

# 4PRO 1031-A

## ACTIVE TWO-WAY SPEAKER



### MAIN APPLICATIONS

- Sound reinforcement systems
- Band and vocal PA
- DJ PA systems
- Small to medium size venue Main PA

### MAIN FEATURES

- 800 WATT PEAK, 400 WATT RMS
- 131 dB max spl
- 90 x 60, Wide dispersion constant directivity horn
- 10" woofer, 2" voice coil
- 1" HF driver, 1.4" voice coil

### DESCRIPTION

The 4PRO 1031-A is a two-way active bass reflex loudspeaker offering extraordinary compact size, high output and vocal fidelity.

It provides low distortion and consistent polar response in a flyable lightweight enclosure.

The 4PRO 1031-A comprises a 10" woofer and a 1.4" voice coil compression driver that is mounted to a 90° x 60° constant directivity horn.

It integrates a 400 Watt digital bi-amplification, a complete electronic processor section and RCF low distortion, high power transducers. The system is compact and extremely linear and offers the typical balanced sound of high level two way systems.

The 90° angle is wide enough to provide coverage of an audience when used one per side, yet narrow enough to allow displaying of multiple enclosures without excessive coverage overlap.

The new 10" inch woofer, with 2" voice coil, is the result of the latest refinement in years of RCF experience in compact speaker design and manufacture, resulting in an accurate and a tight extended midbass. The compression driver uses a new 1 dome, with 1,4" voice coil, in front of a low compression, optimised geometry, radial phase plug. This innovative design is powered from a high flux magnet offering extreme precision in high frequency reproduction.

4PRO 1031-A are equipped with a new generation of 400 Watt Digital Amplifier, 300 Watt for the woofer and 100 Watt for the compression driver. The result of this is very high output, extremely low distortion and an incredible natural sound. The amplifier presents both XLR/jack (Combo) balanced inputs, XLR output link, volume, a switchable EQ Mode (Contour) and a mic/line switch. The amplifier features a solid mechanical aluminium structure which not only stabilize the amplifier during transportation but also assist in the heat dissipation.

The processor section includes active crossover, system equalization, transducer phase alignment, limiter and protection functions. The system is visually monitored from 4 status LEDs. All components are housed in a strong Baltic birch plywood enclosure where high density polystyrene end caps guarantee the maximum strength.

The front is protected from a strong, powder coated, metal grille. The cabinet features two comfortable recessed side handles for easy portability.

### ACOUSTICAL SPECIFICATIONS

Frequency response:	50 Hz- 20 KHz
Max SPL:	127 dB
Horizontal coverage angle:	90°
Vertical coverage angle:	60°
Compression driver:	1", 1.4" v.c.
Midrange:	-
Woofer:	10", 2" v.c.

### INPUT SECTION

Input connector:	Combo XLR-JCK
Output connector:	XLR
Input sensitivity:	-2 dBu / + 4 dBu

### PROCESSOR SECTION

Crossover frequencies:	1800 Hz
Protections:	Themel, RMS
Limiter:	Fast limiter
Controls:	Volume, EQ Shape, Mic/Line

### AMPLIFIER

Power supply:	400 Watt
---------------	----------

High frequencies:	100 Watt
Mid frequencies:	-
Low frequencies:	300 Watt
Cooling:	Convection
Connection:	VDE connector IN/OUT

### PHYSICAL

Height:	539 mm (21.22")
Width:	320 mm (12.59")
Depth:	320 mm (12.59")
Weight:	16.7 Kg (36.81 lbs)
Cabinet:	Baltic Birch
Hardware:	3 x Flytracks

Handles:	1 side
Pole mount cap	yes
Colour:	Black



# 4PRO 1031-A

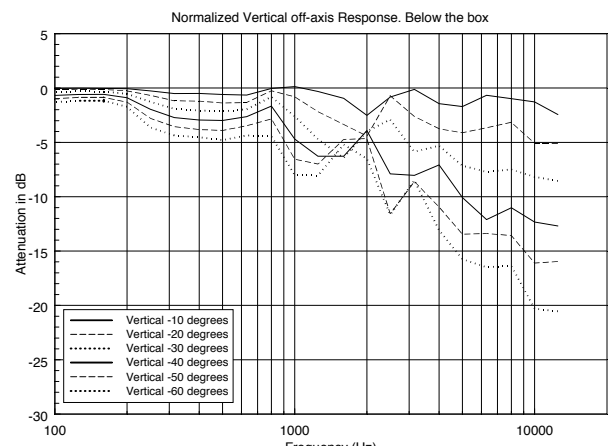
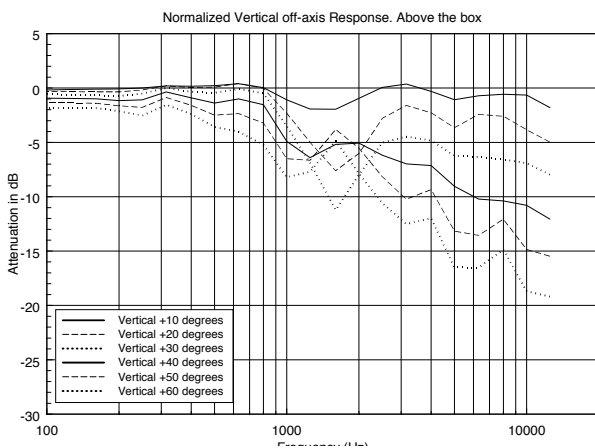
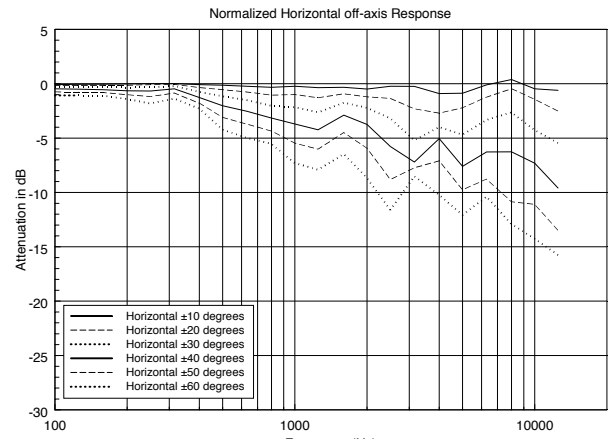
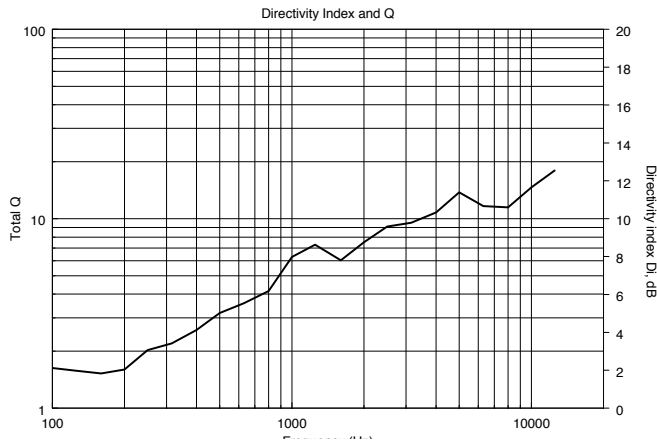
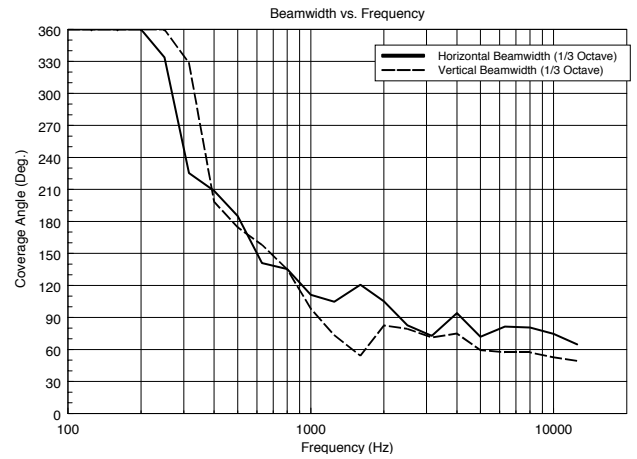
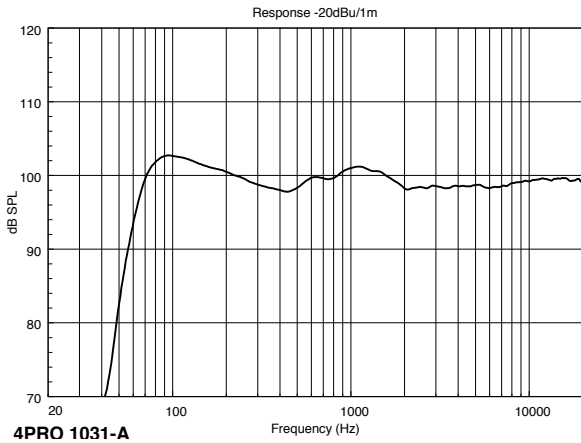

# 4PRO 1031-A

## HORIZONTAL 1/3 POLAR PLOT

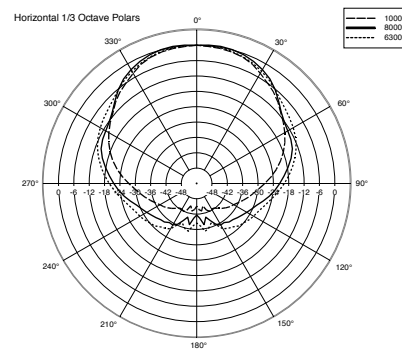
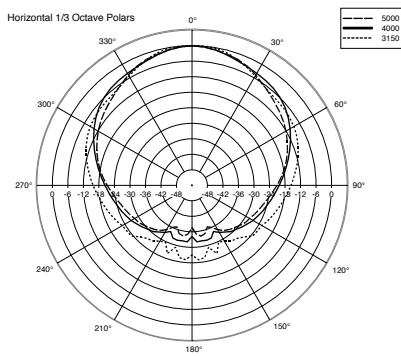
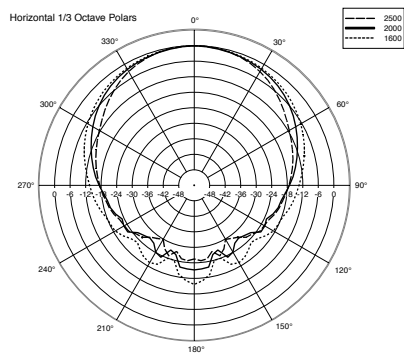
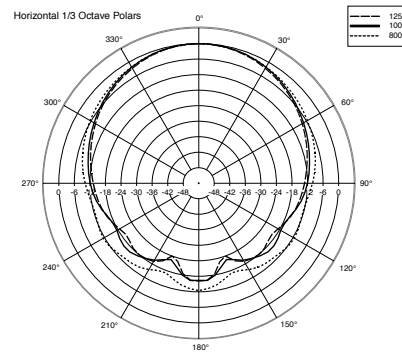
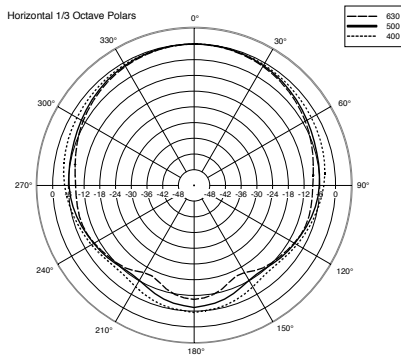
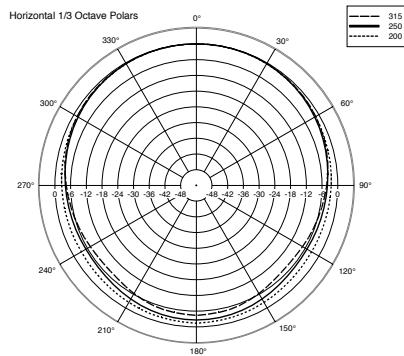

## VERTICAL 1/3 POLAR PLOT

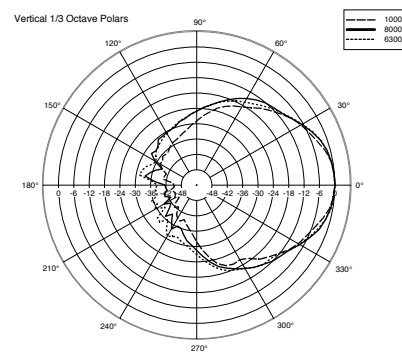
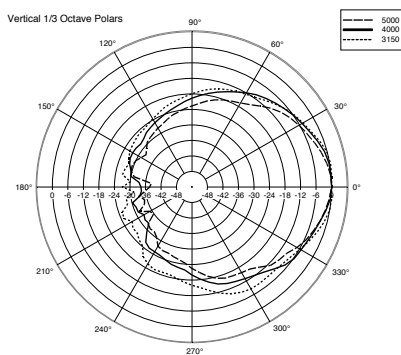
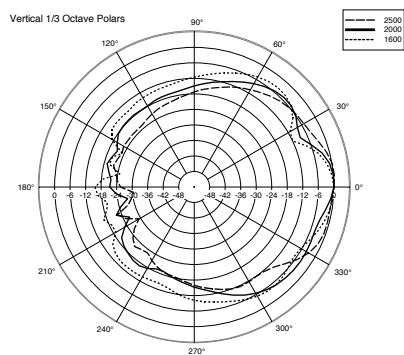
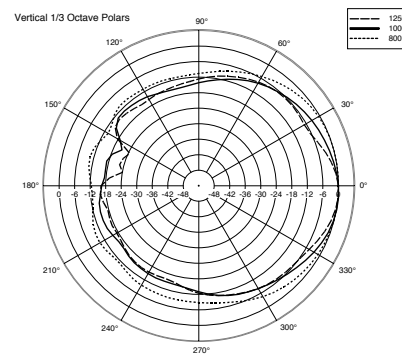
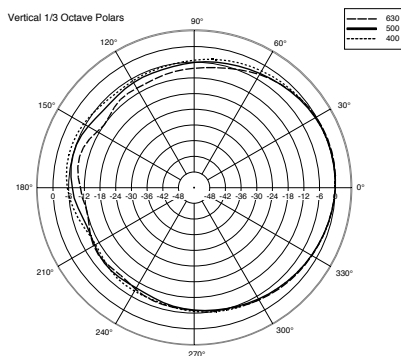
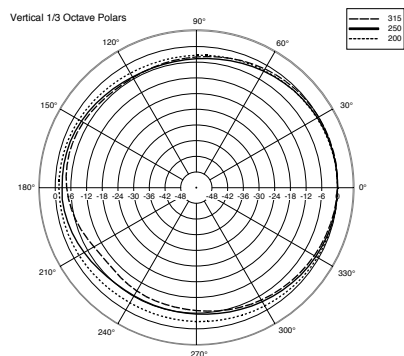

# 4PRO 1031-A

1.0-F

## PART NUMBERS

13000370 - 230VOLT

13000371 - 115 VOLT

## DIMENSIONS (All data are in mm)

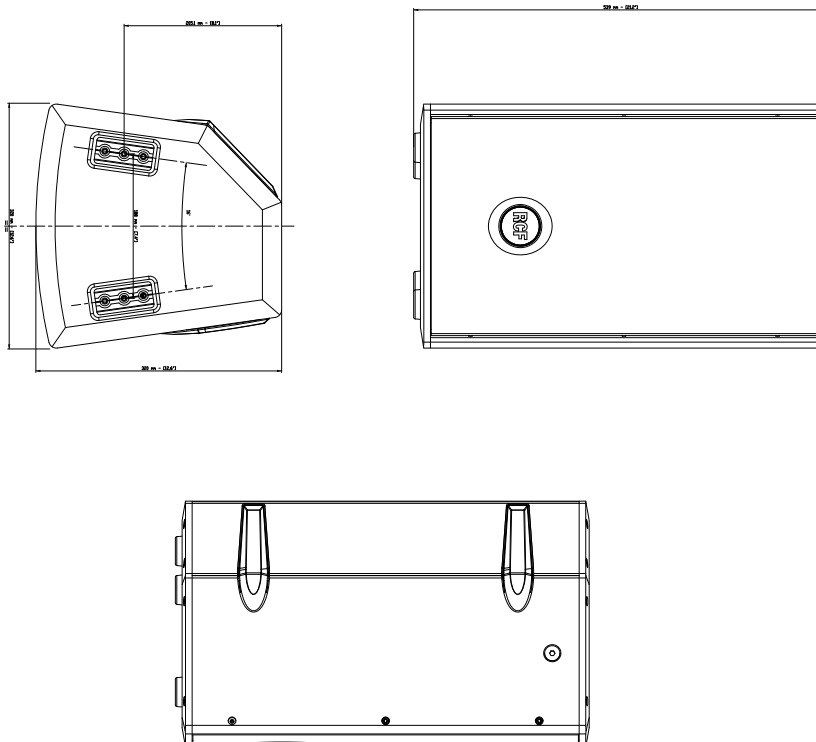

## ACCESSORIES

AC DS4X	4 Hooks Kit
AC PMA	Speaker Pole Mount
AC PRO-FS	Professional Loudspeaker Floor Stand
AC PRO-LF	Professional Adapter Sleeve
AC PRO-PM	Pole Mount with Ring Lock
AC S140	Floor Stand for Loudspeakers
AC PMX	Speaker Pole Mount
AC S260	Floor Stand for Loudspeakers