

305



by **HARMAN**

For: Français, Deutsch, Español, visit www.jblpro.com

Contents

Section 1: Welcome To The EON Family	4
<i>Before You Begin - Important Information</i>	5
Section 2: Precautions	
<i>Watch For These Symbols</i>	6
<i>AC Power Requirements</i>	6
CAUTION	6
<i>EON® Power Amplifiers - Operating Temperature</i>	6
<i>Care and Maintenance</i>	6
<i>Mounting / Suspending EON® Speakers</i>	7
<i>Stand Mounting Safety Precautions</i>	7
<i>Hearing Damage, Prolonged Exposure to Excessive SPL</i>	7
<i>EON® Series Speakers Declaration Of Conformity</i>	8
Section 3: Quick Start	
<i>Packaging Contents</i>	9
Section 4: About the EON305	
<i>Applications</i>	10
<i>Features</i>	10
<i>EON305 Specifications</i>	11
<i>Block Diagram</i>	11
<i>Back Panel</i>	12
Section 5: Loudspeaker Placement and Suspension	13
<i>Using the suspension points</i>	14
Section 6: Application Examples	
<i>Simple PA Using Built-In Mixer EON515</i>	15
<i>Small PA Using External Mixer EON510</i>	16
<i>Simple PA Using External Mixer and Subwoofer EON510 - EON518S</i>	17
<i>Simple PA Using Built-In Mixer</i> <i>and Adding More Power EON315 - EON510 - EON518S</i>	18
<i>PA Using Powered Mixer And Powered Subwoofers EON305 - EON518S</i>	19
<i>PA Using Powered Mixer And Powered Monitors EON305 - EON515</i>	20
<i>Daisy-Chaining a PA System EON315 - EON510 - EON515</i>	21
<i>PA System With Powered Mains and Floor Monitors EON510 - EON515</i>	22
Section 7: Connection Types	
<i>Balanced Lines</i>	23
<i>Unbalanced Lines</i>	23
<i>Unbalanced Sources to EON Powered Loudspeakers</i>	23
<i>Cables and Connectors</i>	23-24
Section 8: Trouble Shooting	25
Section 9: Contact Information	26
Section 10: Warranty Information	27

Section 1: Welcome To The EON Family

Thank you for choosing JBL Professional EON® Series loudspeakers. Since the launch of the very first EON systems in 1995 they have proven to be the loudspeaker system that is all things to everyone and as such remain the best selling powered speaker in professional audio history; congratulations on your choice!

You have now just invested in the next generation of EON, and like the previous versions remain the portable, practical, and powerful choice of industry professionals as well as amateur enthusiasts alike. While retaining the durability and quality of previous generations, the new EONs also offer a host of improvements over the previous models. First and foremost are higher-quality components such as transducers with Differential Drive® technology, which perform better while weighing less. The built-in amplifiers are more powerful, the design more portable and user-friendly, and the addition of mounting and flying points add up to an even more useful and flexible package.

In their quest to be ‘everything for everybody’, the EON Series loudspeakers offer unparalleled flexibility and scalability to provide a variety of solutions for every sound reinforcement need. There are five models in the series – four full-range systems and a subwoofer. Three of the full-range models are powered and one passive. Why passive? A passive version offers the acoustic and physical features to those who just want to upgrade their speakers.

With proper care your EON Series speakers should provide you with many years of flawless performance, and are flexible enough to be a part of your sound reinforcement system even as it grows in scope.

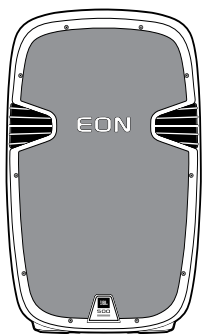

515

Powered
15"
Two-way
Bass-reflex

450 W Continuous
900 W Peak

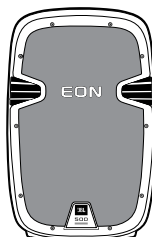

510

Powered
10"
Two-way
Bass-reflex

280 W Continuous
560 W Peak

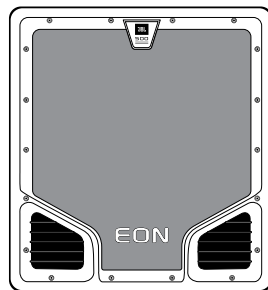

518S

Powered
18"
Subwoofer
Bass-reflex

500 W Continuous
1000 W Peak

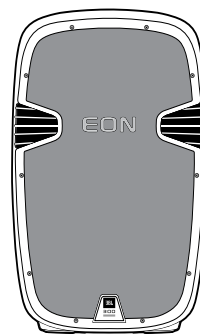

315

Powered
15"
Two-way
Bass-reflex

280 W Continuous
560 W Peak

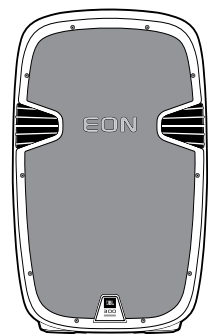

305

Passive
15"
Two-way
Bass-reflex

250 W Continuous
500 W Program
1000 W Peak

Back Panel

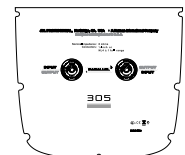
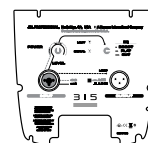
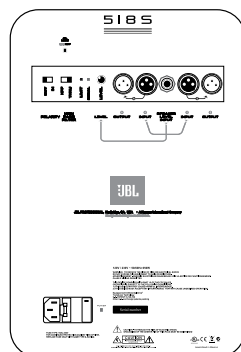
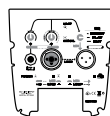
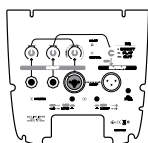

Before You Begin - Important Information

Before using your EON® speaker system please review the following for important information on safety and protection of your investment in quality loudspeakers.

1. Read these instructions.
2. Keep these instructions.
3. Heed all warnings.
4. Follow all instructions.
5. Do not use this apparatus near water.
6. Clean only with dry cloth.
7. Do not block any ventilation openings. Install in accordance with the manufacturer's instructions.
8. Do not install near any heat sources such as radiators, heat registers, stoves, or other apparatus (including amplifiers) that produce heat.
9. Do not defeat the safety purpose of the polarized or grounding-type plug. A polarized plug has two blades with one wider than the other. A grounding-type plug has two blades and a third grounding prong. The wide blade or the third prong is provided for your safety. If the provided plug does not fit into your outlet, consult an electrician for replacement of the obsolete outlet.
10. Protect the power cord from being walked on or pinched, particularly at plugs, convenience receptacles, and the point where they exit from the apparatus.
11. Only use attachments/accessories specified by the manufacturer.
12. Use only with the cart, stand, tripod, bracket, or table specified by the manufacturer, or sold with the apparatus. When a cart is used, use caution when moving the cart/apparatus combination to avoid injury from tip-over.
13. Unplug this apparatus during lightning storms or when unused for long periods of time.
14. Refer all servicing to qualified service personnel. Servicing is required when the apparatus has been damaged in any way, such as power supply cord or plug is damaged, liquid has been spilled or objects have fallen into the apparatus, the apparatus has been exposed to rain or moisture, does not operate normally, or has been dropped.
15. If Service Instruction in Owner's Manual: "CAUTION - THESE SERVICING INSTRUCTIONS ARE FOR USE BY QUALIFIED SERVICE PERSONNEL ONLY. TO REDUCE THE RISK OF ELECTRIC SHOCK DO NOT PERFORM ANY SERVICING OTHER THAN THAT CONTAINED IN THE OPERATING INSTRUCTIONS UNLESS YOU ARE QUALIFIED TO DO SO."
16. To completely disconnect this apparatus from the AC mains, disconnect the power supply cord plug from the AC receptacle.
17. "WARNING – TO REDUCE THE RISK OF FIRE OR ELECTRIC – SHOCK, DO NOT EXPOSE THIS APPARATUS TO RAIN OR MOISTURE."
18. Do not expose this equipment to dripping or splashing and ensure that no objects filled with liquids, such as vases, are placed on the equipment.
19. The mains plug of the power supply cord shall remain readily operable.



Section 2: Precautions

Watch For These Symbols



The lightning flash with arrowhead symbol within an equilateral triangle, is intended to alert the user to the presence of uninsulated. “Dangerous Voltage” within the products enclosure that may be of sufficient magnitude to constitute a risk of electric shock to

persons. The exclamation point within an equilateral triangle is intended to alert the user to the presence of important operating and maintenance (Servicing) instructions in the literature accompanying the product.

AC Power Requirements

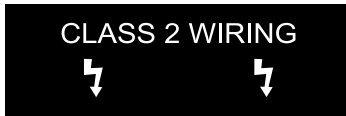

Before plugging an EON® speaker into an outlet ensure that it is able to provide the appropriate AC power. EON speaker systems have been designed to automatically detect 115V or 230V AC mains voltage 50/60 Hz.

DO NOT UNDER ANY CIRCUMSTANCES OPERATE THE UNIT WITH AN AC POWER SUPPLY LESS THAN 100V OR GREATER THAN 240V. DOING SO MAY RESULT IN SERIOUS DAMAGE TO YOUR SPEAKER SYSTEM WHICH WILL NOT BE COVERED BY WARRANTY.

A robust AC supply is necessary for maximum performance. If the supply is too weak the bass performance may be affected and if it sags (drops) too much the system may self-mute to protect itself. As soon as the appropriate AC supply is restored it will continue to operate. Plugging multiple systems into the same outlet and long extension cord runs may affect the AC supply to the systems.

CAUTION

In compliance with safety agency criteria and proper system operation, it is critical that the system installer observe all electrical safety practices at all times and provide proper earth grounding for all AC Power connections.

EON® Power Amplifiers - Operating Temperature

The design of the EON amplifier is such that it is very energy efficient and as a result does not get really hot. In the rare event that it does get too hot it will automatically shut down to protect itself. When its temperature has returned to within its operating range it will turn back on. A condition under which this may occur is when the system is operated in very high ambient temperatures and the heat sink on the rear of the enclosure is in direct sunlight. Always ensure adequate cooling and appropriate shade.

Care and Maintenance

While your EON speakers are rugged and will provide years of service, some common sense care in handling will prevent damage and preserve appearance.

- If your speakers will be frequently moved, consider a padded carrying bag.
- If your EON speakers have been subjected to prolonged exposure to extreme low temperatures, avoid subjecting them to heavy mechanical shock and warm the speakers up by playing at a low volume for one hour before playing at loud levels.
- Keep the exterior of the speaker enclosure clean. Clean only with a dry cloth.
- EON speakers are not intended for fixed installation in outdoor environments. Moisture can damage the speaker cone and surround, cause corrosion of electrical contacts, and create an electrical shock hazard. Protect your speakers from moisture. Avoid exposing the speakers to direct moisture. Any electrically powered device can produce dangerous shock hazards when wet or exposed to moisture. Keep speakers out of extended or intense direct sunlight. The driver's integrity may be affected and finished surfaces will be degraded by long-term exposure to intense ultra-violet (UV) light.

THIS APPARATUS CONTAINS POTENTIALLY LETHAL VOLTAGES. TO PREVENT ELECTRIC SHOCK OR HAZARD, DO NOT REMOVE CHASSIS, INPUT MODULE OR AC INPUT COVERS. NO USER SERVICEABLE PARTS INSIDE. REFER SERVICING TO QUALIFIED SERVICE PERSONNEL.

Mounting / Suspending EON® Speakers

EON speakers are designed for portable applications in which the speakers will be stacked directly on the floor, stage, speaker stands, or a solid, stable platform. When placed on a smooth surface such as polished wood or linoleum, the speakers may move due to acoustical energy output. Precautions should be taken to assure that the speaker does not fall off the stage or table on which it is placed. Optional accessory items are available from JBL Professional and after-market suppliers to facilitate suspension and wall /ceiling mounting of EON speakers. Only those items recommended by JBL Professional should be used. When using these items, review all enclosed documentation and carefully follow all instructions and safety precautions.

CAUTION: *Suspension of EON® speakers should be done by qualified persons following safe rigging standards and practices. Unsafe mounting or overhead suspension of any heavy load can result in serious injury and equipment damage.*

CAUTION: *When suspending this product carefully follow JBL instructions and local ordinances. Do not attempt to use unless you have read and understood all instructions including the JBL User's Guide. Attachment of the loudspeaker to a supporting structure should be referred to a qualified professional.*

Stand Mounting Safety Precautions

EON series full range models include a 36 mm receptacle cup to allow mounting on tripod stands or on a pole over subwoofers. When using stands or poles, be sure to observe the following precautions:

- EON speakers include a thumb-screw that must be tightened to secure the speaker to the tripod stand. Before mounting the speaker on the stand, be sure to loosen the screw so that it doesn't prevent the pole from fully penetrating the socket.
- Check the stand or pole specification to be certain the device is designed to support the weight of the speaker. Observe all safety precautions specified by the manufacturer.
- Always verify that the stand (or subwoofer/pole) is placed on a flat, level and stable surface and be sure to fully extend the legs of tripod type stands. Position the stand so that the legs do not present a trip hazard.
- Route cables so that performers, production crew, and audience will not trip and topple the speakers over.
- Inspect the stand (or pole and associated hardware) before each use and do not use equipment with worn, damaged or missing parts.
- Do not attempt to place more than one EON series speaker on a stand or pole.
- Always be cautious in windy, outdoor conditions. It may be necessary to place additional weight (i.e. sandbags) on the base of the stand to improve stability. Avoid attaching banners or similar items to any part of a speaker system. Such attachments could act as a sail and topple the system.
- Unless you are confident that you can handle the weight of the speaker, ask another person to help you get it onto the tripod stand or pole.

Hearing Damage, Prolonged Exposure to Excessive SPL

EON series loudspeakers are easily capable of generating sound pressure levels (SPL) sufficient to cause permanent hearing damage to performers, production crew and audience members. Caution should be taken to avoid prolonged exposure to SPL in excess of 90 dB.

EON® Series Speakers Declaration Of Conformity

Safety And EMC Compliance Specifications

EN 55103-1:1997 Electromagnetic Compatibility - Product Family Standard for Audio, Video, Audio-Visual and Entertainment Lighting Control Apparatus for Professional Use, Part 1: Emissions

EN 55103-1:1997 Magnetic Field Emissions-Annex A@ 10 cm and 20 cm

EN 55022:2003 Limits and Methods of Measurement of Radio Disturbance Characteristics of ITE: Radiated, Class B Limits; Conducted, Class A

EN 55103-2:1997 Electromagnetic Compatibility - Product Family Standard for Audio, Video, Audio-Visual and Entertainment Lighting Control Apparatus for Professional Use, Part 2: Immunity

EN 61000-4-2: A2:2001 Electrostatic Discharge Immunity (Environment E2-criteria B, 4 kV Contact, 8 kV Air discharge)

EN 61000-4-3:2003 Radiated, Radio-frequency, Electromagnetic Immunity (Environment E2, criteria A)

EN61000-4-4:2005 Electrical Fast Transient/Burst Immunity (criteria B)

EN 61000-4-5:2001 Surge Immunity (criteria B)

EN 61000-4-6:1996 Immunity to Conducted Disturbances Induced by Radio-Frequency Fields (criteria A)

EN 61000-4-11:2004 Voltage Dips, Short Interruptions and Voltage Variation

UL 6500 2nd Edition 1999 Audio/Video and Musical Instruments Apparatus for Household, Commercial, and Similar General Use

UL Compliance Specifications

UL60065/C22.2 No. E60065:03/IEC 60065 7th Ed.

FCC Compliance Notice

This device complies with part 15 of the FCC rules. Operation is subject to the following two conditions:

(1) This device may not cause harmful interference, and (2) this device must accept any interference received, including interference that may cause undesired operation.

CAUTION: Changes or modifications not expressly approved by the party responsible for compliance could void the user's authority to operate the equipment.

NOTE: This equipment has been tested and found to comply with the limits for a Class A digital device, pursuant to part of the FCC Rules. These limits are designed to provide reasonable protection against harmful interference in a residential installation. This equipment generates, uses, and can radiate radio frequency energy and, if not installed and used in accordance with the instruction manual, may cause harmful interference to radio communications. However there is no guarantee that the interference will not occur in a particular installation. If this equipment does cause harmful interference to radio and television reception, which can be determined by turning the equipment off and on, the user is encouraged to try to collect the interference by one or more of the following measures:

- Reorient or relocate the receiving antenna.
- Increase the separation between the equipment and receiver.
- Connect the equipment into an outlet on a circuit different from that to which the receiver is connected.
- Consult the dealer or an experienced radio / TV technician for help.

Section 3: Quick Start

Congratulations on your purchase of JBL Professional EON® Series loudspeakers! We know you are anxious to get up and running as fast as possible, which is why you are reading this section. The following will help you get set up as soon as possible.

Packaging Contents

Your EON305 system should include the following:

- 1 x EON305 speaker
- 1 x User's Guide

1. Refer to the Application Examples with EON305 in Section 6.
2. Plug the Speakon® NL4 connector cable from the powered mixer or amplifier into the INPUT connector.
3. POWER UP PROCEDURE
 - First, switch on the power to the mixer, audio sources, or musical instruments that are feeding your amplifier.
 - Next, turn on the power switch of your amplifier.
 - Reverse this process when shutting down your system.
4. SET VOLUME
 - If you are using an audio mixing console, refer to the manufacturer's instructions to properly set gain structure.
 - Turn up your sources to the level that will be used in performance and talk, sing or play into the system.

Section 4: About the EON305

Applications

- Live sound reinforcement, speech and vocals, music playback in entertainment, A/V, and institutional venues - especially when ease of use and portability are important factors.
- Everywhere you need to be heard.

Features

- 250 watt Passive Speaker System.
- True portability weighing only 15 kg (33 lb).
- Multiple handles for easy transport.
- 15" JBL low-frequency driver.
- 1" throat diameter next generation JBL neodymium compression driver.
- 100 x 60 asymmetrical waveguide for uniform audience coverage.
- NL4 and ¼" input connectors.
- Loop thru signal flow for extended system application and easy "daisy-chain" connections.
- Integrated M10 suspension points for easy rigging.
- Multi angle enclosure for main or monitor applications.
- Integrated 36 mm pole mount socket with anti-wobble securing screw.
- Highly designed composite enclosure for durability, lightweight, acoustic performance.

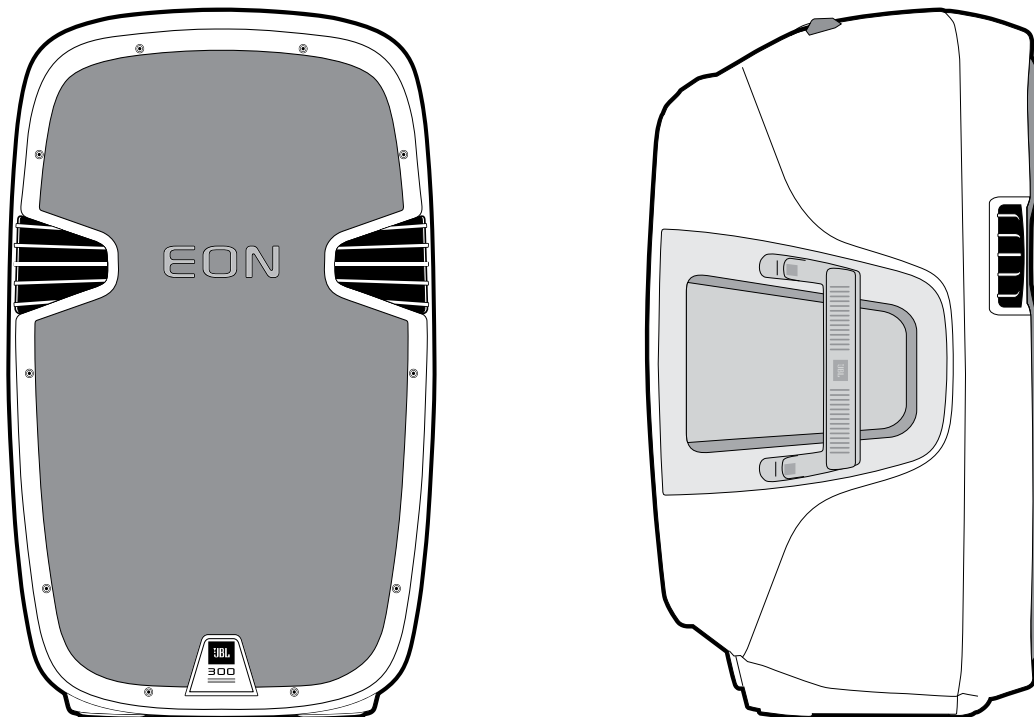

EON305 Specifications

System Type:	15", two-way, bass-reflex design
Frequency Range (-10 dB):	38 Hz - 20 kHz
Frequency Response (± 3 dB):	50 Hz - 18 kHz
Coverage Pattern:	100° x 60° nominal
Directivity Index (DI):	9 dB
Directivity Factor (Q):	8
Crossover Frequency:	1.9 kHz
System Power Rating:	250 W continuous, 500 W program, 1000 W peak
Sensitivity (1w/1m):	98 dB
Maximum SPL:	128 dB
Nominal Impedance:	8 Ohms
LF Driver:	1 x M115-8 380 mm (15 in) woofer
HF Driver:	1 x JBL 2414H-1 25.4 mm (1 in) polymer diaphragm compression driver
Input Connector:	Parallel Neutrik® NL4 / 1/4" combo connectors.
Protection:	Sonic Guard™
Enclosure:	PP impact copolymer, multi-purpose main & monitor orientation.
Handles:	One left/right side, one on top.
Suspension / Mounting:	36 mm pole socket with stabilizing screw, 4 x M10 suspension points 1 x M10 pull-back point.
Grille:	Powder coated perforated steel with acoustically transparent black screen backing.
Dimensions (H x W x D):	685 x 438 x 366 mm (27 x 17.3 x 14.4 in)
Net Weight:	15 kg (33 lb)

Block Diagram

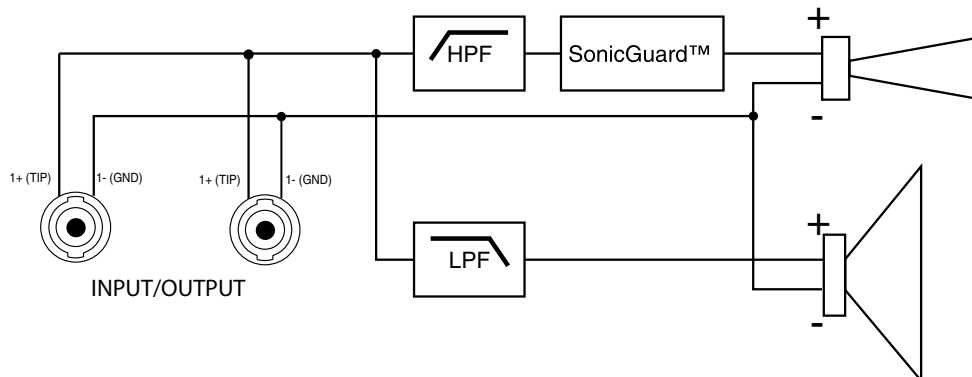

Back Panel

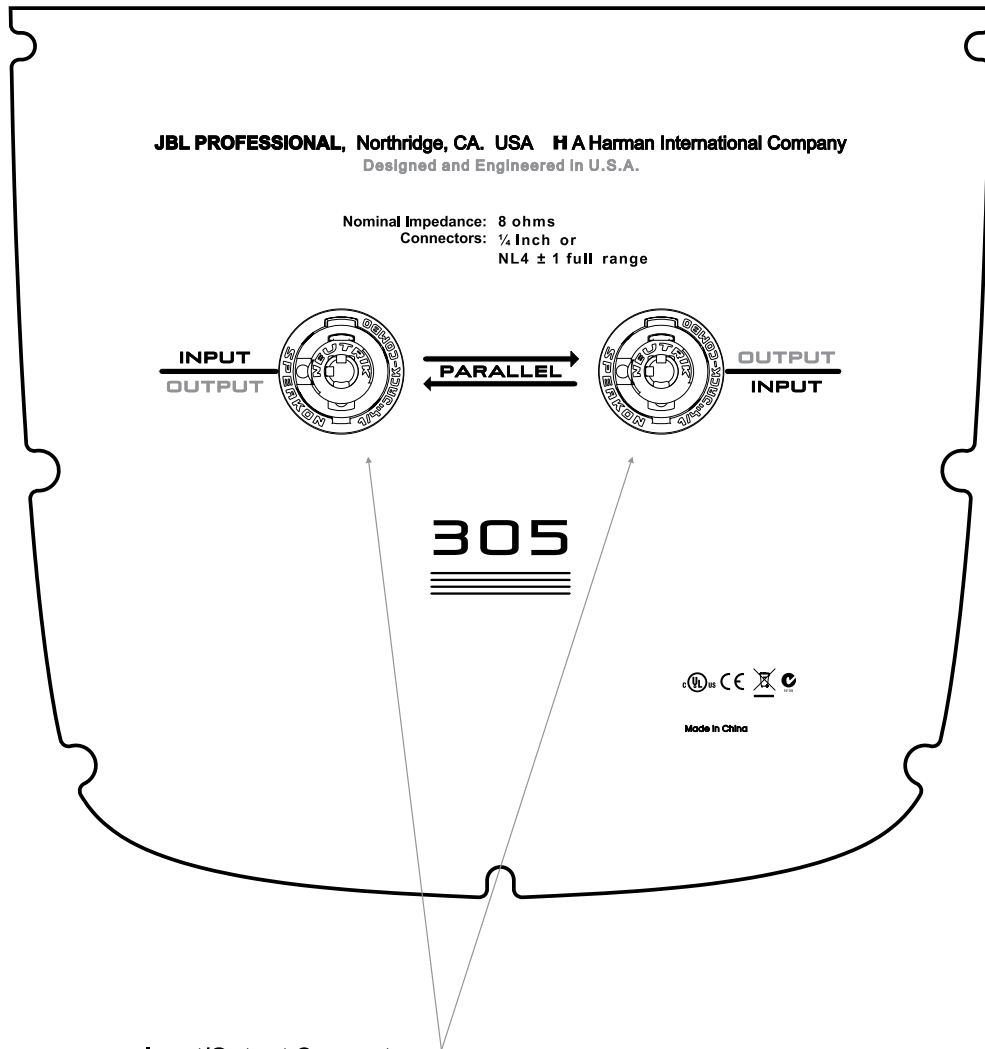

Input/Output Connectors

Speakon® NL4 / 1/4" combo connector accepts both the NL4 and 1/4" TS phone plug connectors.

Connected in parallel is an identical Speakon® NL4 / 1/4" combo connector. This facilitates a loop-through connection and the powering of an additional EON305 in a parallel configuration.

Speakon is a registered trademark of Neutrik AG.

Section 5: Loudspeaker Placement and Suspension

The following guidelines will help you achieve optimum sound wherever you use your EON® loudspeakers:

Raise the speakers as high as possible.

For best results try to get the high frequency horn at least 2 to 4 feet above the heads of the audience. If the speakers are too low, the people in the back of the audience will not receive the best quality sound.

Place the speakers between the microphones and the audience.

Feedback occurs when the microphones pick up sound from the speakers and “feed” the sound back through the sound system. If space is limited, point the speakers away from the microphones to reduce feedback.

Locate the speakers away from turntables.

Low-frequency feedback occurs when the output of the speaker is picked up by the tone arm of the turntable and is re-amplified. A heavy, solid turntable base and shock mounting can also reduce this type of feedback in DJ applications.

Use more speakers in large or highly reverberant spaces.

Spreading speakers throughout these spaces will produce much better sound than trying to compensate with loudness level or equalization. For very long distances, the use of another set of speakers with time delay is recommended.

Stand speakers upright for PA - Tilt the speakers back on the side for stage monitoring. Upright stance provides even coverage over a wide area. EON speakers are also designed with two slanted positions for stage monitoring applications.

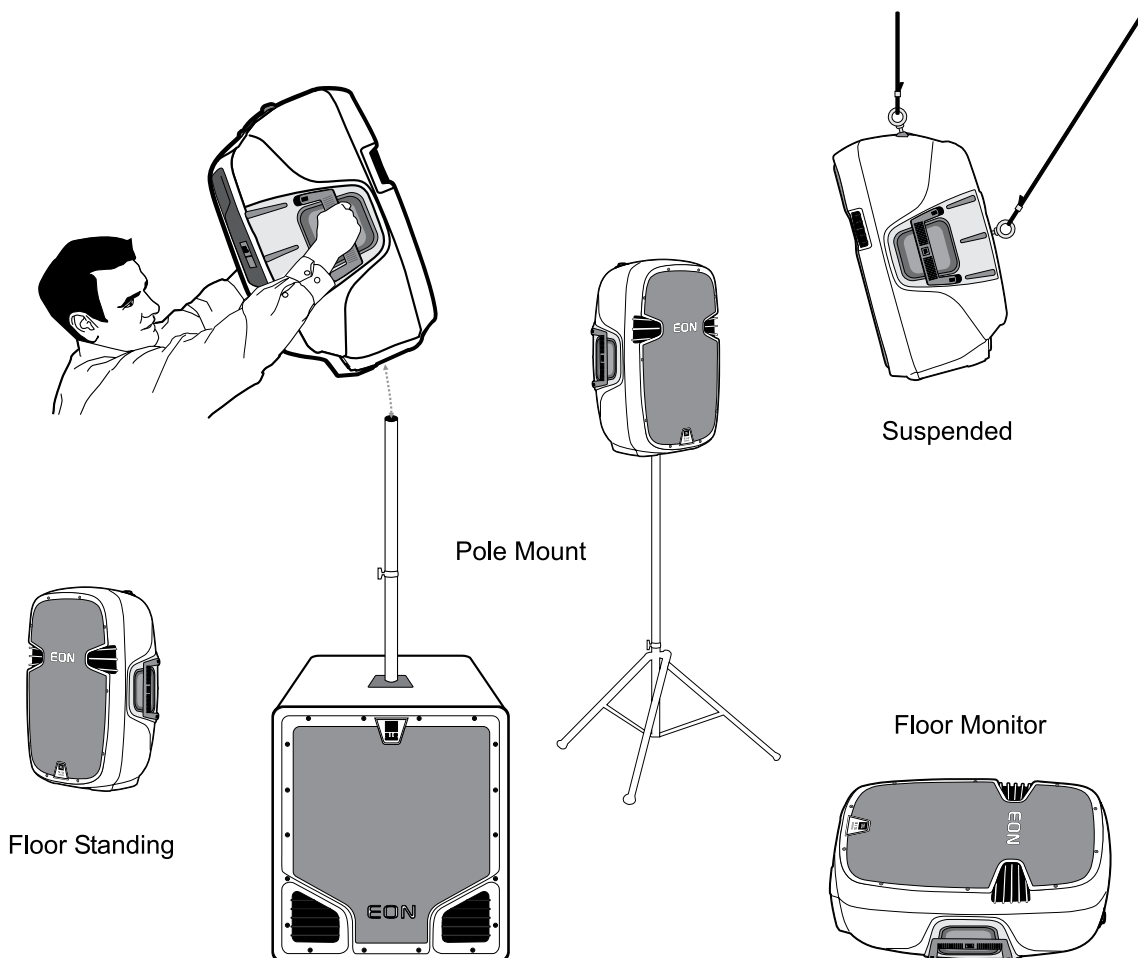

Using the suspension points

CAUTION: Suspension of EON® speakers should be done by qualified persons following safe rigging standards and practices. Unsafe mounting or overhead suspension of any heavy load can result in serious injury and equipment damage.

CAUTION: When suspending this product carefully follow JBL instructions and local ordinances. Do not attempt to use unless you have read and understood all instructions including the JBL User's Guide. Attachment of the loudspeaker to supporting structure should be referred to a qualified professional.

CAUTION: Do not suspend speaker from pull-back point.

Before suspending the system, inspect all components involved for cracks, deformations, corrosion and/or missing or damaged parts that could reduce strength and safety of the installation.

1. Remove suspension point caps
2. Insert load rated shoulder eyebolt with spacer and tighten appropriately

Never suspend more than one EON system from its suspension points.

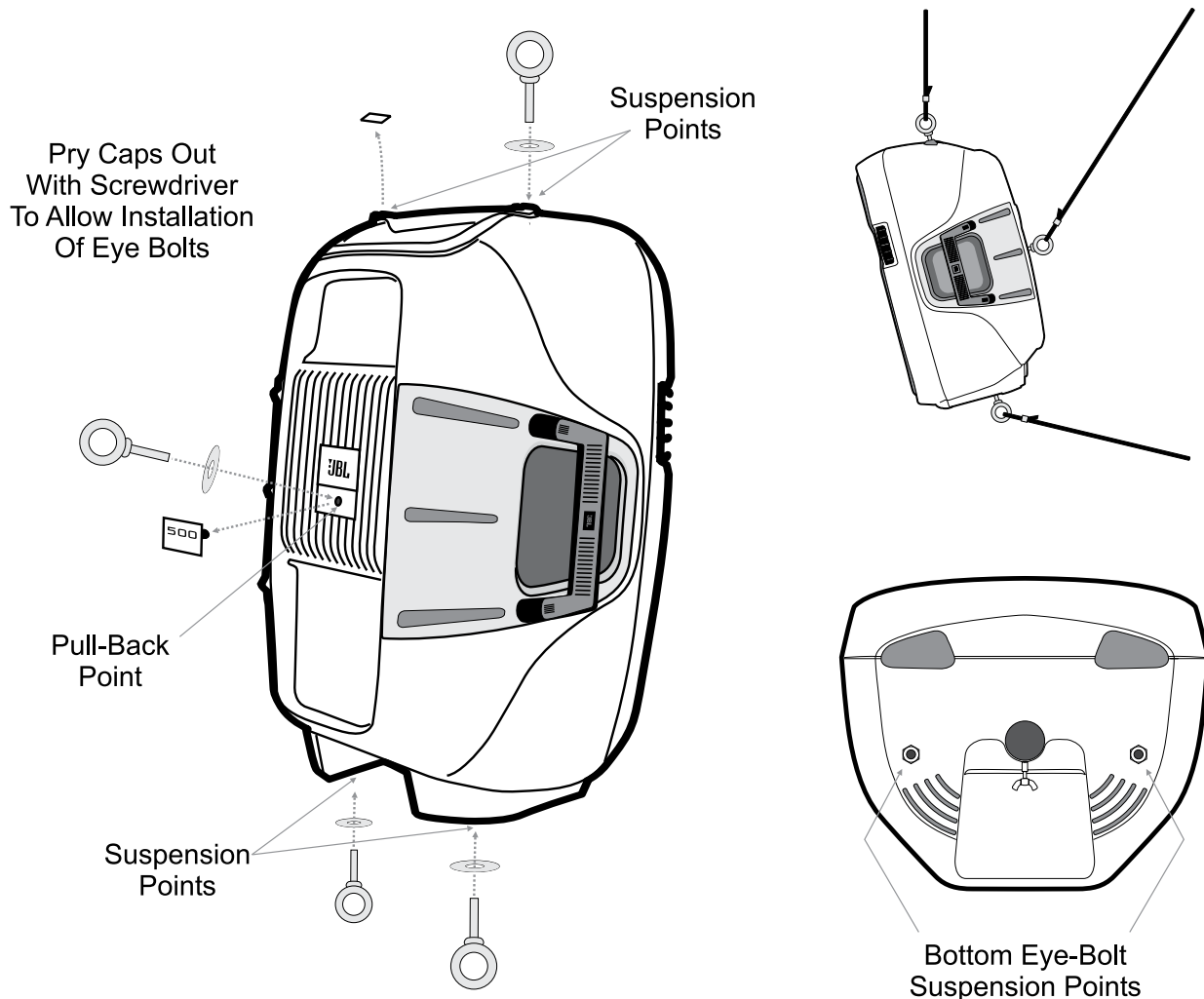

Simple PA Using Built-In Mixer

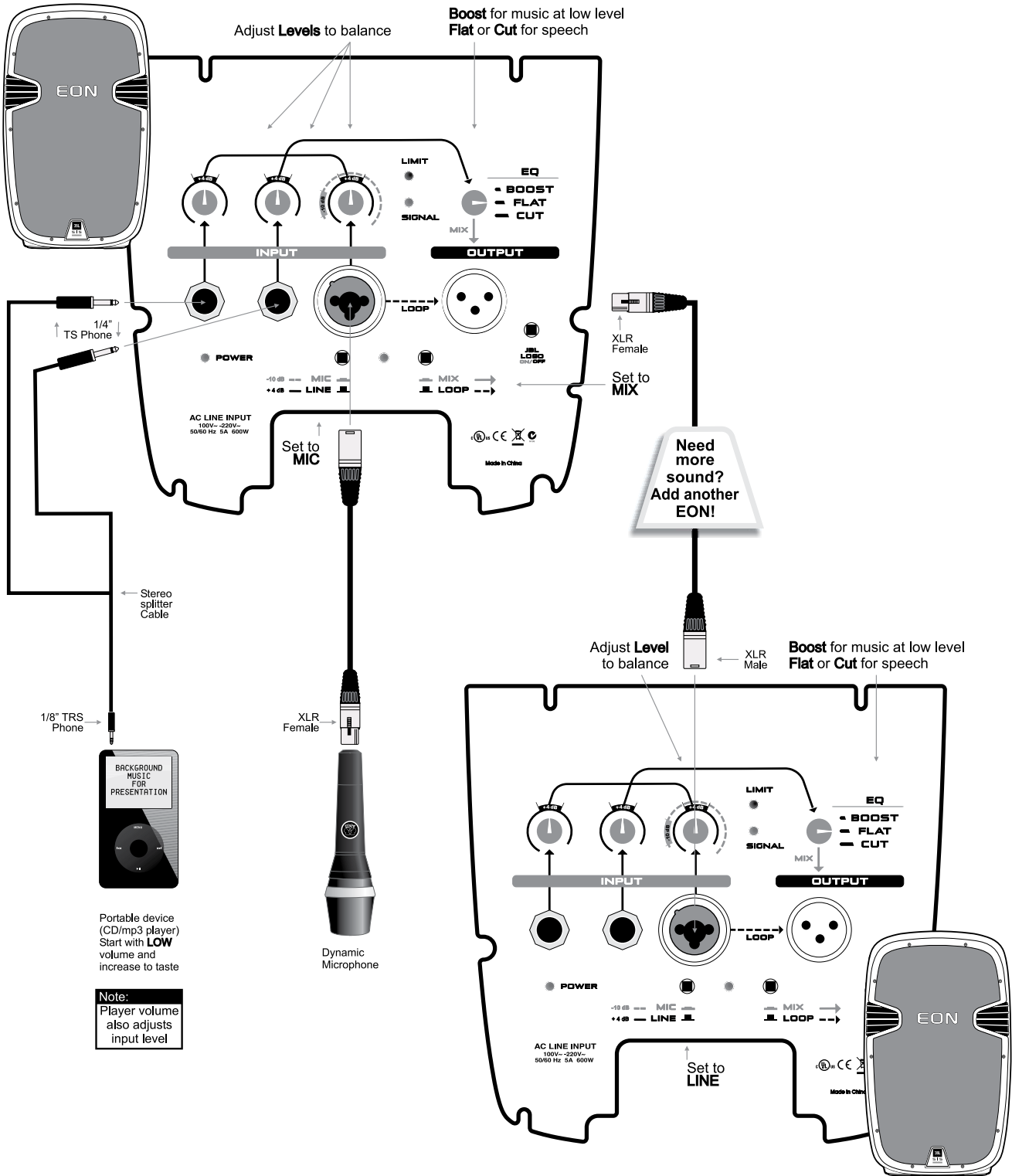
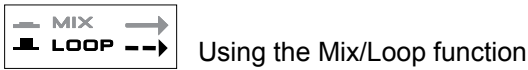

Small PA Using External Mixer

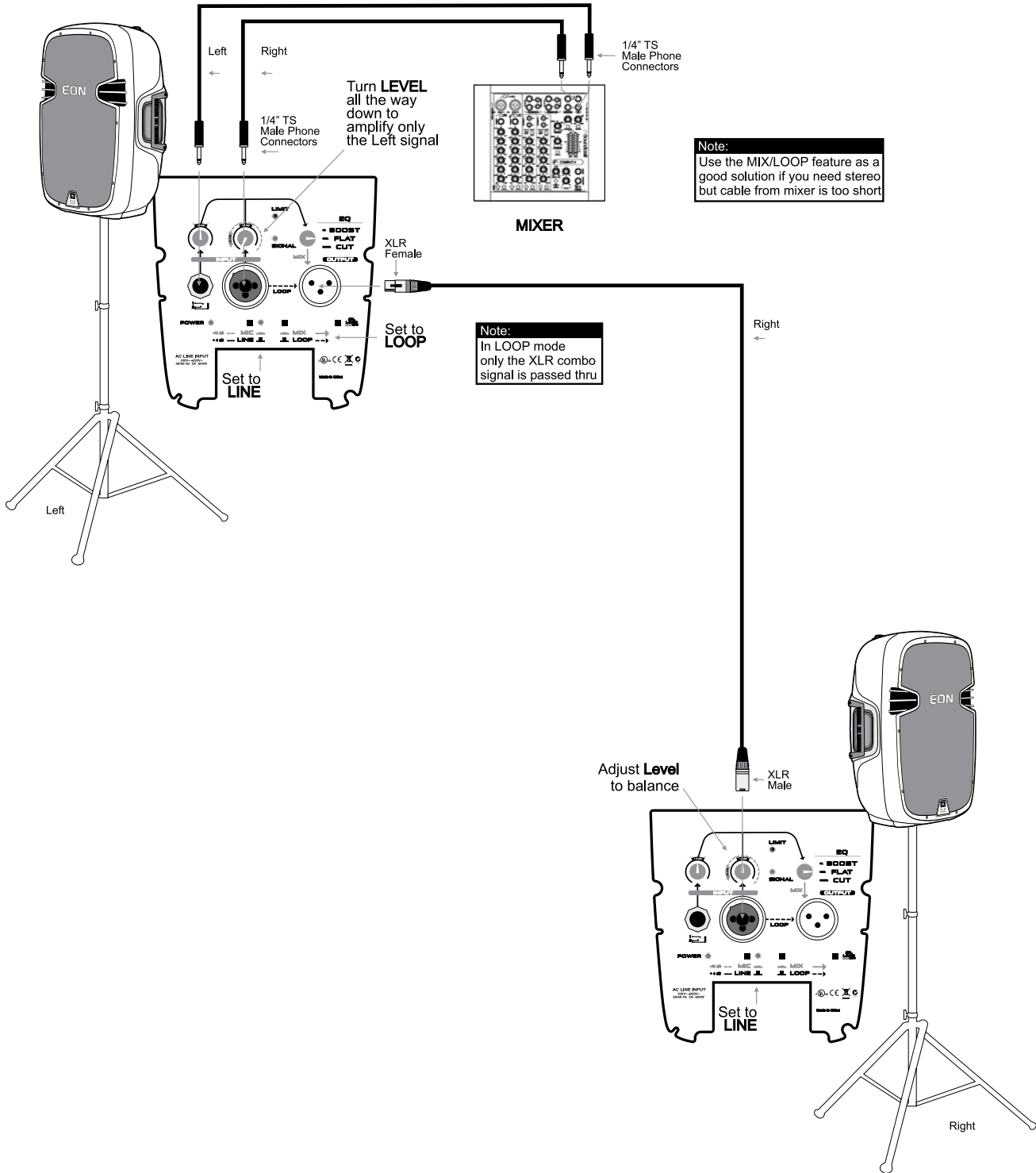
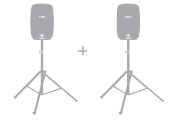

Simple PA Using External Mixer and Subwoofer

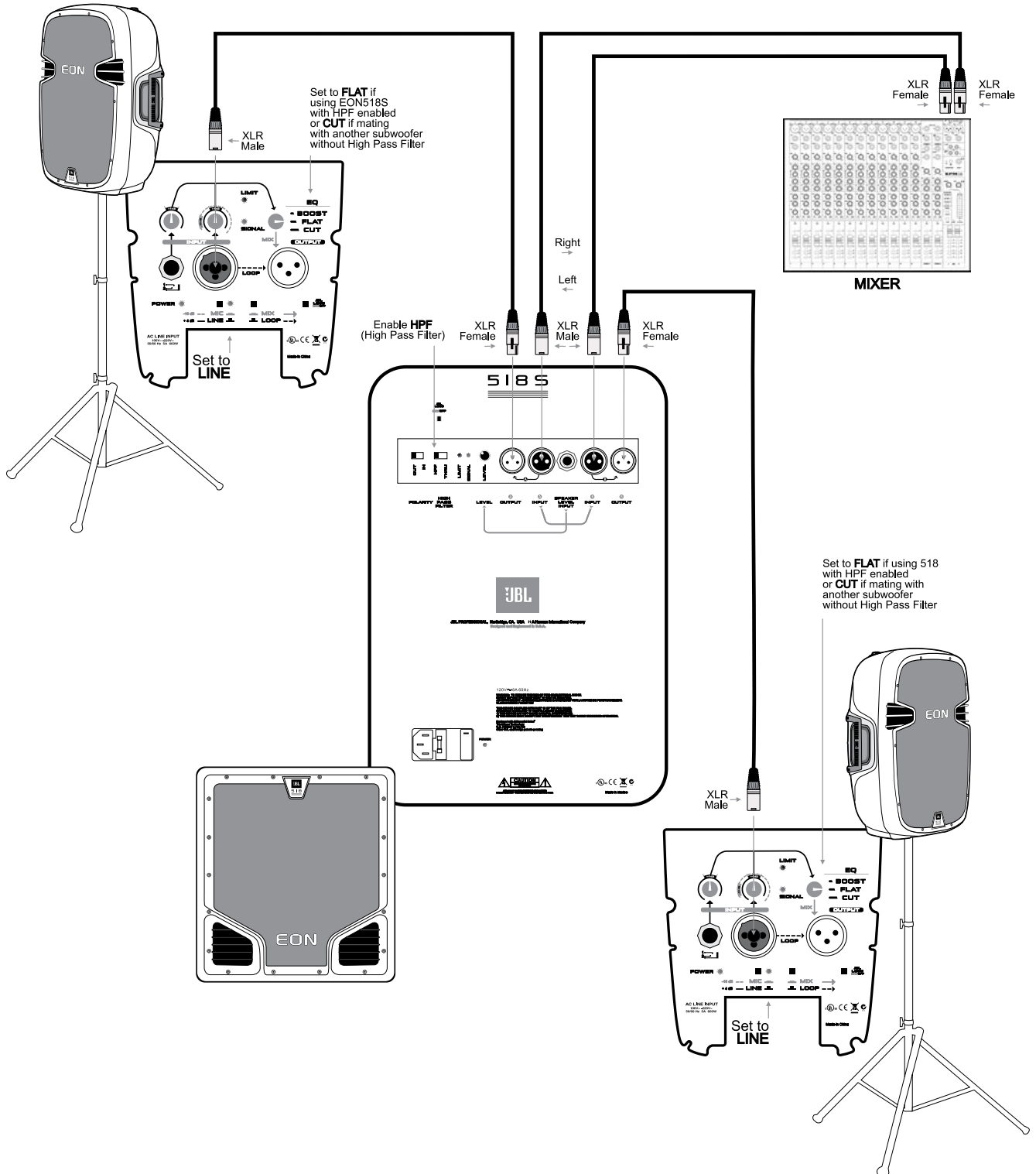

Section 6: Application Examples EON315 - EON510 - EON518S

Simple PA Using Built-In Mixer And Adding More Power



Using the Mix/Loop function

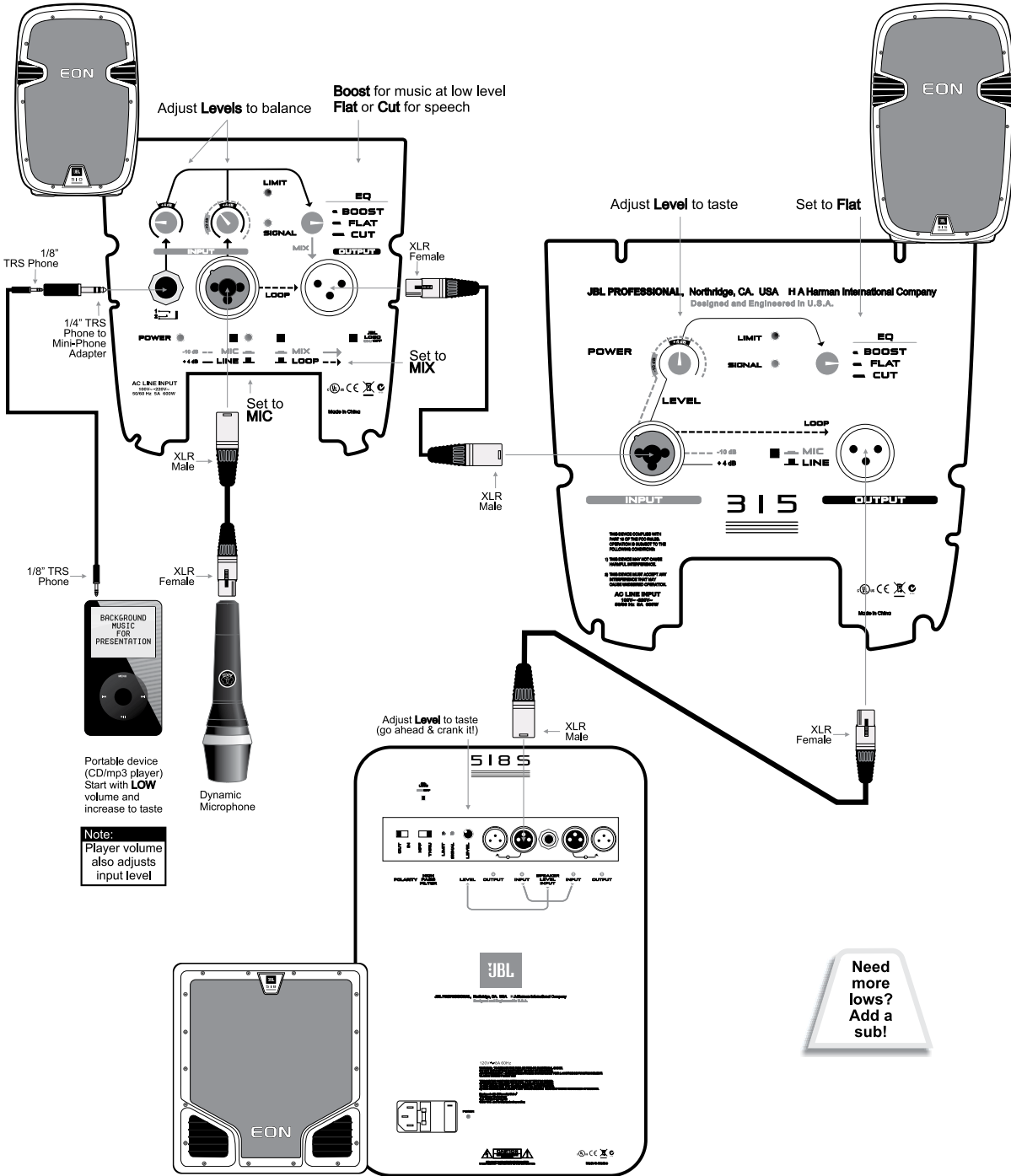

PA Using Powered Mixer And Powered Subwoofers

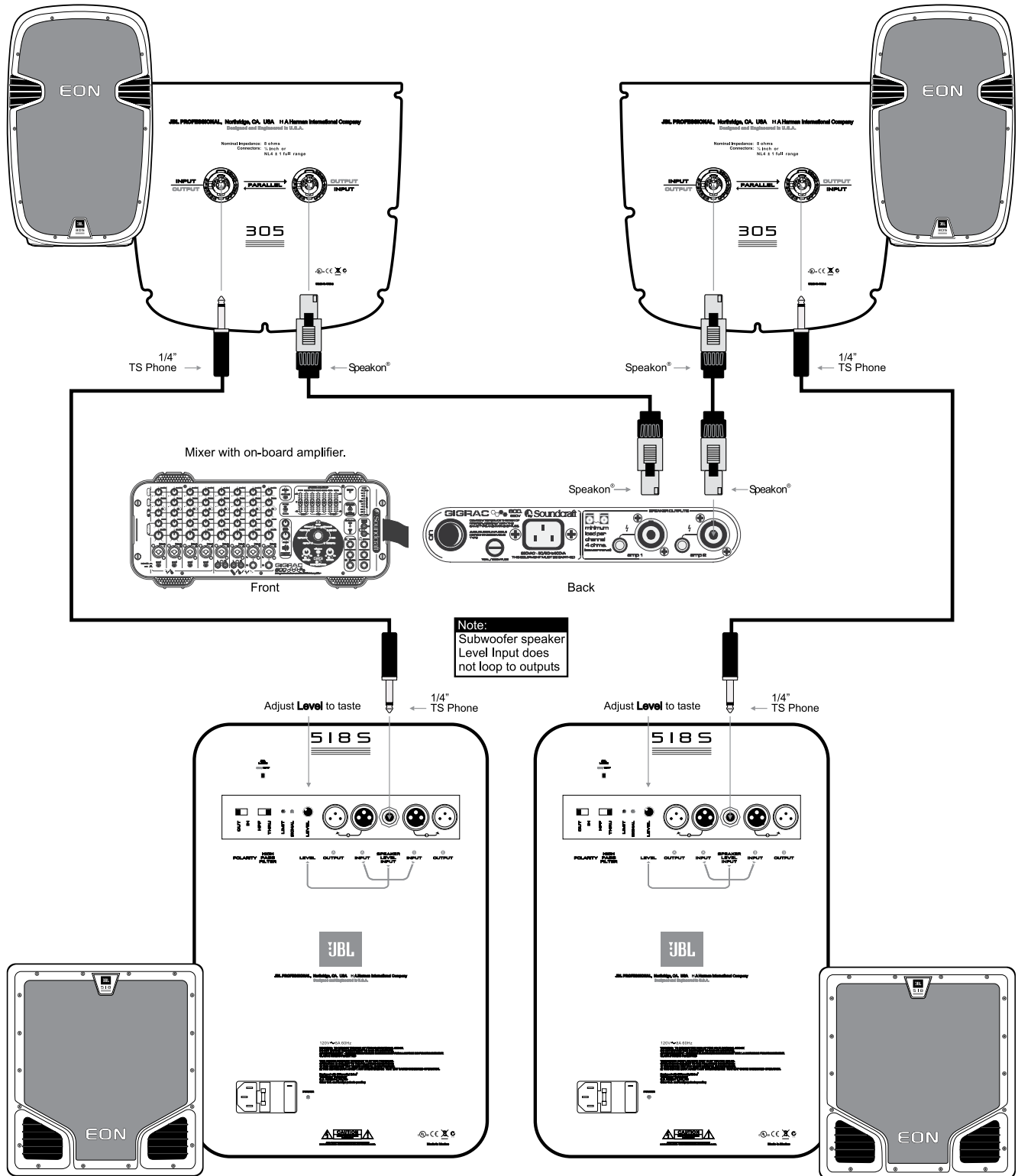

PA Using Powered Mixer And Powered Monitors

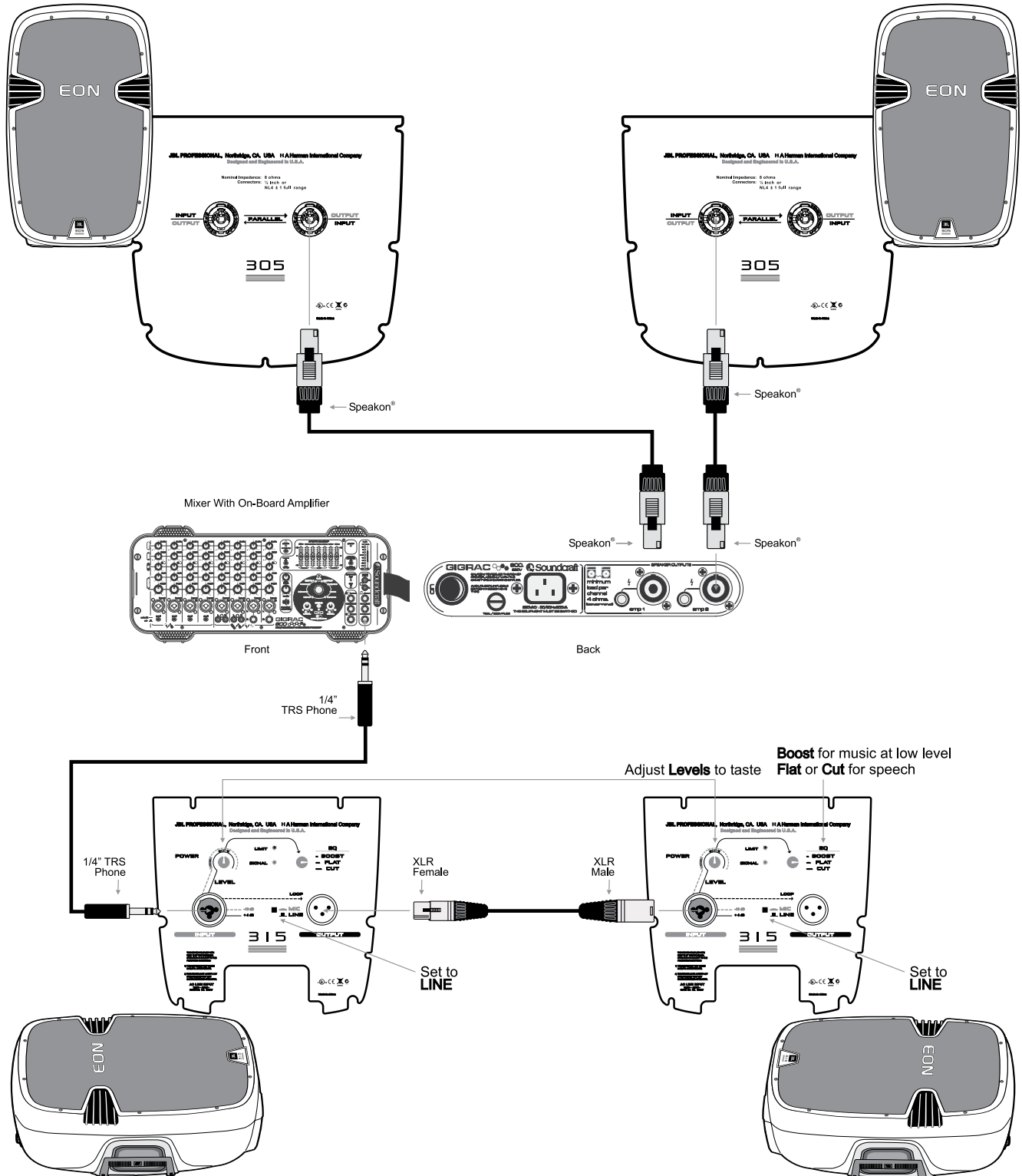

Daisy-Chaining a PA System



Using the Mix/Loop function

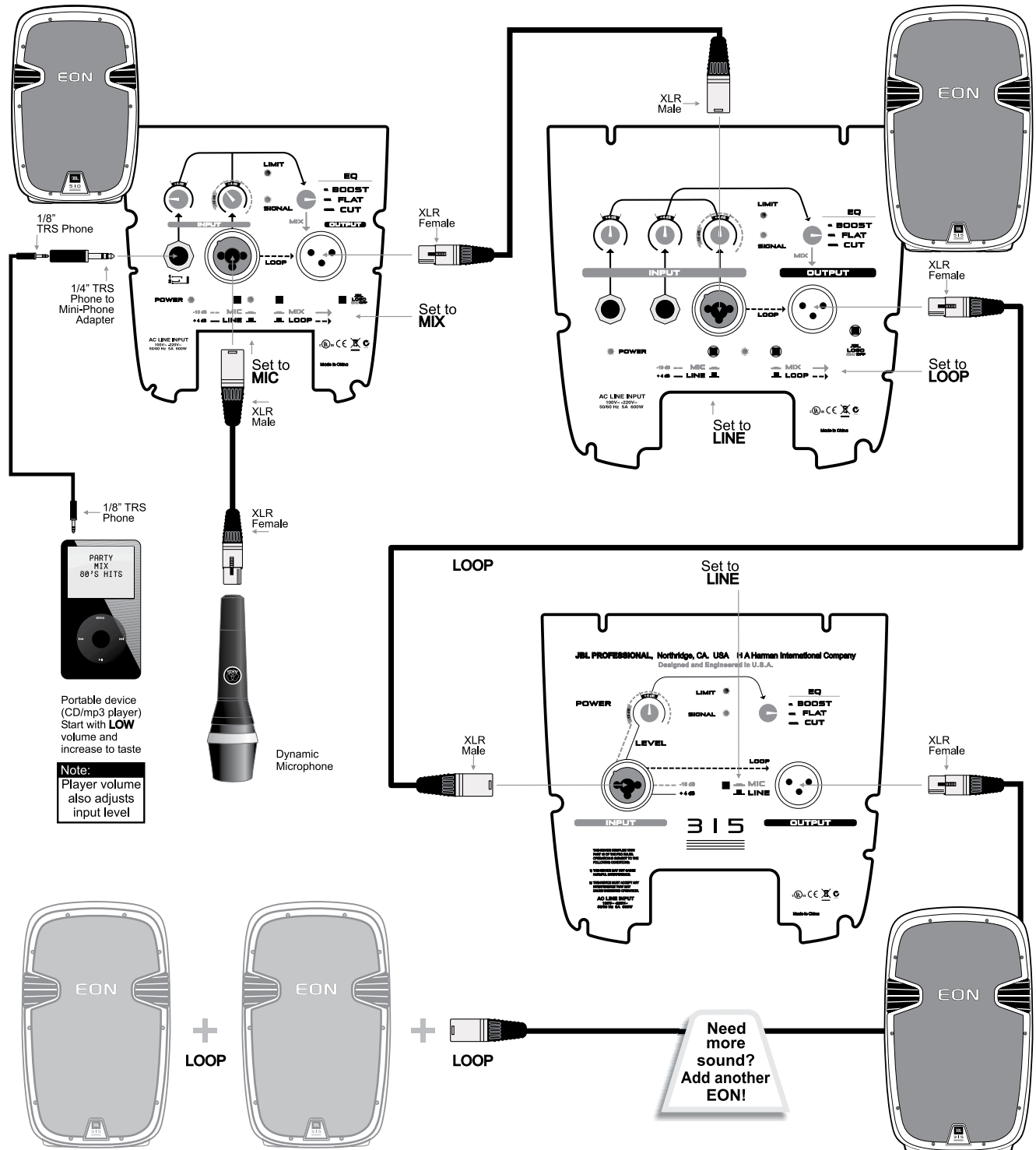

Portable device (CD/mp3 player) Start with **LOW** volume and increase to taste
Note: Player volume also adjusts input level

PA System With Powered Mains and Floor Monitors Gigging with the built-in mixers only

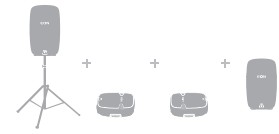

Using the Mix/Loop function

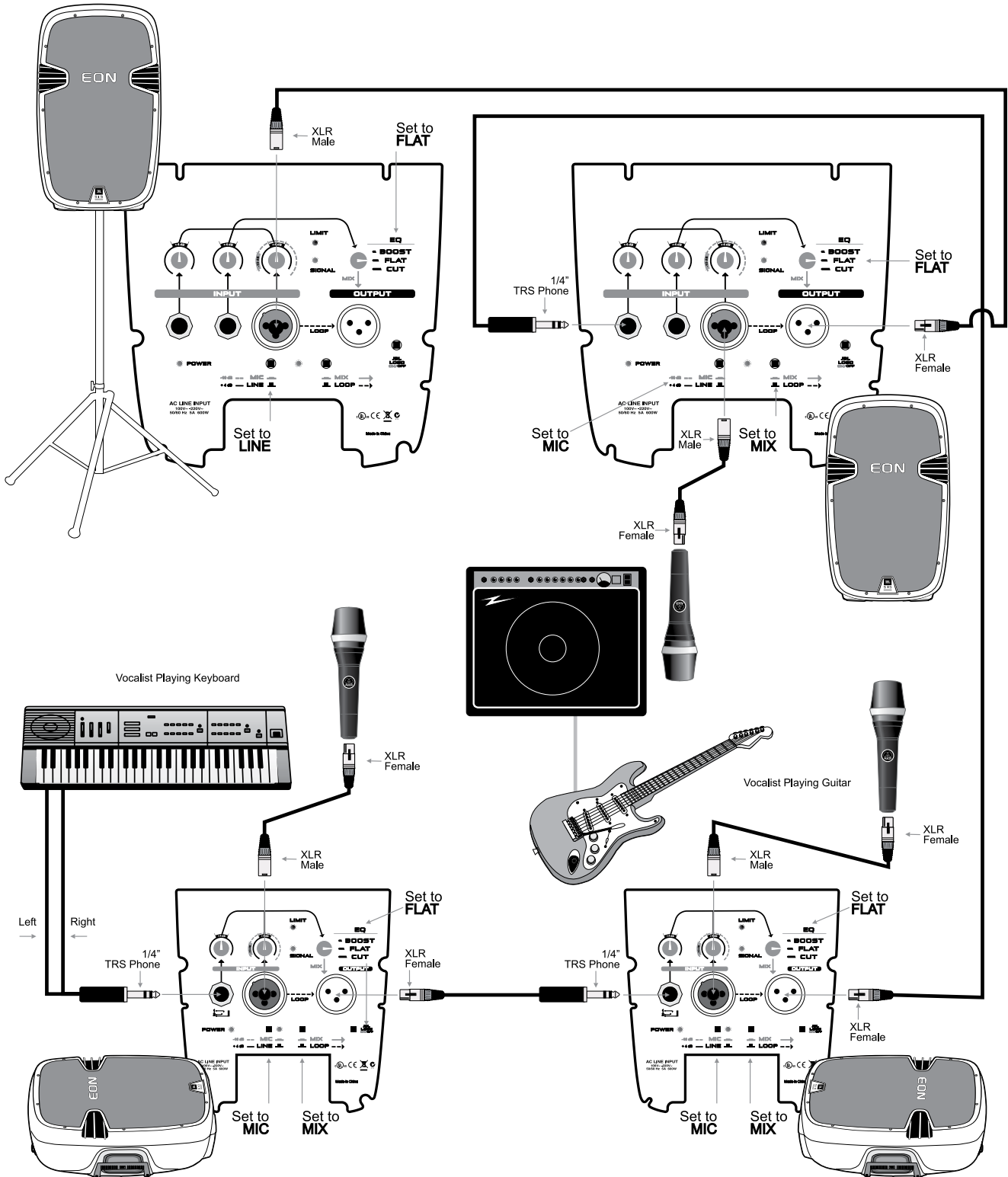

Section 7: Connection Types

There are two basic types of audio system interconnections for audio signals: Balanced and Unbalanced. Your EON® can accept either type of input.

Balanced Lines

In audio, a balanced line is a three-conductor system in which the two signal wires carry an equal, but opposite voltage with respect to the ground wire. The ground wire acts only as a shield and does not carry any audio signal current. Outside interference (such as RFI - Radio Frequency Interference) is either shielded from the internal signal conductor, or if it gets into the cable is cancelled out by the opposite signals at the receiving end. Balanced connections are preferred for any longer cable runs.

Unbalanced Lines

Unbalanced cable is a two-wire system where the shield (ground wire) acts as one of the current carrying signal conductors. The center conductor enclosed by the shield is commonly known as the “hot” conductor. Unbalanced audio cables do not reject noise as well as balanced lines.

Unbalanced lines are typical in home hi-fi type systems and on the outputs of electronic musical instruments. These work well if the distance between the components is short, the signal level is relatively high and all of the electronics used in the system are plugged into the same AC service.

Unbalanced Sources to EON Powered Loudspeakers

If you need to connect your EON speakers to an unbalanced source you have two options:

- Use the LINE 1 and LINE 2 connectors. These inputs are balanced but will accept unbalanced inputs without the need for any special adapters.
- Use an adapter or special cable

Cables and Connectors

Passive Speaker Cables

1/4" Phone to Speakon® NL-4



Dual Banana to Speakon® NL-4

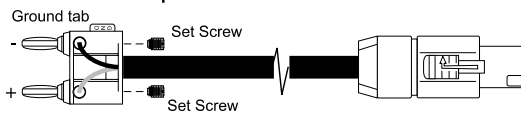

NL-4 to Speakon® NL-4 (with 2 Conductor Cable)



Cables and Connectors (continued)

XLR/F to XLR/M Microphone Cable

The standard cable for interconnection of microphone and line level signal in professional audio systems.

- Microphone to mixer
- Professional audio mixer to EON INPUT
- Microphone to EON INPUT
- "Daisy chaining" EON speaker systems

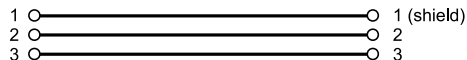

TRS (Balanced) 1/4" Phone to XLR/M Cable

For connecting balanced devices with 1/4" connector to EON XLR input.

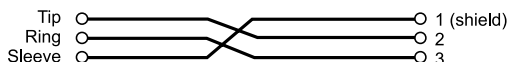

TRS (Unbalanced) 1/4" Phone to XLR/M Cable

For connection of instruments with unbalanced outputs to balanced XLR input.

- Sources (signal processors, electronic instruments) with 1/4" unbalanced outputs to amps, processors, and powered speakers with balanced XLR/F inputs.

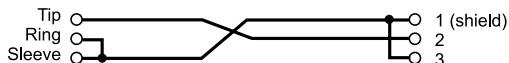

TS (Unbalanced) 1/4" Phone to XLR/M Cable

This cable is electrically identical to "TRS (unbalanced) 1/4" Phone to XLR/M above and may be used interchangeably.

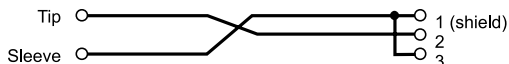

XLR/M to RCA (phono) Cable

Connects consumer audio products and some DJ mixer outputs to professional audio equipment inputs.

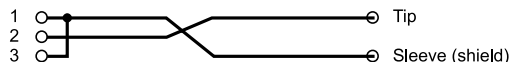

TS (Unbalanced) 1/4" Phone to RCA (phono) Cable

- Connects outputs of consumer audio equipment to unbalanced line inputs of EON15 G2 and many mixers
- Connects unbalanced line outputs of many mixers to the inputs of consumer audio recorders.

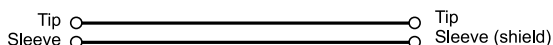

TRS 1/4" Phone to dual TS 1/4" Phone

Splits a stereo output into separate left/right signals.

- Connects stereo electric guitar to two unbalanced audio inputs.
 - Connects a headphone output to two unbalanced audio inputs.
 - Change to a TRS mini-phone to connect to the output of portable CD players and computer sound cards to a mixer or powered speakers.
- Also used to connect signal processors to the "insert" of many mixing consoles.

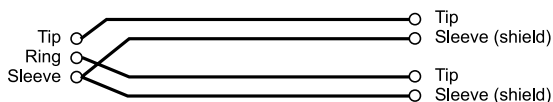
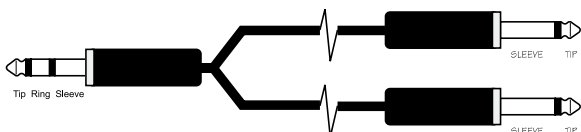

Section 8: Trouble Shooting

Symptom	Likely Cause	What to do
No sound	Speaker not connected to active AC power	Verify that speaker is connected and that the circuit is on
	Power not switched on	Switch on power and verify that power LED is on
No sound, speaker is connected to working AC power but won't come on.	Speaker power cable is faulty or improperly connected.	<ul style="list-style-type: none"> • Re-seat the power cable at both ends. • Substitute a known-good power cable
	Blown fuse	<ul style="list-style-type: none"> • Check fuse and replace with same type "spare fuse in holder".
No sound. Speaker comes on.	Signal source (mixer, instrument, etc.) is not sending.	<ul style="list-style-type: none"> • Check VU meters on the source mixer • Verify that the tape or CD is playing. • Use headphones to verify that the instrument is actually sending an audio signal
	Faulty cables and connections	<ul style="list-style-type: none"> • Disconnect and re-seat signal cables. • Replace suspected cable with a known-good cable
No sound with microphone connected directly to the MIC/ LINE input.	Microphone requires phantom power	The EON does not supply phantom power. Switch to a dynamic microphone, use a battery powered microphone (if possible), use an external phantom power supply for condenser type microphones.
Signal sounds distorted and very loud, LIMIT light is lit most of the time.	Excessive input signal, trying to exceed the capabilities of the speakers	<ul style="list-style-type: none"> • Reduce the output level of the source. • Turn down the level controls on the speaker. • Use additional EON speakers.
Signal sounds distorted even at moderate volumes, LIMIT light is not lit.	Mixer or other source is overdriven	<p>Review the Owner's Manual for your mixer and adjust controls as needed.</p> <ul style="list-style-type: none"> • Input sensitivity (gain) • Channel faders • Master faders Once this is done, review the instructions in the Quick Start section of this guide.
Lots of hiss in the sound, the mixer controls are at very low settings.	Improper gain structure	<ul style="list-style-type: none"> • Make sure that the MIC/LINE switch is in the LINE (disengaged) position. • Reduce the level settings at speaker. Review the Owner's Manual for your mixer and adjust controls as needed. • Input sensitivity (gain) • Channel faders • Master faders
Noise or hiss heard at output.	Noisy source device	Disconnect the devices that are connected to your speaker one at a time. If the noise goes away, the problem is with the source or the connecting cable.
Hum or Buzz that increases or decreases when the mixer level controls are moved.	Improper A/C ground or faulty equipment connected to mixer input	Disconnect or mute channels one at a time to isolate the problem. Refer to the owner's manual of the faulty equipment for troubleshooting help.
	Faulty cable between source equipment and mixer	Substitute a known-good cable for the suspected faulty cable.
Hum or Buzz	Improper A/C grounding, ground loops	<ul style="list-style-type: none"> • 'Lift' the audio ground by using an XLR/F to XLR/M adapter on one end. • Re-route audio cables away from AC power and lighting cables.
	Excessively long unbalanced cable run	<ul style="list-style-type: none"> • Use the balanced outputs (if available) of your mixer or source equipment to drive your EON speakers. • Use a "DI" (direct injection) box to convert your unbalanced equipment output to a balanced output.
	Improper system gain structure	Reduce the INPUT level controls and increase the output level of your source devices.
The inputs from INPUT 1 and INPUT 2 aren't coming out of the OUT connector	MIX/LOOP SWITCH set improperly	Set the MIX/LOOP SWITCH to the MIX position (depressed).
The speaker connected to the OUT connector goes up in volume when I adjust the INPUT 3 control on the first speaker.	MIX/LOOP SWITCH set improperly	Disengage the MIX/LOOP OUT switch, Set to LOOP.
Speakers feed back and howl when the microphone volume is turned up	Microphones are pointed into the speakers	Move the speakers so they do not point at the microphone's pickup pattern.
	Equalizer settings are incorrect	Locate the feedback frequency and reduce it using the mixer EQ or an external equalizer.
	Excessive gain	Reduce the gain at the mixer and move the microphone closer to the sound source.

Section 9: Contact Information



Mailing Address:

JBL Professional
8500 Balboa Blvd.
Northridge, CA 91329

Shipping Address:

JBL Professional
8500 Balboa Blvd., Dock 15
Northridge, CA 91329

(Do not return product to this address without first obtaining prior authorization from JBL)

Customer Service:

Monday through Friday
8:00am -5:00pm
Pacific Coast Time in the U.S.A.
(800) 8JBLPRO (800.852.5776)
www.jblproservice.com

On The World Wide Web:

www.jblpro.com

Professional Contacts, Outside the USA:

Contact the JBL Professional Distributor in your area. A complete list of JBL Professional international distributors is provided at our U.S.A. website: www.jblpro.com

Section 10: Warranty Information

The JBL Limited Warranty on professional loudspeaker products (except for enclosures) remains in effect for five years from the date of the first consumer purchase. JBL amplifiers are warranted for three years from the date of original purchase. Enclosures and all other JBL products are warranted for two years from the date of original purchase.

Who Is Protected By This Warranty?

Your JBL Warranty protects the original owner and all subsequent owners so long as: A.) Your JBL product has been purchased in the Continental United States, Hawaii or Alaska. (This Warranty does not apply to JBL products purchased elsewhere except for purchases by military outlets. Other purchasers should contact the local JBL distributor for warranty information.); and B.) The original dated bill of sale is presented whenever warranty service is required.

What Does The JBL Warranty Cover?

Except as specified below, your JBL Warranty covers all defects in material and workmanship. The following are not covered: Damage caused by accident, misuse, abuse, product modification or neglect; damage occurring during shipment; damage resulting from failure to follow instructions contained in your Instruction Manual; damage resulting from the performance of repairs by someone not authorized by JBL; claims based upon any misrepresentations by the seller; any JBL product on which the serial number has been defaced, modified or removed.

Who Pays For What?

JBL will pay all labor and material expenses for all repairs covered by this warranty. Please be sure to save the original shipping cartons because a charge will be made if replacement cartons are requested. Payment of shipping charges is discussed in the next section of this warranty.

How To Obtain Warranty Performance

If your JBL product ever needs service, write or telephone us at JBL Incorporated (Attn: Customer Service Department), 8500 Balboa Boulevard, PO. Box 2200, Northridge, California 91329 (818/893-8411). We may direct you to an authorized JBL Service Agency or ask you to send your unit to the factory for repair. Either way, you'll need to present the original bill of sale to establish the date of purchase. Please do not ship your JBL product to the factory without prior authorization. If transportation of your JBL product presents any unusual difficulties, please advise us and we may make special arrangements with you. Otherwise, you are responsible for transporting your product for repair or arranging for its transportation and for payment of any initial shipping charges. However, we will pay the return shipping charges if repairs are covered by the warranty.

Limitation of Implied Warranties

ALL IMPLIED WARRANTIES, INCLUDING WARRANTIES OF MERCHANTABILITY AND FITNESS FOR PARTICULAR PURPOSE, ARE LIMITED IN DURATION TO THE LENGTH OF THIS WARRANTY.

EXCLUSION OF CERTAIN DAMAGES

JBL'S LIABILITY IS LIMITED TO THE REPAIR OR REPLACEMENT, AT OUR OPTION, OF ANY DEFECTIVE PRODUCT AND SHALL NOT INCLUDE INCIDENTAL OR CONSEQUENTIAL DAMAGES OF ANY KIND. SOME STATES DO NOT ALLOW LIMITATIONS ON HOW LONG AN IMPLIED WARRANTY LASTS AND/OR DO NOT ALLOW THE EXCLUSION OF INCIDENTAL OR CONSEQUENTIAL DAMAGES, SO THE ABOVE LIMITATIONS AND EXCLUSIONS MAY NOT APPLY TO YOU. THIS WARRANTY GIVES YOU SPECIFIC LEGAL RIGHTS, AND YOU MAY ALSO HAVE OTHER RIGHTS, WHICH VARY, FROM STATE TO STATE.

JBL Professional
8500 Balboa Boulevard
Northridge, CA 91329 USA

7/2008 Visit us online at www.jblpro.com
EON® and Differential Drive® are registered trademarks of JBL/Harman.



by HARMAN

Part Number: 364822-001