

dbx[®]
by HARMAN

TR1616

Performance I/O



Owner's Manual

IMPORTANT SAFETY INSTRUCTIONS



ATTENTION: RISQUE DE CHOQUE ELECTRIQUE - NE PAS OUVRIR

WARNING: TO REDUCE THE RISK OF FIRE OR ELECTRIC SHOCK DO NOT EXPOSE THIS EQUIPMENT TO RAIN OR MOISTURE

The symbols shown above are internationally accepted symbols that warn of potential hazards with electrical products. The lightning flash with arrowpoint in an equilateral triangle means that there are dangerous voltages present within the unit. The exclamation point in an equilateral triangle indicates that it is necessary for the user to refer to the owner's manual.

These symbols warn that there are no user serviceable parts inside the unit. Do not open the unit. Do not attempt to service the unit yourself. Refer all servicing to qualified personnel. Opening the chassis for any reason will void the manufacturer's warranty. Do not get the unit wet. If liquid is spilled on the unit, shut it off immediately and take it to a dealer for service. Disconnect the unit during storms to prevent damage.

SAFETY INSTRUCTIONS

NOTICE FOR CUSTOMERS IF YOUR UNIT IS EQUIPPED WITH A POWER CORD.

WARNING: THIS APPLIANCE SHALL BE CONNECTED TO A MAINS SOCKET OUTLET WITH A PROTECTIVE EARTHING CONNECTION.

THE CORES IN THE MAINS LEAD ARE COLOURED IN ACCORDANCE WITH THE FOLLOWING CODE:

GREEN AND YELLOW - EARTH BLUE - NEUTRAL BROWN - LIVE

AS COLOURS OF THE CORES IN THE MAINS LEAD OF THIS APPLIANCE MAY NOT CORRESPOND WITH THE COLOURED MARKINGS IDENTIFYING THE TERMINALS IN YOUR PLUG, PROCEED AS FOLLOWS:

- THE CORE WHICH IS COLOURED GREEN AND YELLOW MUST BE CONNECTED TO THE TERMINAL IN THE PLUG MARKED WITH THE LETTER E, OR WITH THE EARTH SYMBOL, OR COLOURED GREEN, OR GREEN AND YELLOW.
- THE CORE WHICH IS COLOURED BLUE MUST BE CONNECTED TO THE TERMINAL MARKED N OR COLOURED BLACK.
- THE CORE WHICH IS COLOURED BROWN MUST BE CONNECTED TO THE TERMINAL MARKED L OR COLOURED RED.

THIS EQUIPMENT MAY REQUIRE THE USE OF A DIFFERENT LINE CORD, ATTACHMENT PLUG, OR BOTH, DEPENDING ON THE AVAILABLE POWER SOURCE AT INSTALLATION. IF THE ATTACHMENT PLUG NEEDS TO BE CHANGED, REFER SERVICING TO QUALIFIED SERVICE PERSONNEL WHO SHOULD REFER TO THE TABLE BELOW. THE GREEN/YELLOW WIRE SHALL BE CONNECTED DIRECTLY TO THE UNITS CHASSIS.

CONDUCTOR		WIRE COLOR	
		Normal	Alt
L	LIVE	BROWN	BLACK
N	NEUTRAL	BLUE	WHITE
E	EARTH GND	GREEN/YEL	GREEN

WARNING: IF THE GROUND IS DEFEATED, CERTAIN FAULT CONDITIONS IN THE UNIT OR IN THE SYSTEM TO WHICH IT IS CONNECTED CAN RESULT IN FULL LINE VOLTAGE BETWEEN CHASSIS AND EARTH GROUND. SEVERE INJURY OR DEATH CAN THEN RESULT IF THE CHASSIS AND EARTH GROUND ARE TOUCHED SIMULTANEOUSLY.

WARNING FOR YOUR PROTECTION READ THE FOLLOWING:

KEEP THESE INSTRUCTIONS

HEED ALL WARNINGS

FOLLOW ALL INSTRUCTIONS

the apparatus shall not be exposed to dripping or splashing liquid and no object filled with liquid, such as vases, shall be placed on the apparatus.

CLEAN ONLY WITH A DRY CLOTH.

DO NOT BLOCK ANY OF THE VENTILATION OPENINGS. INSTALL IN ACCORDANCE WITH THE MANUFACTURER'S INSTRUCTIONS.

DO NOT INSTALL NEAR ANY HEAT SOURCES SUCH AS RADIATORS, HEAT REGISTERS, STOVES, OR OTHER APPARATUS (INCLUDING AMPLIFIERS) THAT PRODUCE HEAT.

ONLY USE ATTACHMENTS/ACCESSORIES SPECIFIED BY THE MANUFACTURER.

UNPLUG THIS APPARATUS DURING LIGHTNING STORMS OR WHEN UNUSED FOR LONG PERIODS OF TIME.

Do not defeat the safety purpose of the polarized or grounding-type plug. A polarized plug has two blades with one wider than the other. A grounding type plug has two blades and a third grounding prong. The wide blade or third prong are provided for your safety. If the provided plug does not fit your outlet, consult an electrician for replacement of the obsolete outlet.

Protect the power cord from being walked on or pinched particularly at plugs, convenience receptacles, and the point where they exit from the apparatus.

Use only with the cart stand, tripod bracket, or table specified by the manufacture, or sold with the apparatus. When a cart is used, use caution when moving the cart/apparatus combination to avoid injury from tip-over.



Refer all servicing to qualified service personnel. Servicing is required when the apparatus has been damaged in any way, such as power-supply cord or plug is damaged, liquid has been spilled or objects have fallen into the apparatus, the apparatus has been exposed to rain or moisture, does not operate normally, or has been dropped.

POWER ON/OFF SWITCH: The Power switch used in this piece of equipment DOES NOT break the connection from the mains.

MAINS DISCONNECT: The plug shall remain readily operable. For rack-mount or installation where plug is not accessible, an all-pole mains switch with a contact separation of at least 3 mm in each pole shall be incorporated into the electrical installation of the rack or building.

If connected to 240V supply, a suitable CSA/UL certified power cord shall be used for this supply.

This Equipment is intended for rack mount use only.

IMPORTANT SAFETY INSTRUCTIONS

ELECTROMAGNETIC COMPATIBILITY

This device complies with part 15 of the FCC Rules and the Product Specifications noted on the **Declaration of Conformity**. Operation is subject to the following two conditions:

- this device may not cause harmful interference, and
- this device must accept any interference received, including interference that may cause undesired operation.

Operation of this unit within significant electromagnetic fields should be avoided.

- use only shielded interconnecting cables.

U.K. MAINS PLUG WARNING

A molded mains plug that has been cut off from the cord is unsafe. Discard the mains plug at a suitable disposal facility.

NEVER UNDER ANY CIRCUMSTANCES SHOULD YOU INSERT A DAMAGED OR CUT MAINS PLUG INTO A 13 AMP POWER SOCKET.

Do not use the mains plug without the fuse cover in place.

Replacement fuse covers can be obtained from your local retailer.

Replacement fuses are 13 amps and **MUST** be ASTA approved to BS1362.



If you want to dispose this product, do not mix it with general household waste. There is a separate collection system for used electronic products in accordance with legislation that requires proper treatment, recovery and recycling.

Private household in the 25 member states of the EU, in Switzerland and Norway may return their used electronic products free of charge to designated collection facilities or to a retailer (if you purchase a similar new one).

For Countries not mentioned above, please contact your local authorities for a correct method of disposal.

By doing so you will ensure that your disposed product undergoes the necessary treatment, recovery and recycling and thus prevent potential negative effects on the environment and human health.

SUPPORT/SERVICE CONTACT

If you require technical support, contact dbx Technical Support. Be prepared to accurately describe the problem. Know the serial number of your device—this is printed on a sticker attached to the chassis. If you have not already taken the time to fill out your warranty registration card and send it in, please do so now. You may also register online at www.dbxpro.com.

Before you return a product to the factory for service, we recommend you refer to the manual. Make sure you have correctly followed installation steps and operation procedures. For further technical assistance or service, please contact our Technical Support Department at (801) 568-7660 or visit www.dbxpro.com. If you need to return a product to the factory for service, **YOU MUST FIRST CONTACT TECHNICAL SUPPORT TO OBTAIN A RETURN AUTHORIZATION NUMBER.**

NO RETURNED PRODUCTS WILL BE ACCEPTED AT THE FACTORY WITHOUT A RETURN AUTHORIZATION NUMBER.

Please refer to the Warranty information on the following page, which extends to the first end-user. After expiration of the warranty, a reasonable charge will be made for parts, labor, and packing if you choose to use the factory service facility. In all cases, you are responsible for transportation charges to the factory. dbx will pay return shipping if the unit is still under warranty.

Use the original packing material if it is available. Mark the package with the name of the shipper and with these words in red: **DELICATE INSTRUMENT, FRAGILE!** Insure the package properly. Ship prepaid, **NOT COLLECT. DO NOT SHIP PARCEL POST.**

WARRANTY

1. The warranty registration card that accompanies this product must be mailed within 30 days after purchase date to validate this warranty. You can also register online at www.dbxpro.com. Proof-of-purchase is considered to be the responsibility of the consumer. A copy of the original purchase receipt must be provided for any warranty service.
2. dbx warrants this product, when purchased new from an authorized U.S. dbx dealer and used solely within the U.S., to be free from defects in materials and workmanship under normal use and service. This warranty is valid to the original purchaser only and is non-transferable.
3. dbx liability under this warranty is limited to repairing or, at our discretion, replacing defective materials that show evidence of defect, provided the product is returned to dbx **WITH RETURN AUTHORIZATION** from the factory, where all parts and labor will be covered up to a period of two years. A Return Authorization number must first be obtained from dbx. The company shall not be liable for any consequential damage as a result of the product's use in any circuit or assembly.
4. dbx reserves the right to make changes in design or make additions to or improvements upon this product without incurring any obligation to install the same additions or improvements on products previously manufactured.
5. The foregoing is in lieu of all other warranties, expressed or implied, and dbx neither assumes nor authorizes any person to assume on its behalf any obligation or liability in connection with the sale of this product. In no event shall dbx or its dealers be liable for special or consequential damages or from any delay in the performance of this warranty due to causes beyond their control.

TABLE OF CONTENTS

INTRODUCTION	2
FEATURES	2
PACKAGE CONTENTS	3
INSTALLATION RECOMMENDATIONS	3
QUICK START	3
PANEL DESCRIPTIONS	4
Front Panel	4
Rear Panel	6
MAKING CONNECTIONS—CABLING	8
Power	8
BLU link	8
Analog Inputs	8
Analog Outputs	8
APPLICATIONS	10
Personal Monitoring w/dbx PMC16s	10
16 x 16 Digital Snake w/Personal Monitoring	12
32 x 32 Digital Snake w/Personal Monitoring	14
32 Channel BSS Soundweb London On-Ramp/Off-Ramp	16
OPERATING INSTRUCTIONS	18
Setting BLU link Receive & Transmit Banks	18
BLU link Status Indicators	19
TR1616 Preamp Setup	20
FIRMWARE UPDATES	21
BLOCK DIAGRAM	22
DIMENSIONS	23
SPECIFICATIONS	24

INTRODUCTION

Thank you for choosing the dbx® TR1616 16 channel performance I/O. The TR1616 is a 16 in/16 out analog to BLU link and BLU link to analog audio interface. By providing a modular yet simple solution, the TR1616 is highly expandable and extremely easy to configure.

With 16 precision dbx mic preamps and combo style input jacks, the TR1616 accepts line level or mic level signals.

Configurable in 16 channel blocks, the modular design of the TR1616 allows you to create the digital snake or BLU link network that's right for you. As your needs change, additional TR1616s can easily be added to the network, providing expansion of up to 256 channels at 48 kHz (or 128 channels at 96 kHz). And with its plug and play functionality, getting into networked digital audio no longer requires long hours of training and programming.

Whether you require additional analog inputs or outputs in an existing BLU link compatible BSS Audio Soundweb London system, a digital snake solution for live sound, or a complete personal stage monitoring solution using the dbx PMC personal monitor controllers, the TR1616 provides a professional, cost effective solution for transmitting high resolution audio over CAT5e.

FEATURES

- 16 Channels of Analog I/O
- Combo Analog Input Jacks Accept 1/4" or XLR Connections
- XLR Analog Output Jacks
- BLU link High Bandwidth, Fault Tolerant Digital Audio Bus
- Precision dbx Mic Preamps with Variable Gain Control
- +48 Volts Phantom Power per Channel
- 80 Hz Low Cut Filter per Channel
- Polarity Inversion per Channel
- 20dB Pad per Channel
- 4-Segment LED Input Level Meter per Channel
- Dual 7-Segment BLU link Channel Bank Indicators (Receive/Transmit)
- Supports 48 kHz & 96 kHz Sampling Rates
- Expandable up to 256 Channels @ 48 kHz (128 Channels @ 96 kHz)
- Support for up to 16 TR1616s on a Single BLU link Ring
- USB Port for Firmware Updates

PACKAGE CONTENTS

The TR1616 was packaged with extreme care. Please take a moment to ensure the items listed below were received and that no damage to contents has occurred.

- TR1616 Performance I/O Interface
- AC Cable
- Manual
- Rack Mount Screw Kit

INSTALLATION RECOMMENDATIONS

FOR RACK MOUNT USE ONLY. Install the TR1616 in your rack with the provided rack screws. When installed in a rack, the TR1616 must be positioned with one empty rack space above and below the unit to allow for proper ventilation. The TR1616 should not be mounted above or below anything that generates excessive heat. Ambient temperatures should not exceed 95° F (35° C) when equipment is in use. Although the unit is shielded against radio frequency and electromagnetic interference, extremely high fields of RF and EMI should be avoided where possible.

QUICK START

To begin using the dbx TR1616:

1. Turn off all equipment before making audio connections to the TR1616.
2. Make audio connections to the TR1616. See “Making Connections–Cabling” for further information
3. Connect the included power cable to the TR1616’s power inlet then connect the other end to an available AC outlet.
4. Determine and assign the proper RECEIVE and TRANSMIT BANKS on each TR1616. Each TR1616 on the BLU link network must have a unique TRANSMIT BANK selected. See “Operating Instructions > Setting BLU link Receive & Transmit Banks” for further information.
5. Setup each TR1616 input preamp using each channel’s controls, as described in “TR1616 Preamp Setup”.

PANEL DESCRIPTIONS

Front Panel

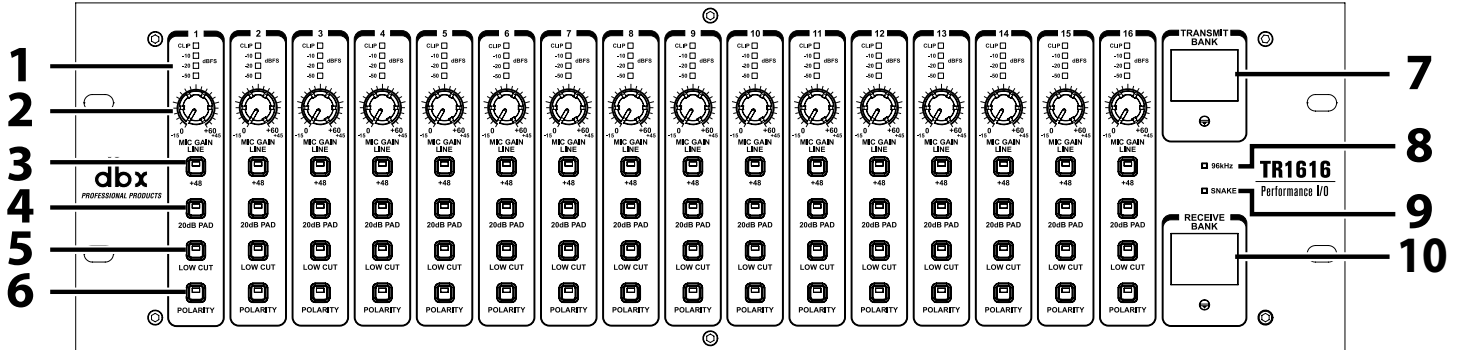

1. 4-Segment Input Meter

These meters display the input signal level for each channel.

2. GAIN Knob

These knobs adjust the input gain for each channel. The range of these controls is 0 dB to +60 dB (XLR input) and -15 dB to +45 dB (1/4" input).

3. +48 Button

+48 Volts of phantom power is available for condenser microphones and direct boxes which require it. These buttons enable and disable the phantom power for each channel. The button's LED will light when the function is engaged.

4. 20dB PAD Button

These buttons enable the 20dB pad for each channel, which can be used to prevent the preamp input from being overdriven. The button's LED will light when the function is engaged.

5. LOW CUT Button

These buttons enable and disable the low cut filter for each channel. This filter is a low cut filter with a cutoff frequency of 80 Hz. The button's LED will light when the function is engaged.

6. POLARITY Button

These buttons enable and disable the 180° polarity inversion for each channel. The button's LED will light when the function is engaged.

7. TRANSMIT BANK Display

This dual 7-segment display shows which bank on the BLU link network the TR1616 is transmitting its audio on. Each bank consists of 16 channels. Each TR1616 on the network must have a unique TRANSMIT BANK selected. The desired TRANSMIT BANK can be selected by adjusting the slotted control below the display. See "Making Connections-Cabling" > "BLU link" for further information on this display.

8. 96 kHz LED

This LED will light when the 96 kHz button on the back panel of the TR1616 is engaged, indicating the TR1616 is configured to clock to a BLU link signal operating at a 96 kHz sampling rate. When the 96 kHz button is disengaged, the sample rate of the TR1616 is 48 kHz.

9. SNAKE LED

This LED will light when the Snake Enable button on the back panel of the TR1616 is engaged, indicating the TR1616 has been configured for use in a TR1616 digital snake network.

10. RECEIVE BANK Display

This dual 7-segment display shows the currently selected bank of BLU link channels which will be received by the TR1616 and routed to the analog outputs. Each bank consists of 16 channels. The desired RECEIVE BANK can be selected by adjusting the slotted control below the display. See “Making Connections–Cabling” > “BLU link” for further information on this display.

Rear Panel

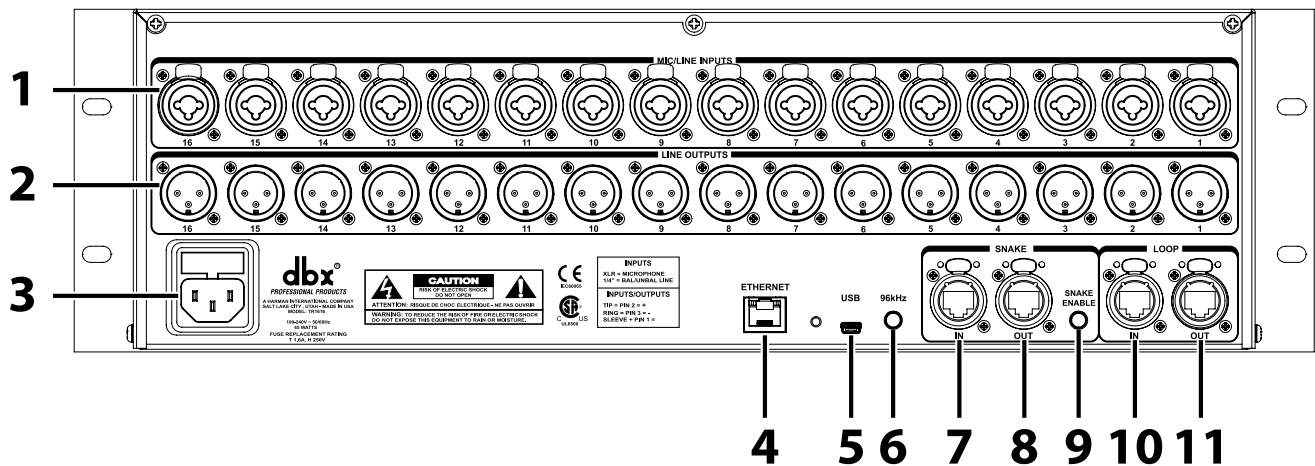

1. INPUTS

These combination analog input jacks accept: 1/4" or XLR type plugs, line level or mic level signals, and balanced or unbalanced connections.

2. OUTPUTS

These XLR analog output jacks output a balanced analog signal, received and converted from the BLU link audio network.

3. AC Power Inlet

Provides power to the TR1616 using the provided IEC type AC power cord. A fuse drawer provides access to the fuse. Replace with same type fuse only.

4. ETHERNET Port

This port allows for future expansion of the TR1616's feature set.

5. USB Port

Using a standard Mini USB cable, this port is used for connecting a PC for updating the TR1616's firmware.

6. 96 kHz Button

Engage this button when connecting to a BLU link network operating at a 96 kHz sampling rate. Disengage this button when connecting to a BLU link network operating at a 48 kHz sampling rate.

NOTE: BLU link supports 256 channels at 48 kHz and 128 channels at 96 kHz.

7. SNAKE IN Port

When using two or more TR1616s in a digital snake network, connect this Ethercon connector to the SNAKE OUT port on the sending TR1616 device.

8. SNAKE OUT Port

When using two or more TR1616s in a digital snake network, connect this Ethercon connector to the SNAKE IN port on the receiving TR1616 device.

9. SNAKE ENABLE Button

When this button is engaged, the TR1616 will transmit and receive BLU link audio through the SNAKE IN and SNAKE OUT ports. Engage this button on two TR1616s which carry and receive the signal between the front of house and stage locations.

10. LOOP IN Port

Connect this Ethercon connection to the BLU link output of a sending BLU link compatible device or to the BLU link LOOP OUT port of another TR1616.

11. LOOP OUT Port

Connect this Ethercon connector to the BLU link input of a receiving BLU link compatible device or to the BLU link LOOP IN port of another TR1616.

MAKING CONNECTIONS-CABLING

It is recommended that power on all interconnecting equipment be turned off before making audio connections to the TR1616.

Power

Connect the included IEC power cable to this fused AC inlet. Connect the other end to an available AC power outlet. The TR1616 does not have a power switch. An AC power strip or power conditioner can be used for switching power to the TR1616 on and off.

NOTE: If the fuse becomes compromised, replace with the same type fuse only. See “Specifications” for fuse information.

Analog Inputs

These combination inputs accept XLR or 1/4” analog connections. Use the XLR inputs for connecting low impedance microphones and DI boxes and the 1/4” inputs for line level devices with balanced or unbalanced connections. The wiring conventions of these connectors are shown to the right.

1/4”		XLR	
Tip	Hot	Pin 1	Ground
Ring	Cold	Pin 2	Hot
Sleeve	Ground	Pin 3	Cold

NOTE: All microphones and devices requiring phantom power must be connected using the XLR input connections.

Analog Outputs

These XLR analog outputs provide balanced audio connections. The wiring convention of these connectors are shown to the right.

XLR	
Pin 1	Ground
Pin 2	Hot
Pin 3	Cold

BLU link

The SNAKE IN, SNAKE OUT, LOOP IN, and LOOP OUT ports are all BLU link ports and require the same type of cabling. BLU link is a proprietary point to point networking protocol that requires CAT5e or better cable. The BLU link ports are auto sensing, so you can use either a straight through cable (same termination on both ends) or crossover cable between them. The maximum allowable cable length of a single BLU link connection is 100 m (328 ft). By closing the BLU link ring, BLU link’s built-in fault tolerance feature can be utilized.

Any of the CAT5e cable configurations shown in the below table can be used when making BLU link connections.

TIA/EIA 568A Straight Through		TIA/EIA 568B Straight Through	
RJ-45 (8-Position)		RJ-45 (8-Position)	
1	White / Green	1	White / Orange
2	Green	2	Orange
3	White / Orange	3	White / Green
4	Blue	4	Blue
5	White / Blue	5	White / Blue
6	Orange	6	Green
7	White / Brown	7	White / Brown
8	Brown	8	Brown
TIA/EIA 568A Crossover		TIA/EIA 568B Crossover	
RJ-45 (8-Position)		RJ-45 (8-Position)	
1	Gr/Wh	1	Wh/Or
2	Gr	2	Or
3	Wh/Or	3	Gr/Wh
4	Bl	4	Wh/Br
5	Wh/Bl	5	Br
6	Or	6	Gr
7	Wh/Br	7	Bl
8	Br	8	Wh/Bl

NOTE: The BLU link network ring must be closed for the BLU link fault tolerance feature to work. The fault tolerance feature ensures audio will still pass through the network if one of the cables in the BLU link network is compromised. This means that when TR1616s are being used as a digital snake, the TR1616s on both sides of the snake connection must complete the BLU link ring. If using a single TR1616 on either side of the snake connection and no other BLU link devices are connected, such as PMC16s, the LOOP OUT port should be connected to the LOOP IN port to close the BLU link ring, as shown below. See page 12 to see full diagram.

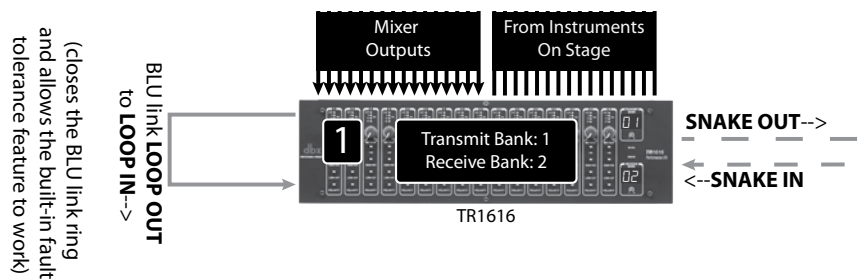

For more information on BLU link, please visit www.dbxpro.com.

APPLICATIONS

Personal Monitoring w/dbx PMC16s

Recommended for:

- Small Performance Venues
- Portable Live Sound
- Houses Of Worship
- Rehearsal Spaces

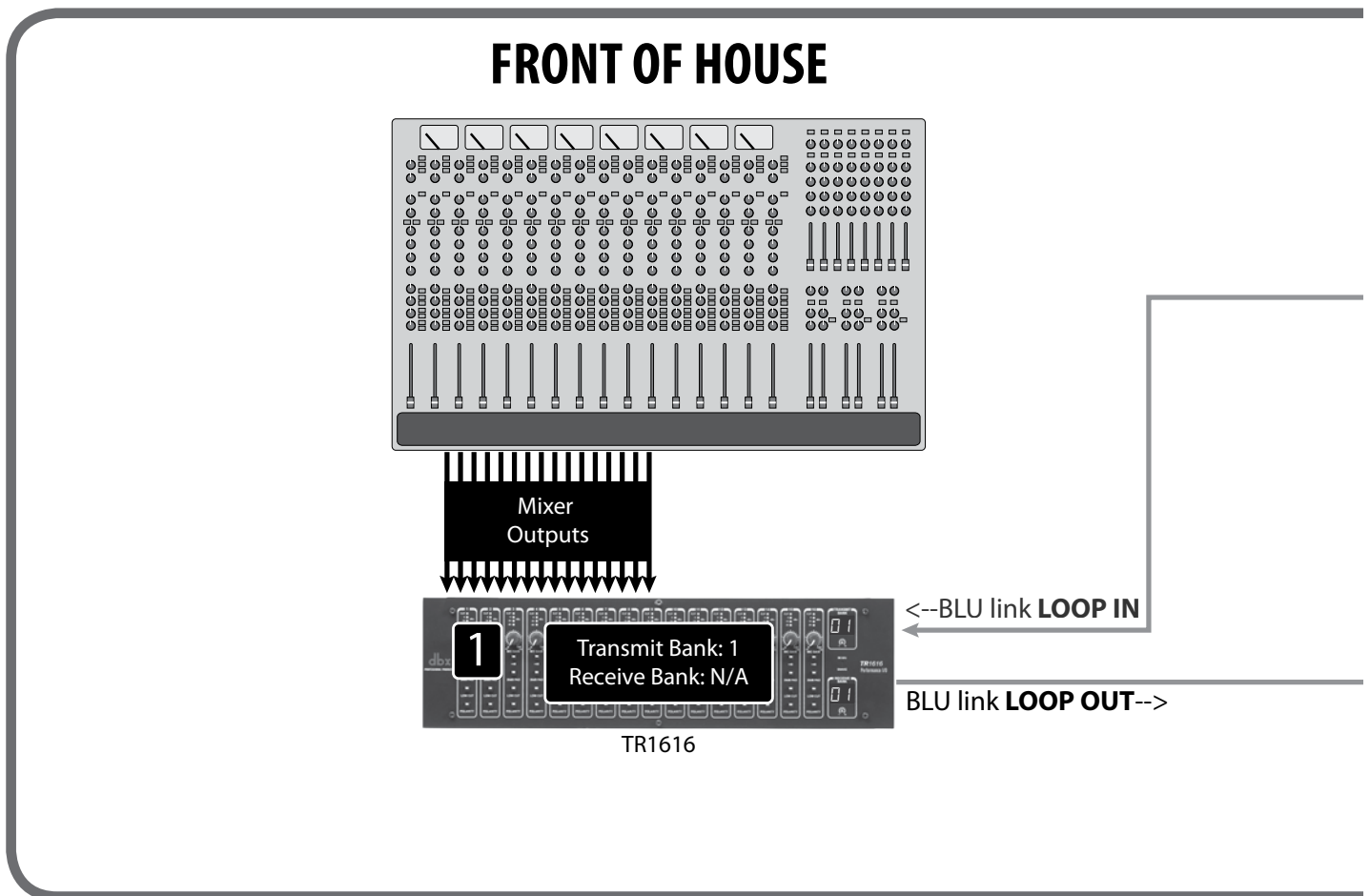

Key Points:

- Up to 16 channels can be received at the PMC16s on stage from front of house.
- Up to 60 PMC16s can be connected to the network.
- System can be further expanded in the future if needed.

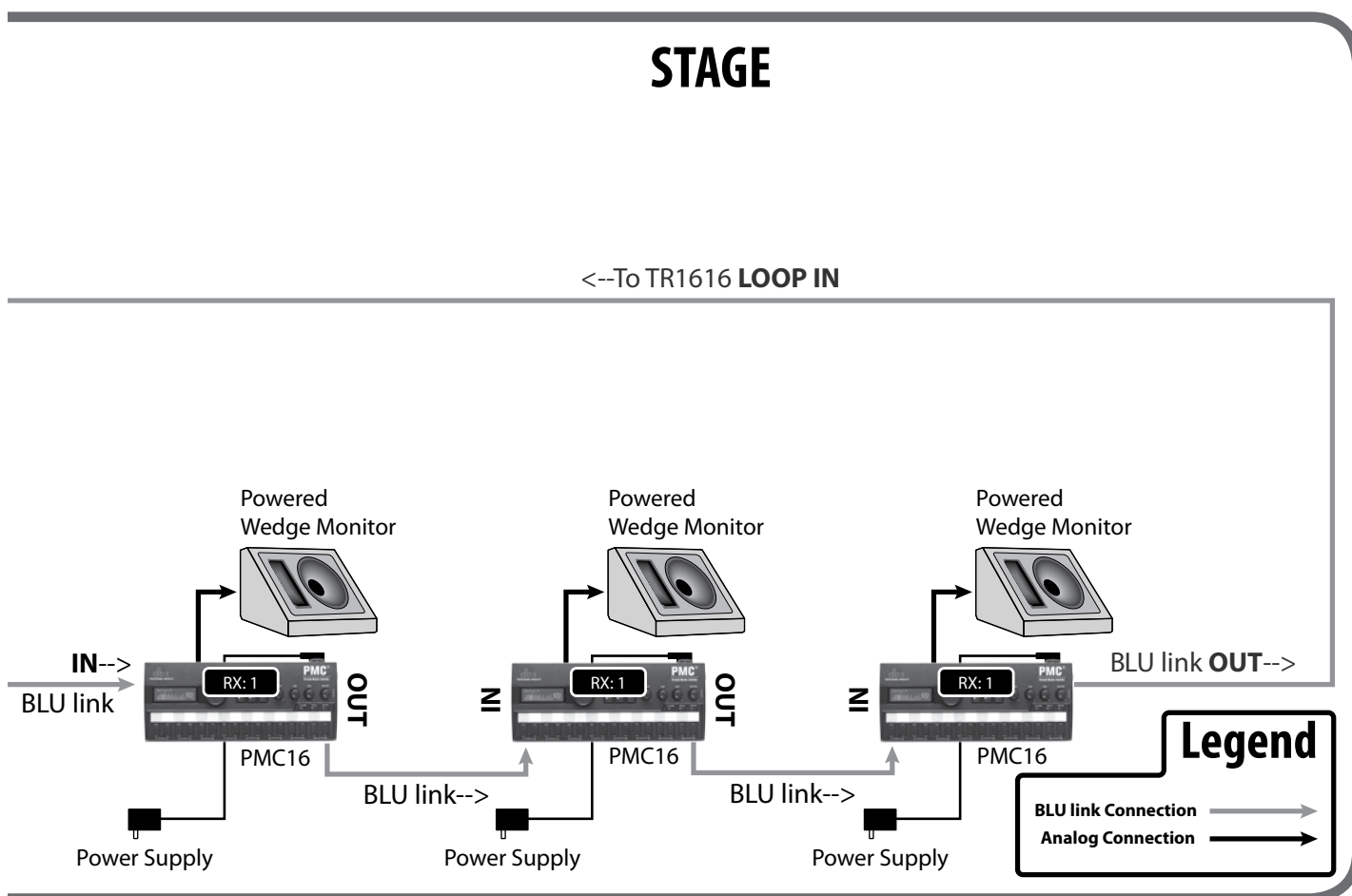

16 x 16 Digital Snake w/Personal Monitoring

Recommended for:

- Small To Medium Performance Venues
- Portable Live Sound
- Houses Of Worship

NOTE: The BLU link ring in the below diagram is closed by connecting the #1 TR1616's LOOP OUT port to the LOOP IN port. However, it is also possible to close the BLU link ring without using this extra cable connection. To do this, leave the snake mode disabled on the #1 TR1616 and make the following connections:

- #2 TR1616 **SNAKE OUT** > #1 TR1616 **LOOP IN**
- #1 TR1616 **LOOP OUT** > #2 TR1616 **SNAKE IN**

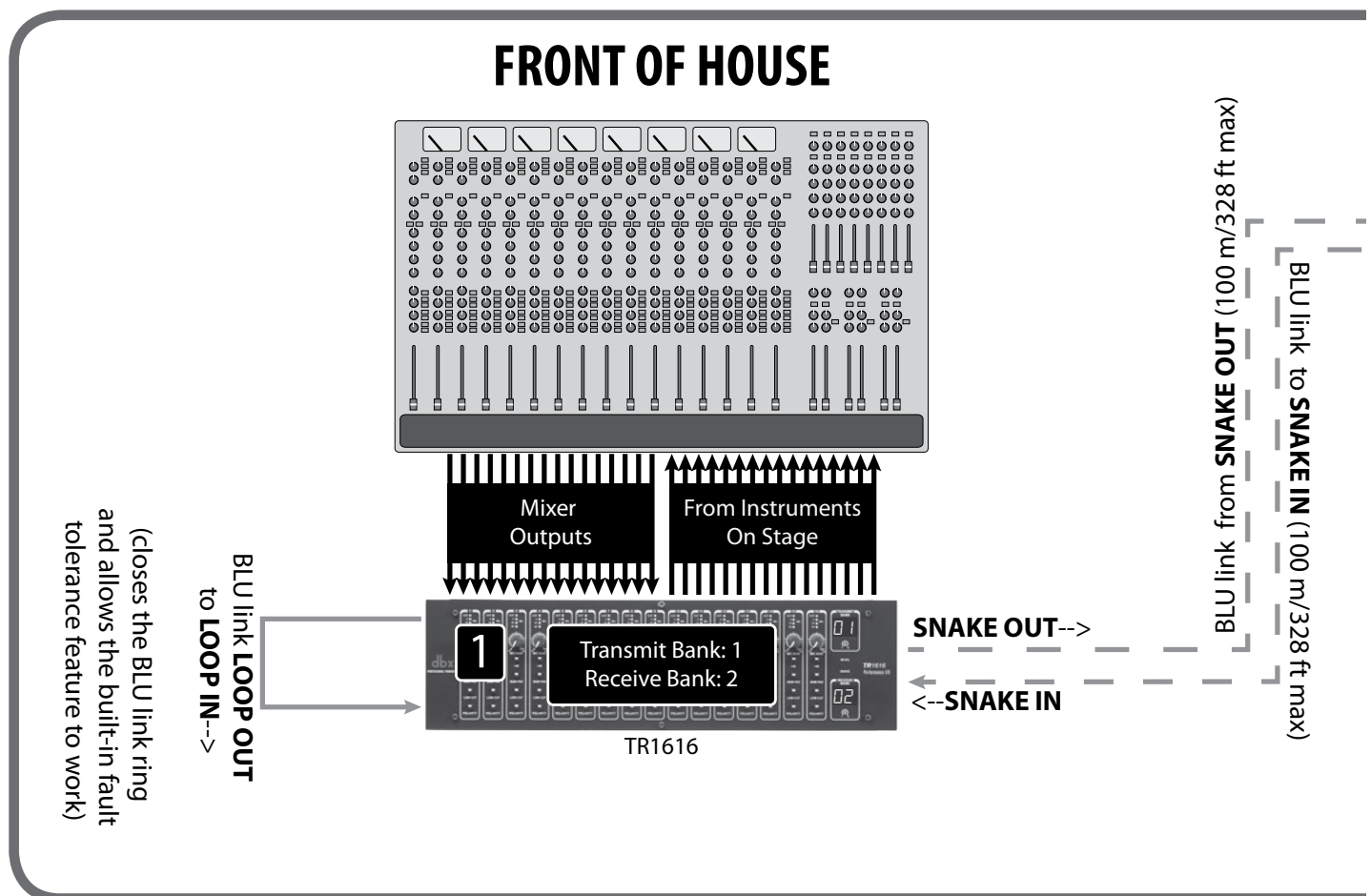

Key Points:

- Up to 16 channels can be received at front of house from the stage.
- Up to 16 channels can be returned to the stage from front of house.
- Up to 60 PMC16s can be connected to the network.
- Although this diagram does not show it, the main mixer outputs could be connected to the #1 TR1616 and then fed to the #2 TR1616 for feeding the amplifiers or loudspeaker management processor for the main PA speakers.
- System can be further expanded in the future if needed.

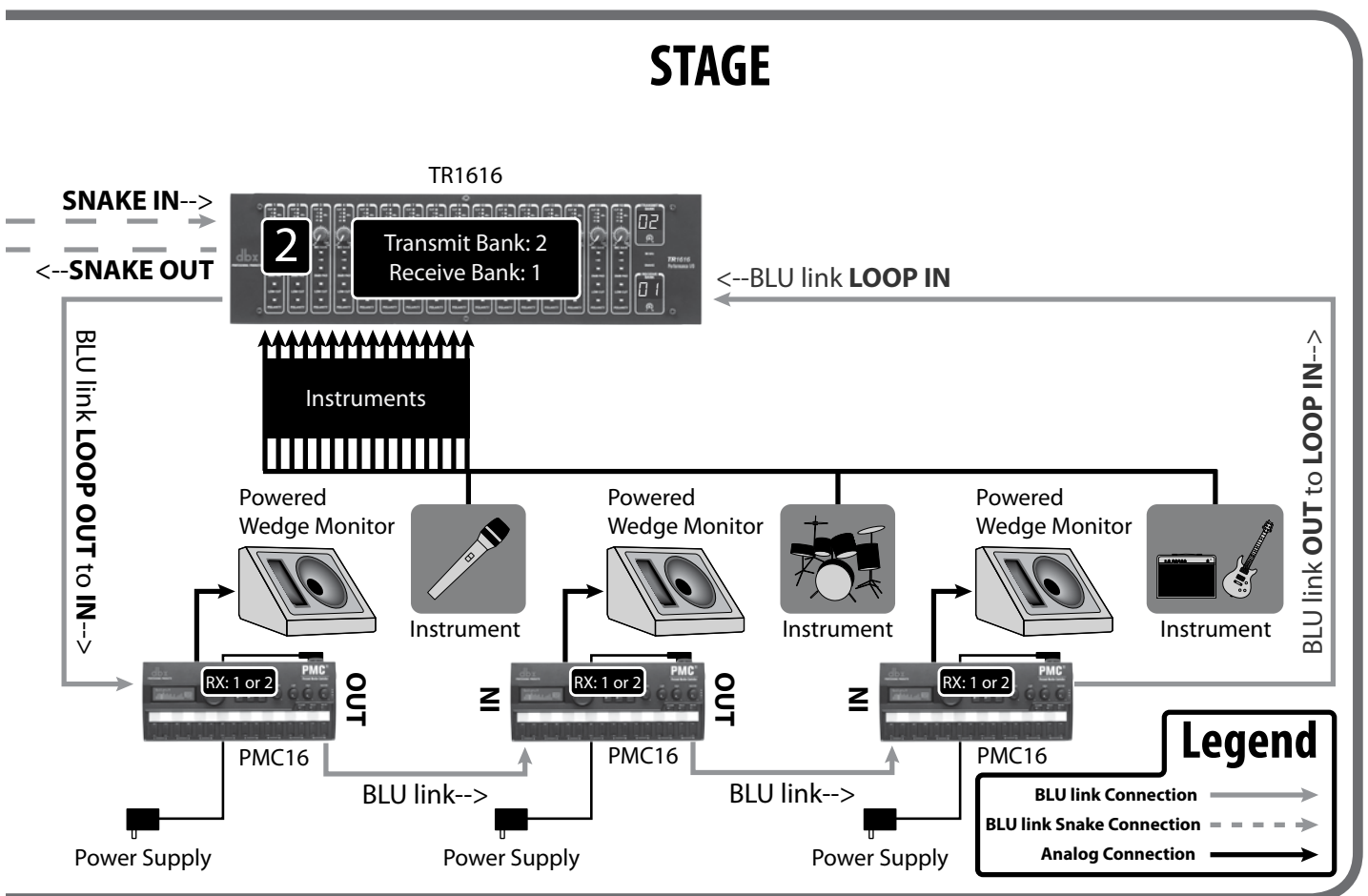

32 x 32 Digital Snake w/Personal Monitoring

Recommended for:

- Large Performance Venues
- Houses Of Worship
- Ensembles
- Orchestras

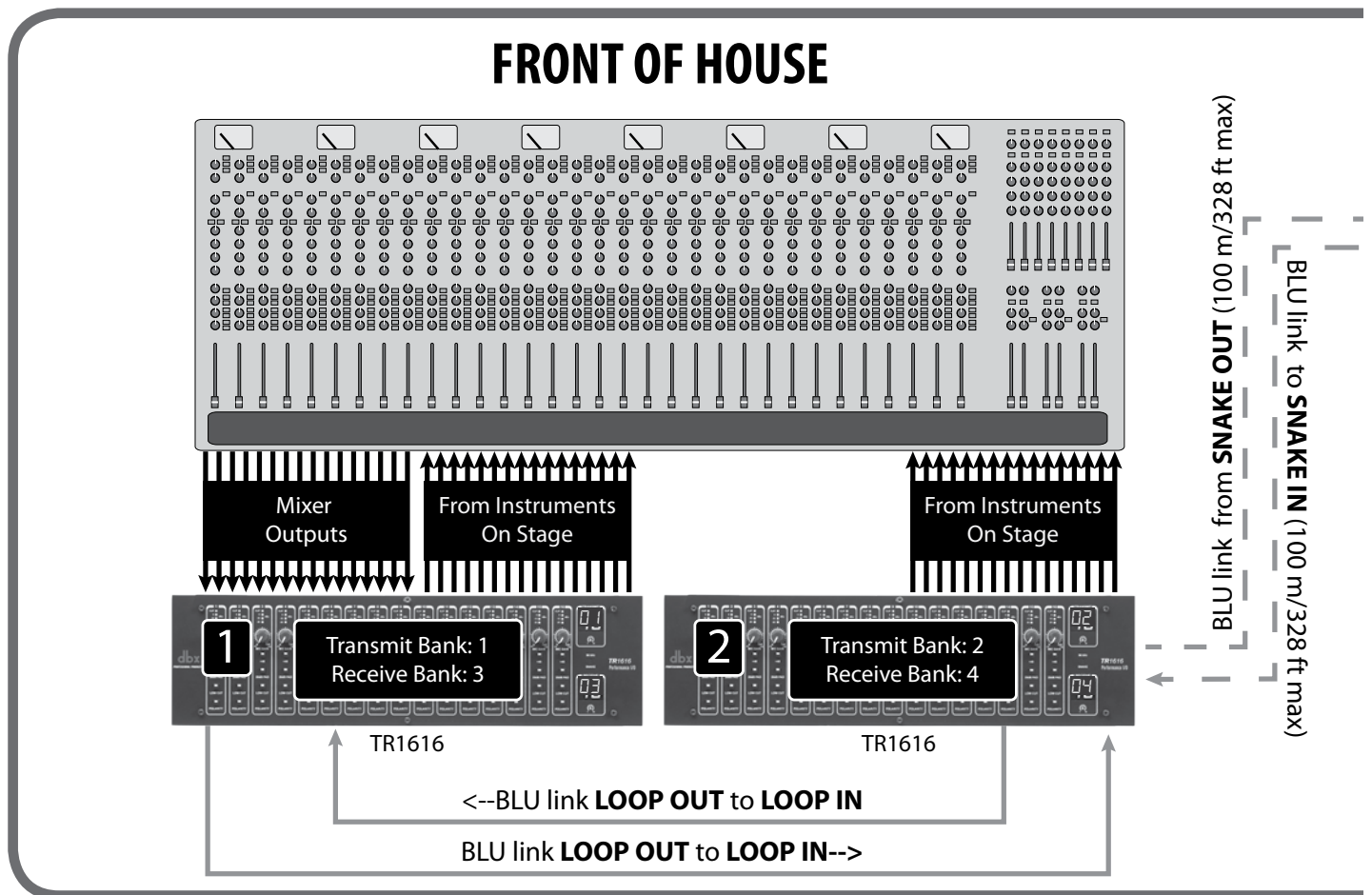

Key Points:

- Up to 32 channels can be received at front of house from the stage.
- Up to 32 channels can be returned to the stage from front of house.
- Up to 60 PMC16s can be connected to the network
- Snake mode is enabled on the #2 and #3 TR1616s and disabled on the #1 and #4 TR1616s.
- Although this diagram does not show it, the main mixer outputs could be connected to the #2 TR1616 and then fed to the #4 TR1616 for feeding the amplifiers or loudspeaker management processor for the main PA speakers.
- System can be further expanded in the future if needed.

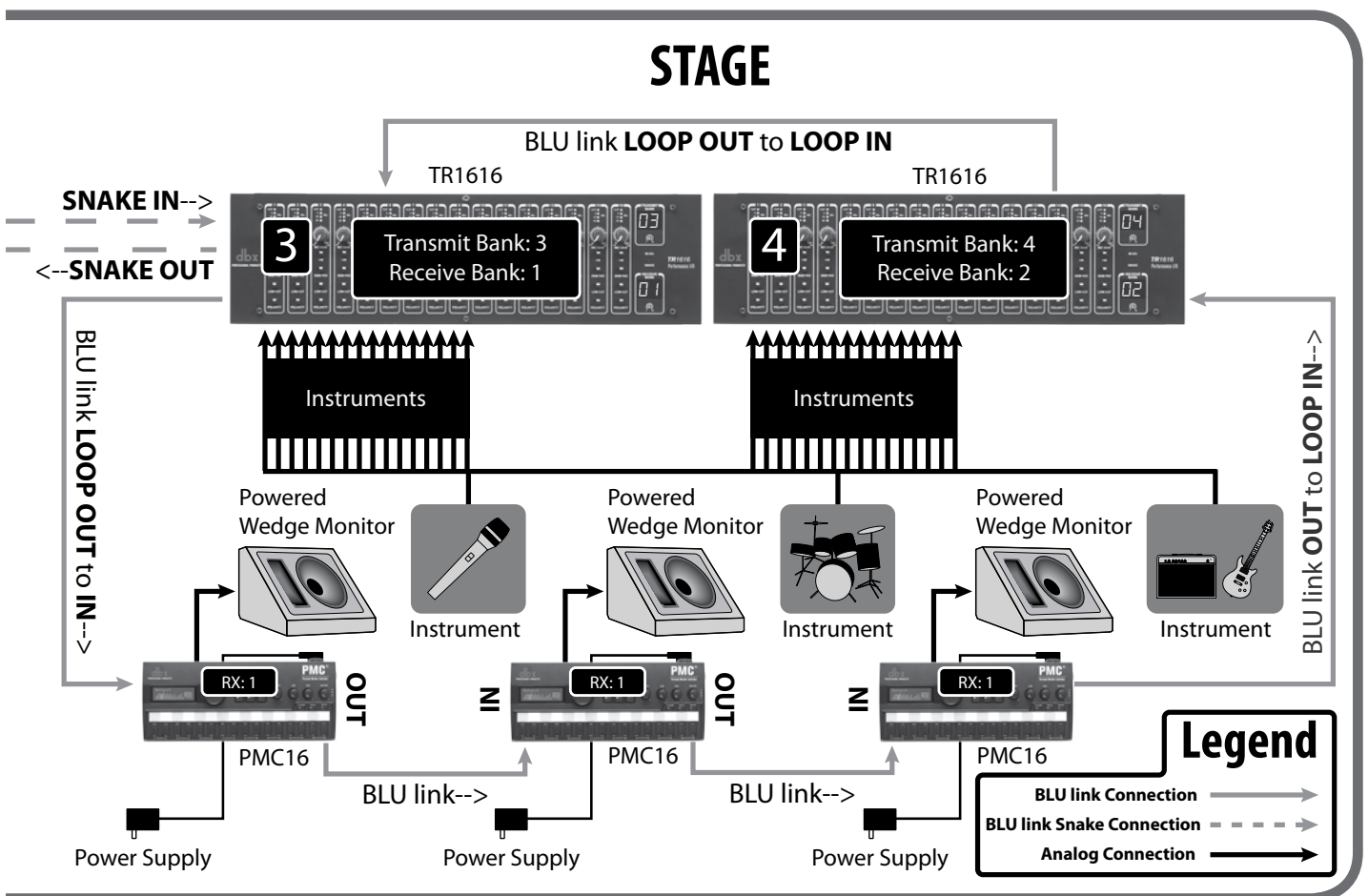

32 Channel BSS Soundweb London On-Ramp/Off-Ramp

Recommended for:

- Large Performance Venues
- Houses Of Worship
- Any BLU link Compatible BSS Audio Soundweb London System Requiring Additional Analog Inputs And/Or Outputs

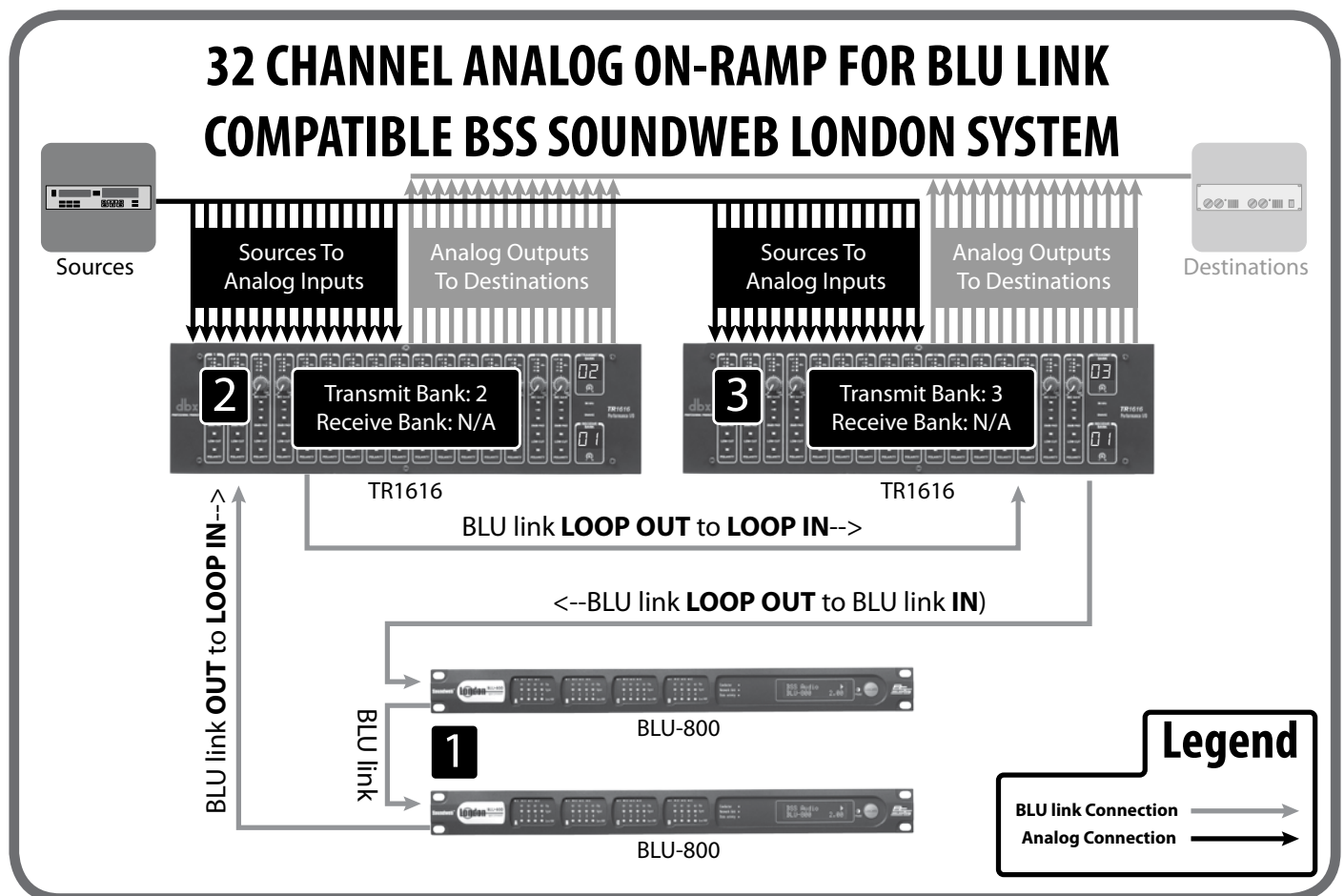

Key Points:

- Allows for easy analog audio connection to BSS Audio Soundweb London systems, due to the TR1616's combo (1/4" and XLR) inputs and XLR outputs, eliminating the need to make special Phoenix fitted cables.
- TR1616s can easily be added to pre-existing BLU link compatible Soundweb London systems with no additional hardware required.
- The two BSS BLU-800 processors (#1) occupy the first 16 channels of audio on the BLU link network. The #2 TR1616 occupies channels 17-32 (BANK 2) and the #3 TR1616 occupies channels 33-48 (BANK 3) on the network.
- These two system diagrams illustrate two separate systems: one is using two TR1616s for adding 32 channels of analog inputs to the BLU link network (on-ramp), the other is using two TR1616s for adding 32 channels of analog outputs to the BLU link network (off-ramp). However, the systems shown in these two diagrams can also be thought of as one system, providing both on-ramp and off-ramp functionality at the same time, as illustrated by the semi-transparent portions within each diagram.
- Systems can be further expanded in the future if needed.

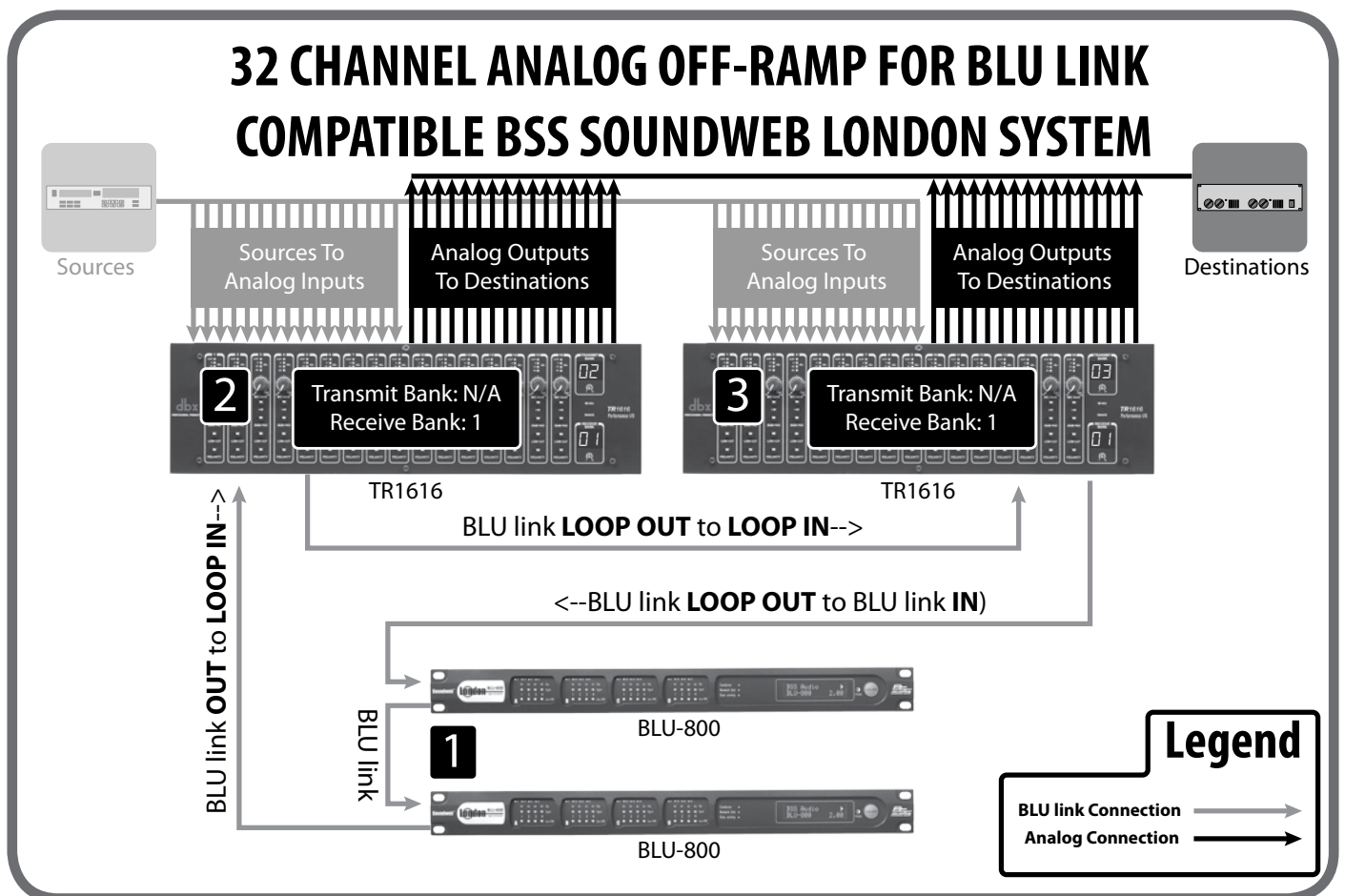

OPERATING INSTRUCTIONS

Setting BLU link Receive & Transmit Banks

To set the BLU link receive and transmit channel banks, use a small flat-head screwdriver or your fingernail to turn the slotted controls beneath the RECEIVE BANK & TRANSMIT BANK displays.

NOTE: Multiple TR1616s in a network can be assigned to the same RECEIVE BANK, if the application requires it. However, each TR1616 on the network must have its own unique TRANSMIT BANK selected. See “Applications” for examples of channel bank assignments.

BLU link supports 256 channels at 48 kHz and 128 channels at 96 kHz. The below table shows which range of channels are available within each BLU link channel bank and which channels are supported when operating at a 96 kHz sample rate.

TR1616 BLU link Bank/Channel Table		
Channel Bank	Channels Available In Bank	Supported Sample Rates
1	1-16	48 kHz/96 kHz
2	17-32	48 kHz/96 kHz
3	33-48	48 kHz/96 kHz
4	49-64	48 kHz/96 kHz
5	65-80	48 kHz/96 kHz
6	81-96	48 kHz/96 kHz
7	97-112	48 kHz/96 kHz
8	113-128	48 kHz/96 kHz
9	129-144	48 kHz
10	145-160	48 kHz
11	161-176	48 kHz
12	177-192	48 kHz
13	193-208	48 kHz
14	209-224	48 kHz
15	225-240	48 kHz
16	241-256	48 kHz

NOTE: Setting both the TRANSMIT BANK and RECEIVE BANK to the same channel allows signal pass-through of the analog inputs to the analog outputs. In certain applications this may be a desirable feature. For example, if you wanted to incorporate dbx PMC16 personal monitor controllers into your existing system using a traditional analog snake, it is possible to connect the analog snake to a single TR1616 at the front of house position (instead of straight to the mixing console). The TR1616 could then pass the analog signals out to the mixing console through the XLR outputs and out to the PMC16s on stage via BLU link.

BLU link Status Indicators

The dual 7-segment displays provide information about BLU link connections as described below.

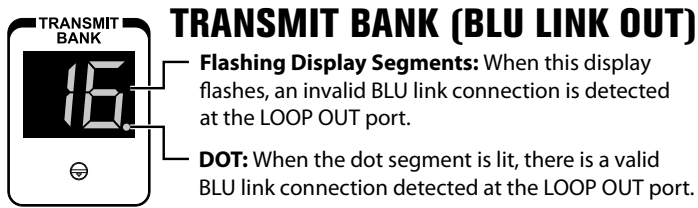

NOTE: The TRANSMIT BANK display indicates cable status for the LOOP OUT port, regardless of snake mode.

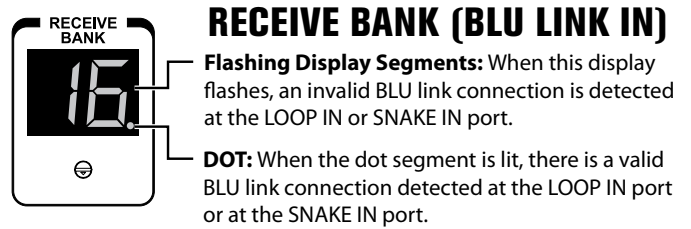

NOTE: The RECEIVE BANK display indicates cable status for the LOOP IN port when snake mode is disabled. When snake mode is enabled, the RECEIVE BANK display indicates cable status for the SNAKE IN port

Examples

- The TR1616 display will flash when an invalid BLU link connection is detected, such as when a BLU link IN is connected to another BLU link IN.
- The TRANSMIT BANK dot on the #1 TR1616 in the example set up on page 12 would not illuminate if there were no path connecting the #1 TR1616's LOOP OUT to LOOP IN.

The signal flow diagrams below show how BLU link signals are redirected depending on the Snake Enable switch position.

Snake Disabled

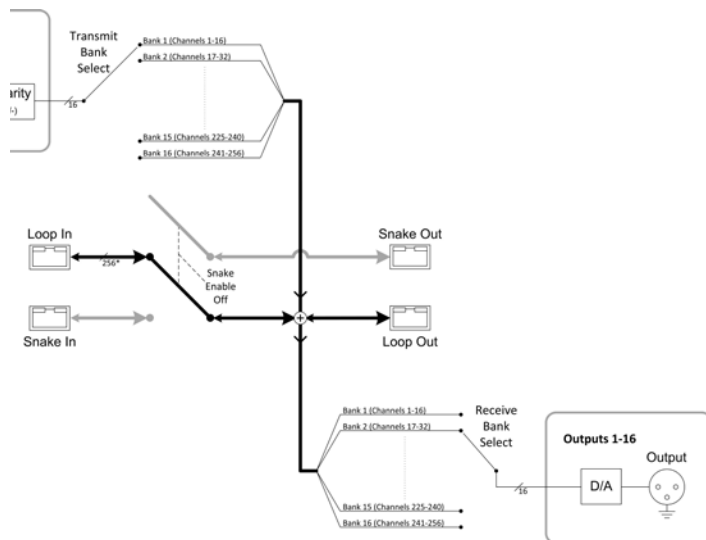

Snake Enabled

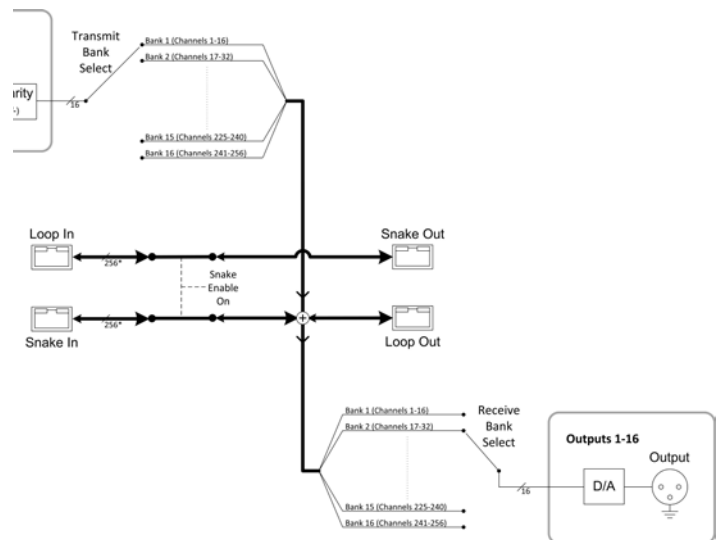

TR1616 Preamp Setup

1. Start with all **<MIC GAINS>** set to the full counterclockwise position and all front panel buttons disengaged (LEDs off).
2. Connect each instrument/source to the TR1616 using either the 1/4" input or XLR input for each channel.
3. Engage the **<+48>** buttons on any channels which require phantom power, such as active direct boxes and condenser microphones.

NOTE: All devices connected to the TR1616 which require phantom power must be connected using the XLR connections.

4. Engage the **<POLARITY>** buttons on any channels which require it, such as the bottom microphone of a top/bottom dual mic'ed snare pair.
5. With source signal present, adjust the first channel's **<MIC GAIN>** knob so that the -10 dBFS LED barely lights and the CLIP LED does not.
6. Repeat step 5 for each channel. If a source causes one of the TR1616's inputs to clip when the **<MIC GAIN>** knob is all the way down, engage the **<20dB PAD>** button for the channel and then complete step 5.

FIRMWARE UPDATES

The firmware in the TR1616 is updatable via the USB port. Available firmware updates can be downloaded from www.dbxpro.com. The Firmware Updater application for the TR1616 requires a Windows® PC.

To perform a firmware update:

1. Download the Firmware Updater application from www.dbxpro.com.
2. Follow the on-screen instructions to install the Firmware Updater application.
3. Launch the Firmware Updater application.
4. Follow the on-screen instructions to complete the firmware update procedure.

BLOCK DIAGRAM

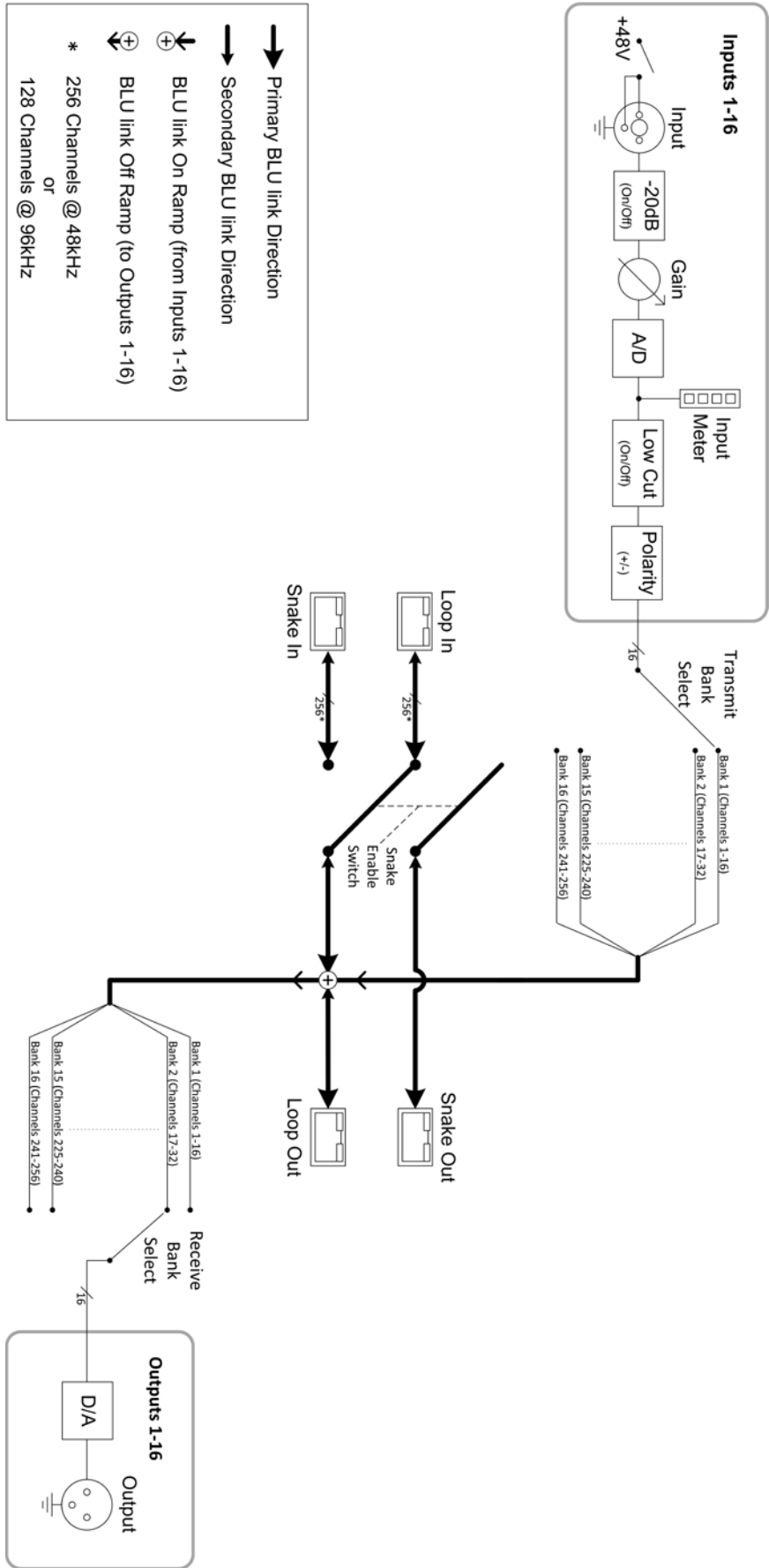

DIMENSIONS

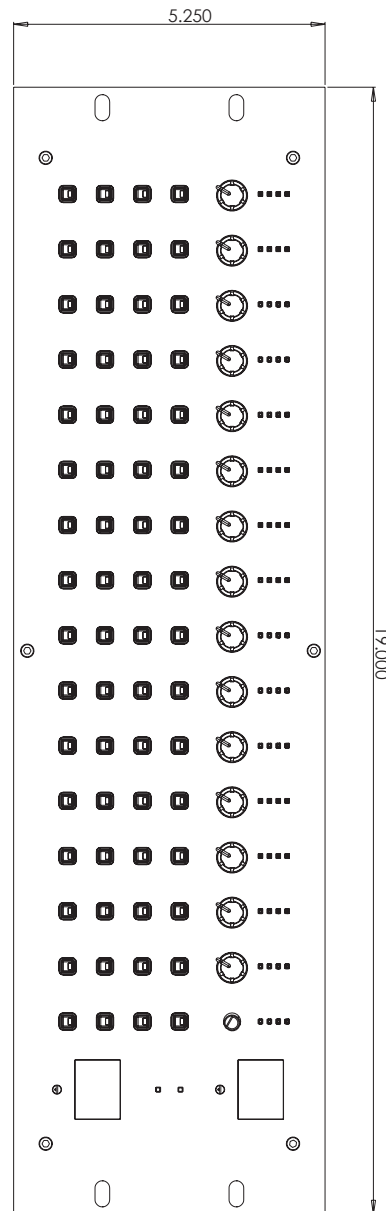
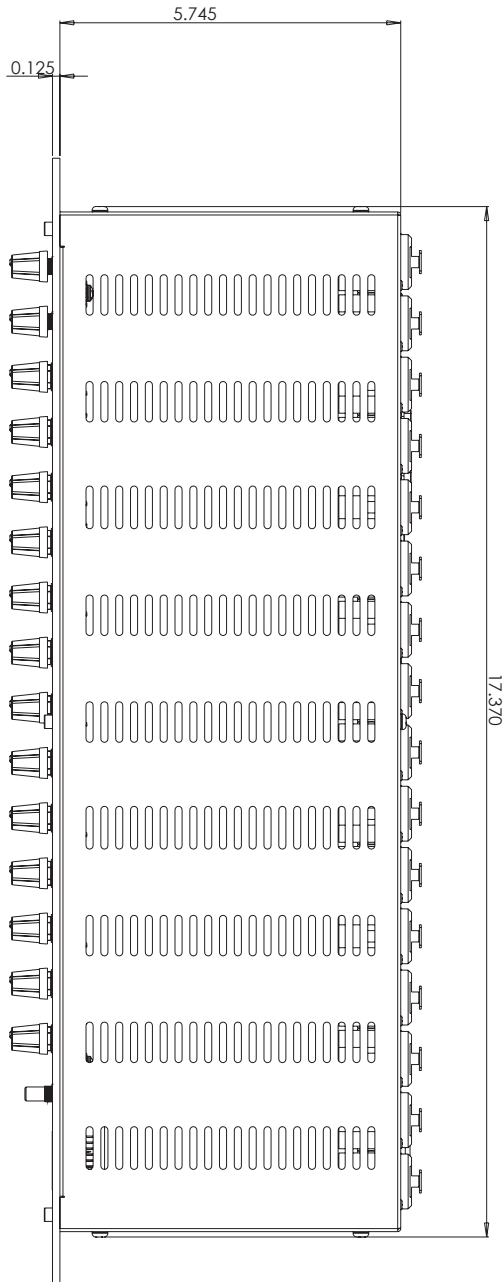
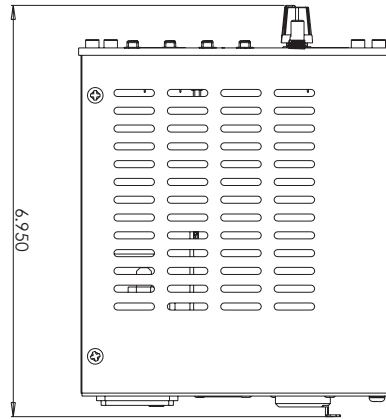

SPECIFICATIONS

ANALOG INPUTS

Number of Inputs:	16
Connectors:	Combination Female XLR and 1/4" Jack
Type:	Electronically balanced, RF Filtered
Impedance:	XLR input: 3k Ω , 1/4" input: 20k Ω balanced, 10k Ω unbalanced
Maximum Input Level:	XLR Input: +18dBu at minimum gain 1/4" Input: +33dBu at minimum gain
Gain:	XLR Input: 0 to +60dB 1/4" Input: -15 to +45dB
EIN:	-125dBu, 22Hz-22kHz, 150 Ω source impedance
CMRR:	>40dB, typically 55dB, 22Hz-22kHz
Dynamic Range:	110dB unweighted, 113dB A-weighted
Frequency Response:	10Hz to 40kHz, +/- 0.25dB at 96kHz 10Hz to 20kHz, +/- 0.25dB at 48kHz
THD+N:	Typically 0.002% at 1kHz, 0dBu XLR input, gain set to minimum
Interchannel Crosstalk:	<100dB, 22Hz to 22kHz
ADC Latency:	37/Fs (0.77msec at 48kHz)
Phantom Power:	+48VDC, applied to XLR pins 2 and 3 through 6.81k resistors
Pad:	20dB
Low Cut Filter:	2-pole Butterworth filter at 80Hz
Polarity:	Normal or Reverse

ANALOG OUTPUTS

Number of Outputs:	16
Connectors:	Male XLR
Type:	Cross-Coupled Electronically balanced, RF Filtered
Impedance:	40 Ω balanced, 20 Ω unbalanced
Maximum Output Level:	+20dBu into 2kohm load or greater
Dynamic Range:	112dB unweighted, 115dB A-weighted
Frequency Response:	10Hz to 40kHz, +/- 0.25dB at 96kHz 10Hz to 20kHz, +/- 0.25dB at 48kHz
THD+N:	Typically 0.006% at 1kHz, 0dBu output
Interchannel Crosstalk:	<-100dB, 22Hz to 22kHz
DAC Latency:	29/Fs (0.60msec at 48kHz)

SYSTEM

Sample Rate:	48kHz or 96kHz
Converter Wordlength:	24 bits
DSP Wordlength:	32 bit floating point

FRONT PANEL INDICATORS

LED Meter:	Clip (-3dBFS), -10dBFS, -20dBFS, -50dBFS (dBFS = dB Full Scale)
96kHz:	Illuminated for 96kHz, off for 48 kHz
Snake:	Illuminated for Snake function

BLU-LINK AUDIO NETWORK

Connectors:	2x Ethercon lockable RJ45 Ethernet connectors
Maximum Cable Length:	100m/328ft on Category 5e cable between devices
Maximum number of nodes:	60
Maximum number of channels:	256 at 48kHz, 128 at 96kHz
Latency:	11/Fs (0.23msec at 48kHz)
Pass Through Latency:	4/Fs (0.08msec at 48kHz)

USB PORT

Connector:	Mini-B
-------------------	--------

ETHERNET

Connector:	RJ45
Maximum Cable Length:	100m/328ft on Category 5e cable between devices

POWER AND DIMENSIONS

Power Requirements:	100VAC-240VAC, 50/60Hz, 55 watts
Fuse:	1.6A 250V Timelag Hi Brk
Rack Unit:	3U
Dimensions:	5.25" (H) x 19" (W) x 6.25" (D) 133.4 mm (H) x 482.6 mm (W) x 158.8 mm (D)
Weight:	9.6 lb (4.4 kg)
Shipping Weight:	11.3 lb (5.1 kg)



**8760 South Sandy Parkway
Sandy, Utah 84070
PH (801) 566-8800
FAX (801) 566-7005
<http://www.dbxpro.com>**

**dbx® is a registered trademark
of Harman**

Copyright - Harman

**TR1616 Owner's Manual 5024729-A
Printed in USA**