

dbx[®]
by HARMAN

DriveRack[®] PA+

Complete Equalization & Loudspeaker Control System



Featuring



CROWN

Custom Tunings

User Manual

Professional Audio Equipment

IMPORTANT SAFETY INFORMATION

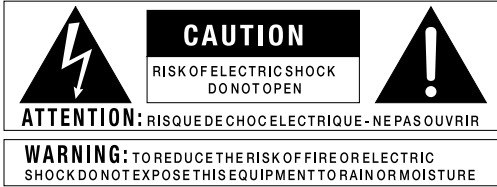

The symbols shown above are internationally accepted symbols that warn of potential hazards with electrical products. The lightning flash with arrowpoint in an equilateral triangle means that there are dangerous voltages present within the unit. The exclamation point in an equilateral triangle indicates that it is necessary for the user to refer to the owner's manual.

These symbols warn that there are no user serviceable parts inside the unit. Do not open the unit. Do not attempt to service the unit yourself. Refer all servicing to qualified personnel. Opening the chassis for any reason will void the manufacturer's warranty. Do not get the unit wet. If liquid is spilled on the unit, shut it off immediately and take it to a dealer for service. Disconnect the unit during storms to prevent damage.

SAFETY INSTRUCTIONS

NOTICE FOR CUSTOMERS IF YOUR UNIT IS EQUIPPED WITH A POWER CORD.

WARNING: THIS APPLIANCE SHALL BE CONNECTED TO A MAINS SOCKET OUTLET WITH A PROTECTIVE EARTHING CONNECTION.

The cores in the mains lead are coloured in accordance with the following code:

GREEN and YELLOW - Earth BLUE - Neutral BROWN - Live

As colours of the cores in the mains lead of this appliance may not correspond with the coloured markings identifying the terminals in your plug, proceed as follows:

- The core which is coloured green and yellow must be connected to the terminal in the plug marked with the letter E, or with the earth symbol, or coloured green, or green and yellow.
- The core which is coloured blue must be connected to the terminal marked N or coloured black.
- The core which is coloured brown must be connected to the terminal marked L or coloured red.

This equipment may require the use of a different line cord, attachment plug, or both, depending on the available power source at installation. If the attachment plug needs to be changed, refer servicing to qualified service personnel who should refer to the table below. The green/yellow wire shall be connected directly to the units chassis.

CONDUCTOR		WIRE COLOR	
		Normal	Alt
L	LIVE	BROWN	BLACK
N	NEUTRAL	BLUE	WHITE
E	EARTH GND	GREEN/ YEL	GREEN

WARNING: If the ground is defeated, certain fault conditions in the unit or in the system to which it is connected can result in full line voltage between chassis and earth ground. Severe injury or death can then result if the chassis and earth ground are touched simultaneously.

WARNING FOR YOUR PROTECTION READ THE FOLLOWING:

KEEP THESE INSTRUCTIONS

HEED ALL WARNINGS

FOLLOW ALL INSTRUCTIONS

THE APPARATUS SHALL NOT BE EXPOSED TO DRIPPING OR SPLASHING LIQUID AND NO OBJECT FILLED WITH LIQUID, SUCH AS VASES, SHALL BE PLACED ON THE APPARATUS.

CLEAN ONLY WITH A DRY CLOTH.

DO NOT BLOCK ANY OF THE VENTILATION OPENINGS. INSTALL IN ACCORDANCE WITH THE MANUFACTURER'S INSTRUCTIONS.

DO NOT INSTALL NEAR ANY HEAT SOURCES SUCH AS RADIATORS, HEAT REGISTERS, STOVES, OR OTHER APPARATUS (INCLUDING AMPLIFIERS) THAT PRODUCE HEAT.

ONLY USE ATTACHMENTS/ACCESSORIES SPECIFIED BY THE MANUFACTURER.

UNPLUG THIS APPARATUS DURING LIGHTNING STORMS OR WHEN UNUSED FOR LONG PERIODS OF TIME.

Do not defeat the safety purpose of the polarized or grounding-type plug. A polarized plug has two blades with one wider than the other. A grounding type plug has two blades and a third grounding prong. The wide blade or third prong are provided for your safety. If the provided plug does not fit your outlet, consult an electrician for replacement of the obsolete outlet.

Protect the power cord from being walked on or pinched particularly at plugs, convenience receptacles, and the point where they exit from the apparatus.

Use only with the cart stand, tripod bracket, or table specified by the manufacturer, or sold with the apparatus. When a cart is used, use caution when moving the cart/apparatus combination to avoid injury from tip-over.



Refer all servicing to qualified service personnel. Servicing is required when the apparatus has been damaged in any way, such as power-supply cord or plug is damaged, liquid has been spilled or objects have fallen into the apparatus, the apparatus has been exposed to rain or moisture, does not operate normally, or has been dropped.

POWER ON/OFF SWITCH: If the equipment has a Power switch, the Power switch used in this piece of equipment DOES NOT break the connection from the mains.

MAINS DISCONNECT: The plug shall remain readily operable. For rack-mount or installation where plug is not accessible, an all-pole mains switch with a contact separation of at least 3 mm in each pole shall be incorporated into the electrical installation of the rack or building.

FOR UNITS EQUIPPED WITH EXTERNALLY ACCESSIBLE FUSE RECEPTACLE: Replace fuse with same type and rating only.

MULTIPLE-INPUT VOLTAGE: This equipment may require the use of a different line cord, attachment plug, or both, depending on the available power source at installation. Connect this equipment only to the power source indicated on the equipment rear panel. To reduce the risk of fire or electric shock, refer servicing to qualified service personnel or equivalent.

If connected to 240V supply, a suitable CSA/UL certified power cord shall be used for this supply.

IMPORTANT SAFETY INFORMATION

ELECTROMAGNETIC COMPATIBILITY

This device complies with part 15 of the FCC Rules and the Product Specifications noted on the **Declaration of Conformity**. Operation is subject to the following two conditions:

- this device may not cause harmful interference, and
- this device must accept any interference received, including interference that may cause undesired operation.

Operation of this unit within significant electromagnetic fields should be avoided.

- use only shielded interconnecting cables.

U.K. MAINS PLUG WARNING

A molded mains plug that has been cut off from the cord is unsafe. Discard the mains plug at a suitable disposal facility.

NEVER UNDER ANY CIRCUMSTANCES SHOULD YOU INSERT A DAMAGED OR CUT MAINS PLUG INTO A 13 AMP POWER SOCKET.

Do not use the mains plug without the fuse cover in place.

Replacement fuse covers can be obtained from your local retailer.

Replacement fuses are 13 amps and **MUST** be ASTA approved to BS1362.



If you want to dispose this product, do not mix it with general household waste. There is a separate collection system for used electronic products in accordance with legislation that requires proper treatment, recovery and recycling.

Private household in the 25 member states of the EU, in Switzerland and Norway may return their used electronic products free of charge to designated collection facilities or to a retailer (if you purchase a similar new one).

For Countries not mentioned above, please contact your local authorities for a correct method of disposal.

By doing so you will ensure that your disposed product undergoes the necessary treatment, recovery and recycling and thus prevent potential negative effects on the environment and human health.

DECLARATION OF CONFORMITY

Manufacturer's Name: dbx Professional Products
Manufacturer's Address: 8760 S. Sandy Parkway
Sandy, Utah 84070, USA

declares that the product:

Product name: dbx DriveRack PA +
Note: Product name may be suffixed by the EU.

Product option: None

conforms to the following Product Specifications:

Safety: IEC 60065 -01+Amd 1

EMC: EN 55022:2006
EN 55024:1998
FCC Part 15

Supplementary Information:

The product herewith complies with the requirements of the:
Low Voltage Directive 2006/95/EC
EMC Directive 2004/108/EC.
RoHS Directive 2002/95/EC
WEEE Directive 2002/96/EC

With regard to Directive 2005/32/EC and EC Regulation 1275/2008 of 17 December 2008, this product is designed, produced, and classified as Professional Audio Equipment and thus is exempt from this Directive.

Vice President of Engineering
8760 S. Sandy Parkway
Sandy, Utah 84070, USA
Date: March 19, 2010

European Contact: Your local dbx Sales and Service Office or

Harman Music Group
8760 South Sandy Parkway
Sandy, Utah 84070, USA
Ph: (801) 566-8800
Fax: (801) 568-7583

Section 1- Introduction	1	Section A - Appendix.....	28
1.1 Defining the DriveRack PA+.....	1	A.1 Factory Reset.....	28
1.2 Service Contact Info.....	2	A.2 DriveRack PA+ Power-Up Button Functions	28
1.3 Warranty.....	3	A.3 Power Up Quick Key Options.....	28
Section 2- Getting Started	4	A.4 Update Firmware	29
2.1 Rear Panel Connections	4	A.5 Preset List/Speaker Tunings	29
2.2 Front Panel Connections	5	A.6 Specifications	30
2.3 Installation Steps	6	A.7 AUTO-EQ Optimization Tips	31
2.4 Quick Start	6	A.8 Block Diagram.....	32
Section 3 - Editing Functions	8	A.9 System Setup and Gain Structure	33
3.1 Basic Navigation Modes	8		
3.2 Button Array Overview.....	8		
3.3 Navigating the EQ Section	10		
3.4 Navigating the Subharmonic Section	10		
3.5 Navigating the Crossover Section	11		
3.6 Navigating the AFS (Advanced Feedback Suppression) Section.....	11		
3.7 Navigating the Comp/Limiter Section	12		
3.8 Navigating the Delay Section.....	12		
3.9 Navigating the Utility Section	13		
3.10 Navigating the Wizard Section	13		
Section 4 - Operating Functions.....	14		
4.1 Preset Definition	14		
4.2 Navigating Factory Presets	14		
4.3 Editing Factory Presets	15		
4.4 Saving Presets.....	15		
Section 5 - Detailed Parameters.....	17		
5.1 Graphic EQ.....	17		
5.2 Advanced Feedback Suppression.....	17		
5.3 Subharmonic Synthesizer	19		
5.4 Crossover.....	20		
5.5 Output Parametric EQ (PEQ)	20		
5.6 Compressor/Limiter	21		
5.7 Alignment Delay	22		
Section 6 - Application Guide	24		
6.1 Stereo 3-Way.....	24		
6.2 Stereo 3-Way with Mono Sub.....	25		
6.3 Stereo 2-Way.....	26		
6.4 Stereo 2-Way with Mono Sub.....	27		

Section 1- Introduction

Drive your PA to a whole new level of performance with the DriveRack PA+ Complete Equalization & Loudspeaker Management System. The DriveRack PA+ from dbx Professional Products represents a complete integration of the key elements that help ensure optimal loudspeaker system management in PA-specific applications. Capitalizing on the legendary dbx® DriveRack technology, the DriveRack PA+ is able to provide its user with top-tier, pro-level loudspeaker management specifications, yet still remain appealing to the budget-conscious audiophile who requires a tried and true utilitarian workhorse. With its all-inclusive, no-compromise design, the DriveRack PA+ has been systematically developed and designed to grow with your system needs for years to come.

1.1 Defining the DriveRack PA+

The dbx DriveRack PA+ is the most effective way to manage all aspects of Loudspeaker management for Public Address system applications. The DriveRack PA+ essentially becomes the only device that you will need between your mixer and your power amps. The following are just some of the features of the DriveRack PA+.

DriveRack PA+ features:

- Setup Wizard Steps Through Speaker and Amp Selection and Levels
- Auto Level™ Wizard Balances Your System
- Auto EQ™ Wizard with 28-Band RTA Tunes Your System For The Venue
- AFS® Wizard Helps Eliminate Feedback
- Stereo Feedback Elimination with 12 feedback notch filters
- dbx 120A Sub-harmonic Synthesizer
- Classic dbx Input Compression
- JBL® Speaker and Crown® Power Amp Tunings included
- USB Firmware and Speaker Tunings Field Updatable With Harman HiQnet™ System Architect
- Full time RTA function
- Front-Panel Output Mutes
- Pink Noise Generator (used with Auto EQ and Auto Level Wizards)
- Linked Stereo DSP Processing for ease of use
- 24-Bit ADC/24-Bit DAC, >113 dB Dynamic Range
- 2-Channel XLR Input and 6-Channel XLR Output
- 2x2, 2x3, 2x4, 2x5, 2x6 Crossover Configurations
- Dual 28-band Graphic EQ- Linked or Dual Mono
- Stereo Multi-band Parametric EQ
- Stereo Output Limiters
- Output Alignment Delay
- Power on/off Mute Circuitry
- Front-panel RTA-M XLR input with phantom power
- 25 User Programs/25 Factory Programs
- Full Graphic LCD Display
- Front Panel Input and Output Meters

By including every form of processing necessary to drive the signal from the mixer to the power amp, the DriveRack PA+ allows you to eliminate all other processing devices normally found in large and cumbersome traditional Front of House rack systems of the past.

The DriveRack PA+ Loudspeaker Management System includes two balanced XLR inputs, as well as six balanced XLR output connectors.

1.2 Service Contact Info

If you require technical support, contact dbx Technical Support. Be prepared to accurately describe the problem. Know the serial number of your device - this is printed on a sticker attached to the chassis. If you have not already taken the time to fill out your warranty registration card and send it in, please do so now. You may also register online at www.dbxpro.com.

Before you return a product to the factory for service, we recommend you refer to the manual. Make sure you have correctly followed installation steps and operation procedures. For further technical assistance or service, please contact our Technical Support Department at (801) 568-7660 or visit www.dbxpro.com. If you need to return a product to the factory for service, you **MUST** first contact Technical Support to obtain a Return Authorization Number.

No returned products will be accepted at the factory without a Return Authorization Number.

Please refer to the Warranty information on the following page, which extends to the first end-user. After expiration of the warranty, a reasonable charge will be made for parts, labor, and packing if you choose to use the factory service facility. In all cases, you are responsible for transportation charges to the factory. dbx will pay return shipping if the unit is still under warranty.

Use the original packing material if it is available. Mark the package with the name of the shipper and with these words in red: DELICATE INSTRUMENT, FRAGILE! Also write the Return Authorization Number (RA#) on the outside of the box in a conspicuous location. Insure the package properly. Ship prepaid, not collect. Do not ship parcel post.

1.3 Warranty

This warranty is valid only for the original purchaser and only in the United States.

1. The warranty registration card that accompanies this product must be mailed within 30 days after purchase date to validate this warranty. You can also register online at www.dbxpro.com. Proof-of-purchase is considered to be the responsibility of the consumer. **A copy of the original purchase receipt must be provided for any warranty service.**
2. dbx warrants this product, when bought and used solely within the U.S., to be free from defects in materials and workmanship under normal use and service.
3. dbx liability under this warranty is limited to repairing or, at our discretion, replacing defective materials that show evidence of defect, provided the product is returned to dbx WITH RETURN AUTHORIZATION from the factory, where all parts and labor will be covered up to a period of two years. A Return Authorization number must first be obtained from dbx. The company shall not be liable for any consequential damage as a result of the product's use in any circuit or assembly.
4. dbx reserves the right to make changes in design or make additions to or improvements upon this product without incurring any obligation to install the same additions or improvements on products previously manufactured.
5. The foregoing is in lieu of all other warranties, expressed or implied, and dbx neither assumes nor authorizes any person to assume on its behalf any obligation or liability in connection with the sale of this product. In no event shall dbx or its dealers be liable for special or consequential damages or from any delay in the performance of this warranty due to causes beyond their control.

Section 2- Getting Started

2.1 Rear Panel Connections

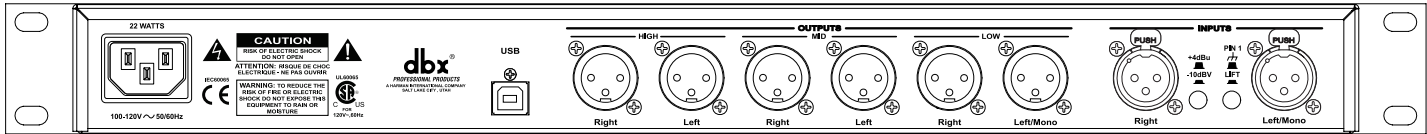

IEC Power Cord Receptacle

The DriveRack PA+ comes with a power supply that will accept voltages ranging from 100V-120V at frequencies from 50Hz-60Hz. An IEC cord is included. EU version accepts 220V-240V at frequencies from 50Hz-60Hz.

USB Connection

The USB connector allows users to connect the DriveRack PA+ to their computer to perform firmware updates using HiQnet System Architect Software via System Architects Firmware Updater. You may download HiQnet System Architect at the HiQnet Web site: <http://hiqnet.harmanpro.com/downloads.php>

Outputs 1-6

The output section of the DriveRack PA+ offers six electronically balanced XLR connectors.

Inputs 1-2

The input section of the DriveRack PA+ offers two electronically balanced XLR connectors.

+4/-10dBv Switch

This switch changes the level from either +4 or -10dBv.

Ground Lift Switch

The ground lift switch lifts the pin 1 chassis ground of both input XLR connectors.

2.2 Front Panel Connections

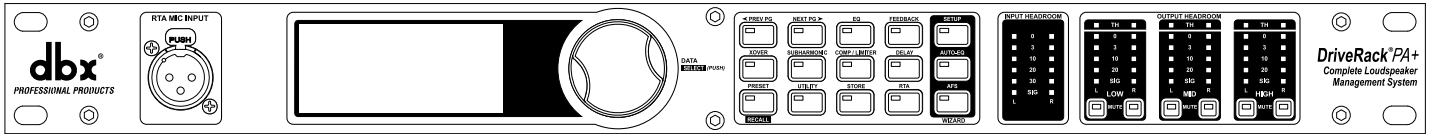

RTA MIC Input

This balanced XLR input is used for the connection of an RTA microphone. This allows the PA+ to measure pink noise that is sent through the speakers. The Auto-EQ Wizard can then optimize the EQ settings for any room. You can also use the full-time RTA feature to monitor levels and make adjustments yourself.

Data Wheel

The Data Wheel of the DriveRack PA+ is used to scroll through the preset menu, load presets, select parameters and edit parameter values.

LCD Display

The backlit LCD display of the DriveRack PA+ provides the user with all of the vital processing information for the DriveRack PA+ including: signal routing, effect block editing and Wizard functions. The display will also notify the user if any internal clipping is taking place within the unit. The following message will appear: CLIP.

Function Buttons

The function button array of the DriveRack PA+ allows direct access to all editing and navigating functions.

Input Headroom Meters

The DriveRack PA+ provides the user with two independent six-segment input headroom meters that range from Signal Present to 0 dBFS (maximum input). These meters monitor the signal level right after the input module.

Output Headroom Meters

The DriveRack PA+ provides the user with six independent five-segment output headroom meters that range from Signal Present to 0 dBFS (maximum output).

Threshold Meters

The three color threshold meters indicate that the threshold level has been exceeded within the Limiter section, and gain reduction may be taking place within the specific output channel. Green is under threshold, Yellow is at threshold and Red is over threshold.

Output Mute Buttons

Each output channel of the DriveRack PA+ contains a Mute button.

2.3 Installation Steps

Make sure that the power outlet that your DriveRack® PA+ is to be plugged into is correct and appropriate for the unit you purchased.

Using the mounting screws provided, screw the DriveRack PA+ into an appropriate rack. Make sure that there is proper ventilation. The sides and back of the device should be free of any obstruction that would prevent airflow.

Using the appropriate plug provided, plug the unit into an electrical outlet.

Fill out and send in the warranty card included or register online at www.dbxpro.com. **Please keep your purchase receipt as final proof of purchase.**

Connect the output of your console or other line level device to the inputs of the DriveRack PA+ and the desired outputs of the DriveRack PA+ to the inputs of the selected amplifier. Configure the DriveRack PA+ for your sound system using the dbx Wizard buttons and the Quick Start below or with the use of the separate Quick Start Guide included in the box.

2.4 Quick Start

For those of you that wish to jump right in, the following information has been provided to act as a quick start for optimizing performance of the DriveRack PA+.

Signal Path Block Diagram

The following diagram shows the logical and intuitive signal path of the input, effects, and output of the DriveRack PA+.

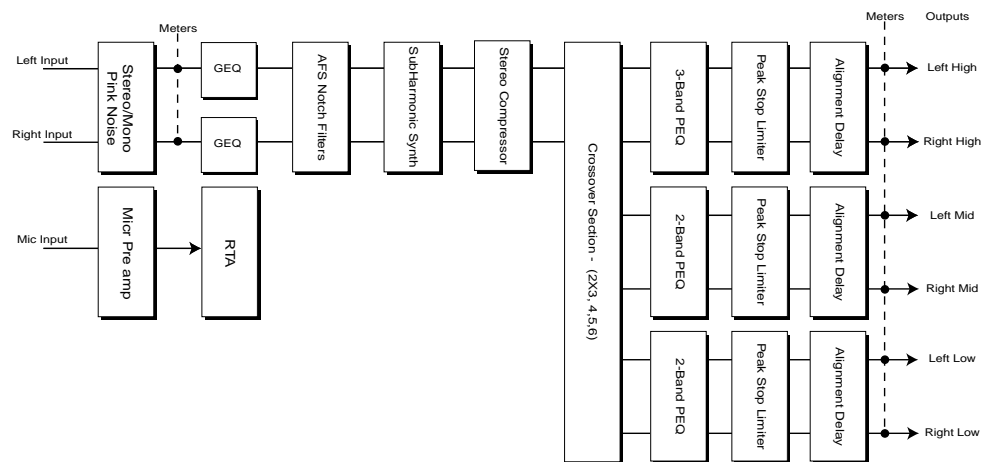

Connections

When setting up the DriveRack PA+, make connections as follows:

- Always make connections prior to applying power to the unit.
- Connect the output from the sending device (mixer) to either of the two XLR Input connectors shown below. (Left to left and right to right is recommended)

- Make output connections from the six output XLR connectors on the back panel to the input of the selected power amplifiers. (Low out to low amp, mid out to mid amp and high out to high amp as needed)
- If you will be “pinking” (Auto-EQing) the room through the use of the pink noise generator, RTA microphone and the Auto-EQ Wizard, connect the RTA microphone to the front-panel XLR input.
- **IMPORTANT-** It is essential that the power amps are turned off prior to cycling power to the DriveRack® PA+. It is standard practice to make sure that your power amps are the last item turned on and the first turned off.

Once all of the connections have been made and the unit is powered up, you can navigate through the entire signal path of the DriveRack PA+ from the front panel of the unit. The display provides you with a clear and concise overview of each aspect of the signal path from the input to the output section.









Section 3 - Editing Functions

3.1 Basic Navigation Modes

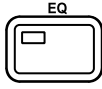
The DriveRack PA+ has been carefully designed and engineered to ensure that all aspects of operation are intuitive and logical. Simply stated, the DriveRack PA+ operating system was designed with the user's best interest in mind.

Navigational aspects of the DriveRack PA+ are clear, concise and more important they are flexible. The DriveRack PA+ provides you with essentially three different modes of navigation when performing preset edits.

3.2 Button Array Overview

	PREVIOUS PAGE - Used to navigate back through the various pages of any effect or WIZARD.
	NEXT PAGE - Used to navigate forward through the various pages of any effect or WIZARD.
	EQ - Used to move to the EQ modules. Successive presses will move you through the EQ modules in the input section and through EQ modules located in the output section.
	FEEDBACK - Used to move to the Automatic Feedback Suppression module.
	XOVER - Used to move to the Crossover module.
	SUBHARMONIC - Used to move to the Subharmonic Synthesizer module.
	COMP/LIMITER - Used to move to the Input Compressor or Output Limiter modules. Successive presses will move you through the Input Compressor and Output Limiter modules.
	DELAY - Used to move to the Delay modules.
	PRESET/RECALL - Press to view the currently loaded preset. Press and hold to scroll through presets, where you can press the Data Wheel to load a new preset or press the PRESET/RECALL button to cancel and return to the currently loaded preset.

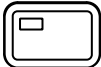
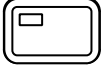
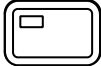
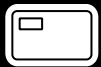
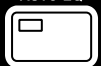
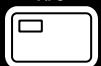
	UTILITY - Used to access the Utility menu.
	STORE - Used to store any preset changes.
	RTA - Press to access the full time RTA module, where you can monitor frequency levels. This information can help experienced users make fine-tune adjustments.
	SETUP - Press and hold to enter the first page of the SYSTEM SETUP WIZARD.
	AUTO-EQ - Press and hold to enter the Auto-EQ Wizard. This Wizard allows the user to automatically tune the speakers to the current room environment with the use of the dbx RTA measurement microphone.
	AFS® - Press and hold to enter the first page of the AFS Wizard.

3.3 Navigating the EQ Section

To edit the parameters of the EQs used in a selected preset, simply use the following procedure. From preset mode, press the EQ button to reach the EQ module to be edited. Successive presses of the EQ button toggle between the input and the output EQ. Navigate through the Pages of the selected EQ section by depressing "Next Page" or "Prev Page" successively until arriving at the desired Page.

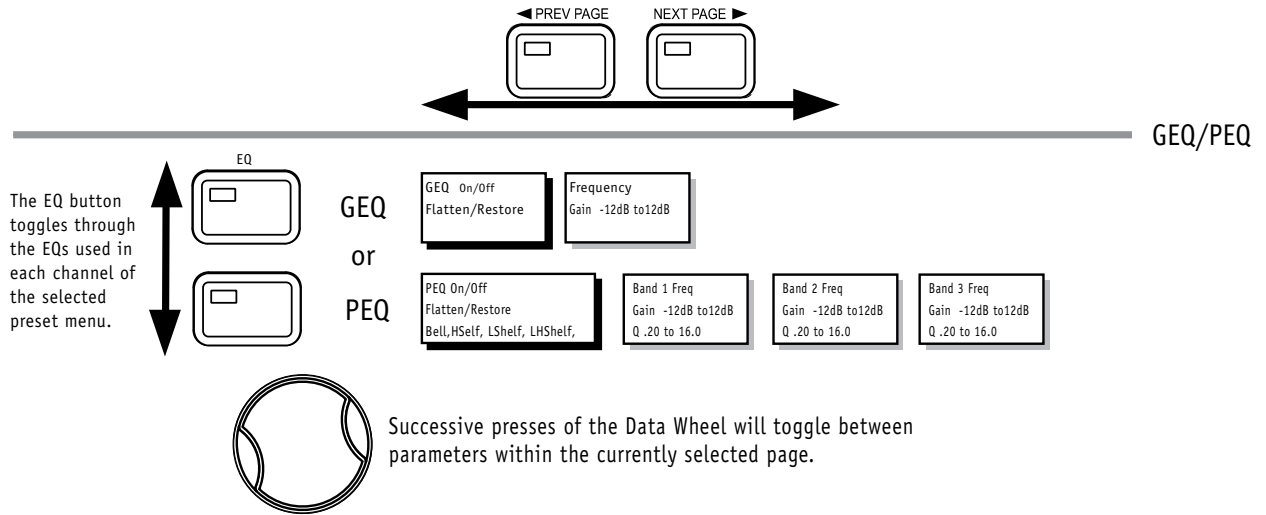

3.4 Navigating the Subharmonic Section

From preset mode, press the SUBHARMONIC button. Pressing the Data Wheel will select the parameter to be edited.

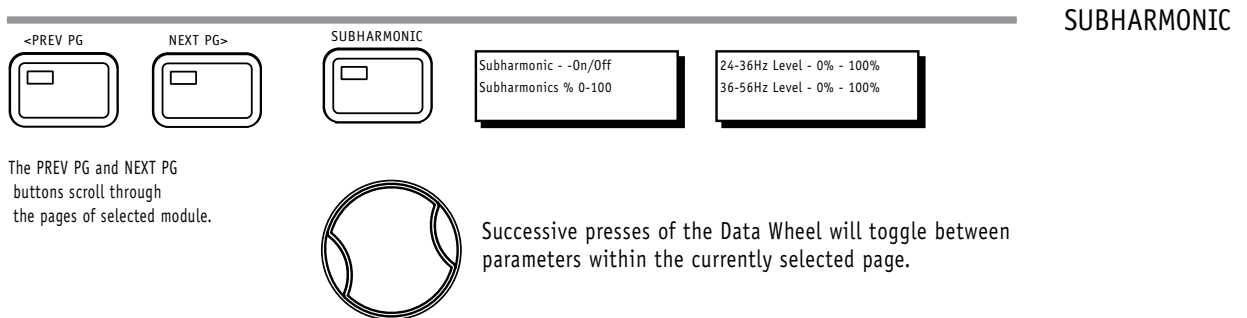

3.5 Navigating the Crossover Section

To edit the parameters of the Crossover used in a selected preset, simply use the following procedure. From preset mode, press the XOVER button. Once you have reached the Crossover module, Navigate through the Pages of the selected Crossover module by pressing the "Next Page" or "Prev Page" buttons successively until arriving at the desired Page.

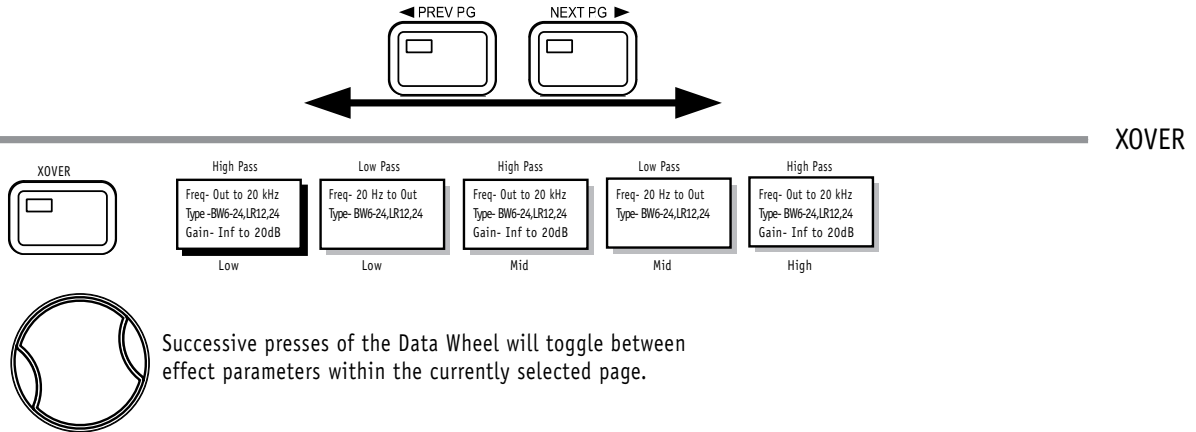

3.6 Navigating the AFS (Advanced Feedback Suppression) Section

From preset mode, press the FEEDBACK button. Pressing the Data Wheel will select the parameter to be edited.

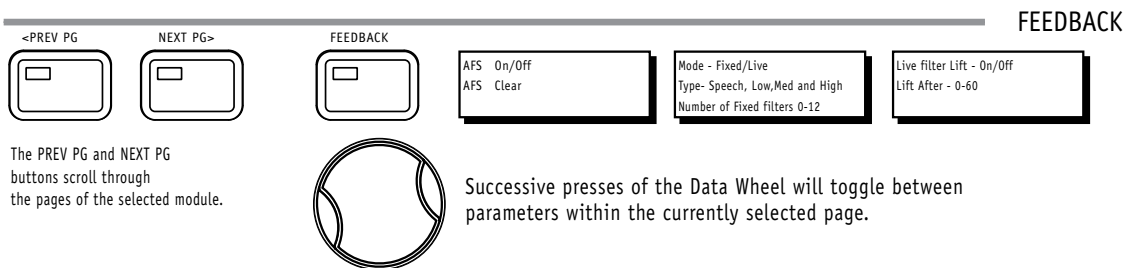

3.7 Navigating the Comp/Limiter Section

From preset mode, press the COMP/LIMITER button to move to either the Compressor or Limiter module(s). Successive presses of the COMP/LIMITER button will toggle between the input and output modules. Navigate through the Pages of the Compressor module by pressing the "Next Page" or "Prev Page" buttons successively until you arrive at the desired Page.

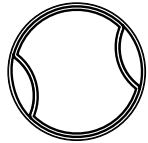
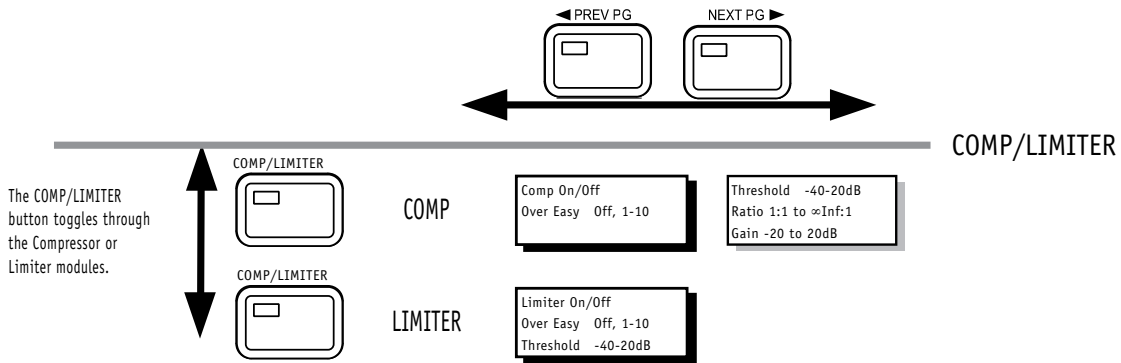

Successive presses of the Data Wheel will toggle between effect parameters within the currently selected page.

3.8 Navigating the Delay Section

From preset mode, press the Delay button. Pressing the Data Wheel will select the effect parameter to be edited.

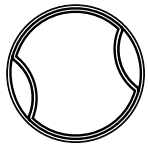
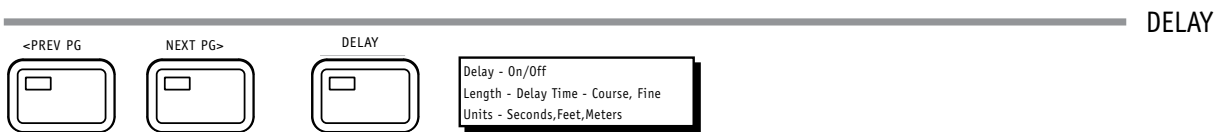

Successive presses of the Data Wheel will toggle between effect parameters within the currently selected page.

3.9 Navigating the Utility Section

From preset mode, press and hold the UTILITY button. Pressing the Data Wheel will select the parameter to be edited.

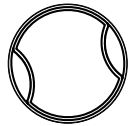
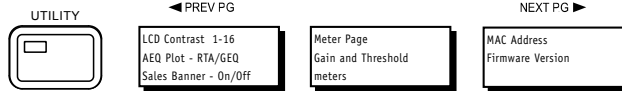

Successive presses of the Data Wheel will toggle between parameters within the currently selected page.

3.10 Navigating the Wizard Section

From preset mode, press and hold one of the WIZARD buttons (SETUP, AUTO-EQ, or AFS).

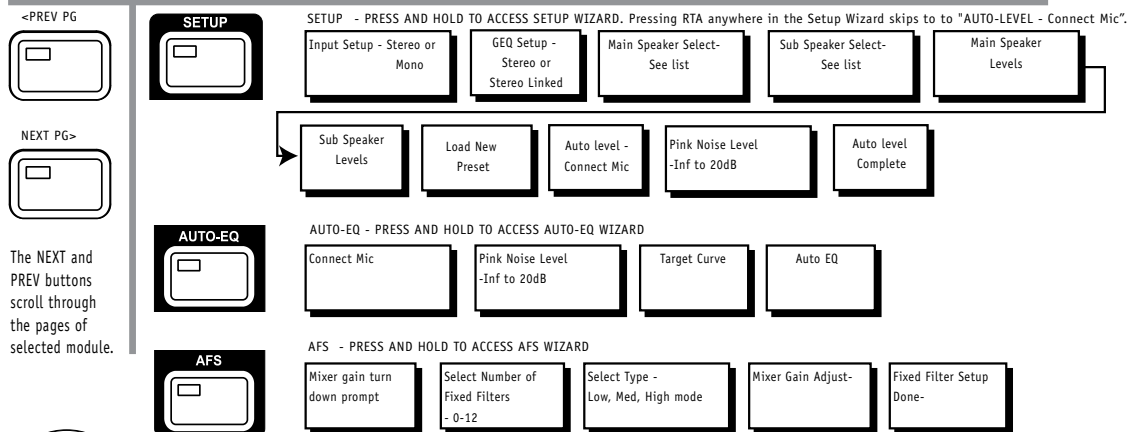

The NEXT and PREV buttons scroll through the pages of selected module.

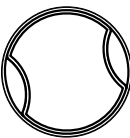

Successive presses of the Data Wheel will toggle between parameters within the currently selected page.

Section 4 - Operating Functions

The Operation section of the DriveRack® PA+ will be your key to successful navigation. The following information provides descriptions about preset functions and operating functions of the DriveRack PA+.

4.1 Preset Definition

The first step in understanding the thorough preset capabilities of the DriveRack PA+ is to understand the elements involved, that when combined, define a complete “preset.” Within an individual preset, there are several levels of editing that make up the complete preset. After turning the unit on, you will be at the “preset” mode level. This level supplies the user with current preset information such as: current signal path, effect usage, and preset name. From this point, the DriveRack PA+ gives you the option of entering subsequent levels of operation that are dedicated to preset editing. The Utility menu mode is accessed via the UTILITY button, and is not part of a single preset.

4.2 Navigating Factory Presets

From the factory, the DriveRack PA+ is shipped with 25 factory presets that utilize carefully constructed routing configurations that have been designed to accommodate virtually any sound reinforcement application. The factory presets offer a clear and concise explanatory title to help get you up and running in a timely manner. These presets can also be used as templates or starting points for the user to create custom presets.

Selecting Presets:

The quickest way to get up and running with the DriveRack PA+ is to use one of the factory presets that are available in the box. To select a preset, press and hold the PRESET/RECALL button. Turn the Data Wheel to scroll through the various presets. As each factory preset is selected, the display will clearly indicate the title that is directly related to a specific application. Press the Data Wheel to load the selected preset (or press the PRESET/RECALL button to cancel). The display will appear something like this:

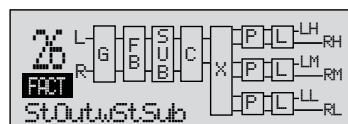

When you load a factory preset, a FACT icon will appear above the factory preset name. When you load a user preset, a USER icon appears above the preset name.

4.3 Editing Factory Presets

To edit the currently loaded factory preset, press a module's button (COMP/LIMITER, for example), then use the PREV PG and NEXT PG buttons to move through the pages within the module. Turn the Data Wheel to edit parameter values. The following illustration shows an example of the Comp module in edit mode:

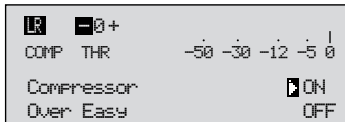

Note that the arrow indicates the currently selected parameter for editing. To select parameters to edit from the current page, simply press the Data Wheel until the arrow is pointing to the parameter that you wish to edit.

4.4 Saving Presets

Once you are satisfied with the changes that have been made to a factory or user preset, the DriveRack® PA+ allows you to save these changes as a custom USER preset. Press the STORE button, the display will appear as follows:

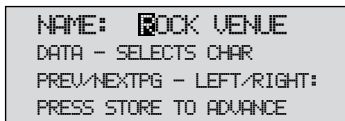

- Rotating the Data Wheel will change characters in the currently selected position.
- Pressing the Data Wheel will toggle between upper and lowercase letters, numbers or symbols.
- Use the PREV PG and NEXT PG button to move character positions.
- Once the desired title has been written, press the STORE button again and the display will now appear something like this:

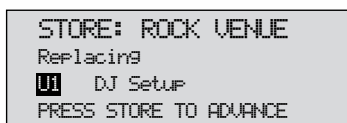

- Rotate the Data Wheel to select the user preset number to be replaced. Press the STORE button again and the existing preset will be replaced with the new preset.

The DriveRack® PA+ will store up to 25 user presets in addition to the 25 factory presets.

Note: Factory presets cannot be over-written. When storing changes to a preset, you must replace an existing User preset.

Section 5 - Detailed Parameters

The DriveRack® PA+ offers complete editing flexibility, by offering in-depth control over every parameter within each effect module. The following section will provide you with descriptions and explanations of parameters within the DriveRack PA+.

5.1 Graphic EQ

The DriveRack PA+'s Graphic EQ section may be configured as a Dual Mono or linkable 28 band graphic EQ.

EQ On/Off

Turns the GEQ on and off.

Flatten/Restore

This parameter either flattens the GEQ or restores the GEQ to the last setting before flattening. The DriveRack PA+ allows you to leave the EQ edit window and return without losing the edited EQ settings.

Frequency (F) 31.5Hz to 16.0kHz

This parameter allows you to select any one of the 28 available frequencies.

Gain (G) -12 to +12 dB

This parameter allows you to adjust the level of any one of the 28 bands of the GEQ in .5 dB increments.

5.2 Advanced Feedback Suppression

The DriveRack PA+ includes the exclusive patent pending AFS® (Advanced Feedback Suppression) feedback elimination module. Feedback is caused when a signal such as a guitar pickup or microphone is reproduced by a speaker and is repeatedly picked up in phase through the same pickup or microphone. The AFS uses precision frequency detection and state-of-the-art processing to determine the exact portions of a given frequency of your feedback that needs to be removed (instead of taking out large sections of your sound). The AFS module of the DriveRack PA+ allows the user to optimize the elimination of feedback. In the past, graphic equalizers were used to eliminate feedback from a system. This was an acceptable method for eliminating feedback, but when this method was precision tested, the result clearly showed that a single 1/3 octave EQ slider was removing approximately half of the signal power. With AFS, the precision filters remove only a fraction of the frequency spectrum. The diagram on the following page shows AFS as opposed to competitive feedback eliminators and conventional graphic EQs:

AFS Comparison Chart

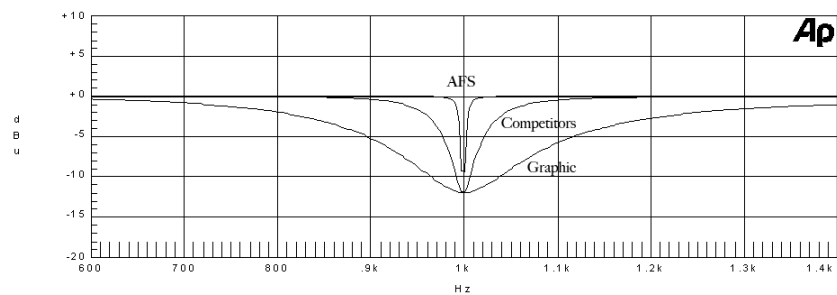
**AFS On/Off**

Turns the AFS® module on and off. If AFS is Off, the filters are bypassed, and the algorithm is halted (the filters are not updated). If AFS is On, the filters are active, and they are updated according to the current selected mode (Fixed or Live).

Clear Live/All

This parameter clears the filters. If Clear Live is selected, then (if invoked) the live filters are reset to “0” boost or cut. If Clear All is selected, then (if invoked) all of the filters (fixed and live) are reset to “0” boost or cut. When either Clear Live or Clear All is selected, the third parameter row displays “Clear w/ Data Wheel.” If Clear (none) is selected, then nothing is displayed on this row. When the user moves to this third row and turns the Data Wheel (when Clear Live or Clear All is selected) then the filter reset is invoked.

Mode - Live or Fixed

When the mode is Fixed, the algorithm updates only the fixed filters. When the mode is Live, the algorithm updates only the live filters. In FIXED mode, the filters are automatically assigned to a frequency creating feedback, thus remaining at that frequency until cleared by the user. Fixed mode is used before the performance without any program, instrument or vocal input signal. In LIVE mode, the live filters automatically detect and remove feedback during the performance. When all of the live filters have been used, they begin to round robin. Essentially this means that the first live filter set is replaced where a new feedback is detected and notched out. This mode is useful because feedback frequencies may change as the microphone is moved, and/or as the characteristics of the venue change.

Type - Speech, Low Music, Medium Music and High Music

If Fixed or Live mode is chosen, the text will read “Type.” The options will be Speech, Music Low, Music Medium and Music High. These types pertain to the Q, sensitivity, and algorithm type. Values are; Speech (Bandwidth = 1/5 octave and Q=7.25) Music Low (Bandwidth = 1/10 octave and Q=14.5) Music Medium (Bandwidth = 1/20 octave and Q=29) Music High (Bandwidth = 1/80 octave and Q=116). Note: To guarantee that feedback is suppressed at lower frequencies, the AFS may place wider notch filters at these lower frequencies (below 700 Hz).

Number Fixed - 0-12

This will range from values 0-12. The total number of filters will stay at 12, and the number of live filters will be = Total Num Filters – Num Fixed. If this is changed before the filters are reset, then the filters will be reset one by one as the number changes. For example, if the number of Fixed filters goes down, then the last fixed filter set will be reset. Likewise, if the number of Fixed filters goes up (and thus the number of live filters goes down), then the last live filter set will be reset. The Fixed/Live filter usage will be indicated at the bottom of each page of the feedback elimination effect. 'F' indicates an available fixed filter, and 'L' indicates an available live filter. A blocked out F or L indicates a filter that is set, or in use.

Live Filter Lift (On/Off)

This parameter turns the Live Filter Lift on and off.

Lift After - 5 sec to 60 min

This parameter allows the user to setup the AFS module so that the Live filters will automatically be removed or set to flat after a set time (as indicated by the "Lift After" parameter). It ranges from 5 seconds to 60 minutes. This feature is useful if the microphone being used is moved or the characteristics of the venue change over time. As example; a filter placed minutes ago will not be presently preventing feedback. This feature removes unnecessary filters from the spectrum to increase sonic quality. If the feedback is still there (after the filter is removed), it will catch it and notch it out the same.

5.3 Subharmonic Synthesizer

The Subharmonic Synthesizer module has been specifically optimized to enhance Bass audio material for use in a variety of professional applications, including nightclub and dance DJ mixing, theatre and film sound, music recording, live music performance and broadcasting. The Subharmonic Synthesizer module's two separate bands of subharmonic synthesis provide the best combination of smoothness and control, and the independent low frequency boost circuit is designed to get the most out of high-performance low frequency speaker systems.

Sub-Harmonic Synth - On/Off

Turns the Subharmonic Synth module on and off.

Sub-Harmonics Synth - 0 to 100%

This parameter sets the overall level of the Subharmonic Synthesizer.

24-36Hz and 36-56Hz (Subharmonic Synthesis) Level - 0 to 100%

These controls individually let you customize the amount of the respective synthesized frequencies to be added in, tuning the ultimate bass response of your system to taste. For example, if the sound is too woofy or growly, try turning down the 36Hz-56Hz level. If your woofers are bottoming out (making a ticking, popping sound), try turning down the 24Hz-36Hz level. You may find that a setting produces fine results in one room, but produces too much boominess in another. If this occurs, adjust the controls as needed, (e.g., increase or decrease one or the other of the band levels). Experimentation will pay off with smooth, full, deeply extended bass. Remember, you are not selecting a frequency. You are controlling the overall level of each band.

IMPORTANT! The Subharmonic Synthesis process creates very low frequency audio material that some speakers may not be designed to reproduce. Attempting to achieve enhanced

bottom end with these systems may not be possible and may result in over-stressing or even damaging your speakers. It is generally not a good idea to use this feature without a subwoofer. In any case, please refer to your mains' and subwoofer speakers' frequency response specifications, and avoid forcing them to reproduce low frequencies that they are not designed to reproduce.

5.4 Crossover

The Crossover is used to divide the input signal into several frequency bands. This allows the user to drive each speaker in its optimum frequency range and send each output separately for more efficient use of amplifier power. The DriveRack® PA+ Crossover can be configured as a 2x2, 2x3, 2x4, 2x5 or 2x6. The High frequency output is created using a High-Pass filter. The Mid and Low outputs are created using Band Pass filters consisting of Low-Pass and High-Pass filters. When editing Crossover parameters the frequency band is indicated by the highlighted H, M, or L in the top left corner of the LCD display. The High-Pass or Low-Pass filter being edited is indicated by the highlighted edge in the graphics area. For each Low-Pass filter there are two parameters:

Frequency

Adjusts the frequency of the Low Pass filter from 20 to 20KHz.

Type

Selects the filter type. Selections are BW 6,12,18,24 for a Butterworth type filter with a slope of 6, 12, 18 or 24 dB/Octave and LR12, 24 for Linkwitz-Riley filter type with slope of 12 or 24 dB/Octave.

For each High Pass filter there are three parameters and they are as follows:

Frequency

Adjusts the frequency of the High Pass filter from 20 to 20KHz.

Type

Selects the filter type. Selections are BW 6,12,18,24 for a Butterworth type filter with a slope of 6, 12, 18 or 24 dB/Octave and LR12, 24 for Linkwitz-Riley filter type with slope of 12 or 24 dB/Octave.

Gain

Adjust the crossover output level for the selected output from -60 to plus 20 dB.

5.5 Output Parametric EQ (PEQ)

In addition to the graphic EQ options within the signal path, the DriveRack PA+ also offers a 2 band low and mid and a 3-band high parametric EQ after the crossover section. The parameters for the PEQ are as follows and are user adjustable.

PEQ On/Off

Turns the PEQ band on and off.

Flatten/Restore

This parameter either flattens the PEQ or restores the PEQ to its original shape.

Type

This parameter selects the PEQ type. Types include: 1. Bell-All parametrics are bell-shaped 2. HShelf - One shelf is High, while all others are bell 3. LShelf - One shelf is Low, while all others are bell and 4. LHSshelf - One shelf is High and one is Low, and the others are bell.

Band (1-3) Frequency 20Hz to 20kHz

Selects the frequency of the selected band of the parametric EQ.

Level (1-3) -12dB to 12dB

Sets the boost or cut level of the selected parametric EQ.

Q (1-3) 0.20 to 16 dB

Sets the Q or Bandwidth of the selected Parametric EQ.

5.6 Compressor/Limiter

The DriveRack® PA+ also offers Compression and Limiter modules. The Compressor is a full bandwidth Stereo Compressor located prior to the Crossover. The Compressor is the perfect tool for tightening uneven signal sources such as vocals and guitars. The Limiters are located on each stereo output channel and have been strategically placed for speaker and amplifier protection. Note that Compressor/Limiter threshold metering can be observed on page two of the Utility section. The parameters for the Compressor/Limiter are as follows and are user adjustable.

Compressor

Compressor On/Off

Turns the Compressor module on and off.

OverEasy (0) Off to 10

There are ten levels of OverEasy® that can be used for the limiters. The point when the compressor starts to compress is the “knee.” When the compressor starts to reduce the level of a signal abruptly as it passes over the threshold, this is called “hard knee” compression. OverEasy (soft knee as it is sometimes called) is when the volume of the sound is compressed gradually. OverEasy compression starts to compress before the level of the signal reaches the threshold and reaches full compression after the level has gone above the threshold. OverEasy compression, by its very nature, sounds much smoother and more natural and will be used for most applications. When it is gentle (natural sounding or light) compression that you are looking for, the compressor offers VariKnee™. VariKnee gives you ten levels of OverEasy compression to choose from (1 being almost hard knee and 10 being the most OverEasy). This lets you choose the exact knee that is needed for the dynamic effect you are looking for.

Threshold (T) -40 to +20dBu

Threshold is the signal level at which the unit starts to compress the signal. If the level is set to -10 dBu, than any signal greater than -10 dBu is compressed while any signal that has

a level that is lower than -10dBu is left at the same signal level. Light compression is where only the loudest parts of the signal go over the threshold. Very heavy compression can be achieved by setting the threshold low enough that almost the entire signal content is over the threshold. For most signals the most natural compression is achieved when most of the signal content remains just below the threshold and only the peaks cross the threshold.

Ratio (R) 1.0 to Inf:1

Ratio is the amount the unit reduces the signal level of the sound that is above the threshold. A 2:1 ratio means that if the incoming signal is 2dB over the threshold the unit will compress the signal, and outputs a signal that only goes 1dB over the threshold. For light compression choose a lower ratio, while a heavy compression requires a higher ratio. A setting of Inf:1 makes the compressor act as a limiter.

Gain (G) -20 to +20 dB

This parameter is used to compensate for the gain lost during compression. By using heavy compression on a signal and then boosting the signal with the output gain, the user can create a signal that sounds much louder than it actually is.

Limiter**Limiter On/Off**

Turns the Limiter module on and off.

OverEasy (O) Off to 10

There are ten levels of OverEasy® that can be used for the limiters. The point when the limiter starts to limit is the “knee.” When the limiter starts to reduce the level of a signal abruptly as it passes over the threshold this is called “hard knee” limiting. OverEasy® (soft knee as it is sometimes called) is when the volume of the sound is limited gradually. OverEasy limiting starts to limit before the level of the signal reaches the threshold and reaches full limiting.

Threshold (T) -40 to +20dBu

Threshold is the signal level at which the unit starts to limit the signal. If the level is set to -10 dBu, any signal larger than -10 dBu is limited while any signal that has a level that is lower than -10dBu is left at the same signal level.

5.7 Alignment Delay

The DriveRack® PA+ offers alignment delay to use for compensating signal delay that occurs due to internal speaker components such as horns, mid speakers and subwoofers within speaker cabinets. The parameters for the alignment delay are as follows and are user adjustable:

Delay On/Off

Turns the Speaker Alignment delay on and off.

Units - Seconds, Feet or Meters

Selects the unit of measurement for the delay.

Length

Sets the amount of Speaker Alignment delay time. Delay times include: Seconds- 0.00-10.00 ms, Feet- 0.00-11.3 and Meters - 0.00-3.43. Fine adjustments are made in .02 ms increments. Coarse adjustments are made in .21 ms increments. Press the Data Wheel when length is selected to switch between coarse and fine options.

Section 6 - Application Guide

This Application guide section is provided to offer suggested installation applications for the DriveRack® PA+. Note that the 25 included application presets represent the extensive flexibility of the DriveRack units. These applications can be used as sample reference guide templates for designing countless audio applications.

6.1 Stereo 3-Way

Hardware

1. Connect the outputs from the mixer to the inputs of the DriveRack PA+.
2. Connect the outputs of the DriveRack PA+ to the selected speaker amplifier.
3. Make sure that the mixer and power amps are turned off prior to powering up the DriveRack PA+.

Front Panel Editing

1. From Preset mode, select factory preset #26 (Stereo 3-Way) as a template, or use the Wizard to set up the specific preset.
2. Once the preset has been chosen, press the Data Wheel to load the preset.

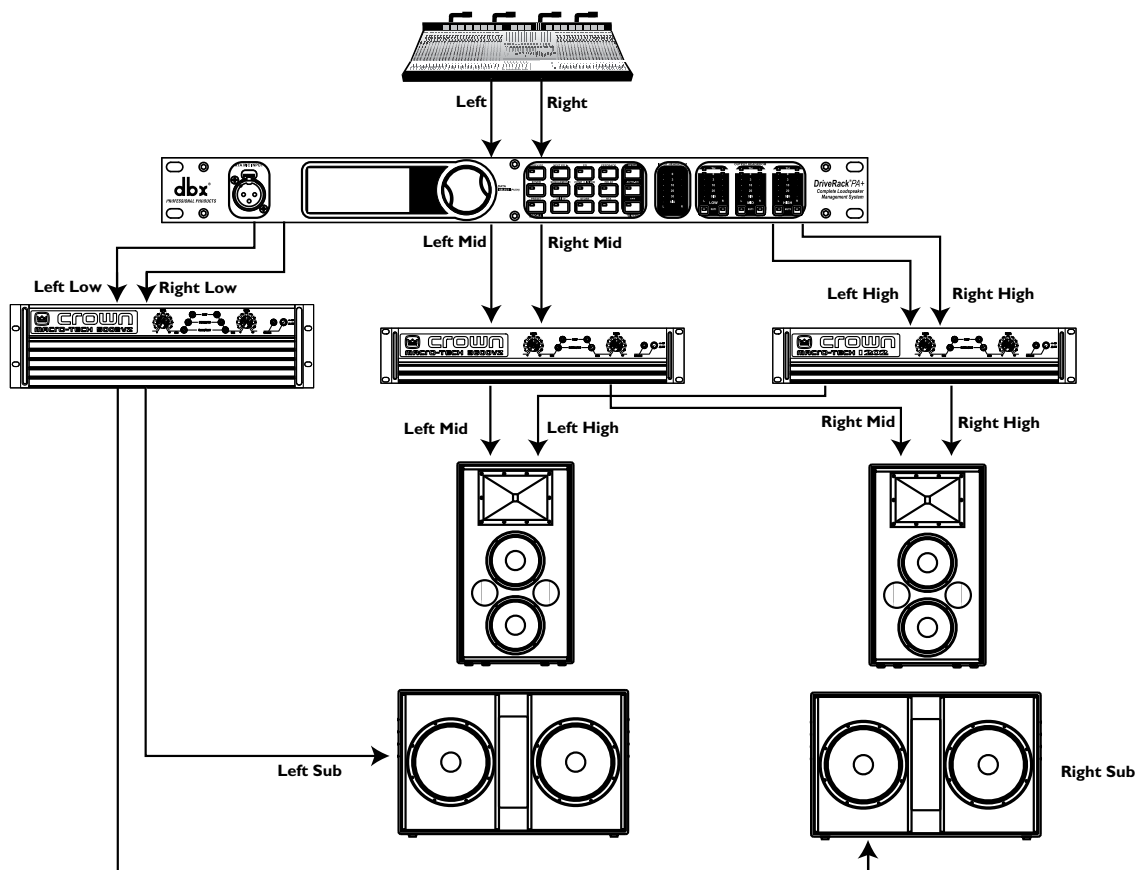

6.2 Stereo 3-Way with Mono Sub

Hardware

1. Connect the outputs from the mixer to the inputs of the DriveRack® PA+.
2. Connect the outputs of the DriveRack PA+ to the selected speaker amplifier.
3. Make sure that the mixer and power amps are turned off prior to powering up the DriveRack PA+.

Front Panel Editing

1. From Preset mode, select factory preset #26 (Stereo 3-Way) as a template, or use the Wizard to set up the specific preset.
2. Once the preset has been chosen, press the Data Wheel to load the preset.

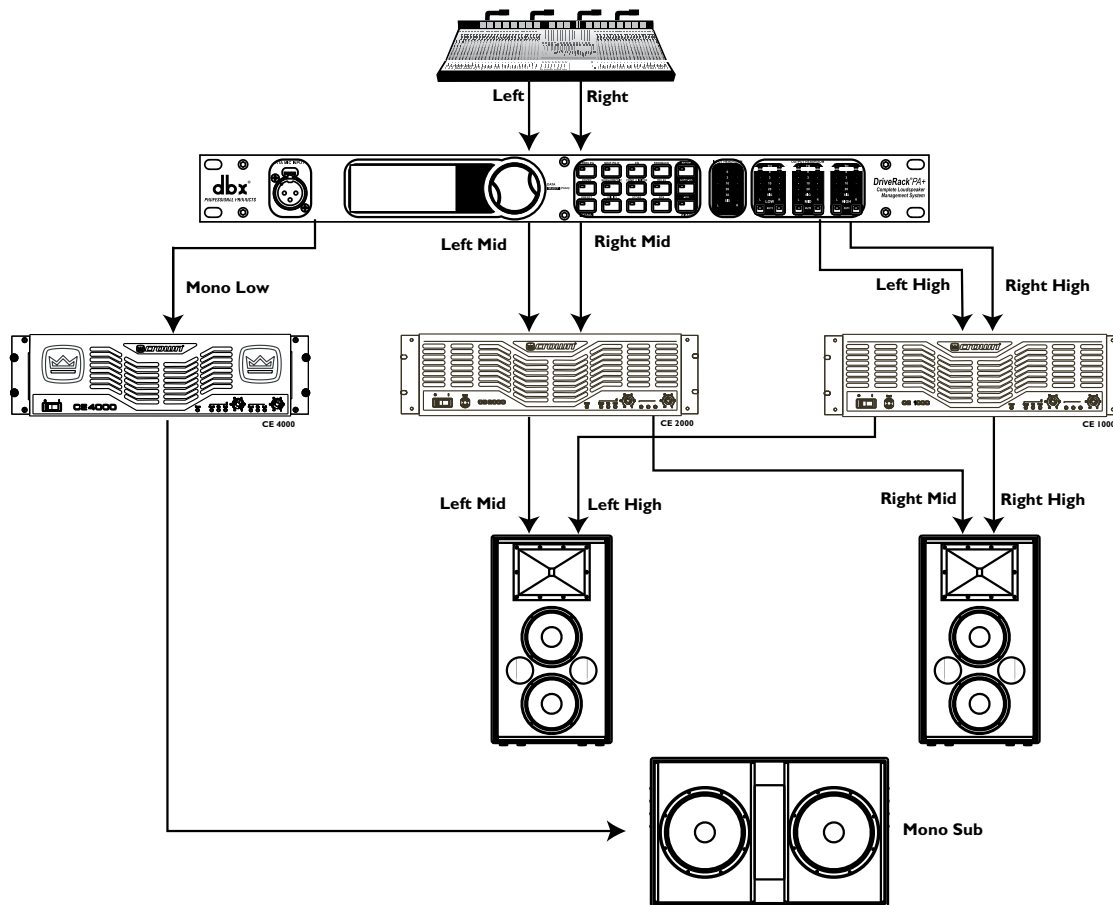

6.3 Stereo 2-Way

Hardware

1. Connect the outputs from the mixer to the inputs of the DriveRack® PA+.
2. Connect the outputs of the DriveRack PA+ to the selected speaker amplifier.
3. Make sure that the mixer and power amps are turned off prior to powering up the DriveRack PA+.

Front Panel Editing

1. From Preset mode, select factory preset #27 (Stereo 2-Way) as a template, or use the Wizard to set up the specific preset.
2. Once the preset has been chosen, press the Data Wheel to load the preset.

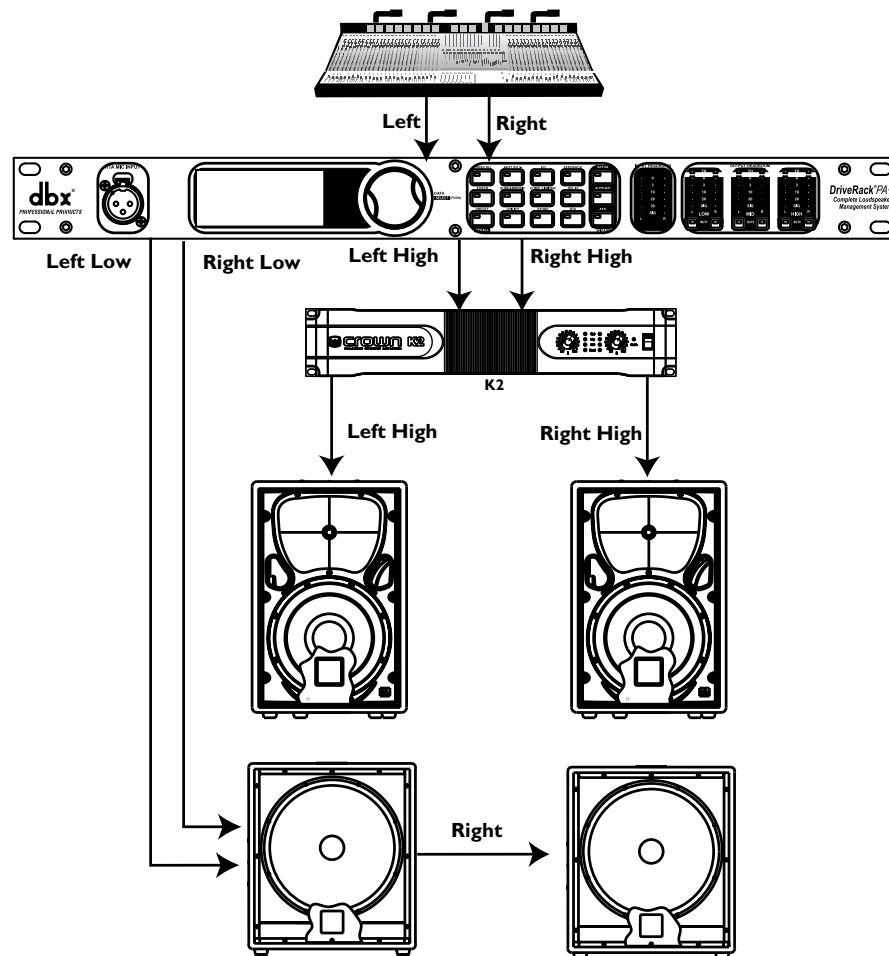

6.4 Stereo 2-Way with Mono Sub

Hardware

1. Connect the outputs from the mixer to the inputs of the DriveRack® PA+.
2. Connect the outputs of the DriveRack PA+ to the selected speaker amplifier.
3. Make sure that the mixer and power amps are turned off prior to powering up the DriveRack PA+.

Front Panel Editing

1. From Preset mode, select factory preset #27 (Stereo 2-Way) as a template, or use the Wizard to set up the specific preset.
2. Once the preset has been chosen, press the Data Wheel to load the preset.

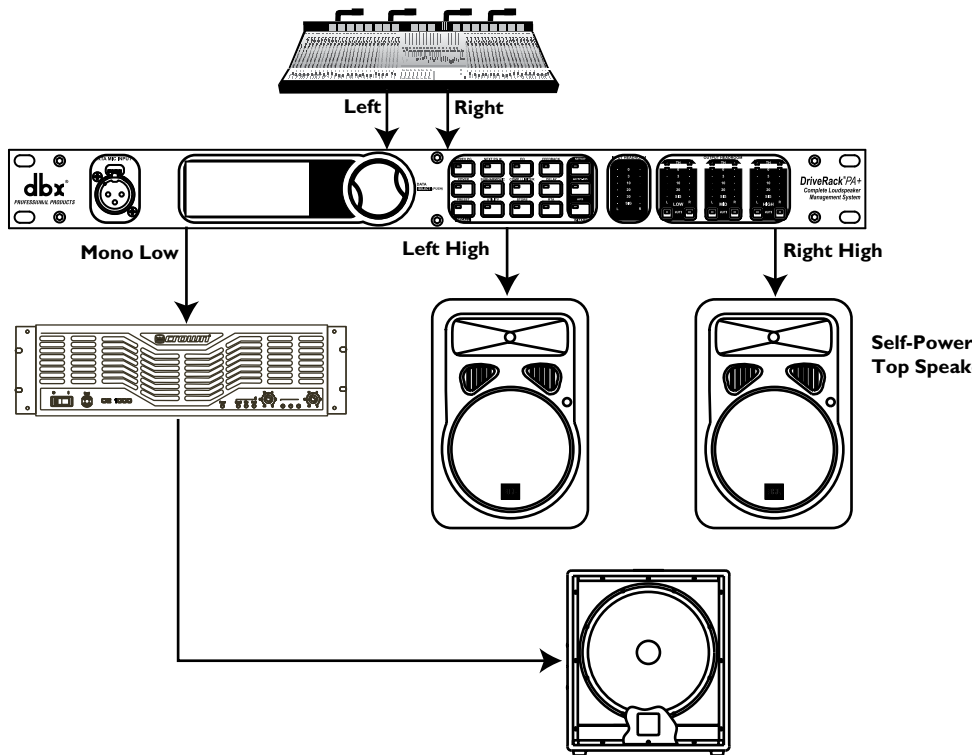

Section A - Appendix

A.1 Factory Reset

In the event that a reset is required, the DriveRack® PA+ offers you the option of performing a "Soft" or "Hard" reset. The Soft Reset resets all operating parameters except user presets. The Hard Reset Procedure will reset all presets information back to the factory defaults.

A.2 DriveRack PA+ Power-Up Button Functions

All Power-Up Functions require a button(s) to be pressed and held as the unit power is turned on.

Factory ("Hard") Reset.

Press and hold the STORE button at power-up until the following message appears:

"! HARD RESET?"

"Yes <PREV PAGE>"

"No <PRESET>"

- Pressing the PREV PG button will start a Factory Reset (All User Presets will be restored to the Factory Presets, all Utility settings will be defaulted, and all Security settings will be defaulted).
- Pressing the PRESET/RECALL button will abort the Factory Reset sequence and the unit will reset normally.

System ("SOFT") Reset

- Press and hold the UTILITY button at power-up until the following message appears:

"! SOFT RESET?"

"Yes <PREV PAGE>"

"No <PRESET>"

- Pressing the PREV PG button will start a System Reset (All Utility settings will be defaulted.)
- Pressing the PRESET/RECALL button will abort the System Reset sequence and the unit will reset normally.

A.3 Power Up Quick Key Options

The DriveRackPA+ offers several "Quick Key" options for initial power up and are as follow:

Change Initial Preset Number

- To change the initial power up preset number, Press and hold the PRESET/RECALL button at power-up until the following message appears:

Use Wheel to Change Restart Preset Number

- Turning the Data Wheel will select the preset you wish to load at initial power-up.
- Press the PRESET/RECALL button again when the selection is complete. Normal startup will continue.

System Lock Out

- Press and hold the RTA button at power-up until one of the following messages appears:
System Unlocked All user input will be accepted
or
System Locked No user input will be accepted
or
System Locked with AFS Filter Clear
- Rotate the Data Wheel to select either Lock, Unlock or Filter Unlocked.
- Pressing PREV PG will unlock the system if it were locked or it will lock the system if it were unlocked.
- If you wish to leave the system locked with the exception of being able to clear the feedback filters, follow the same procedure on power up and then rotate the Data Wheel to select the feedback filter unlock feature.
- Pressing any other button will abort the System Lockout sequence and the unit will reset normally.

A.4 Update Firmware

For information on updating the DriveRack® PA+ firmware via USB, visit the Products page at www.dbxpro.com and select DriveRack PA+. New firmware update links will be posted when available.

A.5 Preset List/Speaker Tunings

For the latest lists of presets and supported speaker tunings, visit the Products page at www.dbxpro.com.

A.6 Specifications**ANALOG INPUTS:**

Number of Inputs:	2 Line inputs 1 RTA Mic input
Connectors:	2 Female XLR line inputs 1 XLR RTA Mic input
Type:	Electronically balanced, RF filtered
Impedance:	> 40 k Ω
Max Input Line level:	+20 dBu
Input CMRR:	> 45 dB
RTA Mic Phantom Voltage:	+15 VDC
RTA Mic EIN:	< -117 dBu, 22 Hz-22 kHz, 150 Ω

ANALOG OUTPUTS:

Number of Outputs:	6 Line outputs
Connectors:	Male XLR
Type:	Electronically balanced, RF filtered
Impedance:	120 Ω
Max Output Level:	> +20 dBu
CMRR:	> 45 dB
Alignment Delay:	10ms per channel (60ms total)

A/D PERFORMANCE:

Type:	dbx Type IV™ conversion system
Dynamic Range:	110 dB A-weighted > 107 dB unweighted
Type IV dynamic range:	123 dB with transient material, A-weighted, 22 kHz BW 121 dB with transient material, unweighted, 22 kHz BW 115 dB typical with preset material, A-weighted, 22 kHz BW
Sample Rate:	48 kHz

D/A PERFORMANCE:

Dynamic Range:	112 dB A-weighted 110 dB unweighted
Sample Rate:	48 kHz

SYSTEM PERFORMANCE:

Dynamic Range:	110 dB A-weighted, >107 dB unweighted,
THD+N:	0.004% typical at +4dBu, 1 kHz, 0 dB input gain
Frequency Response:	20 Hz – 20 kHz, +/- 0.5dB
Interchannel Crosstalk:	<-110 dB, -120 dB typical
Crosstalk input to output:	<-100 dB

POWER SUPPLY:

Operating Voltage:	100-120VAC 50/60 Hz - EU: 220-240 VAC 56/60 Hz
Power Requirements:	25 Watts

PHYSICAL:

Weight:	5.5 lbs.(2.5 kg) Shipping weight 7 lbs. (3.18 kg)
Dimensions:	1.75" (4.4cm) H x 5.75" (14.6cm) D x 19" (48.26cm) W

A.7 AUTO-EQ Optimization Tips

By using the Setup Wizard, cross over output gains and post cross over parametric EQ settings are set to match your system. The Auto-EQ Wizard can be used to adjust your system to compensate for room effects, and adjust the response of the entire system to your liking. After allowing Auto EQ to “pink the room” your system will sound tighter. The low end will have more definition, the mids will be more intelligible, and the highs can be tamed. Here are two things to look for to get the best performance from the Auto EQ.

Look out for “Modes”

Some speaker and RTA microphone positions will result in certain frequencies canceling out. The resulting modes can not be corrected with equalization. The Auto EQ does not detect modes in the frequency response, so may try to boost a band to compensate for a mode with out positive affect. You may be able to see if a lifted band is a mode by manually adjusting a lifted EQ band - if no change in the EQ is perceived, you probably are seeing a mode in your frequency response. To reduce the effect of this mode, try different microphone positions and adjust the location of your speakers, then repink the room for a more effectual Graphic EQ adjustment.

Adjust Cross Over Output Gains

If your system setup or the response you have chosen results in the Auto EQ lifting or cutting a number of consecutive bands of the Graphic EQ, you can adjust the level of the associated cross over output gain to match the average boost or cut in the graphic EQ and repink your room. This time, the adjustment of the Graphic EQ bands will be less “heavy handed” and the system will sound better having fewer phase problems and a lower noise floor than a more aggressively adjusted Graphic EQ. With the rest of your system properly adjusted, the Auto EQ can compensate for room resonance and adjust to suit personal taste without large excursions in the Graphic EQ bands.

A.8 Block Diagram

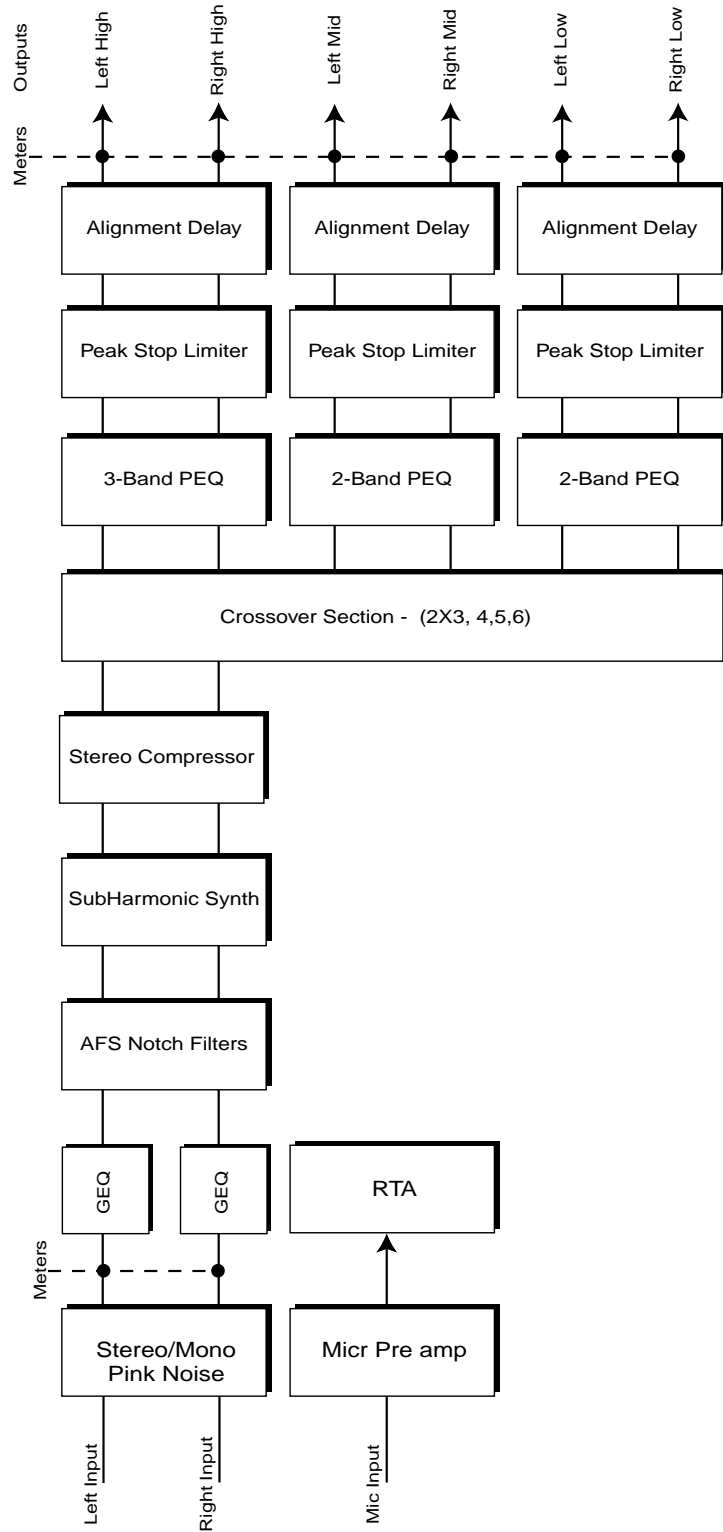

A.9 System Setup and Gain Structure

The DriveRack® PA+ offers a wide range of tools for sound system design and setup. These tools can make your system more efficient and better sounding, but to get the best possible sound it is important to use these tools properly. In the DriveRack PA+ we have included a Setup Wizard tool to help in system setup. If you use the Setup Wizard to set up your DriveRack PA+ it will automatically set the limiters for some amplifier selections. If your amplifiers are not available in the Setup Wizard, you should choose the Custom setting. The following section explains how to maximize system gain and how to use the limiters to protect your amplifiers from clipping.

In traditional system design, the output of your console would be routed to a system EQ, a compressor, and a crossover with output level control. From the crossover, there may be additional filters that are employed to improve the response of your speakers. There may also be limiters set up to keep your amplifiers from going into clipping and protect your speakers from the hazards of a clipped signal. Your amplifiers play a vital role in system setup, because they are last item in the chain before your speakers and offer the greatest amount of gain (that is their job after all). If your amplifiers are incorrectly setup you will not be using your system to its fullest potential and could be harming your speakers.

One thing that is critical to system setup is maximizing gain structure. Gain structure refers to aligning the gain of each device so that they all clip at the same point, and the noise floor of the entire system is at its absolute minimum. Quite often PA systems are setup with the amplifier input controls turned all the way up in the incorrect assumption that this is the only way to get the maximum output level. Amplifiers are fixed gain devices, turning down the amplifier input attenuators does not change the potential output of the amplifier; it only requires more input voltage to get full output power. Many amplifiers will clip with an input level greater than +6 dBu when the input attenuators are turned all the way up. Most mixing consoles can deliver over +18 dBu of output level before clipping. This means that with your amps tuned all the way up you are sacrificing 12 dB of headroom, resulting in poorer noise performance and the potential of system clipping. By adjusting the amplifier controls properly, you can maximize your system performance.

A way to set up your amplifiers for maximum gain structure is to use the clip indicators of the console and amplifiers themselves. Disconnect the output of the amplifier from the speakers.

Run a continuous signal (pink noise or sine waves) through your console. Turn up the output of the console until it begins clipping.

If there is no clip indicator on the console then use the output meters; most reputable console manufacturers use red LEDs at the top of the meters to show the onset of clipping.

Once the console is clipping, back the output gain down slightly until the clip indicator turns off. Run this signal through the DriveRack PA+ and into the amplifiers with the crossovers and output gain section in the DriveRack PA+ set for your particular speakers. Make sure that the output limiters are turned off. Run this signal into the amplifiers and turn up the input

attenuators until the amplifier clip indicator begins to turn on. Turn the attenuators down slightly, so the clip indicator no longer is on. You have just maximized the gain through your system. This amplifier setting should give you maximum gain without clipping, another way to say this is that when the output of your console is clipping you will also be at the clip point of your amplifiers.

Once you have found the clip point of your amplifiers, you can mark this position and turn the amplifiers back up to the point where they are clipping. You can now use the output limiters in the DriveRack PA+ to protect the amplifier from clipping no matter what you do at the console. With the amplifiers clipping, now go to the Limiter page of the DriveRack PA+ and turn the limiter for each output band on. Make sure that the threshold is all the way up to +20dB. Now slowly reduce the threshold until the clip indicator of the amplifier turns off. You have successfully set the output limiter up and the amplifier will not be able to go into clipping no matter what the input is.

You should now proceed to the next output band and go through the same process. If you are using a sine wave to create clipping in your amplifier you should make sure that the sine wave is within the frequency range of the output band that you are working with. Once all the limiters are set up you can now turn the amplifiers back down to the gain maximized position. The Setup Wizard will automatically set your limiters based on your choice of amplifier. Because of component variances within the amplifier circuitry, you may need to adjust the limiter settings by a few dB after running the Wizard to ensure that they are set correctly.

Once all the limiters are set up and the gain is maximized, reduce the output of your console and reconnect your speakers. Now for the fun part, sit back and send your favorite music through the system. If your system is not loud enough, you may want to consider an amplifier or amplifiers with greater output power. Most loudspeaker manufacturers recommend an amplifier that can provide 1.5 to 2 times the rated RMS power of the speaker. If this setting is too loud when your speakers are reconnected you can turn down the amplifier input attenuators even more.



8760 South Sandy Parkway • Sandy, Utah 84070

Phone: (801) 568-7660 • Fax (801) 568-7662

Int'l Fax: (801) 568-7583

Questions or comments?

Contact us at www.dbxpro.com

Printed in China