

CTS

UHF



USER'S MANUAL

ANY SPOT[®]

WIRELESS MICROPHONE SYSTEM

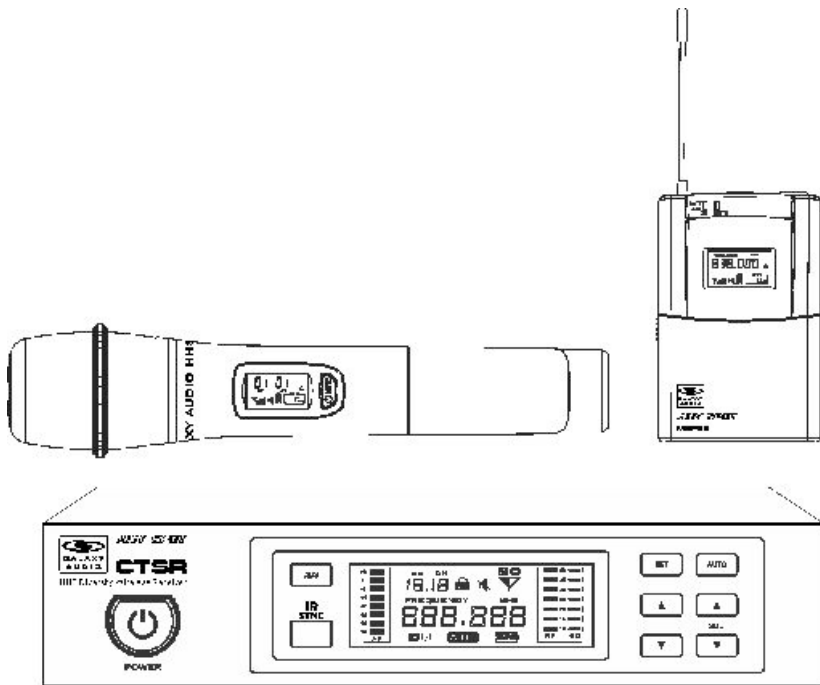

MAKERS OF THE ORIGINAL
HOT SPOT PERSONAL MONITOR

Contents

Introduction.....	1
System Components.....	2
Functions of the CTSR Receiver.....	3-4
Connecting a Receiver to the RF Distributor.....	5
System Setup.....	6-8
HH85 Handheld Transmitter.....	9
MBP85 Body Pack.....	10-11
Main Functions Description of Transmitters.....	12
Handheld and Body Pack Transmitter.....	13-14
Troubleshooting.....	15
Specifications.....	16

Thank you for choosing the Galaxy Audio CTS Wireless Microphone System. You have joined hundreds of thousands of other satisfied Galaxy customers. Since 1977 Galaxy Audio's professional experience in design and manufacturing ensure our products quality, performance and reliability.

For the most up to date manual and information
visit www.galaxyaudio.com.

CTS System Components

System Overview

The CTS system is specifically designed for a variety of performance art. The CTS system has 18 different groups, and each group consists of 14 compatible receiving channels. The CTS system is capable of searching vacant channels automatically, and synchronizing with transmitter accurately.

The CTS system consists of a receiver, transmitter, and power adaptor. The transmitter can either be a handheld or a belt pack (choice of headset or lavalier mic). Systems also include a 1/4" signal cable, (2) AA batteries and a user manual.

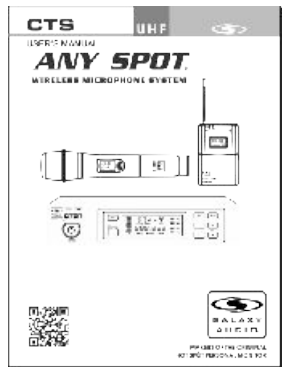
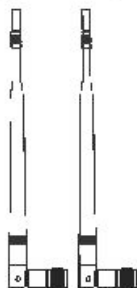
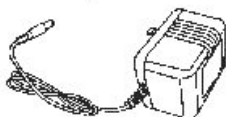

All CTS systems include the following components:

- CTS Receiver
- One 1/4" Audio Cable
- Power Adaptor
- Two Antennas
- Single Rack Ears
- User Manual

Handheld Microphone Systems include the following:

- HH85 Handheld Transmitter



Lavalier/Headset Microphone systems include the following:

- MBP85 Bodypack Transmitter
- Microphone (choice of Lavalier, or Headset)

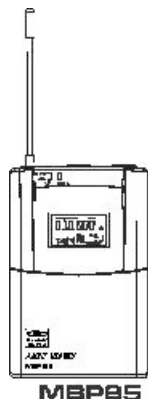

CTSR Receiver Features

Front Panel

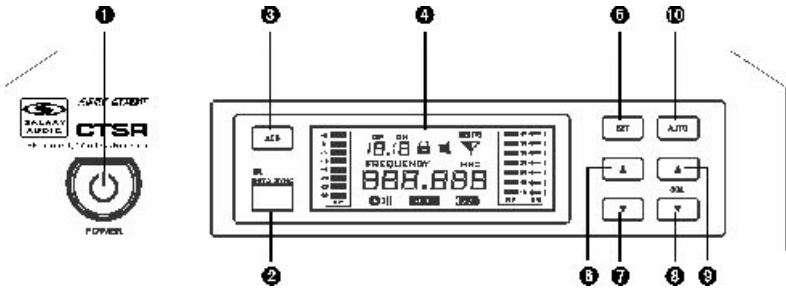

- 1** Power Switch.
With red light indicator, press it one second to turn it on or off.
- 2** IR Port
- 3** IR Sync Signal Button: Pressing button starts 10 second transmitter synchronization indicated by flashing Icon. During the 10 seconds aim the transmitter IR port at the receiver IR port and the transmitter will sync to the receiver frequency.
- 4** LCD Display Panel
- 5** System setting button
- 6** System Menu up button
- 7** System Menu down button
- 8** SQL decrease button
- 9** SQL increase button
- 10** Automatically Search for vacant channels

Functions of the CTSR Receiver

Rear Panel

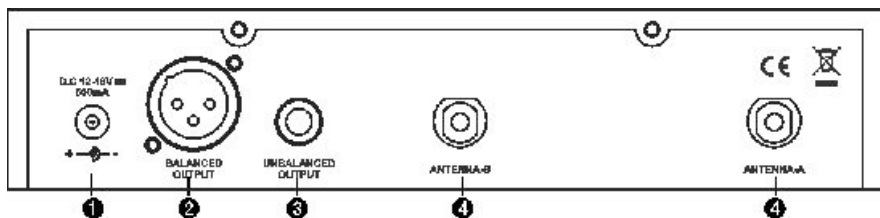

- ① DC power socket
- ② Balanced audio output socket
- ③ Un-balanced audio output socket: 1/4 inch
- ④ Antenna Socket

Receiver LCD Functions

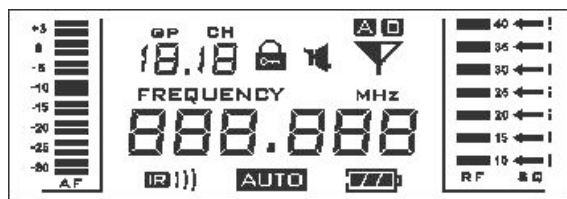

Display	Function
IR)))	IR port
AF	Audio Level
GP	Current Group Number
CH	Current Channel Number
FREQUENCY	Current Frequency
🔇	Mute, it will disappear when the mic is on
RF	Receiving Signal Status
SQ	Squelch Level Setting
AB	Antenna A B status
AUTO	Automatically Search for vacant channels

Connecting Receiver to the RF Distributor

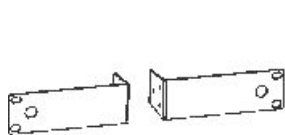

Rack mount side panel



DC power adapter

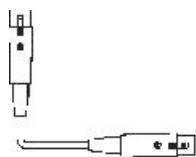

Balanced output cable

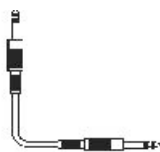

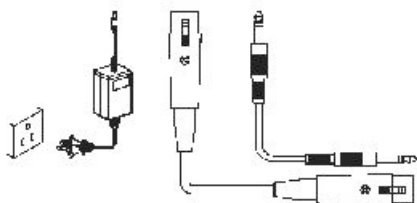
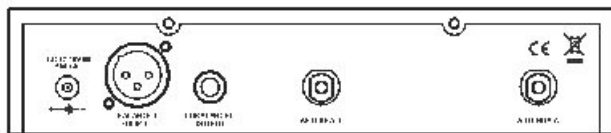
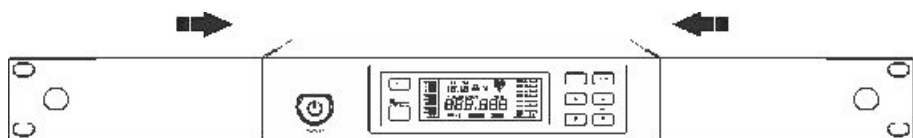

1/4 inch Output cable



System Setup

1. IR SYCN Setting

Press the **ADS** button, the icon  will flash for 10 seconds. During the 10 seconds aim the transmitter IR port at the receiver IR port and the transmitter will sync to the receiver frequency. When the sync is complete the icon  will disappear and the display will return to its normal state.

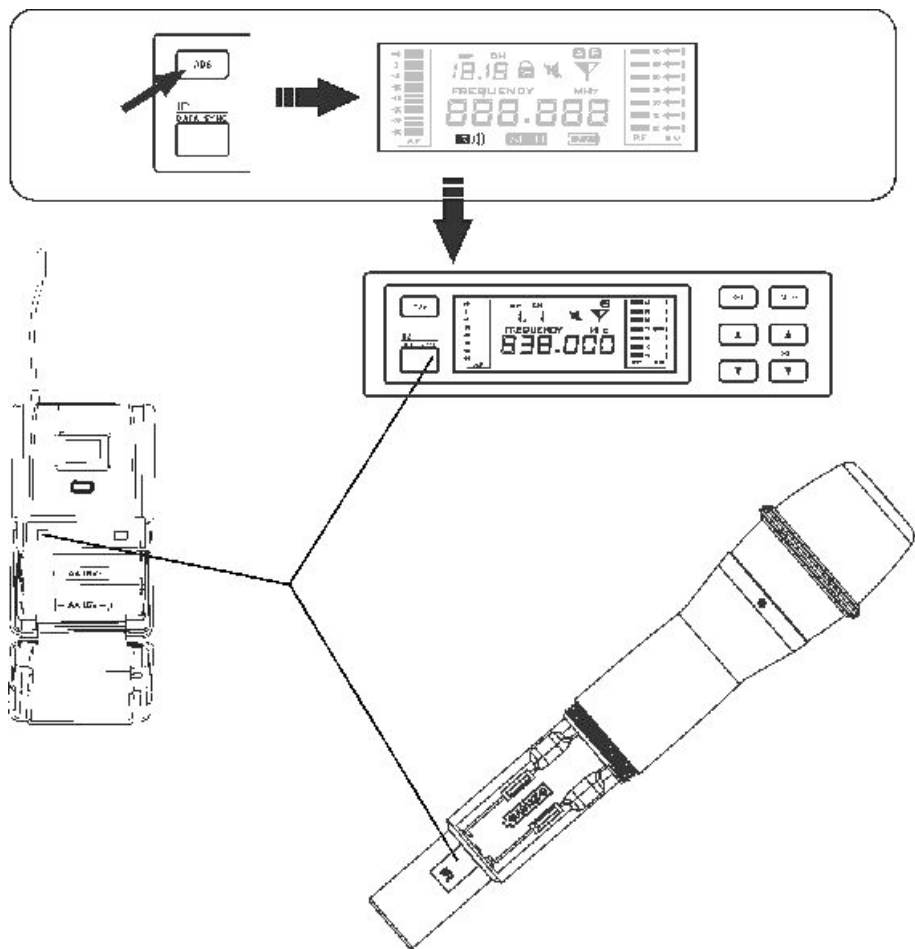

2. Selecting Frequency

Press **SET** button, the GP flashes to indicate the group can be chosen by pressing the **▲** or **▼** button, to confirm press the **SET** button. It will return back to the original state without any operation within 5 seconds.

Press **SET** to confirm the group selection, the CH flashes to indicate the channel can be chosen, press the **▲** or **▼** button to choose, Press **SET** again to exit setting mode automatically after confirmation.

When choosing frequencies from the "U" group, press **SET** button, and the top three numbers before the point flash, press **▲** **▼** buttons to choose, 1MHz for every push, and press **SET** again to confirm, then the last three number after the point blink, press **▲** **▼** buttons to choose, every step for 25Khz.

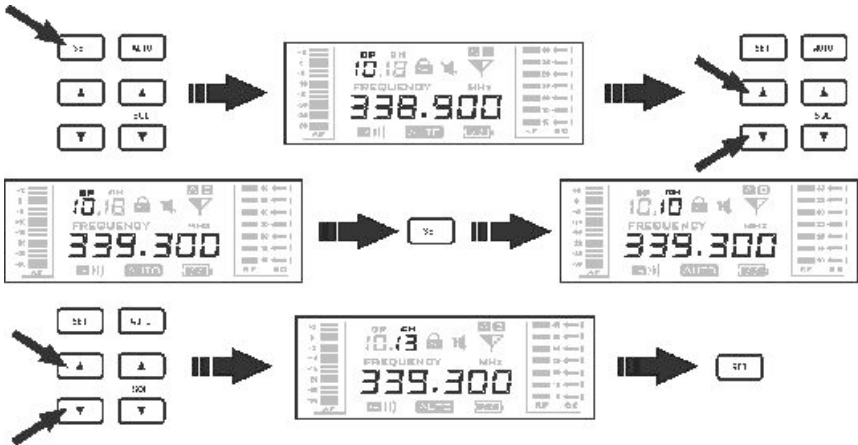

3. SQ Setting and Change

The CTSR receiver has a built-in adjustable SQL (Squelch Level) function which silences the output when the receiver does not get a strong or quality signal from the transmitter, instead of reproducing noise. When squelch is adjusted, the threshold of the signal quality or level is adjusted.

Press SQL **▲** or **▼** to change the value. The higher value means the lower reception sensitivity and stronger anti-interference ability. The selection should be based on the use of different locations to achieve the best effect.



System Setup

4. Automatically Search for Vacant Channel

Press **AUTO** , **AUTO** icon will start to flash , then available channels will be shown on the LCD display. For example , the LCD display shows 15, that means there are 15 vacant channels available. Then Press the button **▲** and **▼** to select an appropriate channel. Once a channel is selected, press **SET** to confirm the setting. If no vacant channel can be found within 5 seconds, receiver will automatically return to the original state.

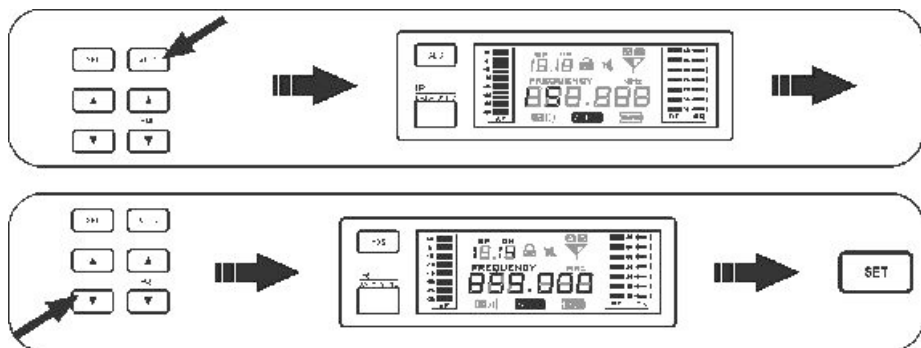

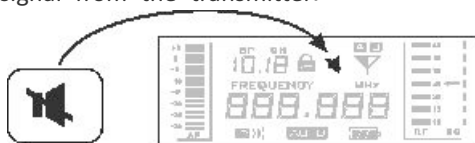

5. Auto Muting

The  icon is displayed in the receiver LCD screen when the frequency is different between receiver and transmitter or the receiver can't receive any signal from the transmitter.



6. Locking and Unlocking

Press **SET** and hold for one second until LCD shows "". At this time, all buttons except Power/Mute will be disabled. All receiver's setting functions are now locked. To unlock, press **SET** and hold it until the "" icon disappears, the receiver is now unlocked.

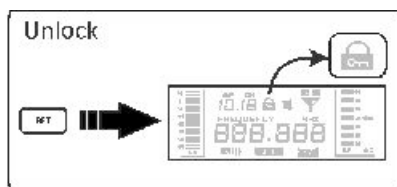
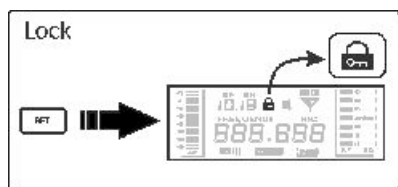

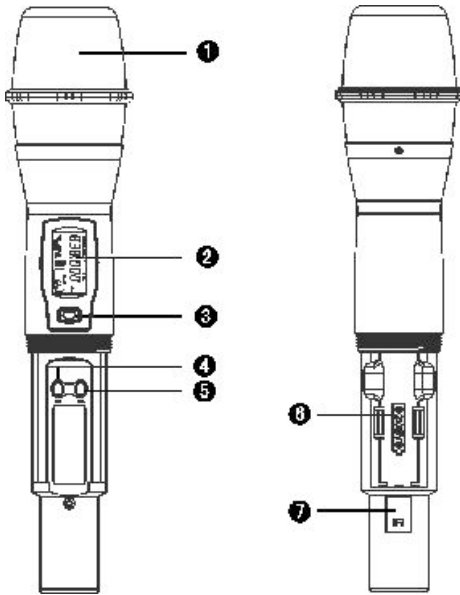

Functions:

- ① Microphone Grille
- ② LCD Display
- ③ Power and Mute switch: hold for three seconds to power on or off. Click once to mute or unmute output signal
- ④ System setting button.
- ⑤ System selection button.
- ⑥ Battery holder.
- ⑦ IR port: Receiving the IR signal to SYNC the CTSR receiver.

Changing Batteries:

Unscrew cover to access the Battery Tray. Observe correct polarity markings when installing Batteries.

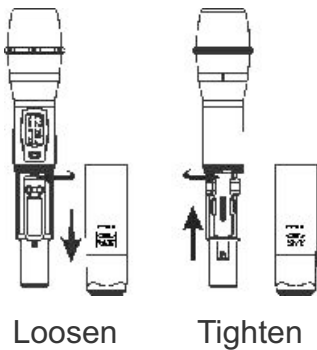

Battery Life

Display	Approximate Hours Remaining (alkaline batteries)
	8 Hrs +
	5 to 6 Hrs
	2 to 3 Hrs
	Low Battery

MBP85 Bodypack Transmitter

Functions:

- ❶ Mini XRL input socket
- ❷ Power/Mute switch: Press it and hold for three seconds can power on or off. Click once can mute or unmute output signal
- ❸ Antenna
- ❹ Low battery indicator
- ❺ Mute indicator
- ❻ LCD Display
- ❼ IR port: Receiving the IR signal to SYNC the CTSR receiver
- ❽ System setting button
- ❾ System Up or Down buttons
- ❿ Battery holder

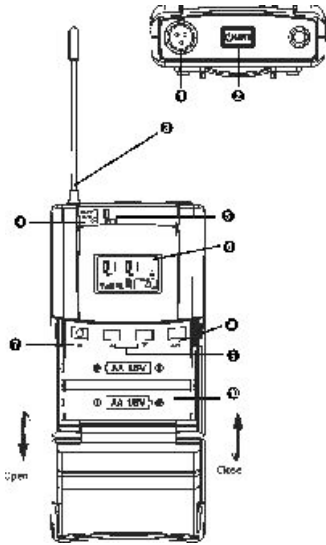

Battery Replacement:

Fold open the Battery Door as shown. Install Batteries while observing correct polarity markings.

The life expectancy of two alkaline batteries is about 8 hours.

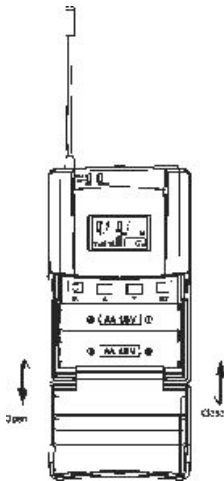

Display	Approximate Hours Remaining (alkaline batteries)
	8 Hrs +
	5 to 6 Hrs
	2 to 3 Hrs
	Low Battery

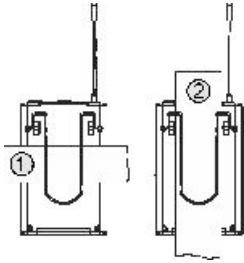

How to Wear the MBP85 Transmitter:

Clip the transmitter to belt ①, or slide a guitar strap through the transmitter's clip ②, as shown in the diagram at left.

For best results, slide the transmitter until the belt is pressed against the base of the clip ①.

Microphones for bodypack transmitter

HS-U3BK Headset Microphor

Polar Patten: Unidirectional
Sensitivity: $-65\text{dB} \pm 2\text{dB}$
Frequency Response:
50Hz-18KHz
Output impedance: $\leq 2\text{K} \Omega$
S/N Ratio: $\leq 38\text{dB}$

LV-U3BK Clip-on Microphone

Polar Patten: Unidirectional
Sensitivity: $-64\text{dB} \pm 2.2\text{dB}$
Frequency Response:
100Hz-20KHz
Output impedance: $2\text{K} \Omega$
S/N Ratio: $> 44\text{dB}$

This is just a sample of the many headset options available from Galaxy Audio.

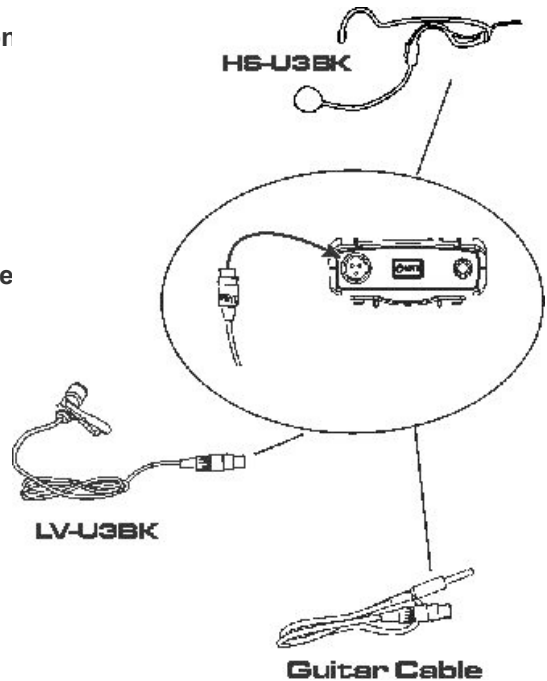



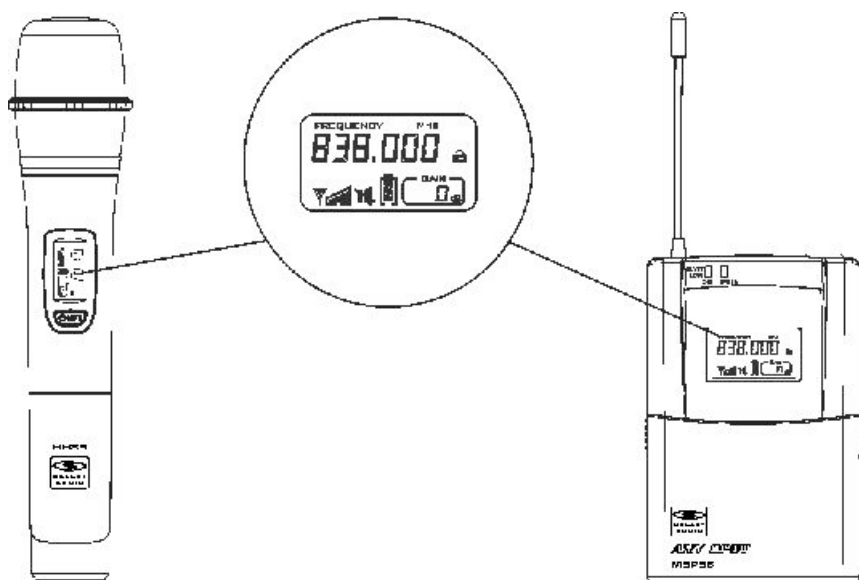

Main Functions Description of Transmitters



Display	Function
	Transmitter Output Power
	Battery Status
	Current Frequency
	Mute Symbol
	Transmitter Output Level
GP	Current Group Number
CH	Current Channel Number
	Function Locked Indicator





Handheld and Bodypack Transmitter

Transmitter gain adjust:

Press ,  symbol flashing, press the  button to change the relative level in dB. (-9dB, -6dB, -3dB, 0dB, 3dB) then press the  button again to confirm it or press on Mute button to exit the setting.





Transmitter RF Power adjust:

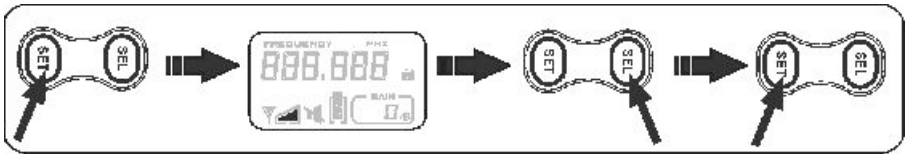

Press  twice, the signal icon  flashes, press the  button to change the relative output level in mW. (5mW, 10mW, 20mW) then press  again to confirm it or press on Mute button to exit the setting.

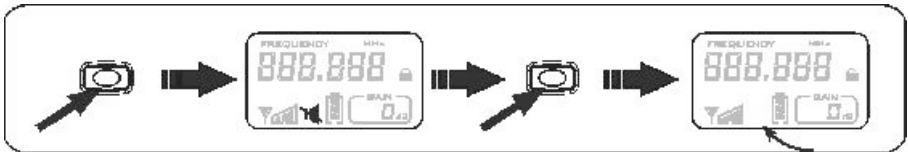

Mute setting:

Press  once, the transmitter will be muted right away and the icon  displayed, press one more time to unmute it.



* Button  on handheld microphone has an identical function as the button  on bodypack transmitter.

Handheld and Bodypack Transmitter

Current Frequency Checking:

Press **(SEL)** button to show the current frequency, press **(SEL)** to return.

If no operation was performed within 5 seconds, the display will return back to normal display automatically.



Battery Status Indicator:

When the battery is low, the display shows an empty flashing battery icon . The battery status of transmitter and receiver is synchronized.

When the battery is lower than 1.6V, an empty battery icon and Lo will appear on the display for about three seconds, then an internal control circuit will force the transmitter into off state automatically.

We recommend users change to a pair of new batteries when the battery icon shows as 30%.

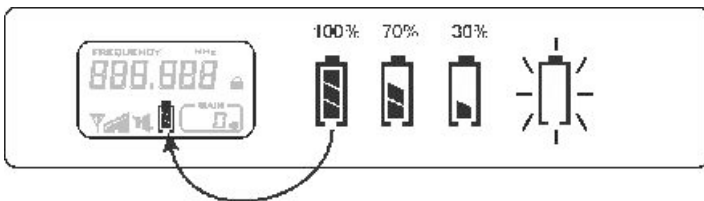

Lock and Unlock Setting:

Press **(SEL)** button and hold it until LCD shows "🔒". At this time, all buttons except Power on/off will be disabled. All transmitter's functions are now locked.

Press **(SEL)** and **(SEL)** buttons continuously back and forth (as shown below) three times to unlock.

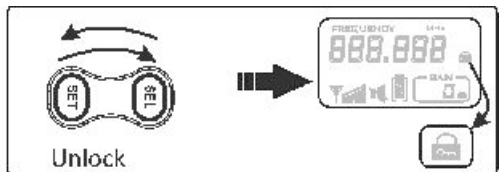
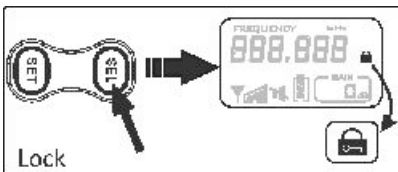

Tips for Improving System Performance

- Maintain a line of sight between transmitter and antenna.
- Avoid placing the receiver near metal surfaces or any digital equipment (CD players, computers, etc).
- Keep the receiver away from the wall and over 1m to the ground.
- Cellular telephones, two-way radios and other RF transmitters can interfere with the transmitting frequencies, maintain a distance from interfering equipment.

Troubleshooting

Issue	Indicator Status	Solution
No sound or faint sound.	Transmitter ON Indicator stop flashing	Turn on transmitter. Make sure the +/- indicator on battery match the transmitter terminals
	Power indicator off	Make sure AC adapter is securely plugged into electrical outlet and into DC input connector on rear panel of receiver.
	Receiver RF indicator glows	Turn the receiver up Turn up the Gain adjustment switch in the transmitter Check the power connection of the receiver and amplifier or mixer
	Receiver RF indicator off, transmitter indicator ON	Take the receiver away from the metal objects Check whether there are obstructions between receiver and transmitter Move the transmitter near the receiver Check the receiver and transmitter whether use the same frequency
	Transmitter low battery indicator ON	Change the batteries in transmitter.
Distortion or unwanted noise bursts.	Receiver RF indicator ON	Remove nearby sources of RF interference (CD players, computers, in-ear monitor systems, etc.)
Distortion level increases gradually.	Transmitter low battery indicator ON	Replace Transmitter batteries.
Sound level different from cabled guitar or microphone, or when using different guitars.		Adjust Transmitter Gain and Receiver Volume as necessary.

Specifications

CTSR System:

Available Channels: 920 Selectable Frequencies
(18 groups of 14 channels)

Band: UHF Frequency

Operating Range Under Typical Conditions: 300'

Audio Frequency Response: 60Hz - 16KHz

Note: battery characteristics may limit this range.

Receiver: CTSR

Frequency Range: CODE D 584~607 MHZ
CODE L 655~679 MHZ

Channels: 920 Selectable Frequencies
(18 groups of 14 channels)

Power Requirements: 12Vdc, 500mA

Bandwidth: 24 MHz

Sensitivity: -102 dBm

Signal-to-noise ratio: >105 dB(A)

Frequency Response: 60 Hz - 15 KHz

Output Level: 8 dBu Max

Output Connections: Balanced XLR,
Unbalanced 1/4"

IR Sync transmitter with receiver

Dimensions: 8.34" W x 6.29" D x 1.73" H
(212mm x 160mm x 44mm)

Weight: 1.98 lbs (900g)

Handheld Transmitter: HH85

Polar Pattern: Cardioid

Element Type: Dynamic

LCD Display: Frequency, Battery Life,
Mute, Gain, RF Power, Lock

Selectable Power: 5, 10, 20mW

Selectable Gain: -3, 0, 3, 6, 9

Power Requirements: 2 "AA" Batteries alkaline
or rechargeable batteries

Battery Life: About 8 Hrs dependent on power setting

Dimensions: 9.68" x 2.08" (246mm H x 53mm W)

Weight: 8.8oz (250g)

Bodypack Transmitter: MBP85

Frequency Range: CODE D 584~607 MHZ
CODE L 655~679 MHZ

LCD Display: Frequency, Battery Life,
Mute, Gain, RF Power, Lock

Selectable Power: 5, 10, 20mW

Selectable Gain: -3, 0, 3, 6, 9

Power Requirements: 2 "AA" size alkaline or
rechargeable batteries

Battery Life: About 8 Hrs dependent on power setting

Dimensions: 3.85" W x 2.51" H x 0.90" D
(98mm x 64mm x 23mm)

Weight: 3.17oz. (90g)

AMY SPOT[®]

WIRELESS SYSTEMS

Galaxy Audio CODE D Frequency Chart

Frequency Ranges:
CODE D 584-607 MHz



	TVCh 34-34	TVCh 34-35	TVCh 35-36	TVCh 33-35	TVCh 34-36	TVCh 33-38	TVCh 33-38	TVCh 33-36	TVCh 33-35	TVCh 34-36	TVCh 33-38	TVCh 33-38	TVCh 33-36	TVCh 33-36	TVCh 33-38	TVCh 33-36	TVCh 33-36	TVCh 33-36	TVCh 33-36	
Channel	Group 1	Group 2	Group 3	Group 4	Group 5	Group 6	Group 7	Group 8	Group 9	Group 10	Group 11	Group 12	Group 13	Group 14	Group 15	Group 16				
Ch 1	584.100	590.150	596.700	584.050	590.200	584.550	585.100	584.725	584.650	590.375	584.300	584.150	584.050	584.325	584.900	584.125				
Ch 2	584.225	590.475	597.775	584.375	594.525	585.550	585.550	585.750	585.350	585.375	585.225	585.150	584.675	584.675	585.050	584.150				
Ch 3	585.000	590.975	598.075	585.300	591.250	586.300	586.100	587.750	586.975	587.650	585.850	585.825	585.950	588.350	586.975	588.350				
Ch 4	585.475	591.925	598.625	586.125	589.100	587.000	587.000	589.100	587.600	587.600	587.025	586.550	586.275	588.150	588.700	587.650				
Ch 5	586.225	582.250	589.850	586.750	582.725	589.800	587.475	589.675	589.075	589.075	587.625	587.175	587.650	589.150	589.150	589.150				
Ch 6	587.100	593.275	600.450	587.275	593.425	590.000	588.200	590.250	589.850	593.450	588.100	587.375	588.200	589.425	590.575	589.625				
Ch 7	587.575	594.450	600.800	587.575	593.750	590.650	589.125	590.650	590.200	595.050	588.950	588.350	589.175	590.475	590.975	590.800				
Ch 8	588.175	595.150	601.375	587.975	594.525	591.450	589.125	590.950	590.950	595.525	589.650	588.575	589.475	591.300	592.225	591.775				
Ch 9	588.475	596.300	602.400	588.525	594.875	592.100	590.625	592.300	591.875	596.850	591.075	589.950	590.600	591.775	592.700	593.100				
Ch 10	590.500	597.300	602.700	588.875	595.450	593.000	591.075	592.600	592.625	597.775	591.500	591.375	590.925	592.550	593.075	593.600				
Ch 11	590.550	597.725	603.325	589.350	596.875	593.425	591.400	593.775	592.925	599.125	592.150	592.025	591.875	592.980	594.250	594.300				
Ch 12	591.225	598.525	603.700	589.675	602.025	594.050	591.825	594.250	593.725	599.600	595.025	592.350	594.025	593.675	594.650	594.900				
Ch 13	591.725	598.975	604.500	596.100	602.700	594.500	592.875	594.150	594.375	599.925	594.200	594.250	594.675	594.000	596.400	595.725				
Ch 14	592.075	599.550	605.100	596.525	603.025	595.500	593.575	596.000	595.275	600.825	595.625	594.250	595.450	595.175	597.225	596.300				

Galaxy Audio CODE L Frequency Chart

Frequency Ranges:
CODE L 655-679 MHz

	TVCh 44-46	TVCh 45-47	TVCh 46-48	TVCh 44-47	TVCh 45-48	TVCh 44-48	TVCh 44-48	TVCh 44-48	TVCh 44-48	TVCh 44-48	TVCh 44-48	TVCh 44-48	TVCh 44-48	TVCh 44-48	TVCh 44-48	TVCh 44-48	TVCh 44-48	TVCh 44-48	TVCh 44-48	
Channel	Group 1	Group 2	Group 3	Group 4	Group 5	Group 6	Group 7	Group 8	Group 9	Group 10	Group 11	Group 12	Group 13	Group 14	Group 15	Group 16				
Ch 1	655.30	658.80	663.95	655.05	658.33	655.72	655.20	656.20	655.95	657.55	655.13	655.10	655.55	655.55	655.25	655.03				
Ch 2	655.90	659.10	667.05	658.20	658.55	656.10	656.73	656.73	656.88	657.90	655.55	657.18	657.50	655.80	655.00	655.70				
Ch 3	657.88	660.75	667.45	658.75	659.93	657.85	656.53	657.70	658.38	659.70	656.53	659.53	657.93	656.15	657.00	657.70				
Ch 4	659.68	662.93	668.48	659.75	662.18	659.20	658.88	658.10	659.38	660.00	657.13	660.88	658.48	656.65	658.80	659.80				
Ch 5	659.68	663.73	668.78	660.60	665.85	659.78	659.58	659.10	659.75	661.05	658.13	661.05	658.63	657.25	658.65	659.20				
Ch 6	660.55	665.23	670.00	663.83	666.58	660.23	659.90	662.03	662.05	661.70	658.60	662.08	660.75	658.08	660.18	660.18				
Ch 7	660.55	666.20	670.33	664.20	667.68	660.28	660.63	662.93	662.93	662.78	659.23	662.78	661.70	659.05	659.65	660.85				
Ch 8	661.23	666.10	672.08	664.68	669.65	662.95	661.08	662.10	663.40	663.08	660.58	662.18	660.58	660.68	659.95	661.35				
Ch 9	662.98	669.88	673.80	666.28	670.73	663.90	661.80	663.28	664.20	664.08	660.88	663.68	663.18	661.33	661.63	662.03				
Ch 10	663.35	670.25	673.73	668.55	671.45	664.48	662.40	663.90	664.90	664.75	662.25	664.35	663.18	662.10	661.15	662.45				
Ch 11	664.93	670.73	674.35	670.00	672.08	665.48	662.73	665.15	666.35	666.30	662.65	664.88	663.75	662.65	663.05	665.75				
Ch 12	665.95	671.03	676.28	671.03	673.03	665.78	663.50	665.48	666.70	667.45	663.73	665.50	663.13	663.38	665.45	666.58				
Ch 13	666.78	672.30	677.30	673.60	673.75	666.88	664.48	666.68	667.88	668.88	664.23	666.90	666.08	664.90	667.03	667.20				
Ch 14	667.95	673.78	677.80	688.25	678.85	667.23	665.33	667.35	668.30	669.18	665.10	667.55	666.60	665.65	667.55	667.55				



MAKERS OF THE ORIGINAL
HOT SPOT PERSONAL MONITOR



www.galaxyaudio.com

THREE YEAR LIMITED WARRANTY

WARRANTY Information can be viewed online at
<http://www.galaxyaudio.com/warranty.php>



www.galaxyaudio.com/warranty.php

CTS **USER'S MANUAL**

Specifications in this manual are subject to change without notice.
For the most up to date manual and information
visit www.galaxyaudio.com.

1-800-369-7768 www.galaxyaudio.com

© Copyright Galaxy Audio 2012