

SOUND DEVICES



PIX 260i

User Guide and Technical Information

Firmware rev. 1.01

Sound Devices, LLC

E7556 State Rd. 23 and 33 • Reedsburg, WI • USA

+1 (608) 524-0625 • fax: +1 (608) 524-0655

Toll-Free: (800) 505-0625

www.sounddevices.com

support@sounddevices.com

Table of Contents

Introduction	1	Fostex DV40	27
Manual Conventions	1	47.952k and 47.952kF	27
Video Mode and Audio Mode	1	Video Scaling and Frame Rate Conversion	28
Panel Descriptions	2	3:2 Pulldown Removal	28
Front Panel	2	Up and Down Conversion	29
Rear Panel	3	Down-Conversion	29
PIX-CADDY 2 (Optional)	5	Up-Conversion	30
Menu and Navigation	6	Playback	31
LCD	6	Playback Operation	31
Main View	6	Fast Forward and Rewind	31
On-screen Display	6	File Skip	31
Menu	8	Shuttle Playback Mode	31
Audio Screen	8	Cue Marker	32
File List	9	Cue Marker Looping	32
File Details	11	Play List	33
Inputs and Outputs	12	Playback Mode	34
Video Inputs	12	Playback Rate of Audio Files	34
HDMI	12	Non-Native File Playback	34
SDI	12	Exporting QT Files for 260i Playback	35
Video Outputs	12	Playing Back Files on a Computer	35
Audio Inputs	13	Synchronization and Timecode	36
Analog Audio Inputs	13	Sync Reference	37
XLR (1-2)	13	Video Mode Synchronization	37
DB25 (1-8)	13	Audio Mode Synchronization	37
Digital Audio Inputs	13	Timecode Reader	37
HDMI / SDI Embedded Audio	13	Internal Ambient® Lockit: Timecode Generator with Sync Out38	
AES3	13	Setting the Sync Out	38
Dante Audio Inputs	14	Timecode Modes	38
Dante Redundancy	15	Freerun Timecode Mode	38
Sample Rate Converters	15	Record Run Timecode Mode	38
Choosing Audio Sources	15	External Timecode Mode	39
Input Level Control	15	Timecode Frame Rate	39
Input Delay Control	16	Timecode Input Sources	39
Audio Outputs	16	Timecode BNC	39
Analog Audio Outputs	16	SDI or HDMI Input Embedded Timecode	39
Digital Audio Outputs (AES/HDMI)	16	Synchronization/Timecode Examples	39
Dante Audio Outputs	16	Single Video Camera, no Genlock	39
SDI Audio Outputs	16	Single Camera with Genlock Input, Genlocked from PIX	40
Headphone Output	16	Multiple Cameras with Genlock Input, all Genlocked from a Single PIX	40
Ethernet	18	Camera #1 to PIX #1, Camera #2 to PIX #2, No Genlock	41
Video Monitoring Features	19	Camera to PIX with Word Clock Connection to Audio Recorder41	
Exposure Assist	19	External Control	42
False Color	19	RS422	42
Zebras	20	PIX Grouping	42
Focus Assist	21	Group Transport	42
Peaking	21	Non-Grouping Settings and Functions	42
Edge Enhance	22	Web Interface - PIXNET	43
Zoom	23	PIXNET All Units Page	43
Flip Display	23	PIXNET Unit Page	44
Recording	24	PIXNET Unit Page Main View and Menu Tabs	45
Selecting Video File Resolution and Frame Rate	25	Main View	45
Progressive Segmented Frames (PsF)	25	Clips Menu	45
Selecting a Video Codec	25	File Storage Menu	45
Interruption of Signal During Recording	26	Video Menu	45
Alignment of Audio and Video	26	Audio Menu	45
Audio Track Arming	26	TC Menu	46
Audio Mode	26	OSD Menu	46
F Sampling Rate Modes	27	Remote Menu	46
48.048k and 48.048kF	27	Network Menu	46

System Menu	46	Audio	59
Triggering Recording from External Timecode	46	Timecode/Sync	60
Triggering Recording from SDI Flag Bits	47	LCD Monitor	62
GPIO (General Purpose Input / Output)	47	On-Screen Display	62
USB Keyboard	47	Remote Control	63
Storage and File Management	49	Network	63
Storage	49	System	64
PIX-CADDY	49	Quick Setup	65
eSATA	49	Button Shortcuts	65
Supported Storage Devices	49	Connector Pin Assignments	66
Formatting	49	Appendix A - Supported Files	69
Target Storage Device for Recording	50	Specifications - PIX 260i	70
Metadata	50	SDI	70
CamID	50	HDMI	70
Reel	50	Video Input Resolutions / Rates	70
Clip	50	Video Codecs and Files	70
Scene/Shot	50	Up/Down/Cross Conversion	70
Take	51	Frame Rate Conversion	70
Audio Track Name (Audio Only)	51	LCD	70
File Management	51	Audio Recording	70
File Size Limit	51	Analog Audio	71
File Naming	51	Digital Audio	71
RED File Format	51	File Storage	71
Arri File Format	52	Timecode and Sync	71
Folder Structure	52	Control	72
Deleting a File	52	Keyboard	72
Transferring Files	52	Power	72
USB, Firewire, Thunderbolt	52	Physical	72
Ethernet File Transfer (Samba)	53	PIX 260i CE Declaration of Conformity	73
Setup Management and Firmware Upgrades	54	CE - CISPR Publication Dates	74
Saving and Loading Setup Files	54	Software License	75
Custom Default Settings and Setup Menu Option Visibility	54	Warranty and Technical Support	76
Firmware Upgrades	56	Warranty & Service	76
Setup Menu Options	57	Technical Support / Bug Reports	76
Video/Audio Mode	57		
File Storage	57		
Video	58		

Copyright Notice and Release

All rights reserved. No part of this publication may be reproduced, stored in a retrieval system, or transmitted in any form or by any means, electronic, mechanical, photocopying, recording, or otherwise, without the expressed written permission of SOUND DEVICES, LLC. SOUND DEVICES is not responsible for any use of this information.

SOUND DEVICES, LLC shall not be liable to the purchaser of this product or third parties for damages, losses, costs, or expenses incurred by purchaser or third parties as a result of: accident, misuse, or abuse of this product or unauthorized modifications, repairs, or alterations to this product, or failure to strictly comply with SOUND DEVICES, LLC's operating and installation instructions.

Microsoft Windows is a registered trademark of Microsoft Corporation. Macintosh, OSX, and ProRes are registered trademarks of Apple, Inc. DNxHD is a registered trademark of Avid, Inc. Other product and company names mentioned herein may be the trademarks of their respective owners.

PIX 260i, and the sound waves logo are registered trademarks of Sound Devices, LLC.

Introduction

The PIX 260i is a rack-mountable, production video recorder with extensive audio and video processing capabilities. The foundation of the PIX 260i is hardware-based, 10-bit video up/down/cross conversion, and hardware-based encoding to Apple ProRes and Avid DNxHD codecs (both at up to 12 bit 4:4:4). These features allow for fast, reliable acquisition of video (at any standard HD or SD resolution and frame rate) and audio (up to 32 tracks from Analog, AES, HDMI, SDI, or Dante sources) to ready-for-edit, industry standard Quicktime .mov files.

Files are recorded simultaneously on (up to) 4 separate, 2.5" SSD storage devices via two front panel PIX-CADDY slots and two rear panel eSATAp connections. This redundancy in local, removable storage devices, coupled with standard, Ethernet-based file transfer features further reduces steps in the production workflow. Gigabit Ethernet network ports enable remote access to recorded files and the ability to transfer them quickly into a post-production environment.

Full-featured precision timecode and sync reference I/O using Ambient Lockit core technology is provided to allow tight synchronization with external equipment in complex multi-machine configurations. The PIX 260i supports various external control options: RS422, GPIO, SDI flags, Timecode triggering, and an embedded web server for network-based remote control.

This User Guide details installation and operation of the PIX 260i. This User Guide corresponds to PIX 260i firmware version 1.010. User Guide revisions are released at the same time as firmware updates and available online:

<http://www.sounddevices.com/products/pix260i/downloads/>

Manual Conventions

Several formatting features have been included to make navigating the guide easier.

- Setup Menu items are indicated with this text: **[Menu Category - Parameter]**, where the menu category is one of the items in the list displayed when the Menu button is pushed, and the parameter is an item in the list displayed when that category is selected (by pushing in on the Control Knob).
- Terms that refer to specific controls or functions (such as Control Knob, Menu Button, Setup Menu, etc) are capitalized. These terms are described elsewhere in this user guide (see the Panel Descriptions section).
- *Blue italicized* text references sections of the user guide containing contextually relevant information.

Video Mode and Audio Mode

Throughout this User Guide, the terms Video Mode and Audio Mode will be used. The PIX 260i is capable of recording video and audio together into a Quicktime .mov file (Video Mode) or recording audio only to a .wav file (Audio Mode). The mode is determined by the Setup Menu option **[Video/Audio Mode - Video/Audio Mode]**. When set to **[Video + Audio (Quicktime)]**, the PIX 260i is in Video Mode. When set to **Audio Only (Wave)**, the PIX 260i is in Audio Mode.

Panel Descriptions

Front Panel

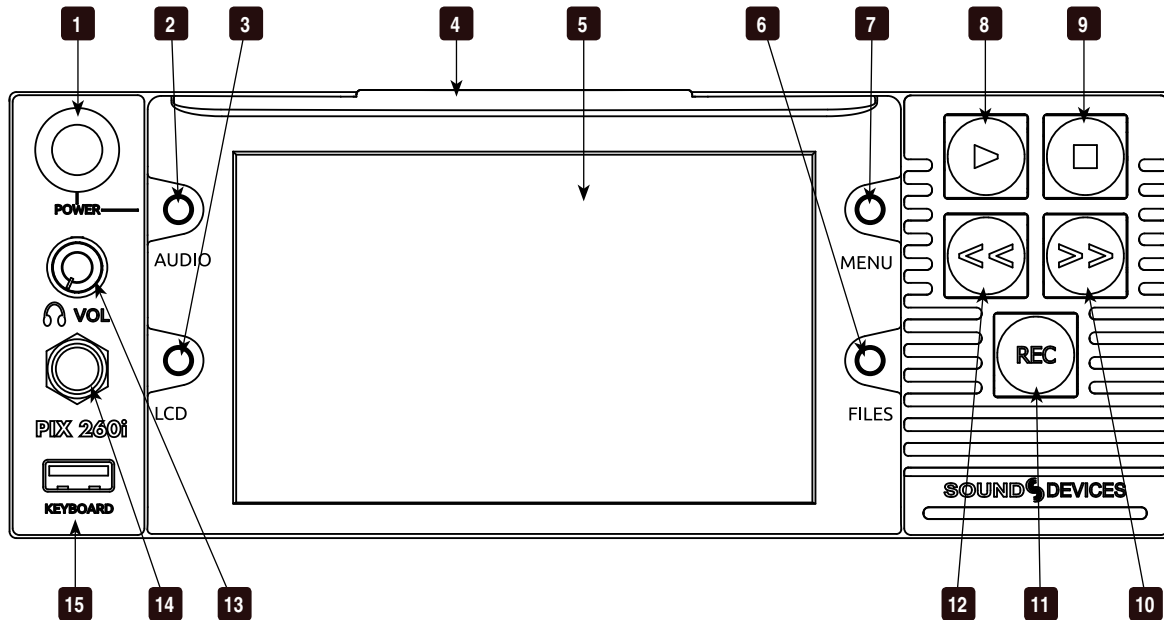

- 1) **Control Knob**
The Control Knob can be both turned and pressed. Use the Control Knob to navigate between menu settings and to select menu items. Pressing during playback or stop will toggle to Shuttle mode. Turning while playback is paused will jog forward or backward by single frames.
- 2) **Audio Button**
Displays the Audio Screen. From the Audio Screen: Select audio input sources, Arm/disarm tracks, Set audio input gain and delay, View audio input levels, and Edit audio track names.
- 3) **LCD Button**
Toggles the On-Screen Display. Hold for 2 seconds to toggle LCD on/off.
- 4) **Handle**
This handle is designed to provide a gripping point for tilting down the LCD.
- 5) **LCD Display**
Displays operating information when the On-Screen Display (OSD) is active (*see On-Screen Display*), user interface, source video, and playback video. 5-inch display; 800x480 resolution.
- 6) **Files Button**
Displays the File Browser Screen. Press during record or playback to add a Cue Marker, press and hold to delete a Cue Marker (Video Mode).
- 7) **Menu Button**
Displays the Setup Menu.
- 8) **Play Button**
Plays the most recently recorded file when pressed. In the File List View, plays the selected video file from the File List. Pauses video during playback. Press and hold Play to activate Loop Play.
- 9) **Stop Button**
Stops an active recording or playback. When Stopped, hold the Stop button to display the next filename.
- 10) **Fast-Forward Button**
When Stopped, press Fast-Forward to cue up the next file for Playback. During Playback or Pause, press once to jump to the next Cue Marker, press and hold to increase playback speed. Continue to hold for faster speeds.

11) **Record Button**

Begins recording. *Optional:* Splits the recording and begins writing a new file when pressed while recording.
[System - Rec Button File Split]

12) **Rewind Button**

When Stopped, press Rewind to cue up the previous file for Playback. During Playback and Pause, press once to jump to the previous Cue Marker or beginning of the file, press and hold to reverse playback speed. Continue to hold for faster reverse speeds.

13) **Headphone Volume Knob**

Adjusts the overall volume of the headphones. NOTE: the headphone output is capable of ear-damaging levels. Take care when adjusting among signal sources.

14) **Headphone Output 1/4"**

TRS stereo headphone connector. Can drive headphones from 8 to 100 ohms to very high headphone levels.

15) **USB Keyboard Input**

USB A female connector to connect a USB keyboard. Keyboards can be used to navigate, control, and enter metadata into the PIX 260i. Keyboards with integrated USB hubs are not compatible.

Rear Panel

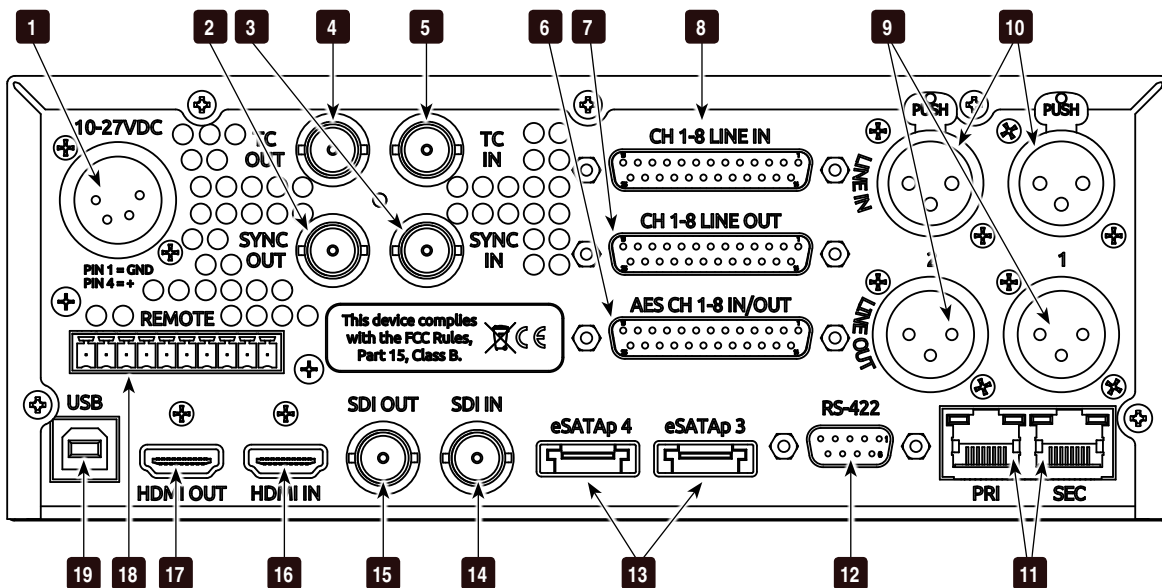
1) **DC Power Input (XLR 4-pin)**

Accepts 10–27 volts DC. XLR 4-pin connector is wired pin-1 ground, pin-4 positive (+).

2) **SYNC Output (BNC)**

Selectable genlock or wordclock output. Configured with Setup Menu option [Timecode/Sync - Sync Out].

3) **SYNC Input (BNC)**

Wordclock input. Configured with Setup Menu options [Timecode/Sync - Sync Ref - Audio Only]

4) **Timcode Output (BNC)**

SMPTE timecode output.

5) **Timcode Input (BNC)**

SMPTE timecode input.

6) **Digital Audio Input/Output (DB-25)**

8 channels of AES digital audio input and 8 channels of AES digital output. *See Pinout section for wiring details*

7) **Ch. 1-8 Analog Audio Output (DB-25)**

8 channels of balanced, line-level analog audio output. *See Connector Pin Assignments*

8) **Ch. 1-8 Analog Audio Input (DB-25)**

8 channels of balanced, line-level analog audio input. *See Connector Pin Assignments*

- 9) **Analog Audio Outputs (XLR)**
2 channels of balanced, line-level analog audio outputs.
- 10) **Analog Audio Inputs (XLR)**
2 channels of balanced, line-level analog audio inputs.
- 11) **Ethernet (RJ-45)**
Attaches to 1G or 100M Ether networks. Provides Dante connectivity (*see Dante*), web access for remote control (*see Web Control*), and network file service. *see File Management*
- 12) **RS-422 Control (DB-9)**
Connects to RS-422 Controllers for external control of the PIX 260i. *See RS-422*
- 13) **External Drive Connections (eSATAp)**
Connector for approved 2.5-inch SATA drives. Sound Devices maintains a list of tested and approved SSD drives for use with PIX video recorders. Visit www.sounddevices.com/approved for an up-to-date list of tested and approved drives.
- 14) **SDI Video Input (BNC)**
SDI video input. Accepts 3G-SDI, HD-SDI, or SD-SDI signal with up to 16 channels of embedded audio.
- 15) **SDI Video Output (BNC)**
SDI video output. Provides 3G-SDI, HD-SDI, or SD-SDI signal with up to 16 channels of embedded audio.
- 16) **HDMI Video Input (HDMI)**
Accepts HDMI (1.4a) signal with 8 channels of embedded audio. The PIX 260i does not record or display content encoded with HDCP.
- 17) **HDMI Video Output (HDMI)**
Provides HDMI (1.3) signal with 8 channels of embedded audio.
- 18) **GPIO Remote (Phoenix 10-pin)**
Logic contact points for remote control. *See GPIO*
- 19) **USB Connection**
Factory use only.

PIX-CADDY 2 (Optional)

The PIX-CADDY 2 is an accessory to connect approved 2.5" drives to the front-panel drive bays. When removed from a PIX 260i, the PIX-CADDY 2 operates as a high-speed drive interface to Mac OS and Windows computers via the onboard FireWire800, USB 3.0, or the optional PIX-DOCK Thunderbolt interface.

For reliable operation, it is imperative that the 2.5" drive be firmly screwed to the PIX-CADDY 2 with the supplied screws.

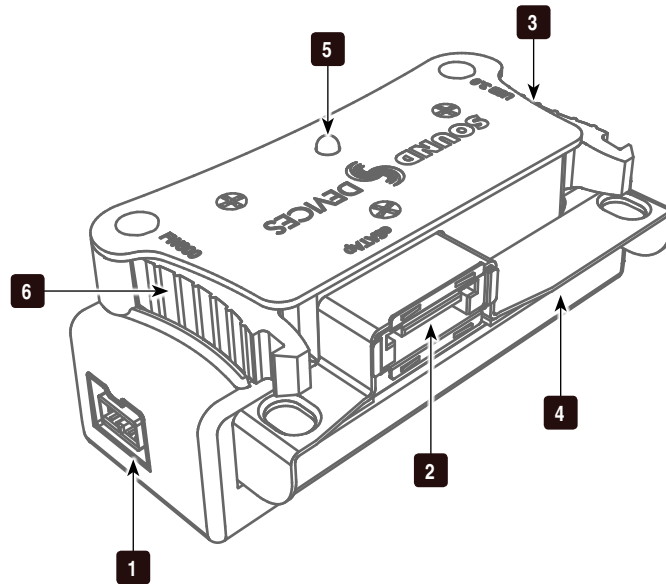

- 1) **FireWire 800**
FireWire 800 or 400 (backward compatible). Requires a powered FireWire 800 or 400 port.
- 2) **eSATAp**
High-speed data transfer over 5V eSATAp. Requires a 5V powered eSATAp port.
- 3) **USB 3.0**
High-speed data transfer over USB 3.0 (backward compatible with USB 2.0).
- 4) **2.5" Drive Slot**
Connector for approved 2.5-inch SATA II and SATA III drives. Sound Devices maintains a list of tested and approved SSD drives for use with PIX video recorders. Visit www.sounddevices.com/approved for an up-to-date list of tested and approved drives.
- 5) **Activity LED**
Illuminates when recording, playing, reading, or writing to the attached 2.5" drive. Do not remove the caddy while the Activity LED is illuminated. *LED does not illuminate when connected to a computer's eSATA port.*
- 6) **Release Latches**
Secures the PIX-CADDY to the recorder. Press both latches to remove the caddy assembly.
- 7) **Screw Holes**
For reliable operation, it is imperative that the 2.5" drive be firmly screwed to the PIX-CADDY 2 with the supplied screws.

Menu and Navigation

LCD

From the Main View, press the LCD button to toggle the On-Screen Display (OSD) on or off, press and hold the LCD button for two seconds to turn off the LCD, press again to turn on. From all other views, press the LCD button to return to the Main View.

The LCD Control Panel provides adjustments to the LCD backlight, button backlight, image brightness, image contrast, and image chroma. To access the LCD Control Panel, hold down the LCD button then press the Control Knob. The parameter with the orange slider bar is the selected parameter. To toggle through the parameters press the Control Knob, to adjust the setting turn the Control Knob. Press LCD again to exit back to the Main View.

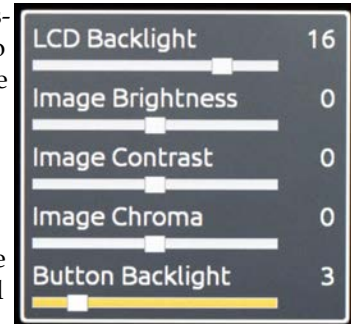

Main View

The Main View displays the live or playback video and the On-screen Display. The Main View is the default view which appears when no other views or menus are selected.

On-screen Display

The On-screen Display (OSD) provides information superimposed over the Main View. From the Main View, the LCD button will toggle the OSD on and off. Items included in the OSD are configured with the Setup Menu option **On-Screen Display**. When factory settings are loaded from the **Quick Setup** menu item all OSD items are shown.

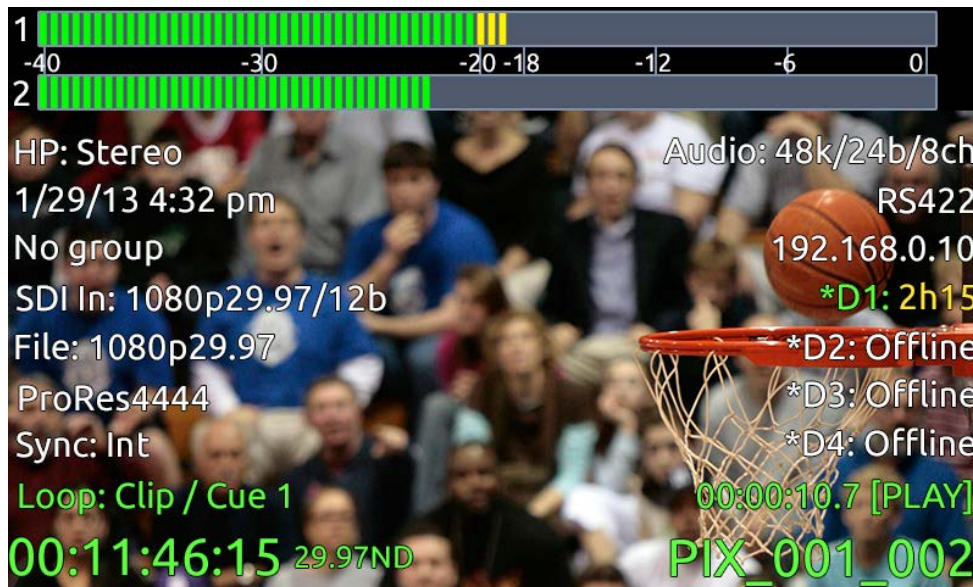

On-screen Display Menu

Item	Description
1. ABS Time	Absolute Time: Displays the elapsed time of the file being recorded or played and the transport status (Stop, Rec, Play, FF, and REW).
2. File Codec	The presently selected video codec (Video Mode) or when in Audio Mode the OSD will display "Audio Only". This information will update for recording and playback.
3. File Name	Name of the current file. Pressing STOP shows the next file name
4. File Resolution/Rate	Displays the resolution and frame rate of the file being recorded or played (Video Mode). In Audio Mode the file type (WAV) is displayed. The File Resolution/Rate field is displayed in different colors to indicate conversion methods. <i>See Video Scaling and Frame Rate Conversion</i>
5. Audio Source	Audio sample rate, bit depth, and channel count. In Audio Mode, flashes red to indicate [Audio - Sample Rate] does not match [Timecode/Sync - Sync Ref - Audio Only] .
6. Input - Video	Resolution and frame rate of the incoming video input.
7. Headphone Source	Current headphone routing selection.
8. Audio Metering	Levels of audio inputs 1 and 2.
9. Time/Date	The current time and date.
10. Timecode	Current timecode and frame rate of the recorder or playing file.
11-14. Drive 1-4 (D1-D4) status	Displays the status and remaining record time of each drive (when video input is present or in Audio Mode) or remaining space in GB (when no video input is present), "Offline" (when no media is present), "Mounting" (when media is becoming ready), "No Fmt" (when media is not formatted), or "Network" (when [Network - Ethernet File Transfer] is set to On). An asterisk indicates that the drive is On in [File Storage - Record to Drive] when recording or stopped. When recording all drives that are recording are displayed in red. When Stopped or in Playback, the green drive is the current default playback drive. Drive status field is orange when a drive is being accessed for writing or reading.
15. RS422 Status	RS422 is displayed when [Remote Control - RS422] is on.
16. Cue Marker	Cue marker and playback looping information is displayed here during record and playback.
17. Sync Reference	The current source of synchronization. This information will update for recording and playback.
18. Group Number	Displays the selected network group in [Network - Network Group] .
19. IP Address	Network IP address of the PIX 260i

Target drives, ABS Time, File Name, Timecode, and Cue Marker OSD fields change colors to indicate the various transport states, White = Stopped, Red = Record, Green = Play/Pause, Blue = REW/FF/Shuttle.

Menu

Press the MENU button (keyboard: F1) to enter the Setup Menu. Most settings of the PIX 260i are accessed and changed from the Setup Menu. Navigate between menu items by turning the Control Knob and pressing it to select. When in a menu, press the MENU button to go back to the previous screen. *See Setup Menu Options* for a complete list of all available options.

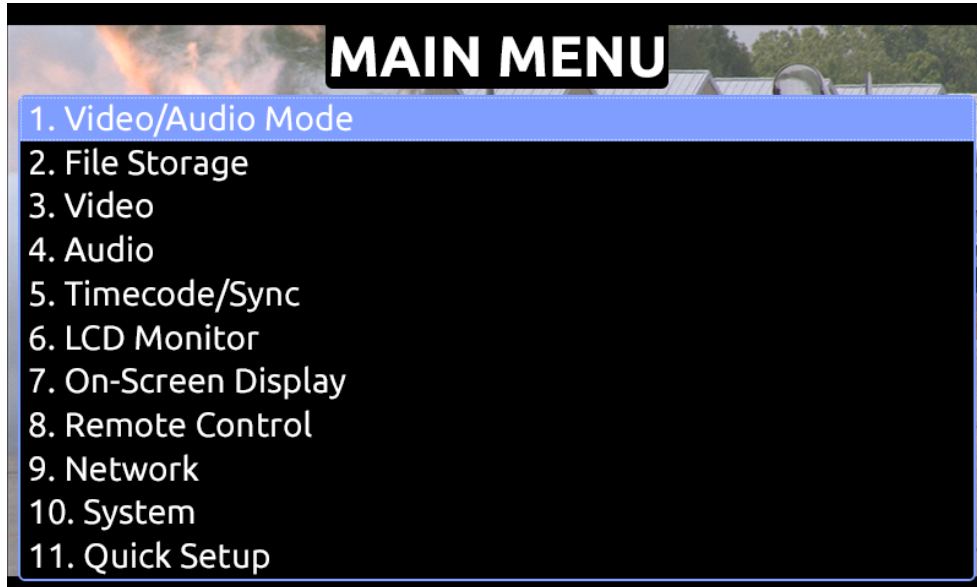

The Setup Menu is not accessible when in Record or Playback. If the Setup Menu is open when record or playback is engaged, the Setup Menu will close and return to the Main View.

Audio Screen

Press the AUDIO button (keyboard: F3) to enter the Audio Screen. The Audio Screen displays all audio input levels and provides configuration of Track Arming, Track Naming, Input Source selection, Input Gain, and Input Delay. Turn the Control Knob to move the blue highlighter vertically and press the FF and RW buttons to move the highlighter horizontally. Press the Control Knob to edit the highlighted setting, press again to save and exit. To exit the Audio Screen press either the Audio or LCD buttons.

When transport is stopped, holding the Stop button while the highlighter is on a Track Name or Input Source field will display the full name of that field. When recording or playing back, pushing the Stop button in the Audio Screen will stop playback.

The Audio Screen by default displays 16 tracks at a time. This can be changed to 8, 16, or 32 track displays in [Audio - Audio Screen Meters].

Arm	Name	Source	Gain	Delay	-40	-30	-20	-18	-12	-6	0
1	Track 01	Line In 1	0.0	0							
2	Track 02	Line In 2	0.0	0							
3	Track 03	Line In 3	0.0	0							
4	Track 04	Line In 4	0.0	0							
5	Track 05	Line In 5	0.0	0							
6	Track 06	Line In 6	0.0	0							
7	Track 07	Line In 7	0.0	0							
8	Track 08	Line In 8	0.0	0							
9	Track 09	HDMI/AES In 1	0.0	0							
10	Track 10	HDMI/AES In 2	0.0	0							
11	Track 11	HDMI/AES In 3	0.0	0							
12	Track 12	HDMI/AES In 4	0.0	0							
13	Track 13	HDMI/AES In 5	0.0	0							
14	Track 14	HDMI/AES In 6	0.0	0							
15	Track 15	HDMI/AES In 7	0.0	0							
16	Track 16	HDMI/AES In 8	0.0	0							

Other audio related settings are accessible from the Setup Menu option **Audio**.

File List

Press the FILE button (keyboard: F2) to display the File List; A list of all of the clips. Clips are arranged chronologically and grouped by Reel. Turn the Control Knob to highlight an item. Press Play to start playback of the highlighted clip. Press the Control Knob to perform functions based on which item is highlighted:

Reel group
Number of clips in the reel indicated in brackets. Press Control Knob to expand or collapse.

Clip
Single file clip. Press Control Knob to view details. Press Play to play.

Multi-file Clip
Multi-file clip. Number of files in the clip indicated in brackets. Press Control Knob to expand or collapse. Press Play to play first clip.

File
File of a multi-file clip. Only shown when clip is expanded. Press Control Knob to view details. Press Play to play.

Drive 2 FILE LIST

Reel 002 [3]		Jan 25, 9:49AM	3.14GB
PIX260_PIX_001_001.mov		Jan25, 9:49AM	1.10GB
PIX260_PIX_001_002.mov		Jan 25, 3:00PM	1.02GB
PIX260_PIX_001_003.mov		Jan 23, 10:15PM	1.02GB
Reel 001 [4]		Jan 22, 8:13AM	6.10GB
PIX260_PIX_001_005.mov		Jan 22, 8:13AM	2.90GB
PIX260_PIX_001_006.mov [2]		Jan 22, 7:02AM	3.20GB
PIX260_PIX_001_006a.mov			1.05GB
PIX260_PIX_001_006b.mov			2.15GB
PIX260_PIX_001_009.wav		Jan 17, 1:15PM	1.35GB
PIX260_PIX_001_010.wav		Jan 17, 8:13AM	3.55GB

Drive 2 FILE LIST

Reel 002 [3]	Jan 25, 9:49AM	3.14GB
PIX260_PIX_001_001.mov	Jan25, 9:49AM	1.10GB
PIX260_PIX_001_002.mov	Jan 25, 3:00PM	1.02GB
PIX260_PIX_001_003.mov	Jan 23, 10:15PM	1.02GB
Reel 001 [4]	Jan 22, 8:13AM	6.10GB
PIX260_PIX_001_005.mov	Jan 22, 8:13AM	2.90GB
PIX260_PIX_001_006.mov [2]	Jan 22, 7:02AM	3.20GB
PIX260_PIX_001_006a.mov		1.05GB
PIX260_PIX_001_006b.mov		2.15GB
PIX260_PIX_001_009.wav	Jan 17, 1:15PM	1.35GB
PIX260_PIX_001_010.wav	Jan 17, 8:13AM	3.55GB

Creation Time/Date
Reel Folder or file creation time and date.

File Size
Size in GB of a single clip or file.

Reel Size
Total size in GB of the entire Reel folder.

Multi-file Clip Size
Total size in GB of a multi-file clip.

Highlighted Item	Result of Pressing Control Knob
Reel group. Indicated by a grey background (when not highlighted) and a number in brackets that indicates the amount of clips in the reel.	Expands a list of clips that are within the Reel.
A Clip that consists of multiple files. Indicated by the filename with a .mov or .wav extension and number in brackets that indicates the amount of files that the clip consists of.	Expands a sub-list of the files that are within the clip.
A Clip that consists of one file or a File within a sub-list of a multi-file clip. Indicated by the filename with a .mov or .wav extension	Opens the File Details view where various details of the file can be viewed and the file can be deleted. <i>See File Management and Metadata</i>

The selected drive is displayed on the top of the screen. To view the contents of other drives, scroll to the top of the list, a pop up box appears with a list of all available drives, select the desired drive and press the Control Knob.

Drive 2 FILE LIST

Reel 002 [3]	View Drive 1	Jan 25, 9:49AM	3.14GB
PIX260_PIX_001_001.mov	View Drive 2	Jan25, 9:49AM	1.10GB
PIX260_PIX_001_002.mov	View Drive 3	Jan 25, 3:00PM	1.02GB
PIX260_PIX_001_003.mov	View Drive 4	Jan 23, 10:15PM	1.02GB
Reel 001 [4]		Jan 22, 8:13AM	6.10GB
PIX260_PIX_001_005.mov		Jan 22, 8:13AM	2.90GB
PIX260_PIX_001_006.mov [2]		Jan 22, 7:02AM	3.20GB
PIX260_PIX_001_006a.mov			1.05GB
PIX260_PIX_001_006b.mov			2.15GB
PIX260_PIX_001_009.wav		Jan 17, 1:15PM	1.35GB
PIX260_PIX_001_010.wav		Jan 17, 8:13AM	3.55GB

While in the File List press the Files button to collapse all Reel folders and multi-file clips to ease file navigation.

The File List is not available when in Record or Playback. If the File List is open when record or playback is engaged, the File List will close and return to the Main View.

It is recommended that files in the same play list or reel be of the same resolution, frame rate, and codec.

File Details

From the File List, highlight a file and press the Control Knob to view the File Details of that file. To view Multi-file Clip details, highlight the menu item with file extension then press and hold the Control Knob. File Details include:

- Start time code
- Timecode frames-per-second
- Timecode user bits
- Video resolution
- Video frame rate
- Video codec/ Broadcast Wave
- Media
- File size
- Duration
- Audio Format

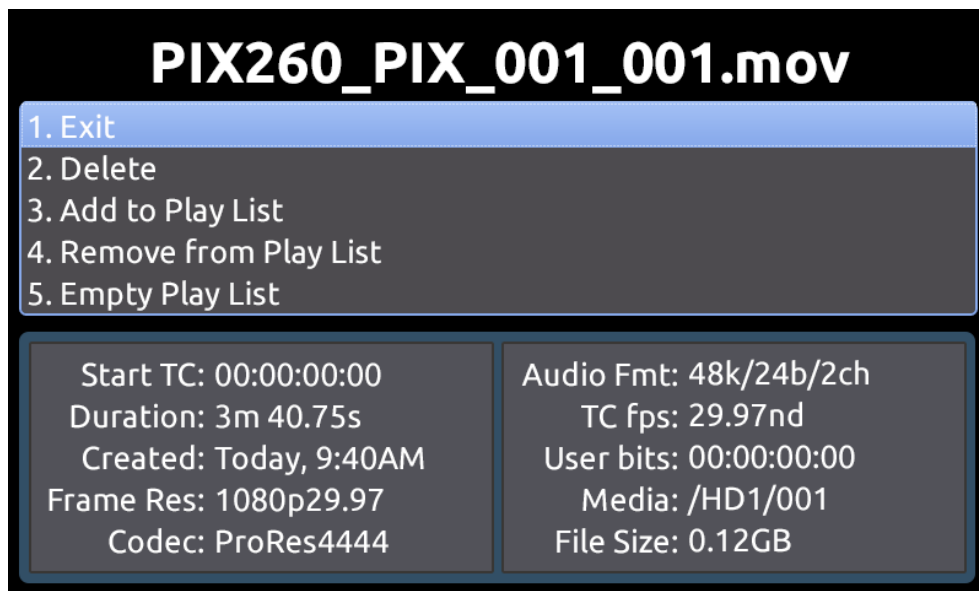

Inputs and Outputs

Video Inputs

The PIX 260i accepts video input signals over HDMI, HD-SDI, and single link 3G-SDI Level A and B.

The PIX 260i does not accept analog video signals. See the specifications section for a complete list of supported frame rates.

HDMI

The PIX 260i accepts HDMI version 1.4a video and audio. Supported video resolutions and rates are listed in the specifications section. The PIX 260i HDMI input accepts up to 10 bit, 4:4:4 video, up to 8 channels of embedded audio. The PIX 260i also accepts Sony's proprietary timecode over HDMI. In Video Mode, the digital audio embedded in the HDMI stream (32 kHz – 192 kHz) is always re-sampled to 48 kHz. In Audio Mode it is re-sampled to the sample rate determined by the **[Timecode/Sync - Sync Ref - Audio Only]**.

720p30/29.97, 720p25, and 720p24/23.976 are not supported on the HDMI input or the HDMI output.

HDCP copy protection prevents direct digital-to-digital copying of copyrighted material. Protected DVDs, Blue-Rays and streaming content with HDCP encryption is not valid content and will be ignored by the PIX 260i.

SDI

The SDI input on the PIX 260i accepts video with embedded audio (up to 16 channels) and embedded SMPTE timecode. This connection accepts digital video up to 12-bit, with up to 4:4:4 color sampling. Unlike the HDMI interface, which auto-negotiates rates between devices, what comes out of a camera's SDI output is received by the PIX 260i with no auto-negotiation or sample rate conversion. **The PIX 260i supports 3G-SDI single link, but not dual-link HD-SDI.**

Timecode over SDI is not available when recording in standard definition

Video Outputs

Both HDMI and SDI outputs are active simultaneously. This allows for conversion from SDI to HDMI and HDMI to SDI.

The output video signal source is the signal present at the currently selected video input (Setup Menu option **[Video - Video Input]**), except during video playback. The resolution and frame rate of the output stream is determined by the Setup Menu option **[Video - File Resolution/Rate]** setting, except during video playback. The SDI Output is capable of sending HD (4:2:2 10-bit) or 3G (4:4:4 12-bit), this is set in **[Video - SDI Output Type]**. Video playback signal is sent to the HDMI and SDI Outputs.

Standard Definition video is always output using HD Mode because 3G does not support Standard Definition.

The output video stream contains up to 16 tracks of embedded audio for SDI and 8 tracks for HDMI. Timecode and record start and stop flags are included on the SDI output.

Timecode overlay can be added to the HDMI and/or SDI output signal in **[Video - Video Output OSD]**. The timecode overlay is displayed in various colors to indicate the current transport state of the PIX 260i, Stopped = white, Red = Record, Green = Playback.

Audio Inputs

The PIX 260i can record up to 32 tracks from a vast array of audio input sources in both Video and Audio modes:

Input Type	Count	Connector(s)	Gain	Details
Analog	8	1-8: DB-25 (CH 1-8 LINE IN) 1-2: XLR (LINE IN 1/2)	Off, -25 to 20 dB	Balanced, Line-level. Channels 1-2 on DB-25 connector are summed with respective XLR connectors.
AES Digital	8	1-8: DB-25 (CH 1-8 AES IN/OUT)	Off, -25 to 50 dB	Selectable between AES or HDMI with Setup Menu option [Audio - HDMI/AES Select]
HDMI Digital	8	1-8: HDMI Input	Off, -25 to 20 dB	Selectable between AES or HDMI with Setup Menu option [Audio - HDMI/AES Select]
SDI Digital	16	1-16: SDI Input	Off, -25 to 20 dB	[Timecode/Sync - Sync Ref - Audio Only] should be set to SDI when using any SDI Audio Inputs (Audio Only Mode). <i>See Sample Rate Converters for details</i>
Dante	32	1-32: Ethernet	Off, -25 to 20 dB	<i>See Dante Audio Inputs for full details</i>

Analog Audio Inputs

The PIX 260i has eight, high-performance, line-level analog audio inputs.

XLR (1-2)

The XLR balanced inputs accept line-level signals. These inputs are shared with Channels 1 and 2 of DB25 Analog Audio Input connector. Channels 1 and 2 of this connector are summed with channels 1 and 2 of the DB25 connector, respectively.

DB25 (1-8)

Eight analog, line-level inputs are provided on the DB25 Analog Audio Input connector. This connector is wired in the Tascam fashion (*see Connector Pin Assignments*). Channels 1 and 2 of this connector are summed with channels 1 and 2 XLR Analog Audio Inputs, respectively.

Digital Audio Inputs

The PIX 260i accepts digital audio from HDMI, SDI, and AES/EBU inputs. In Video Mode, all audio is sampled at the sample rate determined by the video input stream, typically 48kHz. In Audio Mode, the sample rate is determined by the **[Audio - Audio Mode Sample Rate]** when **[Timecode/Sync - Sync Ref - Audio Only]** is set to **Internal**.

HDMI / SDI Embedded Audio

The PIX 260i accept 8 channels of embedded digital audio on the HDMI Video Input or 16 channels of digital audio on the SDI input.

AES3

The PIX 260i accepts AES3 (AES/EBU) digital signals with sampling rates from 32 kHz up to 192 kHz and bit depths up to 24-bits. In Video mode, AES3 inputs are sample rate

converted to 48k. In Audio Mode, they are sample rate converted to the sampling rate set in Setup Menu option **[Audio -Audio Mode Sample Rate]** (except when Setup Menu option **[Timecode/Sync - Sync Ref- Audio Only]** is set to **AES 1-2** in which case the sampling rate is determined by the embedded clock within the AES3 stream). *see Audio Mode*

Dante Audio Inputs

Dante delivers an easy-to-setup, self-configuring, plug-and-play digital audio network that uses standard Internet Protocols over 100Mb and/or Gigabit Ethernet. Dante reliably distributes multichannel digital audio with sub-millisecond latency and sample-accurate record and playback synchronization over CAT 5 cabling. Up to 32 Dante audio channels can be selected in any combination from any Dante audio device on the same Dante network. Should they be necessary, sample rate converters are automatically activated for all Dante audio inputs.

An input Source can be set to an available Dante channel from the PIX 260i or from the Dante Controller application (Available from Audinate's website: <http://www.audinate.com/>) running on a computer attached to the network. To select a Dante source from the PIX 260i, follow the instructions in the *Choosing Audio Sources* section of this guide.

To route Dante channels with the Dante Controller application:

1. Open the Dante Controller application.
2. Select the Routing tab. This table displays Dante devices with available outputs ("Dante Transmitters") horizontally, and Dante devices with available inputs ("Dante Receivers") vertically. PIX 260i units will be represented by their PIX names per Setup Menu option **[Network - This PIX's Name]**.
3. Click the plus symbol (+) where the column of the desired Dante transmitting device intersects with the row of the PIX 260i you wish to set input sources on. This expands the table to display a matrix of the transmitting device's outputs to the PIX 260i's inputs.
4. Click the slots in the matrix where you wish to route or un-route audio channels. A green circle with a check mark will appear in slots that are routed.

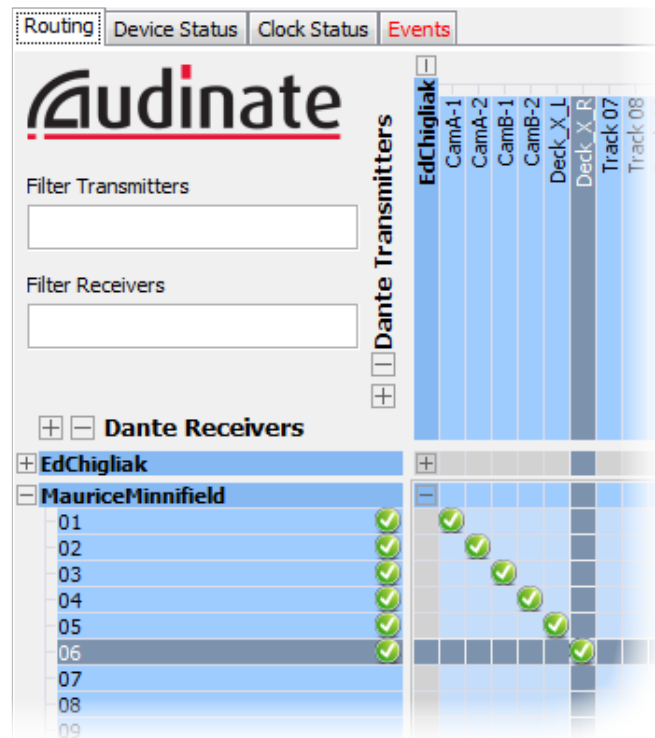

Dante Redundancy

When **[Network - Dante Redundancy Mode]** is set to **On**, the PIX 260i's Primary and Secondary Ethernet ports both transmit Dante Audio data over separate networks. This provides a fail safe of the Dante system if one of the networks should fail.

In Dante Redundancy Mode, two separate networks must be run and they CANNOT be connected to one another. Connect any computer running Dante Controller to the PIX 260's PRI Ethernet network.

See <http://www.audinate.com/> for further information on the Dante protocol.

Sample Rate Converters

Dante, AES, and HDMI inputs all have Sample Rate Converters. These help ensure synchronization of digital audio from multiple sources. SDI Audio Inputs do not have Sample Rate Converters. When using SDI Audio in Audio Only mode the **[Timecode/Sync - Sync Ref - Audio Only]** should be set to **Video Input (SDI/HDMI)**. Any other configuration could result in undesired audio artifacts such as clicks and pops. In Video Mode, SDI audio cannot be used when using HDMI as the Video Input source.

Choosing Audio Sources

Audio Input Source is selected in the Audio Screen in the Source column. To setup an input:

1. Press the Audio button to access the Audio Screen.
2. Select the Source box for the desired track using the Control Knob to move vertically and REW and FF to move left and right.
3. Press the Control Knob to open the Audio Source options window. Select the general type of input to be used from Off, Line In, HDMI/AES In, SDI In, or Dante and press the Control Knob again to open up all options for that input type.
4. Press the Control Knob to make a selection and exit the Audio Input Source options window.

Dante sources must be connected in order to select them as audio input sources.

For quick general audio source configurations use **[Audio - Audio Input Quick Setup]**. See *Setup Menu* for full list of options

Input Level Control

Audio Input Gain is set in the Audio Screen in the Gain column. To adjust the gain of an audio track:

1. Press the Audio button to access the Audio Screen.
2. Select the Gain box for the desired track using the Control Knob to move vertically and REW and FF to move left and right.
3. Press the Control Knob to edit the gain value. Turn the Control Knob to adjust the gain in 1 dB increments. Gain is adjusted in real time. The available gain range depends on audio input source. See *Audio Inputs*
4. Once the desired gain value is set, press the Control Knob to exit the gain window.

Input Gain can be linked in **[Audio - Input Gain Linking]**. When linked, adjust any channel's gain value to adjust the gain of all channels. Gain offsets from channel to channel are maintained. If this is not desired, unlink the gain and set all gain values to the same value then relink input gain.

Input Delay Control

Audio Input Delay is set in the Audio Screen in the Delay column. Delay is adjustable from 0 to 400 mS. To adjust the delay of an audio track:

1. Press the Audio button to access the Audio Screen.
2. Select the Delay box for the desired track using the Control Knob to move vertically and REW and FF to move left and right.
3. Press the Control Knob to edit the delay value. Turn the Control Knob to adjust the delay in 1 mS increments.
4. Once the desired delay value is set, press the Control Knob to exit the delay window.

Input Delay can be linked in **[Audio - Input Delay Linking]**. When linked, adjust any channel's delay value to adjust the delay of all channels. Delay offsets from channel to channel are maintained. If this is not desired, unlink the delay and set all delay values to the same value then relink input delay.

Audio Outputs

Analog Audio Outputs

The eight analog outputs of the PIX 260i are active-balanced, line-level outputs (+18dBu max). At factory default, the source of the Analog Line Outputs 1-8 is tracks 1 to 8, respectively. Any of the available 32 Tracks can be sent to the Line Outputs. Line Output routing is set in **[Audio - Line Output]**.

Digital Audio Outputs (AES/HDMI)

AES and HDMI Outputs are active at all times but these two outputs share the same source. At factory default, the source of the AES/HDMI Outputs 1-8 is tracks 1 to 8, respectively. Any of the available 32 Tracks can be sent to the AES/HDMI Outputs. AES/HDMI Output routing is set in **[Audio - HDMI/AES Output]**.

Dante Audio Outputs

Tracks 1-32 are permanently routed to Dante Outputs 1-32 respectively. Up to four PIX 260i units can be daisy-chained using their built-in internal Ethernet switches. If using five or more PIX 260i units, Sound Devices recommends using an external Ethernet Switch in a star configuration.

SDI Audio Outputs

The SDI video output embeds up to 16 channels of digital audio. At factory default, the source of the SDI Audio Outputs 1-16 is tracks 1 to 16, respectively. Any of the available 32 Tracks can be sent to the SDI Output. SDI Output routing is set in: **[Audio - SDI Output]**.

Headphone Output

The PIX 260i is capable of driving headphones to extremely high sound pressure levels. Hearing experts advise against exposure to high sound pressure levels for extended periods.

The PIX 260i's headphone output is a flexible tool for monitoring audio. The headphone level is adjusted using the Headphone Volume Knob.

To quickly select amongst headphone sources, Press and hold the Audio button while turning the Control Knob. The Headphone Source can also be selected in the Setup Menu option **[Audio - HP Source]**.

Warning Bells are sent to the headphone monitor to alert the user of various states, such as record/stop, and errors such as No Media Connected, or No Input Signal Detected. The loudness of these warning bells is adjustable from Off, -60 to -12 dBFS in **[System - HP Warning Bell Level]**. At factory default, the warning bells are set to -40 dBFS.

Ethernet

The PRI and SEC Ethernet ports on the rear panel of the PIX 260i are used for a variety of PIX 260i functions/features:

- Dante (32-Channel Audio I/O over network) *See Dante Audio Inputs and Outputs for details.*
- PIX Grouping *See PIX Grouping for details.*
- File Transfer (Samba) *See Ethernet File Transfer - Samba for details.*
- Web Browser Control *See Web Interface - PIXNET for details.*

A key use of the Web Browser is to allow the user to remotely instigate a transfer of PIX 260i recorded files to a network destination of their choice. Access to file transfer and web browser is via the IP Address indicated in the **Network Setup Menu** and the OSD. *See Network for further details.*

Up to four PIX 260i units can be daisy-chained using their built-in internal Ethernet switches. If using five or more PIX 260i units, Sound Devices recommends using an external Ethernet Switch in a star configuration.

The PIX 260i can either be allocated an IP address from a DHCP server (recommended) or over Link-local networking. Link-local networking is a protocol which automatically allocates a 169.254.x.x IP address even in absence of any DHCP server. If a DHCP server is available, the PIX 260i will automatically use it if **[Network - Auto IP Settings]** is set to **On**. *See Ethernet File Transfer (Samba) and Web Interface - PIXNET*

The PIX 260i uses on-board Auto-MDIX (crossover detection) to allow for direct connection to a computer or to a network.

Dante uses a separate IP Address which is configured automatically when connected to other Dante devices. This IP Address is displayed when connected to a computer running Dante Controller, a free-of-charge application available from Audinate. See the following link for details about Dante Controller's capabilities.

<http://www.audinate.com/>

In Dante Redundancy Mode, two separate IP Addresses are used by Dante. See Dante Redundancy

Video Monitoring Features

The PIX 260i includes various monitoring features to assist with exposure and focus. These functions only affect signal on the LCD display and will never affect the recorded video or the video output signal.

Exposure Assist

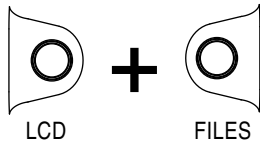

Exposure assist features mark areas of the video image based on the exposure level. With over- or under-exposed areas of the image clearly marked, adjustments can be made on the camera to ensure that the signal reaching the recorder has a proper exposure. Exposure Assist is enabled by holding down the LCD button and pressing the FILES button. When Exposure Assist is enabled, "EXP" is displayed on the OSD in yellow text.

When exposure assist is enabled, False Color or Zebra stripes will be overlaid on the LCD monitor signal. The Setup Menu option **[LCD Monitor - Exposure Assist]** determines which mode will activate when exposure assist is toggled on.

The following image is a luminance ramp signal displayed on a PIX 260i with no exposure assist enabled. Screen shots in the following sections show the effect of the various Exposure Assist features on this test signal.

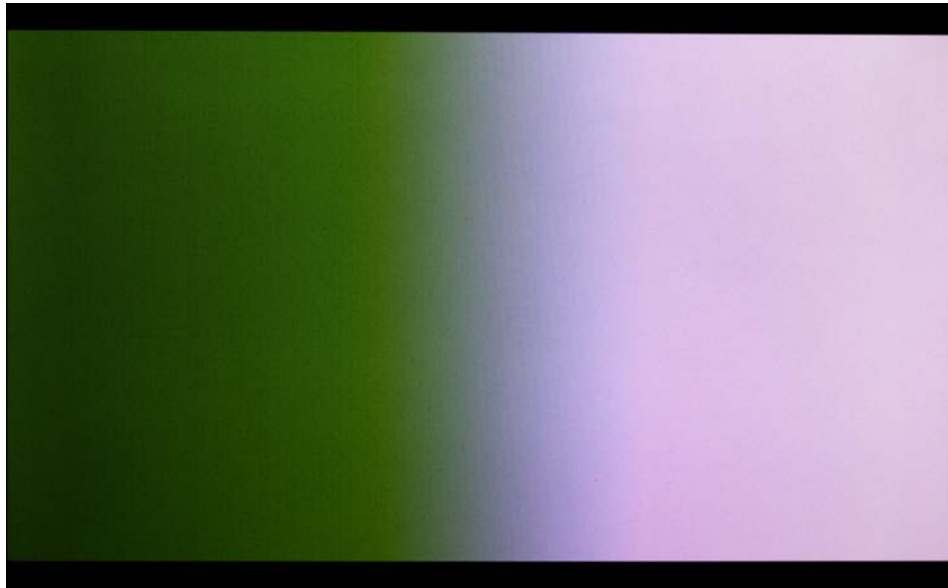

False Color

False Color exposure assist mode replaces pixels with a specific color relative to the luminance level. The two types of False Color (selectable from Setup Menu option **[LCD Monitor - Exposure Assist]**) are 12-step and 4-step.

12-step False Color mode divides the monitor signal into 12 luminance ranges and assigns a color to each.



12-step
100-108 Red
95-99 Orange
85-94 Yellow
79-84 Light Yellow
59-78 Light Grey
53-58 Pink
49-52 Medium Grey
43-48 Green
23-42 Dark Grey
13-22 Light Blue
3-12 Blue
0-2 White

4-step False Color mode divides the monitor signal into 4 ranges and assigns a color to all but one range (this range is displayed without chroma). The table below illustrates the colors as they relate to luminance levels (IRE).



4-step
101+ Red
99-100 Orange
3-98 N/A
0-2 Blue

Zebra

Zebra stripe exposure assist mode overlays diagonal stripes over areas that are in a defined luminance range (Zebra 1) or above a defined luminance threshold (Zebra 2). The range for Zebra 1 is 5% above and below the IRE value of Setup Menu option **[LCD Monitor - Zebra 1 Level]**. The range for Zebra 2 is everything above the IRE value of Setup Menu option **[LCD Monitor - Zebra 2 Threshold]**. The options for Zebra display (selectable from Setup Menu option **[LCD Monitor - Exposure Assist]**) are Zebra 1, Zebra 2, or both Zebra 1 and Zebra 2 simultaneously.

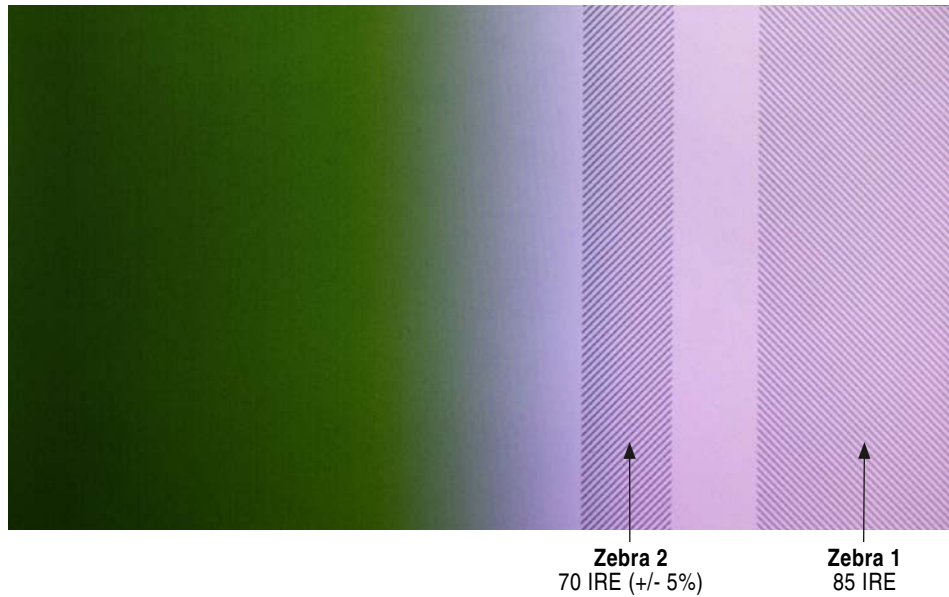

Focus Assist

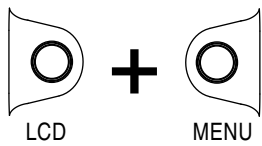

Focus Assist features mark sharp edges in the video image to assist in focusing on the desired subject. Focus assist is enabled by holding down the LCD button and pressing the MENU button. The word “FOCUS” is displayed in yellow text on the OSD when Focus Assist is enabled. There are two available Focus Assist modes: Peaking and Edge Enhance.

Peaking

Peaking finds sharp edges in a video (based on luminance) and replaces pixels in those areas to highlight the edges.

The Setup Menu option **[LCD Monitor - Peaking Sensitivity]** sets sensitivity level of the Peaking filter. A setting of **High** will be more sensitive and highlight more edges.

The Setup Menu option **[LCD Monitor - Peaking Background Contrast]** is used to adjust the area of the video image that is not highlighted while Peaking is enabled.

The color of the Peaking marks can be set with the Setup Menu option **[LCD Monitor - Peaking Color]**.

The following image comparison demonstrates the effect of Peaking on an image with a shallow depth-of-field and a short focal length (top) and a longer focal length (bottom).

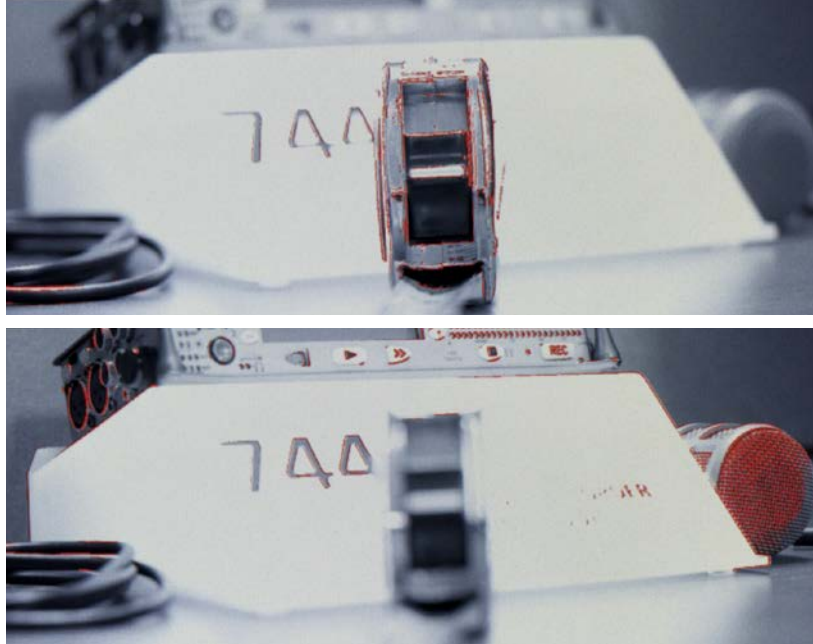

Edge Enhance

The Edge Enhance filter uses an algorithm which enhances the variation of the luminance of all edges present in the video image. The following image comparison demonstrates the effect of Edge Enhance on an image with a shallow depth-of-field and a short focal length (top) and a longer focal length (bottom).



Zoom

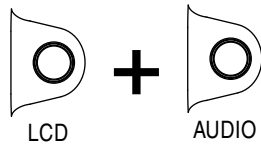

The Zoom function enlarges the video image to a 1:1 pixel ratio. To toggle Zoom on and off, hold down the LCD button and press the AUDIO button. When Zoom is enabled, “ZOOM” is displayed on the OSD in yellow text and all other OSD elements are hidden. When zoomed, turning the Control Knob moves vertically and REW and FF buttons move left and right respectively.

Flip Display

Some mounting situations require the PIX 260i (or camera) to be upside-down. The LCD output can be vertically inverted to facilitate upside-down operation with the Setup Menu option **[LCD Monitor - Vertical Flip Display]**. The Setup Menu option **[LCD Monitor - Horizontal Flip Display]** option reverses the LCD output signal horizontally (mirror image).

Vertical and Horizontal flipping affect the video image on the LCD screen only. Recorded content and HDMI/SDI outputs are not affected.

Recording

The PIX 260i can record video and audio together to a Quicktime .mov file (Video Mode) or audio only to a .wav file (Audio Mode) File type is selected in **[Video/Audio Mode - Video/Audio Mode]**. The PIX 260i can simultaneously record to up to four drives. Files are recorded to all available drives that are set to On in **[File Storage - Record to Drive]**.

Pressing the REC button will start recording provided there is valid video signal present (Video Mode) or at least one audio track is armed (Audio Mode). Recording will continue until the Stop (■) button is pushed or until the target recording media is full. Record and Stop can also be triggered by other devices via a web browser, RS-422, GPIO, SDI Triggers, and Timecode. External control of such functions is set in **Remote Control**. See *External Control and Timecode for more details*

While recording, the REC button will illuminate red and the OSD items Timecode, File Name, ABS Time, and drives actively recording turn red. The PIX 260i is a record-priority device and will enter record any time the REC button is pressed. If the PIX 260i is not ready to record when a record command is given the PIX 260i will enter a Record Pending state. In this state the REC key will flash red, once the system will enter record when it becomes ready. This is usually caused by file storage mounting or response time, loss of video input, or Play/Pause/Shuttle/etc... to Record.

While recording and playback, the Setup Menu and File List are locked out. When the Setup Menu option **[System - REC button File Split]** is set to **On**, pushing the REC button during recording will begin a new file.

Recorded files are split when the time of Setup Menu option **[File Storage - Quicktime File Split every]** is reached (Video Mode) or the file size of Setup Menu option **[File Storage - Wave File Split Every]** is reached (Audio Mode). In both cases, a new file will be created and grouped with the other files from the clip in the File View (*see File Management and Metadata*).

To discard the last take and delete the file (False take), hold down the Stop (■) button and press Re-wind (◀). A dialog box will appear warning that the last take will be deleted and indicating the file name. Use the Control Knob to highlight OK and push the Control Knob to confirm.

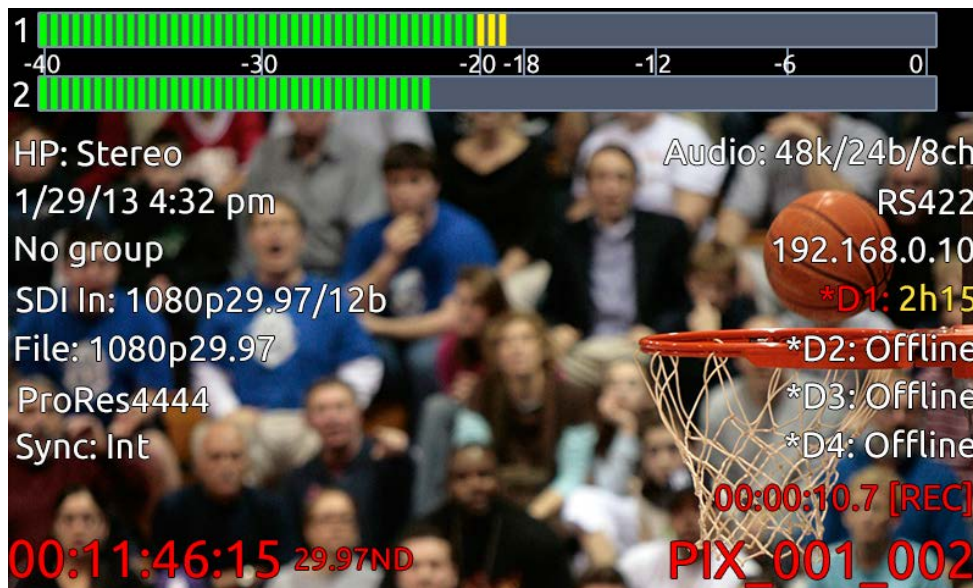

Selecting Video File Resolution and Frame Rate

The PIX 260i can record video in numerous resolutions and frame rates. The Setup Menu option **[Video - File Resolution/Rate]** sets the resolution and frame rate of recorded Quicktime files. This Setup Menu option also determines the resolution and frame rate of the live HDMI and SDI output signals, except during playback. The PIX 260i can record Quicktime files in the following resolutions and frame rates:

- 1080 p30
- 1080 p29.97
- 1080 p25
- 1080 p24
- 1080 p23.976
- 1080 i60
- 1080 i59.94
- 1080 i50
- 1080 PsF 30
- 1080 PsF 29.97
- 1080 PsF 25
- 1080 PsF 24
- 1080 PsF 23.976
- 720 p60
- 720 p59.94
- 720 p50
- 720 p30
- 720 p29.97
- 720 p25
- 720 p24
- 720 p23.976
- 576i50 *
- 480i59.94 *

When Setup Menu option **[Video - File Resolution/Rate]** is set to **Same as Video Input**, recorded Quicktime files and video output signals will be of the same resolution and frame rate as the input video signal.

** Standard definition recording is only available for ProRes 422 HQ, ProRes 422, and ProRes 422 Proxy.*

Progressive Segmented Frames (PsF)

Some cameras output video signal in progressive segmented frames (PsF). PsF is a method for transmitting progressive video in an interlaced stream. A device generates PsF signal by splitting each frame into two segments. PsF segments are the same as interlaced fields in that one segment represents the even lines of a frame and the other segment represents the odd lines of a frame. PsF segments differ from interlaced fields in that there is no motion between each segment in a pair.

The PIX 260i will automatically sense PsF signal from most cameras that output PsF over SDI. This is accomplished through the use of a flag inserted into the SDI signal by the camera. If a camera does not insert this flag into the SDI stream or if it outputs PsF signal over HDMI, then the Setup Menu option **[Video - Input PsF Detect]** can be set to **Interpret 1080i as PsF**. This will force the PIX 260i to treat all 1080i signal as if it were PsF and deinterlace it accordingly.

Selecting a Video Codec

Setup Menu option: **[Video - Codec]**.

The PIX 260i has two families of intra-frame, DCT based codecs available: Apple ProRes and Avid DNxHD, with five levels of compression for ProRes and four levels of data compression available for DNxHD. Both codecs are intermediate codecs that assist the editing process by eliminating the need to transcode video before importing into Final Cut (ProRes) or Avid (ProRes or DNxHD).

ProRes is a variable data rate codec; DNxHD is a fixed data rate codec. PIX 260i supports all compression levels and bit rates of DNxHD and ProRes and automatically records the correct bit rate dependent upon the video input resolutions and frame rate. The data rates indicated in the Setup Menu item **[Video - Codec]** indicate the maximum data rate at 1080p30.

DNxHD 36 Mb/s only supports 1080p signal. Standard definition recording is only available for ProRes 422 HQ, ProRes 422, and ProRes 422 Proxy.

Interruption of Signal During Recording

In video mode, in the event that video signal is lost (an unplugged HDMI or SDI cable, for example) during recording, the PIX 260i will pause the recording and wait for video signal to be re-initialized. If video signal is re-initialized recording will begin again to a new file of the same name with an "A" appended to the end. Further interruptions of signal during that take will cause an alphabetic filename progression ("B", "C", etc).

In Audio Mode, loss of video signal will have no affect on the transport state unless it is the sync reference source.

Alignment of Audio and Video

An advantage to recording audio on the PIX 260i along with the video is the elimination of audio/video sync problems in post. The PIX 260i has many options regarding audio sources along with the two options for video inputs, HDMI and SDI. Given this flexibility, care must still be taken to ensure good audio/video sync.

If recording camera audio embedded on HDMI or SDI, then the audio/video alignment will be excellent provided the alignment is proper on the camera.

If recording audio using the dedicated audio inputs (Analog, AES, or Dante), then a delay may need to be dialed in. The reason for this is that some cameras have a delay of one or more frames from lens to SDI/HDMI output. The PIX 260i on the other hand has no appreciable delay between audio and video. This means that if the camera does have this delay, the audio will lead the video as recorded by the PIX 260i. Note that on some cameras, the lens-to-SDI/HDMI delay changes with resolution/frame rate. The best practice is to test the audio/video sync using sticks on a test file for each camera resolution/frame rate to be used on a project before starting. *See [Audio Input Delay Control](#) for details*

Audio Track Arming

Up to 32 Tracks of audio can be recorded in both Audio and Video modes. Tracks must be armed in the Audio Screen in order for them to be recorded. To arm or disarm Tracks for recording:

1. Press the Audio button to access the Audio Screen.
2. Select the Arm box for the desired track using the Control Knob to move vertically and REW and FF to move left and right.
3. Press the Control Knob to access the Arm options window. Arm options are Off, On, All Off, or All On.
4. Select the desired option then press the Control Knob to exit the arm window.

Audio Mode

When Setup Menu option **[Video/Audio Mode - Video/Audio Mode]** is set to **Audio Only (Wave)**, the PIX 260i is in Audio Mode. In Audio Mode, the PIX 260i records only audio signal to uncompressed PCM .wav files. Certain Setup Menu options apply only to Audio Mode:

- **[Timecode/Sync - Sync Ref - Audio Only Mode]**: This determines the sync reference source clock for audio mode. The source can be set to Internal, Word Clock (Sync In), AES1-2, Dante, or Video Input (SDI/HDMI). In Video Mode, sampling rate always follows the sample rate of the input video stream, typically 48 kHz.
- **[Audio - Audio Mode Sample Rate]**: This menu option only applies when the **[Timecode/Sync - Sync Ref - Audio Only Mode]** is set to **Internal**. The default sample rate is 48 kHz. Audio Mode allows for 44.1 kHz or 48 kHz recordings.

- **[Audio - Audio Mode Bit Depth]**: The bit depth of recorded audio in Audio Mode. The default Bit Depth is 24. Audio Mode allows for 16- or 24-bit recordings. In Video Mode, audio bit depth is always 24 bits.
- **[File Storage - Wave File Split Every]**: The file size that will cause a .wav file split in Audio Mode. At factory default audio files will automatically split when the file size reaches 4 GB. Audio recordings can also be split when the file size reaches 2 GB.
- **[Timecode/Sync - Frame Rate (Audio Only)]**: The frame rate that will be stored in the iXML and Bext area of the .wav file. The default frame rate is 29.97 non-drop. The available frame rate options are 23.976, 24, 25, 29.97, 29.97 drop-frame, 30, 30 drop-frame.

If the synchronization source (Setup Menu option **[Timecode/Sync - Sync Reference -Audio Only]**) is lost while in record, the recording will stop. The **Sync Reference** OSD field will flash red if the synchronization source is not present. The Audio Input OSD field will flash red if there is a mismatch between the currently selected audio sync referenece sample rate and the **[Audio - Audio Mode Sample Rate]** setting. If recording audio from an SDI source, Setup Menu option **[Timecode/Sync - Sync Reference -Audio Only]** must be set to **SDI**. *See [Sample Rate Converters](#)*

F Sampling Rate Modes

48.048k and 48.048kF

The 48.048kF mode (F can stand for “fake”, “faux”, or “Fostex”) is a specific compatibility mode for use with the Fostex DV40 software (1.74 and previous), Avid, Final Cut Pro, and other post-production environments that do not recognize audio files written at 48.048 kHz. In this mode WAV files are recorded at a 48.048 kHz sampling rate but are stamped at 48 kHz. When played, they will play back 0.1% slower than real time.

One use for the 48.048kF mode is to force a 0.1% speed reduction (pull down) of audio to match MOS-telecined film (24 fps-to-NTSC) in non-linear edit systems, such as Avid or Final Cut Pro. Since the file is stamped as a 48 kHz file, the edit system will play it back at 48 kHz and not at 48.048 kHz. This “audio pull down” will match the transferred picture without the need for an intermediate step through other software to create the pull down.

The time code frame rate (actual recording rate) is forced to 30 ND in 48.048kF mode. The audio file, however, is stamped with a 29.97 ND frame rate, along the 48 kHz sampling rate. It will appear as if the file was originally recorded at a 48 kHz sampling rate at a TC rate of 29.97 ND.

Fostex DV40

When using files recorded in the 48.048kF mode in with a DV40 with early software, set the DV40 time code frame rate to 29.97ND. Time code stamps will properly match the original time code start times.

47.952k and 47.952kF

Both 47.952 and 47.952kF settings use a record sampling rate of 47.952 kHz, 0.1% lower than 48 kHz. The 47.952kF mode, however, identifies the file as being recorded at 48 kHz. Additionally there are two frame rate options in 47.952kF mode. The timecode frame rate can be set to 23.97 while the file is identified as 24ND or it can be set to 29.97ND while the file is identified as 30ND. By default, when 47.952kF mode is selected the frame rate is changed to 29.97ND and identified as 30ND unless the Frame Rate was already set to 23.97 in which case it will remain at 23.97.

Video Scaling and Frame Rate Conversion

The PIX 260i features powerful, hardware-based video scaling, frame rate conversion, and de-interlacing. This allows for converting the resolution and frame rate of video input to the recorded file and to the HDMI and SDI outputs in real-time.

Video scaling and/or de-interlacing is active whenever the Setup Menu option **[Video - File Resolution/Rate]** is set to something other than **Same as Video Input**. Any supported input signal can be converted to any available resolution. When set to record progressive frames, the PIX 260i will convert incoming interlaced video to progressive frame video via its built-in, powerful, hardware-based de-interlacer. The PIX 260i will also convert progressive segmented frame (PsF) video to progressive video automatically if Setup Menu option **[Video - File Resolution/Rate]** is set to a progressive frame format (for example **1080p30**). If Setup Menu option **[Video - File Resolution/Rate]** is set to interlaced format (for example **1080PsF30**), the PIX 260i will record PsF signal unaltered, but the file will be stamped as interlaced.

Frame rate conversion occurs whenever the frame rate of **[Video - File Resolution/Rate]** differs from the frame rate of the input video signal. Frame rate conversion is achieved by appropriately duplicating or dropping frames. The PIX 260i will auto-sense between integer and non-integer frame rates (for instance 30 frames vs. 29.97 frames). The PIX 260i will not frame rate convert between integer and non-integer frame rate values. For example, if the incoming video signal is 1080i59.94, it can be converted to 1080p29.97 or 720p59.94 but not 1080p30 or 720p60. The Setup Menu option **[Video - File Resolution/Rate]** contains entries with a combination of integer and non-integer frame rates (such as 1080p30/29.97). When any of these options are selected, the PIX 260i will record in the indicated integer frame rate if the input video is an integer frame or record in the indicated non-integer frame rate if the input video is a non-integer frame rate.

Not all frame rate conversions are visually desirable. When the OSD Item **File Resolution/Rate** is red, the conversion of the frame rate of the input video to the frame rate set by **[Video - File Resolution/Rate]** will contain a finite amount of motion judder. For example, if the incoming video is 720p60 and **[Video - File Resolution/Rate]** is set to **720p50**, the cadence of dropped frames may be noticeable depending on the content. Conversions which are simply 1:2 or 2:1 (such as 1080i59.94 to 1080p29.97) introduce no motion judder. For these conversions, the OSD Item **File Resolution/Rate** remains white.

When the input video signal is 720p24 or 720p23.976, up-, down-, and cross-conversion is not available.

3:2 Pulldown Removal

Many cameras which shoot with a shutter speed of 24/23.976 frames per second will output signal on the HDMI or SDI output at 60i/59.94i. To achieve this, the camera performs a "3:2 pulldown" process. The 3:2 pulldown process splits each frame into 2 fields and duplicates a field periodically. The PIX 260i is capable of removing 3:2 pulldown from a 60i/59.94i signal and converting it back to 24/23.976 progressive frames per second in real-time. The PIX 3:2 removal process actively views video fields looking for duplicates. When these duplicates are sensed, then this cadence is locked in and the appropriate extra fields are removed. The process depends on motion in the incoming video. The OSD item **File Resolution/Rate** changes from orange to white when this cadence is detected:

HDMI In: 1080i59.94
 1080p23.976
 ProRes422

Orange: No 3:2 pulldown sensed in 60i/59.94i input signal. Input video is being converted to 24p/23.976p using a conversion process which drops frames and may introduce judder.

HDMI In: 1080i59.94
 1080p23.976 (3:2 pd)
 ProRes422

White: 3:2 pulldown sensed in 60i/59.94i input video signal. Input video signal is being converted to 24p/23.976p using 3:2 pulldown removal which recreates 24p/23.976p as it is captured from the camera's shutter.

Up and Down Conversion

Standard-definition video resolution employs a 4:3 aspect ratio, and high-definition video resolution employs a 16:9 aspect ratio. Up-conversion is the process of fitting standard-definition video (with a 4:3 aspect ratio) into a high-definition, 16:9 frame. Down-conversion is the opposite process.

The PIX 260i has various options for up and down conversion:

Down-Conversion

Letterbox: Maintains the same height and width ratio. Results in blank bar at top and bottom of image.

Crop: Left and right side of image is cropped to fit into 4:3. Results in missing image at sides of picture.

Anamorphic: Image is horizontally squashed to fit into 4:3. Results in a narrow looking image.

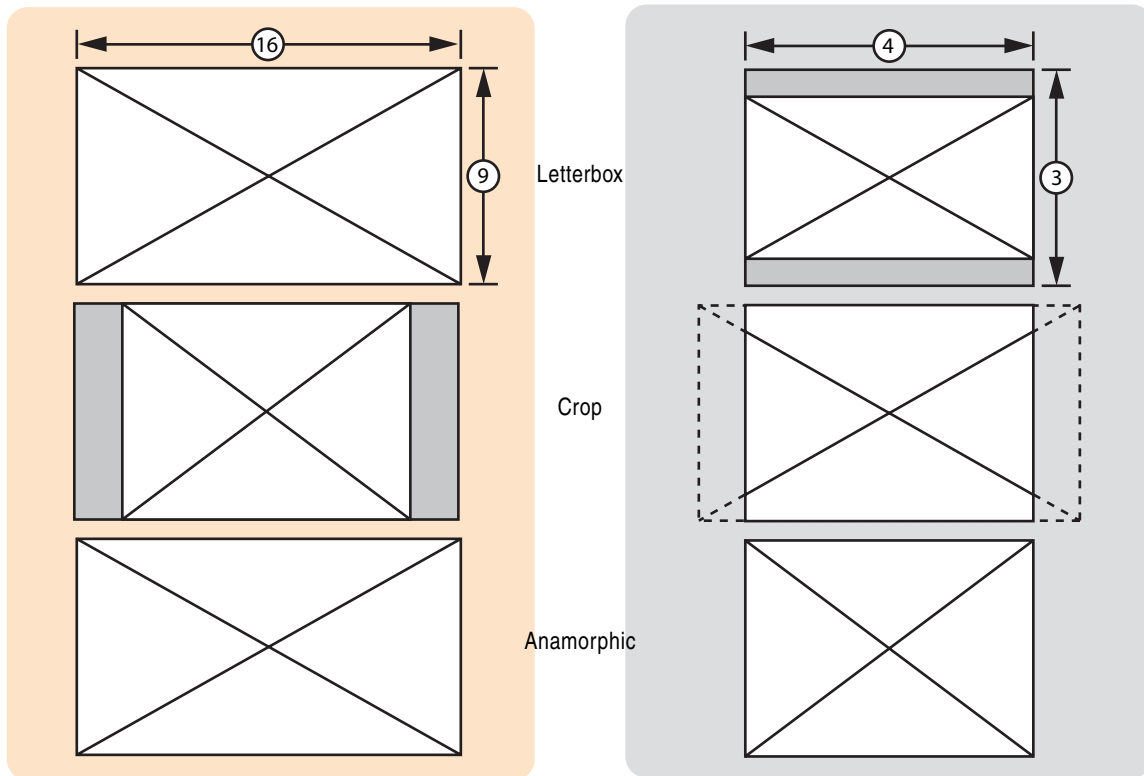

Up-Conversion

Anamorphic: Image is horizontally stretched to fit into 16:9. Results in a wide looking image.

Zoom 14x9: Maintains same size but fills in remaining screen space with blank bar on the right and left of image.

Zoom Letterbox: Converts letterbox to full screen 16:9.

Pillarbox: Increases size and maintains same ratio. Results in blank bar at right and left of image and picture cropped at top and bottom.

Zoom Wide: Increase size and maintains ratio to full screen 16:9. Results in top and bottom being cropped.

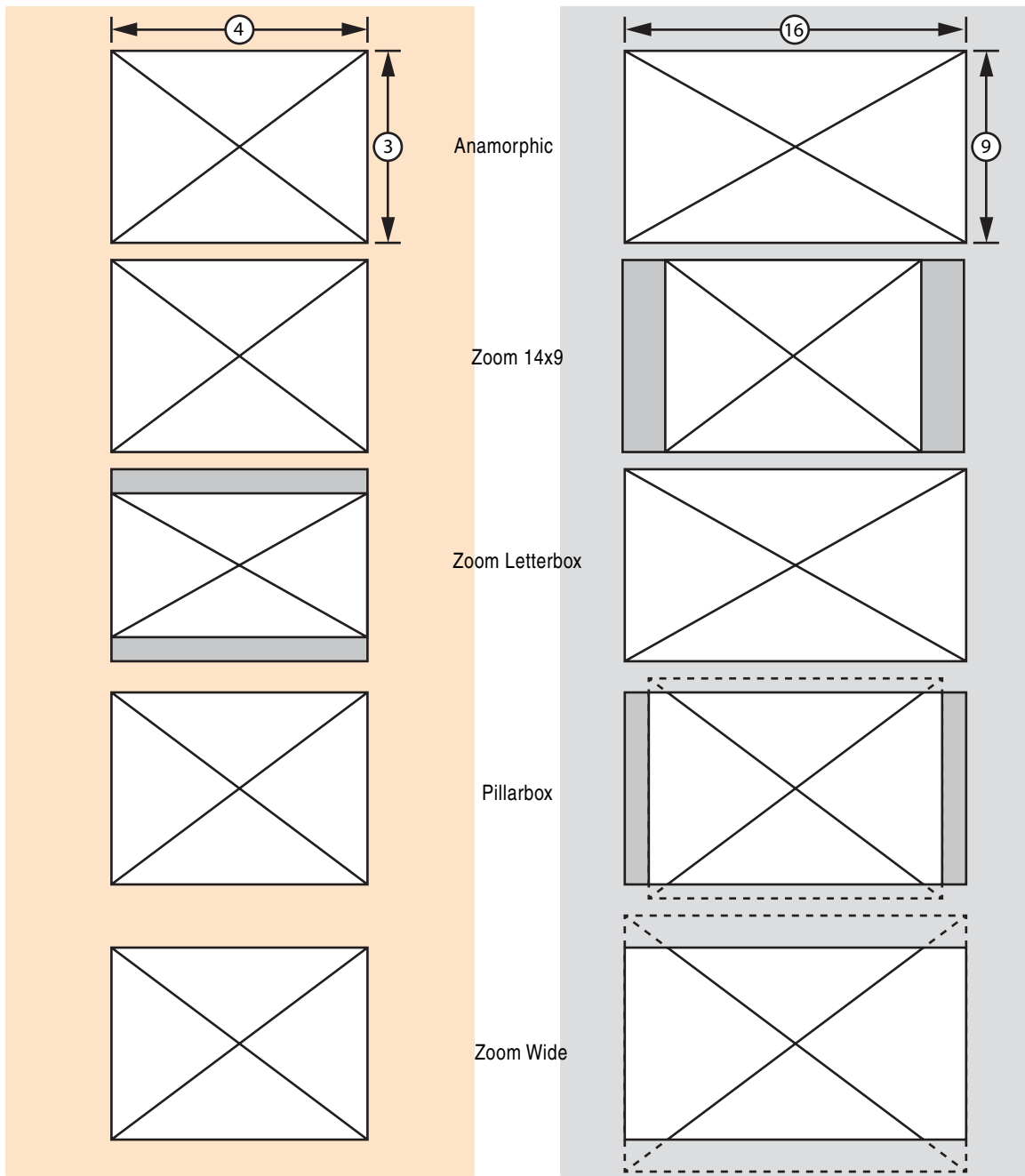

Playback

The PIX 260i has a very powerful playback engine that allows for playback of QuickTime .mov files and PCM .wav files whether the files were generated by the PIX 260i or elsewhere. *See Appendix A for currently supported files* Playback video is shown on the onboard LCD display and is sent to the video outputs. The PIX 260i's video playback clock is determined by the setting in **[Timecode/Sync - Sync Reference -Video Playback]**. Audio Only playback clock is determined by the setting in **[Timecode/Sync - Sync Reference -Audio Only]**.

Playback Operation

From the Main View, pressing Play (▶) after a recording will playback the most recent file. Using the Rewind (◀◀) and Fast Forward (▶▶) buttons, previous recorded files can also be cued for playback. The file cued up for Playback is displayed in the File Name field of the OSD. To select other files for Playback, enter the File List, locate the file then press Play (▶).

The Playback drive is indicated when Stopped or Playback by the green Drive Status OSD field. To switch the playback drive, simply playback a file from the desired drive from the File List.

In Playback Mode the Play (▶) button and the OSD Items **ABS Time**, **Timecode**, and **Filename** are green. While in Playback Mode, pause playback by pressing the Play (▶) button again. The Play button flashes green to indicate playback is paused. Press the Stop (■) button anytime to stop playback and exit Playback Mode.

Frame by frame scrolling (similar to the traditional Jog function) is supported when playing back QuickTime .mov files. To scroll through a video file frame by frame, pause playback then turn the Control Knob to increase/decrease the video file in one frame increments.

Playback audio of both QuickTime .mov and PCM .wav files is routed to audio outputs as determined by output routing options in the **[Audio]** Setup Menu section. *see Audio Outputs*

Other PIX 260i's in a group will begin playback only if a file of the same name is present. *see PIX Grouping*

Fast Forward and Rewind

Video Mode: Hold down the Fast Forward (▶▶) or Rewind (◀◀) button during playback for 2x (double) speed playback. When the Fast Forward (▶▶) or Rewind (◀◀) button is held for five seconds or more the playback will become 16x speed. Normal playback will resume when Fast Forward (▶▶) or Rewind (◀◀) is released.

Audio Mode: Hold down the Fast Forward (▶▶) or Rewind (◀◀) button during playback scrub forward or backward. As the Fast Forward (▶▶) or Rewind (◀◀) button is held down, playback speed in that direction will increase (up to 50x). Release the button to resume playback in real time.

File Skip

Video Mode: During Playback, press Fast Forward (▶▶) once to jump to the next Cue Marker (if applicable) or begin playback of the next clip (if it exists). Press Rewind (◀◀) once to jump to the previous Cue Marker (if applicable) or to the beginning of the current file. Immediately press Rewind (◀◀) again to skip to the previous file's last Cue Marker (if applicable) or beginning. File Skip functions will work while a clip is playing and while it is paused.

Shuttle Playback Mode

Shuttle Playback Mode is available in Video Mode only

In Shuttle Playback Mode the PIX 260i is capable of playing back at various rates in forward and in reverse. Shuttle Playback Mode is only available when playing back Quicktime .mov files.

To immediately enter Shuttle Playback Mode from the Main View, press the Control Knob. The cued file will begin playback at half speed (FFx1/2). Shuttle Playback Mode can also be accessed while a file is playing back or when paused by pressing the Control Knob.

When Shuttle Playback Mode is active, the OSD items **ABS Time**, **Timecode**, and **Filename** are displayed in blue. Turn the Control Knob to select among the available playback directions and rates. The following table defines the playback directions and speeds available when turning the Control Knob in Shuttle Playback Mode.

Reverse																Forward																	
32	16	8	7	6	5	4	3	2	1	1/2	1/3	1/4	1/5	1/6	1/7	1/8	1/8	1/7	1/6	1/5	1/4	1/3	1/2	1	2	3	4	5	6	7	8	16	32

In Shuttle Playback Mode, the playback direction and speed will be indicated on the LCD if Setup Menu option **[Display - ABS Time]** is set to **On**. The Fast Forward (**>>**) and Rewind (**<<**) buttons will illuminate independently to indicate the playback direction. Press the Control Knob while in Shuttle Mode to pause playback. Press the Play (**▶**) button while in Shuttle Mode to return to Playback Mode.

Cue Marker

Cue Markers are available in Video Mode only.

During Record, Playback, or Shuttle mode, press the FILES button to set a Cue Marker. To delete a Cue Marker, press and hold FILES again. A dialog box appears asking “Delete Cue Marker? Cue (number)”, select OK to delete and Cancel to ignore. Cue Markers added or deleted during record are applied to all available drives. Cue Markers added or deleted during playback or shuttle mode are only applied to the current playback drive.

The previous Cue Marker is displayed in the lower left-hand corner of the OSD when **[On-Screen Display - Cue Marker]** is On. The OSD field will be displayed in various colors depending on the current transport status, Red = Record, Green = Play, Blue = REW/FF/Shuttle. To quickly jump to the next or previous Cue Marker, press the Fast Forward (**>>**) or Rewind (**<<**) button respectively.

Cue Marker Looping

Cue Marker Looping is available in Video Mode only.

Looping playback can be enabled between consecutive cue markers or the beginning and end of the current clip. To toggle looping playback and begin looping the currently playing clip, hold the Play (**▶**) button for 1 second during playback. “Loop: Clip” will be displayed in the bottom left-hand corner of the OSD if **[On-Screen Display - Cue Marker]** is set to On.

To loop between two consecutive cue markers, hold down the Play (**▶**) button and press the Fast Forward (**>>**) button while playback is in between the two cue markers. The cue markers that are being looped are displayed on the bottom left-hand corner of the OSD. To return to looping the entire clip, hold down the Play (**▶**) button and press the Rewind (**<<**) button.

To exit looping, hold down the Play (**▶**) button for 1 second.

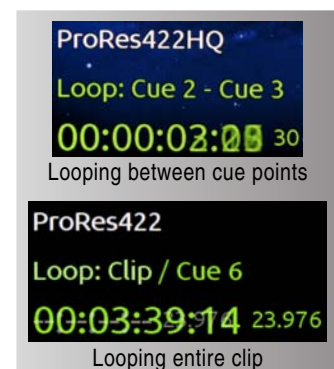

Play List

Files can be added to a play list in order to play them back sequentially. Play list functions are accessed from the File Detail view of any file. To access the File Detail view of a file:

1. Press the FILES button to view the File List.
2. Highlight the desired file, then press the Control Knob to enter the File Details view.



Add to Play List will add the file to the end of the play list. **Remove from Play List** will remove the file from the play list and decrease the position of all files above in the play list. **Empty Play List** will clear the play list completely (note that this function affects the entire play list).

Files in a play list are indicated with a number in the Files View:

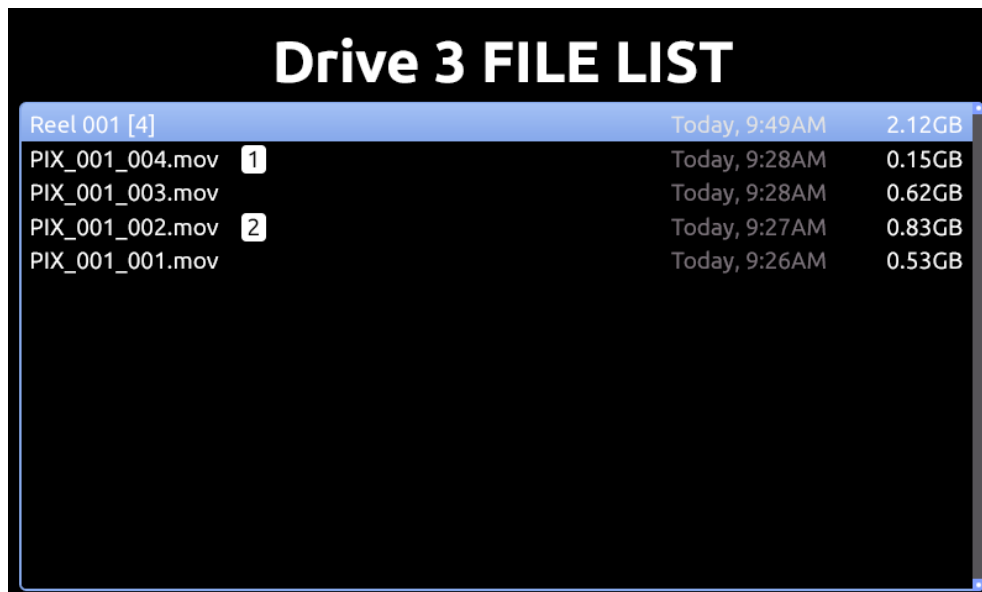

By default, the PIX recorder will play files in the order that they are arranged in the File List. To play back files in a play list in the order of the play list, **[System - Playback Mode]** must be set to one of the Play List modes.

It is recommended that files in the same play list or reel be of the same resolution, frame rate, and codec.

Playback Mode

By default, when a file is selected for playback, the PIX 260i will play the file immediately and stop playback when the end of the file is reached. The Setup Menu options **[System - Playback Start mode]** and **[System - Playback mode]** alter this behavior. When **[System - Playback Start mode]** is set to **Pause on First Frame**, a file will begin playback in a paused state on the first frame. This is useful for “loading” a clip so that playback can be manually triggered without any start up delay.

The Setup Menu option **[System - Playback mode]** affects how playback will continue after the end of a file is reached (assuming no user transport commands are called):

Playback mode	Behavior
Play Once	Playback stops when the end of the file is reached.
Play Once - Pause	Playback pauses on last frame when the end of the file is reached.
Play All	Playback continues with the next file in the File List. This process is repeated until all files in the File List have been played at which point playback stops.
Play All - Pause	Playback pauses at the first frame of the next file. This process is repeated until all files in the File List have been played or Stopped is pressed.
Play All - Loop	Playback continues with the next file in the File List. This process is repeated until all files in the File List have been played at which point playback begins at the beginning of the File List.
Play List	Playback continues with the next file in the Play List. This process is repeated until all files in the Play List have been played at which point playback stops. see Play List
Play List - Pause	Playback pauses at the first frame of the next file in the Play List. This process is repeated until all files in the Play List have been played or Stopped is pressed.
Play List - Loop	Playback continues with the next file in the Play List. This process is repeated until all files in the Play List have been played at which point playback begins at the beginning of the Play List.

It is recommended that files in the same play list or reel be of the same resolution, frame rate, and codec.

Playback Rate of Audio Files

Audio files (WAV) will always be played back at the sample rate of the PIX 260i. The sample rate that the file was originally recorded at (and that is stamped in the file’s header) will be ignored by PIX 260i during playback, and the PIX 260i will play the file at the current sample rate, as determined by Setup Menu option **[Timecode/Sync - Sync Ref - Audio Only Mode]**. When Setup Menu option **[Timecode/Sync - Sync Ref - Audio Only Mode]** is set to **Internal**, audio files will play back at the sample rate of Setup Menu option **[Audio - Audio Mode Sample Rate]**, even in Video Mode.

Non-Native File Playback

The PIX 260i can playback QuickTime .mov files and PCM .wav files generated by third party applications and devices.

Exporting QT Files for 260i Playback

When exporting QuickTime files for PIX 260i playback be sure to set audio to 48kHz. The PIX 260i cannot playback more than two QuickTime tracks of audio. If multi-channel audio is required, it is recommended that the multi-channel audio is interleaved into a single QuickTime audio track.

Playing Back Files on a Computer

Video files recorded with the Apple ProRes codec require Quicktime to be installed. Quicktime can be downloaded from <http://www.apple.com/quicktime/download/>. See http://software.sounddevices.com/Apple_ProRes_White_Paper_July_2009.pdf for more detailed information about the ProRes codec.

Video files recorded with the Avid DNxHD codec require DNxHD drivers to be installed. Visit <http://www.avid.com/dnxhd> to download DNxHD drivers and for more detailed information about the DNxHD codec.

Audio files are industry standard .wav files that adhere to the Broadcast Wave File standard (BWF). Each file includes the original broadcast extension (bext) and a complete iXML section.

Synchronization and Timecode

Synchronization of video, audio, and associated timecode while recording video and audio has long been a problematic area. Situations where several cameras are used can complicate issues further. There may be sync issues between two (or more) cameras and/or between audio recorders because of a) offset and b) drift. In a production environment (during recording), offset and drift are both terms to describe a timing problem between the timecode signal from two or more audio or video recorders. In a post-production environment (a non-linear editor application), offset and drift are both terms to describe a timing problem between two or more audio or video files.

Offset (matching the beginning or “head” of a take) occurs because the beginning of takes are not aligned due to the absence or misuse of timecode. Drift (matching the end or “tail” of a take) occurs because different recorders (audio or camera) run at different rates - the beginning of files from each may have zero offset, but by the end they drift apart. The PIX 260i was designed with these problems in mind and includes the most comprehensive and powerful synchronization features available in a production recorder. These features can be used to alleviate or eliminate offset and drift problems in both production and post-production. While the PIX 260i’s design makes setting the parameters as easy as possible, a good understanding of synchronization is still necessary to properly operate the PIX 260i and ensure a trouble-free workflow.

In a camera, the shutter, video circuitry, audio sampling, and timecode all run off of one “heartbeat” from its master internal clock. If this master clock is slightly fast, then the shutter, audio sampling, and timecode will be slightly fast, and if the master clock is a slightly slow, the shutter etc will also be slightly slow.

When a PIX 260i’s video input is connected via HDMI or SDI to a camera or other video source, this “heartbeat” is passed through the HDMI or SDI. The PIX 260i video and audio circuitry can be clocked off of this incoming signal. In other words, the PIX 260i **references** this clock and **synchro-nizes** its own clock to it. The PIX 260i writes files based on this clock as well - each audio sample and video frame written out to the file is synchronized to the incoming video. This way, the PIX 260i is always completely in sync with the connected video source - there can never be any drift of audio or video between the camera and the PIX. *See Sync Reference for clarification.*

Drift problems in a workflow can arise when more than one camera is used on a shoot, as each camera is driven off of its own internal master clock. Since internal master clock speed will always vary from camera to camera (and vary based on temperature and time), each camera used will run at a slightly different shutter speed, audio sample rate and timecode rate. This is also true when recording video on a camera and recording audio on a separate recorder, as each device has its own internal master clock. Particularly problematic are long takes where there may be significant drift from camera to camera from the beginning to end of the take’s file. Even if the heads match, the tails of a take may not.

These drift problems can be mitigated during recording by using a Genlock (or “Sync”) Input on a camera which takes over the camera’s internal master clock. Wiring several cameras’ Genlock Inputs together forces all of the cameras to run at the exact same rate with no drift. This same concept applies to audio recorders using the Word Clock input. Genlock inputs are available only on higher-end cameras and Word Clock inputs are available on higher-end audio recorders.

Offset problems are easier to overcome than drift problems. By feeding each recording device with the same timecode signal, the files from different recording devices can all be in sync and there will be no offset in post-production.

The PIX 260i can address the synchronization issues of both offset and drift (heads and tails) via its built-in Ambient® Lockit with Genlock Out and Timecode Reader. The PIX 260’s Ambient® Lockit features an internal clock which has an accuracy of +/-0.2ppm (½ frame per 24 hours). Numerous PIX 260i recorders can be used to maintain extremely tight synchronization.

Sync Reference

The following table lists the available sources for sync reference. Depending on the current Mode (Audio or Video) and the transport state, some of these sources might not be available.

Signal	Connection	OSD
HDMI video	HDMI input	Sync: HDMI
SDI video	SDI input	Sync: SDI
Wordclock	SYNC IN	Sync: WCK
AES channels 1-2	Digital Audio I/O (DB-25)	Sync: AES1-2
Dante	Ethernet	Sync: Dante
Internal	None	Sync: Int

By default, The currently referenced synchronization source is always displayed on the OSD preceded by **Sync:**. When valid signal is present at the selected source, the OSD label will show with white text. When no valid signal is present at the selected source, the OSD label will flash and the text will be red. Additionally, when a source is selected that has no valid signal, or when the signal at a selected source is lost, a warning dialog will appear on the LCD.

Video Mode Synchronization

Setup Menu option [**Timecode/Sync - Sync Ref - Video Playback**].

In Video Mode the PIX 260i's sync source is always the incoming video signal when stopped and while recording. This is to ensure that the PIX 260i is always in sync with the incoming video source. During Playback of QuickTime files, the PIX 260i can reference its own Internal clock, or Video Input (SDI/HDMI).

If sync reference source is Video Input and the playback file's resolution and rate are different than the Video Input, the PIX 260i will automatically use it's Internal clock. The OSD label will flash with red text during playback to indicate this.

Audio Mode Synchronization

Setup Menu option [**Timecode/Sync - Sync Ref - Audio Only Mode**].

In Audio Mode, the audio sync reference source is used for both Record and Playback. Sync reference for Audio Only mode can be the PIX 260i's own Internal clock, Wordclock (Sync In), AES 1-2, Dante, or Video Input (SDI/HDMI).

The supported sample rates for audio synchronization are those available in the Setup Menu option [**Audio - Audio Mode Sample Rate**]. The PIX 260i will only lock to supported sample rates from any source (Including external sources). When an unsupported sample rate is present at the sync reference source, the OSD label will flash and the text will be red to indicate there is no synchronization occurring.

Timecode Reader

The PIX 260i includes a timecode reader which can accept incoming SMPTE timecode. The PIX 260i can read timecode from embedded SDI / HDMI or linear timecode fed into the TC IN BNC connector. The timecode reader is enabled whenever the Setup Menu option [**Timecode/Sync - Timecode Mode**] is set to **Ext TC (LTC)** or **Ext TC (SDI, HDMI)** which indicates that it will read external timecode.

Timecode Reader operation is useful for simple cases where the PIX 260i's timecode follows the camera timecode. The timecode of the PIX 260i's file will match exactly with the camera's file with zero-drift (since the PIX 260i is always synchronized with video input during recording in Video Mode. *see Video Mode Synchronization*).

In situations where a consistent offset is observed between PIX 260i files and other production recordings, the PIX 260i can offset the timecode stamp on each file. The Setup Menu option **[Timecode/Sync - File Start TC Offset]** allows for adjustment of the frame offset from **-10** to **+10** in increments of 1 frame. This setting does not affect timecode on the PIX 260i's outputs.

For shoots involving more than one camera or an audio recorder, using the PIX 260i's Timecode Generator can be more beneficial than using the Timecode Reader to achieve good heads and tails sync between all recordings.

Internal Ambient® Lockit: Timecode Generator with Sync Out

The PIX 260i includes an internal Ambient® ACL-203 Lockit which can be used as a master sync/timecode source for cameras or audio recorders. The Lockit is an ultra-high accuracy sync/timecode generator with < 0.2 ppm (½ frame per 24 hours) accuracy that is suitable as a master clock in all levels of productions. With its internal, rechargeable battery, accurate timecode is maintained for up to 2 hours after the PIX 260i is powered down. After 2 hours, the timecode value is reset. The battery is recharged automatically.

Multi-camera shoots using cameras that accept genlock input can benefit from the PIX 260i's built in Ambient® Lockit as their master sync and timecode source. Files from multiple PIX 260i recorders will have very tightly synchronized recordings with matching heads and tails.

Additionally, even multi-camera shoots utilizing lower-cost cameras (with no genlock or timecode) can benefit from the built-in Lockit. By using the Timecode Generator to stamp the beginning of each file, the heads of each take will match from several recorders, even if the tails drift due to using non-genlocked cameras.

Setting the Sync Out

The setting of this parameter is found in Setup Menu option **[Timecode/Sync - Sync Out]**. When the Sync Out of the PIX 260i is not needed, set this option to **Off**. When using the Lockit to generate the Sync (genlock) for a camera, the frame rate and resolution must be set for the camera's sync input. Consult the camera's documentation for information of which rates are accepted.

Additionally, there are two advanced modes under **[Timecode/Sync - Sync Out]**:

Genlock, Follows Video In and **Wordclock, Follows Video In**. **Genlock, Follows Video In** can be used to slave another camera's or audio recorder's genlock input to the camera feeding the PIX. Likewise, **Wordclock, Follows Video In** can be used to slave an external audio recorder to the camera driving the PIX to achieve perfect audio sync with zero drift. Drift is less likely to be an issue when recordings are kept short.

Timecode Modes

Freerun Timecode Mode

Generator mode. Timecode runs continuously. The value can be set by "jamming value" in the Setup Menu option **[Timecode/Sync - Jam Received TC]** or by manually setting a value from the Setup Menu option **[Timecode/Sync - Set Generator TC]**.

Record Run Timecode Mode

Generator mode. The PIX 260i sends running timecode while recording and stationary timecode while not recording. Timecode in this mode defaults to the last stationary value at power-up. When

switching to record run from another mode, the internal generator will stop at the last number generated. A user-defined value can be jammed into the internal generator from the Setup Menu option **[Timecode/Sync - Set Generator TC]**.

External Timecode Mode

Reader mode. The PIX 260's internal timecode generator follows an external timecode signal appearing at the BNC Timecode Input, timecode embedded on the SDI or HDMI input (*see SDI Input Embedded Timecode*). If the external timecode is removed the internal generator continues to run to preserve continuous timecode.

Timecode Frame Rate

In External mode, if the incoming frame rate does not match the frame rate as set in **Video - File Resolution/Rate**, the timecode frame rate display will appear orange to notify the user. The PIX will still record using the File Resolution/Rate.

Timecode Input Sources

Timecode BNC

The Timecode Input BNC accepts standard SMPTE timecode signal.

SDI or HDMI Input Embedded Timecode

The PIX 260i can use timecode embedded in the SDI or HDMI input signal.

[Timecode/Sync - Timecode Mode] must be set to **Ext TC (SDI, HDMI)**.

Synchronization/Timecode Examples

The following examples illustrate common scenarios where timecode and synchronization can be employed with the PIX 260i and other devices.

Single Video Camera, no Genlock



In this scenario, the video camera is the master source of the video sync. The timecode can either be read from the camera or be generated by the PIX 260i. The accuracy of the recording is dependent on the internal clock accuracy of the camera.

To receive timecode from the camera, set **[Timecode/Sync - Timecode Mode]** to **Ext TC (LTC)** for cameras that output standard SMPTE timecode to the PIX 260i's Timecode BNC. Alternatively, the PIX 260i can receive timecode from the SDI or HDMI input (if the camera sends timecode in this way) by setting **[Timecode/Sync - Timecode Mode]** to **Ext TC (SDI, HDMI)**.

The Setup Menu option **[Timecode/Sync - Sync Out]** can be set to several valid settings, including the following:

- **Off** - sync signal is disabled.
- **Genlock, Follows Video In** - Genlock for another camera or device is derived from the video signal of the single camera.

- **Wordclock, Follows Video In** - Wordclock for an audio device is derived from the video signal of the single camera.

Single Camera with Genlock Input, Genlocked from PIX

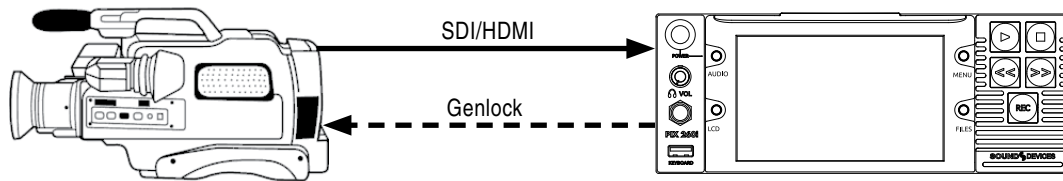

In this scenario, the PIX 260i is the master source of video sync. Set the output of the sync generator to a selected rate and connect the PIX 260i Sync Out (Genlock) to the same camera. Feed the timecode output of the PIX 260i into the timecode input of the camera.

Multiple Cameras with Genlock Input, all Genlocked from a Single PIX

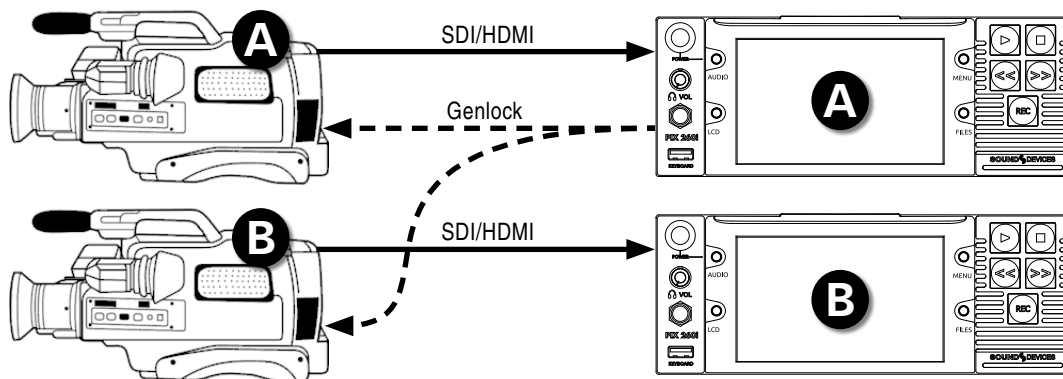

In this scenario, a PIX 260i is the master sync source for multiple cameras, each with or without their own PIX acting as a recorder. Because of this locked connection, the cameras can be run indefinitely and be assured of frame-accurate sync with no possibility of drift.

Set the output of the sync generator to a selected rate and connect the PIX 260i Sync Out (Genlock) and timecode output to multiple cameras ("mult" the genlock output). This connection uses the PIX 260i as both the video sync source and timecode source. Heads and tails sync for the camera's and PIX files will be perfect.

Camera #1 to PIX #1, Camera #2 to PIX #2, No Genlock

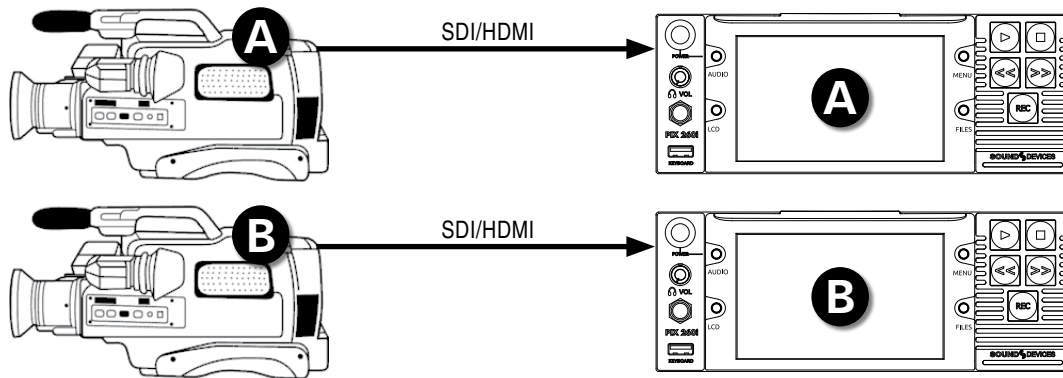

In this scenario, each camera is its own master video sync source, but the PIX 260i is the source of the timecode. The PIX 260i records its files based on the camera's clock. The heads will match perfectly, but the tails may drift depending on the cameras' clocks.

Camera to PIX with Word Clock Connection to Audio Recorder

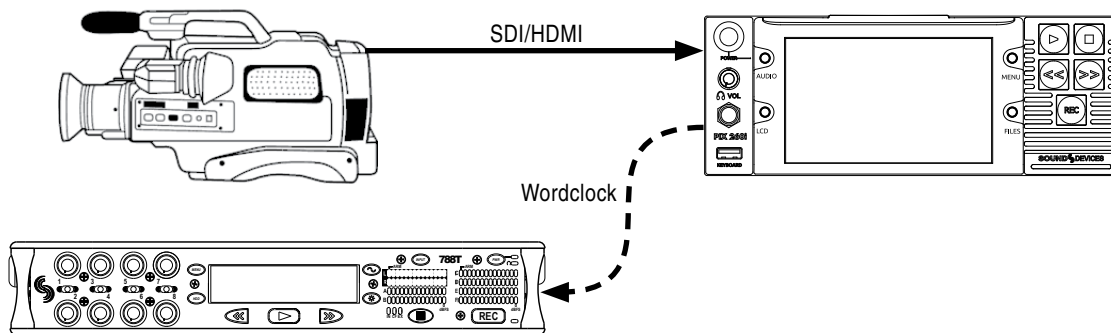

The word clock output on the PIX 260i is synchronous with incoming video signal. The word clock output can be used to sync external audio recorders to any camera. To enable word clock output, set Setup Menu item **[Timecode/Sync - Sync Out]** to **Wordclock, Follows Video In**.

External Control

RS422

The PIX 260i conforms to the Sony P2 (9-pin) machine control standard over RS422. The PIX 260i acts as a slave only, not as a master. To enable RS422 set **[Remote Control - RS422]** to **On**.

The following table lists the tested RS422 controller models and the supported functions for each model.

Command	DNF ST300	JLC-ES450
RECORD	Yes	Yes
STOP RECORDING	Yes	Yes
PLAY	Yes	Yes
PAUSE	Yes	Yes
STOP PLAYBACK	Yes	No (Pause only)
FFWD	Yes	Yes
REW	Yes	Yes
JOG	Yes	Yes
SHUTTLE	Yes	Yes
T-BAR	Yes	n/a
REC and PLAY TIMECODE	Yes	Yes

Please note that the JLC-ES450 does not read machine transport status information from the PIX 260i but the DNF ST300 will.

PIX Grouping

When multiple PIX 260i units are in use, they can be grouped together to ease transport control and setup. A grouped PIX 260i will retain all settings made before being grouped. If a change is made to any PIX 260i in the group, the setting will be changed on all other PIX 260i units in the group. Grouped PIX 260i units do not have a master slave relationship, they are all effectively “masters”.

If a transport command or settings change has to be made to only one unit in a group, ungroup the input, make the change, then regroup the PIX 260i. To quickly toggle between no group and the current group setting, press and hold the MENU button then press the Control Knob.

To group units, connect all PIX 260i units via Ethernet ports or connect them all to the same network. Enter **[Network - Network Group]** and set all PIX 260i units to the same group number.

Group Transport

The Record, Stop, and Pause transport commands will always affect all units in the group. When a file is played back on a grouped unit, the other units in the group will only begin playback if a file of the exact same name is present on those units. Fast Forward, Rewind, Cue Points, and Looping are not group transport functions.

Non-Grouping Settings and Functions

The following settings and functions will only apply to the PIX 260i that they are performed on, even when the unit is grouped.

Settings	Functions
<ul style="list-style-type: none"> • [File Storage - Erase/Reformat] • All settings in [Timecode/Sync] section besides [Sync Ref - Video Playback] and [Sync Ref - Audio Only Mode] • All settings in [Network] section besides [Ethernet File Transfer] • [System - Set Date/Time] • [System - Update Software] • All functions in [Quick Setup] section 	<ul style="list-style-type: none"> • Audio Track Arm • Audio Track Name • Transport: Fast forward, Rewind, Shuttle playback, Cue Points, and Looping • Powering up and powering down • LCD assist functions (Zoom, Focus, and Exposure)

Web Interface - PIXNET

When either the primary (PRI) or secondary (SEC) Ethernet ports on the PIX 260i rear panel are connected to an Ethernet network (via switch or router), or direct to a computer (ad-hoc), the PIX 260i can be controlled remotely via PIXNET. PIXNET is a built-in web server with an intuitive GUI and is accessed with an HTTP connection using a web browser. The interface is designed for use with current versions of Chrome and Safari. Multiple PIX 260i's can be accessed at the same time from the same web browser window using tabs.

The PIX 260i's web IP address must be determined before accessing PIXNET:

1. Make sure that the PIX 260i is powered on and connected to a network or directly to a computer via one of the rear panel Ethernet connectors.
2. The PIX 260i must have a unique name when controlling multiple PIX 260i units via PIXNET. Verify that the PIX 260i has a unique name in [Network - This PIX's Name].
3. The PIX 260i can automatically find a unique IP Address when [Network - Auto IP Settings] is set to **On**. This is the recommended method for setting up IP connections on the PIX 260i. If needed, the IP settings can be manually entered. To manually enter IP settings, set [Network - Auto IP Settings] to **Off**. Then manually enter [Network - IP Address - Subnet Mask -Gateway] values.
4. Open the web browser and enter the IP address displayed on the PIX 260i OSD or listed in [Network - IP Address] into the web browser's address bar.

PIXNET All Units Page

When PIXNET is launched the first page displayed is the All Units Page. This is a quick overview of all PIX 260i units connected to the network. Information available is PIX Name, IP Address, Video Input details, Video Codec details, and assigned Group number. From this page, a PIX 260i can be allotted to a particular group. *See PIX Grouping* Click on the PIX 260i name to open the Unit Page for that particular PIX 260i.

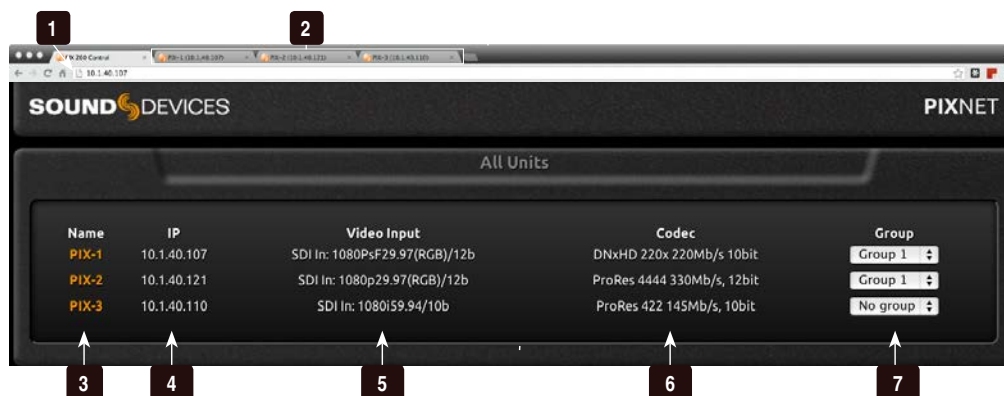

- 1) **Address Bar**
Type in PIX 260i IP Address to connect to PIXNET.
- 2) **Unit Page Tabs**
Each Unit Page can be opened in a separate browser tab
- 3) **PIX 260i Name**
Lists all PIX 260i connected to the network. Click on a Name to open the Unit Page for a particular unit.
- 4) **IP Address**
Displays the IP Address for all PIX 260i units currently on the network.
- 5) **Video Input List**
Displays Video Input for all PIX 260i units currently on the network.
- 6) **Codec List**
Displays Codec for all PIX 260i units currently on the network.
- 7) **Group**
Displays Group settings for all PIX 260i units currently on the network. Group settings can be edited using the drop-down menu for each PIX 260i.

PIXNET Unit Page

The Unit page allows for near full remote control of the PIX 260i via the web browser.

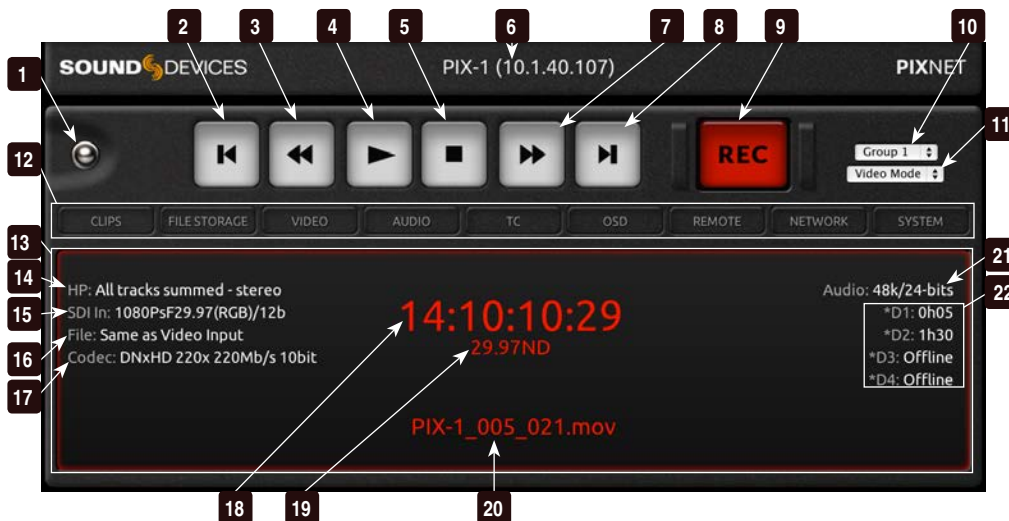

- 1) **All Units Page Button**
Click to return to All Units Page.
- 2) **Previous**
Jumps to the beginning of the file.
- 3) **Rewind**
Acts as Rewind button. When selected the clip will reverse at x2 speeds.
- 4) **Play**
Functions as PLAY button.
- 5) **Stop**
Functions as STOP button
- 6) **Unit Name and IP Address**
Displays the name and IP Address of the current Unit Page PIX 260i.
- 7) **Fast Forward**
Acts as Fast Forward button. When selected the clip advances at x2 speed. Click again for 16x speed.
- 8) **Next**
Jumps to the next file.
- 9) **Record**
Functions as REC button.
- 10) **Group**
Displays current Group setting, quickly change designated group or remove from group using the drop-down menu.

- | | |
|--|---|
| <p>11) Video/Audio Mode
Displays current Video/Audio Mode setting. Switch between Video and Audio modes using the drop-down menu.</p> <p>12) Menu Tabs
Clicking on each tab will display a different menu. <i>See PIXNET Unit Page Views</i></p> <p>13) Main View
Default view of PIXNET. When no View tab is selected the main view is displayed, as shown.</p> <p>14) Headphone Selection
Displays current headphone selection.</p> <p>15) Video Input
Displays the source and current resolution and rate of incoming video.</p> | <p>16) File
Displays the current resolution and rate of incoming file.</p> <p>17) Codec
Displays the current Codec selection.</p> <p>18) Timecode
Displays the current timecode value.</p> <p>19) Frame Rate
Displays the current timecode frame rate.</p> <p>20) File Name
Displays the current file name.</p> <p>21) Audio
Displays the current audio settings.</p> <p>22) Drive Status 1-4
Displays the drive status of all drives (D1-D4).</p> |
|--|---|

PIXNET Unit Page Main View and Menu Tabs

The Unit Page can display many different menus. The menus are accessed by clicking on the tabs of the Unit Page.

Please note that not all PIX 260i menu items or features are available from PIXNET.

Main View

The Main View is always the first to appear when a Unit Page is open and is displayed whenever no other tab is selected. It is the only view active while in Record and Playback. The contents of this view are covered in detail in PIXNET Unit Page.

Clips Menu

The Clips Menu is the PIXNET version of the PIX 260i File List. From the Clips Menu select a drive. The currently selected drive contents are displayed. Reel, file Name and location, creation date, and file size are all displayed. Click on a file name to playback the file.

File Storage Menu

The File Storage Menu provides quick access via the web browser to the PIX 260i **File Storage** menu options. Menu settings are displayed and can be edited directly from the web browser.

Video Menu

The Video Menu provides quick access via the web browser to the PIX 260i **Video** menu options. Menu settings are displayed and can be edited directly from the web browser.

Audio Menu

The Audio Menu provides quick access to the various PIX 260i audio settings and windows. These are separated by views Audio Settings, Tracks, and Output Matrix. When Audio Settings is selected, the PIX 260i **Audio** menu options are displayed and can be edited directly from the web browser. When Tracks is selected, all the settings from the PIX 260i Audio Screen are displayed and can be

edited. When Output Matrix is selected, a comprehensive track-to-output matrix appears. From this view route any PIX 260i track to any output.

TC Menu

The TC Menu (timecode) provides quick access via the web browser to the PIX 260i **Timecode/Sync** menu options. Menu settings are displayed and can be edited directly from the web browser.

OSD Menu

The OSD Menu (On-screen display) provides quick access via the web browser to the PIX 260i **Timecode/Sync** menu options. Menu settings are displayed and can be edited directly from the web browser.

Remote Menu

The Remote Menu provides quick access via the web browser to the PIX 260i **Remote Control** menu options. Menu settings are displayed and can be edited directly from the web browser.

Network Menu

The Network Menu provides quick access via the web browser to the PIX 260i **Network** menu options. Menu settings are displayed and can be edited directly from the web browser. In this menu the **Ethernet File Transfer** option can be remotely activated. This allows for remote transfer of files from the PIX 260i.

System Menu

The System Menu provides quick access via the web browser to the PIX 260i **System** menu options. Menu settings are displayed and can be edited directly from the web browser.

Triggering Recording from External Timecode

The PIX 260i can be configured to start recordings when incoming timecode begins rolling and stop when it becomes stationary. This is generally referred to as Record Run timecode. The master timecode device should be setup in this manner. To configure the PIX 260i to follow Record Run commands:

1. Set Setup Menu option **[Remote Control - Rec Start/Stop]** to **Timecode**
2. Make sure that the device that is sending timecode is configured to send stationary timecode while stopped and running timecode while recording.
3. Some cameras do not send the correct timecode in the first few seconds of a recording, or they send short bursts of timecode causing the PIX 260i to record short unintentional files. The **[Timecode/Sync - Auto Record Hold Off]** feature is designed to eliminate these issues. When a hold off value is applied, the PIX 260i will begin capturing the moment timecode begins rolling but will only go into record if a valid timecode signal is present after the hold off time has elapsed.

*Triggering from external timecode will not cause the PIX 260i to automatically stamp external timecode to recorded files. The timecode stamped to files is determined by the setting **[Timecode/Sync - Timecode Mode]***

Triggering Recording from SDI Flag Bits

Start and stop flags embedded in the SDI signal from some cameras can be used to start and stop recording of the PIX 260i. To enable this feature, set Setup Menu option **[Remote Control - Rec Start/Stop]** to the **SDI Flag** option that refers to the manufacturer of the connected camera.

GPIO (General Purpose Input / Output)

The 10-pin Phoenix connector provides six GPIO logic points. These can be used as simple-closure inputs, and to drive LEDs or relays. The following table lists the pin assignments of the GPIO connector.

Pin	Function
1	(-) Ground. Provides access to ground for triggering logic-low connections.
2	REC Input. Triggers PIX 260i record.
3	Play Input. Triggers PIX 260i play.
4	Stop Input. Triggers PIX 260i stop.
5	(unused)
6	(unused)
7	REC Output. Activates upon PIX 260i record.
8	Play Output. Activates upon PIX 260i play.
9	Stop Output. Activates upon PIX 260i stop.
10	+5V DC Output. Constant source of +5V for triggering logic high connections.

GPIO inputs (pins 2, 3, and 4) and GPIO outputs (pins 7, 8, and 9) can be set to “logic high” or “logic low”. Logic high connections will trigger to the presence of +5V (GPIO input) or output +5V when the function is active (GPIO output). Logic low connections will trigger when connected to ground (GPIO input) or become connected to ground when the function is active (GPIO output).

To configure GPIO connections as logic high or logic low, access Setup Menu option **[Remote Control - GPIO Inputs]** or **[Remote Control - GPIO Outputs]**.

The GPIO Outputs can be used to drive LEDs with a proper series resistor. Resistor values will vary from LED to LED, 470 ohms is a good starting point.

USB Keyboard

The PIX 260i supports standard USB keyboards connected to the USB A connector on the front Panel. The keyboard can be used to navigate menus, enter text, and control PIX 260i Transport functions. The following table shows common functions for an attached keyboard:

Keyboards with integrated USB hubs are not supported.

Key	Function
F1	Functions the same as the MENU button.
F2	Functions the same as the FILES button.
F3	Functions the same as the AUDIO button.
F4	Functions the same as the LCD button.
Menu Key	Functions the same as the MENU button.

Key	Function
Ctrl + R	Functions the same as the Record button.
Ctrl + S	Functions the same as the Stop button.
Space Bar	Functions the same as the Play button.
Arrow Keys	Up/Down function the same as Control Knob turn. Left/Right function the same as Rewind and Fast Forward keys.
Return/Enter	Functions the same as pressing the Control Knob.
Ctrl + L	Loop Mode toggle.
Ctrl + Q	Delete Cue Marker
Ctrl + Alt + F10	Enters Menu Customization. (In Menu only)
Escape	Exits / cancels current dialog.
Page Up Page Down	Moves the highlight to the top or bottom of displayed list elements.
End	Moves the highlight to the end of a list.
Home	Moves the highlight to the beginning of a list.

F1, F2, F3, and F4 keys can be pushed in combinations to activate button shortcuts, just like their respective buttons on the PIX 260i. See [Shortcuts](#)

Storage and File Management

Storage

The PIX 260i records on up to four separate storage devices simultaneously. There are two PIX-CADDY slots on the front panel which are accessed by pulling the LCD Handle forward and tilting the LCD down. Additionally, there are two eSATAp connections on the rear panel. The four drive connections are numbered 1 to 4. Functions on the PIX 260i will refer to the drives using these numbers.

PIX-CADDY

Drives 1 and 2 are PIX-CADDY slots behind the LCD on the Front panel.

The PIX-CADDY allows for simple, quick, and solid connection and removal of drives for file storage and exchange. When connected to a PIX 260i, whether powered on or off, the caddy's USB 3.0, FireWire 800 connections are disabled. When the PIX-CADDY is removed from a PIX 260i, it operates as a high-speed data interface for transferring files from the drive to a computer. Only one data connection can be used at a time. See PIX-CADDY documentation for details on attaching a 2.5" drive to the PIX-CADDY.

eSATA

Drives 3 and 4 are eSATAp connections on the Rear panel. These connections can be used to power an external drive via 5V eSATAp, or they can be used with powered external enclosures using an eSATA (non-powered) cable. It is important to use an approved drive and external enclosure to ensure proper performance. An up-to-date list of supported storage devices can be found online: <http://www.sounddevices.com/approved>

Supported Storage Devices

Sound Devices maintains a list of storage devices that are approved for use with the PIX 260i. An up-to-date list of supported storage devices can be found online: <http://www.sounddevices.com/approved>

Approved mechanical drives are recommended for use only in stationary applications. Excessive vibration or motion may cause data corruption when using mechanical drives.

The PIX 260i formats and writes to a UDF (v2.50) filesystem. The UDF filesystem is readable and writable by Mac OS X, Windows 8, Windows 7, and Windows Vista. Files stored in a UDF filesystem are not restricted to 4GB, unlike FAT32 (a commonly utilized filesystem in other digital recorders). Storage devices to be used with the PIX 260i must be formatted by the PIX 260i.

Mounting PIX formatted UDF volumes to virtual machines is not supported.

UDF volumes are not readable by Windows XP. A third-party UDF driver that enables writing to UDF volumes is available for Windows XP, however it is not officially supported for use with PIX formatted volumes.

Formatting

To format a drive:

1. Make sure the drive to be formatted is connected to the recorder and note which drive number it is.
2. Open Setup Menu option **[File Storage - Erase/Re-format]**.
3. Choose the **Erase/Re-format: Drive Number** for the drive to be formatted or **Erase/Re-format: All Drives** option.
4. A confirmation dialog will appear: "All data will be erased. Continue?". Use the Control Knob to select **OK**.
5. Use the displayed on-screen keyboard (or an external USB keyboard, if attached) to enter a volume label for the drive, and then use the Control Knob to select **OK** to initiate the format. When formatting all drives at once, the volume label is applied to all drives but each drive will be suffixed with an underscore and drive number to distinguish between drives.

Target Storage Device for Recording

The PIX 260i can record directly to four drives simultaneously. The PIX 260i will record to any approved drive that is attached and set to **On** in **[File Storage - Record to Drive]**. The OSD will show all drives that are set to **On** with an * (asterisk). When in record the targeted drive's OSD item will be red.

Metadata

Several parameters can be set within the Setup Menu **File Storage** to aid in the organization of files. Some of this metadata can be used in naming the file which is to be recorded. Folders are created on the drives based on the Reel number. QuickTime files contain reel and timecode metadata. Broadcast Wave files contain bEXT and iXML chunks that store various metadata information such as timecode, scene, take, reel, and audio track names.

CamID

The CamID field consists of a single alpha character. It is intended to indicate which physical camera shot the content for the take.

Reel

The reel can be considered a container for all assets generated during a recording session or day's work. This field consists of a numeric value between 1 and 999. It is intended to indicate what reel the recording is part of. The PIX 260i will create a folder at the root level for each Reel. Recorded files are placed inside the current Reel folder.

Name	
▶	001
▼	010
	010_BOAT_002.mov
	010_BOAT_003.mov
	010_BOAT_004.mov
	010_BOAT_005.mov

Clip

The Clip field consists of a numeric value between 1 and 999. It is intended to indicate what clip number the recording is. This field can be set manually and will increment each time a new file is recorded. The Clip number will reset to 1 when the Reel number is changed.

Scene/Shot

The Scene/Shot field consists of an alpha-numeric value. Use this field to indicate a descriptive name for the current scene or shot.

Take

The Take field consists of a numeric value between 1 and 999. It is intended to indicate what take number the clip is, relative to the scene. This field can be set manually and will increment each time a new file is recorded. The Take number will reset to 1 when the Scene name is changed.

Audio Track Name (Audio Only)

Audio Track Names are stored in the metadata of the Broadcast Wave File only. Audio Track Names are set in the Audio Screen in the Name column. To edit the name of an audio track:

1. Press the Audio button to access the Audio Screen.
2. Select the Name box for the desired track using the Control Knob to move vertically and REW and FF to move left and right.
3. Press the Control Knob to edit the track name.
4. Use the displayed on-screen keyboard (or an external USB keyboard, if attached) to enter a new track name, and then use the Control Knob to select **OK** to save and exit back to the Audio Screen.

File Management

The PIX 260i provides several tools for file management and metadata entry. File management of files to be recorded is managed in **File Storage**. File management for files previously recorded material is handled in the File List. *See [File List and File Details for navigation and basic overview](#).*

File Size Limit

To aid in maintaining manageable file sizes, the PIX 260i will automatically begin writing a new file after a set amount of minutes has elapsed in a recording (Video Mode) or after a file size limit has been reached (Audio Mode). The beginning of this new file will be seamless to the ending of the previous file. The default time before splitting the file is 60 minutes (Video Mode). The Setup Menu option **[File Storage - QuickTime File Split every]** adjusts the amount of time before a file split occurs. File split options include 1, 5, 10, 15, 30, or 60-minute splits. The default file size is 4GB (Audio Mode), this can be reduced to 2 GB in **[File Storage - Wave File Split every]**.

File Naming

Files are named according to the file name format as set with Setup Menu option **[File Storage - File Name Format]**. The options for file name format include various combinations of CamID, Reel, Clip, Scene/Shot, and Take metadata fields. The file name format can also be prefixed with the PIX Name as defined in **[Network - This PIX's Name]**. To prefix the file name with the PIX name, set **[File Storage - File Name Prefix]** to **PIX Name**.

RED File Format

When the Setup Menu option **File Storage - File Name Format** is set to **RED File Format**, the PIX 260i will

- Generate files that follow the same naming convention used by RED cameras.
- Extract the CamID, Reel number, and Clip number from the SDI input signal from a RED One or RED Epic camera and apply it to the file name and appropriate metadata fields of each recorded file. *See [Metadata](#)*

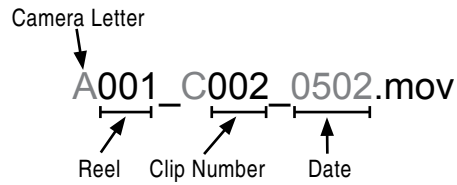

Arri File Format

When the Setup Menu option **[File Storage - File Name Format]** is set to **Arri File Format**, the PIX 260i will:

- Generate files that follow the same naming convention used by Arri cameras.
- Extract the CamID, Reel number, and Clip number from the SDI input signal from the Arri camera and apply it to the file name and appropriate metadata fields of each recorded file. *See Metadata*

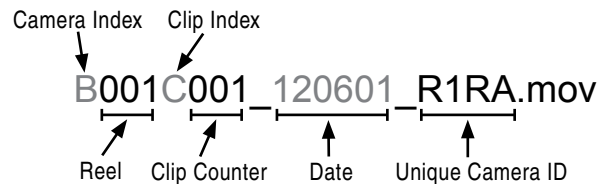

Folder Structure

All files generated by the PIX 260i are placed into a Reel folder. The Reel Folder name/number is defined by the Reel metadata, which is set in **[File Storage - Reel]**. When using the RED or Arri File Formats, the PIX 260i will generate a Reel folder based on the camera's reel metadata.

Deleting a File

Any file that appears in the Take List can be deleted directly from the PIX 260i. To delete a file:

1. Press the FILES button to enter the File List.
2. Scroll with the Control Knob to highlight and select the file to be deleted. Once highlighted, press the Control Knob to enter the File Details view.
3. Highlight and select the Delete option. A dialog will appear to confirm the deletion. Turn the Control Knob to highlight and select "OK".

Transferring Files

USB, Firewire, Thunderbolt

Files on PIX 260i formatted storage volumes (approved 2.5" drive or external storage device) can be copied to a computer by removing the storage device from the PIX 260i and connecting it to a computer. Storage devices formatted with the PIX 260i recorder use the UDF filesystem. *See File Storage*

The Firewire 800 and USB 3.0 connectors on the PIX-CADDY are disabled when the PIX-CADDY is attached to the PIX 260i. When attaching the PIX-CADDY to a computer, either the Firewire 800 or the USB 3.0 connection must be used; not both.

Sound Devices recommends first copying files from the drive to the computer and then editing the files. It is not recommended to edit files directly off of the drive.

Do not copy unsupported files from a computer (or any other host device) to a drive that is intended to be used by the PIX 260i. If this occurs, it is advisable to format the drive with the PIX 260i before making new recordings. See Appendix A for currently supported files

Ethernet File Transfer (Samba)

Samba is an industry standard networking protocol that enables files to be transferred from the PIX 260i to any destination with access to the network. Ethernet File Transfer can be initiated remotely via PIXNET (web browser interface). Ethernet supports data rates up to a theoretical maximum of 1Gbps. In reality, data transfer speeds over Ethernet are dependent on network traffic and many other factors. To transfer files from the PIX 260i drives to a local area network or a computer over Ethernet follow these steps:

1. Attach an Ethernet cable from either PIX 260i Ethernet port to a computer or a LAN (Local Area Network) connection.
2. Set **[Network- Ethernet File Transfer]** to **On**. All drives are now attached to the Network and are unavailable to the PIX 260i for read or write actions. The Drive Status field on the OSD will read "Network" in this mode.
3. From Mac, go to the Finder and select Go>Connect to Server. Enter the server address "smb://(IP Address of the PIX 260i as shown on OSD and in **[Network - IP Address]**)" then click Connect. Connect as a Guest User. All attached PIX 260i drives will be displayed. From Windows, Go to Run type in "\\(IP Address of the PIX 260i as shown on OSD and in **[Network - IP Address]**)\sata". All attached PIX 260i drives will be displayed.
4. Transfer files from the PIX 260i drives to the computer or other LAN device.
5. Set **[Network- Ethernet File Transfer]** to **Off** to remount the drives for further use on the PIX 260i. Allow time for the drives to remount before Recording or Playing back files. The Drive Status OSD field will return to white when the drives are ready.

If the PIX 260i is in a group, setting Ethernet File Transfer to On will enable Ethernet File Transfer for all units in the group!

Ethernet File Transfer only supports file transfer from the PIX 260i to a destination. Files cannot be transferred to PIX 260i drives over Ethernet. When Copying files to PIX 260i drives use USB, FireWire, Thunderbolt, or eSATAp.

Setup Management and Firmware Upgrades

Saving and Loading Setup Files

To save all of the current settings to a setup file, select the Setup Menu option **[Quick Setup - Save Settings to Drive 1]**. Use the on-screen keyboard (or attached USB keyboard) to enter a name for the setup file. This will save all of the current settings to an XML file at root of Drive 1. To load a previously saved setup file, select the Setup Menu option **[Quick Setup - Load Settings from Drive 1]**. The setup XML file will have to be copied to the root of Drive 1 prior to attempting to load it.

For a complete list of available Setup Menu options, *see Setup Menu Options*.

Formatting a storage device will also remove any setup files that are on the drive. Setup files can be stored on a computer and copied back to the root of a PIX 260i drive to be loaded on the PIX 260i.

Custom Default Settings and Setup Menu Option Visibility

The Setup Menu option **[Quick Setup - Load Factory Settings]** loads a setup that is saved internally to the PIX when it leaves the factory. It is possible to alter this “factory” setup, so that the Setup Menu option **[Quick Setup - Load Factory Settings]** will load a custom default.

It is also possible to hide specific Setup Menu parameters and options. This is useful for Setup Menu options that are not commonly used in a particular workflow, or to simplify use when lending the unit to another user.

To customize defaults and Setup Menu option visibility:

1. Attach a USB keyboard to the PIX 260i’s USB keyboard jack.
2. Press the MENU button to enter the Setup Menu.
3. Press Ctrl + Alt + F10 on the keyboard. If this is the first time this action has been performed since powering the PIX 260i up, a password dialog will appear. Enter the password (the default password is “default”).
4. After the correct password has been entered, the Settings Customization Menu will appear. Select **Edit Menu & Default Values**.

Drive 3 FILE LIST

Reel 001 [4]		Today, 9:49AM	2.12GB
PIX_001_004.mov	1	Today, 9:28AM	0.15GB
PIX_001_003.mov		Today, 9:28AM	0.62GB
PIX_001_002.mov	2	Today, 9:27AM	0.83GB
PIX_001_001.mov		Today, 9:26AM	0.53GB

5. The Setup Menu will be shown with a colored background. There will be check boxes next to each menu item. Navigate the menu with the Control Knob, as usual.

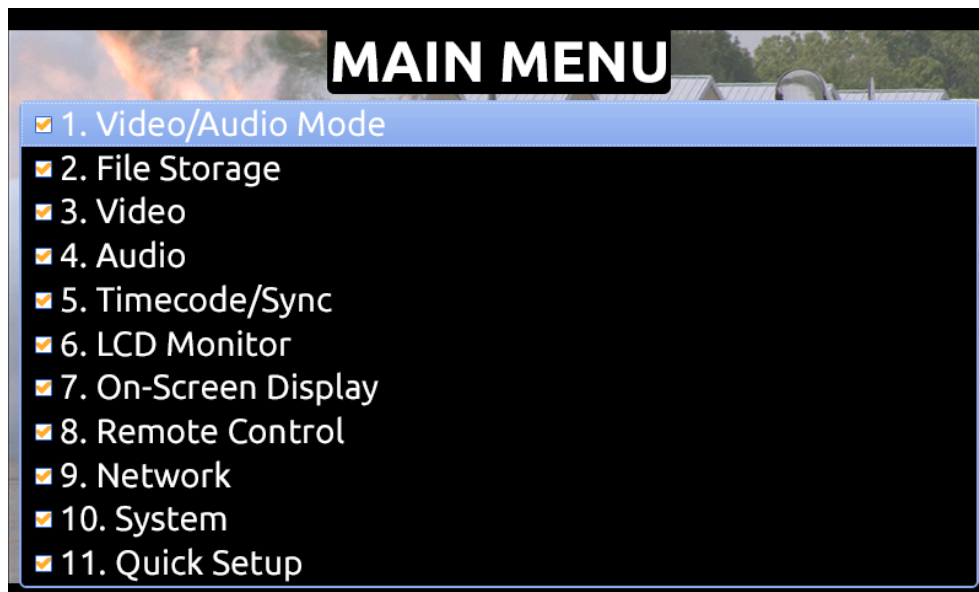

6. To to change the visibility of an item in the Setup Menu, push the spacebar on the keyboard while the item is highlighted. Checked items will be displayed in the Setup Menu and unchecked items will not be displayed.

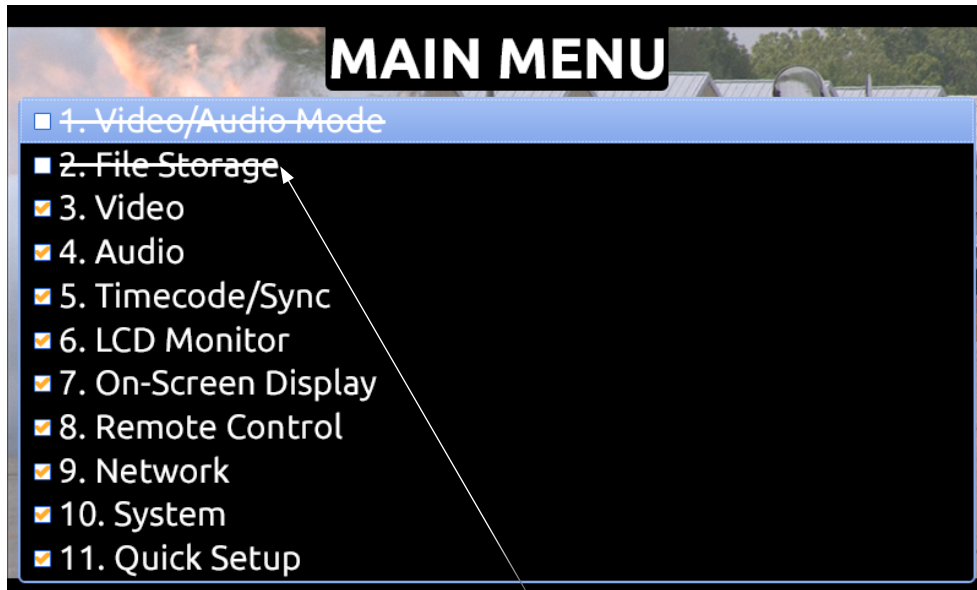

Crossed out items will be hidden

7. Settings changed at this point will become the default settings.
8. When finished, press Esc or F1 on the keyboard. This will show the Settings Customization Menu again. Select any of the save options.

Keep a record of the password, if it is changed. A lost password could result in undesirable limitations.

The Settings Customization Menu option **Reset to Factory Settings** will make all Setup Menu items visible and revert default settings to factory defaults.

Firmware Upgrades

At times, Sound Devices makes firmware updates available for PIX 260i. These updates are easy to apply:

1. Download the new .prg file from the Sound Devices website.
2. Copy this file to an approved drive, and connect to the PIX 260i.
3. Ensure that the power source for the PIX 260i is reliable. Power loss during a firmware upgrade process can produce unexpected results.
4. From the **System** menu in the Setup Menu, select **Firmware Update**. The PIX 260i will search for the .prg file and give the option to install the first file that it finds (cancelling this dialog will cause the PIX to search for another .prg on any attached storage devices). When the correct .prg file has been located, highlight the **OK** button and press the Control Knob to begin the firmware update.
5. The PIX will verify that the file is not corrupted, then it will update the firmware. When done the unit will need to be powered down and then back up.

Firmware updates can take several minutes to complete. Never pull power during a firmware update.

Setup Menu Options

The Setup Menu controls a wide range of parameters for the PIX 260i. The parameters are organized into categories, making the setup Menu easy to navigate. The following tables show the parameter name, a description, options available, and the factory default setting where applicable.

Default settings can be altered. See Setup Management

Video/Audio Mode

#	Parameter Name	Description	Options
1	Video/Audio Mode	Switch between Video Mode (audio and video information recorded to Quicktime .mov files) and Audio Mode (audio recorded to .wav files and video not recorded)	» Video + Audio (Quicktime) • Audio Only (Wave)

File Storage

#	Parameter Name	Description	Options
1	Record to Drive	Enable or disable recording to Drive 1-4	» On (Drives 1-4) • Off
2	Quicktime File Split Every	Choose the maximum file recording time. When set time is exceeded a new .mov file is created automatically. Since ProRes and DNxHD codecs are variable bit rate, the size of each file will vary, even though the running time will be the same.	• 1 min • 5 min • 10 min • 15 min • 30 min » 60 min
3	Wave File Split Every	Choose the file size limit of .wav files. When the limit is reached, the PIX 260i will create a new .wav file (labeled sequentially) and continue recording.	• 2 GB » 4 GB
4	File Name Format	The format for file names as they are written to the drive.	» Drive_Reel_Clip • Reel_Clip • CamID_Reel_Clip • Reel_Scene_Take • Scene_Take • RED File Format • Arri File Format
5	File Name Prefix	Text to be placed before all other characters in each file name. PIX Name is set in [Network - This PIX's Name]	• Off » PIX Name
6	CamID	An identifying character for a camera	» A (single alpha to "Z").
7	Reel	Current Reel number. When the Reel number is altered, the Clip number is reset to 1	• 1 (numeric)
8	Clip	Current Clip number. When the Reel number is altered, the Clip number is reset to 1	» 1 (numeric)
9	Scene/Shot	Current Scene name. When the Scene name is altered, the Take number is reset to 1.	» "Scene 1" (multi alphanumeric)
10	Take	Current take number. When the Scene name is altered, the Take number is reset to 1.	» 1 (numeric)

#	Parameter Name	Description	Options
11	Erase/Reformat	Format any or all attached drives. When all is selected, all drives will share the same volume label but each drive name will be suffixed with a unique drive number.	<ul style="list-style-type: none"> • Erase/Re-format: Drive 1 • Erase/Re-format: Drive 2 • Erase/Re-format: Drive 3 • Erase/Re-format: Drive 4 • Erase/Re-format: All drives

Video

#	Parameter Name	Description	Options
1	Video Input	Physical source to derive recorded video from.	<ul style="list-style-type: none"> • HDMI » SDI
2	File Resolution/Rate	The resolution and frame to be recorded and sent to video outputs.	<ul style="list-style-type: none"> » Same as Video Input • 1080p30/29.97 • 1080p25 • 1080p24/23.976 • 1080i60/59.94 • 1080i50 • 1080PsF30/29.97 • 1080PsF25 • 1080PsF24/23.976 • 720p60/59.94 • 720p50 • 720p30/29.97 • 720p25 • 720p24/23.976 • 576i59 (PAL) • 480i59.94 (NTSC)
3	Codec	The video codec to use for encoding. Note for DNxHD that the rates listed are assuming 1080p30. If a different resolution and frame rate is selected, the PIX 260i will use the corresponding DNxHD data rate.	<ul style="list-style-type: none"> • DNxHD 220x 220Mb/s, 10bit • DNxHD 220 220Mb/s, 8bit • DNxHD 145 145Mb/s, 8bit • DNxHD 36 36Mb/s, 8bit • ProRes 4444 330Mb/s, 12bit • ProRes 422HQ 220Mb/s, 10bit » ProRes 422 145Mb/s, 10bit • ProRes 422LT 100Mb/s, 8bit • ProRes 422Proxy 36Mb/s, 8bit
4	Up Conversion	Method for converting SD input video to HD recorded content.	<ul style="list-style-type: none"> • 4:3->16:9 Anamorphic » 4:3->16:9 Pillar Box • 4:3->16:9 Zoom Letterbox • 4:3->16:9 Zoom 14:9 • 4:3->16:9 Zoom Wide
5	Down Conversion	Method for converting HD input video to SD recorded content.	<ul style="list-style-type: none"> » 16:9->4:3 Letterbox • 16:9->4:3 Crop • 16:9->4:3 Anamorphic
6	Input PsF Detect	When set to "Auto", the PIX will sense PsF signal based on a flag within the signal stream. Most devices with SDI output will provide this flag, however some SDI outputs and all HDMI outputs will not provide this flag. When sending PsF signal from these devices, choose "Interpret 1080i as PsF"	<ul style="list-style-type: none"> » Auto • Interpret 1080i as PsF
7	SDI Output Type	HD output type employs SMPTE 292M / HD-SDI on SDI output. 3G output type employs SMPTE 424M / 3G-SDI on SDI output.	<ul style="list-style-type: none"> » HD (4:2:2 10-bit) • 3G (4:4:4 12-bit)

#	Parameter Name	Description	Options
8	Video Output OSD	Superimpose the current timecode over the video signal on the selected output. Timecode value appears in lower left corner of the frame.	» Off • SDI out • HDMI out • SDI + HDMI out

Audio

#	Parameter Name	Description	Options
1	Audio Mode Sample Rate	The sample rate of recorded .wav files	• 44.1 kHz • 47.952k • 47.952kF » 48k • 48.048k • 48.048kF
2	Audio Mode Bit Depth	The bit depth of recorded .wav files	• 16-bits » 24-bits
3	Input Gain Linking	When Input Gain is linked, adjusting an Input's gain adjusts all other Input Gains by the same amount. Any offsets at the time of linking are maintained.	» Off • On
4	Input Delay Linking	When Input Delay is linked, adjusting an Input's delay adjusts all other Input delays by the same amount. Any offsets at the time of linking are maintained.	» Off • On
5	HDMI/AES Select	Choose between HDMI or AES for digital audio input.	» HDMI Inputs • AES Inputs
6	HP Source	Choose the source for Headphone output and the 2 channel meters on the OSD.	• 1,2 • 3,4 • 5,6 • 7,8 • 9,10 • 11,12 • 13,14 • 15,16 • 17,18 • 19,20 • 21,22 • 23,24 • 25,26 • 27,28 • 29,30 • 31,32 • All tracks summed - mono » All tracks summed - stereo
7	Line Out Source	Sub-menu. Choose output source for each line output (1-8)	• <i>Track 1 - Track 32 (per output)</i> » Track 1-8 (per output)
8	HDMI/AES Output	Sub-menu. Choose output source for HDMI and AES outputs (1-8)	• <i>Track 1 - Track 32 (per output)</i> » Track 1-8 (per output)
9	SDI Output	Sub-menu. Choose output source for SDI output (1-16)	• <i>Track 1 - Track 32 (per output)</i> » Track 1-16 (per output)
10	Audio Signal Generator	Enable audio test to all outputs.	» Off • On
11	Audio Tone Level	Level of audio test tone (dBFS)	» -20 dBFS (numeric -40 to 0)

#	Parameter Name	Description	Options
12	Audio Screen Meters	Amount of audio tracks displayed at a time in the Audio Screen. (All 32 tracks are accessible by scrolling)	<ul style="list-style-type: none"> • 8 » 16 • 32
13	Audio input Quick Setup	Choose from presets audio input source schemes.	<ul style="list-style-type: none"> » 1-8: Off • 9-16: Off • 17-24: Off • 25-32: Off • 1-32: Off • 1-8: Line In 1-8 • 9-16: Line In 1-8 • 17-24: LineIn 1-8 • 25-32: Line In 1-8 • 1-8: HDMI/AES In 1-8 • 9-16: HDMI/AES In 1-8 • 17-24: HDMI/AES In 1-8 • 25-32: HDMI/AES In 1-8 • 1-16: SDI In 1-16 • 17-32: SDI In 1-16 • 1-16: Dante Rx 1-16 • 17-32: Dante Rx 17-32

Timecode/Sync

#	Parameter Name	Description	Options
1	Sync Ref - Video Playback	The reference for synchronization of playback clock for Video Mode.	<ul style="list-style-type: none"> » Internal • Video Input (SDI/HDMI)
2	Sync Ref - Audio Only	The reference for synchronization of recording and playback clocks for Audio Only mode.	<ul style="list-style-type: none"> » Internal • Wordclock (Sync in) • AES1-2 • Dante • Video Input (SDI/HDMI)
3	Timecode Mode	Sets the running mode for the internal timecode generator and/or the method which the PIX 260i receives SMPTE timecode..	<ul style="list-style-type: none"> » Off • Freerun • Record run • Ext TC (LTC) » Ext TC (SDI, HDMI)
4	Frame Rate (Audio Only)	The frame rate of timecode stamped to .wav files (Audio Mode). This setting is ignored in Video Mode.	<ul style="list-style-type: none"> • 23.976 • 24 • 25 » 29.97 • 29.97 DF • 30 • 30 DF
5	Drop Frame Enable	Enable or disable drop frame timecode.	<ul style="list-style-type: none"> » Off • On

#	Parameter Name	Description	Options
6	Sync Out	Determines whether the signal on the Sync Output BNC is genlock or wordclock, and determines the sync reference for that signal. When settings of a resolution / frame rate are selected, the Sync Out BNC will supply genlock signal at the specified rate that reference the internal Ambient® Lockit.	<ul style="list-style-type: none"> » Off • 1080p30 • 1080p29.97 • 1080p29.97df • 1080p25 • 1080p24 • 1080p23.976 • 1080i60/PsF30 • 1080i59.94/PsF29.97nd • 1080i59.94/PsF29.97df • 1080i50/PsF25 • 1080PsF24 • 1080PsF23.976 • 720p60 • 720p59.94 (29.97nd) • 720p59.94 (29.97df) • 720p50 • 720p60 • 720p30 • 720p29.97nd • 720p29.97df • 720p25 • 720p24 • 720p23.976 • 576i50 (PAL) • 480i59.94 (29.97nd NTSC) • 480i59.94 (29.97df NTSC) • Genlock, Follows Video In • Wordclock, Follows Video In
7	Auto-Record Hold Off	Sets the duration that a valid timecode signal has to be recognized by the PIX 260i before generating a new take when using external timecode to trigger recording (When [Remote Control - Rec Start/Stop] is set to Timecode).	<ul style="list-style-type: none"> » 0 sec (numeric 0-8)
8	Jam Received TC	Opens a dialog that displays incoming timecode value in realtime (RxTC), incoming userbits (UB), transmitting/internal (Ambient® Lockit) timecode value (GENTC), and transmitting/internal userbits (UB).	<ul style="list-style-type: none"> • Push Control Knob to jam internal timecode to incoming (RxTC) timecode. • Push Menu button to back out.
9	Jam time Of Day	Sets the internal timecode clock to the current time of day.	
10	Set Generator TC	Sets the Ambient® Lockit timecode generator value in HH:MM:SS.FF format.	<ul style="list-style-type: none"> » 00:00:00.00 (Timecode value)
11	Set Generator UBits	Sets userbits of the Ambient® Lockit timecode generator.	<ul style="list-style-type: none"> » 00 00 00 00 (Hex: 00-FF for each slot)
12	File Start TC Offset	Sets the offset of the beginning timecode stamp of recorded files. Useful when there is a constant offset between camera and PIX 260i recorded files. The applied offset does not affect timecode output of the PIX 260i.	<ul style="list-style-type: none"> » 0 (numeric -10 to +10)

LCD Monitor

#	Parameter Name	Description	Options
1	Exposure Assist	Sets the type of Exposure assist tool.	» False Color, 12-step • False Color, 4-step • Zebras 1 • Zebras 2 • Zebras 1+2
2	Focus Assist	Sets the type of Focus Assist tool.	» Peaking • Edge Enhance
3	Zebra 1 Level	Sets IRE level of Zebra 1.	» 70 IRE +/-5% (numeric 50-108)
4	Zebra 2 Threshold	Sets the IRE threshold valued for Zebra 2.	» 85 IRE (numeric 70-108)
5	Peaking Color	Sets the displayed peaking color.	• White » Red • Blue • Green • Yellow
6	Peaking Sensitivity	Sets the general peaking sensitivity.	• High » Mid • Low
7	Peaking Background Contrast	Sets the amount of background contrast when Focus Assist Peaking is active.	» 1x • 0.5x • 0.25x • No Background
8	Vertical Flip Display	Flips the LCD and OSD vertically.	» Off • On
9	Horizontal Flip Display	Flips the LCD video image horizontally.	» Off • On

On-Screen Display

#	Parameter Name	Description	Options
1	ABS Time	Display of absolute record time.	» On • Off
2	File Codec	Display of current file codec	» On • Off
3	File Name	Display of current file name	» On • Off
4	File Resolution/Rate	Display of current file resolution	» On • Off
5	Audio Source	Display of audio input levels for channels 1 and 2	» On • Off
6	Input - Video	Display of input audio source and channel count	» On • Off
7	Headphone Source	Display of headphone audio source	» On • Off
8	Audio Metering	Display of audio meters for inputs 1 and 2	» On • Off
9	Time/date	Display of time of day and date	» On • Off

#	Parameter Name	Description	Options
10	Timecode	Display of current timecode value	» On • Off
11	Drive (D1) status	Display status of Drive 1	» On • Off
12	Drive (D2) status	Display status of Drive 2	» On • Off
13	Drive (D3) status	Display status of Drive 3	» On • Off
14	Drive (D4) status	Display status of Drive 4	» On • Off
15	RS422 Status	Display status of connected RS422 controller	» On • Off
16	Cue Marker	Display cue marker information during playback	» On • Off
17	Sync Reference	Display current Sync Reference	» On • Off
18	Group Number	Displays [Network - Group] setting	» On • Off
19	IP Address	Displays current PIX 260i IP Address	» On • Off

Remote Control

#	Parameter Name	Description	Options
1	RS422	Enable or disable RS422 capability	• On » Off
2	Rec Start/Stop	Determines what method the PIX 260i uses to automatically start and stop recordings.	» Off • SDI Flag - RED • SDI Flag - Panasonic • SDI Flag - Panasonic (Varicam) • SDI Flag - Canon • SDI Flag - Sony • SDI Flag - Arri • SDI Flag - PIX • Timecode
3	GPIO Inputs	Set GPIO inputs (pins 1, 2, and 3 on GPIO connector) to active high or active low. Active high: Connecting the pin to +5V will activate the function. Active low: Connecting the pin to ground will activate the function.	» Active low • Active high
4	GPIO Outputs	Set GPIO outputs (pins 6, 7, and 8 on GPIO connector) to active high or active low. Active high: When the function is true, +5V will appear on the pin. Active low: When the function is true, the pin will be grounded.	• Active low » Active high

Network

#	Parameter Name	Description	Options
1	This PIX's Name	Sets name of PIX 260i. This must be unique within a network.	» PIX260

#	Parameter Name	Description	Options
2	Network Group	Groups PIX 260i with other PIX 260i units.	» No Group • Group 1 • Group2 • Group 3 • Group 4
3	Ethernet File Transfer	When Off the attached media will mount to the PIX 260i for read and write action. When On the attached drives will dismount from PIX 260i and connect to the Local Area Network or computer for file transfer via Ethernet.	» Off • On
4	Dante Redundancy Mode	When On the PIX 260i's Primary and Secondary Ethernet ports both transmit Dante Audio over separate networks. This provides a fail safe of the Dante system if one of the networks should fail. <i>In Dante Redundancy Mode, two separate networks must be run and they CANNOT be connected to one another. Connect any computer running Dante Controller to the PIX 260's PRI Ethernet network.</i>	» Off • On
5	Auto IP Settings	When On, the IP settings will automatically be provided by a DHCP (recommended), or Link-local when no DHCP is present. When Off the IP Address, Subnet Mask, and Gateway will have to be entered manually.	• Off » On
6	IP Address	Displays IP Address, can be edited when Auto IP Settings is OFF.	
7	Subnet Mask	Displays Subnet Mask, can be edited when Auto IP Settings is OFF.	
8	Gateway	Displays Gateway, can be edited when Auto IP Settings is OFF.	

System

#	Parameter Name	Description	Options
1	Power	Determines power on and off method. When set to Always on, the PIX 260i will turn on and off when external DC is applied. When Use Power Switch is selected the PIX 260i is powered on and off using a key combination of AUDIO button + Control Knob press.	• Always On » Use Power Switch
2	HP Warning Bell Level	Adjusts the level of the headphone warning bell sound	» -40dBFS (Off, -60 to -12dBFS)
3	Time Zone	Selects the international time zone	» (GMT-06:00) Central Time (US) (All GMT zones)
4	Daylight Saving	Toggles daylight saving on or off for the time-of-day clock	» Off • On
5	Time Format	Selects between 12 or 24 hour format for the time-of-day clock	» 12h • 24h
6	Date Format	Selects between MM/DD/YY and DD/MM/YY date format	» MM/DD/YY • DD/MM/YY
7	Set Date/Time	Set the time and date	
8	Rec button File Split	Whether or not a new file will be created when the REC button is pushed during recording.	• On » Off
9	Playback Start Mode	Choose what to do when file playback is initiated.	» Play immediately • Pause on First Frame

#	Parameter Name	Description	Options
10	Playback Mode	Determines Playback Mode.	» Play Once <ul style="list-style-type: none"> • Play Once - Pause • Play All • Play All - Pause • Play All - Loop • Play List • Play List - Pause • Play List - Loop
11	Shortcuts	Displays a dialog that shows all shortcut button combinations. This is not a setting, but a helpful reference.	
12	Version Info	Displays a dialog indicating firmware version and serial number. This is not a setting, but a helpful reference.	
13	Update Software	Searches attached drives for a .prg firmware file and begins the firmware update process.	







Quick Setup

#	Parameter Name	Description	Options
1	Load Factory Settings	Loads default setup	
2	Load Settings From Drive 1	Loads selected setup from setup files saved on Drive 1.	
3	Save Settings to Drive 1	Opens dialog to name and save current setup to Drive 1.	

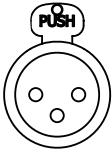
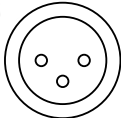

Button Shortcuts

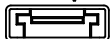
Button Combination	Effect
AUDIO + Control Knob rotate	Change HP source.
LCD + Control Knob press	Adjust LCD and button brightness.
Hold LCD	Turns off LCD display.
MENU + FILES	Button lock options: Unlock Buttons, Lock Non-Transport Buttons, or Lock All Buttons.
STOP + REW	False take.
LCD + MENU	Toggle Focus Assist on LCD display
LCD + FILES	Toggle Exposure Assist on LCD display
PLAY + FF	Begin looping between cue points when in loop playback mode
PLAY + REW	Begin looping of clip when in loop playback mode
FILES	When in Record or Playback, sets a cue marker
Hold FILES	When in Record or Playback, deletes last cue marker
Hold MENU + Control Knob press	Toggles between No Group and current Group setting

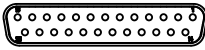
Connector Pin Assignments

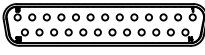
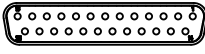
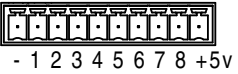
Connector		Pin Assignments	Notes
XLR-F (2) (Analog Audio inputs)		1-ground 2-signal (+) 3-signal (-)	Mates with XLR-Male connector 20k ohm input impedance, line level, active-balanced
XLR-M (2) (Analog Audio outputs)		1-ground 2-signal (+) 3-signal (-)	Mates with XLR-Female connector 20k ohm input impedance, line level, active-balanced
TRS (Headphone output)		Tip-signal L Ring-signal R Sleeve-signal ground	Mates with TRS jack.
BNC (2) (Timecode input & output)		Center pin-signal Sleeve-ground	Mates with BNC male connector Unbalanced, coaxial connection
BNC (2) (SDI input & output)			Mates with BNC male connector Unbalanced, coaxial connection, 75 ohm connectors recommended
BNC (2) (Sync input & output)			Mates with BNC male connector Unbalanced, coaxial connection, 75 ohm connectors recommended
HDMI (2) (HDMI input & output)		Standard HDMI	Mates with HDMI Type A Plug (male)
eSATAp Female (2)		Standard eSATAp	Mates with eSATAp male connector
USB-A (1) Keyboard Input		Standard USB-A receptacle	For use with USB Keyboards only. Data transfer is not supported
DB-25 (1) (CH 1-8 LINE IN)		1-Input 8 signal (+) 2-Input 8 Ground 3-Input 7 signal (-) 4-Input 6 signal (+) 5-Input 6 Ground 6-Input 5 signal (-) 7-Input 4 signal (+) 8-Input 4 Ground 9-Input 3 signal (-) 10-Input 2 signal (+) 11-Input 2 Ground 12-Input 1 signal (-) 13-unused 14-Input 8 signal (-) 15-Input 7 signal (+) 16-Input 7 Ground 17-Input 6 signal (-) 18-Input 5 signal (+) 19-Input 5 Ground 20-Input 4 signal (-) 21-Input 3 signal (+) 22-Input 3 Ground 23-Input 2 signal (-) 24-Input 1 signal (+) 25-Input 1 Ground	Mates with DB-25 Male Connectors wired in Tascam fashion

Connector	Pin Assignments	Notes	
DB-25 (1) (CH 1-8 LINE OUT)		1–Output 8 signal (+) 2–Output 8 Ground 3–Output 7 signal (-) 4–Output 6 signal (+) 5–Output 6 Ground 6–Output 5 signal (-) 7–Output 4 signal (+) 8–Output 4 Ground 9–Output 3 signal (-) 10–Output 2 signal (+) 11–Output 2 Ground 12–Output 1 signal (-) 13–unused 14–Output 8 signal (-) 15–Output 7 signal (+) 16–Output 7 Ground 17–Output 6 signal (-) 18–Output 5 signal (+) 19–Output 5 Ground 20–Output 4 signal (-) 21–Output 3 signal (+) 22–Output 3 Ground 23–Output 2 signal (-) 24–Output 1 signal (+) 25–Output 1 Ground	Mates with DB-25 Male Connectors wired in Tascam fashion
DB-25 (1) (CH 1-8 AES IN/OUT)		1–Digital Out 4 signal (+) 2–Digital Out 4 Ground 3–Digital Out 3 signal (-) 4–Digital Out 2 signal (+) 5–Digital Out 2 Ground 6–Digital Out 1 signal (-) 7–Digital In 4 signal (+) 8–Digital In 4 Ground 9–Digital In 3 signal (-) 10–Digital In 2 signal (+) 11–Digital In 2 Ground 12–Digital In 1 signal (-) 13–unused 14–Digital Out 4 signal (-) 15–Digital Out 3 signal (+) 16–Digital Out 3 Ground 17–Digital Out 2 signal (-) 18–Digital Out 1 signal (+) 19–Digital Out 1 Ground 20–Digital In 4 signal (-) 21–Digital In 3 signal (+) 22–Digital In 3 Ground 23–Digital In 2 signal (-) 24–Digital In 1 signal (+) 25–Digital In 1 Ground	Mates with DB-25 Male Connectors wired in Tascam fashion
Phoenix 10-pin (1) (GPIO)		1–Ground 2–Record Input 3–Playback Input 4–Stop Input 5–unused 6–unused 7–Record Output 8–Playback Output 9–Stop Output 10–+5V DC Output	Logic points can be set to high or low. <i>See GPIO for details</i>

Connector		Pin Assignments	Notes
DB-9 (1) (RS422)		1-Ground 2-Transmit A 3-Receive B 4-Receive Common 5-Spare 6-Transmit Common 7-Transmit B 8-Receive A 9-Ground	Sony P2 (9-pin) machine control standard
8P6C-F (2) (Ethernet)		Standard 8P8C	For Ethernet Network connection, Ethernet file transfer, Dante, and PIX 260i grouping. Mates with Cat-5
USB-B (1) (Factory)		Standard USB-B receptacle	For Factory use only. Mates with USB Standard-B plug.

Appendix A - Supported Files

The PIX 260i supports the playback of various QuickTime .mov and Broadcast Wave .wav files. The PIX 260i will playback any file that it generates. Additionally, the PIX 260i can playback QuickTime and Broadcast Wave files generated by other 3rd party recorders/applications .

The PIX 260i will import and playback up to 32 channels of polyphonic Broadcast Wave files.

The PIX 260i will import and playback High Definition QuickTime Pro Res and DNxHD files generated by Avid and Final Cut Pro (currently tested with Avid 6 and Final Cut Pro 7 and X). 720 x 486 NTSC Standard Definition files are also supported.

720 x 480 NTSC Standard Definition files are not supported.

The PIX 260i supports up to 32 Tracks of audio in a QuickTime file. When exporting the QuickTime file for PIX 260i playback be certain to use only 2 audio streams (PIX 260i can handle up to 32 audio tracks over one QuickTime audio stream).

Specifications - PIX 260i

SDI

Input	<ul style="list-style-type: none"> 4:4:4 or 4:2:2; 12, 10, or 8-bit 3G-SDI (levels A and B), HD-SDI, or SDI
Output	<ul style="list-style-type: none"> 4:4:4 or 4:2:2; 12, 10, or 8-bit 3G-SDI (level A), HD-SDI, or SDI
SMPTE	12M-1, 12M-2, 125M, 259M, 272M, 291M, 292, 296M, 299, 352M, 372, 424, 425

HDMI

Input	v1.4a, 4:4:4 or 4:2:2, RGB or YCbCr, 10 or 8-bit, HDCP-enabled
Output	v1.3, 4:2:2 8-bit, RGB and YCbCr

Video Input Resolutions / Rates

Input Resolutions / Rates	<ul style="list-style-type: none"> 1080p23.976/24/25/29.97/30 1080i50/59.94/60 1080PsF23.976/24/25/29.97/30 720p23.976/24/25/29.97/30 (SDI Only) 	<ul style="list-style-type: none"> 720p50/59.94/60 576i50 (PAL) 480i59.94 (NTSC)
----------------------------------	--	---

Video Codecs and Files

Codecs	<ul style="list-style-type: none"> Apple ProRes 4444, 330 Mb/s, 12-bit Apple ProRes 36, 100, 145, 220 Mb/s, 8 and 10-bit Avid DNxHD 36, 100, 145, 220 Mb/s, 8 and 10-bit
Files	Quicktime wrapper (.MOV), Broadcast Wave (.WAV) Audio Only

Up/Down/Cross Conversion

Up/Down/Cross Conversion	<ul style="list-style-type: none"> 480i, 576i, 720p, 1080i, 1080p to any 480i, 576i, 720p, 1080i, 1080p Hardware based, 10 bit
---------------------------------	--

Frame Rate Conversion

Frame Rate Conversion	<ul style="list-style-type: none"> 24, 25, 30, 50, 60 to 24, 25, 30, 50,60, 23.976, 29.97, 59.94 to 23.976, 29.97, 59.94, automatic 3:2 pull-down removal in 23.976 and 24 frame modes, other pull-down cadences include 2:2:2:4, 2:3:3:2, 3:2:3:2:2, and 2:2 Hardware based, 10 bit
------------------------------	--

LCD

LCD	<ul style="list-style-type: none"> 5-inch LCD - IPS (In-Plane Switching), glossy, 800x480 pixel LCD display Ultra wide viewing angle and color accuracy
------------	---

Audio Recording

Record/Playback	<ul style="list-style-type: none"> 32 channels record/playback, simultaneous with video Simultaneous Dante, Analog, HDMI or SDI, AES/EBU, selectable per channel
------------------------	--

Analog Audio

Inputs	<ul style="list-style-type: none"> • 8 Balanced, line-level inputs on DB-25. • Ch1,2 also on XLR
Outputs	<ul style="list-style-type: none"> • 8 Balanced, line-level outputs on DB-25. • Ch1,2 also on XLR
Frequency Response	10Hz-20kHz, +/- 0.5dB re 1kHz
THD + Noise	0.004% max (1kHz, 22Hz-22kHz)
Input and Output Topology	Fully electronically balanced, RF, ESD, short, and overload protected; pin-2 hot, pin-3 cold
Line Output Clipping Level	+18dBu
Output Attenuation	0-20 dB, 1 dB increments
Front Panel Headphone	1/4" with gain control
Line Input Clipping Level	+26dBu
Input Impedance	10k

Digital Audio

Sample Rate / Bit Depth	<ul style="list-style-type: none"> • 44.1 kHz, 47.0952 kHz, 48 kHz, 48.048 kHz • 24-bit
AES3	<ul style="list-style-type: none"> • 8 channels in and out via DB-25, 110 ohm, 2 V p-p. • Accepts 32k, 44.1k, 48k, 96k, 192k sample rates. with SRC at input.
HDMI	<ul style="list-style-type: none"> • 8 channels embedded HDMI input • 8 channels embedded HDMI output. • Accepts 32k, 44.1k, 48k, 96k, 192k sample rates.
SDI	<ul style="list-style-type: none"> • 16 channels embedded SDI input • 16 channels embedded SDI output • 48k sample rate, with sample rate conversion
Dante	<ul style="list-style-type: none"> • 32 channels • 48kHz input and output

File Storage

Disk Format	UDF 2.5
PIX-CADDY 2 mounted drives	Two, front-mounted Sound Devices approved 2.5-inch drives
eSATAp conected drives	Two, rear panel eSATAp ports for drives meeting Sound Devices specifications, supplies 5V @ 2A

See Sound Devices' website for a list of approved media:
<http://www.sounddevices.com/approved>

Timecode and Sync

Modes Supported	Freerun, Record run, External
Frame Rates	23.976, 24, 25, 29.97DF, 29.97ND, 30DF, 30ND
Accuracy	<ul style="list-style-type: none"> • +/- 0.2ppm (1/2 frame per 24hrs) accuracy • Holds accurate timecode for 2 hours after power is removed

Timecode Inputs / Outputs	<ul style="list-style-type: none">• SDI Input BNC• SDI Output BNC• HDMI Input Jack (Sony protocol)	<ul style="list-style-type: none">• Timecode Input BNC• Timecode Output BNC
Sync Output	<ul style="list-style-type: none">• Analog bi-, tri-level sync / Genlock• Wordclock (Square wave, 48 kHz sampling rate, 3.3vp-p, 75 ohm)	
Sync Input	<ul style="list-style-type: none">• Wordclock (Square wave, 48 kHz sampling rate, 3.3vp-p, 75 ohm)	

Control

RS422	Machine Control
Ethernet	Web-based control of settings and transport
GPIO	GPIO on 8 pins, Phoenix connector

Keyboard

USB Keyboard	Front-panel USB host. Keyboards without hubs acceptable.
---------------------	--

Power

External	10–27V, 60W max, via locking 4-pin XLR connector (pin-1 = ground, pin-4 = +). <i>See Power-ing</i>
-----------------	--

Physical

Size (H x W x D)	3.3" x 8.6" x 10.3" (8.4 cm x 21.8 cm x 26.2 cm)
Weight	7.5 lbs
Operating Temperature	-10° C to +40° C

PIX 260i CE Declaration of Conformity

According to ISO/IEC Guide 22
 Sound Devices, LLC
 E7556 State Rd. 23 and 33
 Reedsburg, WI 53959 USA

declares that the product, PIX 260i Video Recorder is in conformity with and passes:

Product Family		Application		
EN 55103-1		EMC-Product family standard for audio, visual, audio-visual and lighting control apparatus for professional use - Part 1: Emissions		
EN 55103-2		EMC-Product family standard for audio, visual, audio-visual and lighting control apparatus for professional use – Part 2: Immunity		
Basic Standards (Emissions)		Port Tested	Test Descriptions	Results
CISPR 22 (EN 55022)		Enclosure	Radiated Emissions, Class B	Pass
CISPR 22 (EN 55022)		AC Power Ports	Conducted Emissions, Class B	Pass
IEC 61000-3-2	EN 61000-3-2	AC Power Ports	Harmonic Current Emissions (through Amendment 14 of IEC 61000-4-7)	Pass
IEC 61000-3-3	EN 61000-3-3	AC Power Ports	Voltage Fluctuation and Flicker	Pass
*EN 55103-1 Phenomena 2,3	EN 55103-1	Enclosure	Magnetic Emissions at 1 Meter 50Hz – 50kHz	Pass
Basic Standards (Immunity)		Port Tested	Test Specifications	Results
IEC 61000-4-2	EN 61000-4-2	Enclosure	ESD: ± 4 kV Contact, ± 8 kV Air Discharge	Pass
IEC 61000-4-3	EN 61000-4-3	Enclosure	Radiated RF Immunity: 3V/m, 80% AM @ 1kHz, 80-2700 MHz, 1% step	Pass
IEC 61000-4-4	EN 61000-4-4	AC Power Ports DC Power Ports	EFT Burst: ± 0.5 kV - ± 2 kV	Pass
IEC 61000-4-4	EN 61000-4-4	Signal (>3m), Control & Measurement (>3m)	EFT Burst: ± 0.5 kV	Pass
IEC 61000-4-5	EN 61000-4-5	AC Input Ports	Surge: ± 1 kV Differential Mode (line to line) ± 2 kV Common Mode (line to ground)	Pass
IEC 61000-4-5	EN 61000-4-5	Signal (>30m)	Surge: ± 1 kV Common Mode	N/A
IEC 61000-4-6	EN 61000-4-6	AC Power Ports DC Power Ports	Conducted RF Immunity: 3 V 80% AM modulation @ 1kHz	Pass
IEC 61000-4-6	EN 61000-4-6	Signal (>3m) (Control & Measurement) (>3m)	Conducted RF Immunity: 3 V, 80% AM modulation @ 1kHz	Pass
*EN 55103-2 Phenomena 3	EN 55103-2	Enclosure	Magnetic Immunity 50Hz – 10 KHz	Pass
IEC 61000-4-11	EN 61000-4-11	AC input ports	Voltage Dips and Short Interruptions: 70%, 40% and 5% nominal for 10ms, 100ms, 1 sec and 5 sec (50Hz)	Pass

CE - CISPR Publication Dates

Standard #	Date	Am.1	Am. 2
ANSI C63.4	2003		
CISPR 11	2009-05		
CISPR 12	2007-05	2009-01	
CISPR 14-1	2005-11	2008-11	
CISPR 14-2	2001-11	2001-11	2008-05
CISPR 16-1-1	2006-03	2006-09	2007-07
CISPR 16-1-2	2003	2004-04	2006-07
CISPR 22	2008-09		
CISPR 24	1997-09	2001-07	2002-10
EN 55011	2007-05		
EN 55014-1	2006		
EN 55014-2	1997		
EN 55022	2006	2007	
EN 60601-1-2	2007-03		
EN 61000-3-2	2006-05		
EN 61000-3-3	2008-12		
EN 61000-4-2	2001	1998	2001
EN 61000-4-3	2006-07	2008-05	
EN 61000-4-4	2004		
EN 61000-4-5	2006-12		
EN 61000-4-6	2007-08		
EN 61000-4-8	1993	1994-01	

Standard #	Date	Am.1	Am. 2
EN 61000-4-11	2004-10		
EN 61000-6-1	2007-02		
EN 61000-6-2	2005-12		
EN 61000-6-3	2007-02		
EN 61000-6-4	2007-02		
EN 60601-1-2	2007-03		
EN 61000-3-2	2005-11	2008-03	2009-02
EN 61000-3-3	2008-06		
EN 61000-4-2	2008-12		
EN 61000-4-3	2008-04		
EN 61000-4-4	2004-07		
EN 61000-4-5	2005-11		
EN 61000-4-6	2008-10		
EN 61000-4-8	2001-03		
EN 61000-4-11	2004-03		
EN 61326-1	2006-06		
ISO 14082	1998-07		
MIL Std. 461E	1999-08		
*IEC 60601-2-25	1993	1999-05	
*EN 50499	2008-03		
EN 55103-1	2009		
EN55103-2	2009		

*: Test not on LSR Scope of Accreditation

Tested by L. S. Compliance, Inc. Cedarburg, Wisconsin
October 25, 2012



Matthew Anderson
Director of Engineering
Sound Devices, LLC

Software License

End-user license agreement for Sound Devices PIX 260i Embedded Software / Firmware

Important Read carefully: This Sound Devices, LLC end-user license agreement (“EULA”) is a legal agreement between you (either an individual or a single entity) and Sound Devices, LLC for the Sound Devices, LLC software product identified above, which includes computer software, embedded software, and may include associated media, printed materials, and “online” or electronic documentation (“SOFTWARE PRODUCT”). By using, installing, or copying the SOFTWARE PRODUCT, you agree to be bound by the terms of this EULA. If you do not agree to the terms of this EULA, do not use or install the SOFTWARE PRODUCT.

Software Product License

The SOFTWARE PRODUCT is protected by copyright laws and international copyright treaties, as well as other intellectual property laws and treaties. The SOFTWARE PRODUCT is licensed, not sold.

Grant of license. This EULA grants you the following limited, non-exclusive rights: In consideration of payment of the licensee fee, Sound Devices, LLC, as licensor, grants to you, the licensee, a non-exclusive right to use this copy of a Sound Devices, LLC software program (hereinafter the “SOFTWARE”) on a single product and/or computer. All rights not expressly granted to licensee are reserved to Sound Devices, LLC.

Software ownership. As the licensee, you own the hardware on which the SOFTWARE is recorded or fixed. Sound Devices, LLC shall retain full and complete title to the SOFTWARE and all subsequent copies of the SOFTWARE, regardless of the media or form on or in which the original copies may exist. The license is not a sale of the original SOFTWARE.

Copyright. All rights, title, and copyrights in and to the SOFTWARE PRODUCT (including, but not limited to, any images, photographs, animations, video, audio, music, text, and “applets” incorporated into the SOFTWARE PRODUCT) and any copies of the SOFTWARE PRODUCT are owned by Sound Devices, LLC or its suppliers. The SOFTWARE PRODUCT is protected by copyright laws and international treaty provisions. Therefore, you must treat the SOFTWARE PRODUCT like any other copyrighted material, except that you may make copies as only provided below. You may not copy the printed materials accompanying the SOFTWARE PRODUCT.

Restrictions on use. Licensee may not distribute copies of the SOFTWARE or accompanying materials to others. Licensee may not modify, adapt, translate, reverse engineer, decompile, disassemble, or create derivative works based on the SOFTWARE or its accompanying printed or written materials.

Transfer restrictions. Licensee shall not assign, rent, lease, sell, sublicense, or otherwise transfer the SOFTWARE to another party without prior written consent of Sound Devices, LLC. Any party authorized by Sound Devices, LLC to receive the SOFTWARE must agree to be bound by the terms and conditions of this agreement.

Termination. Without prejudice to any other rights, Sound Devices, LLC may terminate this EULA if you fail to comply with the terms and conditions of this EULA. In such event, you must destroy all copies of the SOFTWARE PRODUCT and all of its component parts.

Limited Warranty

No warranties. Sound Devices, LLC expressly disclaims any warranty for the SOFTWARE PRODUCT. The SOFTWARE PRODUCT and any related documentation is provided “as is” without warranty or condition of any kind, either express or implied, including, without limitation, the implied warranties and conditions of merchantability, fitness for a particular purpose, or non-infringement. The entire risk arising out of use or performance of the SOFTWARE PRODUCT remains with you.

No liability for damages. In no event shall Sound Devices, LLC or its suppliers be liable for any damages whatsoever (including, without limitation, damages for loss of business profits, business interruption, loss of business information, or any other pecuniary loss) arising out of the use of or inability to use this Sound Devices, LLC product, even if Sound Devices, LLC has been advised of the possibility of such damages. In any case, Sound Devices, LLC’s entire liability under any provision of this evaluation license shall be limited to the greater of the amount actually paid by you for the SOFTWARE PRODUCT or U.S. \$5.00. Because some states/jurisdictions do not allow the exclusion or limitation of liability for consequential or incidental damages, the above limitation may not apply to you.

Governing Law

This agreement and limited warranty are governed by the laws of the state of Wisconsin.

Warranty and Technical Support

Warranty & Service

Sound Devices, LLC warrants the PIX 260 Video Recorder against defects in materials and workmanship for a period of TWO (2) years from date of original retail purchase. This is a non-transferable warranty that extends only to the original purchaser. Sound Devices, LLC will repair or replace the product at its discretion at no charge. Warranty claims due to severe service conditions will be addressed on an individual basis. THE WARRANTY AND REMEDIES SET FORTH ABOVE ARE EXCLUSIVE. SOUND DEVICES, LLC DISCLAIMS ALL OTHER WARRANTIES, EXPRESS OR IMPLIED, INCLUDING WARRANTIES OF MERCHANTABILITY AND FITNESS FOR A PARTICULAR PURPOSE. SOUND DEVICES, LLC IS NOT RESPONSIBLE FOR SPECIAL, INCIDENTAL, OR CONSEQUENTIAL DAMAGES ARISING FROM ANY BREACH OF WARRANTY OR UNDER ANY OTHER LEGAL THEORY. Because some jurisdictions do not permit the exclusion or limitations set forth above, they may not apply in all cases.

For all service, including warranty repair, please contact Sound Devices for an RMA (return merchandise authorization) before sending your unit in for repair. Product returned without an RMA number may experience delays in repair. When sending a unit for repair, please do not include accessories, including SSD drives, CF cards, batteries, power supplies, carry cases, cables, or adapters unless instructed by Sound Devices.

Sound Devices, LLC
Service Repair RMA #XXXXX
E7556 State Rd. 23/33
Reedsburg, WI 53959 USA
telephone: (608) 524-0625

Technical Support / Bug Reports

For technical support and bug reporting on all Sound Devices products contact:

Sound Devices, LLC
E-mail: support@sounddevices.com
web: www.sounddevices.com/support/
Telephone: +1 (608) 524-0625 / Toll-Free in the U.S.A.: (800) 505-0625
Fax: +1 (608) 524-0655

Sound Devices hosts a user support forum. The URL is:

<http://forum.sounddevices.com>

Sound Devices cannot guarantee that a given computer, software, or operating system configuration can be used satisfactorily with the PIX 260i based exclusively on the fact that it meets our minimum system requirements.

SOUND **DEVICES**