

Panasonic[®]

Owner's Manual for advanced features

Digital Camera

Model No. **DMC-G5**



Before connecting, operating or adjusting this product,
please read the instructions completely.

Register online at
www.panasonic.com/register
(U.S. customers only)

VQT4H13
F0612MC0

Contents

Before Use

Care of the camera	7
Standard Accessories	8
Names and Functions of Components	9
About the Lens	16

Preparation

Changing the Lens	17
Attaching the Shoulder Strap	20
Charging the Battery	21
• Charging	21
• Approximate operating time and number of recordable pictures	23
Inserting and Removing the Card (optional)/ the Battery	26
About the Card	27
• About cards that can be used with this unit	27
• Approximate number of recordable pictures and available recording time	28
Setting Date/Time (Clock Set)	29
• Changing the Clock Setting	30

Basic

Selecting the Recording Mode	31
Tips for taking good pictures	33
• Detects orientation of camera (Direction Detection Function)	33
Using the Viewfinder	34
• Switching the LCD monitor/Viewfinder	34
• About the Eye Sensor AF	35
• Setting the focus position with the Touch Pad	35
Taking a Still picture	36
• How to set focus when taking a still picture (AFS/AFF/AFC)	36
• Taking a still picture	38
• Taking pictures using the Touch Shutter function	39
• Switching the Information Displayed on the recording screen	40
Taking Pictures using the Automatic Function (Intelligent Auto Mode)	42
• Recording with Camera-Recommended Effects	45
• Recording using Intelligent Auto Plus Mode	46
Taking Pictures with Defocus Control Function	48
Taking Pictures with Your Favorite Settings (Program AE Mode)	50
Recording Motion Picture	52
• How to set focus when recording a motion picture (Continuous AF)	52
• Recording motion picture	53
• Recording still pictures while recording motion pictures	55
Playing Back Pictures/Motion Pictures	56

• Playing Back Pictures	56
• Changing the information displayed on the playback screen	60
• Playing Back Motion Pictures	61
• Creating Still Pictures from a Motion Picture	62
Deleting Pictures	63
Setting the Menu	64
• Setting menu items	64
• Setting the menu screen background	67
Setting the Quick Menu	68
• Change the Quick Menu to your preferred item	69
About the Setup Menu	70

Recording

Optical Image stabilizer	78
Taking Pictures with the Zoom	80
• Zooming using touch operations	83
Taking Pictures using the Built-in Flash	84
• Switching to the appropriate flash setting	84
Compensating the Exposure	88
Taking Pictures using Burst Mode	89
Taking Pictures using Auto Bracket	91
Taking Pictures with the Self-timer	93
Taking Pictures with Auto Focus	95
Taking Pictures with Manual Focus	101
Fixing the Focus and the Exposure (AF/AE Lock)	104
Adjusting the White Balance	106
Setting the Light Sensitivity	111
Using the function button	113
• Confirm the Effects of Aperture and Shutter Speed (Preview Mode)	115
• Easily set aperture/shutter speed for suitable exposure (One Push AE)	116
Taking Pictures by Specifying the Aperture/	
Shutter Speed	117
• Aperture-Priority AE Mode	117
• Shutter-Priority AE Mode	118
• Manual Exposure Mode	119
Taking Pictures that match the Scene being recorded (Scene Guide Mode) ...	121
• [Clear Portrait]	122
• [Silky Skin]	122
• [Backlit Softness]	122
• [Clear in Backlight]	123
• [Relaxing Tone]	123
• [Sweet Child's Face]	123
• [Distinct Scenery]	124
• [Bright Blue Sky]	124
• [Romantic Sunset Glow]	124
• [Vivid Sunset Glow]	124
• [Glistening Water]	125
• [Clear Nightscape]	125

• [Cool Night Sky].....	125
• [Warm Glowing Nightscape].....	126
• [Artistic Nightscape].....	126
• [Glittering Illuminations].....	126
• [Clear Night Portrait].....	127
• [Soft Image of a Flower].....	127
• [Appetizing Food].....	128
• [Cute Dessert].....	128
• [Freeze Animal Motion].....	129
• [Clear Sports Shot].....	129
• [Monochrome].....	129
Taking Pictures with different image effects	
(Creative Control Mode).....	130
• [Expressive].....	132
• [Retro].....	132
• [High Key].....	132
• [Low Key].....	132
• [Sepia].....	133
• [Dynamic Monochrome].....	133
• [Impressive Art].....	133
• [High Dynamic].....	133
• [Cross Process].....	134
• [Toy Effect].....	134
• [Miniature Effect].....	135
• [Soft Focus].....	137
• [Star Filter].....	137
• [One Point Color].....	137
Taking Pictures in Custom Set.....	139
• Registering Personal Menu Settings (Registering custom settings).....	140
• Recording using registered custom set.....	141
Taking a Picture with Face Recognition Function.....	142
Entering Text.....	146
Using the [Rec] Menu.....	147
• [Photo Style].....	147
• [Aspect Ratio].....	149
• [Picture Size].....	149
• [Quality].....	150
• [Focus Mode].....	150
• [Metering Mode].....	151
• [HDR].....	151
• [i.Dynamic] (Intelligent dynamic range control).....	152
• [Flash].....	152
• [Red-Eye Removal].....	152
• [Flash Synchro].....	153
• [Flash Adjust.].....	153
• [i.Resolution].....	154
• [ISO Limit Set].....	154

• [ISO Increments].....	154
• [Long Shtr NR].....	155
• [Shading Comp.].....	155
• [Digital Zoom].....	156
• [Electronic Shutter]	156
• [Burst Rate].....	156
• [Auto Bracket]	156
• [Self Timer]	156
• [Color Space]	157
• [Stabilizer]	157
• [Face Recog.]	157
• [Profile Setup].....	158
• [Recommended Filter]	158
Using the [Motion Picture] Menu	159
• [Rec Mode]	159
• [Rec Quality]	160
• [Picture Mode].....	161
• [Continuous AF].....	161
• [Ex. Tele Conv.].....	161
• [Wind Cut].....	161
• [Mic Level Disp.]	162
• [Mic Level Adj.]	162
• [Flkr Decrease]	162
Using the [Custom] Menu.....	163

Playback/Editing

Playing Back Burst Pictures	173
Editing Burst Pictures.....	174
Using the [Playback] Menu.....	175
• [2D/3D Settings].....	175
• [Slide Show].....	175
• [Playback Mode]	177
• [Title Edit].....	178
• [Text Stamp].....	179
• [Video Divide].....	181
• [Resize].....	182
• [Cropping]	183
• [Rotate]	184
• [Favorite].....	185
• [Print Set].....	186
• [Protect]	188
• [Face Rec Edit].....	188

Connecting to other equipment

Enjoying 3D pictures.....	189
Playing Back Pictures on a TV Screen.....	193
• Using VIERA Link (HDMI).....	195
Saving still pictures and motion pictures on your PC.....	197
Saving still pictures and motion pictures on a Recorder.....	201
Printing the Pictures	202

Others

Optional accessories	206
LCD Monitor Display/Viewfinder Display	209
Cautions for Use.....	212
Message Display	218
Troubleshooting	221

Care of the camera

Do not subject to strong vibration, shock, or pressure.

- The lens, LCD monitor, or external case may be damaged if used in the following conditions.

It may also malfunction or image may not record if you:

- Drop or hit the camera.
- Press hard on the lens or the LCD monitor.

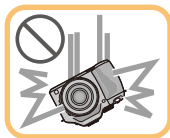

This camera is not dust/drip/water proof.

Avoid using the camera in places with a lot of dust, water, sand, etc.

- Liquid, sand and other foreign material may get into the space around the lens, buttons, etc. Be particularly careful since it may not just cause malfunctions, but it may also become irreparable.

- Places with a lot of sand or dust.
- Places where water can come into contact with this unit, such as when using it on a rainy day or at the beach.



Do not place your hands inside the mount of the digital camera body.

Since the sensor unit is a precision apparatus, it may cause a malfunction or damage.

■ About Condensation (When the lens, the viewfinder or LCD Monitor is fogged up)

- Condensation occurs when the ambient temperature or humidity changes. Be careful of condensation since it causes lens and LCD monitor stains, fungus and camera malfunction.
- If condensation occurs, turn the camera off and leave it for about 2 hours. The fog will disappear naturally when the temperature of the camera becomes close to the ambient temperature.

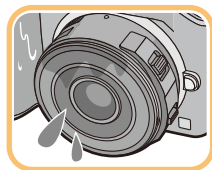

Standard Accessories

Check that all the accessories are supplied before using the camera.



- The accessories and their shape will differ depending on the country or area where the camera was purchased.
For details on the accessories, refer to “Basic Owner’s Manual”.
- Battery Pack is indicated as **battery pack** or **battery** in the text.
- Battery Charger is indicated as **battery charger** or **charger** in the text.
- SD Memory Card, SDHC Memory Card and SDXC Memory Card are indicated as **card** in the text.
- **The card is optional.**
- Description in this owner’s manual is based on the interchangeable lens (H-PS14042).
- If any accessories are lost, customers in the USA and Puerto Rico should contact Panasonic’s parts department at 1-800-833-9626 and customers in Canada should contact 1-800-99-LUMIX (1-800-995-8649) for further information about obtaining replacement parts.

Names and Functions of Components

■ Camera body

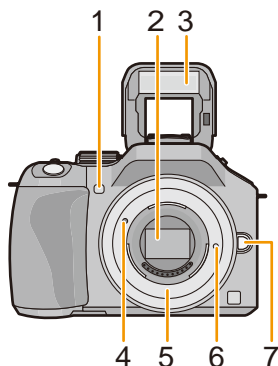
- 1 Self-timer indicator (P93)/
AF Assist Lamp (P168)
- 2 Sensor
- 3 Flash (P84)
- 4 Lens fitting mark (P17)
- 5 Mount
- 6 Lens lock pin
- 7 Lens release button (P18)



- 8 [LVF/LCD] button (P34)/
[Fn3] button (P113)
- 9 Diopter adjustment dial (P34)
- 10 Viewfinder (P34)
- 11 Eye Cup (P213)
- 12 Eye sensor (P34)
- 13 [Q.MENU] button (P68)
- 14 [AF/AE LOCK] button (P104)/
[Fn1] button (P113)
- 15 Rear dial (P14)
- 16 Touch screen/LCD monitor (P13)
- 17 Playback button (P56)
- 18  /  button (P63)/
[Fn2] button (P113)
- 19 [MENU/SET] button (P14, 64)
- 20 Cursor buttons (P14)
 - ▲/ISO button (P111)
 - ▶/WB (White Balance) (P106)
 - ◀/AF Mode button (P95)
 - ▼/[Drive Mode] button

This button in picture record mode will allow the user to select between the following options.
- 21 [DISP.] button (P40, 60)

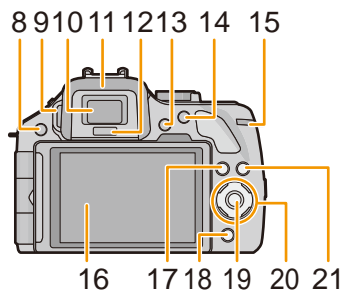

- 22 Focus distance reference mark (P103)
 23 Flash open lever (P84)
 24 Stereo microphone (P162)
 • Be careful not to cover the microphone with your finger. Doing so may make sound difficult to record.

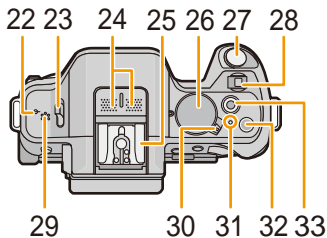

- 29 Speaker (P71)
 • Be careful not to cover the speaker with your finger. Doing so may make sound difficult to hear.
- 30 Camera ON/OFF switch (P29)
 31 Status indicator (P29)
 32 Intelligent Auto button (P42)
 33 Motion picture button (P53)
 34 Tripod mount (P217)
 • A tripod with a screw length of 5.5 mm (0.22 inch) or more may damage this unit if attached.
- 35 Card/Battery door (P26)
 36 Release lever (P26)

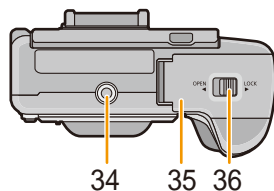

- 37 Shoulder strap eyelet (P20)
 • Be sure to attach the shoulder strap when using the camera to ensure that you will not drop it.
- 38 [REMOTE] socket (P208)
 39 [HDMI] socket (P193)
 40 [AV OUT/DIGITAL] socket (P193, 198, 201, 202)
 41 DC coupler cover
 • When using an AC adaptor, ensure that the Panasonic DC coupler (optional) and AC adaptor (optional) are used. (P208)

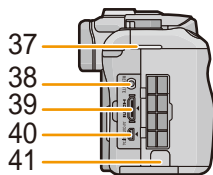

■ Lens

H-PS14042
(LUMIX G X VARIO PZ 14–42 mm/
F3.5–5.6 ASPH./POWER O.I.S.)

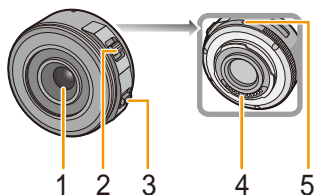

H-FS014042
(LUMIX G VARIO 14–42 mm/
F3.5–5.6 ASPH./MEGA O.I.S.)

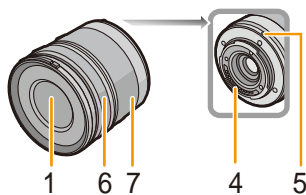

H-FS45150
(LUMIX G VARIO 45–150 mm/
F4.0–5.6 ASPH./MEGA O.I.S.)

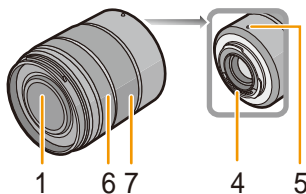

- 1 Lens surface
- 2 Zoom lever (P81)
- 3 Focus lever (P101)
- 4 Contact point
- 5 Lens fitting mark (P17)
- 6 Focus ring (P101)
- 7 Zoom ring (P81)

LCD Monitor

At the time when this camera is purchased, the LCD monitor is stowed in the camera body. Bring out the LCD monitor as shown below.

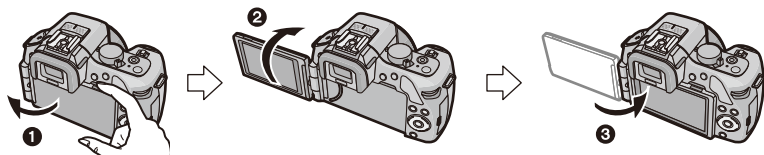

❶ Open the LCD monitor. (Maximum 180 °)

❷ It can be rotated 180° forward.

❸ Return the monitor to its original position.

• **Only rotate the LCD monitor after opening it wide enough, and be careful not to use excessive force as it may be damaged.**

The LCD monitor can be rotated to suit your needs. This is convenient as it allows you to take pictures from various angles by adjusting the LCD monitor.

• Do not cover the AF Assist Lamp with your fingers or other objects.

■ Taking pictures at a high angle

• This is convenient when there is someone in front of you and you cannot get close to the subject.



• It can only be rotated 90° towards you.

■ Taking pictures at a low angle

• This is convenient when taking pictures of flowers etc. that are in a low position.

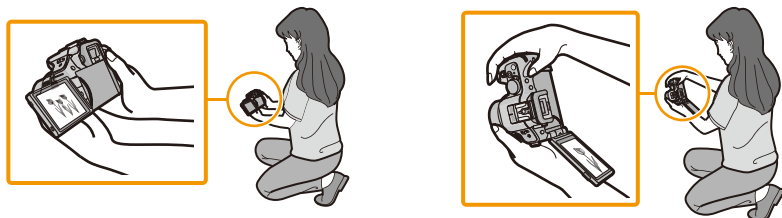

• It can be rotated 180° forward.

● Note

• When not using the LCD monitor it is recommended that you close it with the screen facing inward to prevent dirt and scratches.

Touch screen

This touch screen detects pressure.

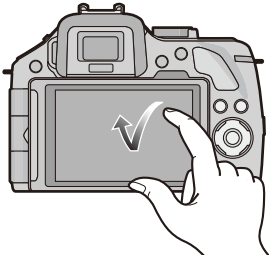
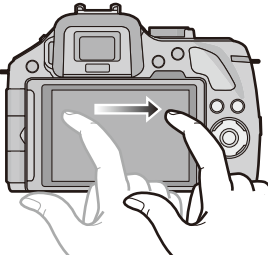
Touch the screen To touch and release the touch screen.	Drag A movement without releasing the touch screen.
 <p>Use this to perform tasks such as selecting icons or images displayed on the touch screen.</p> <ul style="list-style-type: none"> • When selecting features using the touch screen, be sure to touch the center of the desired icon. 	 <p>This is used to move the AF area, operate the slide bar, etc. This can also be used to move to the next image during playback, etc.</p>

Note

- If you use a commercially available liquid crystal protection sheet, please follow the instructions that accompany the sheet. (Some liquid crystal protection sheets may impair visibility or operability.)
- If a commercially available LCD protection sheet is used, **a little extra pressure** may be required if you notice that the touch screen is not responsive.
- Avoid letting the hand holding the camera accidentally apply pressure to the touch screen. Doing so may affect the touch screen operation.
- Do not press on the LCD monitor with hard pointed tips, such as ball point pens.
- Do not operate with your fingernails.
- Wipe the LCD monitor with dry soft cloth when it gets dirty with finger prints and others.
- Do not scratch or press the LCD monitor too hard.
- For information about the icons displayed on the touch screen, refer to “LCD Monitor Display/Viewfinder Display” on [P209](#).

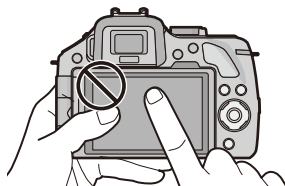

Cursor buttons/[MENU/SET] button

Pressing the cursor button:

Selection of items or setting of values etc., is performed.

Pressing [MENU/SET]:

Confirmation of setting contents, etc., is performed.

- This document expresses the up, down, left, and right of the cursor button as follows, or as ▲/▼/◀/▶.

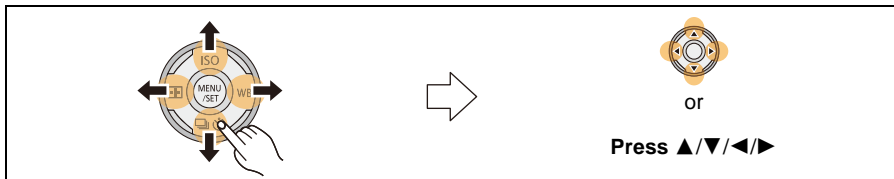

Even when the camera is operated using the touch screen, it is possible to operate with the cursor button and [MENU/SET] button if a guide like the one shown on the right is displayed.

Even on menu screens etc. on which the guide is not displayed, you can make settings and selections by operating the buttons.

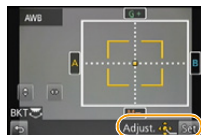

Rear Dial

There are 2 ways to operate the rear dial, rotating left or right, and deciding by pressing.

Rotating:

Selection of items or setting of values is performed during the various settings.

Pressing:

Operations that are the same as [MENU/SET] button, such as determine settings, etc., are performed during the various settings.

- Rear dial is described as follows in this Owner's Manual.

e.g.: Rotating left or right

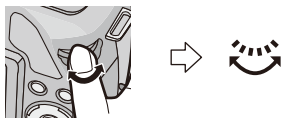

e.g.: Pressing the rear dial



Function Lever

Function lever can be used in 2 ways, for zoom operations (P81) and for Exposure Compensation (P88).

Slide the lever to left or right to operate.

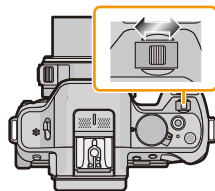

■ To assign a function to the Function Lever

You can assign a function to the function lever at [Function Lever] in the [Custom] menu. The default setting is [AUTO].

- 1 Select [Function Lever] in the [Custom] menu. (P64)
- 2 Touch the item.

Item	Settings
[AUTO]	<p>When the lens is replaced, the camera automatically assigns the setting suitable for the lens in use.</p> <ul style="list-style-type: none"> • When using an interchangeable lens (H-PS14042) that supports the power zoom (electrically operated zoom), the camera assigns the [ZOOM] operation. • When using an interchangeable lens (H-FS014042, H-FS45150) that does not support the power zoom, the camera assigns the [EXP.] operation.
[ZOOM]	Zoom operations are operable.
[EXP.]	Exposure compensation is operable. (In the Manual Exposure Mode: Aperture setting is operable.)

- Exit the menu after it is set.

About the Lens

■ Micro Four Thirds™ mount specification lens

This unit can use the dedicated lenses compatible with the Micro Four Thirds System lens mount specification (Micro Four Thirds mount).



■ Four Thirds™ mount specification lens

Lens with the Four Thirds mount specification can be used by using the mount adaptor (DMW-MA1: optional).



■ Leica mount specification lens

• When you use the M mount adaptor or R mount adaptor (DMW-MA2M, DMW-MA3R: optional), you can use Leica M Mount or Leica R Mount interchangeable lenses.

- For certain lenses, the actual distance at which the subject is in focus may differ slightly from the rated distance.
- When using a Leica lens mount adaptor, set [Shoot w/o Lens] (P172) to [ON].

About the lens and functions

There are functions that cannot be used, or the operation may be different depending on the lens used.

Auto Focus*/Auto aperture setting*/[Eye Sensor AF] (P35)/Defocus control function (P48)/[Stabilizer] (P78)/Touch zoom (P83)/[Shading Comp.] (P155)/[Quick AF] (P166)/[Power Zoom Lens] (P169)

- * The interchangeable lens (H-PS14042, H-FS014042 or H-FS45150) is compatible with the Auto Focus and automatic Aperture operation during the recording of motion pictures. With the interchangeable lens (H-PS14042), when using the power zoom (electrically operated zoom); you can record motion pictures even more smoothly and quietly thanks to the powerful high AF following performance and silence design.

For details on the lens used, refer to the website.

Refer to catalogs/Web pages for most current information regarding compatible lenses.
<http://panasonic.jp/support/global/cs/dsc/> (This Site is English only.)

Note

- The available flash range etc. differs depending on the aperture value of the lens you are using.
 - The focal length noted on the lens in use is equivalent to double when converted to the 35 mm film camera. (It will be equivalent to 100 mm lens when a 50 mm lens is used.)
- Refer to the website for details about the 3D interchangeable lens.

Changing the Lens

- Check that the camera is turned off.
- Change lenses where there is not a lot of dirt or dust. Refer to [P213](#), [P214](#) when dirt or dust gets on the lens.

Attaching the lens

- 1 Turn the lens rear cap **(A)** and the body cap **(B)** in the direction of the arrow to detach them.

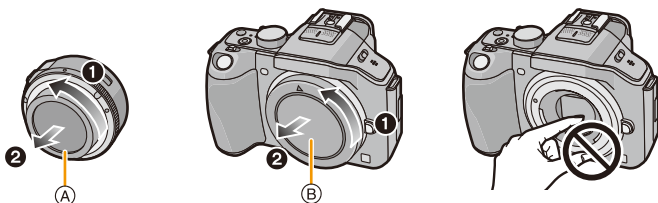

- Do not put your hands inside the mount.

- 2 Align the lens fitting marks **(C)** (red marks) on the camera body and the lens and then rotate the lens in the direction of the arrow until it clicks.

- Do not press the lens release button **(D)** when you attach a lens.
- Do not try to attach the lens when holding it at an angle to the camera body as the lens mount may get scratched.

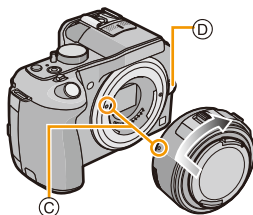

- 3 Detach the lens cap.

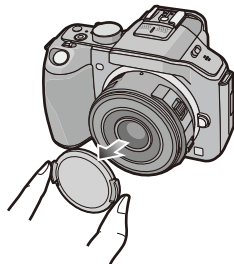

Detaching the lens

- When using the interchangeable lens (H-PS14042), change the lens only after turning this unit off and checking that the lens barrel has retracted. (Do not push in the lens barrel with your fingers. Doing so may damage the lens.)

Ⓐ When retracting the lens barrel

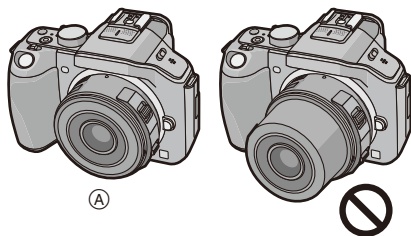

1 Attach the lens cap.

2 While pressing on the lens release button Ⓑ, rotate the lens toward the arrow until it stops and then remove.

- Always attach the body cap to the camera body so that dirt or dust does not get inside.
- Attach the lens rear cap so that the lens contact point does not get scratched.



Note

- It is recommended to attach the lens cap or attach the MC Protector (optional) to protect the lens surface when carrying. (P208)

Attaching the Lens Hood

When recording into strong backlight, irregular reflection may occur within the lens. The lens hood reduces the inclusion of unwanted light in the recorded images and lowers the drop in contrast. The lens hood cuts off excess lighting and improves the picture quality.

- The interchangeable lens (H-PS14042) does not have a lens hood.

To attach the lens hood (flower shape) that came with the interchangeable lens (H-FS014042)

Insert the lens hood into the lens with the short sides at the top and bottom, and turn in the direction of the arrow until it stops.

- Ⓐ Fitting to the mark.

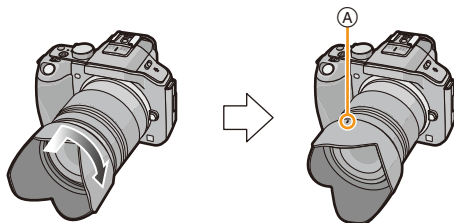

To attach the lens hood that came with the interchangeable lens (H-FS45150)

Insert the lens hood into the lens, and turn in the direction of the arrow until it stops.

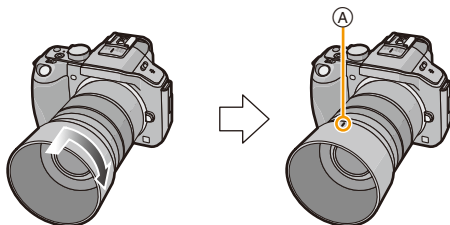

Note

- When temporarily detaching and carrying the lens hood, attach the lens hood to the lens in the reverse direction.
- Hold the short sides of the flower shaped lens hood when attaching or detaching it.

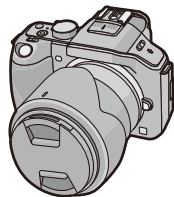

Attaching the Shoulder Strap

- We recommend attaching the shoulder strap when using the camera to prevent it from dropping.

1 Pass the shoulder strap through the shoulder strap eyelet on the camera body.

(A): Shoulder strap eyelet

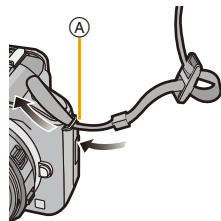

2 Pass the end of the shoulder strap through the ring in the direction of the arrow and then pass it through the stopper.

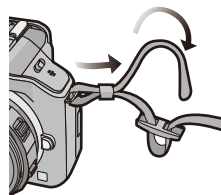

3 Pass the end of the shoulder strap through the hole on the other side of the stopper.

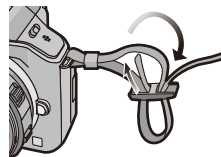

4 Pull the other side of the shoulder strap and then check that it will not come out.

- Perform steps **1** to **4** and then attach the other side of the shoulder strap.

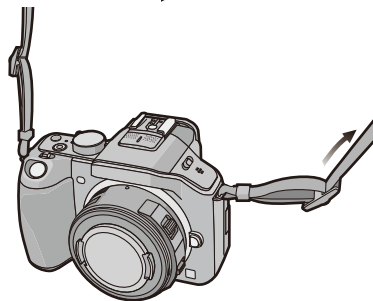

Note

- Use the shoulder strap around your shoulder.
 - Do not wrap the strap around your neck.
 - It may result in injury or accident.
- Do not leave the shoulder strap where an infant can reach it.
 - It may result in an accident by mistakenly wrapping around the neck.

Charging the Battery

About batteries that you can use with this unit

It has been found that counterfeit battery packs which look very similar to the genuine product are made available for purchase in some markets. Some of these battery packs are not adequately protected with internal protection to meet the requirements of appropriate safety standards. There is a possibility that these battery packs may lead to fire or explosion. Please be advised that we are not liable for any accident or failure occurring as a result of use of a counterfeit battery pack. To ensure that safe products are used, we recommend that a genuine Panasonic battery pack is used.

- Use the dedicated charger and battery.

Charging

- The battery is not charged when the camera is shipped. Charge the battery before use.
- Charge the battery with the charger indoors.

- 1 Attach the battery paying attention to the direction of the battery.

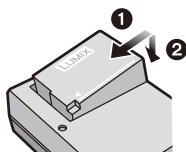

- 2 Connect the charger to the electrical outlet.

- The [CHARGE] indicator (A) lights up and charging begins.

plug-in type

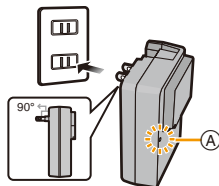

inlet type

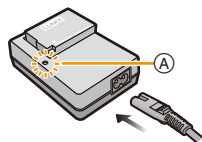

■ About the [CHARGE] indicator

The [CHARGE] indicator turns on:

The [CHARGE] indicator is turned on during charging.

The [CHARGE] indicator turns off:

The [CHARGE] indicator will turn off once the charging has completed without any problem. (Disconnect the charger from the electrical socket and detach the battery after charging is completed.)

• When the [CHARGE] indicator flashes

- The battery temperature is too high or too low. It is recommended to charge the battery again in an ambient temperature of between 10 °C and 30 °C (50 °F and 86 °F).
- The terminals of the charger or the battery are dirty. In this case, wipe them with a dry cloth.

■ Charging time

Charging time	Approx. 140 min
----------------------	------------------------

- The indicated charging time is for when the battery has been discharged completely. The charging time may vary depending on how the battery has been used. The charging time for the battery in hot/cold environments or a battery that has not been used for a long time may be longer than normal.

■ Battery indication

The battery indication is displayed on the screen.



- The indication turns red and blinks if the remaining battery power is exhausted. (The status indicator also blinks) Recharge the battery or replace it with a fully charged battery.

📌 Note

- **Do not leave any metal items (such as clips) near the contact areas of the power plug. Otherwise, a fire and/or electric shocks may be caused by short-circuiting or the resulting heat generated.**
- The battery can be recharged even when it still has some charge left, but it is not recommended that the battery charge be frequently topped up while the battery is fully charged. (Since characteristic swelling may occur.)

Approximate operating time and number of recordable pictures

Recording still pictures (when using the LCD monitor/Viewfinder) (By CIPA standard in Program AE Mode)

When the interchangeable lens (H-PS14042) is used	
Number of recordable pictures	Approx. 320 pictures
Recording time	Approx. 160 min

When the interchangeable lens (H-FS014042) is used	
Number of recordable pictures	Approx. 310 pictures
Recording time	Approx. 155 min

When the interchangeable lens (H-FS45150) is used	
Number of recordable pictures	Approx. 320 pictures
Recording time	Approx. 160 min

Recording conditions by CIPA standard

- CIPA is an abbreviation of [Camera & Imaging Products Association].
- Temperature: 23 °C (73.4 °F)/Humidity: 50%RH when LCD monitor is on.
- Using a Panasonic SD Memory Card (4 GB).
- Using the supplied battery.
- Starting recording 30 seconds after the camera is turned on.
(When attaching an interchangeable lens compatible with the Optical Image stabilizer function, set the Optical Image stabilizer to )
- **Recording once every 30 seconds** using full flash every second recording.
- When an interchangeable lens compatible with power zoom (electrically operated zoom) is attached, the zoom moves from Tele to Wide or from Wide to Tele on each recording.
- Turning the camera off every 10 recordings and leaving it until the temperature of the battery decreases.

The number of recordable pictures varies depending on the recording interval time. If the recording interval time becomes longer, the number of recordable pictures decreases. [For example, if you were to take one picture every two minutes, then the number of pictures would be reduced to approximately one-quarter of the number of pictures given above (based upon one picture taken every 30 seconds).]

■ Recording motion pictures (when using the LCD monitor)

– [AVCHD] (Recording with picture quality set to [FSH])

When the interchangeable lens (H-PS14042) is used

Recordable time	Approx. 150 min
Actual recordable time	Approx. 75 min

When the interchangeable lens (H-FS014042) is used

Recordable time	Approx. 140 min
Actual recordable time	Approx. 70 min

When the interchangeable lens (H-FS45150) is used

Recordable time	Approx. 150 min
Actual recordable time	Approx. 75 min

– [MP4] (Recording with picture quality set to [FHD])

When the interchangeable lens (H-PS14042) is used

Recordable time	Approx. 150 min
Actual recordable time	Approx. 75 min

When the interchangeable lens (H-FS014042) is used

Recordable time	Approx. 140 min
Actual recordable time	Approx. 70 min

When the interchangeable lens (H-FS45150) is used

Recordable time	Approx. 150 min
Actual recordable time	Approx. 75 min

- These times are for an ambient temperature of 23 °C (73.4 °F) and a humidity of 50%RH. Please be aware that these times are approximate.
- Actual recordable time is the time available for recording when repeating actions such as turning this unit on and off, starting/stopping recording, etc.
- Maximum time to record motion pictures continuously with [PSH] in [AVCHD] is 29 minutes 59 seconds.
- Maximum time to record motion pictures continuously with [MP4] is 29 minutes 59 seconds or up to 4 GB. (For [FHD] in [MP4] format, the file size is large and so the recordable time will drop below 29 minutes 59 seconds.)

■ Playback (when using the LCD monitor)

When the interchangeable lens (H-PS14042) is used

Playback time

Approx. 200 min

When the interchangeable lens (H-FS014042) is used

Playback time

Approx. 190 min

When the interchangeable lens (H-FS45150) is used

Playback time

Approx. 210 min

Note

- **The operating times and number of recordable pictures will differ according to the environment and the operating conditions.**

For example, in the following cases, the operating times shorten and the number of recordable pictures is reduced.

- In low-temperature environments, such as on ski slopes.
- Using the [AUTO] of [LCD Mode] or [MODE1] of [LCD Mode].
- When flash is used repeatedly.
- When the operating time of the camera becomes extremely short even after properly charging the battery, the life of the battery may have expired. Buy a new battery.

Inserting and Removing the Card (optional)/ the Battery

- Check that this unit is turned off.
- We recommend using a Panasonic card.

1 Slide the release lever in the direction of the arrow and open the card/battery door.

- Always use genuine Panasonic batteries.
- If you use other batteries, we cannot guarantee the quality of this product.

2 Battery: Being careful about the battery orientation, insert all the way until you hear a locking sound and then check that it is locked by lever **A**.

Pull the lever **A** in the direction of the arrow to remove the battery.

Card: Push it securely all the way until you hear a “click” while being careful about the direction in which you insert it.

To remove the card, push the card until it clicks, then pull the card out upright.

B: Do not touch the connection terminals of the card.

3 **1:** Close the card/battery door.

2: Slide the release lever in the direction of the arrow.

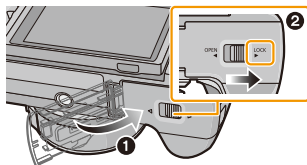
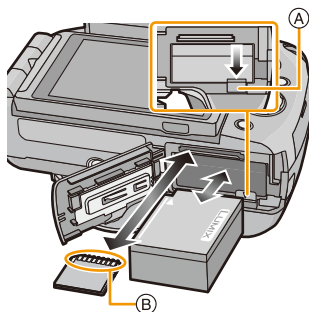
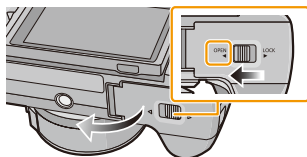

Note

- Remove the battery after use. (The battery will be exhausted if left for a long period of time after being charged.)
- The battery becomes warm after using it and during and after charging. The camera also becomes warm during use. This is not a malfunction.
- Before removing the card or battery, turn the camera off, and wait until the status indicator has gone off completely. (Otherwise, this unit may no longer operate normally and the card itself may be damaged or the recorded pictures may be lost.)

About the Card

About cards that can be used with this unit

The following cards which conform to the SD video standard can be used with this unit.
(These cards are indicated as **card** in the text.)

	Remarks
SD Memory Card (8 MB to 2 GB)	<ul style="list-style-type: none"> • Use a card with SD Speed Class* with “Class 4” or higher when recording motion pictures. • SDHC Memory Card can be used with SDHC Memory Card or SDXC Memory Card compatible equipment. • SDXC Memory Card can only be used with SDXC Memory Card compatible equipment. • Check that the PC and other equipment are compatible when using the SDXC Memory Cards. http://panasonic.net/avc/sdcard/information/SDXC.html • This unit is compatible with UHS-I standard SDHC/SDXC memory cards. • Only the cards with capacity listed left can be used.
SDHC Memory Card (4 GB to 32 GB)	
SDXC Memory Card (48 GB, 64 GB)	

* SD Speed Class is the speed standard regarding continuous writing. Check via the label on the card, etc.

e.g.:



• Please confirm the latest information on the following website.

<http://panasonic.jp/support/global/cs/dsc/>

(This Site is English only.)

Access to the card

The access indication displays red when pictures are being recorded on the card.

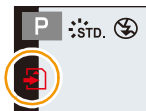

• During access (image writing, reading and deleting, formatting etc.), do not turn this unit off, remove the battery, card or disconnect the AC adaptor (optional). Furthermore, do not subject the camera to vibration, impact or static electricity.

The card or the data on the card may be damaged, and this unit may no longer operate normally.

If operation fails due to vibration, impact or static electricity, perform the operation again.

Note

• Write-Protect switch (A) provided (When this switch is set to the [LOCK] position, no further data writing, deletion or formatting is possible. The ability to write, delete and format data is restored when the switch is returned to its original position.)

• The data on the card may be damaged or lost due to electromagnetic waves, static electricity or breakdown of the camera or the card. We recommend storing important data on a PC etc.

• Do not format the card on your PC or other equipment. Format it on the camera only to ensure proper operation. (P77)

• Keep the Memory Card out of reach of children to prevent swallowing.

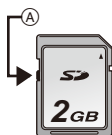

Approximate number of recordable pictures and available recording time

About the display of the number of recordable pictures and available recording time

- Switching between the display of number of recordable pictures and available recording time can be performed in the [Remaining Disp.] (P171) in the [Custom] menu.

- (A) Number of recordable pictures
- (B) Available recording time

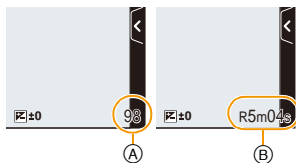

Number of recordable pictures

- [9999+] is displayed if there are more than 10000 pictures remaining.

Aspect ratio [4:3], Quality [FINE]

[Picture Size]	2 GB	8 GB	32 GB	64 GB
L (16M)	220	890	3630	7260
M (8M)	400	1630	6600	13000
S (4M)	670	2710	10980	21490

Aspect ratio [4:3], Quality [RAW]

[Picture Size]	2 GB	8 GB	32 GB	64 GB
L (16M)	68	270	1110	2230
M (8M)	79	320	1290	2580
S (4M)	86	340	1400	2800

Available recording time (when recording motion pictures)

- “h” is an abbreviation for hour, “m” for minute and “s” for second.

[AVCHD]

[Rec Quality]	2 GB	8 GB	32 GB	64 GB
PSH	8m00s	36m00s	2h31m	5h7m
FSH/FPH/SH	13m00s	1h00m	4h9m	8h25m

[MP4]

[Rec Quality]	2 GB	8 GB	32 GB	64 GB
FHD	11m18s	49m5s	3h22m13s	6h50m11s
HD	21m34s	1h33m43s	6h26m4s	13h3m6s
VGA	47m28s	3h26m16s	14h9m40s	28h43m28s

Note

- The number of recordable pictures and the available recording time are an approximation. (These vary depending on the recording conditions and the type of card.)
- The number of recordable pictures and the available recording time varies depending on the subjects.
- Maximum time to record motion pictures continuously with [PSH] in [AVCHD] is 29 minutes 59 seconds.
- Maximum time to record motion pictures continuously with [MP4] is 29 minutes 59 seconds or up to 4 GB. (For [FHD] in [MP4] format, the file size is large and so the recordable time will drop below 29 minutes 59 seconds.)
- The maximum available continuous recording time is displayed on the screen.

Setting Date/Time (Clock Set)

- The clock is not set when the camera is shipped.

1 Turn the camera on.

- The status indicator ❶ lights when you turn this unit on.
- If the language select screen is not displayed, proceed to step 4.

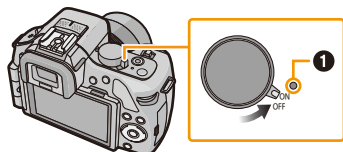

2 Touch [Language Set].

3 Select the language.

4 Touch [Clock Set].



5 Touch the items you wish to set (Year/Month/Day/Hours/Minutes), and set using [^]/[v].

- Ⓐ: Time at the home area
- Ⓑ: Time at the travel destination

- You can continue to switch the settings by continuously touching [^]/[v].
- Touch [⏪] to cancel the date and time settings without setting a date and time.

To set the display order and the time display format.

- Touch [Style] to display the settings screen for setting display order/time display format.



6 Touch [Set] to set.

7 Touch [Set] in the confirmation screen.

- When the clock setting is complete, the confirmation screen for the function lever setting is displayed. Select [Change] or [Exit]. (You can check/uncheck the check box each time you touch [Don't show this again].)

For [Function Lever] refer to P15.

Changing the Clock Setting

Select **[Clock Set]** in the **[Setup]** menu. (P64)

- The clock can be reset as shown in steps **5** and **6**.
- **The clock setting is maintained for 3 months using the built-in clock battery even without the battery. (Leave the charged battery in the unit for 24 hours to charge the built-in battery.)**



Note

- If the clock is not set, the correct date cannot be printed when you stamp the date on the pictures with [Text Stamp] or order a photo studio to print the pictures.
- If the clock is set, the correct date can be printed even if the date is not displayed on the screen of the camera.

Selecting the Recording Mode

- To select a Recording Mode with the mode dial

Select the mode by rotating the mode dial.

- Rotate the mode dial slowly to select the desired mode **(A)**.

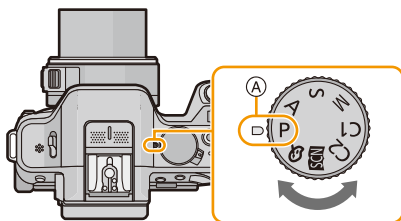



- To select Intelligent Auto Mode

Press **[iA]**.

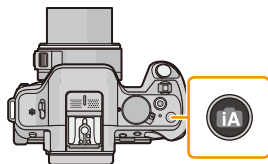

- **[iA]** button will light up when it is switched to Intelligent Auto Mode.
- The Recording Mode selected by the mode dial is disabled while the **[iA]** button is lit.



■ Basic

 Intelligent Auto Mode (P42)
The subjects are recorded using settings automatically selected by the camera.
 Intelligent Auto Plus Mode (P46)
The subjects are recorded using settings automatically set by the camera, but color, brightness and defocus effect can be adjusted.
P Program AE Mode (P50)
The subjects are recorded using your own settings.

■ Advanced

A Aperture-Priority AE Mode (P117)
The shutter speed is automatically determined by the aperture value you set.
S Shutter-Priority AE Mode (P118)
The aperture value is automatically determined by the shutter speed you set.
M Manual Exposure Mode (P119)
The exposure is adjusted by the aperture value and the shutter speed which are manually adjusted.
C1 C2 Custom Mode (P139)
Use this mode to take pictures with previously registered settings.
 Scene Guide Mode (P121)
This allows you to take pictures that match the scene being recorded.
 Creative Control Mode (P130)
Record while checking the image effect.

Tips for taking good pictures

Hold the camera gently with both hands, keep your arms still at your side and stand with your feet slightly apart.

- Do not cover the flash, the AF assist lamp (A) or the microphone (B) with your fingers or other objects.
- Be careful not to move the camera when you press the shutter button.
- When taking pictures, make sure your footing is stable and there is no danger of colliding with another person, an object etc.

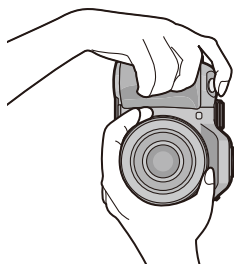
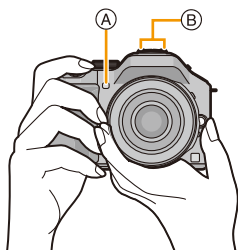

Detects orientation of camera (Direction Detection Function)

This function detects the vertical orientation when you record with the camera vertically orientated. When you play back the recording, the recording is automatically displayed in vertical orientation. (Only available when [Rotate Disp.] (P75) is set to [ON].)

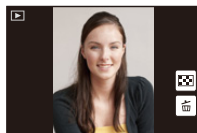

- When recording with this unit, Direction Detection can be performed even if you are using a lens that is not compatible with the Direction Detection Function.
- When the camera is held vertically and tilted significantly up or down to record, the Direction Detection Function may not work correctly.
- Motion pictures taken with the camera held vertically are not displayed vertically.
- You cannot record 3D pictures in vertical orientation.

Using the Viewfinder

Switching the LCD monitor/Viewfinder

About the eye sensor automatic switching

When [LVF/LCD Auto] of [Eye Sensor] (P170) in the [Custom] menu is set to [ON] and your eye or an object is brought close to the viewfinder, the display automatically switches to the viewfinder display.

Sensitivity of the eye sensor can be set to [HIGH] or [LOW] with [Sensitivity].

- Eye sensor might not work properly depending on the shape of your eyeglasses, the way you hold the camera, or bright light shining around the eyepiece. Switch manually in that case.
- The eye sensor is disabled during motion picture playback and slide show.

Switching the LCD monitor/Viewfinder manually

[LVF/LCD/Fn3] button can be used in two ways, as [LVF/LCD] or as [Fn3] (function 3). At the time of purchase, it is initially set to [LVF/LCD].

- To switch the setting, select using [LVF/LCD / Fn3] in [Custom] menu.
- Refer to P113 for details about the function button.

Press [LVF/LCD] to switch the monitor screen.

- (A) [LVF/LCD/Fn3] button
- (B) Eye sensor

- When [LVF/LCD / Fn3] in the [Custom] menu is set to [Fn3], use the eye sensor to switch between the LCD display and the viewfinder.

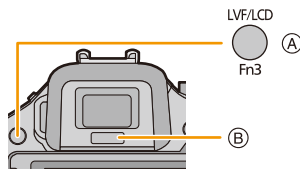

Diopter adjustment

Adjust the diopter to suit your vision so that you can see the characters displayed in the viewfinder clearly.

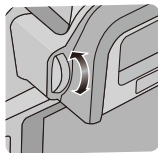

About the Eye Sensor AF

If [Eye Sensor AF] in the [Custom] menu is set to [ON], the camera automatically adjusts the focus as the eye sensor is activated.

Note

- Beep sounds are not emitted when the focus is achieved in [Eye Sensor AF].
- [Eye Sensor AF] may not work in dimly lit conditions.
- The [Eye Sensor AF] feature is disabled in the following conditions:
 - With lenses that only offer Manual Focus
 - With some Four Third lenses

Setting the focus position with the Touch Pad

If you set [Touch Pad AF] of [Touch Settings] (P171) in the [Custom] menu to [ON] when the viewfinder is in use, you can use the LCD monitor as the TouchPad. Touch the LCD monitor to move the AF area on the viewfinder to a desired position.

- Press the shutter button halfway to determine the focus position.
If you press [⏏/➡] before determining the focus position, the AF area frame returns to the center position.
- To cancel the AF area frame when the Auto Focus Mode (P95) is set to [👤] ([Face Detection]), [👤] ([AF Tracking]) or [👤] ([23-Area]), press [MENU/SET].

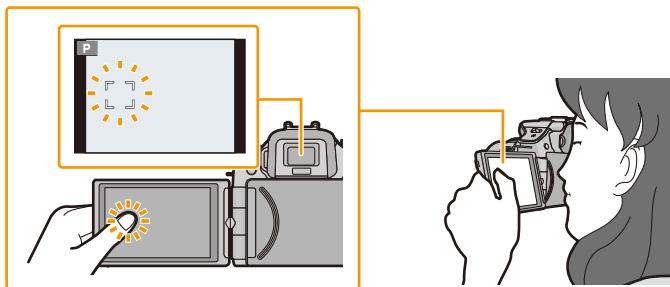

Note

- The Touch Shutter function (P39) is disabled when using [Touch Pad AF].

Taking a Still picture

Applicable modes:   **P** **A** **S** **M** **C1** **C2**  

How to set focus when taking a still picture (AFS/AFF/AFC)

1 Select [Focus Mode] from the [Rec] menu. (P64)

2 Touch the item.

- Select [Focus Mode] according to the movement of the subject and the scene you are recording.



Item	The movement of the subject and the scene (recommended)	Description of settings
AFS	Subject is still (Scenery, anniversary photograph, etc.)	"AFS" is an abbreviation of "Auto Focus Single". Focus is set automatically when the shutter button is pressed halfway. Focus will be fixed while it is pressed halfway.
AFF	Movement cannot be predicted (Children, pets, etc.)	"AFF" is an abbreviation of "Auto Focus Flexible". In this mode, focusing is performed automatically when the shutter button is pressed halfway. If the subject moves while the shutter button is pressed halfway, the focus is corrected to match the movement automatically.
AFC	Subject is moving (Sport, trains, etc.)	"AFC" is an abbreviation of "Auto Focus Continuous". In this mode, while the shutter button is pressed halfway, focusing is constantly performed to match the movement of the subject. When the subject is moving, the focusing is performed by predicting the subject position at the time of recording. (Movement prediction)
MF	Set the focus manually. (P101)	

• **When recording using [AFF], [AFC]**

- It may take time to focus on the subject when you operate the zoom from Wide to Tele or suddenly change the subject from a distant one to a nearby one.
- Press the shutter button halfway again when it is difficult to focus on the subject.
- While the shutter button is pressed halfway, shake may be seen on the screen.
- Depending on the lens used, [AFF] and [AFC] may not operate. Refer to the website on P16.
- Exit the menu after it is set.

3 Press the shutter button halfway.

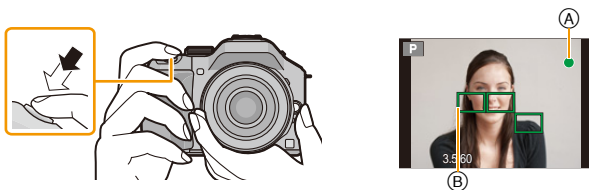

Focus Mode		AFS	
Focus		When the subject is focused	When the subject is not focused
Focus indication	(A)	On	Blinks
AF area	(B)	Green	—
Sound		Beeps 2 times	—

Focus Mode		AFF/AFC	
Focus		When the subject is focused	When the subject is not focused
Focus indication	(A)	On	Blinks or Off
AF area	(B)	Green*1	—
Sound		Beeps 2 times*2	—

*1 When AF Mode is set to [AF-ON], the first AF area at which focus is achieved may be displayed momentarily while pressing halfway.

*2 A beep will be emitted when focus is first achieved during the pressing halfway.

- When the brightness is insufficient for [AFF] or [AFC], the camera will operate as if [AFS] has been set. In this case, the display will change to the yellow [AFS].

Note

- If you zoom in/out after focusing on a subject, the focus may lose its accuracy. In that case, re-adjust the focus.
- The focus range is different depending on the lens used.
 - When the interchangeable lens (H-PS14042) is used: 0.2 m (0.66 feet) (Wide to focal length 20 mm) to ∞ , 0.3 m (0.99 feet) (focal length 21 mm to Tele) to ∞
 - When the interchangeable lens (H-FS014042) is used: 0.3 m (0.99 feet) to ∞
 - When the interchangeable lens (H-FS45150) is used: 0.9 m (2.95 feet) to ∞

Subjects and recording conditions which are difficult to focus

- Fast-moving subjects, extremely bright subjects or subjects without contrast.
- When recording subjects through windows or near shiny objects.
- When it is dark or when jitter occurs.
- When the camera is too close to the subject or when taking a picture of both distant and near subjects.

Taking a still picture

- Set the drive mode to [] by pressing ▼ ([]).

1 Select the Recording Mode.

2 Press the shutter button halfway to focus.

- (A) Aperture value
- (B) Shutter speed

- Aperture value and shutter speed are displayed. (It will flash in red if the correct exposure is not achieved, except when set to flash.)
- When the image is correctly focused, the picture will be taken, since the [Focus Priority] (P167) is set initially to [ON].**

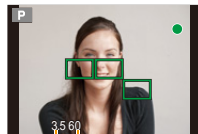

3 Press the shutter button fully (push it in further), and take the picture.



Taking pictures using the Touch Shutter function

Just by touching the subject you want as your point of focus, the camera will focus on the subject and take the picture automatically.

1 Touch [⏪].

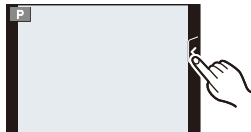

2 Touch [🖱️].

- Icon will change to [🖱️], and taking a picture with the Touch Shutter function becomes possible.

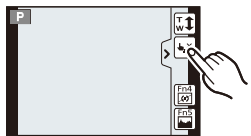

3 Touch the subject you wish to focus on, and then take a picture.

- AF area with same function as [📏] in AF mode is displayed at the position you touch, and picture is taken when it is focused when the AF mode is set to [👤], [🔍], [📏] or [📏].
- The position you touched is enlarged and picture is taken when it is focused when the AF mode is set to [📏]. (Cannot be set at the edge of the screen)
- If the histogram is displayed on top of the subject you want to touch, touch the subject after first moving the histogram by dragging it (P13).

■ To cancel the Touch Shutter function



Touch [🖱️].

Note

- If [Focus Priority] is [ON], when the [Focus Mode] is set to [AFS] and the Touch Shutter fails, if the AF area briefly turns red and disappears, this signifies that the picture cannot be taken under the current conditions.
When set to [AFF] or [AFC], the picture will not be taken if the focus indication is flashing green, but if the subject comes into focus while you are touching the screen, the picture will be taken.
- Measurement of brightness is performed on the spot touched when the [Metering Mode] (P151) is set to [☐]. At the edge of the screen, the metering may be affected by the brightness around the touched location.

Switching the Information Displayed on the recording screen

Press [DISP.] to change.

- You can select between [] (LCD monitor style) and [] (viewfinder style) for each of the LCD monitor and the viewfinder display screen using [LCD Disp.Style] and [LVF Disp.Style] in the [Custom] menu.

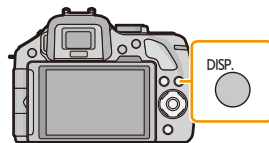

[] LCD monitor style

- Screen will switch as follows:
(Example of LCD monitor display)

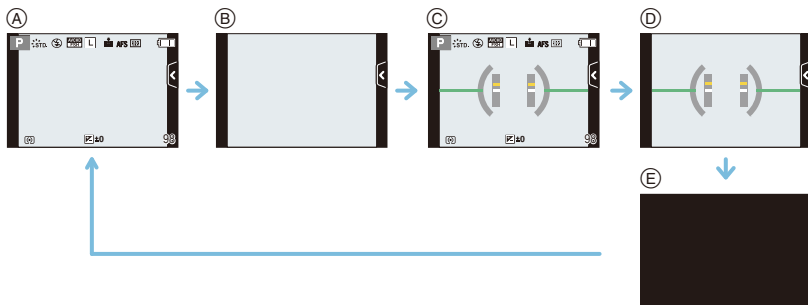

- (A) With information*
- (B) Without information
- (C) With information (tilt sensor display)*
- (D) Without information (tilt sensor display)
- (E) Turned off

[] viewfinder style

- Screen will switch as follows:
(Example of display on viewfinder)

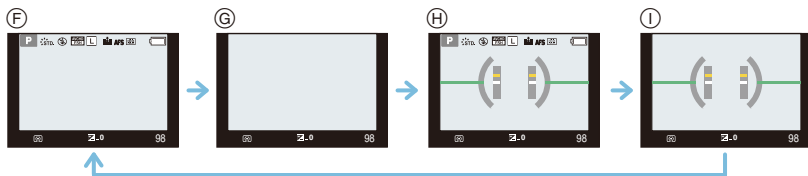

- (F) With information (detailed information)*
- (G) With information
- (H) With information (detailed information, tilt sensor display)*
- (I) With information (tilt sensor display)

- * Histograms are displayed when the [Histogram] of the [Custom] menu is set to [ON]. It is also possible to display the Exposure meter by setting the [Expo.Meter] of the [Custom] menu to [ON]. (P166)

Note

- If approximately 1 minute elapses without an operation being performed, part of the display will disappear. Press [DISP.] or touch the LCD monitor to make the display reappear.

About the tilt sensor display

With the tilt sensor displayed, it is easy to correct the tilt of the camera etc.

1 Press [DISP.] to display the tilt sensor.

2 Check the tilt of the camera.

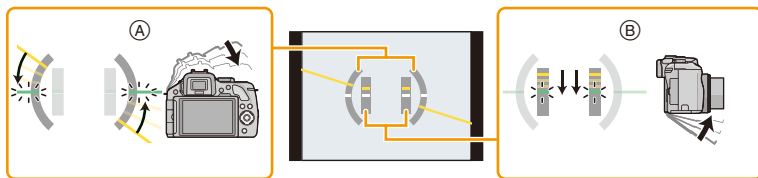

(A) Horizontal direction:

Correcting tilt to the left

(B) Vertical direction:

Correcting downward tilt

- When the tilt of the camera is little, the indicator changes to green.
- When recording with a vertical orientation, the display automatically switches to a vertically orientated display.

Note

- Even after correcting the tilt, there may still be an error of approximately $\pm 1^\circ$.
- When [Fn Button Set] of the [Custom] menu is set to [Level Gauge], you can switch the tilt sensor display on/off by pressing function button.
- When tilted significantly upwards or downwards to record, the tilt sensor display may not be displayed correctly, and the Direction Detection Function (P33) may not work correctly.





Taking Pictures using the Automatic Function

(Intelligent Auto Mode)

Recording Mode:

In this mode, the camera makes the optimal settings for the subject and scene, so we recommend it when you wish to leave the settings to the camera and record without thinking about them.

Press .

- The camera will switch to either the most recently used of Intelligent Auto Mode or Intelligent Auto Plus Mode. (P46) At the time of purchase, the mode is set to Intelligent Auto Mode.
-  button will light up when it is switched to Intelligent Auto Mode. (Light turns off during recording)
-  button is turned off when it is pressed again, and it will be set to the [Rec] Modes selected by the mode dial.
- Defocus control can be set by touching  on the recording screen and then touching . (P48)
- When the subject is touched, AF Tracking function works. It is also possible by pressing the cursor button towards , and then pressing the shutter button halfway. For details, refer to P97.

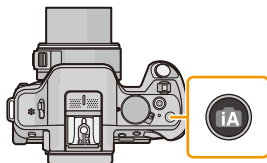









■ Scene Detection

When the camera identifies the optimum scene, the icon of the scene concerned is displayed in blue for 2 seconds, after which its color changes to the usual red.



Depending on the identified scene, the camera may display , which allows you to select the camera-recommended effects. For details, refer to “Recording with Camera-Recommended Effects” on P45.







When taking pictures









 →	 [i-Portrait]
	 [i-Scenery]
	 [i-Macro]
	 [i-Night Portrait]* ¹
	 [i-Night Scenery]
	 [i-Baby]* ²
	 [i-Sunset]

*¹ Only when  (AUTO) is selected.

*² When  is set to [ON],  will be displayed for birthdays of registered faces already set only when the face of a person 3 years old or younger is detected.

When recording motion pictures

 →	 [i-Portrait]
	 [i-Scenery]
	 [i-Low Light]
	 [i-Macro]

-  is set if none of the scenes are applicable, and the standard settings are set.
- When ,  or  is selected, the camera automatically detects a person's face, and it will adjust the focus and exposure. **(Face Detection)**
- If a tripod is used, for instance, and the camera has judged that camera shake is minimal when the Scene detection has been identified as , the shutter speed will be slower than normal. Take care not to move the camera while taking pictures.
- An optimum scene for the specified subject will be chosen when set to AF tracking.
- When [Face Recog.] is set to [ON], and the face similar to the registered face is detected, [R] is displayed in the top right of ,  and .
- Due to conditions such as the ones below, a different scene may be identified for the same subject.
 - Subject conditions: When the face is bright or dark, the size of the subject, the color of the subject, the distance to the subject, the contrast of the subject, when the subject is moving
 - Recording conditions: Sunset, sunrise, under low brightness conditions, when the camera is shaken, when zoom is used
- To take pictures in an intended scene, it is recommended that you take pictures in the appropriate Recording Mode.

■ About the flash

Flash mode is set to [📷] when the flash is closed, and [📷A] (AUTO) when it is open. When the flash is open, the camera automatically sets [📷A], [📷A] (AUTO/Red-Eye Reduction), [📷A], or [📷S] to match the type of subject and brightness.

Note

- **Open the flash when the flash is to be used. (P84)**
- When [📷A] or [📷A] is set, Digital Red-Eye Correction is enabled.
- Shutter speed will be slower during [📷A] or [📷S].

■ Functions that work automatically and menu options which are disabled

The following functions are performed automatically to allow the camera to make the optimal settings.

- Scene Detection/Backlight Compensation/Face Detection/Auto White Balance/Intelligent ISO sensitivity control/[Red-Eye Removal]/[i.Resolution]/[i.Dynamic]/[Long Shtr NR]/[Shading Comp.]/[Quick AF]/[AF Assist Lamp]

Because the camera makes the optimal settings automatically, the following menus are disabled.

Menu	Item
[Rec]	Items other than [Standard] and [Monochrome] in [Photo Style]/[Metering Mode]/[HDR]/[i.Dynamic]/[Flash]/[Red-Eye Removal]/[Flash Synchro]/[Flash Adjust.]/[i.Resolution]/[ISO Limit Set]/[ISO Increments]/[Long Shtr NR]/[Shading Comp.]/[Digital Zoom]
[Motion Picture]	Items other than [Standard] and [Monochrome] in [Photo Style]/[Picture Mode]/[Metering Mode]/[i.Dynamic]/[i.Resolution]/[Digital Zoom]/[Flkr Decrease]
[Custom Menu]	[Cust.Set Mem.]/[Expo.Meter]/[AF/AE Lock]/[AF/AE Lock Hold]/[Quick AF]/[Eye Sensor AF]/[Direct Focus Area]/[Shutter AF]/[AF Assist Lamp]/[AF+MF]

- For the setting method of the menu, refer to P64.

Note

• The Backlight Compensation

- When there is a backlight, the subject appears darker and the camera will automatically attempt to correct it by increasing the brightness of the picture. In Intelligent Auto Mode, backlight compensation works automatically.

Recording with Camera-Recommended Effects



Depending on the scene that is automatically identified, it may be possible to select from a number of different image effects (filters) automatically recommended by the camera, with reference to example images. (Only available when [Recommended Filter] on the recording menu is set to [ON]. At the time of purchase, this setting is [ON].)

1 Touch the , which is automatically displayed after automatic detection.

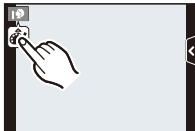
- The selection screen for camera-recommended effects is displayed.
- The selection screen can also be displayed by pressing .



2 Touch the example image to select image effects (filters).



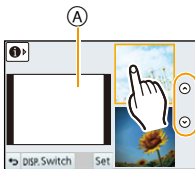

- The image effect of the selected example image will be applied in a preview display .
- The image effect can be switched by touching /.



3 Touch [Set].

- The Creative Control Mode for the selected image effect is set.

Note

-  is displayed on the recording screen. Touch to return to Intelligent Auto ( or  Mode. The same operation can be performed by pressing the  button.
- When using a recommended filter, you cannot use menus or recording functions not available in Creative Control Mode.
- For how to adjust the image effects and other information, refer to “Taking Pictures with different image effects (Creative Control Mode)” on [P130](#).
- Recommended filter is unavailable when the viewfinder is in use.

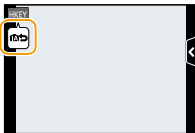

Recording using Intelligent Auto Plus Mode

Recording Mode:

The brightness and color optimally set by the camera can be easily matched to your preferences. This mode is useful if you do not like dealing with detailed settings but like the settings made automatically by the camera to match your preferences.

- Except for allowing setting of the brightness and color, Intelligent Auto Plus Mode is identical to Intelligent Auto Mode.

1 Press [MENU/SET] when in Intelligent Auto Mode.



2 Touch [iA MODE].

3 Select [] and then touch [Set].



Setting brightness

1 Touch [].



2 Touch [] to display the setting screen.

- The setting screen can also be displayed from the recording screen by pressing rear dial.
- Each press of the rear dial switches among brightness setting, Defocus Control (P48) and end operation.

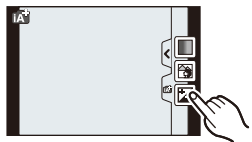

3 Drag the slide bar to set.

- This will adjust the brightness of the image.
- Setting can also be performed by rotating the rear dial.
- Touch [] again to return to the recording screen. You can also return to the recording screen by pressing the rear dial.

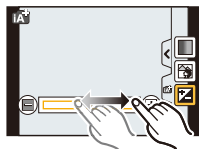

Setting color

1 Touch [].



2 Touch [] to display the setting screen.

- The settings screen can also be displayed from the recording screen by pressing cursor button ►.

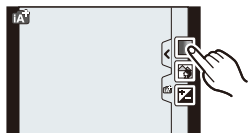

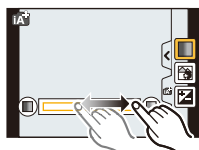

3 Drag the slide bar to set.

- This will adjust the color of the image from a reddish color to a bluish color.
- Setting can also be performed by rotating the rear dial.
- Touch [] again to return to the recording screen. You can also return to the recording screen by pressing the cursor button ►.



 **Note**

- If you touch [] during the adjustment, you can take a picture also by touching [].
- The brightness and color settings will return to the default (center point) when this unit is turned off or the camera is switched to another Recording Mode.

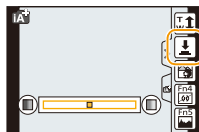

Taking Pictures with Defocus Control Function

Applicable modes:   P A S M    

You can easily set the blurriness of the background while checking the screen.

1 Touch .

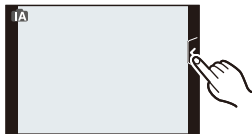

2 Touch  to display the setting screen.

- Defocus Control setting screen can also be displayed by pressing the rear dial.

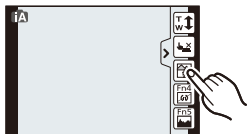

3 Drag the slide bar to set.

- Setting can also be performed by rotating the rear dial.





Strong defocus

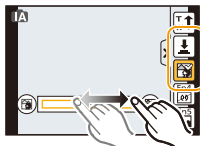

Weak defocus



4 Record pictures or motion pictures.

- Defocus Control operation can be ended by touching .
- Defocus Control operation can also be ended by pressing the rear dial.
- It is also possible to record a picture by touching .

 **Note**

- On the Defocus Control setting screen of Intelligent Auto (IA or AI) Mode, the AF Mode is [■]. You can set the location of the AF area by touching the screen. (Size cannot be changed)
- After beginning motion picture recording, the amount of defocus will vary depending on the recording conditions.
- Aperture is controlled within the range of appropriate exposure during the recording of a motion picture, so the aperture may not actually change even when the slide bar is moved depending on the brightness of the subject, and the blurriness may not change.
(When recording dark scenes in rooms etc., the aperture may remain fully open and leave the defocus state unchanged, even when you move the slide bar from end to end.)
- Depending on the lens used, you may hear a sound from the lens when the Defocus Control is used, but this is due to operation of the aperture of the lens and it is not a malfunction.
- Depending on the lens used, operational sound of the Defocus Control may be recorded during the recording of a motion picture when the function is used.
- Depending on the lens used, Defocus Control function may not operate.
Refer to the website for compatible lenses.
- In [Miniature Effect] of Creative Control Mode, Defocus Control cannot be used.

Taking Pictures with Your Favorite Settings

(Program AE Mode)

Recording Mode: **P**

The camera automatically sets the shutter speed and the aperture value according to the brightness of the subject.

You can take pictures with greater freedom by changing various settings in the [Rec] menu.

Set the mode dial to **[P]**.

Note

- The shutter speed is automatically set between about 20 seconds and 1/4000th of a second in the following cases.
 - When the [Sensitivity] is set to [ISO160].
 - When the aperture value is set to F3.5 [when the interchangeable lens (H-PS14042, H-FS014042) is attached].
 - When the aperture value is set to F4.0 [when the interchangeable lens (H-FS45150) is attached].

Program Shift

In Program AE Mode, you can change the preset aperture value and shutter speed without changing the exposure. This is called Program Shift.

You can make the background more blurred by decreasing the aperture value or record a moving subject more dynamically by slowing the shutter speed when taking a picture in Program AE Mode.

- 1 Press the shutter button halfway and display the aperture value and shutter speed value on the screen.
- 2 While the values are displayed (about 10 seconds), perform the Program Shift by rotating the rear dial.

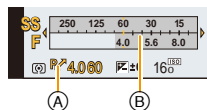

- It will switch between Program Shift operation and Exposure Compensation operation (P88) every time the rear dial is pressed while the values are displayed.
- Rotate the rear dial to display the [Expo.Meter] (B). (P166)
- The Program Shift indication (A) appears on the screen when Program Shift is activated.
- To cancel Program Shift, turn the camera off or rotate the rear dial until the Program Shift indication disappears.
Program Shift is easily canceled by setting [Fn Button Set] on the [Custom] menu to [One Push AE]. (P116)

Example of Program Shift

[When the interchangeable lens (H-PS14042) is used]

(A): Aperture value

(B): Shutter speed

- 1 Program Shift amount
- 2 Program Shift line chart
- 3 Program Shift limit

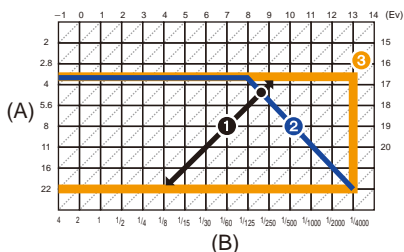

Note

- EV is an abbreviation of [Exposure Value].
The EV changes with the aperture value or the shutter speed.
- If the exposure is not adequate when the shutter button is pressed halfway, the aperture value and shutter speed turn red and blink.
- Program Shift is canceled and the camera returns to normal Program AE Mode if more than 10 seconds pass after Program Shift is activated. However, the Program Shift setting is memorized.
- Program Shift will only allow adjustments to be made when there is an adequate amount of light.
- Program Shift is available in all [Sensitivity] settings except [ISO].

Recording Motion Picture

Applicable modes:          

This camera can record full high definition motion pictures compatible with the AVCHD format or motion pictures recorded in MP4.

Audio will be recorded in stereo.

The functions available when recording motion pictures differ according to the lens you are using, and the operational sound of the lens may be recorded.

Refer to page 16 for details.

How to set focus when recording a motion picture (Continuous AF)

Focusing varies depending on the settings of the [Focus Mode] and the [Continuous AF] in the [Motion Picture] menu.

Focus Mode	Continuous AF	Settings
AFS/AFF/AFC	ON	You can have the camera focus continuously. • Press the shutter button halfway when it is difficult to focus on the subject.
	OFF	The focus position is fixed when beginning to record a motion picture. • It is possible to set the focus by pressing the shutter button halfway or touching the subject.
MF	ON	You can focus manually.
	OFF	

- Depending on the recording conditions or lens used, operational sound may be recorded when the Auto Focus is operated while recording a motion picture. It is recommended to record with [Continuous AF] in the [Motion Picture] menu set to [OFF], if the sound of operation bothers you to avoid recording the lens noise.
- When operating the zoom when recording motion pictures, it may take time to come into focus.

Recording motion picture

1 Start recording by pressing the motion picture button.

- (A) Elapsed recording time
- (B) Available recording time

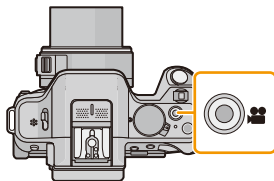

- Recording of motion picture appropriate for each mode is possible.
- The recording state indicator (red) (C) will flash while recording motion pictures.
- If approximately 1 minute elapses without an operation being performed, part of the display will disappear. Press [DISP.] or touch the LCD monitor to make the display reappear.
- When recording a motion picture, do not cover the microphone with your fingers or other objects.
- Release the motion picture button right after you press it.
- For the motion picture menu settings such as [Rec Mode], [Rec Quality], [Wind Cut] and [Mic Level Adj.], refer to P159 to 162.

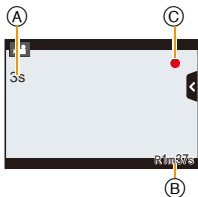

2 Stop the recording by pressing the motion picture button again.

■ About the recording format for recording motion pictures

This unit can record motion pictures in either AVCHD or MP4 formats.

AVCHD:

You can record high definition quality images with this format. It is suitable for viewing on a large format TV or for saving to disc.

AVCHD Progressive:

The [PSH] in [AVCHD] is a mode that allows motion pictures to be recorded at 1920×1080/60p, the highest quality* that complies with the AVCHD standard.

Recorded motion pictures can be saved and played back using this unit or "PHOTOfunSTUDIO".

* This means the highest quality for this unit.

MP4:

This is a simpler video format best used when extensive editing is needed, or when uploading videos to the internet.

■ About the compatibility of the recorded motion pictures

Motion pictures recorded in [AVCHD] or [MP4] may be played back with poor picture or sound quality or playback may not be possible even when played back with equipment compatible with these formats. Also, the recording information may not be displayed properly. In this case, use this unit.

• For details on AVCHD Progressive and MP4 compatible devices, refer to the support sites below.

<http://panasonic.jp/support/global/cs/dsc/>

(This Site is English only.)

Note

- The operational sound of the zoom or button operation may be recorded when it is operated during the recording of a motion picture.
- When using the interchangeable lens (H-PS14042), if you take your finger off the zoom lever, focus lever or function lever during recording of a motion picture, the sound of the lever returning may be recorded. When returning the lever to its starting position, do so quietly.
- When using the interchangeable lens (H-PS14042), zoom speed may be slower than normal when recording motion pictures.
- The available recording time displayed on the screen may not decrease regularly.
- Depending on the type of the card, the card access indication may appear for a while after recording motion pictures. This is not a malfunction.
- When the aspect ratio setting is different in still and motion pictures, the angle of view changes at the start of motion picture recording. When [Rec Area] (P171) is set to [], angle of view during motion picture recording is displayed.
- When the Extended Tele Conversion is used, the angle of view will change when the screen is switched between the still picture screen and motion picture screen, because the zoom factor is different between still pictures and motion pictures. (P80)
- If you end motion picture recording after a short time when using [Miniature Effect] of the Creative Control Mode, the camera may go on recording for a certain period. Please continue to hold the camera until the recording finishes.
- The [Sensitivity] will be set to [AUTO] (for motion pictures) when recording motion pictures. Also, the [ISO Limit Set] will not operate.
- When recording a motion picture, [Stabilizer] will be fixed to [] even if it is set to [].
- It is recommended to use a fully charged battery or AC adaptor (optional) when recording motion pictures. (P208)
- If while recording motion pictures using the AC adaptor (optional) the power supply is cut off due to a power cut or if the AC adaptor (optional) is disconnected etc., the motion picture will not be recorded.
- Motion pictures cannot be recorded in the following cases.
 - [Glistening Water]/[Glittering Illuminations]/[Soft Image of a Flower] (Scene Guide Mode)
 - [Soft Focus]/[Star Filter] (Creative Control Mode)
- It will be recorded in the following categories for certain Recording Modes. A motion picture recording matching each Recording Mode will be performed for the ones not listed below.

Selected Recording Mode	Recording Mode while recording motion picture
<ul style="list-style-type: none"> • Program AE Mode • Aperture-Priority AE Mode • Shutter-Priority AE Mode • Manual Exposure Mode 	Normal motion picture
<ul style="list-style-type: none"> • [Clear in Backlight] (Scene Guide Mode) 	Portrait Mode
<ul style="list-style-type: none"> • [Clear Nightscape]/[Artistic Nightscape]/[Clear Night Portrait] (Scene Guide Mode) 	Low Light Mode

Recording still pictures while recording motion pictures

Still pictures can be recorded even while recording a motion picture. (Simultaneous recording)

During motion picture recording, press the shutter button fully to record a still picture.

- Simultaneous recording indicator (A) is displayed while recording still pictures.
- You can also take pictures using the Touch Shutter function (P39).

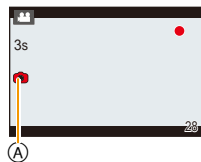

Setting motion picture and still picture priorities

Applicable modes: **P A S M C1 C2 SCN**

Recording method for the still pictures taken while recording a motion picture can be set with [Picture Mode] in the [Motion Picture] menu.

Item	Settings
<p>(Motion picture priorities)</p>	<ul style="list-style-type: none"> • Pictures will be recorded with a picture size of [S] (2 M). The picture quality may be different to [S] (2 M) of standard pictures. • Only JPEG images are recorded when [Quality] is set to [RAW$\frac{1}{2}$], [RAW$\frac{1}{4}$] or [RAW]. (When set to [RAW], still pictures will be recorded in [Quality] of [S].) • Up to 30 still pictures can be taken during recording of the motion picture. • In the Creative Control Mode [Miniature Effect], there may be a slight delay between fully pressing the shutter button and recording.
<p>(Still picture priorities)</p>	<ul style="list-style-type: none"> • Pictures will be recorded with the set picture size and quality. • The screen will go dark while recording pictures. A still picture will be recorded in the motion picture during that period, and audio is not recorded. • Up to 8 still pictures (up to 7 if [PSH] is set) can be recorded during recording of the motion picture.

Note

- The picture aspect ratio will be fixed to [16:9].
- Simultaneous recording is not possible in the following cases:
 - When [Rec Mode] is set to [VGA] in [MP4]

Playing Back Pictures/Motion Pictures

Playing Back Pictures

1 Press [▶].



2 Forward or rewind the image by dragging the screen horizontally.

Forward: drag from right to left

Rewind: drag from left to right



- It is also possible to forward or rewind the image by pressing ◀▶ of the cursor button.
- Speed of picture forwarding/rewinding changes depending on the playback status.
- You can forward or rewind pictures continuously by keeping your finger on the left or right sides of the screen after forwarding/rewinding a picture.
(Pictures are displayed reduced in size)

■ To finish playback







Press [▶] again, press the motion picture button or press the shutter button halfway.

Note

- This camera complies with the DCF standard “Design rule for Camera File system” established by JEITA “Japan Electronics and Information Technology Industries Association” and with Exif “Exchangeable Image File Format”. This camera can only display pictures that comply with the DCF standard.
- Pictures recorded with another camera may not be able to play back on this unit.

Displaying multiple screens (Multi Playback)

Touch [].

- It is possible to switch the playback screen by touching the following icons.
 - []: 1 screen
 - []: 12 screens
 - []: 30 screens
 - []: Calendar screen display
- Playback screen can also be switched by rotating the rear dial.
- Playback screen can also be switched by sliding the function lever.
- Switch the screen by touching []/[] if these are displayed on the slide bar.
- Screen can be switched by dragging the slide bar up or down.
 - Ⓐ Slide bar
- The screen can be switched gradually by dragging the screen up or down.
- Pictures displayed using [] cannot be played back.

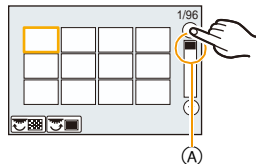
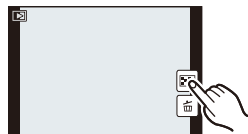

■ To return to Normal Playback

Touch the picture.

Displaying Pictures by Recording Date (Calendar Playback)

1 Touch **[CAL]** on the Multi Playback screen.

2 Touch **[^]/[v]** to select the month to be played back.

- If there were no pictures recorded during a month, that month is not displayed.
- Touch **[📅]** to display the multi playback screen.



3 Select the date you wish to play back, and then touch **[Set]**.

4 Touch the picture you wish to play back.

- To return to the calendar screen, perform one of the following operations.
 - Touch **[CAL]**
 - Rotate the rear dial to the left.
 - Slide the function lever to the left.



Note

- The recording date of the picture selected in the playback screen becomes the date selected when the Calendar screen is first displayed.
- If there are multiple pictures with the same recording date, the first picture recorded on that day is displayed.
- You can display the Calendar between January 2000 and December 2099.
- If the date is not set in the camera, the recording date is set as January 1st, 2012.
- If you take pictures after setting the travel destination in [World Time], the pictures are displayed by the dates at the travel destination in Calendar Playback.

Using the Playback Zoom

Touch the part you want to enlarge firmly.

1× → 2× → 4× → 8× → 16×

- You can also enlarge/reduce the picture by rotating the rear dial.
- You can also enlarge/reduce the picture by sliding the function lever.
- When you change the magnification, the zoom position indication (A) appears for about 1 second.
- The more a picture is enlarged, the more its quality deteriorates.
- You can move the enlarged part by dragging (P13) the screen.
- Picture will return to the original size (1×) by touching [].
- When you touch [], the magnification becomes lower.

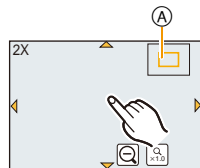

Switching the displayed image while maintaining the Playback Zoom

You can switch the displayed image while maintaining the same zoom magnification and zoom position for the Playback Zoom.

Switch to picture select operation by pressing the rear dial during Playback Zoom, and select pictures by touching []/[].

- It is also possible to forward or rewind the image by pressing ◀/▶ of the cursor button.
- The zoom position returns to the center in the following images.
 - Images with different aspect ratios
 - Images with different numbers of recorded pixels
 - Images with a different rotation direction (when [Rotate Disp.] is set to [ON])



Changing the information displayed on the playback screen

Press [DISP.] to switch the monitor screen.

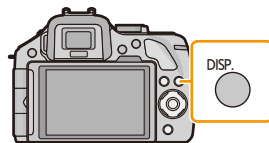

• Screen will switch as follows:

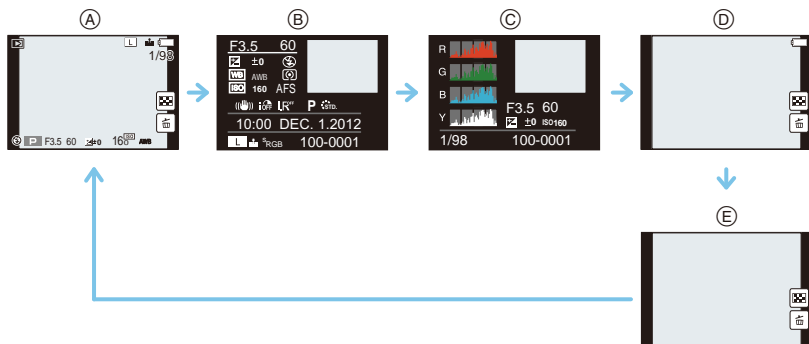

(A) With information*1

(B) Detailed information display*2 (P211)

(C) Histogram display*2 (P211)

(D) Without information (Highlight display)*1, 2, 3, 4

(E) Without information*4

*1 If approximately 1 minute elapses without an operation being performed, part of the display will disappear. Press [DISP.] or touch the LCD monitor to make the display reappear.

*2 It is not displayed during the Playback Zoom, while playing back a motion picture, or during slide show.



*3 This is displayed if [Highlight] (P165) in the [Custom] menu is set to [ON].

*4 If no operation is performed for a number of seconds, [] and other touch icons will disappear.

• Histogram is displayed in R (red), G (green), B (blue), and Y (luminance) during the playback.

Playing Back Motion Pictures

This unit was designed to play motion pictures using the AVCHD, MP4 and QuickTime Motion JPEG formats.

In Playback Mode, select a picture with the motion picture icon ([]) and touch [] in the middle of the screen.



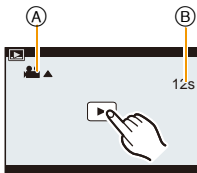

- (A) Motion picture icon
- (B) The motion picture recording time





- After playback starts, the elapsed playback time is displayed on the screen.
- For example, 8 minutes and 30 seconds is displayed as [8m30s].
- Some information (recording information, etc.) is not displayed for motion pictures recorded in [AVCHD].
- Pressing the cursor button  allows you to play back motion pictures.

Operations performed during Motion Picture Playback

	Play/Pause		Stop
	Fast rewind*		Fast forward*
	Frame-by-frame rewind (while pausing)		Frame-by-frame forward (while pausing)
	Reduce volume level		Increase volume level

- Control panel disappears after approximately 2 seconds if no operation is performed. Touch the screen to redisplay the control panel.
- Display at the right of the screen while playing back corresponds to /// on the cursor button.

* The fast forward/rewind speed increases if you touch []/[] again.

Note

- When using a high capacity card, it is possible that fast rewinding may be slower than usual.
- To play back the motion pictures recorded by this unit on a PC, use the "PHOTOfunSTUDIO" software on the CD-ROM (supplied).
- Motion pictures recorded with other camera may not be able to play back on this unit.
- Motion pictures recorded with [Miniature Effect] in Creative Control Mode play back at approximately 10 times speed.

Creating Still Pictures from a Motion Picture

You can create a single still picture from a recorded motion picture.

1 Touch [▶/||] during Motion Picture playback.

2 Touch [📷].

- Confirmation screen is displayed. It is executed when [Yes] is selected.

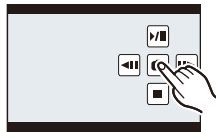

Note

- It will be saved with [Picture Size] set to [S] (2 M), [Aspect Ratio] set to [16:9], and [Quality] set to [High].
- Still pictures created from a motion picture may be coarser than with normal picture quality.
- While recording [MP4], using [VGA], the ability to create still pictures is disabled.
- You may not be able to save still pictures from a motion picture taken on other equipment.
- [📷] is displayed during playback of still pictures created from motion pictures.



Deleting Pictures

Once deleted, pictures cannot be recovered.

- Pictures that are not in the DCF standard or those that are protected cannot be deleted.

To delete a single picture

- 1 In Playback Mode, select the picture to delete and touch [].

- The same operation can be performed by pressing [ / ].

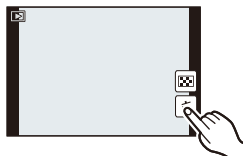

- 2 Touch [Delete Single].

- Confirmation screen is displayed.
Pictures are deleted by selecting [Yes].

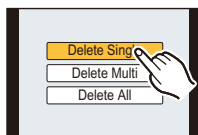

To delete multiple pictures (up to 100*) or all the pictures

- * Burst group will be treated as a single picture. (All the pictures in the selected burst group will be deleted.)

- 1 In Playback Mode, touch [].

- 2 Touch [Delete Multi] or [Delete All].

- [Delete All] → Confirmation screen is displayed.
Pictures are deleted by selecting [Yes].
- It is possible to delete all pictures except the ones set as favorite when [All Delete Except Favorite] is selected with the [Delete All] set.

- 3 (When [Delete Multi] is selected) Touch the picture to be deleted. (repeat this step)

- [] appears on the selected pictures. Touching again cancels the setting.

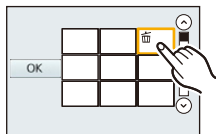

- 4 (When [Delete Multi] is selected) Touch [OK].

- Confirmation screen is displayed.
Pictures are deleted by selecting [Yes].

Note

- Do not turn the camera off while deleting. Use a battery with sufficient battery power or the AC adaptor (optional).
- Depending on the number of pictures to be deleted, it may take some time to delete them.

Setting the Menu

This camera offers menu selections that allow you to customize its operation to maximize your picture taking experience.

In particular, the [Setup] menu contains some important settings relating to the camera's clock and power. Check the settings of this menu before proceeding to use the camera.

Setting menu items

You can set the menus using two types of operation - touch operations in which you touch the screen, and button operations in which you press the cursor button and rotate the rear dial.

- If you set [Menu Resume] (P75) in the [Setup] menu to [ON], the screen shows the last selected menu item when the camera was turned off.

It is set to [ON] at the time of purchase.

Example: In the [Rec] menu, change [Quality] from [4:3] to [16:9]





1 Press [MENU/SET].

- The top menu screen is displayed.



2 Touch the menu icon.



Menu	Description of settings
 [Rec] (P147 to 158)	This menu lets you set the aspect ratio, number of pixels and other aspects of the pictures you are recording.
 [Motion Picture] (P159 to 162)	This menu lets you set the [Rec Mode], [Rec Quality], and other aspects for motion picture recording.
 [Custom Menu] (P163 to 172)	Operation of the unit, such as displaying of the screen and button operations, can be set up according to your preferences. Also, it is possible to register the modified settings.
 [Setup] (P70 to 77)	This menu lets you perform the clock settings, select the operating beep tone settings and set other settings which make it easier for you to operate the camera.
 [Playback] (P175 to 188)	This menu lets you set the Protection, Cropping or Print Settings, etc. of recorded pictures.

(When operating buttons)

Press ▲/▼/◀/▶ of the cursor button to select the menu and press [MENU/SET], or rotate the rear dial to select the menu, and press the rear dial.

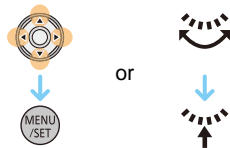
**3 Touch the menu item.**

- The page can be changed by touching [▲]/[▼].

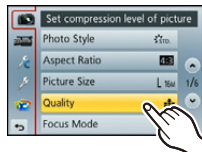
**(When operating buttons)**

Press ▲/▼ of the cursor button to select the menu item and press [MENU/SET], or rotate the rear dial to select the menu item, and press the dial.

- It will switch to the next page when you reach the bottom.
- You can also move to the next screen by sliding the function lever.
- You can also move to the next screen by pressing [DISP.].

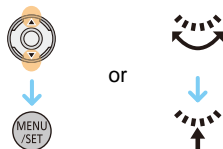
**4 Touch the Setting to set.**

- Depending on the menu item, its setting may not appear or it may be displayed in a different way.

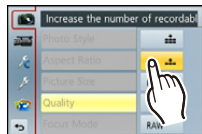
**(When operating buttons)**

Press ▲/▼ of the cursor button to select the setting and press [MENU/SET], or rotate the rear dial to select the setting, and press the dial.

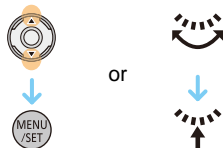

A brief description appears when you touch a menu item/option in steps 3 and 4.

- It will be set when you release your finger.
- You can avoid selecting an item by dragging your finger to a vacant area and releasing the finger there.

Note

- There are functions that cannot be set or used depending on the modes or menu settings being used on the camera due to the specifications.

■ Close the menu

Touch [⏪] or press the shutter button halfway.

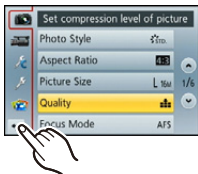

(When operating buttons)

Press [⏪/⏩].

■ Switching to other menus

e.g.: Switching to the [Setup] menu from [Rec] menu.

Touch [⏪] or another of the menu toggle icons (A).

- Select a menu item next and set it.



(When operating buttons)

- 1 Press ◀ of the cursor button.
- 2 Press ▼ of the cursor button or rotate the rear dial to select the [Setup] menu icon [⏪].
- 3 Press ▶ of the cursor button or press the rear dial.

Setting the menu screen background

You can set the background for the menu screen according to your preferences. You can also set one of the recorded still images as the background on the top menu screen.

Setting the top menu screen background

- 1 Press [MENU/SET] to display the top menu.
- 2 Touch [Background Image].



- 3 Touch the item.

[From SD card]	Select a background from the recorded images. The selected image is registered in this unit. (Only 1 image can be registered. If an image has already been registered, it will be overwritten.)
[From internal memory]	Set the default image (1 image) in the camera as the background.
[Registered image]	Set the last image selected from the SD card as the background.
[No static image]	Set a background without an image.

- Touch [From internal memory], [Registered image] or [No static image] to change to the selected background.

- 4 (When [From SD card] is selected) Drag the screen horizontally and select an image.

- 5 (When [From SD card] is selected) Touch [Set].

- Confirmation screen is displayed. It is executed when [Yes] is selected.



Note

- Images recorded using another device cannot be used as the background.

Setting the menu screen background

- 1 Select [Menu Background] on the [Setup] menu. (P64)
- 2 Select and touch background color.
 - You can select the background color from four colors.
 - Exit the menu after it is set.

Setting the Quick Menu

By using the Quick Menu, some of the menu settings can be easily found.

- The features that can be adjusted using Quick Menu are determined by the mode or a display style the camera is in.

1 Press [Q.MENU] to display the Quick Menu.

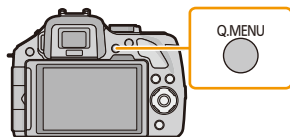

2 Touch the menu item.

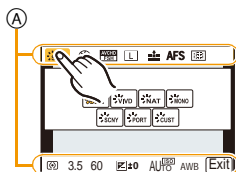

3 Touch the setting.

4 Touch [Exit] to exit menu once the setting is completed.

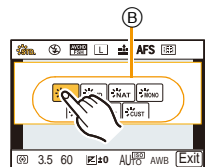

(A) Item

(B) Settings

- You can close the menu by pressing the shutter button halfway.

■ When using the viewfinder

1 Press [Q.MENU] to display the Quick Menu.

2 Rotate the rear dial to select the menu item, then press the rear dial.

- You can set the options for the selected item.

3 Rotate the rear dial to select the setting, then press the rear dial.

- You can select the menu items again.

4 Press [Q.MENU] to exit the menu once the setting is complete.

- You can close the menu by pressing the shutter button halfway.

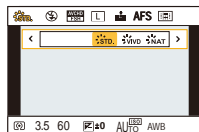

Note

- You can also set items by pressing the cursor buttons ▲/▼/◀/▶.
- You can also select the settings by sliding the function lever.

Change the Quick Menu to your preferred item

When [Q.MENU] (P163) in the [Custom] menu is set to [CUSTOM], the Quick Menu can be changed as desired. Up to 15 items can be set to the Quick Menu.

1 Touch [Q].

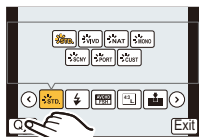

2 Select the menu in the top row and drag it to the bottom row.

- Ⓐ Items that can be set up as Quick Menus.
- Ⓑ Items that can be displayed in the Quick Menu screen.
- If there is no empty space in the bottom row, drag it into the menu item to be replaced.
- New item can be set replacing the old item.
- When the item is dragged from the bottom row to the top row, the setting will be canceled and that space will become empty.
- Menu item or Settings can be switched by touching [◀]/[▶].
- Items that can be set are as follows:

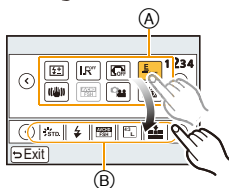

[Rec] menu/Recording functions

- | | |
|---|--|
| <ul style="list-style-type: none"> • [Photo Style] (P147) • [Picture Setting] (P149) • [Quality] (P150) • [Focus Mode] (P36) • [Metering Mode] (P151) • [HDR] (P151) • [i.Dynamic] (P152) • [Flash] (P84) • [Flash Adjust.] (P153) | <ul style="list-style-type: none"> • [i.Resolution] (P154) • [Digital Zoom] (P80) • [Electronic Shutter] (P156) • [Stabilizer] (P78) • [Sensitivity] (P111) • [White Balance] (P106) • [AF Mode] (P95) • [Drive Mode] (Single (P38)/Burst (P89)/Auto bracket (P91)/Self-timer (P93)) |
|---|--|

[Motion Picture] menu

- [Motion Pic. Set] (P159 , 160)
- [Picture Mode] (P55)
- [Ex. Tele Conv.] (still pictures/motion pictures) (P80)

[Custom] menu

- [Function Lever] (P15)
- [Histogram] (P164)
- [Guide Line] (P165)
- [Step Zoom] (P169)
- [Zoom Speed] (P169)
- [Rec Area] (P171)

3 Touch [Exit].

- It will return to screen of above step 1. Touch [Exit] to switch to the recording screen.

About the Setup Menu

For details on how to select the [Setup] menu settings, refer to P64.

[Clock Set] and [Economy] are important items. Check their settings before using them.

[Clock Set]	—
-------------	---

- Refer to P29 for details.

<p>[World Time]</p>	<p>Set the time in your home area and travel destination. You can display the local times at the travel destinations and record them on the pictures you take.</p> <ul style="list-style-type: none"> • Set [Home] first thing after purchasing. [Destination] can be set after setting up [Home]. <p>After selecting [Destination] or [Home], select your area with [◀]/[▶] and touch [Set].</p> <p>✈ [Destination]: Travel destination area</p> <ul style="list-style-type: none"> (A) Current time of the destination area (B) Time difference from home area <p>🏠 [Home]: Your home area</p> <ul style="list-style-type: none"> (C) Current time (D) Time difference from GMT (Greenwich Mean Time)
---------------------	---

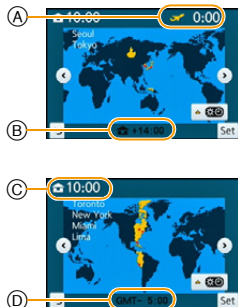

- Touch [▲☀Ⓞ] if you are using Summer Time. (The time will move forward by 1 hour.) Touch again return to standard time.
- If you cannot find the travel destination in the areas displayed on the screen, set by the time difference from the home area.

[Travel Date]	Departure date and return date of the trip as well as the name of the travel destination can be set. You can display the number of days that have passed when playing back the pictures and stamp it on the recorded pictures with [Text Stamp] (P179).	
	[Travel Setup]:	
	<p>[SET]: Departure date and return date are set. Elapsed days (how many days after) of the trip are recorded.</p> <p>[OFF]</p> <ul style="list-style-type: none"> • The travel date is automatically canceled if the current date is after the return date. If the [Travel Setup] is set to [OFF], [Location] will also be set to [OFF]. 	
	[Location]:	
	<p>[SET]: Travel destination is recorded at the time of recording.</p> <p>[OFF]</p> <ul style="list-style-type: none"> • For details on how to enter characters, refer to “Entering Text” on P146. 	





- The number of days that have passed since the departure date can be printed out using the “PHOTOfunSTUDIO” bundled software on the CD-ROM (supplied).
- The travel date is calculated using the date in the clock setting and the departure date you set. If you set [World Time] to the travel destination, the travel date is calculated using the date in the clock setting and the travel destination setting.
- The travel date setting is memorized even if the camera is turned off.
- The [Travel Date] feature is disabled when recording [AVCHD] motion pictures.
- While recording motion pictures, the [Location] feature is disabled.

[Beep]	Set the volume for electronic noises and the electronic shutter noise.	
	<p>[Beep Volume]:</p> <p>[🔊] (High)</p> <p>[🔊] (Low)</p> <p>[🔊] (OFF)</p>	<p>[E-Shutter Vol]:</p> <p>[🔊] (High)</p> <p>[🔊] (Low)</p> <p>[🔊] (OFF)</p>





- The [E-Shutter Vol] only works when [SH] for Burst Mode or [Electronic Shutter] is set to [ON].

[Volume]	Adjust the volume of the speaker to any of the 7 levels.
-----------------	--

- When you connect the camera to a TV, the volume of the TV speakers does not change.

[LCD Display]/ [Viewfinder]	Brightness, color, or red or blue tint of the LCD monitor/viewfinder is adjusted.
	 [Brightness]: Adjust the brightness.
	 [Contrast · Saturation]: Adjust the contrast or clarity of colors.
	 [Red Tint]: Adjust the red tint.  [Blue Tint]: Adjust the blue tint.
	<ol style="list-style-type: none"> 1 Touch the item. 2 Drag the slide bar to adjust. <ul style="list-style-type: none"> • Adjusting can also be performed by rotating the rear dial. 3 Touch [Set].



- It will adjust the LCD monitor when the LCD monitor is in use, and the viewfinder when the viewfinder is in use.
- Some subjects may appear differently from actuality on the LCD monitor. However, this does not affect the recorded pictures.

[LCD Mode]	The brightness of the LCD monitor can be adjusted depending on how bright it is around the camera.
	 [AUTO]: The brightness is adjusted automatically depending on how bright it is around the camera.  [MODE1]: Make the LCD monitor brighter.  [MODE2]: Set the LCD monitor to the standard brightness.  [MODE3]: Make the LCD monitor darker.

- The brightness of the pictures displayed on the LCD monitor is increased so some subjects may appear differently from actuality on the LCD monitor. However, this does not affect the recorded pictures.
- The LCD monitor automatically returns to standard brightness if no operations are performed for 30 seconds when recording in [MODE1]. It will light up brightly again with button or touch operation.
- When [AUTO] or [MODE1] is set, the usage time is reduced.
- [AUTO] is only available in the Recording Mode.
- When the menu screen is displayed in a dark environment etc., the LCD monitor becomes darker even if [LCD Mode] is set to [MODE2].
- The initial setting when using the AC adaptor (optional) is [MODE2].

[Economy]	You can conserve the battery life by setting these menus. Also, it will turn off the LCD monitor automatically when not in use to prevent discharge of the battery.
	[Sleep Mode]: The camera is automatically turned off if the camera has not been used for the time selected on the setting. [10MIN.]/[5MIN.]/[2MIN.]/[1MIN.]/[OFF]
	[Auto LCD Off]: The LCD monitor is automatically turned off if the camera has not been used for the time selected on the setting. [30MIN.]/[5MIN.]/[2MIN.]/[1MIN.]

- Press the shutter button halfway or turn the camera off and on to cancel [Sleep Mode].
- To turn the LCD monitor on again, press any button or touch the LCD monitor.
- Since [Economy] is canceled when the eye sensor auto switching is performed, it is recommended to use this mode with [LVF/LCD Auto] in [Eye Sensor] (P170) set to [OFF].
- [Sleep Mode] does not work in the following cases.
 - When using the AC adaptor (optional)
 - When connecting to a PC or a printer
 - When recording or playing back motion pictures
 - During a slide show

[USB Mode]	Select the USB communication system after or before connecting the camera to your PC or your printer with the USB connection cable (supplied).
	 [Select on connection]: Select either [PC] or [PictBridge(PTP)] if you connected the camera to a PC or a printer supporting PictBridge.  [PictBridge(PTP)]: Set after or before connecting to a printer supporting PictBridge.  [PC]: Set after or before connecting to a PC.

[Output]	<p>This sets how the unit connects to a television etc.</p> <p>[TV Aspect]: Set to match the type of TV.</p> <p>16:9 [16:9]: When connecting to a 16:9 screen TV.</p> <p>4:3 [4:3]: When connecting to a 4:3 screen TV.</p> <ul style="list-style-type: none"> • This will work when the AV cable (optional) is connected.
	<p>[HDMI Mode]: Set the format for the HDMI output when playing back on the HDMI compatible high-definition TV connected with this unit using the HDMI mini cable (optional).</p> <p>[AUTO]: The output resolution is automatically set based on the information from the connected TV.</p> <p>[1080p]: The progressive method with 1080 available scan lines is used for output.</p> <p>[1080i]: The interlace method with 1080 available scan lines is used for output.</p> <p>[480p]: The progressive method with 480 available scan lines is used for output.</p> <ul style="list-style-type: none"> • This will work when the HDMI mini cable (optional) is connected. • If the images are not output on the TV when the setting is [AUTO], match with the image format your TV can display, and select the number of effective scanning lines. (Please read the operating instructions for the TV.)

[VIERA Link]	Settings that allow this unit to be controlled by the remote control of the VIERA equipment by automatically coupling this unit with the VIERA Link compatible equipment using HDMI mini cable (optional).
	<p>[ON]: Remote control operation of the VIERA Link compatible equipment is enabled. (Not all operations are possible) Button operation of the main unit will be limited.</p> <p>[OFF]: Operation is performed with the buttons on this unit.</p>

- This will work when the HDMI mini cable (optional) is connected.
- Refer to [P195](#) for details.

[3D Playback]	Set the output method for 3D pictures.
	<p>[3D]: Set when connecting to a 3D compatible television.</p> <p>[2D]: Set when connecting to a television not compatible with 3D. Set this when you would like to view pictures in 2D (conventional image) on a 3D compatible television.</p>

- This will work when the HDMI mini cable (optional) is connected.
- Refer to [P191](#) for the method to play back 3D pictures in 3D.

[Menu Resume]	Stores the location of the last-used menu item for each menu.
	[ON]/[OFF]

[Rotate Disp.]	This mode allows you to display pictures vertically if they were recorded holding the camera vertically. (P33)
	[ON]/[OFF]

- When you play back pictures on a PC, they cannot be displayed in the rotated direction unless the OS or software is compatible with Exif. Exif is a file format for still pictures which allows recording information etc. to be added. It was established by "JEITA (Japan Electronics and Information Technology Industries Association)".
- It may not be possible to rotate pictures that have been recorded with other equipment.
- The display is not rotated during Multi Playback.

[Menu Background]	Set the background color for the menu screen.
--------------------------	---

- Refer to [P67](#) for details.

[Language]	Set the language displayed on the screen.
-------------------	---

- If you set a different language by mistake, select  from the menu icons to set the desired language.

[Version Disp.]	—
------------------------	---

- This enables the firmware versions of the camera and lens to be checked.
- [–. –] is displayed as the lens firmware when the lens is not mounted.
- Touch [Software info] on the version display screen to display information about the software on the unit.

[No.Reset]	Reset the file number of the next recording to 0001.
-------------------	--

- The folder number is updated and the file number starts from 0001.
- A folder number between 100 and 999 can be assigned.
The folder number should be reset before it reaches 999. We recommend formatting the card ([P77](#)) after saving the data on a PC or elsewhere.
- To reset the folder number to 100, format the card first and then use this function to reset the file number.
A reset screen for the folder number will then appear. Select [Yes] to reset the folder number.

[Reset]	The [Rec] or [Setup]/[Custom] menu settings are reset to the initial settings.
----------------	--

- When the recording setting is reset, the content of the following settings is also reset.
 - The [Face Recog.] setting
 - The [Profile Setup] setting
- When [Setup]/[Custom] menu settings are reset, the following settings are also reset.
 - The [World Time] setting
 - The settings of [Travel Date] (departure date, return date, location)
 - [Registered image] set as the background of the Top Menu screen ([P67](#))
- The folder number and the clock setting are not changed.

[Pixel Refresh]	It will perform optimisation of imaging device and image processing.
------------------------	--

- Imaging device and image processing is optimized when the camera is purchased. Use this function when bright spots that do not exist in the subject get recorded.
- Turn the camera off and on after the pixels are corrected.

[Sensor Cleaning]	Dust reduction to blow off the debris and dust that have affixed to the front of the imaging device is performed.
--------------------------	---

- Dust Reduction Function will operate automatically when the camera is turned on, but you can use this function when you see dust. (P213)

[Format]	<p>The card is formatted.</p> <p>Formatting permanently deletes all data on your memory card. Please be sure all pictures and motion pictures are saved elsewhere before using this feature.</p>
-----------------	---

- Use a battery with sufficient battery power or the AC adaptor (optional) when formatting. Do not turn the camera off during formatting.
- If the card has been formatted on a PC or other equipment, format it on the camera again.
- If the card cannot be formatted, please try another card before contacting your nearest Service Center.

For USA and Puerto Rico assistance, please call:
1-800-211-PANA(7262) or, contact us via the web at:
<http://www.panasonic.com/contactinfo>

For Canadian assistance, please call:
1-800-99-LUMIX (1-800-995-8649) or
send e-mail to: lumixconciierge@ca.panasonic.com

Optical Image stabilizer

Applicable modes:   **P** **A** **S** **M** **C1** **C2**  



Using one of these modes, jitter during picture taking is detected, and the camera automatically compensates the jitter, enabling jitter-free images to be taken.

A lens which supports the stabilizer function is required.

- The interchangeable lens (H-PS14042, H-FS014042, H-FS45150) supports the stabilizer function.

■ Setting the stabilizer in the [Rec] menu

- 1 Select [Stabilizer] in the [Rec] menu. (P64)
- 2 Touch the item.

Item	Settings
 ([Normal])	Vertical and horizontal shake are compensated for.
 ([Panning])	Camera shake is corrected for up/down movements. This mode is ideal for panning (a method of taking pictures which involves turning the camera to track the movements of a subject which continues to move in a fixed direction).
[OFF]	[Stabilizer] does not work. (This can be selected only when using a lens without the [O.I.S.] switch.)

- The [Stabilizer] feature is only available if the lens you are using has an internal stabilizer.
- Exit the menu after it is set.

■ Preventing jitter (camera shake)

When the jitter alert [] appears, use [Stabilizer] (P157), a tripod, the self-timer (P93) or the remote shutter (DMW-RSL1: optional) (P208).

- Shutter speed will be slower particularly in the following cases. Keep the camera still from the moment the shutter button is pressed until the picture appears on the screen. We recommend using a tripod.
 - Slow Sync.
 - Slow Sync./Red-Eye Reduction
 - [Clear Nightscape]/[Cool Night Sky]/[Warm Glowing Nightscape]/[Artistic Nightscape]/[Glittering Illuminations]/[Clear Night Portrait] (Scene Guide Mode)
 - When you set to a slow shutter speed

 **Note**

- When using an optional interchangeable lens with an O.I.S. switch, it is possible to set to enable the Optical Image stabilizer by switching the O.I.S. switch on the lens to [ON]. (At the time of purchase, it is initially set to [OFF].)
- It is recommended to disable the Optical Image stabilizer when using a tripod. [OFF] is displayed on the screen at that time.
- The stabilizer function may not be effective in the following cases. Be careful of camera jitter when you press the shutter button.
 - When there is a lot of jitter.
 - When the zoom magnification is high.
 - When using the Digital Zoom.
 - When taking pictures while following a moving subject.
 - When the shutter speed becomes slower to take pictures indoors or in dark places.
- The panning effect in [OFF] is more difficult to achieve in the following cases.
 - In brightly lit places such as in broad daylight on a summer's day
 - When the shutter speed is faster than 1/100th of a second.
 - When you move the camera too slowly because the subject is moving slowly. (The background will not become a blur.)
 - When the camera does not keep up with the subject satisfactorily
- We recommend taking pictures with the viewfinder when panning in [OFF].

Taking Pictures with the Zoom

Applicable modes:   **P A S M C1 C2 SCN** 

(In **iA**, **AV** and **SCN** modes, you can only use Optical Zoom and Extended Tele Conversion)

You can zoom-out to record landscapes etc. in wide angle (Wide) or zoom-in to make people and objects appear closer (Tele).

The Extended Tele Conversion enables you to take pictures that are further enlarged without deteriorating the picture quality.

■ Types of zooms and recording magnification

Feature	Optical Zoom	Extended Tele Conversion (EX)	Digital Zoom
Recording magnification	Different depending on the lens used.	when taking still pictures: Max. $2\times^{*1}$ when recording motion pictures: $2.4\times^{*2}$	[2×] [4×]
Picture quality	No deterioration	No deterioration	The higher the magnification level, the greater the deterioration.
Conditions	None	when taking still pictures: Set the picture size to [M] or [S] (picture size with [EX]). when recording motion pictures: Set [Ex. Tele Conv.] to [ON].	Set the [Digital Zoom] to [2×] or [4×] in the [Rec]/[Motion Picture] menu.

*1 When a picture size of [S] (4 M), aspect ratio of [**4:3**] is selected.

The magnification level differs depending on [Picture Size] and [Aspect Ratio] setting.

*2 When recording quality setting [PSH], [FSH], [FPH] or [FHD] is selected:

When [SH] or [HD] is selected, Extended Tele Conversion factor will change to $3.6\times$.

When [VGA] is selected, Extended Tele Conversion factor will change to $4.8\times$.

About the zoom operations with interchangeable lens

When using the interchangeable lens (H-PS14042) having a zoom lever
(**Optical Zoom and Extended Tele Conversion for still picture recoding are operable**)

Move to T side:

Enlarges distant subject

Move to W side:

Widens angle of view

- The zoom speed varies depending on how far you move the zoom lever.

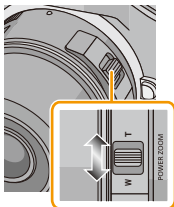

When using the interchangeable lens (H-FS014042, H-FS45150) having a zoom ring
(**Optical Zoom is operable**)

Rotate to T side:

Enlarges distant subject

Rotate to W side:

Widens angle of view

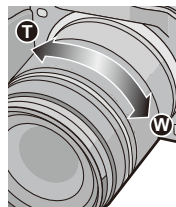

Zoom operations with the function lever of this unit

- To perform zoom operations with the function lever, set [Function Lever] (P163) in the [Custom] menu to [ZOOM].

When using the interchangeable lens (H-PS14042) that supports the power zoom (electrically operated zoom)

(**Optical Zoom and Extended Tele Conversion for still picture recoding are operable**)

When using the interchangeable lens (H-FS014042/H-FS45150) that do not support the power zoom

(**Extended Tele Conversion for still picture recoding is operable**)

Slide to T side: Enlarges distant subject

Slide to W side: Widens angle of view

- Zoom speed varies depending on the swing range of the function lever.

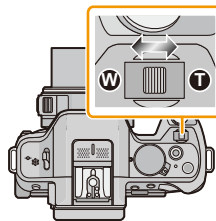

Screen display

- (A) Optical Zoom range (Focal length)*
- (B) Extended Tele Conversion range for still picture recording (Zoom magnification)



* This zoom slider is displayed when using an interchangeable lens (H-PS14042) that supports the power zoom.

- When using an interchangeable lens (H-PS14042) that supports the power zoom, Extended Tele Conversion becomes available after zooming in to the Tele end of the optical zoom.
- The indicated zoom magnification is an approximation.

 **Note**

- When the Extended Tele Conversion is used, angle of view for still pictures will be different from the angle of view for motion pictures because the zoom factor is different between them. Angle of view for recording can be checked beforehand by matching the [Rec Area] (P171) setting to the mode you wish to record in.
- When using the Digital Zoom, we recommend using a tripod and the self-timer (P93) for taking pictures.
- Extended Tele Conversion for still picture and [Digital Zoom] cannot be used in the following cases.
 - When [Quality] is set to [RAW_{4K}], [RAW_{4K}+] or [RAW]
 - When [Burst Rate] is set to [SH]
 - When [HDR] is set to [ON]
- In [Toy Effect] of Creative Control Mode, the Extended Tele Conversion and [Digital Zoom] cannot be used.
- In [Miniature Effect] of Creative Control Mode, the [Digital Zoom] cannot be used.

Zooming using touch operations

You can perform zoom operations by touching. (Touch zoom)

(Optical Zoom and Extended Tele Conversion for still picture recording are operable)

- When using the interchangeable lenses (H-FS014042/H-FS45150) that do not support power zoom, the zoom operation is limited to Extended Tele Conversion for still picture recording.

1 Touch .

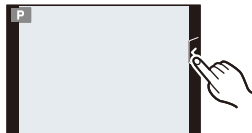

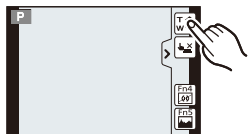

2 Touch .

- The slide bar is displayed.



3 Perform zoom operations by dragging the slide bar.

- The zoom speed varies depending on the touched position.

	Zooms slowly
	Zooms quickly

- Touch  again to end touch zoom operations.

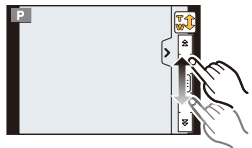

Note

- When [Step Zoom] (P169) is set to [ON], the slide bar for step zoom is displayed.



Taking Pictures using the Built-in Flash

Applicable modes:        

(A) To open the flash
Slide the flash open lever.

(B) To close the flash
Press the flash until it clicks.

- Be sure to close the flash when not in use.
- The flash setting is fixed to  while the flash is closed.

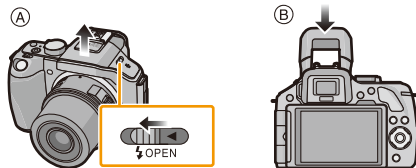

Note

- Be careful not to catch a finger when closing a flash bulb.





Switching to the appropriate flash setting



Applicable modes:        

Set the built-in flash to match the recording.

- Open the flash.

- 1 Select [Flash] in the [Rec] menu. (P64)
- 2 Touch the item.
 - Exit the menu after it is set.

Item	Description of settings
 ((Forced Flash On))	The flash is activated every time regardless of the recording conditions. • Use this when your subject is back-lit or under fluorescent light.
 ((Forced On/ Red-Eye))	
 ((Slow Sync.))	When taking pictures against a dark background landscape, this feature will slow the shutter speed when the flash is activated. Dark background landscape will appear brighter. • Use this when you take pictures of people in front of a dark background.
 ((Slow Sync./ Red-Eye))	• Using a slower speed can cause motion blur. Using a tripod can enhance your photos.
 ((Forced Flash Off))	The flash is not activated in any recording conditions. • Use this when you take pictures in places where the use of flash is not permitted. • Close the flash to turn it off when the built-in flash is used.

The flash is activated twice. The interval between the first and second flash is longer when  or  is set. The subject should not move until the second flash is activated.

■ Available flash settings by Recording Mode

The available flash settings depend on the Recording Mode.

(○: Available, —: Not available, ●: Initial setting of Scene Guide Mode)

Intelligent Auto Mode	—*	—*	—*	—*	○	
Intelligent Auto Plus Mode	—*	—*	—*	—*	○	
P Program AE Mode	○	○	○	○	○	
A Aperture-Priority AE Mode	○	○	○	○	○	
S Shutter-Priority AE Mode	○	○	—	—	○	
M Manual Exposure Mode	○	○	—	—	○	
Creative Control Mode	—	—	—	—	○	
Scene Guide Mode	[Clear Portrait]	○	●	—	—	○
	[Silky Skin]	○	●	—	—	○
	[Backlit Softness]	—	—	—	—	●
	[Clear in Backlight]	●	—	—	—	○
	[Relaxing Tone]	—	—	—	—	●
	[Sweet Child's Face]	○	●	—	—	○
	[Distinct Scenery]	—	—	—	—	●
	[Bright Blue Sky]	—	—	—	—	●
	[Romantic Sunset Glow]	—	—	—	—	●
	[Vivid Sunset Glow]	—	—	—	—	●
	[Glistening Water]	—	—	—	—	●
	[Clear Nightscape]	—	—	—	—	●
	[Cool Night Sky]	—	—	—	—	●
	[Warm Glowing Nightscape]	—	—	—	—	●
	[Artistic Nightscape]	—	—	—	—	●
	[Glittering Illuminations]	—	—	—	—	●
	[Clear Night Portrait]	—	—	—	●	○
	[Soft Image of a Flower]	●	—	—	—	○
	[Appetizing Food]	●	—	—	—	○
	[Cute Dessert]	●	—	—	—	○
[Freeze Animal Motion]	●	—	—	—	○	
[Clear Sports Shot]	●	—	—	—	○	
[Monochrome]	●	○	○	○	○	

* Cannot be set using the [Rec] menu. [A] is set when the flash is opened. (P44)

- The flash setting may change if the Recording Mode is changed. Set the flash setting again if necessary.
- The flash setting is memorized even if the camera is turned off. When changing scene using Scene Guide Mode, the Scene Guide Mode flash setting is returned to the default value with each change of scene.
- Flash will not be activated when recording motion picture.

■ The available flash range

If the distance to the subject is close when taking a picture using a flash, part of the recorded image becomes dark because the light of flash is blocked by the lens or it becomes out of flash range. Check the distance to the subject when taking a picture. The distance at which light from the flash is blocked by lens, and the distance to which light from the flash is delivered vary depending on the lens used.

	When the interchangeable lens (H-PS14042) is used	
	Available flash range	
	Wide	Tele
[AUTO] in [Sensitivity]	30 cm (0.99 feet) to 9.4 m (30.8 feet)	30 cm (0.99 feet) to 5.9 m (19.4 feet)

	When the interchangeable lens (H-FS45150) is used		When the interchangeable lens (H-FS014042) is used	
	Available flash range		Available flash range	
	Wide	Tele	Wide	Tele
[AUTO] in [Sensitivity]	90 cm (2.95 feet) to 8.3 m (27.2 feet)	90 cm (2.95 feet) to 5.9 m (19.4 feet)	50 cm (1.65 feet) to 9.4 m (30.8 feet)	30 cm (0.99 feet) to 5.9 m (19.4 feet)

- The available flash range is an approximation.
- This is the range when [ISO Limit Set] (P154) is set to [OFF].

■ Shutter speed for each flash setting

Flash setting	Shutter speed (Sec.)
	1/60*1 to 1/160th

Flash setting	Shutter speed (Sec.)
	1 to 1/4000th
	60*2 to 1/4000th

*1 This becomes 60 seconds in Shutter-Priority AE Mode and B (Bulb) in the Manual Exposure Mode.

*2 This becomes B (Bulb) in the Manual Exposure Mode.

- When the flash is activated the fastest shutter speed that can be selected is 1/160 of a second.
- In Intelligent Auto (or) Mode, shutter speed changes depending on the identified scene.

Note

- When recording with the flash, white saturation can occur if the subject is too close. If [Highlight] of the [Custom] menu is set to [ON], regions of white saturation will blink black and white when you play back or use Auto Review. In this case, we recommend that you adjust [Flash Adjust.] (P153) in the minus direction and record the pictures again.
- Do not bring the flash too close to objects or close the flash while it is activated. The objects may be discolored by its heat or lighting.
- Do not close the flash soon after the flash is activated prior to taking pictures due to Forced ON/ Red-Eye Reduction etc. It causes a malfunction.
- Recording a subject from too close, or without sufficient flash will not provide the appropriate level of exposure, and may result in a picture that is too white or dark.
- You must wait a moment to take the next picture while the flash icon is blinking RED indicating the flash is charging.
- If recording a subject without sufficient flash, the White Balance may not be properly adjusted.
- **When you use certain lenses, light from the flash may be blocked or fail to cover the lens field of view, causing dark areas to appear in the resulting pictures.**
- When taking pictures with flash with the lens hood attached, the lower portion of the photo may turn dark and the control of the flash may be disabled because the photo flash may be obscured by the lens hood. We recommend detaching the lens hood.
- It may take time to charge the Flash if you repeatedly take pictures. Take a picture after the access indication disappears.
- The Red-Eye Reduction effect differs between people. Also, if the subject was far away from the camera or was not looking at the first flash, the effect may not be evident.
- When you attach an external flash, it takes priority over the built-in flash. Refer to P206 for the external flash.

Compensating the Exposure

Applicable modes:  P A S M  C1 C2 SCN 

Use this function when you cannot achieve appropriate exposure due to the difference in brightness between the subject and the background. Look at the following examples.

- 1 Press the rear dial to switch to Exposure Compensation operation.

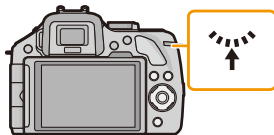

- 2 Rotate the rear dial to compensate the exposure.

- (A) Exposure Compensation value
(B) [Expo.Meter]

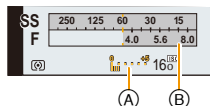

Underexposed		Properly exposed		Overexposed
				
				
Compensate the exposure towards positive.			Compensate the exposure towards negative.	

- The Exposure Compensation value can be set within a range of -5 EV to $+5$ EV. When recording motion pictures, the Exposure Compensation value can be set within a range of -3 EV to $+3$ EV.
- Select [0] to return to the original exposure.
- Rotate the rear dial to display the [Expo.Meter]. (P166)

Note

- To compensate the exposure using the function lever, set [Function Lever] (P163) in the [Custom] menu to [EXP.].
- When the exposure value is out of the -3 EV to $+3$ EV range, the brightness of the recording screen will no longer change. It is recommended to record by checking the actual brightness of the recorded image in the Auto Review or playback screen.
- The set exposure value is memorized even if the camera is turned off.
- The compensation range of the exposure will be limited depending on the brightness of the subject.
- When the aperture and shutter speed values are displayed in the screen in the Program AE Mode, Program Shift operation and Exposure Compensation operation is switched every time the rear dial is pressed.
- In the Aperture-Priority AE Mode, Aperture Setting operation (P117) and Exposure Compensation operation is switched every time the rear dial is pressed.
- In the Shutter-Priority AE Mode, Shutter Speed Setting operation (P118) and Exposure Compensation operation is switched every time the rear dial is pressed.

Taking Pictures using Burst Mode

Applicable modes: **P** **A** **S** **M** **C1** **C2**

Pictures are taken continuously while the shutter button is pressed.

Pictures taken with a burst speed of [SH] will be recorded as a single burst group (P173).

1 Press ▼ ().

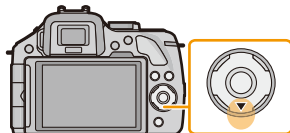

2 Touch burst icon ([H], etc.).

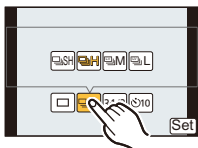

3 Touch the burst speed.

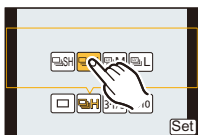

	[SH] (Super high speed)	[H] (High speed)	[M] (Middle speed)	[L] (Low speed)
Burst speed (pictures/second)	20	6	3.7	2
Live View during Burst Mode	None	None	Available	Available
*1	With RAW files	—	g*2, 3	
	Without RAW files	Max. 40	Depends on the capacity of the card*3	

*1 Number of recordable pictures

*2 Depending on the recording conditions, the number of frames in a burst may be reduced. (For example, when [i.Resolution] of the recording menu is set to [EXTENDED], the number of frames in a burst may be reduced)

*3 Pictures can be taken until the capacity of the card becomes full. However the burst speed will become slower halfway. The exact timing of this depends on the aspect ratio, the picture size, the setting for the quality and the type of card used.

• The Burst Mode speed may become slower depending on the following settings.

– [Picture Size] (P149)/[Quality] (P150)/[Sensitivity] (P111)/[Focus Mode] (P36)/[Focus Priority] (P167)

• Burst speed can also be set with [Burst Rate] in the [Rec] menu.

• Refer to P150 for information about RAW files.

4 Touch [Set].

5 Focus on the subject and take a picture.

(A) When Burst Mode is set to high speed [H].

- Hold down the shutter button fully to activate the Burst Mode.

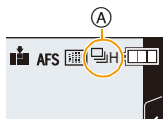

■ Focusing in Burst Mode

The focus changes depending on the setting for [Focus Priority] (P167) in the [Custom] menu and the setting for [Focus Mode] (P36) in the [Rec] menu.

Focus Mode	Focus Priority	Focus
AFS	ON	At the first picture
	OFF	
AFF/AFC*1	ON	Normal focusing*2
	OFF	Predicted focusing*3
MF	—	Focus set with Manual Focus

*1 When the subject is dark or the burst speed is set to [SH], the focus is fixed on the first picture.

*2 The burst speed may become slower because the camera is continuously focusing on the subject.

*3 Burst speed takes priority, and focus is estimated within possible range.

Note

- We recommend using the remote shutter (DMW-RSL1: optional) when you want to keep the shutter button pressed fully while taking pictures in Burst Mode. Refer to P208 for information about the remote shutter.
- When the burst speed is set to [SH] or [H] (when [Focus Mode] is [AFS] or [MF]), the exposure and White Balance are fixed at the settings used for the first picture for the subsequent pictures as well. Depending on the brightness of the subject, the second picture and subsequent pictures may be brighter or darker. When the burst speed is set to [H] (when [Focus Mode] is [AFF] or [AFC]), [M] or [L], they are adjusted each time you take a picture.
- Since the shutter speed becomes slower in dark places, the burst speed (pictures/second) may become slower.
- Depending on the operating conditions, it may take time to take the next picture if you repeat the recording of pictures.
- It may take time to save pictures taken in Burst Mode on the card. If you take pictures continuously while saving, the maximum number of recordable pictures decreases. For continuous shooting, use of a high speed memory card is recommended.
- The Burst Mode is disabled in the following cases.
 - [Glistening Water]/[Glittering Illuminations]/[Soft Image of a Flower] (Scene Guide Mode)
 - [Miniature Effect]/[Soft Focus]/[Star Filter] (Creative Control Mode)
 - When White Balance Bracket is set
 - When recording motion pictures
 - When recording using the flash
 - When [HDR] is set to [ON]

Taking Pictures using Auto Bracket

Applicable modes:   P A S M C1 C2 SCN 

Maximum of 7 pictures will be recorded with different exposure settings following the Exposure Compensation range every time the shutter button is pressed.

With Auto Bracket

[Step]: [3•1/3], [Sequence]: [0/-/+]

1st picture



±0 EV

2nd picture



-1/3 EV

3rd picture



+1/3 EV

1 Press  ( ).

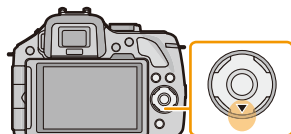

2 Touch Auto Bracket icon (, etc.).

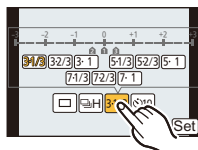

3 Touch the step.

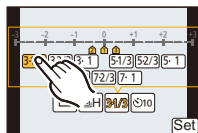

4 Touch [Set].

5 Focus on the subject and take a picture.

Ⓐ Auto Bracket indication

- If you press and hold the shutter button, the number of pictures that you set is taken.
- The Auto Bracket indication blinks until the number of pictures that you set is taken.
- The picture count is reset to [0] if you change the Auto Bracket setting or turn the camera off before all the pictures that you set are taken.

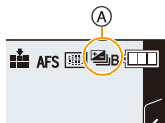

■ Changing the settings for [Single/Burst Settings], [Step] and [Sequence] in Auto Bracket

- 1 Select [Auto Bracket] in the [Rec] menu. (P64)
- 2 Touch [Single/Burst Settings], [Step] or [Sequence].
- 3 Touch the setting.

Item	Settings
[Single/Burst Settings]	[□] (single)
	[□□] (burst)
[Step]	[3•1/3] (3 pictures)
	[3•2/3] (3 pictures)
	[3•1] (3 pictures)
	[5•1/3] (5 pictures)
	[5•2/3] (5 pictures)
	[5•1] (5 pictures)
	[7•1/3] (7 pictures)
	[7•2/3] (7 pictures)
	[7•1] (7 pictures)

Item	Settings
[Sequence]	[0/-/+]
	[-/0/+]

- You can take one picture at a time when set to [□].
- You can continuously take pictures up to set numbers when set to [□□].
- Exit the menu after it is set.

Note

- When taking pictures using Auto Bracket after setting the Exposure Compensation range, the pictures taken are based on the selected Exposure Compensation range.
- The exposure may be compensated incorrectly, depending on the brightness of the subject.
- When taking pictures continuously using Auto Bracket with [i.Resolution] set to [EXTENDED], it may take time to record all the set number of pictures.
- Auto Bracket is disabled in the following cases.
 - [Glistening Water]/[Glittering Illuminations]/[Soft Image of a Flower] (Scene Guide Mode)
 - [Miniature Effect]/[Soft Focus]/[Star Filter] (Creative Control Mode)
 - When White Balance Bracket is set.
 - When recording motion pictures
 - When recording using the flash
 - When [HDR] is set to [ON]

Taking Pictures with the Self-timer

Applicable modes: **P** **A** **S** **M** **C1** **C2** **SCN**

1 Press ().

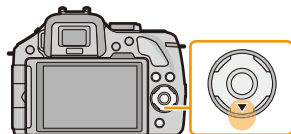

2 Touch self-timer icon (), etc.).

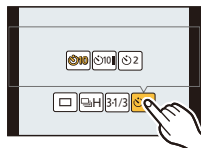

3 Touch the time setting for the self-timer.

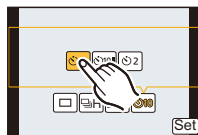

Item	Settings
	Picture is taken 10 seconds after shutter is pressed.
	After 10 seconds the camera takes 3 pictures at about 2 seconds intervals.
	Picture is taken 2 seconds after shutter is pressed. <ul style="list-style-type: none"> When using a tripod, etc., this setting is a convenient way to avoid the jitter caused by pressing the shutter button.

4 Touch **[Set]**.

5 Press the shutter button halfway to focus and then press it fully to take the picture.

(A) When self-timer is set to [10].

- A picture is not taken until the subject is brought into focus. Focus and exposure will be set when the shutter button is pressed halfway.
- If you want to press the shutter button fully to take a picture even when the subject is not focused, set [Focus Priority] in the [Custom] menu to [OFF]. (P167)
- The self-timer indicator (B) blinks and the shutter is activated after 10 seconds (or 2 seconds).
- When [10] is selected, the self-timer indicator blinks again after the first and the second pictures are taken and the shutter is activated 2 seconds after it blinks.

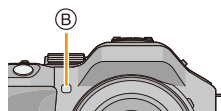
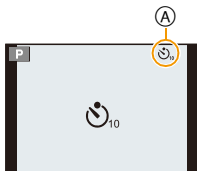

Note

- Time setting for the self timer can also be set by [Self Timer] in the [Rec] menu.
- We recommend using a tripod when recording with the self-timer.
- Depending on the recording conditions, the recording interval may become more than 2 seconds when [10] is selected.
- The flash output may vary slightly when the [10] is selected.
- [10] is disabled when White Balance Bracket is set.
- The self-timer will be disabled during recording of the motion pictures.

Taking Pictures with Auto Focus

Applicable modes:        

This allows the focusing method that suits the positions and number of the subjects to be selected.

Also, it is possible to set the focus to the subject specified on the touch screen.



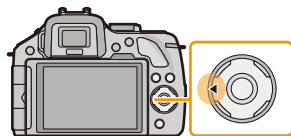

(Set the [Touch AF] of the [Touch Settings] in the [Custom] menu to [ON].)

1 Set the [Focus Mode] to [AFS], [AFF] or [AFC] (P36).

2 Press  .





3 Touch the item.

- AF area selection screen is displayed when  is pressed while , , or  is selected. For operation in the AF area selection screen, refer to [P99](#).



4 Touch [Set].

Note

- It cannot be set to  in the following conditions.
 - [Clear Nightscape]/[Cool Night Sky]/[Warm Glowing Nightscape]/[Artistic Nightscape]/[Glittering Illuminations]/[Appetizing Food]/[Cute Dessert] (Scene Guide Mode)
- The  is disabled in the following cases.
 - [AFF]/[AFC] ([Focus Mode])
- The AF Mode is fixed to  in the following cases.
 - When using the Digital Zoom
 - [Miniature Effect] (Creative Control Mode)

About [👤] ([Face Detection])

The camera automatically detects the person's face. The focus and exposure can then be adjusted to fit that face no matter what portion of the picture it is in. (max. 15 areas)

When the camera detects a person's face, the AF area is displayed.

Yellow:

When the shutter button is pressed halfway, the frame turns green when the camera is focused.

White:

Displayed when more than one face is detected. Other faces that are the same distance away as faces within the yellow AF areas are also focused.



Note

• Position and size of the AF area can be changed. (P99)

- When [👤] is selected and [Metering Mode] is set to multiple [☉], the camera will adjust the exposure to suit the person's face. (P151)
- Under certain picture-taking conditions including the following cases, the Face Detection Function may fail to work, making it impossible to detect faces. The AF Mode is switched to [📷].
 - When the face is not facing the camera
 - When the face is at an angle
 - When the face is extremely bright or dark
 - When there is little contrast on the faces
 - When the facial features are hidden behind sunglasses, etc.
 - When the face appears small on the screen
 - When there is rapid movement
 - When the subject is other than a human being
 - When the camera is shaking

Setting up [AF Tracking] ([AF Tracking])

Focus and exposure can be adjusted to a specified subject. Focus and exposure will keep on following the subject even if it moves. (Dynamic tracking)

■ When operating the touch screen

You can lock the subject by touching it.

- Perform the operation after canceling the touch shutter function.
- The AF area turns yellow while the subject is locked.
- Lock is canceled when [OFF] is touched.



■ When operating buttons

Place the subject in the AF tracking frame, and press the shutter button halfway to lock the subject.

Ⓐ AF tracking frame

- AF area will turn green when the camera detects the subject.
- The AF area turns yellow when the shutter button is released.
- Lock is canceled when [MENU/SET] is pressed.
- Tracking AF and Face Detection will switch every time ◀ is pressed in the Intelligent Auto ([IA] or [AF]) Mode.

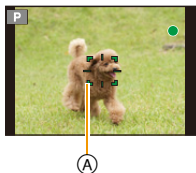

📘 Note

- Exposure is adjusted in accordance with the locked subject when [Metering Mode] is set to [C]. (P151)
- If it fails to lock, AF area will flash in red, and disappear. Try to lock again.
- AF Tracking may be disabled in certain picture conditions such as when it is very dark. AF Mode will be switched to [□] in that case.
- In the following cases, [AF Tracking] operates as [□]
 - [Glistening Water]/[Glittering Illuminations]/[Soft Image of a Flower]/[Monochrome] (Scene Guide Mode)
 - [Sepia]/[Dynamic Monochrome]/[Soft Focus]/[Star Filter] (Creative Control Mode)
 - When [Photo Style] is [Monochrome]
- Dynamic Tracking function may not work in the following cases:
 - When the subject is too small
 - When the recording location is too dark or bright
 - When the subject is moving too fast
 - When the background has the same or similar color to the subject
 - When jitter is occurring
 - When zoom is operated

About [] ([23-Area])

Up to 23 points for each AF area can be focused. This is effective when the subject is not in the center of the screen.

(AF area frame will be same as image aspect ratio setting)

Note

- The 23 AF areas can be divided into 9 areas and the area to be focused can be set. (P99)

About [] ([1-Area])

The camera focuses on the subject in the AF area on the center of the screen.



Note

- **Position and size of the AF area can be changed. (P99)**
- When the subject is not in the center of the composition in [], you can bring the subject into the AF area, fix the focus and exposure by pressing the shutter button halfway, move the camera to the composition you want with the shutter button pressed halfway, and then take the picture. (Only when the [Focus Mode] is set to [AFS].)

About [] ([Pinpoint])

You can achieve a more precise focus on a point that is smaller than [].

Note

- **The focus position can be set on an enlarged screen. (P100)**
- Pressing the shutter button halfway displays the screen for checking the focus position enlarged to approximately 5 times original size.
The time for which the display is enlarged can be set using [Pinpoint AF Time] (P167) in the [Custom] menu.
- The size of the AF area displayed when the camera has achieved focus may change according to the subject.
- In the following cases, [] operates as []
 - When recording motion pictures

Setting up position of the AF area/changing size of the AF area

- Perform the operation after canceling the touch shutter function.

When selecting [AF-ON], [AF-ON]

Position and size of the AF area can be changed.

1 Touch the subject.

- AF area setting screen is displayed.
- AF area setting screen can also be displayed by pressing ◀ and then ▼.
- AF area can also be moved by the cursor button in the AF area setting screen.
- Touch [Reset] to return the AF area to the center of the screen.



2 Drag the slide bar to change the size of AF area frame.

- It can be changed to 4 different sizes.
- Enlarge/reduce can also be performed by rotating the rear dial.

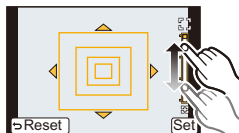

3 Touch [Set].

- It is also possible to set by pressing [MENU/SET].
- AF area with the same function as [AF-ON] is displayed in the touched position, when the [AF-ON] is selected. Setting of the AF area is cleared when [OFF] is touched.

When selecting [23AF]

The 23 AF areas can be divided into 9 areas and the area to be focused can be set.

Touch the screen to display the AF area setting screen, and select the AF area frame as shown in the figure on the right.

- After releasing your finger from the touch screen for a while, AF area frame will disappear, and only [+] display (center point of selected AF area frame) will remain on the screen.
- Setting of the AF area frame is canceled when [OFF] is touched.
- AF area frame can be selected by the cursor button when the AF area setting screen is displayed by pressing ◀ and then ▼. AF area frame is set by pressing [MENU/SET].

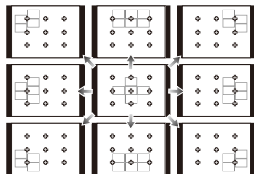

When selecting [⊕]

You can set the focus position precisely by enlarging the screen.

- The focus position cannot be set at the edge of the screen.

1 Touch the subject.

- The assist screen for setting the focus position is enlarged to approximately 5 times original size.
- The assist screen can also be displayed by pressing ◀, pressing ▼ to display the enlarged position setting screen, and then selecting the enlarged position using the cursor buttons and pressing [MENU/SET].

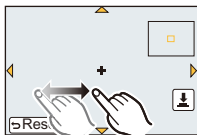

2 Drag the screen to align the subject on the cross point of the crosshair in the center of the screen.

- It is also possible to move the focus position with the cursor button.
- Touching [Reset] will bring the focus position back to the center position.
- On the assist screen, it is also possible to record a picture by touching [📷].

■ Move the AF area easily with [Direct Focus Area] function

When the [Direct Focus Area] in the [Custom] menu is set to [ON] while [👤], [📷] or [📺] is selected, it is possible to move the AF area directly with the cursor button.

With [⊕], you can move the enlarged position.

- To set the items that use the cursor buttons like [Drive Mode], [White Balance], or [Sensitivity], use the Quick Menu (P68) instead.

Note

- The spot metering target can also be moved to match the AF area when the [Metering Mode] (P151) is set to [☐]. At the edge of the screen, the metering may be affected by the brightness around the AF area.
- [Direct Focus Area] is fixed to [OFF] in Creative Control Mode.
- When using digital zoom, the position and size of the AF area cannot be changed.

Taking Pictures with Manual Focus

Applicable modes:   **P A S M C1 C2**  

Use this function when you want to fix the focus or when the distance between the lens and the subject is determined and you do not want to activate Auto Focus.

The operations used to focus manually differ depending on the lens.

When using the interchangeable lens (H-PS14042) having a focus lever

Move to **A** side:

Focuses on nearby subject

Move to **B** side:

Focuses on faraway subject

- The focusing speed varies depending on how far you move the focus lever.

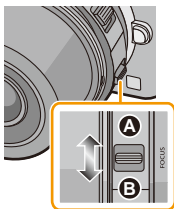

When using the interchangeable lens (H-FS014042, H-FS45150) having a focus ring

Rotate to **C** side:

Focuses on nearby subject

Rotate to **D** side:

Focuses on faraway subject

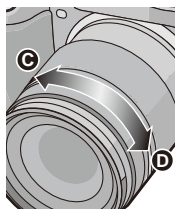

1 Set the [Focus Mode] in the [Rec] menu to [MF]. (P64)

2 Use the focus lever or focus ring on the lens to achieve focus.

- When [MF Assist] on the [Custom] menu is set to [ON] and you focus manually, the display will switch to the assist screen and the image will be enlarged. (MF Assist **A**)
- When [MF Guide] on the [Custom] menu is set to [ON] and you focus manually, the MF guide **B** is displayed on the screen. You can check whether the point of focus is to the near side or the far side.

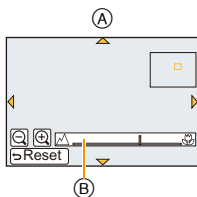



MF ASSIST

■ Displaying the MF Assist

- This is displayed by moving the focus lever, rotating the focus ring, or touching the screen. (In the Creative Control Mode [Miniature Effect], MF Assistance cannot be displayed by touching the screen)
- It can also be displayed by pressing ◀ to display the setup screen for the enlarged area, deciding the area to enlarge using the cursor button, and then pressing [MENU/SET].
- It will switch to the setting screen for the enlarged area by pressing the cursor button when the [Direct Focus Area] in the [Custom] menu is set to [ON].

■ Changing the display of the MF Assist

You can switch the magnification factor between approx. 4 times, 5 times and 10 times. In the case of 4 times magnification, the central region is magnified. In the case of 5 and 10 times magnification, the whole screen is magnified.

- You can change the magnification by touching []/] or rotating the rear dial.

■ Moving the enlarged area

- The enlarged area can be moved by dragging the screen (P13), or pressing the cursor button.
- The following will return the MF assistance to the original position.
 - When the [Focus Mode] is set to other than [MF]
 - Changing [Aspect Ratio] or [Picture Size]
 - Turning the camera off
 - When [Reset] is touched in the setup screen for the enlarged area

■ Closing the MF Assist

- It will close when the shutter button is pressed halfway.
- It will also close by touching the [Exit] on the screen or pressing [MENU/SET].
- When displayed by moving the focus lever or rotating the focus ring, it is closed approximately 10 seconds after operations are stopped.

Note

- The MF Assist is disabled when using the Digital Zoom or recording motion pictures.
- MF Assist or MF guide may not display depending on the lens used, but you can display MF Assist by direct operation of the camera, using the touch screen or a button.

Technique for Manual Focus

- ❶ Focus by moving the focus lever or rotating the focus ring.
- ❷ Move the lever or rotate the ring a little further in the same direction.
- ❸ Fine tune the focus by moving the focus lever slightly in the opposite direction or rotating the focus ring slightly in the opposite direction.

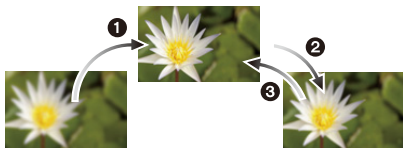

Note

- If you zoom in/out after focusing on a subject, the focus may lose its accuracy. In that case, re-adjust the focus.
- After canceling Sleep Mode, focus on the subject again.
- If you are taking close-up pictures
 - We recommend using a tripod and the self-timer (P93).
 - The effective focus range (depth of field) is significantly narrowed. Therefore, if the distance between the camera and the subject is changed after focusing on the subject, it may become difficult to focus on it again.
 - The resolution of the periphery of the picture may decrease slightly. This is not a malfunction.

About the focus distance reference mark

The focus distance reference mark is a mark used to measure the focus distance.

Use this when taking pictures with Manual Focus or taking close-up pictures.

- Ⓐ Focus distance reference mark
- Ⓑ Focus distance reference line
- Ⓒ 0.2 m (0.66 feet) [When the interchangeable lens (H-PS14042) is used, Wide to focal length 20 mm]
- Ⓓ 0.3 m (0.99 feet) [When the interchangeable lens (H-PS14042) is used, focal length 21 mm to Tele]
- Ⓔ 0.3 m (0.99 feet) [When the interchangeable lens (H-FS014042) is used]
- Ⓕ 0.9 m (2.95 feet) [When the interchangeable lens (H-FS45150) is used]

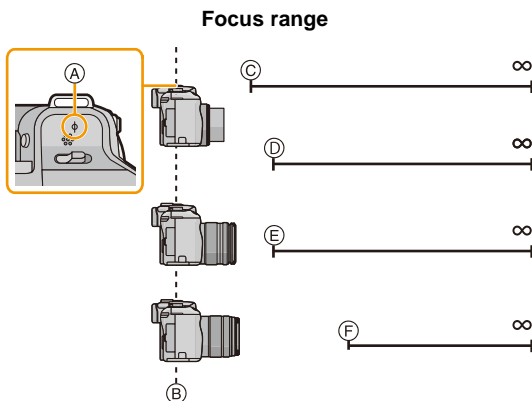

Fixing the Focus and the Exposure (AF/AE Lock)

Applicable modes:  P A S M C1 C2 SCN 

This is useful when you want to take a picture of a subject outside the AF area or the contrast is too strong and you cannot achieve appropriate exposure.

[AF/AE LOCK/Fn1] button can be used in two ways, as [AF/AE LOCK] or as [Fn1] (function 1). At the time of purchase, it is initially set to AF/AE Lock.

- To switch the setting, select using [AF/AE LOCK / Fn1] in [Custom] menu.
- Refer to [P113](#) for details about the function button.

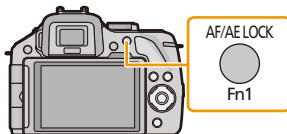

- 1 Align the screen with the subject.**
- 2 Press and hold [AF/AE LOCK] to fix the focus or exposure.**
 - If you release [AF/AE LOCK], AF/AE Lock is canceled.
 - Only the exposure is locked in the default setting.
- 3 While pressing [AF/AE LOCK], move the camera as you compose the picture and then press shutter button fully.**

 AE Lock indication

- When [AE] is set, after pressing the shutter button halfway to focus, press the shutter button fully.

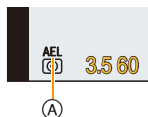

■ AF/AE Lock

Locking of the focus and exposure can be set in [AF/AE Lock] in the [Custom] menu.

Item	Settings
[AE]	Only the exposure is locked. • [AEL], aperture value, the shutter speed light when the exposure is set.
[AF]	Only the focus is locked. • [AFL], the focus indication, aperture value, the shutter speed light when the subject is focused.
[AF/AE]	Both focus and exposure are locked. • [AFL], [AEL], the focus indication, aperture value and the shutter speed light when the subject is focused and the exposure is set.

Note

- If you set [AF/AE Lock Hold] in the [Custom] menu to [ON], you can fix the focus and the exposure even if you release [AF/AE LOCK] after pressing it. (P166)
- When AE lock is performed, the brightness of the recording screen that appears on the screen is fixed.
- AF Lock only is effective when taking pictures in Manual Exposure Mode.
- AE Lock only is effective when taking pictures with Manual Focus.
- AE Lock and AF Lock must be activated before motion picture recording begins.
- During motion picture recording only cancellation of AF Lock can be performed.
- AE Lock is canceled when motion picture recording begins.
- The exposure is set, even if the brightness of the subject changes.
- The subject can be focused again by pressing the shutter button halfway even when AE is locked.
- Program Shift can be set even when AE is locked.

Adjusting the White Balance



Applicable modes:        

In sunlight, under incandescent lights or in other such conditions where the color of white takes on a reddish or bluish tinge, this item adjusts to the color of white which is closest to what is seen by the eye in accordance with the light source.

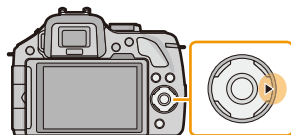
1 Press (WB).











2 Touch the White Balance.

- The item can be switched by touching []/[].



3 Touch [Set].

Item	Recording conditions
[AWB]	Automatic adjustment
[]	When taking pictures outdoors under a clear sky
[]	When taking pictures outdoors under a cloudy sky
[]	When taking pictures outdoors in the shade
[]	When taking pictures under incandescent lights
[ WB]*	When taking pictures with the flash only
[]/[]	The manually set value is used
[ K]	When using the preset color temperature setting

*It will operate as [AWB] during motion picture recording.

Note

- Under fluorescent lighting, LED lighting fixture etc., the appropriate White Balance will vary depending on the lighting type, so use [AWB] or [A1], [A2].
- The White Balance is only calculated for subjects within the range of the camera's flash.
- The set White Balance is maintained even after this unit is turned off, but when the White Balance is changed in a different Scene Guide Mode, [White Balance] for the Scene Guide Mode that was set will return to [AWB].
- In the Scene Guide Modes listed below, White Balance is fixed to [AWB].
 - [Backlit Softness]/[Relaxing Tone]/[Distinct Scenery]/[Bright Blue Sky]/[Romantic Sunset Glow]/[Vivid Sunset Glow]/[Glistening Water]/[Clear Nightscape]/[Cool Night Sky]/[Warm Glowing Nightscape]/[Artistic Nightscape]/[Glittering Illuminations]/[Clear Night Portrait]/[Appetizing Food]/[Cute Dessert]
- When [Direct Focus Area] (P100) is set to [ON], the operations on the cursor buttons translate to movements of the AF area. Set using the Quick Menu (P68).

Auto White Balance

Depending on the conditions prevailing when pictures are taken, the pictures may take on a reddish or bluish tinge. Furthermore, when a multiple number of light sources are being used or there is nothing with a color close to white, Auto White Balance may not function properly. In a case like this, set the White Balance to a mode other than [AWB].

- 1 Auto White Balance will work within this range.
 - 2 Blue sky
 - 3 Cloudy sky (Rain)
 - 4 Shade
 - 5 Sunlight
 - 6 White fluorescent light
 - 7 Incandescent light bulb
 - 8 Sunrise and sunset
 - 9 Candlelight
- K=Kelvin color Temperature

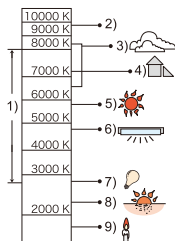

Setting the White Balance manually

Set the White Balance value. Use to match the condition when taking photographs.

- 1 Select [**1**], [**2**] and then touch [White Set].
- 2 Aim the camera at a sheet of white paper etc. so that the frame in the center is filled by the white object only and then touch [Set].

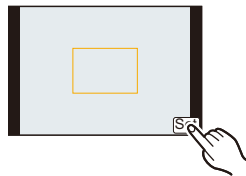

Note

- White Balance may not be set when the subject is too bright or too dark. Set the White Balance again after adjusting to appropriate brightness.

Setting the color temperature

You can set the color temperature manually for taking natural pictures in different lighting conditions. The color of light is measured as a number in degrees Kelvin. As the color temperature increases, the picture becomes more bluish. As the color temperature decreases, the picture becomes more reddish.

- 1 Select [**K**] and then touch [WB K Set].
- 2 Drag the color temperature setting bar.
 - It is also possible to set the values by touching [▲]/[▼] or pressing ▲/▼ of the cursor button.
 - You can set a color temperature from [2500K] to [10000K].
- 3 Touch [Set].

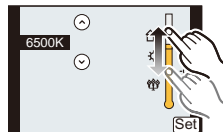

Finely adjusting the White Balance

You can finely adjust the White Balance when you cannot acquire the desired hue by setting the White Balance.

1 Select the White Balance and then touch [Adjust].

2 Drag within the frame to finely adjust.

- You can finely adjust also by touching [G+]/[M-]/[A]/[B], or pressing ▲/▼/◀/▶ of the cursor button.

- ◀ : A (AMBER: ORANGE)
- ▶ : B (BLUE: BLUISH)
- ▲ : G+ (GREEN: GREENISH)
- ▼ : M- (MAGENTA: REDDISH)

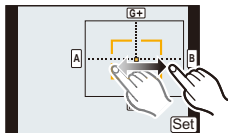

- Select the center point if you are not finely adjusting the White Balance.

3 Touch [Set].

Note

- If you finely adjust the White Balance to [A] (amber), the White Balance icon on the screen will change to orange. If you finely adjust the White Balance to [B] (blue), the White Balance icon on the screen will change to blue.
- If you finely adjust the White Balance to [G+] (green) or [M-] (magenta), [+] (green) or [-] (magenta) appears beside the White Balance icon on the screen.
- The White Balance fine adjustment setting is reflected in the picture when using the flash.
- You can finely adjust the White Balance independently for each White Balance item.
- The White Balance fine adjustment setting is memorized even if the camera is turned off.
- The White Balance fine adjustment level returns to the standard setting (center point) in the following cases.
 - When you reset the White Balance in [] or []
 - When you reset the color temperature manually in []

White Balance Bracket

Bracket setting is performed based on the adjustment values for the White Balance fine adjustment, and 3 pictures with different colors are automatically recorded when the shutter button is pressed once.

- 1 **Finely adjust the White Balance in step 2 of the “Finely adjusting the White Balance” procedure, and touch [◀▶]/[↕] to set the bracket.**

[◀▶]: Horizontal ([A] to [B])

[↕]: Vertical ([G+] to [M-])

- Bracket settings can also be made by rotating the rear dial.

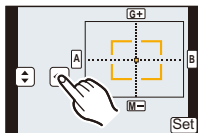

- 2 **Touch [Set].**

Note

- [BKT] is displayed in White Balance icon in the screen when the White Balance Bracket is set.
- The White Balance Bracket setting is released when this unit has been turned off (including Sleep Mode).
- You will only hear the shutter sound once.
- The White Balance Bracket does not work in the following cases:
 - When recording motion pictures
 - When [HDR] is set to [ON]

Setting the Light Sensitivity

Applicable modes:  **P A S M C1 C2**

This allows the sensitivity to light (ISO sensitivity) to be set. Setting to a higher figure enables pictures to be taken even in dark places without the resulting pictures coming out dark.

1 Press ▲ (ISO).

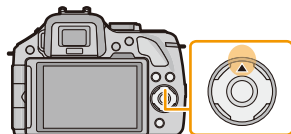

2 Touch the ISO sensitivity.

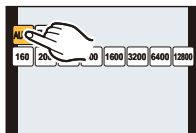

ISO sensitivity	Settings
AUTO	The ISO sensitivity is automatically adjusted according to the brightness. • Maximum [ISO1600]*
 ISO (Intelligent)	The ISO sensitivity is adjusted according to the movement of the subject and the brightness. • Maximum [ISO1600]*
160/200/400/800/1600/3200/6400/12800	The ISO sensitivity is fixed to various settings. (When the [ISO Increments] in [Rec] menu (P154) is set to [1/3 EV], items of ISO sensitivity that can be set will increase.)

* When the [ISO Limit Set] (P154) of [Rec] menu is set to anything except [OFF], it is set automatically within the value set in [ISO Limit Set].

	160  12800	
Recording location (recommended)	When it is light (outdoors)	When it is dark
Shutter speed	Slow	Fast
Noise	Less	Increased
Jitter of the subject	Increased	Less

■ About [iISO] (Intelligent ISO sensitivity control)

The camera detects movement of the subject and then automatically sets the optimum ISO sensitivity and shutter speed to suit the movement of the subject and brightness of the scene to minimize the jitter of the subject.

- The shutter speed is not fixed when the shutter button is pressed halfway. It is continuously changing to match the movement of the subject until the shutter button is pressed fully.



Note

- For the focus range of flash when [AUTO] is set, refer to [P86](#).
- When [Electronic Shutter] is set to [ON], the ISO sensitivity can be set up to [ISO 1600].
- When [Direct Focus Area] ([P100](#)) is set to [ON], the operations on the cursor buttons translate to movements of the AF area. Set using the Quick Menu ([P68](#)).

Using the function button

You can assign recording functions, etc. to specific buttons and icons.

To use those functions, press [Fn1], [Fn2] or [Fn3] or touch [Fn4] or [Fn5].

- To use [Fn1], set the [AF/AE LOCK / Fn1] of the [Custom] menu to [Fn1].
- To use [Fn3], set the [LVF/LCD / Fn3] of the [Custom] menu to [Fn3].

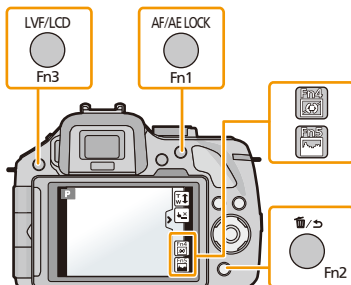

1 Touch [Fn1], [Fn2], [Fn3], [Fn4] or [Fn5] from the [Fn Button Set] in the [Custom] menu.

2 Touch the function you want to assign.

- Assign your favorite functions to each of the function buttons.

[Rec] menu/Recording functions	
<ul style="list-style-type: none"> [One Push AE] (P116) [Preview] (P115) [Level Gauge] (P41) [Focus Area Set] [Photo Style] (P147) [Aspect Ratio] (P149) [Picture Size] (P149) [Quality] (P150) [Focus Mode] (P36) [Metering Mode] (P151) [HDR] (P151) [Flash] (P84) 	<ul style="list-style-type: none"> [Flash Adjust.] (P153) [i.Resolution] (P154) [i.Dynamic] (P152) [Digital Zoom] (P80) [Electronic Shutter] (P156) [Stabilizer] (P78) [Sensitivity] (P111) [White Balance] (P106) [AF Mode] (P95) [Drive Mode] (Single (P38)/Burst (P89)/Auto bracket (P91)/Self-timer (P93)) [Playback] (P56)
[Motion Picture] menu	
<ul style="list-style-type: none"> [Motion Pic. Set] (P159, 160) 	<ul style="list-style-type: none"> [Picture Mode] (P55) [Ex. Tele Conv.] (P80)
[Custom] menu	
<ul style="list-style-type: none"> [Function Lever] (P15) [Histogram] (P164) [Guide Line] (P165) 	<ul style="list-style-type: none"> [Step Zoom] (P169) [Zoom Speed] (P169) [Rec Area] (P171)

- Exit the menu after it is set.

Note

- Some functions cannot be used depending on the mode or displayed screen.
- When [Level Gauge] is enabled, you can turn the tilt sensor display on/off. (P41)
- When set to [Focus Area Set], it is possible to display the position setting screen of either AF area or MF Assist.
- [Playback] can be set to [Fn1] and [Fn3].
- In [Miniature Effect], [One Point Color] of Creative Control Mode, [Fn2] cannot be used.
- [Fn4] and [Fn5] cannot be used when the viewfinder is in use.

Using function buttons with touch operations

[Fn4] and [Fn5] are used by touching function buttons.

1 Touch [Fn4].

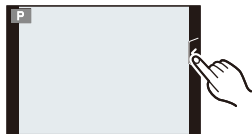

2 Touch [Fn4] or [Fn5].

- The assigned function will operate.

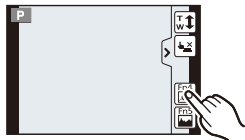

Confirm the Effects of Aperture and Shutter Speed (Preview Mode)

Applicable modes:   **P** **A** **S** **M** **C1** **C2**  

The effects of aperture and shutter speed can be checked by using the Preview Mode.

- **Confirm the effects of aperture:** You can check the depth of field (effective focus range) before taking a picture by closing the leaf shutter to the aperture value you set.
- **Confirm the effects of shutter speed:** Movement can be confirmed by displaying the actual picture that will be taken with that shutter speed. When the shutter speed is set for high speed, display in the shutter speed preview will be displayed like a time-release film. It is used in cases such as stopping the movement of running water.

1 Set [Fn Button Set] in the [Custom] menu to [Preview].

- This is the procedure for setting [Fn2].

2 Switch to confirmation screen by pressing [Fn2].

- Screen is switched every time [Fn2] is pressed.

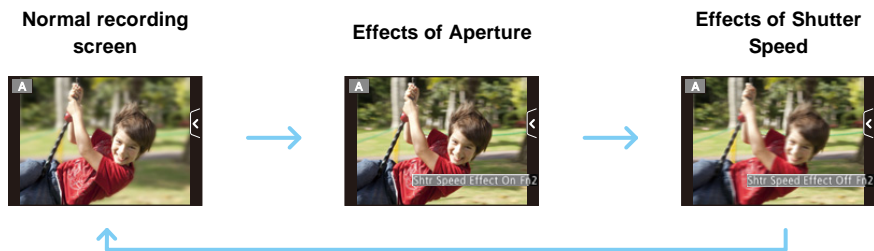

■ Depth of field properties

*1	Aperture value	Small	Large
	Focus length of the lens	Tele	Wide
	Distance to the subject	Near	Distant
Depth of field (effective focus range)		Shallow (Narrow)*2	Deep (Wide)*3

*1 Recording conditions

*2 Example: When you want to take a picture with a blurred background etc.

*3 Example: When you want to take a picture with everything in focus including the background etc.

Note

• It is possible to record while in Preview Mode.



• Range for shutter speed effect check is 8 seconds to 1/1000th of a second.

Easily set aperture/shutter speed for suitable exposure (One Push AE)

Applicable modes:   **P** **A** **S** **M** **C1** **C2**  

When the exposure setting is too bright or too dark, you can use one push AE to achieve a suitable exposure setting.

How to tell if the exposure is not adequate

- If the aperture values and shutter speed blink red (A) when the shutter button is pressed halfway.
- If the Manual Exposure Assistance is anything other than   when in Manual Exposure mode. For more details on Manual Exposure Assistance, refer to [P119](#).

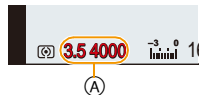

1 Set the [Fn Button Set] of the [Custom] menu to [One Push AE].

- This is the procedure for setting [Fn1].

2 (When exposure is not adequate) Press [Fn1].

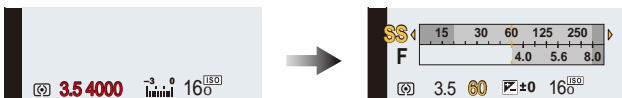

- The exposure meter is displayed, and the aperture and shutter speed are changed to give a suitable exposure. Which items of the settings change will depend on the Recording Mode.

Recording Mode	Settings that change
A	Aperture value
S	Shutter speed
M	Aperture value/Shutter speed

- In the following cases, suitable exposure cannot be set. (Exposure meter is displayed)
 - When the subject is extremely dark and it is not possible to achieve adequate exposure by changing the aperture value or shutter speed
 - When recording using the flash
 - In Preview Mode ([P115](#))
 - When using a lens that includes an aperture ring

Note

- In Program AE Mode, you can cancel program shift by pressing function button.

Taking Pictures by Specifying the Aperture/ Shutter Speed

Recording Mode: **A S M**

Aperture-Priority AE Mode

Set the aperture value to a higher number when you want a sharp focus background. Set the aperture value to a lower number when you want a soft focus background.

- 1 Set the mode dial to **[A]**.
- 2 Rotate the rear dial to set the aperture value.

Aperture value: Reduces
It becomes easier to defocus the background.

Aperture value: Increases
It becomes easier to maintain focus as far as the background.

(A) Aperture value
(B) Exposure meter

- It will switch between aperture setting operation and Exposure Compensation operation every time the rear dial is pressed.
- The effects of the set aperture value will not be visible on the recording screen. To check on the recording screen, please use [Preview]. (P115)

Note

- The brightness of the screen and the recorded pictures may differ. Check the pictures on the playback screen.
- Rotate the rear dial to display the [Expo.Meter]. Unsuitable areas of the range are displayed in red.
- If the exposure is not adequate, the aperture value and the shutter speed turn red and blink when the shutter button is pressed halfway.
- When using a lens having an aperture ring, set the position of the aperture ring to [A] to activate the rear dial setting. At positions other than [A], the ring setting will take priority.

Shutter-Priority AE Mode

When you want to take a sharp picture of a fast moving subject, set with a faster shutter speed. When you want to create a trail effect, set to a slower shutter speed.

- 1 Set the mode dial to [S].
- 2 Rotate the rear dial to set the shutter speed.

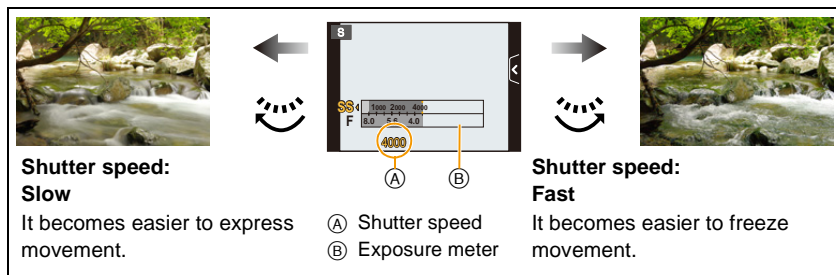

- It will switch between shutter speed setting operation and Exposure Compensation operation every time the rear dial is pressed.
- The effects of the set shutter speed will not be visible on the recording screen. To check on the recording screen, please use [Preview]. (P115)

Note

- The brightness of the screen and the recorded pictures may differ. Check the pictures on the playback screen.
- Rotate the rear dial to display the [Expo.Meter]. Unsuitable areas of the range are displayed in red.
- If the exposure is not adequate, the aperture value and the shutter speed turn red and blink when the shutter button is pressed halfway.
- Display of the shutter speed will count down when the shutter speed is set slow and the shutter button is pressed all the way.
- We recommend using a tripod when the shutter speed is slow.
- When the flash is activated, the fastest shutter speed that can be selected is 1/160th of a second. (P87)
- The shutter speed slower than 1 second is not available when [Electronic Shutter] is set to [ON].
- The [Sensitivity] is automatically set to [AUTO] when you switch the Recording Mode to Shutter-Priority AE Mode while the [Sensitivity] is set to [ISO] (Intelligent).





Manual Exposure Mode

Determine the exposure by manually setting the aperture value and the shutter speed. The Manual Exposure Assistance appears on the lower portion of the screen to indicate the exposure.

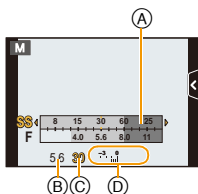
- 1 Set the mode dial to [M].
- 2 Rotate the rear dial to set the aperture and shutter speed.



- (A) Exposure meter
- (B) Aperture value
- (C) Shutter speed
- (D) Manual Exposure Assistance



Aperture value	 <p>Reduces It becomes easier to defocus the background.</p>	 <p>Increases It becomes easier to maintain focus as far as the background.</p>
Shutter speed	 <p>Slow It becomes easier to express movement.</p>	 <p>Fast It becomes easier to freeze movement.</p>

- It will switch between aperture setting operation and shutter speed setting operation every time the rear dial is pressed.
- The effects of the set aperture value and shutter speed will not be visible on the recording screen. To check on the recording screen, please use [Preview]. (P115)

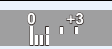
Manual Exposure Assistance

	The exposure is adequate.
	Set to faster shutter speed or larger aperture value.
	Set to slower shutter speed or smaller aperture value.

- The Manual Exposure Assistance is an approximation. We recommend checking the pictures on the playback screen.

About [B] (Bulb)

If you set the shutter speed to [B], the shutter stays open while the shutter button is pressed fully (up to about 120 seconds).

The shutter closes if you release the shutter button.

Use this when you want to keep the shutter open for a long time to take pictures of fireworks, a night scene etc.

- We recommend using a tripod or the remote shutter (DMW-RSL1: optional) when you take pictures with the shutter speed set to [B]. Refer to [P208](#) for information about the remote shutter.
- If you set the shutter speed to [B], [B] is displayed on the screen.
- When you take pictures with the shutter speed set to [B], use a sufficiently charged battery. ([P21](#))
- When you take pictures with the shutter speed set to [B], noise may become visible. To avoid picture noise, we recommend setting [Long Shtr NR] in the [Rec] menu to [ON] before taking pictures. ([P155](#))
- The Manual Exposure Assistance does not appear.
- This cannot be used when [Electronic Shutter] is set to [ON].

Note

- The brightness of the screen and the recorded pictures may differ. Check the pictures on the playback screen.
- Rotate the rear dial to display the [Expo.Meter]. Unsuitable areas of the range are displayed in red.
- If the exposure is not adequate, the aperture value and the shutter speed turn red and blink when the shutter button is pressed halfway.
- Display of the shutter speed will count down when the shutter speed is set to slow and the shutter button is pressed all the way.
- We recommend using a tripod when the shutter speed is slow.
- When the flash is activated, the fastest shutter speed that can be selected is 1/160th of a second. ([P87](#))
- The shutter speed slower than 1 second is not available when [Electronic Shutter] is set to [ON].
- The [Sensitivity] is automatically set to [ISO160] when you switch the Recording Mode to Manual exposure while the [Sensitivity] is set to [AUTO] or [iISO] (Intelligent).
- When you use a lens with an aperture ring, the aperture ring setting takes priority.

Taking Pictures that match the Scene being recorded (Scene Guide Mode)

Recording Mode:

If you select a scene to suit the subject and recording conditions with reference to the example images, the camera will set optimal exposure, color, and focus, allowing you to record in a manner appropriate to the scene.

1 Set the mode dial to .

2 Drag the example images to select a screen.

- You can also select the scene by dragging the slide bar .

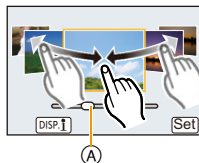

3 Touch .

■ To enjoy a variety of picture effects

Touch  on the scene selection screen to display explanations etc. for picture effects to suit the scene. To take full advantage of the picture effects, we recommend that you read the explanations and try recording pictures.

- The page can be changed by touching /.



Note

- The following items cannot be set in Scene Guide Mode because the camera automatically adjusts them to the optimal setting.
 - Items other than the picture quality adjustment in [Photo Style]/[Sensitivity]/[Metering Mode]/[Digital Zoom]
- Although white balance is fixed to [AWB] for certain types of scene, you can fine tune the white balance or use white balance bracketing by pressing the cursor button  on the recording screen. For further details, please read [P109](#), [110](#).

[Clear Portrait]



The brightness of the face is adjusted and the background is defocused to create a clear portrait.

Note

- If you are using a lens with the zoom function, you can enhance the effect by zooming in as much as possible and closing the distance between the camera and the subject.

[Silky Skin]

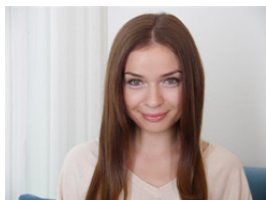

Brighter face and softer skin color creates a healthy younger look.

Note

- If you are using a lens with the zoom function, you can enhance the effect by zooming in as much as possible and closing the distance between the camera and the subject.
- The smoothing effect is applied to the part that has a similar tone to the complexion of a subject, as well.
- This mode may not be effective under insufficient lighting.

[Backlit Softness]



When backlit, the overall screen brightness is increased. Portraits are softened and infused with light.

[Clear in Backlight]

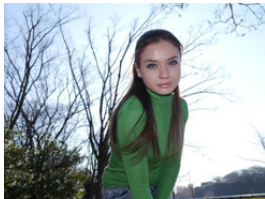

Outdoors, the flash will be used to more evenly illuminate the subject's face.

Note

- **Open the flash.** (You can set to [\downarrow].)
- White saturation can occur if the subject is too close.
- Flash pictures taken closer or beyond the flash's rated distance may appear too bright or too dark.

[Relaxing Tone]



The warm color tone creates an image with a relaxing mood.

[Sweet Child's Face]



Moderate background defocusing and skin tone highlighted draws attention to the child's face.

Touch the face.

- A still picture is recorded with the focus and exposure set for the touched location.

Note

- If you are using a lens with the zoom function, you can enhance the effect by zooming in as much as possible and closing the distance between the camera and the subject.

[Distinct Scenery]

Saturation of sky and trees creates more distinct scenery.

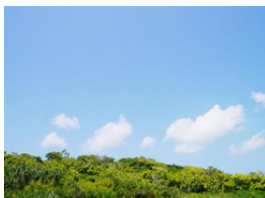
[Bright Blue Sky]

On a sunny day, the overall screen brightness is increased to create a vibrant image of the blue sky.

[Romantic Sunset Glow]

The enhanced purple tone creates a romantic image of the sky just after sunset.

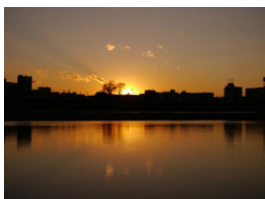
[Vivid Sunset Glow]

Red is enhanced to create a vivid image of the sunset.

[Glistening Water]

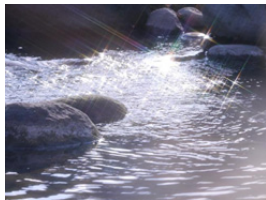

The glisten of the water is enhanced to look brighter and slightly bluish.

Note

- Display of the recording screen will be delayed more than usual and the screen will look as if frames are dropping.
- Star filter used in this mode may cause glistening effects on the objects other than water surface.

[Clear Nightscape]



Color saturation of the night light is increased to accentuate the nightscape.

Note

- We recommend using a tripod and the self-timer.
- The shutter may remain closed after taking the picture. This is due to signal processing and is not a malfunction.
- Noise may become visible when you take pictures in dark places.

[Cool Night Sky]



Blue tones are enhanced to create a cool and sophisticated image of the night sky after sunset.

Note

- We recommend using a tripod and the self-timer.
- The shutter may remain closed after taking the picture. This is due to signal processing and is not a malfunction.
- Noise may become visible when you take pictures in dark places.

[Warm Glowing Nightscape]

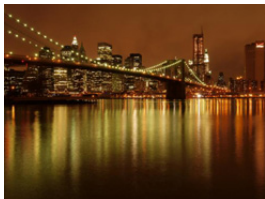

The warm color tone creates a warm image of the nightscape.

Note

- We recommend using a tripod and the self-timer.
- The shutter may remain closed after taking the picture. This is due to signal processing and is not a malfunction.
- Noise may become visible when you take pictures in dark places.

[Artistic Nightscape]



A slow shutter speed captures light trails that can create an artistic nightscape.

Note

- We recommend using a tripod and the self-timer.
- The shutter may remain closed after taking the picture. This is due to signal processing and is not a malfunction.
- Noise may become visible when you take pictures in dark places.

[Glittering Illuminations]



The star filter enhances pinpoints of light.

Note

- We recommend using a tripod and the self-timer.
- Display of the recording screen will be delayed more than usual and the screen will look as if frames are dropping.
- The shutter may remain closed after taking the picture. This is due to signal processing and is not a malfunction.
- Noise may become visible when you take pictures in dark places.

[Clear Night Portrait]



Fill flash and a longer exposure capture better portraits against the nightscape.

Note

- **Open the flash. (You can set to [S].)**
- We recommend using a tripod and the Self-timer for taking pictures.
- When [Clear Night Portrait] is selected, keep the subject still for about 1 second after taking the picture.
- The shutter may remain closed after taking the picture. This is due to signal processing and is not a malfunction.
- Noise may become visible when you take pictures in dark places.

[Soft Image of a Flower]

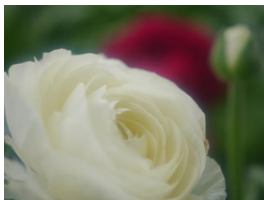

The soft focus creates a diffused image.

Note

- We recommend using a tripod and the self-timer.
- For close-up recording, we recommend that you close the flash and avoid using it.
- Display of the recording screen will be delayed more than usual and the screen will look as if frames are dropping.
- The focus range is different depending on lens used. Refer to “About the focus distance reference mark” on [P103](#) for the focus range.
- When a subject is close to the camera, the effective focus range is significantly narrowed. Therefore, if the distance between the camera and the subject is changed after focusing on the subject, it may become difficult to focus on it again.
- Close-up regions are prioritized when taking pictures, and so time is required to focus if you take a picture of a distant subject.
- When you take pictures at close range, the resolution of the periphery of the picture may decrease slightly. This is not a malfunction.
- If the lens becomes dirty with fingerprints or dust, the lens may not be able to focus on the subject correctly.

[Appetizing Food]



The overall screen brightness is increased to make the food look appealing.

Note

- If you are using a lens with the zoom function, you can enhance the effect by zooming in as much as possible and closing the distance between the camera and the subject.
- We recommend using a tripod and the self-timer.
- For close-up recording, we recommend that you close the flash and avoid using it.

[Cute Dessert]



The overall screen brightness is set higher to enhance the cuteness of the dessert.

Note

- If you are using a lens with the zoom function, you can enhance the effect by zooming in as much as possible and closing the distance between the camera and the subject.
- We recommend using a tripod and the self-timer.
- For close-up recording, we recommend that you close the flash and avoid using it.

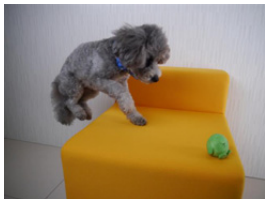
[Freeze Animal Motion]

The faster shutter speed prevents blur and captures a clear image of the fast moving animal.

[Clear Sports Shot]

The faster shutter speed prevents blur, for example at sporting events.

[Monochrome]

A monochrome image captures the mood of the moment.





Taking Pictures with different image effects

(Creative Control Mode)

Recording Mode: 

This mode records with additional image effects. You can set the effects to add by selecting example images and checking them on the screen.

- 1 Set the mode dial to .
- 2 Touch the example image to select image effects (filters).

- The image effect of the selected example image will be applied in a preview display .
- The image effect can be switched by touching .
- Touch  to display the explanation for the selected image effect.
- The explanation can also be displayed by pressing cursor button .

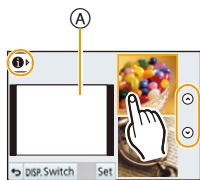

- 3 Touch .

Adjust the effect to fit your preferences.

The strength and colors of the effects can be easily adjusted to fit your preferences.

- 1 Touch .



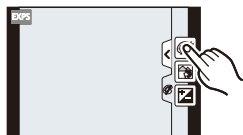

- 2 Touch  to display the setting screen.

- The settings screen can also be displayed from the recording screen by pressing cursor button .



- 3 Drag the slide bar to set.

- Setting can also be performed by rotating the rear dial.
- The items that can be set differ depending on which Creative Control Mode is currently set.
For information on each image effect, refer to "Items that can be set".
- Touch  again to return to the recording screen. Pressing  also takes you back to the recording screen.
- When making the effect setting,  is displayed on the screen.
- If you cannot change the settings, select the center (standard).

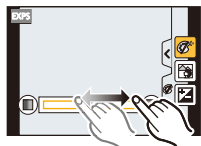

Note

- Touch [Switch] to switch between displaying 2 or 3 example images on the screen for selecting image effects.

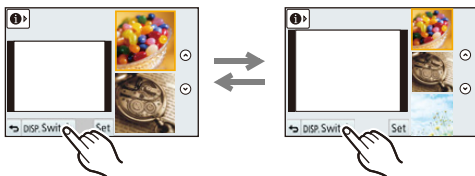

- Creative Control settings are memorized even if the camera is turned off.
- White Balance will be fixed to [AWB], and [Sensitivity] will be fixed to [AUTO].
- In Creative Control Mode, you can adjust brightness.

- 1 Touch [📷].
- 2 Touch [⚙️] to display the setting screen.
- 3 Drag the slide bar to set.

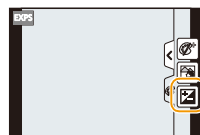

- You can set defocus control by touching [📷] on the recording screen and then touching [📷]. (P48)
- You can also record still pictures by touching [📷] on the recording screen and then touching [📷].

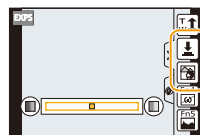

[Expressive]

This effect emphasizes the color to make a pop art picture.

Items that can be set

Freshness	Understated colors	↔	Pop colors
-----------	--------------------	---	------------

[Retro]

This effect gives a faded image.

Items that can be set

Color	Yellow emphasized	↔	Red emphasized
-------	-------------------	---	----------------

[High Key]

This effect adds a bright, airy and soft feel to the overall image.

Items that can be set

Color	Pink emphasized	↔	Aquamarine emphasized
-------	-----------------	---	-----------------------

[Low Key]

This effect adds a dark and relaxing feel to the overall image and enhances bright parts.

Items that can be set

Color	Red emphasized	↔	Blue emphasized
-------	----------------	---	-----------------

[Sepia]

This effect creates a sepia image.

Items that can be set

Contrast	Low contrast	↔	High contrast
----------	--------------	---	---------------

[Dynamic Monochrome]

This effect gives a higher contrast to create an impressive black and white picture.

Items that can be set

Contrast	Low contrast	↔	High contrast
----------	--------------	---	---------------

[Impressive Art]

This effect gives your photo a dramatic contrast look.

Items that can be set

Freshness	Black and white	↔	Pop colors
-----------	-----------------	---	------------

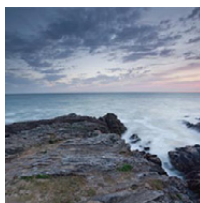
[High Dynamic]

This effect produces the optimum brightness for both dark and bright parts.

Items that can be set

Freshness	Black and white	↔	Pop colors
-----------	-----------------	---	------------

[Cross Process]

This effect gives your photo a dramatic color look.

Items that can be set

Color	Green tone/Blue emphasized/Yellow tone/ Red tone
-------	---

- Touch to select the color balance you wish to generate.

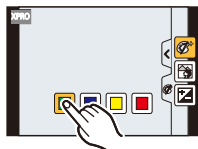
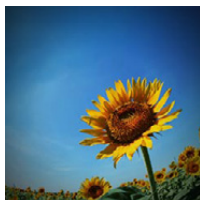
**[Toy Effect]**

This effect reduces peripheral brightness to give the impression of a toy camera.

Items that can be set

Color	Orange emphasized	↔	Blue emphasized
-------	-------------------	---	-----------------

[Miniature Effect]



This effect blurs peripheral areas to give the impression of a diorama.

Items that can be set

Freshness	Understated colors	↔	Pop colors
-----------	--------------------	---	------------

■ Setting the type of defocus

With [Miniature Effect] you can make the subject stand out by intentionally creating defocused and in-focus portions. You can set the recording orientation (defocus orientation) and the position and size of the in-focus portion.

1 Touch [].



2 Touch [] to display the setting screen.

- You can also display the setting screen by touching the screen on the recording screen.
- You can also display the setting screen by pressing [Fn2].

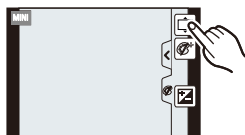

3 Touch [] to set the recording orientation (defocus orientation).

- Ⓐ Setting screen when recording with horizontal orientation
- Ⓑ Setting screen when recording with vertical orientation



4 Touch the in-focus portion.

- It is also possible to move the in-focus portion using the cursor button.

**5 Drag the slide bar to change the size of in-focus portion.**

- It can be changed to 3 different sizes.
- Enlarge/reduce can also be performed by rotating the rear dial.
- If you touch [Reset], settings for the non-blurred portions are restored to the initial settings.

**6 Touch [Set].****Note**

- Display of the recording screen will be delayed more than usual and the screen will look as if frames are dropping.
- No sound is recorded in motion pictures.
- Approximately 1/10 of the time period is recorded. (If you record for 10 minutes, the resulting motion picture recording will be approximately 1 minute long.)
The displayed available recording time is approximately 10 times. When switching to Recording Mode, please check the available recording time.
- When the [Focus Mode] is set to [MF], move the focused location to the in-focus portion.

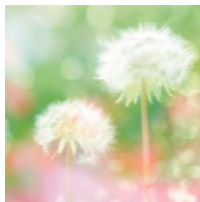
[Soft Focus]

This effect blurs the overall image to produce a soft feel.

Items that can be set

Extent of defocus	Weak defocus	↔	Strong defocus
-------------------	--------------	---	----------------

Note

- Display of the recording screen will be delayed more than usual and the screen will look as if frames are dropping.

[Star Filter]

This effect transforms pin-points of light into a star effect.

Items that can be set

Length of shine	Short	↔	Long
-----------------	-------	---	------

Note

- Display of the recording screen will be delayed more than usual and the screen will look as if frames are dropping.

[One Point Color]

This effect leaves one selected color to emphasize impressiveness.

Items that can be set

Amount of color left	Small amount of color	↔	Large amount of color
----------------------	-----------------------	---	-----------------------

■ Set the color to leave in

Set the color to leave in by selecting a location on the screen.

- 1 Touch [].



- 2 Touch [] to display the setting screen.

- You can also display the setting screen by pressing [Fn2].

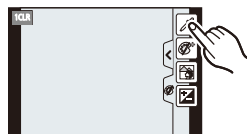

- 3 Touch the part where you want to leave the color.

- Touch [Reset] to return the setting of the color to leave in to the center.



- 4 Touch [Set].

Note

- Depending on the subject, the set color may not be left in.

Taking Pictures in Custom Set

Recording Mode: **C1** **C2**

You can register the current camera settings as custom settings. If you then record in Custom Mode, you can use the registered settings.

- Initial setting of the Program AE Mode is registered as the custom settings initially.

■ Example of registering the settings of the Recording Mode (P) and menus etc. to [C1]:



① Make settings

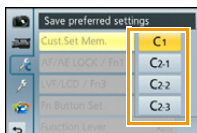

② Register

Refer to P140 for details about steps ①, ②.



③ Switch to Custom Mode



④ Settings registered in Step ② are called up

Refer to P141 for details about steps ③, ④.

Registering Personal Menu Settings (Registering custom settings)

To allow recording using the same settings, up to 4 sets of current camera settings can be registered using [Cust.Set Mem.].

Preparations: Set in advance the Recording Mode you wish to save and select the desired menu settings on the camera.

1 Select [Cust.Set Mem.] in the [Custom] menu. (P64)

2 Touch the custom set to register.

- Confirmation screen is displayed. It is executed when [Yes] is selected.
Exit the menu after it is executed.

Custom set	Description of settings
C1	The settings are registered for C1 on the mode dial. • You can record using by simply rotating the mode dial to the corresponding position. If you register the custom settings you use often, it is then convenient to use them.
C2-1	The settings are registered for C2 on the mode dial. • You can register up to 3 sets of custom settings and use the different sets as condition demand.
C2-2	
C2-3	

Recording using registered custom set

You can easily call up the settings you have registered using [Cust.Set Mem.].

Set the mode dial to [C1].

- The custom set registered for [C1] is called up.

1 Set the mode dial to [C2].

- The custom set registered for [C2-1], [C2-2] or [C2-3] is called up. The most recently used custom set is called up.
- To change a custom set
→ To steps **2** and **3**.

2 Press [MENU/SET] and then touch [Custom Mode].

3 Touch the custom settings.



- Saving of the selected custom settings is displayed on the screen.

(A) Display custom settings



■ When changing the menu settings

Registered contents do not change when the menu setting is changed temporarily with the mode dial set to **C1** or **C2**. To change the registered settings, overwrite the registered content using [Cust.Set Mem.] on the custom settings menu.

Note

- The following menu settings are not registered in the custom set since they are reflected to other Recording modes.

[Rec] menu	[Setup] menu	[Custom] menu
<ul style="list-style-type: none"> • Data registered with [Face Recog.] • The [Profile Setup] setting 	<ul style="list-style-type: none"> • All menus 	<ul style="list-style-type: none"> • [iA Button Switch] • [Touch Scroll] • [Menu Guide]

Taking a Picture with Face Recognition Function

Applicable modes:   **P A S M C1 C2 SCN** 

Face Recognition is a function which finds a face resembling a registered face and prioritizes focus and exposure automatically. Even if the person is located towards the back or on the end of a line in a group photo, the camera can still take a clear picture.

[Face Recog.] is initially set to [OFF] on the camera.

[Face Recog.] will turn [ON] automatically when the face image is registered.

• The following functions will also work with the Face Recognition function.

In Recording Mode

- Display of corresponding name when camera detects a registered face* (if name has been set for the registered face)



In Playback Mode

- Display of name and age (if information has been registered)
- Selective playback of pictures chosen from pictures registered with Face Recognition ([Category Play] (P177))

* Names of up to 3 people are displayed. Precedence for the names displayed when taking pictures is determined according to the order of registration.

Note

- **[Face Recog.] only works when the AF Mode is set to [AF].**
- During the Burst Mode, [Face Recog.] picture information can be attached to only the first picture.
- You cannot use [Face Recog.] in the following cases.
 - [Clear Nightscape]/[Cool Night Sky]/[Warm Glowing Nightscape]/[Artistic Nightscape]/[Glittering Illuminations]/[Appetizing Food]/[Cute Dessert] (Scene Guide Mode)
 - [Miniature Effect] (Creative Control Mode)
 - When recording motion pictures
- Similarity in facial features can result in one person being recognized as another.
- Face Recognition may take more time to select and recognize distinctive facial features than regular Face Detection.
- Even when face recognition information has been registered, pictures taken with [Name] set to [OFF] will not be categorized by face recognition in [Category Play].
- **Even when Face Recognition information is changed (P145), Face Recognition information for the pictures already taken will not be changed.**

For instance, if the name is changed, pictures recorded before the change will not be categorized by face recognition in [Category Play].
- To change the name information of the pictures taken, perform the [REPLACE] in [Face Rec Edit] (P188).

Face Settings

You can register information such as names and birthdays for face images of up to 6 people. Registration can be facilitated by taking multiple face images of each person (up to 3 pictures/registration).

■ Point of recording when registering the face images

- Face front with eyes open and mouth closed, making sure the outline of the face, the eyes, or the eyebrows are not covered with hair when registering.
- Make sure there is no extreme shading on the face when registering. (Flash will not flash during registration.)

(Good example for registering)

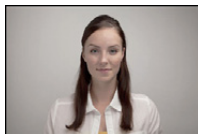

■ When face is not recognized during recording

- Register the face of same person indoors and outdoors, or with different expressions or angles. (P145)
- Additionally register at the location of recording.
- When a person who is registered is not recognized, correct by re-registering.
- Face Recognition may not be possible or may not recognize faces correctly even for registered faces, depending on the facial expression and environment.

1 Select [Face Recog.] on the [Rec] menu. (P64)

2 Touch [MEMORY].

3 Touch [New].

- [New] will not display if there are 6 people already registered. Delete a person already registered to register a new person.

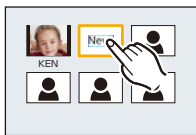

4 Take the picture adjusting the face with the guide.

- Confirmation screen is displayed. It is executed when [Yes] is selected.
- The faces of subjects other than people (pets, etc.) cannot be registered.
- Information for taking face images is displayed when [ⓘ] is touched.



5 Set the item.

- You can register up to 3 face images.

Item	Description of settings
[Name]	It is possible to register names. 1 Touch [SET]. 2 Enter the name. <ul style="list-style-type: none"> For details on how to enter characters, refer to “Entering Text” section on P146.
[Age]	It is possible to register the birthday. 1 Touch [SET]. 2 Set the Year/Month/Day by touching [^]/[v] for each item, and touch [Set].
[Add Images]	To add additional face images. (Add Images) 1 Touch [Add]. 2 Perform steps 4 in “Face Settings”.
	To delete one of the face images. (Delete) Touch the face image to delete. <ul style="list-style-type: none"> This feature requires that at least one facial image remain, once registered. Confirmation screen is displayed. It is executed when [Yes] is selected.

- Exit the menu after it is set.

Change or delete the information for a registered person

You can modify the pictures or information of an already registered person. You can also delete the information of the registered person.

- 1 Select **[Face Recog.]** from the **[Rec]** menu. **(P64)**
- 2 Touch **[MEMORY]**.
- 3 Touch the face image to edit or delete.
- 4 Set the item.

Item	Description of settings
[Info Edit]	Changing the information of an already registered person. Perform step 5 in “Face Settings”.
[Priority]	The focus and exposure are preferentially adjusted for higher-priority faces. Touch the position you wish to change in the order of registration.
[Delete]	Deleting information of a registered person. • Confirmation screen is displayed. It is executed when [Yes] is selected.

- Exit the menu after it is set.



Entering Text

It is possible to enter babies' and pets' names and the names of travel destinations when recording. (Only alphabetical characters and symbols can be entered.)

1 Display the entry screen.

- You can display the entry screen via the following operations.
 - [Name] in [Face Recog.] (P144)
 - [Name] of [Baby1], [Baby2] or [Pet] in [Profile Setup] (P158)
 - [Location] in [Travel Date] (P71)
 - [Title Edit] (P178)

2 Enter characters.

- Touch []/[] will move the position of the text input cursor left and right.

You can also move left and right by rotating the rear dial.

- Touch [] to enter a blank, or [Delete] to delete an entered character.
- A maximum of 30 characters can be entered. (Maximum of 9 characters when setting names in [Face Recog.])
- *A maximum of 15 characters can be entered for [\], [Γ], [J], [•] and [–] (Maximum of 6 characters when setting names in [Face Recog.]).



3 Touch [Set].

Note

- Text can be scrolled if all of the entered text does not fit on the screen.

Using the [Rec] Menu







For details on [Rec] menu settings, refer to P64.

- [Photo Style], [Focus Mode], [Metering Mode], [i.Dynamic], [i.Resolution] and [Digital Zoom] are common to both the [Rec] menu and [Motion Picture] menu. Changing these settings in one of these menus is reflected in other menu.

[Photo Style]



Applicable modes:   P A S M C1 C2  

6 effects can be selected to match the image you wish to record. It is possible to adjust the items such as color or picture quality of the effect to your desire.

Settings	Description of settings
 [Standard]	This is the standard setting.
 [Vivid]*	Brilliant effect with high saturation and contrast.
 [Natural]*	Soft effect with low saturation.
 [Monochrome]	Monochrome effect with no color shades.
 [Scenery]*	An effect appropriate for sceneries with vivid blue skies and greens.
 [Portrait]*	An effect appropriate for portraits with a healthy and beautiful skin tone.
 [Custom]*	Use the setting registered in advance.

* This is disabled when Intelligent Auto ( or ) Mode is selected.

Note

- In Intelligent Auto ( or ) Mode, the setting will be reset to [Standard] when the camera is switched to another Recording Mode or this unit is turned on and off.
- In Scene Guide Mode, a photo style which matches each scene is fixed.

■ Adjusting the picture quality

- Picture quality cannot be adjusted in the Intelligent Auto (IA or IA+) Mode.





1 Touch [◀]/[▶] to select the type of Photo Style.

- In Scene Guide Mode, you cannot select the photo style.

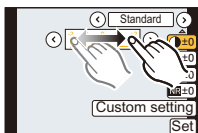
2 Touch the items.

3 Drag the slide bar to adjust.



Item		Effect
 [Contrast]	[+]	Increases the difference between the brightness and the darkness in the picture.
	[-]	Decreases the difference between the brightness and the darkness in the picture.
 [Sharpness]	[+]	The picture is sharply defined.
	[-]	The picture is softly focused.
 [Saturation]	[+]	The colors in the picture become vivid.
	[-]	The colors in the picture become natural.
 [Noise Reduction]	[+]	The noise reduction effect is enhanced. Picture resolution may deteriorate slightly.
	[-]	The noise reduction effect is reduced. You can obtain pictures with higher resolution.

- Registered settings are memorized even if the camera is turned off.
- If you adjust the picture quality, [+] is displayed beside the Photo Style icon on the screen.
- Color can be changed by [Saturation] when [Monochrome] is selected.

4 Touch [Custom setting].

- Confirmation screen is displayed. It is executed when [Yes] is selected.
- Setting can be registered in [Custom].

[Aspect Ratio]

Applicable modes: **P** **A** **S** **M** **C1** **C2**

This allows you to select the aspect ratio of the pictures to suit printing or the playback method.

Settings	Description of settings
[4:3]	[Aspect Ratio] of a 4:3 TV
[3:2]	[Aspect Ratio] of a 35 mm film camera
[16:9]	[Aspect Ratio] of a high-definition TV, etc.
[1:1]	Square aspect ratio

Note

- The ends of the recorded pictures may be cut at printing so check before printing. (P230)

[Picture Size]

Applicable modes: **P** **A** **S** **M** **C1** **C2**

Set the number of pixels. The higher the numbers of pixels, the finer the detail of the pictures will appear even when they are printed onto large sheets.

When the aspect ratio is **[4:3]**.

Settings	Image size
L (16M)	4608×3456
EX M (8M)	3264×2448
EX S (4M)	2336×1752

When the aspect ratio is **[3:2]**.

Settings	Image size
L (14M)	4608×3072
EX M (7M)	3264×2176
EX S (3.5M)	2336×1560

When the aspect ratio is **[16:9]**.

Settings	Image size
L (12M)	4608×2592
EX M (6M)	3264×1840
EX S (2M)	1920×1080

When the aspect ratio is **[1:1]**.

Settings	Image size
L (12M)	3456×3456
EX M (6M)	2448×2448
EX S (3M)	1744×1744

Note

- Extended Tele Conversion does not work in some modes, and **[EX]** is not displayed. Refer to P82 to check the modes that cannot be used with Extended Tele Conversion.
- The picture size will be fixed to **[S]** when **[Burst Rate]** is set to **[SH]**.

[Quality]

Applicable modes:

Set the compression rate at which the pictures are to be stored.

Settings	File format	Description of settings
	JPEG	A JPEG image in which image quality was given priority.
		A standard image quality JPEG image. This is useful for increasing the number of shots without changing the number of pixels.
	RAW+JPEG	You can record a RAW image and a JPEG image (or) simultaneously.*1
	RAW	You can only record RAW images.*2

*1 If you delete a RAW file from the camera, the corresponding JPEG image will also be deleted.

*2 It is fixed to maximum recordable pixels (L) for each image aspect ratio.

Note

- You can enjoy more advanced picture editing if you use RAW files. You can save RAW files in a file format (JPEG, TIFF etc.) that can be displayed on your PC etc., develop them and edit them using the software "SILKYPIX Developer Studio" by Ichikawa Soft Laboratory on the CD-ROM (supplied).
- The following effects are not reflected in RAW images:
 - [Photo Style]/[i.Dynamic]/[Red-Eye Removal]/[i.Resolution]/[Color Space] ([Rec] menu)
 - Scene Guide Mode
 - Creative Control Mode
- [RAW] images are recorded with a smaller data volume than [RAW] or [RAW].
- You cannot set to [RAW], [RAW] or [RAW] in the following cases:
 - When [Burst Rate] is set to [SH]
 - When White Balance Bracket is set
 - When [HDR] is set to [ON]

[Focus Mode]

Settings: [AFS]/[AFF]/[AFC]/[MF]

Note

- Refer to [P36](#) for details.

[Metering Mode]

Applicable modes:   **P A S M C1 C2**  

Type of optical measurement to measure brightness can be changed.

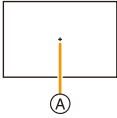
Settings	Description of settings
[☉] (Multiple)	This is the method in which the camera measures the most suitable exposure by judging the allocation of brightness on the whole screen automatically. Usually, we recommend using this method.
[☐] (Center weighted)	This is the method used to focus on the subject on the center of the screen and measure the whole screen evenly.
[•] (Spot)	This is the method to measure the subject in the spot metering target (A) . 

[HDR]

Applicable modes:   **P A S M C1 C2**  

You can combine 3 pictures with different levels of exposure into a single picture with rich gradation. You can minimize the loss of gradations in bright areas and dark areas when, for example, the contrast between the background and the subject is large.

Settings: **[ON]/[OFF]**

■ What Is HDR?

HDR stands for High Dynamic Range and refers to an image combination technique for expressing a wide contrast range.

Note

- Do not move the camera during the continuous shooting after pressing the shutter button.
- You cannot take the next picture until the combination of pictures is complete.
- A moving subject may be recorded with unnatural blurs.
- The angle of view becomes narrow slightly when [HDR] is set to [ON].
- Flash is fixed to  ([Forced Flash Off]).
- [HDR] does not work for the pictures taken during a motion picture recording.

[i.Dynamic] (Intelligent dynamic range control)

Applicable modes:   **P** **A** **S** **M** **C1** **C2**  

Contrast and exposure will be adjusted automatically when there is a big difference in brightness between the background and subject, to bring the image close to how you see.

Settings: [HIGH]/[STANDARD]/[LOW]/[OFF]

Note

- This feature may be automatically disabled, depending on the lighting conditions.
- [HIGH], [STANDARD], or [LOW] represents the maximum range of effect.
- [i.Dynamic] does not work when [HDR] is set to [ON].

[Flash]



Settings: []/[] / [S]/[S^o]

Note

- Refer to [P84](#) for details.



[Red-Eye Removal]

Applicable modes:   **P** **A** **S** **M** **C1** **C2**  

When Red-Eye Reduction ([], [S^o]) is selected, Digital Red-Eye Correction is performed whenever the flash is used. The camera automatically detects red-eye and corrects the picture.

Settings: [ON]/[OFF]



Note

- Only available when [AF Mode] is set to [] and Face Detection is active.
- Under certain circumstances, red-eye cannot be corrected.
- [] is displayed on the icon when it is set to [ON].



[Flash Synchro]

Applicable modes:   **P A S M C1 C2**  

2nd curtain synchro activates the flash just before the shutter closes when taking pictures of moving objects such as cars using a slow shutter speed.

Settings	Description of settings
[1ST]	1st curtain synchro The normal method when taking pictures with the flash. 
[2ND]	2nd curtain synchro The light source appears behind the subject and picture becomes dynamic. 

Note

- Set it to [1ST] for normal use.
- [2nd] is displayed in the flash icon on the screen if you set [Flash Synchro] to [2ND].
- The flash sync. settings are also effective when using an external flash. (P206)
- When a fast shutter speed is set, the effect of [Flash Synchro] may deteriorate.
- You cannot set [] or [] when [Flash Synchro] is set to [2ND].

[Flash Adjust.]

Applicable modes:   **P A S M C1 C2**  

Adjust the flash output if the recorded pictures are too bright or too dark.

Note

- You can adjust from [-2 EV] to [+2 EV] in steps of [1/3 EV].
- Select [0 EV] to return to the original flash output.
- [+] or [-] is displayed on the flash icon in the screen when the flash level is adjusted.

[i.Resolution]

Applicable modes:   **P A S M C1 C2**  

Pictures with sharp profile and resolution can be taken by using the Intelligent Resolution Technology.

Settings: **[HIGH]/[STANDARD]/[LOW]/[EXTENDED]/[OFF]**

Note

- [EXTENDED] allows you to take natural pictures with a higher resolution.
- The speed of burst and continuous recording becomes slower when [EXTENDED] is used.
- When recording a motion picture, [EXTENDED] changes to [LOW].

[ISO Limit Set]

Applicable modes:   **P A S M C1 C2**  

It will select optimal ISO sensitivity with set value as limit depending on the brightness of the subject.

Settings: **[200]/[400]/[800]/[1600]/[3200]/[OFF]**

Note

- It will work when the [Sensitivity] is set to [AUTO] or .
- [ISO Limit Set] is disabled in the following cases:
 - [Clear Nightscape]/[Cool Night Sky]/[Warm Glowing Nightscape] (Scene Guide Mode)
 - When recording motion pictures

[ISO Increments]

Applicable modes:   **P A S M C1 C2**  

You can adjust the ISO sensitivity settings for every 1/3 EV.

Settings	
[1/3 EV]	[160]/[200]/[250]/[320]/[400]/[500]/[640]/[800]/[1000]/[1250]/[1600]/[2000]/[2500]/[3200]/[4000]/[5000]/[6400]/[8000]/[10000]/[12800]
[1 EV]	[160]/[200]/[400]/[800]/[1600]/[3200]/[6400]/[12800]

Note

- When the setting is changed from [1/3 EV] to [1 EV], [Sensitivity] will be set to value closest to the value set during the [1/3 EV]. (Set value will not restore when the setting is changed back to [1/3 EV]. It will stay as the setting selected for [1 EV].)

[Long Shtr NR]

Applicable modes:   **P** **A** **S** **M** **C1** **C2**  

The camera automatically removes noise that appears when the shutter speed becomes slower to take pictures of night scenery etc. so you can take beautiful pictures.

Settings: [ON]/[OFF]

Note

- If you set [ON], the countdown screen is displayed when the shutter button is pressed. Do not move the camera at this time. After the countdown is finished, [Please wait...] is displayed for the same time as the selected shutter speed for signal processing.
- We recommend using a tripod when the shutter speed is slowed to take pictures.
- In the following cases, [Long Shtr NR] does not work:
 - When recording motion pictures
 - When [Burst Rate] is set to [SH]
 - When [Electronic Shutter] is set to [ON]

[Shading Comp.]

Applicable modes:   **P** **A** **S** **M** **C1** **C2**  

When the screen periphery darkens as a result of the lens characteristics, you can record pictures with the brightness of the screen periphery corrected.

Settings: [ON]/[OFF]

Note

- This feature may be automatically disabled, depending on the recording conditions.
- Noise in the periphery of the picture may stand out with higher ISO sensitivity.
- Correction is not possible in the following cases:
 - When recording motion pictures
 - Recording still pictures while recording a motion picture [only when set to  (motion picture priorities)].
 - When [Burst Rate] is set to [SH].
- Depending on the lens used, [Shading Comp.] may not operate. Refer to the website for compatible lenses.

[Digital Zoom]

Settings: [4×]/[2×]/[OFF]

Note

- Refer to P80 for details.

[Electronic Shutter]

Applicable modes:   P A S M C1 C2  

The electronic shutter can reduce the picture blur. Moreover, you can take pictures without the shutter sound when the camera is used in a quiet location.

Settings: [ON]/[OFF]

Note

- Flash is fixed to  ([Forced Flash Off]).
- If a subject is moving or your hands are shaking, the subject may appear distorted on the picture taken. Use of a tripod is recommended.
- [Electronic Shutter] is disabled when [Burst Rate] is set to [SH].
- You can turn off the shutter sound at [E-Shutter Vol] in [Beep]. (P71)
- Be sure to pay special attention to the privacy, the likeness rights, etc. of the subject when you use this function. Use at your own risk.

[Burst Rate]

Settings: [SH]/[H]/[M]/[L]

Note

- Refer to P89 for details.

[Auto Bracket]

Settings: [Single/Burst Settings]/[Step]/[Sequence]

Note

- Refer to P91 for details.

[Self Timer]

Settings:   

Note

- Refer to P93 for details.

[Color Space]

Applicable modes:         

Set this when you want to correct the color reproduction of the recorded pictures on a PC, printer etc.

Settings	Description of settings
[sRGB]	Color space is set to sRGB color space. This is widely used in computer related equipment.
[AdobeRGB]	Color space is set to AdobeRGB color space. AdobeRGB is mainly used for business purposes such as professional printing because it has a greater range of reproducible colors than sRGB.

Note

- Depending on the color space setting, the file name of the recorded picture changes as shown.

P1000001.JPG

└─ P: sRGB
└─ _: AdobeRGB

- Set to sRGB if you are not very familiar with AdobeRGB.
- The setting is fixed to [sRGB] when recording motion pictures.

[Stabilizer]

Settings:  /  / [OFF]

Note

- Refer to [P78](#) for details.

[Face Recog.]

- Refer to [P142](#) for details.

[Profile Setup]

Applicable modes:   **P A S M C1 C2**  

If you set the name and birthday of your baby or pet in advance, you can record their name and age in months and years in the images.



You can display these at playback or stamp the recorded images using [Text Stamp] (P179).

Settings: [] ([Baby1])/[] ([Baby2])/[] ([Pet])/[OFF]/[SET]

■ Setting [Age] or [Name]

- 1 Touch [SET].
- 2 Touch [Baby1], [Baby2] or [Pet].
- 3 Touch [Age] or [Name].
- 4 Touch [SET].

Enter [Age]

For each item, touch []/[], set the year/month/day of the birthday, and touch [Set].

Enter [Name]

For details on how to enter characters, refer to “Entering Text” on P146.

- 5 Touch [Exit].



■ To cancel [Age] and [Name]



Select the [OFF] setting in step 1.

Note

- Still pictures recorded during motion picture recording ([] (motion picture priorities)) (P55) will not record age or name.
- The age and name can be printed out using the “PHOTOfunSTUDIO” bundled software on the CD-ROM (supplied).

[Recommended Filter]

Applicable modes:   **P A S M C1 C2**  

This sets whether to display the camera-recommended effects (filters) in Intelligent Auto ( or  Mode.

Settings: [ON]/[OFF]

Using the [Motion Picture] Menu

For details on [Motion Picture] menu settings, refer to P64.

- [Photo Style], [Focus Mode], [Metering Mode], [i.Dynamic], [i.Resolution] and [Digital Zoom] are common to both the [Rec] menu and [Motion Picture] menu. Changing these settings in one of these menus is reflected in other menu.
 - For details, refer to the explanation for the corresponding setting in the [Rec] menu.
- [Motion Picture] menu is not displayed in the following cases.
 - [Glistening Water]/[Glittering Illuminations]/[Soft Image of a Flower] (Scene Guide Mode)
 - [Soft Focus]/[Star Filter] (Creative Control Mode)

[Rec Mode]

Applicable modes:          

This sets up the data format of motion pictures.

Settings	Description of settings
[AVCHD]	Select this format to record HD (high definition) video for playback on your HDTV using an HDMI connection.
[MP4]	Select this format to record standard definition video for playback on your PC.

[Rec Quality]

Applicable modes:         

This sets up the picture quality of motion pictures.

When [AVCHD] is selected

Settings	Picture size/Bit rate	fps	Aspect ratio
[PSH]	1920×1080 pixels/Approx. 28 Mbps	60p	16:9
[FSH]	1920×1080 pixels/Approx. 17 Mbps	60i	
[FPH]	1920×1080 pixels/Approx. 17 Mbps	30p	
[SH]	1280×720 pixels/Approx. 17 Mbps	60p	

When [MP4] is selected

Settings	Picture size/Bit rate	fps	Aspect ratio
[FHD]	1920×1080 pixels/Approx. 20 Mbps	30	16:9
[HD]	1280×720 pixels/Approx. 10 Mbps		4:3
[VGA]	640×480 pixels/Approx. 4 Mbps		

 Note

- What is bit rate

This is the volume of data for a definite period of time, and the quality becomes higher when the number gets bigger. This unit is using the “VBR” recording method. “VBR” is an abbreviation for “Variable Bit Rate”, and the bit rate (volume of data for definite period of time) is changed automatically depending on the subject to record. Therefore, the recording time is shortened when a subject with fast movement is recorded.

[Picture Mode]

Settings: [] (Motion picture priorities)/[] (Still picture priorities)

Note

- Refer to [P55](#) for details.

[Continuous AF]

Settings: [ON]/[OFF]

Note

- Refer to [P52](#) for details.

[Ex. Tele Conv.]

Settings: [ON]/[OFF]

Note

- Refer to [P80](#) for details.

[Wind Cut]

Applicable modes:          

This prevents the recording of wind-noise automatically.

Settings: [AUTO]/[OFF]

Note

- Sound quality may be different than usual when [Wind Cut] is set.
- Not available with [Miniature Effect] in Creative Control Mode.

[Mic Level Disp.]**Applicable modes:**   **P** **A** **S** **M** **C1** **C2**  

Set whether or not the mic levels are displayed on the screen.

Settings: [ON]/[OFF]

-  **Note**
- Not available with [Miniature Effect] in Creative Control Mode.

[Mic Level Adj.]**Applicable modes:**   **P** **A** **S** **M** **C1** **C2**  

Adjust the sound input level to 4 different levels.

-  **Note**
- Not available with [Miniature Effect] in Creative Control Mode.

[Flkr Decrease]**Applicable modes:**   **P** **A** **S** **M** **C1** **C2**  

The shutter speed can be fixed to reduce the flicker or striping in the motion picture.

Settings: [1/50]/[1/60]/[1/100]/[1/120]/[OFF]

Using the [Custom] Menu

For details on how to select the [Custom] menu settings, refer to [P64](#).

[Cust.Set Mem.]	[C 1]/[C 2-1]/[C 2-2]/[C 2-3]
-----------------	-------------------------------

• Refer to [P139](#) for details.

[AF/AE LOCK / Fn1]	—
--------------------	---

• Refer to [P104](#) for details.

[LVF/LCD / Fn3]	—
-----------------	---

• Refer to [P34](#) for details.

[Fn Button Set]	—
-----------------	---

• Refer to [P113](#) for details.

[Function Lever]	[AUTO]/[ZOOM]/[EXP.]
------------------	----------------------



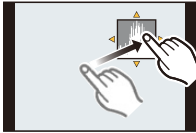
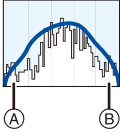

• Refer to [P15](#) for details.

[Q.MENU]	Switch the setting method of Quick Menu.
	<p>[PRESET]: The Quick Menu will consist of the items that are displayed as icons on the recording screen.</p> <p>[CUSTOM]: The Quick Menu will consist of desired items (P69)</p>

[Histogram]	This allows you to set either to display or not display the histogram.
	<p>[ON]: Position can be set by dragging the histogram.</p> <ul style="list-style-type: none"> • Direct touch operation is also possible from the recording screen.  <p>[OFF]</p> <p>A histogram is a graph that displays brightness along the horizontal axis (black to white) and the number of pixels at each brightness level on the vertical axis. It allows you to easily check a picture's exposure.</p> <p>(A) dark (B) bright</p> 

• **When the recorded picture and the histogram do not match each other under the following conditions, the histogram is displayed in orange.**

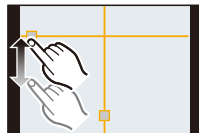

- When the Manual Exposure Assistance is other than $[\pm 0]$ during Exposure Compensation or in the Manual Exposure Mode
- When the flash is activated
- When suitable exposure is not achieved with the flash closed
- When the brightness of the screen is not correctly displayed in dark places
- The histogram is an approximation in the Recording Mode.
- The histogram displayed in this camera does not match histograms displayed by picture editing software used in PCs etc.

[Guide Line]	This will set the pattern of guide lines displayed when taking a picture.
	<p>[]/[]</p> <p>[]: Position can be set by dragging the [] on the guide line.</p> <ul style="list-style-type: none"> • When it is difficult to move the guide line on the screen edge by touch operation, use the cursor button to set the position. • Direct touch operation is also possible from the recording screen.
	[OFF]



- When you align the subject on the horizontal and vertical guidelines or the cross point of these lines, you can take pictures with well-designed composition by viewing the size, the slope and the balance of the subject.

[Auto Review]	Set the length of time that the picture is displayed after taking the still picture.
	<p>[HOLD]:</p> <p>The pictures are displayed until shutter button is pressed halfway.</p> <p>[5SEC]/[3SEC]/[1SEC]/[OFF]</p>

- If it is set to [HOLD] when the camera is set to [] or [], switching of the playback screen display or enlargement by rotating the rear dial is possible during Auto Review.
- Regardless of the Auto Review setting, pictures will automatically be reviewed when taking burst pictures with [SH] or [H] set, and recording with Auto Bracket. (Will not hold)
- [Auto Review] is disabled when Burst Mode is set to [M] or [L].

[Highlight]	When the Auto Review function is activated or when playing back, white saturated areas appear blinking in black and white. This does not affect the recorded image.
	[ON]/[OFF]

- If there are any white saturated areas, we recommend compensating the exposure towards negative (P88) referring to the histogram (P164) and then taking the picture again. It may result in a better quality picture.
- This does not work while in Multi Playback, Calendar Playback, or Playback Zoom.

[ON]**[OFF]**

[Expo.Meter]	Set whether or not to display the exposure meter.
	[ON]/[OFF]

- Set to [ON] to display the [Expo.Meter] when correcting exposure, performing Program Shift, setting aperture, and setting shutter speed.
- Unsuitable areas of the range are displayed in red.
- When [Expo.Meter] is not displayed, switch the display information for screen by pressing [DISP.]. (P40)
- The [Expo.Meter] disappears after approximately 4 seconds if no operation is performed.

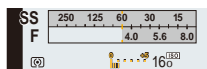

[AF/AE Lock]	[AE]/[AF]/[AF/AE]
---------------------	--------------------------

- Refer to P105 for details.

[AF/AE Lock Hold]	This will set the operation of [AF/AE LOCK] button when taking a picture with fixed focus or exposure.
	[ON]: The focus and the exposure remain fixed even if you release [AF/AE LOCK] after pressing it. If you press [AF/AE LOCK] again, AF/AE Lock is canceled.
	[OFF]: The focus and the exposure are fixed only while you are pressing [AF/AE LOCK]. (P104) If you release [AF/AE LOCK], AF/AE Lock is canceled.

[Quick AF]	As long as the camera is held steady, the camera will automatically adjust the focus and focus adjustment will then be quicker when the shutter is pressed. This is useful when you do not want to miss a picture-taking opportunity.
	[ON]/[OFF]

- The battery will be consumed faster than usual.
- Press the shutter button halfway again when it is difficult to focus on the subject.
- The [Quick AF] feature is disabled in the following conditions:
 - In Preview Mode
 - In low light situations
 - With lenses that only offer Manual Focus
 - With some Four Third lenses that do not support contrast AF

[Eye Sensor AF]	[ON]/[OFF]
------------------------	-------------------

- Refer to [P35](#) for details.

[Direct Focus Area]	[ON]/[OFF]
----------------------------	-------------------

- Refer to [P100](#), [102](#) for details.

[Focus Priority]	It will set so no picture can be taken when it is out of focus.
	[ON]: You cannot take a picture until the subject is brought into focus.
	[OFF]: This gives priority to the best time to take a picture so you can take a picture when the shutter button is pressed fully.

- When set to [OFF], please be aware that focus may not be achieved even with [Focus Mode] set to [AFS], [AFF] or [AFC].
- [Focus Priority] is disabled during motion picture recording.

[Shutter AF]	Set whether or not the focus is adjusted automatically when the shutter button is pressed halfway.
	[ON]/[OFF]

[Pinpoint AF Time]	Sets the time for which the screen is enlarged when the shutter button is pressed halfway with Auto Focus Mode set to [\oplus].
	[LONG] (Approx. 1.5 seconds)/[MID] (Approx. 1.0 seconds)/[SHORT] (Approx. 0.5 seconds)

[AF Assist Lamp]	AF assist lamp will illuminate the subject when the shutter button is pressed halfway, making it easier for the camera to focus when recording in low light conditions. (Larger AF area is displayed depending on the recording conditions.)
	[ON]/[OFF]

- The effective range of the AF Assist Lamp is different depending on the lens used.
 - When the interchangeable lens (H-PS14042, H-FS014042, H-FS45150) is attached and at Wide: Approx. 1.0 m (3.29 feet) to 3.0 m (9.85 feet)
- The AF Assist Lamp is valid only for the subject in the center of the screen. Use it by positioning the subject in the center of the screen.
- Remove the lens hood.
- When you do not want to use the AF Assist Lamp (e.g. when taking pictures of animals in dark places), set the [AF Assist Lamp] to [OFF]. In this case, it will become more difficult to focus on the subject.
- The AF Assist Lamp gets slightly blocked when the interchangeable lens (H-PS14042, H-FS014042, H-FS45150) is used, but it does not affect the performance.
- The AF Assist Lamp may be greatly blocked, and it may become harder to focus when a lens with large diameter is used.
- The setting for the [AF Assist Lamp] is fixed to [OFF] in the following cases.
 - [Distinct Scenery]/[Bright Blue Sky]/[Romantic Sunset Glow]/[Vivid Sunset Glow]/[Glistening Water]/[Clear Nightscape]/[Cool Night Sky]/[Warm Glowing Nightscape]/[Artistic Nightscape] (Scene Guide Mode)

[AF+MF]	It is possible to adjust focus manually after it was adjusted automatically.
	[ON]: When AF Lock is ON (press the shutter button halfway with the [Focus Mode] set to [AFS] or set AF Lock using [AF/AE Lock]), you can make fine adjustments to the focus manually.
	[OFF]



[MF Assist]	[ON]/[OFF]
--------------------	-------------------

- Refer to [P101](#) for details.

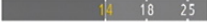

[MF Guide]	[ON]/[OFF]
-------------------	-------------------

- Refer to [P101](#) for details.

[Power Zoom Lens]	<p>This may only be selected when using a lens that is compatible with power zoom (electrically operated zoom).</p> <ul style="list-style-type: none"> – The interchangeable lens (H-PS14042) is compatible with power zoom. – The interchangeable lenses (H-FS014042, H-FS45150) are not compatible with power zoom. <p>(For compatible lenses, please refer to our website.)</p>
	<p>[Disp Focal Length]: When you zoom, the focal distance is displayed and you can confirm the zoom position.</p> <p>[e.g.: When the interchangeable lens (H-PS14042) is used]</p> <p>[A] Current focal distance</p> <p>[ON]/[OFF]</p> 
	<p>[Step Zoom]: When you operate the zoom with this setting [ON], the zoom will stop at positions corresponding to predetermined distances.</p> <ul style="list-style-type: none"> • [Step Zoom] is disabled during motion picture recording. <p>[e.g.: When the interchangeable lens (H-PS14042) is used]</p> <p>[ON]/[OFF]</p> 
	<p>[Zoom Resume]: When you turn this unit on, the zoom positions when you last turned this unit off are automatically restored.</p> <p>[ON]/[OFF]</p>
	<p>[Zoom Speed]: You can set the zoom speed for zoom operations.</p> <ul style="list-style-type: none"> • If you set [Step Zoom] to [ON], the zoom speed will not change. <p>[Photo]: [H] (High speed), [M] (Middle speed), [L] (Low speed)</p> <p>[Video]: [H] (High speed), [M] (Middle speed), [L] (Low speed)</p>
	<p>[Zoom Ring]: This may only be selected when a power zoom-compatible lens with a zoom lever and zoom ring is attached. When set to [OFF], the operations controlled by the zoom ring are disabled to prevent accidental operation.</p> <p>[ON]/[OFF]</p>

[LVF Disp.Style]	This will set the display style of the viewfinder.
	[]: Viewfinder style []: LCD monitor style









- Refer to [P40](#) for details.

[LCD Disp.Style]	This will set the display style of the LCD monitor.
	[]: Viewfinder style []: LCD monitor style



- Refer to [P40](#) for details.

[Eye Sensor]	It will switch automatically to viewfinder display when an eye or object gets near the viewfinder using an eye sensor. It will return to LCD monitor display when it goes away.
	[Sensitivity]: This will set the sensitivity of the eye sensor. [HIGH]/[LOW]
	[LVF/LCD Auto]: Enables/disables the eye sensor. [ON]/[OFF]



- LCD monitor display and viewfinder display can be switched manually by pressing [LVF/LCD]. ([P34](#))

[iA Button Switch]	It is possible to set how the [] button to toggle to Intelligent Auto ( or ) Mode will operate.
	[Single Press]: It will switch to Intelligent Auto ( or ) Mode by pressing [].
	[Press and hold]: It will switch to Intelligent Auto ( or ) Mode by pressing [] for a while.

[Video Button]	Enables/disables the motion picture button.
	[ON]/[OFF]

[Rec Area]	This changes the angle of view during motion picture recording and still picture recording.
	 (Picture)/  (Motion picture)

- The recording area indicated is a guide line.

[Remaining Disp.]	This will switch display between the number of recordable pictures and available recording time.
	<p> ([Remaining Shots]): This will display the number of recordable pictures for still pictures.</p> <p> ([Remaining Time]): This will display the available recording time for motion pictures.</p>



[Touch Settings]	Enables/disables the Touch operation. When set to [OFF], no corresponding touch tab or touch icon is displayed on the screen.
	<p>[Touch Screen]: All touch operations. When set to [OFF], only button and dial operations can be used. [ON]/[OFF]</p>
	<p>[Touch Tab]: Operation to display the touch icons by touching tabs such as  displayed on the right of the screen. [ON]/[OFF]</p>
	<p>[Touch AF]: Operation to focus on the touched subject. [ON]/[OFF]</p>
	<p>[Touch Pad AF]: Using the LCD monitor as a touch pad when the viewfinder is in use. [ON]/[OFF]</p>

[Touch Scroll]	This allows you to set the speed of continuously forwarding or rewinding pictures using touch operation.
	[H]: High speed [L]: Low speed

[Dial Guide]	Set whether or not to display the dial operation guide.
	[ON]/[OFF]

- When it is set to [ON], pressing the rear dial displays a dial operation guide on a screen that allows changes to operations.



[Menu Guide]	Set the screen that is displayed when the mode dial is set to  and  .
	[ON]: Displays the selection screen for the Scene Guide or the Creative Control Mode. [OFF]: Displays the recording screen of the Scene Guide or the Creative Control Mode.

[Shoot w/o Lens]	Sets whether or not the shutter can be released when no lens is attached to the main body.
	[ON]: Shutter will operate regardless of the lens on the unit. [OFF]: You cannot press the shutter button when a lens is not attached to the camera body or is not attached correctly.

- When using a Leica lens mount adaptor (DMW-MA2M, DMW-MA3R: optional), set it to [ON].

Playing Back Burst Pictures

About the Burst Picture Group

The pictures taken continuously with burst speed set to [SH] are recorded together as a burst group with the burst icon [📷].

Ⓐ Burst icon

- Deleting and editing in a group unit is possible. (For example, if you delete a Burst Picture Group with [📷], all the pictures in that group are deleted.)

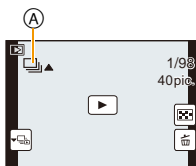

Note

- Burst pictures recorded after the number of pictures has exceeded 50000 will not be grouped.
- Burst pictures recorded on other cameras may not be recognized as a Burst Picture Group.
- Burst pictures will not be grouped if recorded without setting the clock.

Continuously playing back burst pictures

Select a picture with a burst icon [📷], and then touch [▶] to play back.

- Pressing the cursor button ▲ to allows you to play back burst pictures. Display at the right of the screen while playing back corresponds to ▲/▼/◀/▶ on the cursor button.

Operations during Burst Picture Group playback

	Continuous playback/Pause		Stop
	Fast rewind		Fast forward
	Rewind (while pausing)		Forward (while pausing)

Playing back each burst picture

1 Select a picture with a burst icon [📷], and then touch [📷].

- The same operation can be performed by pressing ▼ of the cursor buttons.

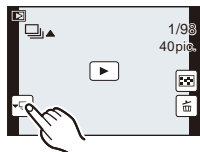

2 Drag horizontally to transfer between images.

- You can also transfer between images by pressing ◀/▶.
- Touch [▶] or press ▼ again to return to the normal playback screen.
- The same playback controls used for normal pictures can be used for pictures within the burst picture group. (Such as Multi Playback, Playback Zoom and deleting images)

Editing Burst Pictures

You can edit the pictures in the Burst Picture Group as single pictures or in group units (including all pictures in group).

• The following editing menu can be used.

– [Title Edit] (P178), [Text Stamp] (P179), [Cropping]*¹ (P183), [Favorite] (P185), [Print Set] (P186), [Protect] (P188), [Face Rec Edit]*² (P188)

*1 Cannot be used for the entire burst picture group.

*2 Cannot be used for single pictures within a burst picture group.

Editing in burst picture group units (All pictures in the burst picture group)

- 1 Press [MENU/SET] during playback to display the [Playback] menu. (P64)
- 2 Touch the menu item.
- 3 Touch [Single] or [Multi].
- 4 Select an image with burst icon [📁], and perform editing.

Editing single pictures within a burst picture group

- 1 Select a picture with a burst icon [📁], and then touch [📁].

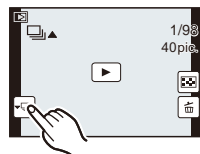

- 2 Press [MENU/SET] to display the [Playback] menu.
- 3 Touch the menu item.
- 4 Touch [Single] or [Multi].
- 5 Select the picture, and perform editing.

Note

- By setting [Favorite], [Print Set], or [Protect] setting to a picture in the Burst Picture Group, number of settings (number of settings and total number when [Print Set] is set) is displayed on the icon for the first picture of each group.
- Pictures for which you have performed [Text Stamp] or [Cropping] will be saved separately from burst pictures.

Using the [Playback] Menu

For details on [Playback] menu settings, refer to [P64](#).

With this menu, you can use various playback functions such as cropping and other editing of recorded images, protect settings, etc.

- With [Text Stamp], [Resize] or [Cropping], a new edited picture is created. A new picture cannot be created if there is no free space on the card so we recommend checking that there is free space before editing the picture.

[2D/3D Settings]

Playback methods for the 3D pictures can be switched.

- This is a menu that is only displayed when 3D display is possible. Refer to [P191](#) for details.

[Slide Show]

You can play back the pictures you have taken in synchronisation with music, and you can do this in sequence while leaving a fixed interval between each of the pictures.

You can also put together a slide show composed of only still pictures, only motion pictures, only 3D pictures etc.

We recommend this feature when you view your pictures by connecting the camera to a TV.

1 Select [Slide Show] on the [Playback] menu. (P64)

2 Touch the group to play back.

- Refer to [P191](#) for the method to play back [3D] pictures in 3D.
- In [Category Selection], touch the category you wish to play back.
For details on categories, refer to [P177](#).

3 Touch [Start].

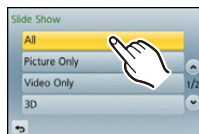

■ Operations performed during slide show

	Play/Pause		Exit slide show
	Back to previous picture (while pausing/playing back motion pictures/playing back burst picture group)		Ahead to next picture (while pausing/playing back motion pictures/playing back burst picture group)
	Reduce volume level		Increase volume level

- Normal playback resumes after the slide show finishes.
- Display at the right of the screen while playing back corresponds to ▲/▼/◀/▶ on the cursor button.
- You can also adjust the volume by rotating the rear dial.

■ Changing the slide show settings

You can change the settings for slide show playback by selecting [Effect] or [Setup] on the slide show menu screen.

[Effect]

This allows you to select the screen effects when switching from one picture to the next.

[AUTO], [NATURAL], [SLOW], [SWING], [URBAN], [OFF]

- When [URBAN] has been selected, the picture may appear in black and white as a screen effect.
- [AUTO] can be used only when [Category Selection] has been selected. The pictures are played back with the recommended effects in each category.
- [Effect] is fixed to [OFF] when in [Video Only] or during the slide show for [] in [Category Selection].
- Even if [Effect] is set, it does not work during a slide show of Burst Picture Group.
- While viewing pictures in Portrait Mode (vertical) some selections in the [Effect] feature are disabled.

[Setup]

[Duration] or [Repeat] can be set.

Item	Settings
[Duration]	[1SEC]/[2SEC]/[3SEC]/[5SEC]
[Repeat]	[ON]/[OFF]
[Sound]	<p>[AUTO]: Music is played when the still pictures are played back, and audio is played when the motion pictures are played back.</p> <p>[Music]: Music is played back.</p> <p>[Audio]: Audio (only for motion pictures) is played back.</p> <p>[OFF]: There will be no sound.</p>

- [Duration] can be set only when [OFF] has been selected as the [Effect] setting.
- Even if [Duration] is set, it does not work during a slide show of motion pictures only or slide show of Burst Picture Group.

[Playback Mode]

Playback in [Normal Play], [Picture Only], [Video Only], [3D Play], [Category Play] or [Favorite Play] can be selected.

1 Select [Playback Mode] on the [Playback] menu. (P64)









2 Touch the group to play back.

- Refer to P191 for the method to play back [3D Play] pictures in 3D.

When [Category Play] is selected in above step 2

3 Touch the category to play back.

- Pictures are sorted into the categories shown below.

	Recording information e.g. Scene Detection or Scene Guide Modes
	• [Face Recog.]*
	• [i-Portrait], [i-Night Portrait], [i-Baby] in Scene Detection • [Clear Portrait]/[Silky Skin]/[Backlit Softness]/[Clear in Backlight]/[Relaxing Tone]/[Sweet Child's Face]/[Clear Night Portrait] (Scene Guide Mode)
	• [i-Scenery], [i-Sunset] in Scene Detection • [Distinct Scenery]/[Bright Blue Sky]/[Romantic Sunset Glow]/[Vivid Sunset Glow]/[Glistening Water] (Scene Guide Mode)
	• [i-Night Portrait], [i-Night Scenery] in Scene Detection • [Clear Nightscape]/[Cool Night Sky]/[Warm Glowing Nightscape]/[Artistic Nightscape]/[Glittering Illuminations]/[Clear Night Portrait] (Scene Guide Mode)
	• [Clear Sports Shot] (Scene Guide Mode)
	• [Appetizing Food]/[Cute Dessert] (Scene Guide Mode)
	• [Travel Date]
	Still pictures recorded continuously with burst speed set to [SH]

*Play back by selecting and touching the picture of the person you desire to play back. The whole group with pictures taken with the burst speed [SH] will be treated as face recognition pictures.

- Categorisation of the motion pictures differ from the still pictures depending on the Recording Mode. Some motion pictures may not be played back.

4 Touch [Set].

[Title Edit]

You can add text (comments) to pictures. After text has been registered, it can be stamped in prints using [Text Stamp] (P179).

1 Select [Title Edit] on the [Playback] menu. (P64)

2 Touch [Single] or [Multi].

3 Select an image to add text.

- [✔] is displayed for pictures with titles already registered.

[Single] setting

- 1 Drag the screen horizontally and select an image.
- 2 Touch [Set].

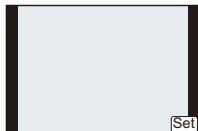

[Multi] setting

- 1 Touch a picture (repeat).
 - Selection will be canceled by touching the same picture again.
- 2 Touch [OK].

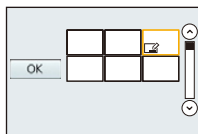

4 Enter the text. (P146)

- Exit the menu after it is set.

Note

- To delete the title, erase all the text in the text input screen.
- You can print out texts (comments) using the "PHOTOfunSTUDIO" bundled software on the CD-ROM (supplied).
- You can set up to 100 pictures at one time with [Multi].
- You cannot use [Title Edit] for the following pictures.
 - Motion pictures
 - Pictures taken with [RAW.m], [RAW.m] or [RAW]
 - Pictures recorded with other equipment

[Text Stamp]

You can stamp the recording date/time, name, location, travel date or title onto the recorded pictures.

1 Select [Text Stamp] on the [Playback] menu. (P64)

2 Touch [Single] or [Multi].

3 Select an image you wish to stamp with text.

- [☑] appears on screen if the picture is stamped with text.

[Single] setting

- 1 Drag the screen horizontally and select an image.
- 2 Touch [Set].

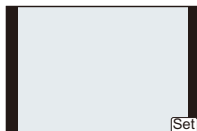

[Multi] setting

- 1 Touch a picture (repeat).
 - Selection will be canceled by touching the same picture again.
- 2 Touch [OK].

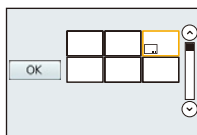

4 Touch [Set].

5 Select the item to stamp.

Item	Description of settings
[Shooting Date]	<p>[W/O TIME]: Stamp the year, month and date.</p> <p>[WITH TIME]: Stamp the year, month, day, hour and minutes.</p> <p>[OFF]</p>
[Name]	<p>[👤]: Name registered in [Face Recog.] will be stamped. ([Face Recognition])</p> <p>[👶/🐾]: Name registered in [Profile Setup] will be stamped. ([Baby/Pet])</p> <p>[OFF]</p>
[Location]	<p>[ON]: Stamps the travel destination name set under [Location].</p> <p>[OFF]</p>
[Travel Date]	<p>[ON]: Stamps the travel date set under [Travel Date].</p> <p>[OFF]</p>
[Title]	<p>[ON]: Title input in the [Title Edit] will be stamped.</p> <p>[OFF]</p>

6 Touch [].

7 Touch [OK].

- Confirmation screen is displayed. It is executed when [Yes] is selected.
Exit the menu after it is executed.

 **Note**

- When you print pictures stamped with text, the date will be printed over the stamped text if you specify printing of the date at the photo shop or on the printer.
- You can set up to 100 pictures at one time in [Multi].
- The picture quality may deteriorate when text stamping is carried out.
- Depending on the printer being used, some characters may be cut at printing. Check before printing.
- You cannot use [Text Stamp] for the following pictures.
 - Motion pictures
 - Pictures recorded without setting the clock and title
 - Pictures that were previously stamped with [Text Stamp]
 - Pictures taken with [RAW⁺], [RAW⁺..] or [RAW]
 - Pictures recorded with other equipment

[Video Divide]

Recorded motion picture can be divided in two. It is recommended for when you want to divide a part you need with a part you do not need.

Dividing a motion picture is permanent. Decide before you divide!

- 1 Select [Video Divide] on the [Playback] menu. (P64)**
- 2 Drag the screen horizontally to select a motion picture to divide, and touch [Set].**
- 3 Touch [▶/||] at the location to divide.**
 - Motion picture is played back from the same location when [▶/||] is touched again.
 - Make fine adjustments to the division position by touching [◀/||]/[||/▶] while the motion picture is paused.
 - Display at the right of the screen corresponds to ▲/▼/◀/▶ on the cursor button.
- 4 Touch [⏏].**
 - Confirmation screen is displayed. It is executed when [Yes] is selected. Exit the menu after it is executed.
 - Motion picture may be lost if the card or battery is removed while processing the dividing.

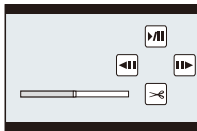

Note

- The [Video Divide] feature only works on motion pictures recorded on this camera.
- Avoid trying to divide motion picture near the very beginning or end of the motion picture.
- With [MP4] motion pictures, the order of pictures will change if divided.
It is recommended to search these motion pictures by using Calendar Playback (P58) or [Video Only] in the [Playback Mode].
- You cannot use [Video Divide] for the following pictures.
 - Motion pictures with a short recording time

[Resize]

To allow easy posting to web pages, attachment to e-mail etc., picture size (number of pixels) is reduced.

- 1 Select **[Resize]** on the **[Playback]** menu. (P64)
- 2 Touch **[Single]** or **[Multi]**.
- 3 Select the picture and size.

[Single] setting

- 1 Drag the screen horizontally to select an image, and then touch **[Set]**.
- 2 Touch the size you wish to change, and then touch **[Set]**.
 - Confirmation screen is displayed. It is executed when **[Yes]** is selected.
 - Exit the menu after it is executed.

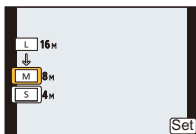

[Multi] setting

- 1 Touch the size you wish to change.
- 2 Touch a picture (repeat).
 - Selection will be canceled by touching the same picture again.
- 3 Touch **[OK]**.
 - Confirmation screen is displayed. It is executed when **[Yes]** is selected.
 - Exit the menu after it is executed.



Note



- You can set up to 100 pictures at one time in **[Multi]**.
- The picture quality of the resized picture will deteriorate.
- It may not be possible to resize pictures recorded with other equipment.
- You cannot use **[Resize]** for the following pictures.
 - Motion pictures
 - Burst Picture Group
 - Pictures stamped with **[Text Stamp]**
 - Pictures taken with **[RAW₁]**, **[RAW₂]** or **[RAW]**

[Cropping]

You can enlarge and then clip the important part of the recorded picture.

- 1 Select [Cropping] on the [Playback] menu. (P64)**
- 2 Drag the screen horizontally to select an image, and then touch [Set].**
- 3 Select the parts to be cropped.**
 - Touch [ - You can also move using the cursor buttons ▲/▼/◀/▶.
 - Enlarge/reduce can also be performed by rotating the rear dial.
- 4 Touch [Set].**
 - Confirmation screen is displayed. It is executed when [Yes] is selected.
Exit the menu after it is executed.

Note

- The picture quality of the cropped picture will deteriorate.
- It may not be possible to crop pictures recorded with other equipment.
- You cannot use [Cropping] for the following pictures.
 - Motion pictures
 - Pictures stamped with [Text Stamp]
 - Pictures taken with [RAW , [RAW ] or [RAW]
- Information regarding the Face Recognition in the original picture will not be copied to images having undergone [Cropping].

[Rotate]

You can manually rotate the images by 90° each time.

1 Select [Rotate] on the [Playback] menu. (P64)

- The [Rotate] function is disabled when [Rotate Disp.] in the [Setup] menu is set to [OFF].

2 Drag the screen horizontally to select an image, and then touch [Set].

- The [Rotate] function is disabled for Burst Picture Groups.

3 Select the rotation direction.

Touch :

The picture rotates clockwise in steps of 90°.

Touch :

The picture rotates counter-clockwise in steps of 90°.

- Exit the menu after it is set.

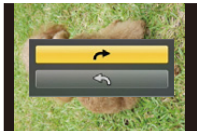

Note

- When you play back pictures on a PC, they cannot be displayed in the rotated direction unless the OS or software is compatible with Exif. Exif is a file format for still pictures which allows recording information etc. to be added. It was established by "JEITA (Japan Electronics and Information Technology Industries Association)".
- It may not be possible to rotate pictures that have been recorded with other equipment.

[Favorite]

You can do the following if a mark has been added to pictures and they have been set as favorites.

- Play back the pictures set as favorites only as a slide show.
- Play back only the pictures set as favorites. ([Favorite Play])
- Delete all the pictures not set as favorites. ([All Delete Except Favorite])

1 Select [Favorite] on the [Playback] menu. (P64)

2 Touch [Single] or [Multi].

3 Select the picture.

[Single] setting

Select the picture and touch [Set/Cancel].

- Setting is canceled by touching [Set/Cancel] again.
- Exit the menu after it is set.

[Multi] setting

Touch the pictures you wish to set as favorites.

- Setting is canceled by touching the same picture again.
- Exit the menu after it is set.

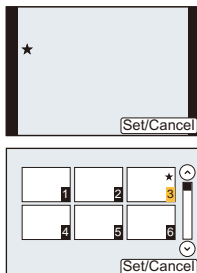

canceling all the [Favorite] settings

1 Select [Favorite] on the [Playback] menu.

2 Touch [Cancel].

- Confirmation screen is displayed. It is executed when [Yes] is selected.
Exit the menu after it is executed.
- In [Playback Mode] the [Cancel] Mode is disabled.

Note

- You can set up to 999 pictures as favorites.
- You may not be able to set pictures taken with other equipment as favorites.
- You cannot use [Favorite] for the following pictures.
 - Pictures taken with [RAW]

[Print Set]

DPOF "Digital Print Order Format" is a system that allows the user to select which pictures to print, how many copies of each picture to print and whether or not to print the recording date on the pictures when using a DPOF compatible photo printer or photo printing store. For details, ask at your photo printing store.

For more information visit:

http://panasonic.jp/dc/dpof_110/white_e.htm

When you set [Print Set] for a burst picture group, the print setting for the number of prints will be applied to every picture in the group.

1 Select [Print Set] on the [Playback] menu. (P64)

2 Touch [Single] or [Multi].

3 Select the picture.

[Single] setting

Drag the screen horizontally to select an image, and then touch [Set].

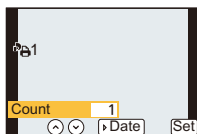

[Multi] setting

Touch the picture you wish to print.

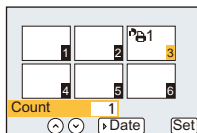

4 Touch [▲]/[▼] to set the number of prints, and then touch [Set].

- When [Multi] has been selected
 - repeat steps **3** and **4** for each picture. (It is not possible to use the same setting for a multiple number of pictures.)
- [999+] is displayed on the screen, if the total number of prints you set for a burst picture group is more than 1000 pictures.
- Exit the menu after it is set.

■ canceling all the [Print Set] settings

1 Select [Print Set] on the [Playback] menu.

2 Touch [Cancel].

- Confirmation screen is displayed. It is executed when [Yes] is selected.
- Exit the menu after it is executed.

■ To print the date

After setting the number of prints, set/cancel printing with the recording date by touching [Date].

- Depending on the photo printing store or the printer, the date may not be printed even if you set to print the date. For further information, ask at your photo printing store or refer to the operating instructions for the printer.
- The date print feature is disabled for pictures that are stamped with text.



Note

- The number of prints can be set from 0 to 999.
- Depending on the printer, the date print settings of the printer may take precedence so check if this is the case.
- It may not be possible to use the print settings with other equipment. In this case, cancel all the settings, and reset the settings.
- If the file is not based on the DCF standard, the DPOF print setting cannot be set.
- You cannot use [Print Set] for the following pictures.
 - Motion pictures
 - Pictures taken with [RAW]

[Protect]

You can set protection for pictures you do not want to delete by mistake.

- 1 Select **[Protect]** on the **[Playback]** menu. (P64)
- 2 Touch **[Single]** or **[Multi]**.
- 3 Select the picture.

[Single] setting

Select the picture and touch **[Set/Cancel]**.

- Setting is canceled by touching **[Set/Cancel]** again.
- Exit the menu after it is set.

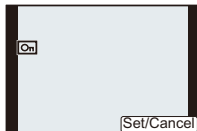

[Multi] setting

Touch the picture you wish to protect.

- Setting is canceled by touching the same picture again.
- Exit the menu after it is set.

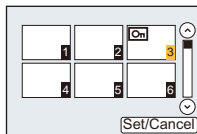

■ canceling all the [Protect] settings

- 1 Select **[Protect]** on the **[Playback]** menu.
- 2 Touch **[Cancel]**.
 - Confirmation screen is displayed. It is executed when **[Yes]** is selected.
 - Exit the menu after it is executed.

Note

- The **[Protect]** feature is only designed to work with this camera.
- Even if you protect pictures on a card, they will be deleted if the card is formatted.
- Even if you do not protect pictures on a card, they cannot be deleted when the card's Write-Protect switch is set to **[LOCK]**.

[Face Rec Edit]

You can clear and replace all information relating to face recognition in selected images.

- 1 Select **[Face Rec Edit]** on the **[Playback]** menu. (P64)
- 2 Touch **[REPLACE]** or **[DELETE]**.
- 3 Drag the screen horizontally to select an image, and then touch **[Set]**.
- 4 Touch the name of the person you wish to edit.
- 5 (When **[REPLACE]** is selected) Touch the person to replace.
 - Confirmation screen is displayed. It is executed when **[Yes]** is selected.
 - Exit the menu after it is executed.

Note

- Cleared information regarding the **[Face Recog.]** cannot be restored.
- When all Face Recognition information in a picture has been canceled, the picture will not be categorized using Face Recognition in **[Category Play]**.

Enjoying 3D pictures

Taking 3D pictures

Attaching the 3D interchangeable lens (H-FT012: optional) to the camera allows you to take 3D pictures for extra impact.

To view 3D pictures, a television that supports 3D is required.

3D picture



The illustration is an image.

1 Attach the 3D interchangeable lens to the camera.

2 Bring the subject into the frame and record by pressing the shutter button fully.

- Focusing is not required when recording 3D pictures.
- Still pictures recorded with the 3D interchangeable lens attached are saved in MPO format (3D).

To ensure that the 3D pictures can be safely viewed, pay attention to the following points when recording.

- Where possible, record with the unit in a horizontal state.
- The suggested minimum subject distance is 0.6 m (1.97 feet).
- Be careful not to shake the camera while in a vehicle or walking.

Note

- **You cannot record 3D pictures in vertical orientation.**
- It is recommended to use a tripod or a flash to record steady pictures.
- When a distance to the subject is 0.6 m (1.97 feet) to approximately 1 m (3.29 feet), horizontal disparity becomes too great, and you may not see the 3D effect at the edges of the image.
- Up to approx. 490 3D pictures can be recorded on a 2 GB card. (When the aspect ratio is set to [4:3], and the quality is set to [3D 1].)
- Read the operating instructions of the 3D interchangeable lens for details.

■ Functions that cannot be used during 3D recording

When recording with the 3D interchangeable lens (H-FT012: optional), the following feature will be disabled:

(Recording functions)

- Auto Focus/Manual Focus operation
- Aperture setting
- Zoom operation
- Recording motion pictures*1
- [Glistening Water]/[Glittering Illuminations] (Scene Guide Mode)
- [Impressive Art]/[High Dynamic]/[Toy Effect]/[Star Filter]/[One Point Color] (Creative Control Mode)
- Defocus control function

*1 The motion picture button and the [Motion Picture] menu will be unavailable or unusable.

([Rec] menu)

- [Picture Size]*2/[Quality]*3/[Focus Mode]/[HDR]/[i.Dynamic]/[Red-Eye Removal]/[i.Resolution]/[Shading Comp.]/[Digital Zoom]/[SH] of [Burst Rate]/[Stabilizer]

*2 The setting is fixed as shown below.

Aspect ratio	Picture size
4:3	1824×1368 pixels
3:2	1824×1216 pixels
16:9	1824×1024 pixels
1:1	1712×1712 pixels

*3 When attaching 3D interchangeable lens, the following icons are displayed.

: MPO+Fine (Both MPO images and fine JPEG images are recorded simultaneously.)

: MPO+Standard (Both MPO images and standard JPEG images are recorded simultaneously.)

([Custom] menu)

- [AF/AE Lock]/[Quick AF]/[Eye Sensor AF]/[Direct Focus Area]/[Focus Priority]/[Shutter AF]/[Pinpoint AF Time]/[AF Assist Lamp]/[AF+MF]/[MF Assist]/[MF Guide]/[Power Zoom Lens]/[Video Button]/[Rec Area]/[Remaining Disp.]/[Touch AF], [Touch Pad AF] in [Touch Settings]

Playing back 3D pictures

Connecting the camera to a 3D compatible television and playing back pictures taken in 3D allows you to enjoy 3D pictures for extra impact.

It is also possible to play back the recorded 3D pictures by inserting an SD card into the 3D compatible television with an SD card slot.

For current information regarding devices that can play back 3D pictures recorded with this unit, please refer to the below support site.

<http://panasonic.jp/support/global/cs/dsc/> (This Site is English only.)

Preparations: Set the [HDMI Mode] to [AUTO] or [1080i]. (P74)

Set the [3D Playback] to [**3D**]. (P75)

Connect the unit to a 3D compatible television using the HDMI mini cable and display the playback screen. (P193)

- When [VIERA Link] (P75) is set to [ON] and the camera is connected to a TV supporting VIERA Link, input of the TV will be switched automatically and playback screen will be displayed. Refer to P195 for details.
- For the pictures recorded in 3D, [**3D**] will appear on the thumbnail display at playback.

■ Playback in 3D by selecting only the still pictures recorded in 3D

Select [3D Play] in [Playback Mode] in the [Playback] menu. (P177)

■ Playback as a 3D slide show by selecting only the still pictures recorded in 3D

Select [3D] in [Slide Show] in the [Playback] menu. (P175)

■ Switch the playback method for the still pictures recorded in 3D

1 Select the picture recorded in 3D.

2 Select [2D/3D Settings] on the [Playback] menu. (P64)

- Playback method will switch to 3D if it is playing back in 2D (conventional image), or it will switch to 2D if it is playing back in 3D.
- If you feel tired, uncomfortable or otherwise strange when playing back pictures recorded in 3D, set to 2D.

■ Functions that cannot be set/do not work with 3D pictures

- [Highlight] ([Custom] menu)*
- Playback Zoom*
- Deleting pictures*
- Editing functions of [Playback] menu ([Title Edit]/[Text Stamp]/[Video Divide]/[Resize]/[Cropping]/[Rotate]/[Favorite]*/[Print Set]*/[Protect]*/[Face Rec Edit]*)

* Can be used when displayed in 2D.

 **Note**

- When a picture recorded in 3D is displayed on this unit, it is played back in 2D (conventional image).
- A black screen is displayed for a few seconds when switching playback back and forth from 3D to 2D pictures.
- When you select a 3D picture thumbnail, it may take a few seconds for playback to start. After playback, the thumbnail display may take a few seconds to reappear.
- When viewing 3D pictures, your eyes may become tired if you are too close to the television screen.
- If your television does not switch to a 3D picture, make the necessary settings on the TV. (For details, refer to the operating instructions of the TV.)
- 3D pictures can be saved to your computer or Panasonic devices. ([P197](#), [201](#))

Playing Back Pictures on a TV Screen

Pictures recorded with this unit can be played back on a TV screen.

Preparations: Turn this unit and the TV off.

- Confirm the terminals on your TV and use a cable compatible with the terminals. Image quality may vary with the connected terminals.

- 1 High quality
- 2 HDMI socket
- 3 Video socket



1 Connect the camera and a TV.

- Check the direction of the terminals and plug in/out straight holding onto the plug. (It may result in malfunction by the deforming of the terminal if it is plugged in obliquely or in wrong direction.)

To connect with an HDMI mini cable (optional)

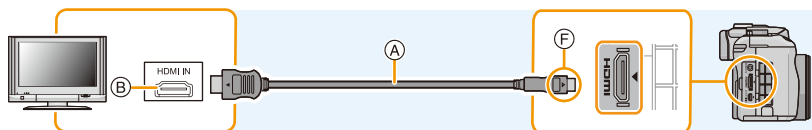

- Always use a genuine Panasonic HDMI mini cable (RP-CDHM15, RP-CDHM30: optional).
Part numbers: RP-CDHM15 (1.5 m) (5 feet), RP-CDHM30 (3.0 m) (10 feet)
- Check the [HDMI Mode]. (P74)
- Audio will be played back as stereo (2ch).
- No picture is displayed on the screen of this unit.

To connect with an AV cable (optional)

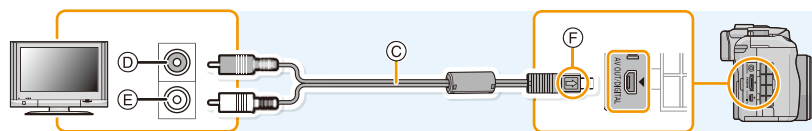

- Always use a genuine Panasonic AV cable (DMW-AVC1: optional).
- Check the [TV Aspect]. (P74)
- Audio will be played back in monaural.
- The viewfinder cannot be displayed when connected with a AV cable.

- A HDMI mini cable (optional)
- B HDMI socket
- C AV cable (optional)
- D Yellow: to the video input socket
- E White: to the audio input socket
- F Align the marks, and insert.

2 Turn on the TV and select the input to match the connector in use.

3 Turn the camera on and then press [▶].

- Input of the TV will switch automatically and playback screen is displayed when connected to a VIERA Link compatible TV using an HDMI mini cable with the [VIERA Link] (P75) set to [ON]. (P195)

 **Note**

- Depending on the [Aspect Ratio], black bands may be displayed on the top and bottom or the left and right of the pictures.
- Change the screen mode on your TV if the picture is displayed with the top or bottom cut off.
- Output from the HDMI mini cable (optional) has priority when both AV cable (optional) and HDMI mini cable (optional) are connected.
- The connection with the USB connection cable (supplied) will take priority when you connect the USB connection cable (supplied) simultaneously with the HDMI mini cable (optional).
- When you play back a picture vertically, it may be blurry.
- Proper playback will be dependent on the TV used for viewing.
- No sound is output from the camera speakers.
- Read the operating instructions for the TV.

The recorded pictures can be played back on a TV with an SD Memory Card slot.

- Proper playback (aspect ratio) will be dependent on the TV used for viewing.
- The file format of the motion pictures that can be played back differs depending on the TV model.
- For cards compatible with playback, refer to the operating instructions of the TV.

Using VIERA Link (HDMI)

What is the VIERA Link (HDMI) (HDAVI Control™)?

- VIERA Link™ is a new name for EZ Sync™.
- This function allows you to use your remote control for the Panasonic TV for easy operations when this unit has been connected to a VIERA Link compatible device using a HDMI mini cable (optional) for automatic linked operations. (Not all operations are possible.)
- VIERA Link is a unique Panasonic function built on a HDMI control function using the standard HDMI CEC (Consumer Electronics Control) specification. Linked operations with HDMI CEC compatible devices made by other companies are not guaranteed. When using devices made by other companies that are compatible with VIERA Link, refer to the operating instructions for the respective devices.
- This unit is compatible with VIERA Link Ver.5. VIERA Link Ver.5 is the newest Panasonic version and is also compatible with existing Panasonic VIERA Link devices. (As of November 2011)

Preparations: Set the [VIERA Link] to [ON]. (P75)

- 1 Connect this unit to a Panasonic TV compatible with VIERA Link with a HDMI mini cable (optional) (P193).**
- 2 Turn the camera on and then press .**
- 3 Operate with the remote control for the TV.**

- Operate with reference to the operation icons displayed on the screen.

Note

- To play back the audio of the motion pictures, set the [Sound] in the Slide Show setting screen to [AUTO] or [Audio].
- It is recommended to connect this unit to an HDMI terminal other than the HDMI1 if there are 2 or more HDMI input terminals on the TV.
- Operation using the buttons on this unit will be limited.

■ Other linked operations

Turning this unit off:

If you use the remote control for the TV to turn the TV off, this unit is also turned off.

Automatic input switching:

- If you connect with a HDMI mini cable and then turn this unit on, and then press **[▶]**, the input channel on the TV automatically switches to this unit's screen. If the TV's power is in standby status, it will turn on automatically (if **[Set]** has been selected for the TV's **[Power on link]** setting).
- Depending on your TV's HDMI connection, on some TV's it may be necessary to manually select the HDMI connection you are using. In this case, use the remote control for the TV to switch the input channel. (For details on how to switch input, please read the operating instructions for the TV.)
- If VIERA Link does not work properly, refer to page [229](#).

Note

- If you are unsure whether or not the TV you are using is compatible with VIERA Link, read the operating instructions for the TV.
- Available linked operations between this unit and a Panasonic TV are different depending on the types of Panasonic TVs even if they are compatible with VIERA Link. Refer to the operating instructions of the TV for the operations are supported on the TV.
- Be sure to use a cable that is HDMI certified.
Always use a genuine Panasonic HDMI mini cable (RP-CDHM15, RP-CDHM30: optional).
Part numbers: RP-CDHM15 (1.5 m) (5 feet), RP-CDHM30 (3.0 m) (10 feet)
- **[HDMI Mode]** for this unit is determined automatically when the VIERA Link is operating.

Saving still pictures and motion pictures on your PC

You can acquire recorded pictures to a PC by connecting the camera and the PC.

- Some PCs can read directly from the card removed from the camera. For details, refer to the operating instructions of your PC.
- **If the computer being used does not support SDXC Memory Cards, a message prompting you to format may appear. (Doing so will cause recorded images to be erased so do not choose to format.)**

If the card is not recognized, please refer to the below support site.

<http://panasonic.net/avc/sdcard/information/SDXC.html>

■ PC that can be used

The unit can be connected to any PC capable of recognising a mass storage device.

- Windows support: Windows 7/Windows Vista/Windows XP
- Mac support: OS X v10.1 ~ v10.7

AVCHD motion pictures may not be imported correctly when copied as files or folder.

- With Windows, always import AVCHD motion pictures using "PHOTOfunSTUDIO", one of the programs on the CD-ROM (supplied).
(Read the "Basic Owner's Manual" for more information about the "PHOTOfunSTUDIO")
- With a Mac, AVCHD motion pictures can be imported using "iMovie'11".
Note that motion pictures (AVCHD Progressive) recorded in [PSH] cannot be imported.
(For details about iMovie'11, please contact Apple Inc.)

Preparations: Install “PHOTOfunSTUDIO” to the PC.

- Read the “Basic Owner’s Manual” for more information about install.

The software “PHOTOfunSTUDIO” on the CD-ROM (supplied) can be used to save all the still pictures and motion pictures recorded by the camera in their various formats to your computer.



1 Connect the computer and camera with the USB connection cable (supplied).

- Please turn this unit on and your PC before connecting.
- Check the directions of the connectors, and plug them straight in or unplug them straight out. (Otherwise, the connectors may bend out of shape, which will cause a malfunction.)
- Do not use any other USB connection cables except the supplied one or a genuine Panasonic USB connection cable (DMW-USBC1: optional).
- Turn the LCD monitor so the LCD will show out.

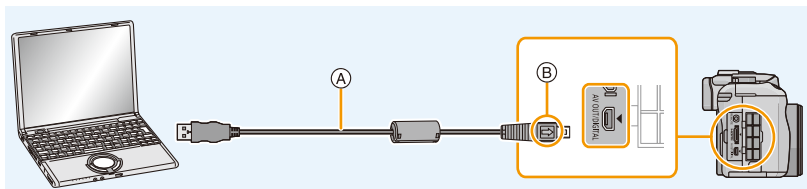

- (A) USB connection cable (supplied)
- (B) Align the marks, and insert.

2 Touch [PC] on the screen of this unit.

- If [USB Mode] (P73) is set to [PC] in the [Setup] menu in advance, the camera will be automatically connected to the PC without displaying the [USB Mode] selection screen.
- When the camera has been connected to the PC with [USB Mode] set to [PictBridge(PTP)], a message may appear on the PC’s screen. Close the screen by selecting [Cancel], safely remove the USB connection cable (P200), and set the [USB Mode] to [PC].

3 Copy the images to a PC using “PHOTOfunSTUDIO”.

- Do not delete or move copied files or folders in Windows Explorer. When viewing in “PHOTOfunSTUDIO”, you will not be able to play back or edit.

Note

- “PHOTOfunSTUDIO” is not compatible with Mac.
 - Use a battery with sufficient battery power or the AC adaptor (optional). If the remaining battery power becomes low while the camera and the PC are communicating, the status indicator blinks and the alarm beeps.
- Refer to “Disconnecting the USB connection cable safely” (P200) before disconnecting the USB connection cable. Otherwise, data may be destroyed.
- Before connecting or disconnecting the AC adaptor (optional), turn the camera off.
 - Before inserting or removing a card, turn the camera off and disconnect the USB connection cable. Otherwise, data may be destroyed.

■ Copying to a PC without using “PHOTOfunSTUDIO”

If you are not able to install “PHOTOfunSTUDIO”, you can copy files and folders to your PC by dragging and dropping files from this unit.

- The content (folder structure) on the card of this unit is as follows.

For Windows: A drive ([Removable Disk]) is displayed in [Computer]

For Mac: A drive ([LUMIX], [NO_NAME] or [Untitled]) is displayed on the desktop

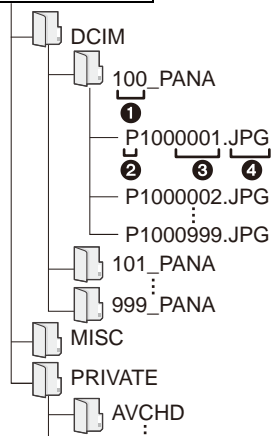
• Card

DCIM:	Images
① Folder number	
② Color space	P: sRGB _: AdobeRGB
③ File number	
④ JPG:	Still pictures
MP4:	[MP4] Motion pictures
RW2:	Pictures in RAW files
MPO:	3D pictures
MISC:	DPOF print Favorite
AVCHD:	[AVCHD] Motion pictures

- AVCHD motion pictures may not be imported correctly when copied as files or folder. We recommend using “PHOTOfunSTUDIO” on the CD-ROM (supplied) for importing files. Refer to P197 for details.
- A new folder is created when pictures are taken in the following situations.
 - After [No.Reset] (P76) in the [Setup] menu has been executed
 - When a card containing a folder with the same folder number has been inserted (such as when pictures were taken using another maker of camera)
 - When there is a picture with file number 999 inside the folder

■ Disconnecting the USB connection cable safely

Select the  icon in the task tray displayed on the PC, and then click [Eject DMC-XXX] (XXX varies by model).

- Depending on your PC's settings, this icon may not be displayed.
- If the icon is not displayed, check that [Access] is not displayed on the LCD monitor of the digital camera before removing the hardware.

■ Connection in the PTP Mode

Set [USB Mode] to [PictBridge(PTP)].

- Data can now be read only from the card in the PC.
- When there are 1000 or more pictures on a card, the pictures may not be imported in the PTP mode.
- Motion picture cannot be played back in PTP Mode.

Saving still pictures and motion pictures on a Recorder

If you insert card holding content recorded with this unit into a Panasonic recorder, you can dub the content to a Blu-ray Disc or DVD etc.

Methods to export still pictures and motion pictures to other devices will vary depending on the file format. (JPEG, RAW, MPO, AVCHD, or MP4).

For details on Panasonic devices compatible with the respective file format (such as a Blu-ray Disc recorder), refer to the support sites below.

<http://panasonic.jp/support/global/cs/dsc/>

(This Site is English only.)

* Some compatible devices may not be sold in certain countries and regions.

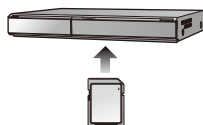

- See the operating instructions for the recorder about the details about copying and playing back.
- **Note that the equipment described may not be available in certain countries and regions.**

■ Dubbing with non-compatible equipment

You can dub the content played back using this unit to non-compatible equipment such as recorders and video players by connecting this unit to the non-compatible equipment using an AV cable (optional). Non-compatible equipment will be able to play back the content. This is convenient if you wish to pass around dubbed content. In this case, the content will be played back in standard rather than high-definition picture quality.

- 1 **Connect this unit with the recording equipment with an AV cable (optional).**
- 2 **Start the playback of this unit.**
- 3 **Start the recording on the recording equipment.**

- When ending the recording (copying), stop the playback on this unit after stopping the recording on recording equipment.

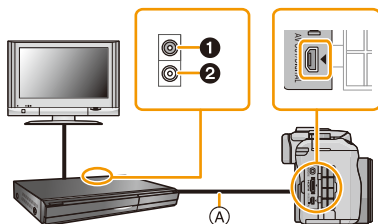

- 1 Yellow: to the video input socket
- 2 White: to the audio input socket
- A AV cable (optional)

Note

- When you play back motion pictures on 4:3 aspect ratio TV, you must set [TV Aspect] (P74) on this unit to [4:3] before starting a copy. The image will be vertically long if you play back motion pictures copied with [16:9] setting on a [4:3] aspect TV.
- Always use a genuine Panasonic AV cable (DMW-AVC1: optional).
- See the operating instructions for the recording equipment for details about copying and playing back.

Printing the Pictures

If you connect the camera to a printer supporting PictBridge, you can select the pictures to be printed out and instruct that printing be started on the camera's LCD monitor.

- Burst pictures will be displayed as a list, and not as a group.
- Some printers can print directly from the card removed from the camera. For details, refer to the operating instructions of your printer.

Preparations: Turn on the camera and the printer.

Perform the print quality and other settings at the printer before printing the pictures.

1 Connect the printer and camera with the USB connection cable (supplied).

- Check the directions of the connectors, and plug them straight in or unplug them straight out. (Otherwise, the connectors may bend out of shape, which will cause a malfunction.)
- Do not use any other USB connection cables except the supplied one or a genuine Panasonic USB connection cable (DMW-USBC1: optional).

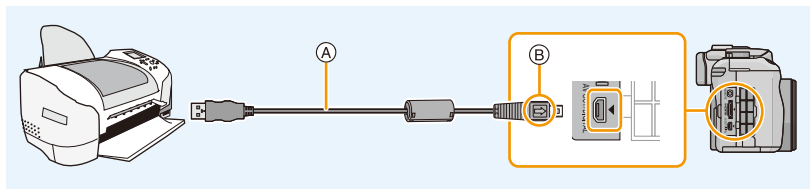

- (A) USB connection cable (supplied)
- (B) Align the marks, and insert.

2 Touch [PictBridge(PTP)].

Note

- Use a battery with sufficient battery power or the AC adaptor (optional). If the remaining battery power becomes low while the camera and the printer are connected, the status indicator blinks and the alarm beeps. If this happens during printing, stop printing at once. If not printing, disconnect the USB connection cable.
- Do not disconnect the USB connection cable while [⊘] (Cable disconnect prohibit icon) is displayed. (May not be displayed depending on the type of printer used)
- Before connecting or disconnecting the AC adaptor (optional), turn the camera off.
- Before inserting or removing a card, turn the camera off, and disconnect the USB connection cable.
- Motion pictures recorded cannot be printed out.

Selecting a single picture and printing it

- 1 Drag the screen horizontally to select an image, and then touch [Print].

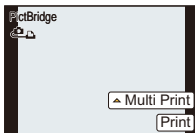

- 2 Touch [Print start].

- Refer to [P204](#) for the items that can be set before starting to print the pictures.
- Disconnect the USB connection cable after printing.

Selecting multiple pictures and printing them

- 1 Touch [Multi Print].

- 2 Touch the item.

Item	Description of settings
[Multi Select]	Multiple pictures are printed at one time. <ul style="list-style-type: none"> • Select the picture you wish to print. (Touch the same picture again to cancel the selection) • After the pictures have been selected, touch [OK].
[Select All]	Prints all the stored pictures.
[Print Set (DPOF)]	Prints the pictures set in [Print Set] only. (P186)
[Favorite]	Prints the pictures set as favorites only. (P185)

- 3 Touch [Print start].

- If the print check screen has appeared, select [Yes], and print the pictures.
- Refer to [P204](#) for the items which can be set before starting to print the pictures.
- Disconnect the USB connection cable after printing.

Print Settings

Select and set the items both on the screen in step 2 of the “Selecting a single picture and printing it” and in step 3 of the “Selecting multiple pictures and printing them” procedures.

- When you want to print pictures on a paper size or a layout which is not supported by the camera, set [Paper Size] or [Page Layout] to  and then set the paper size or the layout on the printer. (For details, refer to the operating instructions of the printer.)
- When [Print Set (DPOF)] has been selected, the [Print with Date] and [Num.of prints] items are not displayed.

■ [Print with Date]

Item	Description of settings
[ON]	Date is printed.
[OFF]	Date is not printed.

- If the printer does not support date printing, the date cannot be printed on the picture.
- Depending on the printer, the date print settings of the printer may take precedence so check if this is the case.
- When printing images with a text stamp, please remember to set print with date to [OFF] or the date will print on top.
- In some printers, the picture date for pictures taken with the aspect ratio set to  will be printed vertically.

Note

When asking the photo shop to print the pictures

- By stamping the date using [Text Stamp] (P179) or setting date printing at the time of the [Print Set] (P186) setting before going to a photo shop, the dates can be printed on the pictures at the photo shop.

■ [Num.of prints]

You can set the number of prints up to 999.





- You can also use the rear dial to set.

■ [Paper Size]

Item	Description of settings
	Settings on the printer are prioritized.
[L/3.5"×5"]	89 mm×127 mm
[2L/5"×7"]	127 mm×178 mm
[POSTCARD]	100 mm×148 mm
[16:9]	101.6 mm×180.6 mm
[A4]	210 mm×297 mm
[A3]	297 mm×420 mm
[10×15cm]	100 mm×150 mm
[4"×6"]	101.6 mm×152.4 mm
[8"×10"]	203.2 mm×254 mm
[LETTER]	216 mm×279.4 mm
[CARD SIZE]	54 mm×85.6 mm

- Paper sizes not supported by the printer will not be displayed.

■ [Page Layout] (Layouts for printing that can be set with this unit)

Item	Description of settings
	Settings on the printer are prioritized.
	1 picture with no frame on 1 page
	1 picture with a frame on 1 page
	2 pictures on 1 page
	4 pictures on 1 page

- An item cannot be selected if the printer does not support the page layout.

■ Layout printing

When printing a picture several times on 1 sheet of paper.

For example, if you want to print the same picture 4 times on 1 sheet of paper, set [Page Layout] to  and then set [Num.of prints] to 4 for the picture that you want to print.

When printing different pictures on 1 sheet of paper.

For example, if you want to print 4 different pictures on 1 sheet of paper, set [Page Layout] to  and then set [Num.of prints] to 1 for each of the 4 pictures.

Note

- The camera is receiving an error message from the printer when the  indication lights orange during printing. After finishing printing, make sure there are no problems with the printer.
- If the number of prints is high, the pictures may be printed several times. In this case, the remaining number of prints indicated may differ from the number set.
- Only pictures taken in JPEG format can be printed. Those taken in RAW will use the JPEG pictures that were simultaneously created. If an equivalent JPEG picture is not available, no print will take place.

Optional accessories

External Flash (optional)

After attaching the external flash (DMW-FL220, DMW-FL360, DMW-FL500: optional), the effective range will be increased when compared to the camera's built-in flash.

Preparations:

- Turn off the camera and close the built-in flash.

■ Using the dedicated flash (DMW-FL220: optional)

- 1 Attach the dedicated flash to the hot shoe and then turn on the camera and the dedicated flash.**
- 2 Select [Flash] on the [Rec] menu. (P64)**
- 3 Touch the item.**

- While the external flash is connected, the following icons are displayed.

⚡: External flash Forced ON

⚡S: External flash Slow Sync.

■ When using other commercially available external flashes without communication functions with the camera (DMC-G5)

- It is necessary to set the exposure on the external flash. If you want to use the external flash in Auto Mode, use an external flash that allows you to set the aperture value and the ISO sensitivity to match the settings on the camera.
- Set to Aperture-Priority AE Mode or Manual Exposure Mode on the camera and then set the same aperture value and ISO sensitivity on the external flash. (The exposure cannot be compensated adequately due to the change on the aperture value in Shutter-Priority AE Mode and the external flash cannot control the light adequately in Program AE Mode because the aperture value cannot be fixed.)

 **Note**

- You can set the aperture value, the shutter speed and the ISO sensitivity on the camera even when attaching the external flash.
- Some commercial external flashes have synchro terminals with high-voltage or reversed polarity. Using such extra flashes may cause a malfunction or the camera may not operate normally.
- If you use commercially available external flashes with communication functions other than the dedicated one, they may not operate normally or they may be damaged. Do not use them.
- Even if the external flash is turned off, the camera may enter the external flash mode when the external flash is attached. When you are not using the external flash, detach it.
- Do not open the built-in flash when an external flash is attached.
- The camera will become unstable when attaching the external flash, it is recommended to use a tripod when taking picture.
- Detach the external flash when carrying the camera.
- When attaching the external flash, do not hold only the external flash because it may detach from the camera.
- If you use the external flash when the White Balance is set to [] finely adjust the White Balance depending on the picture quality. (P109)
- If you record at close range with a wide angle, light from the flash may be blocked by the lens, darkening the lower part of the screen.
- Read the operating instructions of the external flash for details.

Conversion lens (optional)

You can easily widen the range of expression of the unit by installing a compatible lens.

Wide conversion lens:	Wide-angle effect allows a wider field of view.
Tele conversion lens:	Telescopic effect allows a higher level of magnification.
Macro conversion lens:	Allows higher level of magnification of small subjects.
Fish eye conversion lens:	Enables recording of image with stretched perspective.

- We recommend that you use a conversion lens that is compatible with this unit. Use of a non-compatible conversion lens or adaptor may result in breakage or damage to the lens.
- For details, refer to the operating instructions of the relevant conversion lenses.

Filters (optional)

The MC protector is a transparent filter which affects neither the colors nor the amount of light, so it can always be used to protect the camera's lens.

The ND filter reduces the amount of light to approximately 1/8th (equal to adjusting the aperture value 3 increments) without affecting the color balance.

PL filter will suppress the reflected light from a metal or non spherical surfaces (flat non-metallic surfaces, water vapour or invisible particles in the air), making it possible to take a picture with enhanced contrast.

Note

- When using the interchangeable lens (H-PS14042), turn this unit off and ensure the lens barrel is retracted before attaching or removing a filter.
- Do not attach multiple filters at the same time.
- You can attach the lens cap or the lens hood when the filter is attached.
- Refer to the instructions for each filter for details.

Remote Shutter (optional)

If you use the remote shutter (DMW-RSL1: optional), you can avoid jitter (camera shake) when using a tripod and you can keep the shutter pressed fully when taking pictures with [B] (Bulb) or Burst Mode. The remote shutter works similar to the shutter button on the camera.

Note

- Always use a genuine Panasonic remote shutter (DMW-RSL1: optional).
- You cannot operate the camera with the remote shutter in the following cases.
 - When the Sleep Mode is canceled
 - When starting/ending the recording of motion pictures
- Read the operating instructions of the remote shutter for details.

AC adaptor (optional)/DC coupler (optional)

By connecting the AC adaptor (optional), and then plugging them into an electrical socket, you can connect this unit to a PC or printer and use without worrying about the capacity of the battery. To use the AC adaptor, a DC coupler (optional) is required.

Note

- Always use a genuine Panasonic AC adaptor (optional).
- When using an AC adaptor, use the AC cable supplied with the AC adaptor.
- Also read the operating instructions for the AC adaptor and DC coupler.

LCD Monitor Display/Viewfinder Display

- The following images are examples of when the display screen is set to [] (LCD monitor style) in the LCD monitor.

In recording

Recording in Program AE Mode [P]

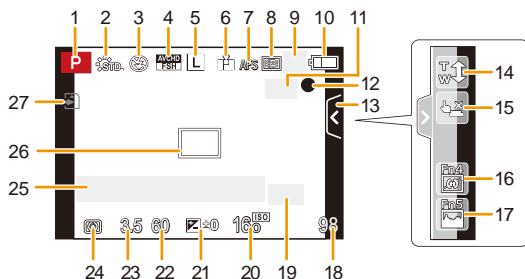

- | | | | |
|----|--|----|---|
| 1 | Recording Mode (P31) | 17 | Fn5 (Function button) (P114)*2 |
| 2 | Photo Style (P147) | 18 | Number of recordable pictures*3 (P28) |
| 3 | Flash Mode (P84) | 19 | Dial operation guide (P172)/Extended
Tele Conversion (when taking still
pictures) (P80) |
| 4 | REC MODE (when recording motion
pictures) (P159)/Recording quality (P160) | 20 | ISO sensitivity (P111) |
| 5 | Picture size (P149) | 21 | Exposure compensation value (P88)/
Brightness (P46)/Manual Exposure
Assistance (P120) |
| 6 | Quality (P150) | 22 | Shutter speed (P38) |
| 7 | Focus Mode (P36) | 23 | Aperture value (P38) |
| 8 | AF Mode (P95) | 24 | Metering Mode (P151) |
| 9 | ☐H: Burst (P89)
☐B: Auto Bracket (P91)
☐10: Self-timer (P93) | 25 | Exposure meter (P166)
Focal distance display (P169)
Step zoom (P169) |
| 10 | Battery indication (P22) | 26 | AF area (P37, 99) |
| 11 | ⦿: Optical Image Stabilizer*1 (P78)/
⦿: Jitter alert (P78) | 27 | Card (P27) (displayed only during
recording)/Elapsed recording time
(P53): 8m30s*4 |
| 12 | Recording state (Flashes red.)/
Focus (P37) (Lights green.) | | |
| 13 | Touch tab (P171)*2 | | |
| 14 | Touch zoom (P83)*2 | | |
| 15 | Touch Shutter (P39)*2 | | |
| 16 | Fn4 (Function button) (P114)*2 | | |

■ In recording (after settings)

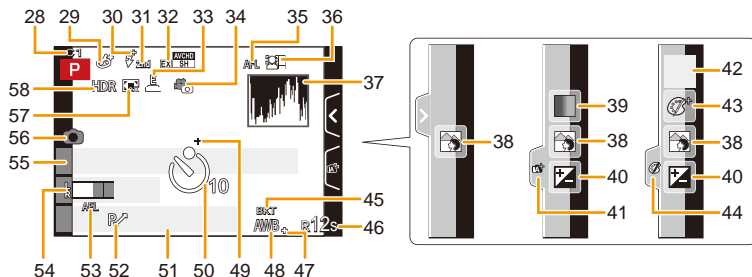

- 28 Custom settings (P139)
 29 Creative control adjustment display (P130)
 30 Flash output adjustment (P153)
 31 2nd curtain synchro (P153)
 32 Extended Tele Conversion (when recording motion pictures) (P80)
 33 Electronic shutter (P156)
 34 Picture Mode (P55)
 35 AF Lock (P104)
 36 Face Recognition (P142)
 37 Histogram (P164)
 38 Defocus control function*2 (P48)
 39 Color*2 (P47)
 40 Brightness*2 (P46)
 41 Touch tab (P46, 171)
 42 : Type of defocus ([Miniature Effect])*2 (P135)/
: [One Point Color]*2 (P138)
 43 Creative control adjustment*2 (P130)
 44 Touch tab (P130, 171)
 45 White Balance Bracket (P110)
 46 Available recording time*3 (P28): R8m30s*4
 47 White Balance Fine Adjustment (P109)
 48 White Balance (P106)/: Color (P47)
 49 Spot metering target (P151)
 50 Self-timer*5 (P93)
 51 Current date and time/: Travel destination setting*6 (P70)

- 52 Program Shift (P51)
 53 AE Lock (P104)
 54 Mic level display (P162)
 Age*7 (P158)
 Location*6 (P71)
 55 Name*7 (P158)
 Number of days that have passed since the departure date*6 (P71)
 56 Simultaneous recording indicator (P55)
 57 Digital Zoom (P80)
 58 HDR (P151)

- *1 Only available when a lens that supports the stabilizer function is attached
 *2 Only displayed in the LCD monitor.
 *3 It is possible to switch the display between the number of recordable pictures and available recording time with the [Remaining Disp.] setting in the [Custom] menu.
 *4 "h" is an abbreviation for hour, "m" for minute and "s" for second.
 *5 This is displayed during countdown.
 *6 This is displayed for about 5 seconds when the camera is turned on, after setting the clock and after switching from Playback Mode to Recording Mode.
 *7 This is displayed for about 5 seconds when the camera is turned on if the [Profile Setup] setting is set.

In playback

- 1 Playback Mode (P177)
- 2 : Motion picture playback (P61)/
: Continuously Burst Picture Group Playback (P173)
- 3 Protected picture (P188)
- 4 Number of prints (P186)
- 5 Picture size (P149)
: Recording mode (when recording motion pictures) (P159)/Recording quality (P160)
- 6 Quality (P150)
- 7 Battery indication (P22)
- 8 Picture number/Total pictures
- 9 Number of pictures in burst/
Motion picture recording time (P61): 8m30s*1
- 10 Playback (Motion Picture, Burst Pictures) (P61, 173)
- 11 Multi Playback (P57)
- 12 Delete (P63)
- 13 Recording information*2
: Intelligent Dynamic Range Control (P152)
: HDR (P151)
: Intelligent Resolution (P154)
: [Shading Comp.] (P155)
- 14 Age (P158)
- 15 Burst Picture Group Display (P173)
- 16 Name*3 (P144, 158)/Location*3 (P71)/Title*3 (P178)
- 17 Number of days that have passed since the departure date (P71)
- 18 Currently retrieving information icon (P220)
- 19 Stamped with text indication (P179)
Elapsed playback time (P61): 8m30s*1
- 20 Favorites (P185)
Cable disconnection warning icon (P202)
- 21 Folder/File number*2 (P199)
- 22 Color space*4 (P157)
- 23 Recorded date and time/World Time (P70)
- 24 Histogram (P60)

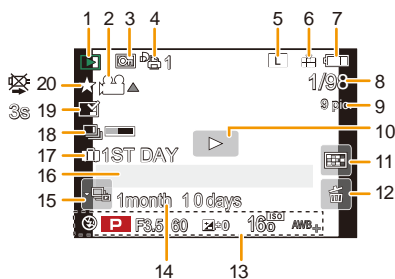

Detailed information display

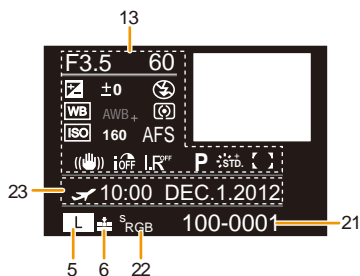

Histogram display

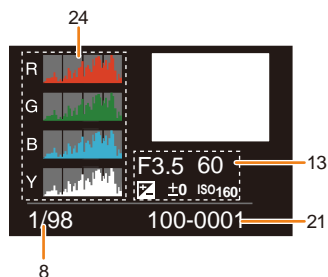

*1 "h" is an abbreviation for hour, "m" for minute and "s" for second.

*2 This is not displayed for motion pictures recorded in [AVCHD].

*3 It is displayed in order of [Title], [Location], [Name] ([Baby1]/[Baby2], [Pet]), [Name] ([Face Recog.]).

*4 This is not displayed for motion pictures recorded in [AVCHD]/[MP4].

Cautions for Use

Optimal use of the camera

Keep this unit as far away as possible from electromagnetic equipment (such as microwave ovens, TVs, video games etc.).

- If you use this unit on top of or near a TV, the pictures and/or sound on this unit may be disrupted by electromagnetic wave radiation.
- Do not use this unit near cell phones because doing so may result in noise adversely affecting the pictures and/or sound.
- Recorded data may be damaged, or pictures may be distorted, by strong magnetic fields created by speakers or large motors.
- Electromagnetic wave radiation generated by microprocessors may adversely affect this unit, disturbing the pictures and/or sound.
- If this unit is adversely affected by electromagnetic equipment and stops functioning properly, turn this unit off and remove the battery or disconnect AC adaptor (optional). Then reinsert the battery or reconnect AC adaptor and turn this unit on.

Do not use this unit near radio transmitters or high-voltage lines.

- If you record near radio transmitters or high-voltage lines, the recorded pictures and/or sound may be adversely affected.

Always use the supplied cords and cables. If you use optional accessories, use the cords and the cables supplied with them.

Do not extend the cords or the cables.

Do not spray the camera with insecticides or volatile chemicals.

- If the camera is sprayed with such chemicals, the body of the camera may be damaged and the surface finish may peel off.
- Do not keep rubber or plastic products in contact with the camera for a long period of time.

Cleaning

Before cleaning the camera, remove the battery or the DC coupler (optional), or disconnect the power plug from the outlet. Then wipe the camera with a dry, soft cloth.

- When the camera is soiled badly, it can be cleaned by wiping the dirt off with a wrung wet cloth, and then with a dry cloth.
- Wipe off any dirt or dust on the zoom ring and the focus ring with a dry, dustless cloth.
- Do not use solvents such as benzine, thinner, alcohol, kitchen detergents, etc., to clean the camera, since it may deteriorate the external case or the coating may peel off.
- When using a chemical cloth, be sure to follow the accompanying instructions.

■ About dirt on the image sensor

This camera features an interchangeable lens system so dirt may get inside the camera body when changing lenses. Depending on the recording conditions, dirt on the image sensor may appear on the recorded picture.

To prevent debris or dust adhering to internal parts of the body, avoid changing the lens in a dusty environment and always fit the body cap or a lens when storing the camera. Remove any dirt on the body cap before attaching it.

Dust reduction function

This unit has a dust reduction function that will blow off the debris and dust that have affixed to the front of the imaging device. This function will function automatically when the camera is turned on, but if you see dust, perform the [Sensor Cleaning] (P77) in the [Setup] menu.

■ Removing dirt on the image sensor

The image sensor is very precise and delicate, so be sure to observe the following when you do have to clean it yourself.

- Blow off the dust on the surface of the image sensor with a commercially available blower brush. Be careful not to blow too strongly.
- Do not put the blower brush further inside than the lens mount.
- Do not let the blower brush touch the image sensor as the image sensor may get scratched.
- Do not use any objects except a blower brush to clean the image sensor.
- If you cannot remove the dirt or dust with the blower, consult the dealer or your nearest Service Center.

■ For care of the eye cup on the viewfinder

- As the eye cup cannot be removed, gently wipe it with a dry and soft cloth, and be careful not to remove it.
- If you wipe the eye cup too hard and it is removed, consult the dealer or your nearest Service Center.

About the LCD monitor/Viewfinder

- Do not press the LCD monitor with excessive force. Uneven colors may appear on the LCD monitor and it may malfunction.
- If the camera is cold when you turn it on, the picture on the LCD monitor/Viewfinder will be slightly darker than usual at first. However, the picture will return to normal brightness when the internal temperature of the camera increases.

Extremely high precision technology is employed to produce the LCD monitor/Viewfinder screen. However there may be some dark or bright spots (red, blue or green) on the screen. This is not a malfunction. The LCD monitor/Viewfinder screen has more than 99.99% effective pixels with a mere 0.01% of the pixels inactive or always lit. The spots will not be recorded on pictures on a card.

About the Lens

- Do not press the lens with excessive force.
- Do not leave the camera with the lens facing the sun as rays of light from the sun may cause it to malfunction. Also, be careful when placing the camera outside or near a window.
- When there is dirt (water, oil, and fingerprints, etc.) on the surface of the lens, the picture may be affected. Lightly wipe the surface of the lens with a soft, dry cloth before and after taking pictures.
- Do not place the lens mount facing downwards. Do not allow the lens mount contacts ① to become dirty.

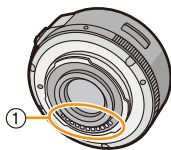

Battery

The battery is a rechargeable lithium ion battery. Its ability to generate power comes from the chemical reaction that takes place inside it. This reaction is susceptible to the surrounding temperature and humidity. If the temperature is too high or too low, the operating time of the battery will become shorter.

Always remove the battery after use.

- Place the removed battery in a plastic bag, and store or keep away from metallic objects (clips, etc.).

If you drop the battery accidentally, check to see if the body of the battery and the terminals are damaged.

- Inserting a damaged battery in the camera will damage the camera.

Bring charged spare batteries when going out.

- Be aware that the operating time of the battery becomes shorter in low temperature conditions such as at a ski resort.
- When you travel, do not forget to bring the battery charger (supplied) so that you can charge the battery in the country that you are traveling in.

Dispose of unusable battery.

- The battery has a limited life.
- Do not throw the battery into fire because it may cause an explosion.

Do not allow battery terminals to come into contact with metal objects (such as necklaces, hairpins, etc.).

- This can cause short-circuiting or heat generation and you may be badly burned if you touch a battery.

Charger

- The [CHARGE] indicator may blink under the influence of static electricity or electromagnetic wave. This phenomenon has no effects on charging.
- If you use the battery charger near a radio, the radio reception may be disturbed.
- Keep the charger 1 m (3.29 feet) or more away from radio.
- The charger may generate whirring sounds when it is being used. This is not a malfunction.
- After use, be sure to disconnect the power supply device from the electrical outlet. (A very small amount of current is consumed if it is left connected.)
- Keep the terminals of the charger and battery clean.

About 3D**■ About 3D recording**

With the 3D interchangeable lens attached, do not record a subject at less than the minimum focus distance.

- The 3D effects may be more pronounced, and therefore cause tiredness or discomfort.
- When the 3D interchangeable lens (H-FT012: optional) is used, the minimum focus distance is 0.6 m (1.97 feet).

When recording with the 3D interchangeable lens attached, be careful not to shake the unit.

- Tiredness or discomfort may result if the shake is pronounced, due to riding in a vehicle or walking etc.
- We recommend using a tripod.

■ About 3D viewing

Anyone who is hyper sensitive to light, suffers from heart disease or is otherwise unwell should avoid viewing 3D pictures.

- Doing may have an adverse affect on such medical conditions.

If you feel tired, uncomfortable or otherwise strange when viewing 3D pictures, stop viewing at once.

- Continuing to view may cause illness.
- Please rest appropriately after stopping the viewing.

When viewing 3D pictures, we recommend taking a break every 30 to 60 minutes.

- Viewing for extended periods may cause eye-fatigue.

Short-sighted or long-sighted persons, those with differences in the sight of their right and left eyes, and those with astigmatism are advised to correct their vision by wearing glasses etc.

Stop viewing if you can clearly see a double image while viewing 3D pictures.

- There are differences in the way that different people experience 3D pictures. Please correct your sight appropriately before viewing 3D pictures.
- You can change the 3D setting of your television or 3D output setting of the unit to 2D.

Card

Do not leave the card where the temperature is high, where electromagnetic waves or static electricity are easily generated or exposed to direct sunlight.

Do not bend or drop the card.

- The card may be damaged or the recorded content may be damaged or deleted.
- Put the card in the card case or the storage bag after use and when storing or carrying the card.
- Do not allow dirt, dust, or water to get into the terminals on the back of the card and do not touch the terminals with your fingers.

Notice for when transferring to another party, or disposing of the memory card

- "Format" or "delete" using the camera or a PC will only modify the file management information, it will not erase the data in the memory card completely.

It is recommended to physically destroy the memory card or use the commercially available computer data deletion software to completely erase the data in the memory card before transferring to another party or disposing.

Management of data in the memory card is the responsibility of the user.

About the personal information

If a name or birthday is set for [Profile Setup]/Face Recognition function, this personal information is kept in the camera and recorded in the image.

Disclaimer

- Information including personal information may be altered or vanish due to erroneous operation, effect of static electricity, accident, malfunction, repair, or other handlings.

Please note in advance that Panasonic is not liable in any way for any direct or indirect damage from the alteration or vanishing of information or personal information.

When requesting a repair, transferring to another party, or disposing.

- Reset the settings to protect the personal information. (P76)
- Remove the memory card from the camera when requesting a repair.
- Settings may return to factory default when camera is repaired.
- Please contact the dealer where you purchased the camera or your nearest Service Center if above operations are not possible due to malfunction.

When transferring to another party, or disposing of the memory card, please refer to "Notice for when transferring to another party, or disposing of the memory card" above.

When not using the camera for a long period of time

- Store the battery in a cool and dry place with a relatively stable temperature: [Recommended temperature: 15 °C to 25 °C (59 °F to 77 °F), Recommended humidity: 40%RH to 60%RH]
- Always remove the battery and the card from the camera.
- If the battery is left inserted in the camera, it will discharge even if the camera is turned off. If the battery continues to be left in the camera, it will discharge excessively and may become unusable even if charged.
- When storing the battery for a long period of time, we recommend charging it once a year. Remove the battery from the camera and store it again after it has completely discharged.
- We recommend storing the camera with a desiccant (silica gel) when you keep it in a closet or a cabinet.
- **Check all the parts before taking pictures when you have not used the camera for a long period of time.**

About the picture data

- Recorded data may be damaged or lost if the camera breaks down due to inappropriate handling. Panasonic will not be liable for any damage caused due to loss of recorded data.

About tripods or unipods

- When you use a tripod, make sure the tripod is stable when this unit is attached to it.
- You may not be able to remove the card or the battery when using a tripod or unipod.
- Make sure that the screw on the tripod or unipod is not at an angle when attaching or detaching the camera. You may damage the screw on the camera if you use excessive force when turning it. Also, the camera body and the rating label may be damaged or scratched if the camera is attached too tightly to the tripod or unipod.
- When using this unit with a large-diameter lens, the lens may come into contact with the pedestal depending on the tripod/unipod. Tightening the screw with the lens and pedestal in contact with each other may damage this unit or the lens. Therefore it is recommended to attach the tripod adaptor (DMW-TA1: optional) before mounting on the tripod/unipod.
- Read the operating instructions for the tripod or unipod carefully.

About the shoulder strap

- If you attach a heavy interchangeable lens (more than about 1 kg/35.3 oz) to the camera body, do not carry the camera by the shoulder strap. Hold the camera and the lens when carrying them.

Message Display

Confirmation messages or error messages will be displayed on the screen in some cases. The major messages are described below as examples.

[This picture is protected]

- Delete the picture after canceling the protect setting. (P188)

[This picture cannot be deleted]/[Some pictures cannot be deleted]

- This feature can only be used with pictures that comply with the DCF standard.
 - If you want to delete some pictures, format the card after saving necessary data on a PC etc. (P77)

[Cannot be set on this picture]

- [Title Edit], [Text Stamp] or [Print Set] cannot be set for pictures not based on the DCF standard.

[Memory Card Error Format this card?]

- It is a format that cannot be used with this unit.
 - Insert a different card.
 - Format the card again with the camera after saving necessary data on a PC etc. (P77) Data will be deleted.

[Lens not found, or shoot w/o lens in Custom menu is set to off.]

- When using a Leica lens mount adaptor (DMW-MA2M, DMW-MA3R: optional), set [Shoot w/o Lens] (P172) to [ON] in the custom menu.

[The lens is not attached properly. Do not push lens release button while lens is attached.]

- Detach the lens once, and then attach it again without pressing the lens release button. (P17) Turn this unit on again, and if it is still displaying, contact the dealer.

[Lens attachment failed. Please check connection for dirt.]

- Detach the lens from the camera body and gently wipe the contacts on the lens and the camera body using a dry cotton swab. Attach the lens, turn this unit on again, and if it is still displaying, contact the dealer.

[Lens not detected. Please turn camera on again.]

- This is displayed when the lens has stopped operating normally due to being pressed on by a hand etc.
 - Turn the camera off and on. If the message persists, contact the dealer or your nearest Service Center.

[Memory Card Error]/[Memory card parameter error]/[This memory card cannot be used]

- Use a card compatible with this unit. (P27)
- SD Memory Card (8 MB to 2 GB)
- SDHC Memory Card (4 GB to 32 GB)
- SDXC Memory Card (48 GB, 64 GB)

[Insert SD card again]/[Try another card]

- An error has occurred accessing the card.
 - Insert the card again.
 - Insert a different card.

**[Read Error/Write Error
Please check the card]**

- It has failed to read or write data.
 - Remove the card after turning this unit off. Insert the card again, turn this unit on, and try to read or write the data again.
- The card may be broken.
 - Insert a different card.

[Cannot record due to incompatible format(NTSC/PAL) data on this card.]

- If you want to delete some pictures, format the card after saving necessary data on a PC etc. (P77)
- Insert a different card.

[Motion recording was cancelled due to the limitation of the writing speed of the card]

- Use a card with SD Speed Class with "Class 4" or higher when recording motion pictures.
- In the event that it stops even after using a "Class 4" card or higher, the data writing speed has deteriorated so it is recommended to make a backup and then format (P77).
- Depending on the type of the card, motion picture recording may stop in the middle.

[A folder cannot be created]

- A folder cannot be created because there are no remaining folder numbers that can be used.
 - Format the card after saving necessary data on a PC etc. (P77) If you execute [No.Reset] in the [Setup] menu after formatting, the folder number is reset to 100. (P76)

[Picture is displayed for 16:9 TV]/[Picture is displayed for 4:3 TV]

- Select [TV Aspect] in the [Setup] menu if you want to change the TV aspect. (P74)
- This message also appears when the USB connection cable is connected to the camera only.
In this case, connect the other end of the USB connection cable to a PC or a printer. (P198, 202)

[Editing operation cannot proceed as information processing is ongoing.]

When a card with pictures deleted or file names changed using a PC or other device is inserted into this unit, it will automatically retrieve new information and reconstruct the burst groups. The currently retrieving information icon [] may be displayed in the playback screen for long period of time when there are many image files, and deletion or [Playback] menu cannot be used during this time.

- If you turn this unit off while information is being retrieved, the pictures for which information was retrieved up to that point will be saved as a burst group. When you switch on again, the information retrieval will restart from the same point.

[This battery cannot be used]

- Use a genuine Panasonic battery. If this message is displayed even when a genuine Panasonic battery is used, contact the dealer or your nearest Service Center.
- If the battery terminal is dirty, clean it and remove any objects.

Troubleshooting

First, try out the following procedures (P221–231).

If the problem is not resolved, it may be improved by selecting [Reset] (P76) on the [Setup] menu.

Battery and power source

**The camera cannot be operated even when it is turned on.
The camera turns off immediately after it is turned on.**

- The battery is exhausted.
- Charge the battery.
- If you leave the camera on, the battery will be exhausted.
 - Turn the camera off frequently by using the [Economy] etc. (P73)

This unit is turned off automatically.

- If you connect to a TV compatible with VIERA Link with a HDMI mini cable (optional) and turn the TV off with the remote control for the TV, this unit is also turned off.
 - If you are not using VIERA Link, set [VIERA Link] to [OFF]. (P75)

Card/battery door does not close.

- Insert the battery securely all the way in. (P26)

Recording

**Taking pictures is not possible.
The shutter will not operate immediately when the shutter button is pressed.**

- Is the subject focused?
 - [Focus Priority] is set to [ON] at the time of purchase, and so you cannot take pictures until the subject is in focus. If you want to be able to take a picture when you press the shutter button fully even if the subject is not focused, set [Focus Priority] in the [Custom] menu to [OFF]. (P167)

The recorded picture is whitish.

- Picture might look whitish when lens or image sensor gets dirty with fingerprints or similar.
 - If the lens is dirty turn the camera off and then gently wipe the lens surface with a soft, dry cloth.
 - Refer to P213 when the image sensor gets dirty.

The recorded picture is too bright or dark.

- Check that the exposure is correctly compensated. (P88)
- Is the AE Lock (P104) applied incorrectly?

Multiple pictures are taken at one time.

- Cancel the settings of White Balance Bracket (P110).
- Is the Burst (P89) or Auto Bracket (P91) set?
 - Set the drive mode to Single. (P38)
- Is the self-timer (P93) set to ?

The subject is not focused properly.

- The subject is beyond the focus range of the camera. (P37)
- There is camera shake (jitter) or the subject is moving slightly. (P78)
- Is [Focus Priority] in the [Custom] menu set to [OFF]? (P167)
 - In this case, the picture may not be properly focused even if [AFS], [AFF] or [AFC] in [Focus Mode] is set.
- Is the AF Lock (P104) applied incorrectly?

The recorded picture is blurred. The Optical Image Stabilizer is not effective.

- The shutter speed will become slower and the Optical Image Stabilizer function may not work properly when taking pictures especially in dark places.
 - We recommend holding the camera firmly with both hands when taking pictures. (P33)
 - We recommend using a tripod and the self-timer (P93) when taking pictures with a slow shutter speed.
- Are you using a lens which supports the stabilizer function? (P16)

Taking pictures using White Balance Bracket is not possible.

- Is there any memory remaining on the card?

The recorded picture looks rough.**Noise appears on the picture.**

- Is the ISO sensitivity high or the shutter speed slow?
 - ([Sensitivity] is set to [AUTO] when the camera is shipped. Therefore, when taking pictures indoors etc. noise will appear.)
 - Decrease the ISO sensitivity. (P111)
 - Increase the setting for [Noise Reduction] in [Photo Style] or lower the setting for each of the items other than [Noise Reduction]. (P148)
 - Take pictures in bright places.
 - Set the [Long Shtr NR] to [ON]. (P155)
- Is the [Picture Size] (P149) or the [Quality] (P150) set low?
- Is the [Digital Zoom] set? (P80)

Striping or flicker may appear under lighting such as fluorescent lighting and LED lighting fixture.

- This is characteristic of MOS sensors which serve as the camera's pickup sensors.
This is not a malfunction.
- When you see noticeable flicker or striping while recording a motion picture, you can reduce the flicker or striping by setting up [Flkr Decrease] (P162) and fixing the shutter speed. It is possible to select a shutter speed from [1/50], [1/60], [1/100], or [1/120].



The brightness or the hue of the recorded picture is different from the actual scene.

- When recording under fluorescent or LED lighting fixture, etc., increasing the shutter speed may introduce slight changes to brightness and color. These are a result of the characteristics of the light source and do not indicate a malfunction.
- When recording subjects in extremely bright locations or recording under fluorescent lighting, LED lighting fixture, mercury lamp, sodium lighting, etc., the colors and screen brightness may change or horizontal striping may appear on the screen.

Bright spot not in subject is recorded.

- There may be defective pixels in the image sensor. Perform [Pixel Refresh] (P77).

You cannot compensate the exposure.

- Are you in Exposure Compensation operation?
→ Press the rear dial to switch to Exposure Compensation operation. (P88)

The function lever does not work.

- Set the [Function Lever] to [AUTO]. (P15)

Subject cannot be locked. (AF tracking not possible)

- If the subject contains sections that differ in color to the surroundings, touch those sections or the main colors of the subject to set the AF frame (P97).

Operation sound is small.

- Is your finger covering up the speaker? (P10)

Motion pictures

Recording motion pictures is not possible.

- You may not be able to record for a short while after turning this unit on when using a large capacity card.

Motion picture recording stops in the middle.

- Use a card with SD Speed Class with “Class 4” or higher when recording motion pictures.
- Depending on the type of the card, recording may stop in the middle.
 - If motion picture recording stops during use of a card of at least “Class 4” or if you use a card on which recording and deleting have been repeated many times, or a card that has been formatted on a PC or other equipment, the data-writing speed is lower. In such cases, we recommend that you make a backup of the data and then format (P77) the card in this unit.

When recording a motion picture, the screen may go dark.

- When recording a motion picture, the screen may go dark after a certain period to reduce battery consumption, but this will not affect the recorded motion picture.

The screen may be blacked out momentarily, or the unit may record noise.

- The screen may be blacked out momentarily, or the unit may record noise due to static electricity or electromagnetic waves etc. depending on the environment of the motion picture recording.

Object seems to be warped.

- Object seems to be warped slightly when the object moves across the image very fast, but this is because the unit is using MOS for the image sensor. This is not a malfunction.

In motion pictures, abnormal clicking and buzzing sounds are recorded. The recorded sound is very quiet.

- With recording in a quiet environment, depending on the lenses used, the sound of aperture and focus actions may be recorded in motion pictures. This is not a malfunction. Focus operation while recording motion pictures can be set to [OFF] with [Continuous AF] (P52).
- Be careful while recording motion pictures because the sounds of the zoom operations, buttons and dial operation etc. may be recorded.
- While recording motion pictures, plugging the aperture of the microphone with a finger may reduce the level of audio recording or audio may not record at all. Also be careful because the operation sound of lenses can easily be recorded at this time.

Lens

Recorded image may be warped, or nonexistent color is surrounding the subject.

- Depending on the lens used, picture may be warped slightly or you may see colors along the edge depending on the zoom factor, due to the characteristics of the lens. Also, the peripherals of the image might look warped because the perspective is enhanced when the wide angle is used. This is not a malfunction.

When the lens is attached to another digital camera, stabilizer function cannot be turned off or stabilizer function does not work.

- The Optical Image stabilizer function of the interchangeable lens (H-PS14042, H-FS014042, H-FS45150) only works correctly with supported cameras.
 - When older Panasonic digital cameras (DMC-GF1, DMC-GH1, DMC-G1) are used, [Stabilizer] in the [Rec] menu (P78) cannot be set to [OFF]. It is recommended to update the firmware of the digital camera at the following website.
<http://panasonic.jp/support/global/cs/dsc/download/>
 - When using this lens with another make of digital cameras, the Optical Image Stabilizer function will not work. (As of August 2012)
 For details, contact the respective company.

Flash

The flash is not activated.

- Is the flash closed?
 - Slide the [ OPEN] lever to open the flash. (P84)

The flash is activated 2 times.

- The flash is activated 2 times. The interval between the first and second flash is longer when Red-Eye Reduction (P84) is set so the subject should not move until the second flash is activated.

LCD monitor/Viewfinder

The LCD monitor turns off although the camera is turned on.

- The LCD monitor turns off when [Auto LCD Off] (P73) is selected for the [Economy] Mode. [This does not happen when using the AC adaptor (optional).]
- It will switch to viewfinder display if there is hand or object near the eye sensor. (P34)

The LCD monitor/Viewfinder is too bright or dark.

- Check [LCD Mode] setting. (P72)
- Perform [LCD Display]/[Viewfinder]. (P72)

It may flicker for an instant or the brightness of the screen may change significantly for an instant.

- This occurs due to the aperture of the lens changing when the shutter button is pressed halfway, or when the brightness of the subject changes. This is not a malfunction.

The picture is not displayed on the LCD monitor.

- Does the picture appear on the viewfinder?
→ Press [LVF/LCD] to switch to LCD monitor display. (P34)
- Is the LCD monitor switched off?
→ Switch the display by pressing [DISP.]. (P40)

LCD monitor and viewfinder do not switch when [LVF/LCD] is pressed.

- It is only displayed on the LCD monitor when the camera is connected to a PC or printer.

Black, red, blue and green dots appear on the LCD monitor.

- This is not a malfunction.
These pixels do not affect the recorded pictures.

Noise appears on the LCD monitor.

- In dark places, noise may appear to maintain the brightness of the LCD monitor.

You see red, green, or blue flashes when you move your eyes in the viewfinder, or when the camera is moved rapidly.

- This is a characteristic of the drive system of the viewfinder of this unit, and it is not a malfunction. There will be no problem with the recorded image.

Playback

The picture being played back is not rotated, or is rotated in an unexpected direction, when displayed.

- You can display the pictures without being rotated when [Rotate Disp.] (P75) is set to [OFF].
- You can rotate pictures with the [Rotate] function. (P184)

The picture is not played back. There are no recorded pictures.

- Did you press [▶]?
- Is the card inserted?
- Is there a picture on the card?
- Is this a folder or picture which was processed in the PC? If it is, it cannot be played back by this unit.
→ It is recommended to use the "PHOTOfunSTUDIO" software in the CD-ROM (supplied) to write pictures from PC to card.
- Has [Playback Mode] been set for playback?
→ Change to [Normal Play]. (P177)

The folder number and the file number are displayed as [—] and the screen turns black.

- Is this a non-standard picture, a picture which has been edited using a PC or a picture which was taken by another make of digital camera?
- Did you remove the battery immediately after picture-taking or did you take the picture using a battery with a low remaining charge?
→ Format the data to delete the pictures mentioned above. (P77)
(Other pictures will be deleted as well and it will not be possible to restore them. Therefore, check well before formatting.)

Playback sound or operation sound is too low.

- Is something covering up the speaker? (P10)

Images with different date as recorded date are played back in the Calendar Playback.

- Is the clock in the camera set properly? (P29)
- Images edited on a PC or images recorded on other cameras might display a different date to the recorded date during the Calendar Playback.

White round spots like soap bubbles appear on the recorded picture.



- If you take a picture with the flash in a dark place or indoors, white round spots may appear on the picture caused by the flash reflecting of particles of dust in the air. This is not a malfunction.

A characteristic of this is that the number of round spots and their position differ in every picture.

**[Thumbnail is displayed] appears on the screen.**

- Is it a picture that has been recorded with other equipment? In such cases, these pictures may be displayed with a deteriorated picture quality.

Red part of the recorded image has changed color to black.

- When Digital Red-Eye Correction ([, []) is in operation, if you take a picture of a subject with red color surrounded by a skin tone color, that red part may be corrected to black by the Digital Red-Eye Correction function.

→ It is recommended to take a pictures with the flash closed, Flash Mode set to [, or [Red-Eye Removal] set to [OFF]. (P152)

Motion pictures recorded with this model cannot be played back on other equipment.

- Motion pictures recorded in [AVCHD] or [MP4] may be played back with poor picture or sound quality or playback may not be possible even when played back with equipment compatible with these formats. Also, the recording information may not be displayed properly.

TV, PC and printer**The picture does not appear on the television.**

- Is the camera connected to the TV correctly?
→ Set the TV input to external input mode.

The display areas on the TV screen and the camera's LCD monitor are different.

- Depending on the TV model, the pictures may be extended horizontally or vertically or they may be displayed with their edges cut off.

The motion pictures cannot be played back on a TV.

- Are you trying to play back the motion pictures by directly inserting the card in the card slot of the TV?
→ Connect the camera to the TV with the AV cable (optional), or with the HDMI mini cable (optional), and then play back the motion pictures on the camera. (P193)

The picture is not displayed fully on the TV.

→ Check [TV Aspect] setting. (P74)

VIERA Link does not work.

- Is it connected properly with the HDMI mini cable (optional)? (P193)
 - Confirm that the HDMI mini cable (optional) is firmly fitted.
 - Press [▶] on this unit.
- Is the [VIERA Link] on this unit set to [ON]? (P75)
 - Depending on HDMI terminal of the TV, the input channel may not switch automatically. In this case, use the remote control for the TV to switch input. (For details on how to switch input, please read the operating instructions for the TV.)
 - Check the VIERA Link setting on the connected device.
 - Turn this unit off and on.
 - Set [HDAVI Control] to [Off] on the TV and then turn it back to [On]. (Refer to the operating instructions of the TV for details.)

Cannot communicate with the PC.

- Is the camera connected to the PC correctly?
- Is the camera recognized by the PC correctly?
 - Set to [PC] in [USB Mode]. (P73, 198)
 - Turn this unit off and on.

The card is not recognized by the PC.

- Disconnect the USB connection cable. Connect it again while the card is inserted in the camera.
- If there are two or more USB terminal on a single PC, try connecting the USB connection cable to another USB terminal.

The card is not recognized by the PC. (SDXC memory card is used)

- Check if your PC is compatible with SDXC memory cards.
<http://panasonic.net/avc/sdcard/information/SDXC.html>
- A message prompting to format the card may be displayed when connecting, but do not format.
- If the [Access] displayed on the LCD monitor does not disappear, disconnect the USB connection cable after turning this unit off.

The picture cannot be printed when the camera is connected to a printer.

- Pictures cannot be printed using a printer that does not support PictBridge.
→ Set to [PictBridge(PTP)] in [USB Mode]. (P73, 202)

The ends of the pictures are cut at printing.

- When using a printer with a Cropping or borderless printing function, cancel this function before printing. (For details, refer to the operating instructions for the printer.)
- When you order photo studios to print pictures, ask the photo studio if the 16:9 pictures can be printed.



Others**The camera makes a noise when this unit is turned on.**

- This is the noise of the Dust Reduction Function working (P213); it is not a malfunction.

There is a sound from lens unit.

- It is a sound of lens movement or aperture operation when this unit is turned on or off, and it is not a malfunction.
- You may hear a sound from the lens and image in the LCD monitor may suddenly change when the brightness has changed by zoom operation or moving the camera, but there is no effect on recording.
The sound is caused by the automatic adjustment of the aperture. This is not a malfunction.

An unreadable language was selected by mistake.

- Press [MENU/SET], select the [Setup] menu icon [] and then select the [] icon to set the desired language. (P76)

Part of the picture is flashing in black and white.

- This is a highlight function showing the white saturated area. (P165)

A red lamp sometimes turns on when the shutter button is pressed halfway.

- In dark places, the AF Assist Lamp (P168) lights red to make it easier to focus on a subject.

The AF Assist Lamp does not turn on.

- Is [AF Assist Lamp] set to [ON]? (P168)
- The AF Assist Lamp does not turn on in bright places.

The camera becomes warm.

- The surface of the camera and the reverse side of the LCD monitor may become warm during use. This does not affect the performance or quality of the camera.

The clock is reset.

- If you do not use the camera for a long time, the clock may be reset.
→ [Please set the clock] message will be displayed; please reset the clock. (P29)

The file numbers are not recorded consecutively.

- When you perform an operation after taking a certain action, the pictures may be recorded in folders with different numbers from the ones used prior to the operation.

The file numbers are recorded with previously used numbers.

- If you insert or remove the battery before turning off this unit, the folder and file numbers for the pictures taken will not be stored in the memory. When this unit is turned on again and pictures are taken, they may be stored under file numbers which should have been assigned to previous pictures.

- G MICRO SYSTEM is a lens exchange type digital camera system of LUMIX based on a Micro Four Thirds System standard.
- Micro Four Thirds™ and Micro Four Thirds Logo marks are trademarks or registered trademarks of Olympus Imaging Corporation, in Japan, the United States, the European Union and other countries.
- Four Thirds™ and Four Thirds Logo marks are trademarks or registered trademarks of Olympus Imaging Corporation, in Japan, the United States, the European Union and other countries.
- SDXC Logo is a trademark of SD-3C, LLC.
- “AVCHD”, “AVCHD Progressive” and the “AVCHD Progressive” logo are trademarks of Panasonic Corporation and Sony Corporation.
- Manufactured under license from Dolby Laboratories. Dolby and the double-D symbol are trademarks of Dolby Laboratories.
- HDMI, the HDMI Logo, and High-Definition Multimedia Interface are trademarks or registered trademarks of HDMI Licensing LLC in the United States and other countries.
- HDAVI Control™ is a trademark of Panasonic Corporation.
- QuickTime and the QuickTime logo are trademarks or registered trademarks of Apple Inc., used under license therefrom.
- Adobe is a trademark or registered trademark of Adobe Systems Incorporated in the United States and/or other countries.
- iMovie, Mac and Mac OS are trademarks of Apple Inc., registered in the U.S. and other countries.
- Windows and Windows Vista are either registered trademarks or trademarks of Microsoft Corporation in the United States and/or other countries.
- This product uses “DynaFont” from DynaComware Corporation. DynaFont is a registered trademark of DynaComware Taiwan Inc.
- Other names of systems and products mentioned in these instructions are usually the registered trademarks or trademarks of the manufacturers who developed the system or product concerned.

AVCHD™
Progressive

DOLBY
DIGITAL

HDMI



This product is licensed under the AVC patent portfolio license for the personal and non-commercial use of a consumer to (i) encode video in compliance with the AVC Standard (“AVC Video”) and/or (ii) decode AVC Video that was encoded by a consumer engaged in a personal and non-commercial activity and/or was obtained from a video provider licensed to provide AVC Video. No license is granted or shall be implied for any other use. Additional information may be obtained from MPEG LA, LLC. See <http://www.mpegla.com>.