

Panasonic®

Operating Instructions **Vol.2**

Memory Card Camera-Recorder

Model No. **AG-AC90P**
AG-AC90PJ
AG-AC90PX



Register now!!

This product is eligible for the AVCCAM 3 Year Warranty Repair Program.
For details, see operating instructions Vol. 1.

http://panasonic.biz/sav/pass_e/

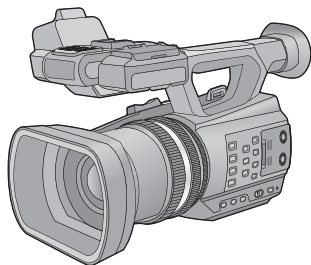

Vol.2

This document explains in detail how to operate this device. Concerning basic operation, please refer to the enclosed "Operating Instructions Vol.1" (printed document).

Please read these instructions carefully before using this product, and save this manual for future use.

AVCCAM

AVCHD™
Progressive

HDMI

SD™
XC

DOLBY
DIGITAL
5.1 CREATOR

ENGLISH

Read this first

■ About the recording format for recording motion pictures

You can record motion pictures with AVCHD recording formats using this unit. (→ 30, 89)

- AVCHD Progressive (1080/60p) supported.

AVCHD Progressive:

It is possible to record video with highest quality (1080/60p) possible with this unit.

■ Indemnity about recorded content

Panasonic does not accept any responsibility for damages directly or indirectly due to any type of problems that result in loss of recording or edited content, and does not guarantee any content if recording or editing does not work properly. Likewise, the above also applies in a case where any type of repair is made to the unit.

■ About Condensation (When the lens or the LCD monitor is fogged up)

Condensation occurs when there is a change in temperature or humidity, such as when the unit is taken from outside or a cold room to a warm room. Please be careful, as it may cause the lens or LCD monitor to become soiled, moldy, or damaged.

When taking the unit to a place which has a different temperature, if the unit is accustomed to the room temperature of the destination for about one hour, condensation can be prevented. (When the difference in temperature is severe, place the unit in a plastic bag or the like, remove air from the bag, and seal the bag.) When condensation has occurred, remove the battery and/or the AC adapter and leave the unit like that for about one hour. When the unit becomes accustomed to the surrounding temperature, foginess will disappear naturally.

■ Caution regarding laser beams



The lens may suffer damage if struck by a laser beam. Make sure that laser beams do not strike the lens when shooting in an environment where laser devices are used.

■ Cards that you can use with this unit

SD Memory Card, SDHC Memory Card and SDXC Memory Card

- 4 GB or more Memory Cards that do not have the SDHC logo or 48 GB or more Memory Cards that do not have the SDXC logo are not based on SD Memory Card Specifications.
- Refer to page 16 for more details on SD cards.

■ For the purposes of these operating instructions

- The battery pack is referred to as the "Battery".
- SD Memory Card, SDHC Memory Card and SDXC Memory Card are referred to as the "SD card".
- Function that can be used for Recording Mode: 
- Function that can be used for Playback Mode: 
- Pages for reference are indicated by an arrow, for example: → 00

Contents

Read this first	2
-----------------------	---

Preparation

Names and Functions of Main Parts	5
Power supply	11
Charging the battery	12
Inserting/removing the battery	13
Charging and recording time	14
Connecting to the AC outlet.....	15
Preparation of SD cards	16
Cards that you can use with this unit	16
Inserting/removing an SD card	17
Turning the unit on/off	18
Selecting a mode	18
Using the LCD monitor/Viewfinder	19
Using the LCD monitor	19
How to use the touch screen	20
LCD monitor adjustment.....	20
Viewfinder adjustment	21
Recording yourself.....	22
Setting date and time	23
Using the menu screen	24
Using with the wireless remote control	25
Operation of direction buttons/	
OK button	26

Recording

Before recording	27
Formatting cards.....	28
Selecting a media to record	29
Recording motion pictures	30
Recording still pictures	31
Intelligent Auto Mode/Manual Mode	33
Using the zoom	35
Ring zoom	35
Image Stabilizer Function	37
Focus	38
White Balance	40
Iris adjustment	42
Manual shutter speed	44
Audio Input	45
Microphone setup	45
Switching Audio Input	46
Adjusting the audio input level.....	49
Counter display	51

Setting the Time Code	52
Setting the User Information	53
Setting the Recording Counter.....	54

USER button	55
Setting the USER button.....	55
Using the USER button	56
Functions of the USER button	57
Useful functions	61
Quick Start	61
Zebra.....	62
Color Bar Screen	62
Switching the screen indications/ mode information display	63
Using of Operation Icons	64

Playback

Motion picture/Still picture playback	65
Motion picture playback using operation icon	68
Useful functions	70
Creating still picture from motion picture	70
Repeat Playback.....	70
Resuming the previous playback	71
Playback scenes by the selected format	71
Playing back still pictures by date	72
Deleting scenes/still pictures	73
Protecting scenes/still pictures.....	74
Watching Video/Pictures on your TV	75
Connecting with a HDMI cable.....	78
Listening in 5.1 channel sound	78
Connecting with the AV multi cable.....	78

Editing

Connecting to a PC (File transfer/nonlinear editing)	79
Operating environment (mass storage).....	79
Connecting to a PC.....	81
About the PC display	82
Dubbing	83
Dubbing with a Blu-ray disc recorder	83

Menu

Using the Menu	84
Camera Setup	84
Recording Setup	89
Switch and display setting	95
Other Functions	100
Video Setup	104
Picture Setup	104

Display

Indications	105
Messages	107

Others

Troubleshooting	107
About recovery	111
Updating the firmware incorporated into the unit	111
Cautions for use	112
About copyright	116
Recording modes/ approximate recordable time	117
Approximate number of recordable pictures	118

Names and Functions of Main Parts

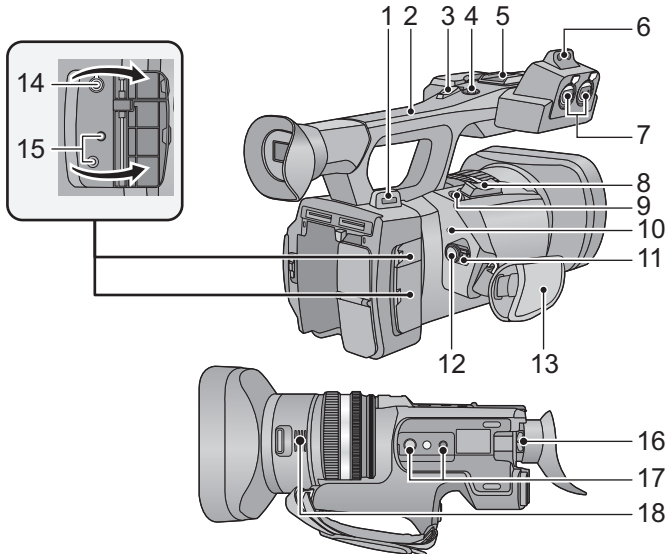

1 Shoulder strap fixture (→ 8)

2 Handle

3 Sub zoom lever (→ 35, 99)

- This lever functions in the same manner as the zoom lever.

4 Sub recording start/stop button (→ 27, 99)

- This button functions in the same manner as the recording start/stop button.

5 Accessory shoe

6 Microphone holder attachment part (→ 9)

7 Audio input terminals 1, 2 (XLR 3 pin) [AUDIO INPUT1, 2] (→ 10, 47)

8 Zoom lever [T/W] (In Recording Mode) (→ 35)

Volume lever [+VOL-]/Thumbnail display switch [Q / 

9 Photoshot button [] (→ 31)

10 Status indicator (→ 18)

11 Power switch (→ 18)

12 Recording start/stop button (→ 30)

13 Grip belt (→ 8)

14 Headphone terminal [] (→ 64)

15 Camera remote jack [CAM REMOTE] [CAM REMOTE] (3.5 mm (0.14 ") mini jack)

It is possible to adjust the focus or iris connecting with the remote control (optional).

- It is not possible to use the remote control (optional) in the Intelligent Auto Mode.

[ZOOM S/S] (2.5 mm (0.1 ") super mini jack)

It is possible to operate zoom operation or recording start/stop connecting with the remote control (optional).

- Do not connect any equipment except the remote control (optional) to the camera remote jack. Brightness of the image may change or it may not focus when an equipment other than the remote control (optional) is connected.

16 Eyepiece corrector lever (→ 21)

17 Tripod receptacle (→ 9)

18 Inlet (cooling fan) (→ 28)

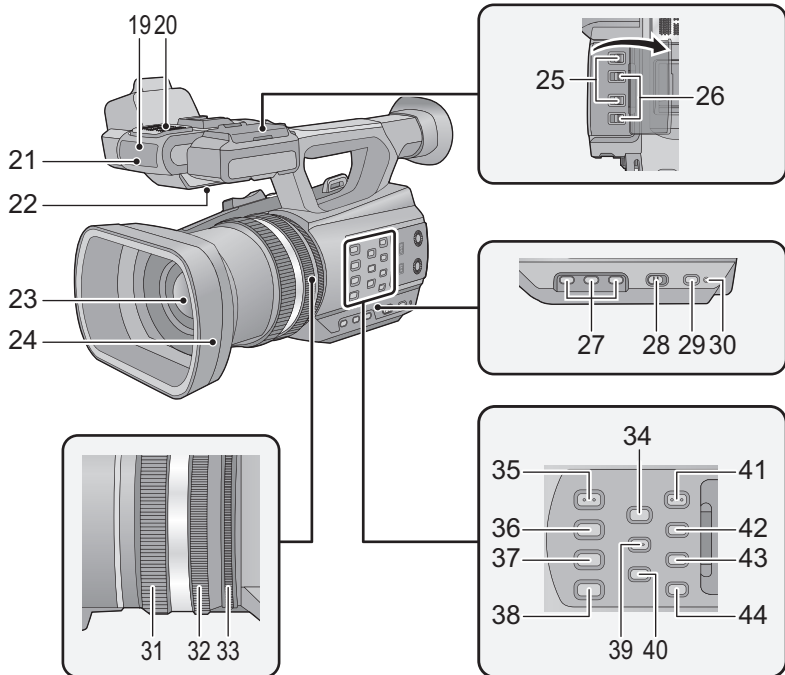

- 19 Wireless remote control sensor (→ 26)
- 20 Internal microphones
- 21 Recording lamp (→ 100)
- 22 Speaker
- 23 Lens (→ 10)
- 24 Lens hood
- 25 INPUT 1, 2 (LINE/MIC) switches (→ 47)
- 26 INPUT 1, 2 (+48V) switches (→ 47)
- 27 User 1, 2, 3 buttons [USER1, USER2, USER3] (→ 55)
- 28 Intelligent auto/Manual switch [i/MANU] (→ 33)
- 29 Quick start button [QUICK START] (→ 61)
- 30 Quick start lamp (→ 61)
- 31 Focus ring (→ 38)
- 32 Zoom ring (→ 35)
- 33 Iris ring (→ 42)
- 34 Focus assist button [FOCUS ASSIST] (→ 39)
- 35 Iris auto/Manual button [IRIS A/M] (→ 42)
- 36 Focus auto/Manual/∞ button [FOCUS A/M/∞] (→ 38)
- 37 Optical image stabilizer button [O.I.S.] (→ 37)
- 38 White balance button [W.B.] (→ 40)
- 39 Zebra button [ZEBRA] (→ 62)
- 40 Color Bar Screen button [BARS] (→ 62)
- 41 Menu button [MENU] (→ 24)
- 42 Display/Mode check button [DISP/MODE CHK] (→ 56, 63)
- 43 Counter button [COUNTER] (→ 51)
- 44 Counter reset button [RESET] (→ 53, 54)

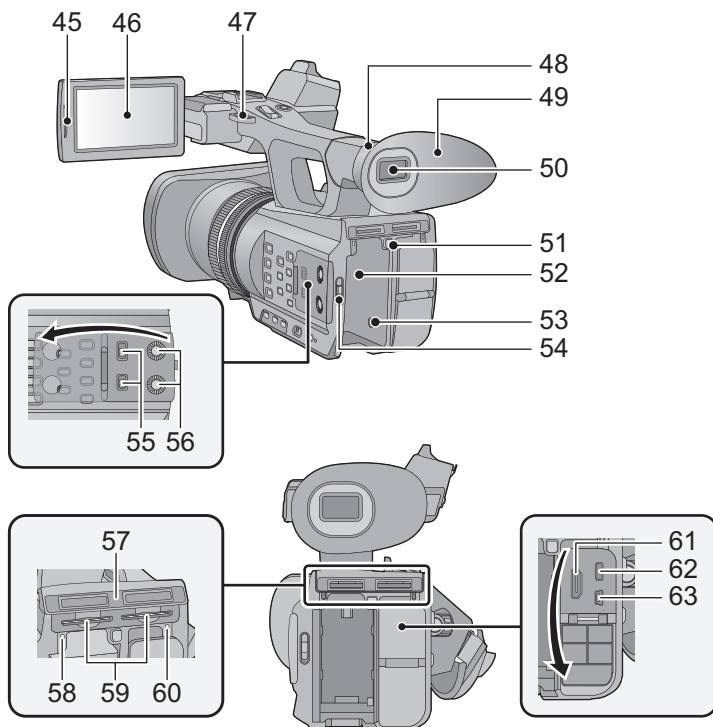

- 45** LCD monitor extract part [PULL] (→ 19)
- 46** LCD monitor (Touch screen) (→ 20)
- 47** Shoulder strap fixture (→ 8)
- 48** Eye cup attachment part (→ 8)
- 49** Eye cup (→ 8)
- 50** Viewfinder (→ 21)
- 51** Battery release button [PUSH] (→ 13)
- 52** Battery holder (→ 13)
- 53** DC input terminal [DC IN] (→ 15)
- Do not use any other AC adaptors except the supplied one.
- 54** Mode switch (→ 18)
- 55** CH1, CH2 switches [CH1, CH2] (→ 47)
- 56** Audio control knobs [CH1, CH2] (→ 50)
- 57** SD Card slot cover (→ 17)
- 58** Access lamp (card 1) (→ 17)
- 59** Card slot 1 (left)
Card slot 2 (right) (→ 17)
- 60** Access lamp (card 2) (→ 17)
- 61** HDMI connector [HDMI] (→ 75)
- 62** AV multi connector [AV MULTI] (→ 75)
- Use the AV multi cable (only the supplied cable).
- 63** USB terminal [USB 2.0] (→ 81)

■ Attaching the microphone holder

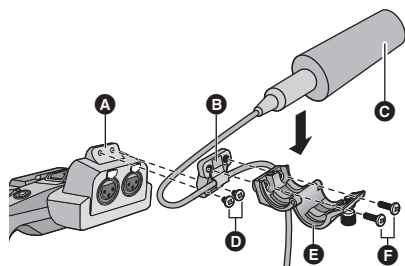

- A** Microphone holder attachment part
- B** Microphone holder adaptor
- C** External microphone (optional)
- D** Microphone holder screws (6 mm)
(0.24 ")
- E** Microphone holder
- F** Microphone holder screws (12 mm)
(0.47 ")

- Attach by using a commercially available screw driver.
- When attaching an external microphone (optional) to the microphone holder attachment part, use the supplied microphone holder and microphone holder adaptor.
- The microphone holder is set up so that a 21 mm (0.83 ") external microphone (AG-MC200G: optional) can be attached. Check in advance whether the microphone you wish to use can be attached.
- When attaching the microphone holder and the microphone holder adaptor, be sure to tighten the screws firmly even though you might hear a squeaking sound.
- When wiring the microphone cable, use the cable clumper of the microphone holder adaptor.

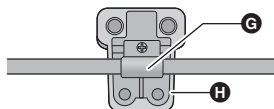

- G** Cable clumper
- H** Microphone holder adaptor

■ Attaching the tripod

- There are tripod mounting holes that are compatible with 1/4-20UNC and 3/8-16UNC screws. Use the size that matches the diameter of the tripod's fixing screw.
- If you attach a tripod which has 5.5 mm (0.22 ") screw or larger, it may damage this unit.

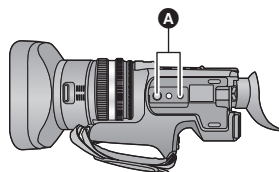

- A** Tripod receptacle

■ Attaching the lens cap

Protect the lens surface with the lens cap while the unit is not used.

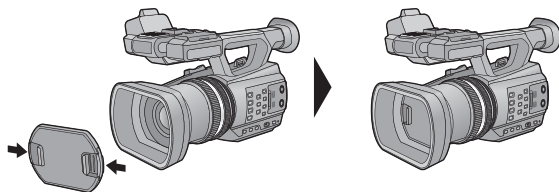

Attach or remove it by pinching on it.

■ Attaching the INPUT terminal cap

Attach the INPUT terminal cap while the audio input terminals 1, 2 (XLR 3 pin) is not used.

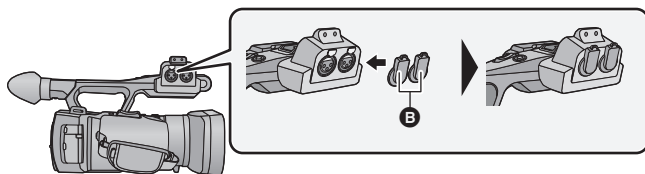

B INPUT terminal cap

Power supply

■ About batteries that you can use with this unit

(AG-AC90P/PJ)

The battery that can be used with this unit is CGA-D54.

(AG-AC90PX)

The battery that can be used with this unit is CGA-D54s.

It has been found that counterfeit battery packs which look very similar to the genuine product are made available to purchase in some markets. Some of these battery packs are not adequately protected with internal protection to meet the requirements of appropriate safety standards. There is a possibility that these battery packs may lead to fire or explosion. Please be advised that we are not liable for any accident or failure occurring as a result of use of a counterfeit battery pack. To ensure that safe products are used we would recommend that a genuine Panasonic battery pack is used.

Charging the battery

When this unit is purchased, the battery is not charged. Charge the battery fully before using this unit for the first time.

Important:

- Do not use the AC cable with any other equipment as it is designed only for this unit. Also, do not use the AC cable from other equipment with this unit.
- It is recommended to charge the battery in a temperature between 10 °C and 30 °C (50 °F to 86 °F).
(The battery temperature should also be the same.)

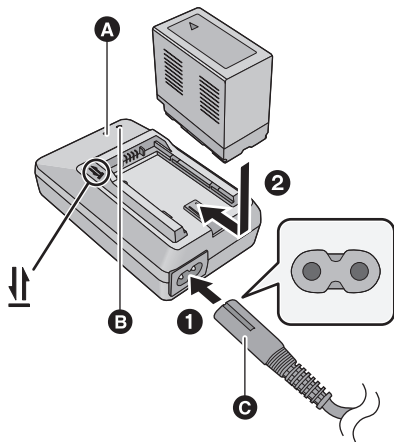

Charging lamp [CHARGE] **A**

Lights up:

Charging (Battery charging time: → 14)

Goes off:

Charging completed

Flashing:

Be sure to connect the unit correctly (→ 114)

Power lamp **B**

- This will light up when the AC cable is connected.

- **C** AG-AC90P/PJ: AC cable (K2CA2CA00025; supplied)
AG-AC90PX: AC cable (K2CA2YY00129; supplied)

- Insert the plugs as far as they will go.

1 Connect the AC cable to the battery charger and the AC outlet.

(AG-AC90P/PJ only)

- Use the AC cable (K2CA2CA00025; supplied) dedicated for the battery charger.

2 Insert the battery into the battery charger by aligning the arrows.

- We recommend using Panasonic batteries (→ 14).
- If you use other batteries, we cannot guarantee the quality of this product.
- Do not heat or expose to flame.
- Do not leave the battery(ies) in a car exposed to direct sunlight for a long period of time with doors and windows closed.

Inserting/removing the battery

Install the battery by inserting it in the direction shown in the figure.

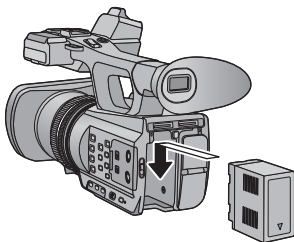

Insert the battery until it clicks and locks.

Removing the battery

Make sure that the power switch is set to OFF and the status indicator is turned off, and then remove by holding onto it taking care not to drop. (→ 18)

While pressing the battery release button, remove the battery.

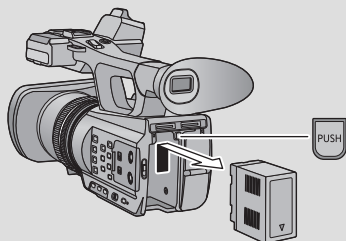

Charging and recording time

■ Charging/Recording time



- Temperature: 25 °C (77 °F)/humidity: 60%RH
- When using the viewfinder (times in parentheses are when using the LCD monitor)

Battery model number [Voltage/Capacity (minimum)]	Charging time	Recording format	Maximum continuously recordable time	Actual recordable time
Supplied battery/ CGA-D54 and CGA-D54s (optional) [7.2 V/5400 mAh]	6 h	PS 1080/60p	6 h 25 min (5 h 45 min)	4 h (3 h 35 min)
		PH 1080/60i	6 h 45 min (6 h)	4 h 10 min (3 h 40 min)
		PH 1080/30p	6 h 50 min (6 h 5 min)	4 h 15 min (3 h 45 min)
		PH 1080/24p	7 h 10 min (6 h 20 min)	4 h 25 min (3 h 55 min)
		HA 1080/60i	6 h 45 min (6 h)	4 h 10 min (3 h 45 min)
		HE 1080/60i	6 h 55 min (6 h 5 min)	4 h 15 min (3 h 45 min)
		SA 480/60i	7 h 5 min (6 h 15 min)	4 h 20 min (3 h 50 min)

- These times are approximations.
- **The indicated charging time is for when the battery has been discharged completely. Charging time and recordable time vary depending on the usage conditions such as high/low temperature.**

- The actual recordable time refers to the recordable time when repeatedly starting/stopping recording, turning the unit on/off, moving the zoom lever etc.
- The batteries heat up after use or charging. This is not a malfunction.

Battery capacity indication

- The display changes as the battery capacity reduces.  →  will flash red.

Connecting to the AC outlet

The unit is in the standby condition when the AC adaptor is connected. The primary circuit is always "live" as long as the AC adaptor is connected to an electrical outlet.

Important:

- Use the supplied AC adaptor. Do not use the AC adaptor of another device.
- Do not use the AC cable with any other equipment as it is designed only for this unit. Also, do not use the AC cable from other equipment with this unit.

(AG-AC90P/PJ)

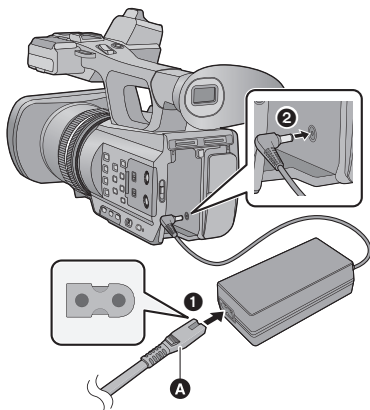

- A** AC cable (K2CB2CB00022; supplied)
• Insert the plugs as far as they will go.

(AG-AC90PX)

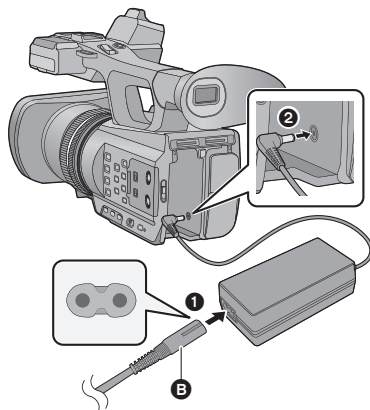

- B** AC cable (K2CA2YY00129; supplied)

1 Connect the AC cable to the AC adaptor and the AC outlet.

(AG-AC90P/PJ only)

- Use the AC cable (K2CB2CB00022; supplied) dedicated for the AC adaptor.

2 Connect the AC adaptor to the DC input terminal [DC IN].

■ Removing the AC adaptor

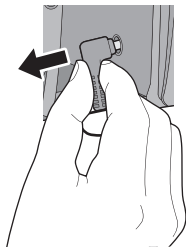

- Make sure to set the power switch to OFF and the status indicator is turned off when disconnecting the AC adaptor.

Preparation of SD cards

The unit can record motion pictures or still pictures to an SD card.

Cards that you can use with this unit

Use SD cards conforming to Class 4 or higher of the SD Speed Class Rating* for motion picture recording.

Card type	Capacity
SD Memory Card	512 MB/1 GB/2 GB
SDHC Memory Card	4 GB/6 GB/8 GB/12 GB/16 GB/24 GB/32 GB
SDXC Memory Card	48 GB/64 GB

* SD Speed Class Rating is the speed standard regarding continuous writing. Check e.g. via the label on the card, etc.



- Please check the latest information on the support website below.
<http://pro-av.panasonic.net>
- **When using an SDHC Memory Card/SDXC Memory Card with other equipment, check the equipment is compatible with these Memory Cards.**
- We do not guarantee the operation of SD cards other than the ones above. Further, SD cards with a capacity of less than 32 MB cannot be used for video recording.
- 4 GB or more Memory Cards that do not have the SDHC logo or 48 GB or more Memory Cards that do not have the SDXC logo are not based on SD Memory Card Specifications.
- When the write-protect switch **A** on SD card is locked, no recording, deletion or editing will be possible on the card.
- Keep the Memory Card out of reach of children to prevent swallowing.

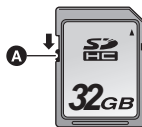

Inserting/removing an SD card

When using a non Panasonic SD card for the first time, or one which was previously used on another equipment, it is necessary to format the SD card. (→ 28) When the SD card is formatted, all of the recorded data is deleted. Once the data is deleted, it cannot be restored.

Caution:

Check that the access lamp has gone off.

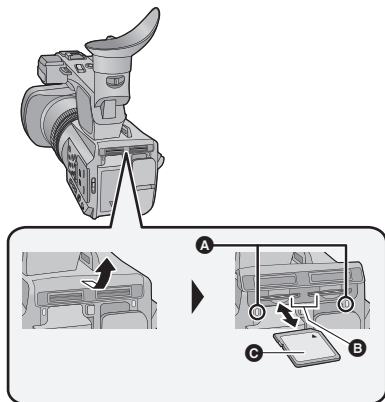

Access lamp **A**

- When this unit is accessing the SD card, the access lamp lights up.

1 Open the SD card slot cover and insert (remove) the SD card into (from) the card slot **B**.

- One SD card can be inserted into each of the card slot 1 and the card slot 2.
- Face the label side **C** in the direction shown in the illustration and press it straight in as far as it will go.
- Press the center of the SD card and then pull it straight out.

2 Securely close the SD card slot cover.

- Securely close it until it clicks.

- Do not touch the terminals on the back of the SD card.
- Do not apply strong shocks, bend, or drop the SD card.
- Electrical noise, static electricity or the failure of this unit or the SD card may damage or erase the data stored on the SD card.
- When the card access lamp is lit, do not:
 - Remove the SD card
 - Turn the unit off
 - Insert and remove the USB cable
 - Expose the unit to vibrations or shockPerforming the above while the lamp is on may result in damage to data/SD card or this unit.
- Do not expose the terminals of the SD card to water, dirt or dust.
- Do not place SD cards in the following areas:
 - In direct sunlight
 - In very dusty or humid areas
 - Near a heater
 - Locations susceptible to significant difference in temperature (condensation can occur.)
 - Where static electricity or electromagnetic waves occur
- To protect SD cards, return them to their cases when you are not using them.
- About disposing of or giving away the SD card. (→ 115)

Turning the unit on/off

Set the power switch to ON while pressing the lock release button **B** to turn on the unit.

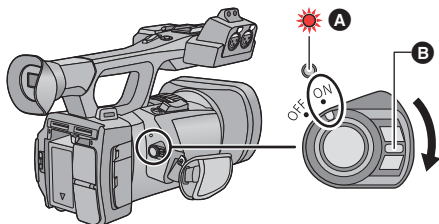

To turn off the unit

Set the power switch to OFF while pressing the lock release button. The status indicator goes off.

A The status indicator lights on.



- To turn on the unit again after the [ECONOMY (BATT)] or [ECONOMY (AC)] is activated, set the power switch to OFF once, and then to ON again. (→ 101)

Selecting a mode

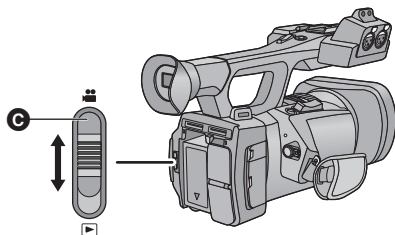
Operate the mode switch to change the mode to  or .



C Mode switch

	Recording Mode (→ 30, 31)
	Playback Mode (→ 65)

Using the LCD monitor/Viewfinder

The viewfinder is turned off and the LCD monitor is turned on when the LCD monitor is extracted. The viewfinder is turned on when the LCD monitor is retracted.

Using the LCD monitor

1 Extract the LCD monitor in the direction as indicated in the figure.

- Hold the LCD monitor extract part **A** when pulling out.

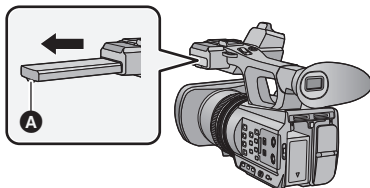

2 Rotate to the position that is easy to view.

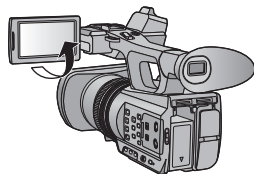

To retract the LCD monitor

Retract as shown in the figure with the LCD facing downward.

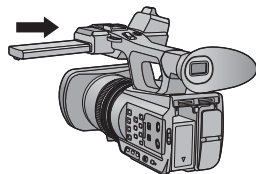

Range of rotation of the LCD monitor

- It can rotate up to 270° **B** towards the lens.

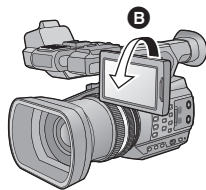

How to use the touch screen

You can operate by directly touching the LCD monitor (touch screen) with your finger.

■ Touch

Touch and release the touch screen to select icon or picture.

- Touch the center of the icon.
- Touching the touch screen will not operate while you are touching another part of the touch screen.

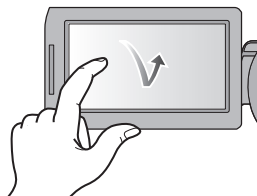

■ Slide while touching

Move your finger while pressing on the touch screen.

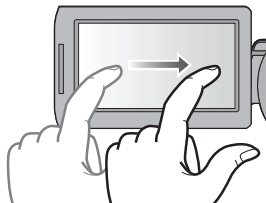

■ About the operation icons

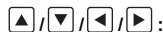

Touch when changing a page or performing settings.



Touch to return to the previous screen.



- Do not touch the LCD monitor with hard pointed tips, such as ball point pens.

LCD monitor adjustment

- These settings will not affect the images actually recorded.

[POWER LCD]

This makes it easier to view the LCD monitor in bright places including outdoors.

Select the menu. (→ 24)

 : [SW & DISP SETUP] → [POWER LCD] → [ON]

- When the AC adaptor is in use, [POWER LCD] is set to [ON] automatically.
- Recordable time with the battery is shortened when the LCD is made brighter.

[LCD SET]

It adjusts brightness and color density on the LCD monitor.

1 Select the menu. (→ 24)

 : [SW & DISP SETUP] → [LCD SET]

2 Touch the desired setting item.

[COLOR]: Color level of the LCD monitor

[BRIGHTNESS]: Brightness of the LCD monitor

[CONTRAST]: Contrast of the LCD monitor

3 Touch  /  to adjust settings.

4 Touch [ENTER].

- Touch [EXIT] to exit the menu screen.

Viewfinder adjustment

- These settings will not affect the images actually recorded.

Adjusting the field of view

It adjusts the field of view to show the image on the viewfinder clearly.

1 Adjust the viewfinder to suit your vision so that you can see the display images clearly.

- Be careful not to trap your fingers when moving the viewfinder.
- The viewfinder can be lifted vertically up to approximately 90°.
- Retract the LCD monitor and turn on the viewfinder.

2 Adjust the focus by operating the eyepiece corrector lever.

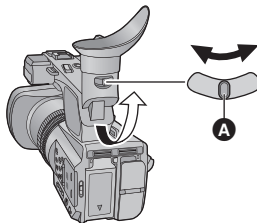

 Eyepiece corrector lever

[EVF SET]

Brightness of the viewfinder can be switched.

Select the menu. (→ 24)

 : [SW & DISP SETUP] → [EVF SET] → [BRIGHT]/[NORMAL]/[DARK]

[EVF COLOR]

The recording images or playback images on the viewfinder can be selected between color/black and white.

Select the menu. (→ 24)

MENU
[MENU] : [SW & DISP SETUP] → [EVF COLOR] → [ON] or [OFF]

[ON]: Displayed in color

[OFF]: Displayed in black and white

Recording yourself

- Change the mode to .
- **Rotate the LCD monitor towards the lens side.**
- Displaying during the recording yourself can be switched by setting [SELF SHOOT]. (→ 98)

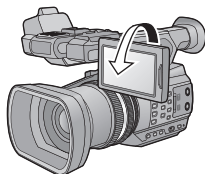

- Only some indications will appear on the screen when the [SELF SHOOT] is set to [MIRROR]. When  appears, return the direction of the LCD monitor to normal position and check the warning/alarm indication. (→ 107)

Setting date and time

When the unit is turned on for the first time, a message asking you to set the date and time will appear.

Select [YES] and perform steps 2 to 3 below to set the date and time.

1 Select the menu. (→ 24)

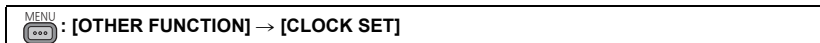

2 Touch the date or time to be set, then set the desired value using ▲/▼.

- The year can be set between 2000 and 2039.

Example: AG-AC90PJ



3 Touch [ENTER].

- The screen may switch to the setting screen for the [TIME ZONE]. Touch the screen and set the [TIME ZONE].
 - Touch [EXIT] to complete the setting.
-
- The date and time function is driven by a built-in lithium battery.
 - If the time display becomes [- -], the built-in lithium battery needs to be charged. To recharge the built-in lithium battery, connect the AC adaptor or attach a charged battery to this unit. Leave the unit as it is for approx. 24 hours and the battery will maintain the date and time for approx. 6 months. (The battery is still being recharged even if the unit is off.)
 - The way that time is displayed can be changed in the menu settings. (→ 97) [SW & DISP SETUP] → [DATE/TIME] or [DATE FORMAT]

Time zone

Time difference from the Greenwich Mean Time can be set.

1 Select the menu. (→ 24)

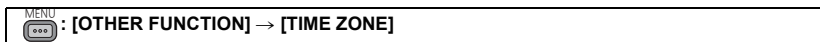

- If the clock is not set, set the clock to current time first.
- ### 2 Touch ◀/▶ and set the region to record.
- ### 3 Touch [ENTER].
- Touch [EXIT] to complete the setting.

Using the menu screen

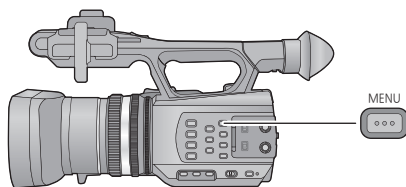

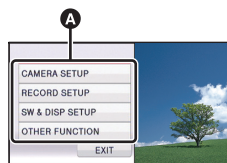

1 Press the MENU button .

2 Touch the top menu **A**.



3 Touch the submenu **B**.

- Next (Previous) page can be displayed by touching  / .

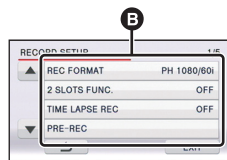

4 Touch the desired item to enter the setting.

5 Touch [EXIT] to exit the menu setting.

Using with the wireless remote control

Select the menu.

MENU
 : [OTHER FUNCTION] →
 [REMOTE CONTROL] → [ON]

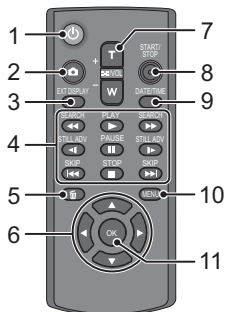

1 Power on/off button []

The unit can be turned on/off when the power switch of this unit is set to ON.

- Unit cannot be turned off when it is connected to the PC.

2 Photoshot button []*

3 On-screen display button [EXT DISPLAY] (→ 77)

4 Playback operation buttons (→ 66, 68)

These buttons function in the same manner as the corresponding playback operation icon being displayed on screen. [Excluding Skip Playback (→ 68)]

5 Delete button [] (→ 74)

6 Direction buttons [, , ,]

7 Zoom/volume/thumb nail display switch buttons [T, W, /VOL]*

8 Recording start/stop button [START/STOP]*

9 Date/time button [DATE/TIME] (→ 97)

10 Menu button [MENU]*

11 OK button [OK] (→ 26)

* means that these buttons function in the same manner as the corresponding buttons on the unit.

Remove the insulation sheet **A** before using.

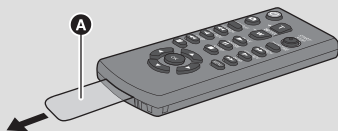

Replace a button-type battery

- 1 While pressing the stopper **B**, pull out the battery holder.

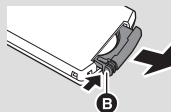

- 2 Set the button-type battery with its (+) mark facing upward and then put the battery holder back in place.



- When the button-type battery runs down, replace it with a new battery (part number: CR2025). The battery should normally last about 1 year, however this depends on how frequently the unit is used.

■ Wireless remote control usable range

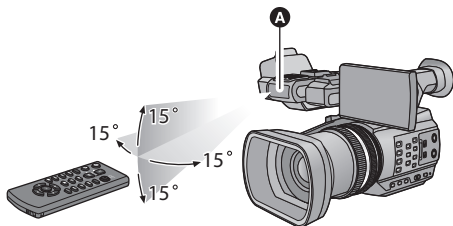

A Wireless remote control sensor

Distance: Within approx. 5 m (16 feet)

Angle: Approx. 15° up, down, left and right

- The wireless remote control is intended for indoor operation. Outdoors or under strong light, the unit may not operate properly even within the usable ranges.

Operation of direction buttons/OK button

1 Press a direction button.

- Selected item will become yellow.

2 Select the item with the direction button.



3 Confirm the selection by pressing the OK button.



- Selection/confirmation of operation icons, thumbnail display etc. can be operated.
- Wherever you can touch with your finger can be operated by the wireless remote control. (Excluding some functions)

Before recording

■ Basic camera positioning

Normal recording



- Put your hand through the grip belt and hold the unit with both hands.

Recording from a high position



Low-angle recording



- For easier low-angle recording, the sub recording start/stop button and the sub zoom lever can be used.

- When recording, make sure your footing is stable and there is no danger of colliding with another person or object.
- Hold the eye cup of the viewfinder as close as possible to your right eye.
- Adjust the angle of the LCD monitor according to the position in which the unit is held.
- When you are outdoors, record pictures with the sunlight behind you. If the subject is backlit, it will become dark in the recording.
- Keep your arms near your body and separate your legs for better balance.
- For stable images, it is recommended to use a tripod whenever possible.
- Do not cover the cooling fan inlet with your hand etc.

Formatting cards

If you use the SD cards for the first time for recording with this unit, format the cards. Please be aware that if a medium is formatted, then all the data recorded on the medium will be erased and cannot be restored. Back up important data on a PC, disc etc. (→ 79)

- When using two SD cards, format both SD cards.

1 Select the menu.

 : [OTHER FUNCTION] → [FORMAT CARD]

2 Touch [SD CARD 1] or [SD CARD 2].

- When formatting is complete, touch [EXIT] to exit the message screen.

- Do not turn this unit off or remove the SD card, while formatting. Do not expose the unit to vibrations or shock.

Use this unit to format media.

Do not format an SD card using any other equipment such as a PC. Otherwise it may not be possible to use the card on this unit.



Selecting a media to record

[SD CARD 1] and [SD CARD 2] can be selected separately to record motion pictures or still pictures.

1 Select the menu.

 : [SW & DISP SETUP] → [MEDIA SELECT]

2 Touch the media to record motion pictures or still pictures.

- The media is selected separately for motion pictures or still pictures and is then highlighted in yellow.

3 Touch [ENTER].

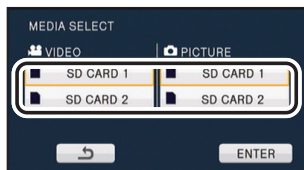



Recording motion pictures



1 Change the mode to .

- Extract the LCD monitor.

2 Press the recording start/stop button to start recording.

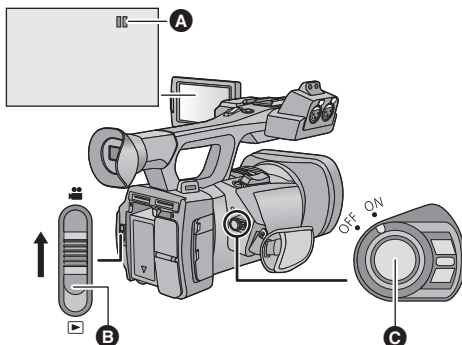

- Recording will stop when you press the recording start/stop button again.



- A** When you begin recording,  changes to .
- B** Mode switch

■ Screen indications in the Recording Mode



TC 00:00:00:00	Counter display (→ 51)
 (White)	Media where the motion picture is recorded (→ 29)
R 1h20m	Approximate remaining recordable time <ul style="list-style-type: none"> • When the remaining time is less than 1 minute, R 0h00m flashes red.
	Recording format (→ 89)
60i	Frame rate (→ 89)

- The images recorded between pressing the recording start/stop button to start recording and pressing it again to pause recording become one scene.
- Up to approximately 3,900 scenes can be recorded on single SD card.
Number of scenes that can be recorded will be less than above in following cases:
 - If you change [REC FORMAT]
 - During the interval recording
 - If you change [MIC SETUP] (→ 45)
- Please refer to page 117 about approximate recordable time.



Recording still pictures

1 Change the mode to .

- Extract the LCD monitor.

2 Press the button.

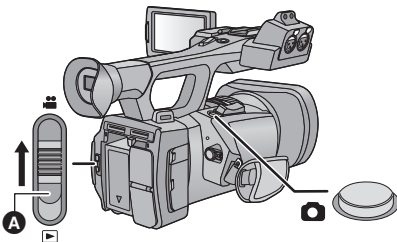

- When photos are being recorded, the remaining recordable number of photos and the photo operation display  are displayed.



A Mode switch



■ About the screen indications while recording still pictures



	Size of still pictures
R3000	Remaining number of still pictures
	Still picture indication

■ About picture size

The number of recording pixels changes depending on the [REC FORMAT] (→ 89) and the [ASPECT] (→ 92).

Recording format	ASPECT	Picture size
[PS 1080/60p], [PH 1080/60i], [PH 1080/30p], [PH 1080/24p], [HA 1080/60i], [HE 1080/60i]	-	 2304×1296
[SA 480/60i]	16:9	 1728×1296
	4:3	

- **It is possible to record still pictures while recording motion pictures. (Simultaneous recording)**
- It is recommended to use a tripod when recording under low light conditions because the shutter speed becomes slow.
- If simultaneous recording is used while recording a motion picture, the remaining recordable time will shorten. If the unit is turned off or the mode switch operated, the remaining recordable time may lengthen.
- The 16:9 still pictures recorded using this unit may be cropped at the edges when printed. So, be sure to check before printing in the store or on your printer.
- Please refer to page 118 about approximate number of recordable pictures.



Intelligent Auto Mode/Manual Mode

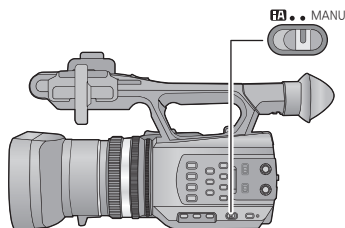

iA/MANU switch

Slide the switch to change the Intelligent Auto Mode/Manual Mode.

- **MNL** is displayed in the Manual Mode.
- The following modes appropriate for the condition are set just by pointing the unit to what you want to record in the Intelligent Auto Mode.

Mode	Effect
Portrait	Faces are detected and focused automatically, and the brightness is adjusted so it is recorded clearly.
Scenery	The whole landscape will be recorded vividly without whitening out the background sky, which may be very bright.
Spotlight	Very bright object is recorded clearly.
Low light*	It can record very clearly even in a dark room or twilight.
Normal	In modes other than those described above, the contrast is adjusted to give a clear picture.

* When [AUTO SLOW SHTR] (→ 93) is [OFF], Low Light Mode will not be entered.

- Depending on the recording conditions, the unit may not enter the desired mode.
- In the Portrait, Spotlight, or Low Light Mode, the face will be surrounded by a white frame when detected. In the Portrait Mode, a subject that is bigger and close to center of the screen will be surrounded by an orange frame. (→ 98)
- Faces cannot be detected depending on the recording conditions, such as when faces are of certain sizes or at certain tilts or when digital zoom is used.

■ Intelligent Auto Mode

When switching to Intelligent Auto Mode, the Auto White Balance and Auto Focus operate and automatically adjust the color balance and focusing.

Depending on the brightness of the subject etc., the aperture and shutter speed are automatically adjusted for an optimum brightness.

- Color balance and focus may not be adjusted automatically depending on light sources or scenes. If so, manually adjust these settings. (→ 38, 40)

Automatic White Balance

The illustration shows the range over which Automatic White Balance functions.

- 1) The effective range of Automatic White Balance adjustment on this unit
- 2) Blue sky
- 3) Cloudy sky (rain)
- 4) Sunlight
- 5) White fluorescent lamp
- 6) Halogen light bulb
- 7) Incandescent light bulb
- 8) Sunrise or sunset
- 9) Candlelight

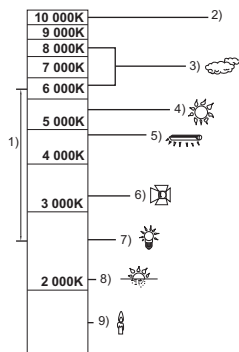

If the Automatic White Balance is not functioning normally, adjust the White Balance manually. (→ 40)

Auto Focus

The unit focuses automatically.

- Auto Focus does not work correctly in the following situations.
Record pictures in the Manual Focus Mode. (→ 38)
 - Recording distant and close-up objects at the same time
 - Recording a subject behind dirty or dusty window
 - Recording a subject that is surrounded by objects with glossy surfaces or by highly reflective objects



Using the zoom

It can be zoomed up to 12×.

- It can zoom up to 25× when the [i.Zoom] is set to [ON]. (→ 92)
- Zoom magnification can be checked in the screen display of Z00 to Z99. The value gets larger when zoomed in, and the value gets smaller when zoomed out. **Z**99 is displayed during the i.Zoom.

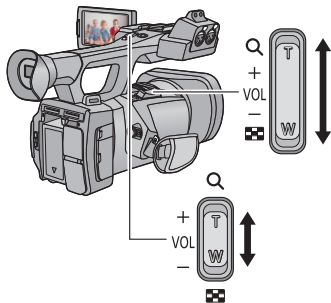

Zoom lever/Sub zoom lever

T side:

Close-up recording (zoom in)

W side:

Wide-angle recording (zoom out)

Ring zoom

Zoom operation can be done using the zoom ring.

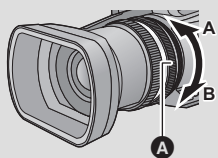

Zoom ring **A**

Zoom by rotating the ring.

A side:

Wide-angle recording (zoom out)

B side:

Close-up recording (zoom in)

■ About the zoom speed

- The zoom speed will vary depending on how far the zoom lever is pressed or how fast the zoom ring is rotated.
 - Zoom speed of the sub zoom lever will vary depending on the setting of [SUB ZOOM]. (→ 99)
 - The zoom speed does not vary when operating with the wireless remote control.
-

- If you take your finger off the zoom lever during zoom operation, the operation sound may be recorded. When returning the zoom lever to the original position, move it quietly.
- It can be focused approximately 1.2 m (3.9 feet) or further when the zoom magnification is at its maximum.
- It can be focused approximately 3.5 cm (1.4 ") or further when the zoom magnification is set to 1x.

Utilizing the USER button

Digital zoom can be used by setting the USER button. (→ 59)

- Please refer to page 55 for details about setting the USER button.

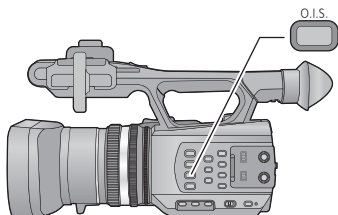

Image Stabilizer Function

Use the image stabilizer to reduce the effects of shake during recording.

This unit is equipped with Hybrid Optical Image Stabilizer.

Hybrid Optical Image Stabilizer is a hybrid of optical and electrical image stabilizer.



Optical image stabilizer button

Press the button to turn optical image stabilizer on/off.

◀ [Hand icon] / [Hand icon] ▶ → [Hand icon] (setting canceled)

- When [HYBRID O.I.S.] is [ON], ◀ [Hand icon] ▶ is displayed. When [OFF], [Hand icon] is displayed.

■ Changing Image Stabilizer Mode

MENU : [RECORD SETUP] → [HYBRID O.I.S.] → [ON] or [OFF]

When set to [ON], you can further improve image stabilization for recording while walking, or holding the unit and recording a distant subject with zoom.

- This function's default setting is [ON].
 - This cannot be set when Optical Image Stabilizer is set to [Hand icon] (setting canceled).
-
- Stabilization may not be possible under strong shaking conditions.
 - When using a tripod, we recommend that you set the image stabilizer to [Hand icon] (setting canceled).



Focus

Perform focus adjustments using the focus ring. If auto focusing is difficult due to the conditions, then use Manual Focus.

- **Switch to Manual Mode. (→ 33)**

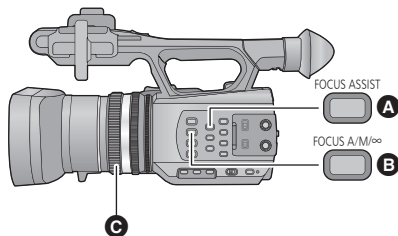

- A** FOCUS ASSIST button
- B** FOCUS A/M/∞ button
- C** Focus ring

1 Press the FOCUS A/M/∞ button to switch to Manual Focus.

- It will switch to MF from AF.

2 Adjust the focus by rotating the focus ring.

- The focus value can be set from MF00 (focus distance: approximately 3.5 cm (1.4 ″)) to MF99 (focus distance: infinity). The larger the focus value gets, the further the position where focus is achieved.
- It is set to MF95 and the focus will move to infinite when the FOCUS A/M/∞ button is pressed and held.
- To return to Auto Focus, either press the FOCUS A/M/∞ button or set to Intelligent Auto Mode by switching the iA/MANU switch.

-
- When the distance to the subject approaches within 1 m (3.3 feet) approx., the unit switches to the macro range and **[AF]** or **[MF]**. (The unit may switch to the macro range even when the distance to the subject is 1 m (3.3 feet) or more depending on the subject.)
 - Depending on the zoom magnification, this unit may fail to switch to the macro range, or go to a non-displayed focus value.
 - When you perform a zoom operation in the macro range, this unit may go out of focus.

■ Focus Assist

When the FOCUS ASSIST button is pressed, Focus Assist can be set.

The in-focus area is displayed in red.

- When it is pressed once more, the settings are canceled.
-

- The red display does not appear on the images actually recorded.

- The red display does not appear on TV.

Utilizing the USER button

When performing Manual Focus, Push AF can be used by setting the USER button. (→ 55)

- Please refer to page 55 for details about setting the USER button.



White Balance

Automatic White Balance function may not reproduce natural colors depending on the scenes or lighting conditions. If so, you can adjust the White Balance manually.

Switch the modes of White Balance by pressing the W.B. button.

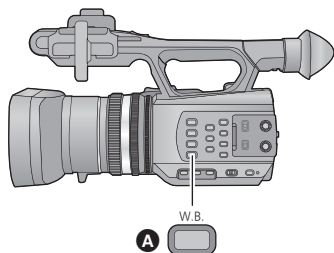

A W.B. button

Mode	Settings
ATW ATW	It will automatically adjust in accordance with the recording condition.
LOCK ATW Lock	It will lock the setting for ATW.
P3.2k P3.2k*	Preset value for studio/indoor recording (halogen lamp, etc.)
P5.6k P5.6k*	Preset value for outdoors
Ach Ach* Bch Bch*	Setting in accordance to the recording scenes can be set. (→ 41)



* Only displayed when Manual Mode is in use.

- To return to auto setting, either set to ATW or set to Intelligent Auto Mode by switching the iA/MANU switch.
- ATW and ATW Lock can also be set to the USER button. (→ 55)

■ To set the White Balance in accordance to the recording scene

1 Fill the screen with a white subject or place a white piece of paper in front of the lens.

2 Press the W.B. button to display Ach.

● When the operation icon is displayed and  is touched, it will switch to . (→ 64)

3 Keep on pressing the W.B. button to start the White Balance adjustment.

● The screen goes dark momentarily, "WB SET OK" is displayed, and the adjustment ends.

● When the mode of White Balance is set to something other than Ach/Bch, the Black Balance adjustment is performed by pressing and holding the W.B. button. Setting is completed when the screen goes black momentarily and "BB SET OK" is displayed.

● When the White Balance/Black Balance cannot be performed, an error message "WB SET NG" or "BB SET NG" is displayed on the screen. In such case, use other mode.

● The contents previously set are maintained in the Ach/Bch. Perform the setting again when the recording condition has changed.

■ To finely adjust the White Balance

White Balance for the Ach/Bch can be finely adjusted. Perform this after adjusting the White Balance.

● Switch to Manual Mode. (→ 33)

1 Select the menu.

: [CAMERA SETUP] → [COLOR TEMP A ch] or [COLOR TEMP B ch]

2 Touch  /  to adjust settings of color.

3 Touch [EXIT] to complete the setting.



Iris adjustment

Perform Iris/Gain adjustments using the iris ring.
Adjust it when the screen is too bright or too dark.



- A** Gain value
 - B** Iris value
 - C** Auto iris icon*
- * It is displayed in Auto Iris Mode.

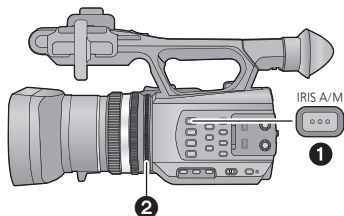

- 1** IRIS A/M button
- 2** Iris ring

- Switch to Manual Mode. (→ 33)

1 Press the IRIS A/M button to switch to Manual Iris Mode.

- **STD** disappears.
- The gain is displayed in dB.

2 Adjust the iris by rotating the iris ring.

Iris/Gain value:

CLOSE ↔ (F11 to F1.6) ↔ **OPEN** ↔ (0dB to 30dB)

- Value closer to CLOSE darken the image.
- Value closer to 30dB brighten the image.
- When the iris value is adjusted to brighter than OPEN, it changes to the gain value.
- To return to Auto Iris Mode, press the IRIS A/M button.



-
- If the gain value is increased, the noise on the screen increases.
 - Depending on the zoom magnification, there are iris values that are not displayed.

■ Adjusting brightness during the Auto Iris Mode

- Switch to Manual Mode. (→ 33)

1 Select the menu.

 : [CAMERA SETUP] → [AUTO IRIS LEVEL]

2 Touch  /  to adjust settings.

3 Touch [EXIT] to complete the setting.

Utilizing the USER button

It is convenient to use following functions of the USER button when it is set to Manual Iris.

- Please refer to page 55 for details about setting the USER button.

USER button function	Effect
Backlight Compensation (→ 57)	Switches to automatic iris control to compensate the backlight. This will brighten the image on the screen to prevent getting dark when a backlight is hitting the subject from the back.
Spotlight (→ 58)	Switches to automatic iris control for spotlight. This will allow to clearly record an extremely bright subject.



Manual shutter speed

Adjust the shutter speed when recording fast-moving subjects.

- Switch to Manual Mode. (→ 33)

1 Touch the LCD monitor to display the operation icons and touch . (→ 64)

2 Touch / to adjust settings.

- When [AUTO] is touched, the shutter speed is set automatically.
- Touch to complete the adjustment.

Shutter speed:

1/60 to 1/2000

- It will be 1/30 to 1/2000 when [AUTO SLOW SHTR] is set to [ON]. (→ 93)
- It will be 1/50 to 1/2000 (1/24 to 1/2000 when [AUTO SLOW SHTR] is set to [ON]) when [REC FORMAT] is set to [PH 1080/24p].
- The shutter speed closer to 1/2000 is faster.

-
- You may see a band of light around an object that is shining very bright, or highly reflective.
 - During normal playback, image movement may not look smooth.
 - If you record an extremely bright object or record under indoor lighting, color and screen brightness may change or a horizontal line may appear on the screen. Perform following operation in such case.
 - Record in the Intelligent Auto Mode
 - Adjust the shutter speed to 1/60 in areas where the power supply frequency is 60 Hz, or 1/100 in areas of 50 Hz.



Audio Input

This unit can record audio in 5.1 ch or 2 ch. (The voice recording method is Dolby® Digital ())
When recording in 2 ch, it is possible to switch between built-in microphone, external microphone, or connected audio equipment for each channel.

Microphone setup

Recording setting of the built-in microphone can be adjusted.

Select the menu.

: [RECORD SETUP] → [MIC SETUP] → desired setting

[SURROUND]:	Sound is recorded with 5.1 ch surround microphone.
[ZOOM MIC]:	Sound is recorded with 5.1 ch surround microphone changing the directionality in conjunction with the zoom operation. Sounds near the front of the unit are recorded more clearly if you zoom in (close-up) and surrounding sounds are recorded more realistically if you zoom out (wide angle).
[FOCUS MIC]:	The forward sound is recorded more clearly by enhancing the directionality toward the center for the 5.1 ch surround microphone.
[2ch]:	Sound from two directions is recorded in 2 ch by forward-facing stereo microphones.

- If you wish to record higher quality sound and maintain realism even when zooming in, for instance recording a music recital, we recommend setting [MIC SETUP] to [SURROUND].
- When the [BASS SETTING] is set to anything other than [0dB], it becomes impossible to select [FOCUS MIC]. (→ 94)
- When the [REC FORMAT] is set to [SA 480/60i], [2ch] is used.
- Display of the audio level meter will change depending on the settings. (→ 106)

Switching Audio Input

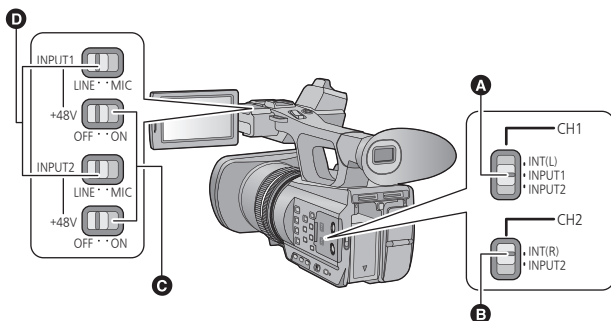

- A** CH1 switch
- B** CH2 switch
- C** INPUT1, 2 (+48V) switches
- D** INPUT1, 2 (LINE/MIC) switches

■ Using the built-in microphone

Audio is recorded with the built-in microphone (5.1 ch) when the [MIC SETUP] is set to anything other than [2ch].

When [MIC SETUP] is set to [2ch], audio is recorded with the built-in microphone (2 ch) when the CH1 switch is set to INT(L) and the CH2 switch is set to INT(R).

■ Using an external microphone or audio equipment

- Set [MIC SETUP] to [2ch]. (→ 45)

- 1** Connect an external microphone or audio equipment to **AUDIO INPUT1, 2** terminals (XLR 3 pin). (→ 9)
- 2** Use **INPUT1, 2 (LINE/MIC)** switches to switch the connected audio input signal.

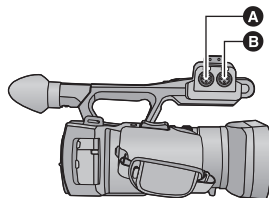

- A** AUDIO INPUT2 terminal (XLR 3 pin)
- B** AUDIO INPUT1 terminal (XLR 3 pin)

LINE: audio equipment is connected

Input level is 0 dBu.

MIC: an external microphone is connected

Input level is -50 dBu.

- When [EXT. MIC GAIN1] or [EXT. MIC GAIN2] is set to [-60dB], the input level is set to -60 dBu. (→ 94)

- 3** (When using the phantom microphone (which requires +48 V power supply))

Set the INPUT1, 2 (+48V) switches to ON.

ON: +48 V power supply to audio input terminals 1, 2 (XLR 3 pin).

OFF: No power supply for audio input terminals 1, 2 (XLR 3 pin).

- 4** Use the **CH1** switch to select the input signal to be recorded to audio channel 1.

INT(L): Audio from the built-in microphone L (left) ch is recorded to audio channel 1.

INPUT1: Audio from a device connected to audio input terminal 1 (XLR 3 pin) is recorded to channel 1.

INPUT2: Audio from a device connected to audio input terminal 2 (XLR 3 pin) is recorded to channel 1.

- 5** Use the **CH2** switch to select the input signal to be recorded to audio channel 2.

INT(R): Audio from the built-in microphone R (right) ch is recorded to audio channel 2.

INPUT2: Audio from a device connected to audio input terminal 2 (XLR 3 pin) is recorded to channel 2.

To remove the external microphone, etc., from the audio input terminals 1, 2 (XLR 3 pin)

Remove while pushing on the PUSH section of the audio input terminals 1, 2 (XLR 3 pin).

- Set the input signal to built-in microphone by switching the CH1, CH2 switches to INT (L) or INT (R) after removing the external microphone. Audio will not be recorded when motion picture is recorded without switching.

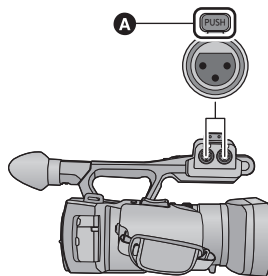

A PUSH section

-
- **Set INPUT1, 2 (+48V) switches to OFF if you connect equipment not compatible with +48 V. You can damage this unit or such equipment if you leave the setting at ON.**
 - This unit is turned off when a problem occurs with the +48 V power supply.
 - The battery will discharge faster if you use a phantom microphone.
 - When inputting the external microphone signal to audio channels 1 and 2, connect the external microphone to audio input terminal 2 (XLR 3 pin) and switch both CH1 and CH2 switches to INPUT2.

Adjusting the audio input level

■ Adjusting the input level of the built-in microphone (5.1 ch)

- Set the [MIC SETUP] to anything other than [2ch]. (→ 45)

1 Select the menu.

MENU : [RECORD SETUP] → [5.1ch MIC LEVEL] → desired setting

[AUTO]: ALC is activated, and the recording level is adjusted automatically.

[SET]/[SET+ ALC]: The desired recording level can be set.

2 (When [SET]/[SET+ ALC] is selected)

Touch **◀**/**▶** to adjust the microphone input level.

- Touch **ALC** to activate/disactivate ALC. When ALC is activated, the icon is surrounded by yellow and the amount of sound distortion can be reduced. When ALC is deactivated, natural recording can be performed.
- Adjust the microphone input level so that the last 2 bars of the gain value are not red. (Otherwise, the sound is distorted.) Select a lower setting for microphone input level.

3 Touch [ENTER] to set the microphone input level and then touch [EXIT].



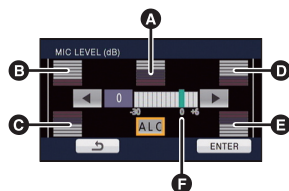

- **ALC** is displayed on the recording screen when the ALC is turned on.



- A** Center
- B** Front left
- C** Back left
- D** Front right
- E** Back right
- F** Microphone input level

- When [MIC SETUP] is [ZOOM MIC], the volume will be different depending on the zoom rate.
- You cannot record with the audio completely muted.

Adjusting the input level of the built-in microphone (5.1 ch) using the operation icons

- Set the [MIC SETUP] to anything other than [2ch]. (→ 45)
 - Set [5.1ch MIC LEVEL] to [SET]/[SET+ **ALC**]. (→ 49)
- 1 Display the operation icons and touch . (→ 64)
 - 2 Touch /  to adjust settings.
 - 3 Touch  to complete the setting.

■ Adjusting the input level of the built-in microphone (2 ch), external microphone or audio device

- Set [MIC SETUP] to [2ch]. (→ 45)
- Adjust the input level operating the Audio control knobs (CH1, CH2)

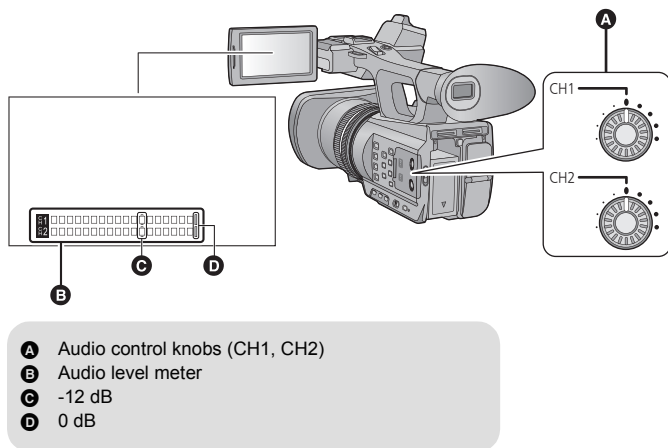

- Adjust confirming the audio level meter.

Counter display

You can change a counter display that indicates how much time has elapsed during recording or playback.

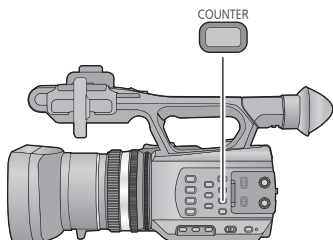

COUNTER button

Each time you press the button, the counter display changes.

Time Code → User Information → Recording Counter → Setting canceled

Counter display	Indications
Time Code	TC 00:00:00:00 or TC 00:00:00.00 <ul style="list-style-type: none"> Display will change depending on the setting of the [TC MODE]. (→ 52)
User Information (→ 53)	UB 00 00 00 00
Recording Counter (→ 54)	(In Recording Mode) 0:00:00 or SCN 0:00:00 (In Playback Mode) SCN 0:00:00 <ul style="list-style-type: none"> In Recording Mode, display will change depending on the setting of the [REC COUNTER]. (→ 54) In Playback Mode, display will return to SCN 0:00:00 for each scene.

Setting the Time Code

Time code will display the recording time in hours, minutes, seconds, and frames.

TC 00:00:00:00 (hour : minute : second : frame [NDF])

TC 00:00:00.00 (hour : minute : second . frame [DF])

- The frame (Number of frames counted every second) will vary depending on the [REC FORMAT] setting. (→ 89)

Recording format	Frame
[PS 1080/60p], [PH 1080/60i], [PH 1080/30p], [HA 1080/60i], [HE 1080/60i], [SA 480/60i]	0 to 29
[PH 1080/24p]	0 to 23

[TC MODE]



Select the compensation mode for the time code.

: [RECORD SETUP] → [TC MODE] → desired setting

- [DF]:** Time code is compensated in accordance with the actual time. It is mainly used for broadcasting such as TV programs.
- [NDF]:** It will not compensate the time code. (There will be a difference from the actual time)

- It is automatically set to [NDF] when the [REC FORMAT] is set to [PH 1080/24p] or the interval recording is used.

[TCG]



Sets the way the time code will move.

: [RECORD SETUP] → [TCG] → desired setting

- [FREE RUN]*:** It will constantly move.
- [REC RUN]:** It will move only when recording.

* An error may occur when the playback mode is switched when the [REC FORMAT] is set to [PH 1080/24p].

- It is automatically set to [FREE RUN] when it is set to PRE-REC.
- The time code will reset when the built-in lithium battery is exhausted when it is set to [FREE RUN].

[TC PRESET]



You can set the initial time code.

1 Select the menu.

: [RECORD SETUP] → [TC PRESET]

2 Touch the item to set and change with / .

- It will be set to 00h00m00s00f when the RESET button is pressed.
- "h" is an abbreviation for hour, "m" for minute, "s" for second and "f" for frame.

3 Touch [ENTER].

- Touch [EXIT] to complete the setting.

• This unit will adjust the time code in accordance with the frame rate of the recording format. (→ 89) Therefore, it may not be continuous from the previous final time code when the recording format is changed.

- Set the frame to [00] or value that is multiple of 4 when the [REC FORMAT] is set to [PH 1080/24p]. The time code that is recorded will shift when other values are set.

Setting the User Information

Eight digit hexadecimal alphanumeric can be entered and displayed as a memo information such as dates, control numbers, etc., into the User Information.

UB 00 00 00 00

[UB PRESET]



You can set the User Information.

1 Select the menu.

: [RECORD SETUP] → [UB PRESET]

2 Touch the item to set and change with / .

- You can use numbers from 0 to 9 and letters from A to F.
- It will be set to 00 00 00 00 when the RESET button is pressed.

3 Touch [ENTER].

- Touch [EXIT] to complete the setting.

Setting the Recording Counter

Recording Counter will display the recording time in seconds.

0:00:00 (hour : minute : second (When [REC COUNTER] is set to [TOTAL]))

SCN 0:00:00 (hour : minute : second (When [REC COUNTER] is set to [SCENE]))

[REC COUNTER]



Select the counting method during the recording.

MENU



[SW & DISP SETUP] → [REC COUNTER] → desired setting

[TOTAL]:

The count continues to increase until the Recording Counter is resetted.

[SCENE]:

Resets the Recording Counter at start of recording. Counts the time of each recording session.

To reset the Recording Counter for the Recording Mode

The Recording Counter will be set to 0:00:00 when the RESET button is pressed while displaying the counter.



USER button

Each of the USER button can register one function from the 12 available functions.

- There are three USER buttons (USER1 to USER3) on the main body and four USER button icons (USER4 to USER7) displayed on the LCD monitor.

Setting the USER button

1 Select the menu.

MENU [***] : [SW & DISP SETUP] → [USER BUTTON SETUP]

2 Touch the USER button you wish to set.

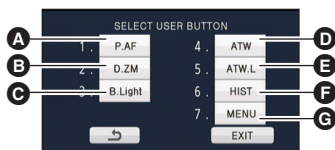

- A USER1 button
- B USER2 button
- C USER3 button
- D USER4 button
- E USER5 button
- F USER6 button
- G USER7 button

- The USER button number and currently set function name are displayed. (For example, a display of 1. [P.AF] means that Push AF has been assigned to USER1 button.)

3 Touch the item to register.

- For the functions of the USER button that can be registered, refer to page 57.
- Touch [INH] (Inhibit) if not registering.
- Next (Previous) page can be displayed by touching / .
- To continuously set other USER buttons, repeat steps 2-3.

4 Touch [EXIT] to complete the setting.

Using the USER button

To use the set USER button, press USER1 to USER3 button or touch the USER4 to USER7 button icon displayed when you touch the LCD monitor.

(When you use the USER1 to USER3)

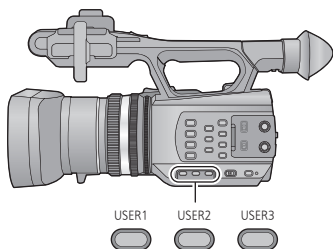

(When you use the USER4 to USER7)

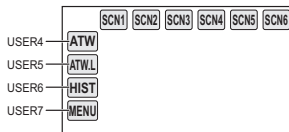

- To cancel, press the USER button or touch the USER button icon again.
For canceling or using of the following functions for the USER buttons, refer to each page.
 - Push AF (→ 57)
 - Black Fade (→ 58)
 - White Fade (→ 58)
 - Digital Zoom (→ 59)
 - Recording Check (→ 59)
 - Last Scene Delete (→ 60)

■ Switch display/not-display of the USER buttons

Display/not-display of the USER button icons in the LCD monitor can be switched.

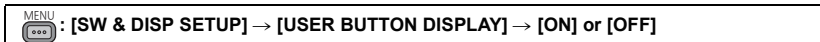

■ Check the setting of the USER buttons

To check the settings of the USER buttons (USER1 to USER3) in the recording screen, press and hold on the DISP/MODE CHK button.

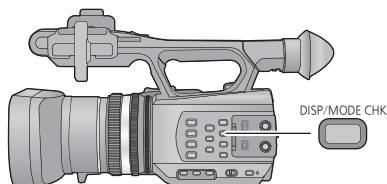

Functions of the USER button

■ List of USER button function

Icon	Item	Function
[P.AF]	[PUSH AF]	Push AF
[B.Light]	[BACKLIGHT]	Backlight Compensation
[S.Light]	[SPOTLIGHT]	Spotlight
[B.FD]	[BLACK FADE]	Black Fade
[W.FD]	[WHITE FADE]	White Fade
[ATW]	[ATW]	ATW
[ATW.L.]	[ATW LOCK]	ATW Lock
[D.ZM]	[D.ZOOM]	Digital Zoom
[HIST]	[HISTOGRAM]	Histogram
[REC.C]	[REC CHECK]	Recording Check
[LstDel]	[LAST SCN DEL]	Last Scene Delete
[MENU]	[MENU]	Menu

Push AF

It can be temporary changed to Auto Focus when it is set to Manual Focus. (→ 38)

Press and hold the USER button, or touch and hold the USER button icon in the recording screen.

- It will be canceled when the button is released.

-
- The focus position set by the Push AF will be maintained when canceled.

Backlight Compensation

Switches to automatic iris control to compensate the backlight.



This makes the image brighter to prevent darkening of a backlit subject.

-  appears when it is set.
- It will return to standard Auto Iris Mode () when it is canceled. (→ 42)

Spotlight

Switches to automatic iris control for spotlight.

Very bright object is recorded clearly.

-  appears when it is set.
- It will return to standard Auto Iris Mode () when it is canceled. (→ 42)

Black Fade

Fade in/fade out effect (black) can be added to the video and audio that is being recorded.

Press USER button or touch USER button icon in the recording screen.

- Fade out will start, and fade in will start after completing the fade out.
- It will fade out when the button is pressed and held, and fade in will start when the button is released.

-
- Recording will not start even if the fade out is started. It is possible to press the recording start/ stop button during the fade in or fade out.
 - This effect cannot be set for interval recording.
 - The thumbnails of scenes recorded using fade in become black.

White Fade

Fade in/fade out effect (white) can be added to the video and audio that is being recorded.

Press USER button or touch USER button icon in the recording screen.

- Fade out will start, and fade in will start after completing the fade out.
- It will fade out when the button is pressed and held, and fade in will start when the button is released.

-
- Recording will not start even if the fade out is started. It is possible to press the recording start/ stop button during the fade in or fade out.
 - This effect cannot be set for interval recording.
 - The thumbnails of scenes recorded using fade in become white.

ATW

The White Balance can be changed to ATW. (→ 40)

-
- This cannot be set when the Intelligent Auto Mode is used or the White Balance is set to ATW Lock.

ATW Lock

The White Balance can be changed to ATW Lock. (→ 40)

- It will return to ATW when canceled.
-

- This cannot be set when the White Balance is set to anything other than ATW.

Digital Zoom

Press **USER** button or touch **USER** button icon in the recording screen.

- The zoom magnification will change every time the button is pressed or the button icon is touched.

2× → 5× → 10× → Setting canceled

- The larger the digital zoom magnification, the more the image quality is degraded.
- Digital zoom is not possible when the [REC FORMAT] is [PH 1080/24p].
- Digital zoom is canceled in following cases:
 - If you turn the unit off
 - If you use the Quick Start Mode (→ 61)
 - If you change the mode

Histogram

A graph with brightness as horizontal axis and number of pixels at that brightness as vertical axis is displayed. It is possible to determine the exposure of the whole image by looking at the distribution in the graph.

- To adjust the brightness, refer to page 42.

Recording Check

Approximately 2 seconds at the end of the video recorded last can be played back. It will return to recording screen once the playback is completed.

- Playback operation is not possible during the Recording Check.
- Recording Check is not possible in following cases:
 - When the unit is turned on/off
 - When the mode switch is operated
 - When the setting of [REC FORMAT] is changed
 - When the SD Card is inserted/removed
 - During the interval recording

Last Scene Delete

The motion picture recorded last can be deleted.

Deleted scenes cannot be restored.

1 Press USER button or touch USER button icon in the recording screen.

2 Touch [YES].

- It will return to recording screen without deleting by touching [NO].

• Last Scene Delete is not possible in following cases:

- When the unit is turned on/off
- When the mode switch is operated
- When the setting of [REC FORMAT] is changed
- When the SD Card is inserted/removed
- During the interval recording
- Set [2 SLOTS FUNC.] to [BACKUP]. (→ 90)

Menu

The menu can be displayed.



Useful functions

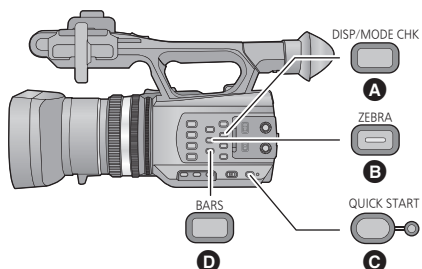

- A** DISP/MODE CHK button
- B** ZEBRA button
- C** QUICK START button
- D** BARS button

Quick Start

- 1 Press and hold down the QUICK START button until the display on the LCD monitor/viewfinder disappears.**

The quick start lamp **E** flashes green and the unit goes into Quick Start Standby Mode.

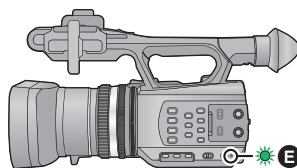

- 2 Press the QUICK START button.**

The quick start lamp **E** goes off and the unit is put into recording pause about 0.6 seconds.

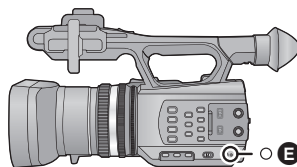

- **When in Quick Start Standby Mode about 80% of the power used in recording pause mode is being consumed, so the recording time will be reduced.**
- This unit is turned off after approximately 30 minutes elapse in Quick Start Standby Mode.
- Quick Start Standby Mode is cleared when the mode switch is set to .
- Depending on the recording conditions and menu settings, time for Quick Start may be longer than 0.6 seconds.
- It may take some time for Automatic White Balance to adjust.
- In the Quick Start Mode, the zoom magnification becomes approximately 1×.

Zebra

ZEBRA button

It will switch between the zebra display and the marker display every time the button is pressed.
Zebra 1 → Zebra 2* → Marker* → setting canceled

* It is not displayed when the [ZEBRA DETECT 2]/[MARKER] is set to [OFF]. (→ 96)

Zebra display:

Parts where white saturation (color saturation) is likely to occur (extremely brightly lit or shiny parts) are displayed with diagonal lines (zebra pattern).

Marker display:

Displays the luminance level of the center of the screen (luminance display frame) in %.

It makes the adjustment of the brightness of the object easier, by checking the luminance level of the object, when recording same object in different surroundings.

- Marker display is displayed between 0% and 99%. It will be displayed as 99% ↑ when it is over 99%.
- You can record an image with little white saturation if you manually adjust the shutter speed or brightness. (→ 42, 44)
- The zebra pattern does not appear on the images actually recorded.
- It is also possible to adjust the level of the zebra pattern to be displayed. (→ 95, 96)

Color Bar Screen

BARS button

Press the BARS button to output a color bar screen to a television or monitor so you can adjust them.

- To cancel, press the BARS button again.
- It will be canceled when the unit is turned off.
- While the color bar is displayed, a test tone will be output from the headphone terminal, HDMI terminal and AV multi terminal. (The test tone that is output will be 1 kHz.) It will not be output from the speaker of this unit.
- It is possible to record the color bar screen.

Switching the screen indications/mode information display

DISP/MODE CHK button

All the screen display other than the Counter display, Recording start/stop, Zebra display, Marker, and Safety Zone will disappear when this button is pressed. (→ 105)

- To cancel, press the DISP/MODE CHK button again.

■ To display the Mode Information

List of functions assigned to the USER buttons (USER1 to USER3) and settings of the [SUB REC BUTTON] and [SUB ZOOM] are displayed by pressing and holding the DISP/MODE CHK button.

- They are displayed only while the DISP/MODE CHK button is held. It is disappeared when the button is released.



Using of Operation Icons

You can use convenient functions just by the easy operation of touching the screen.

1 Touch the LCD monitor in the recording screen.

- The operation icons are displayed.

2 Touch an operation icon.

- The following function is available. Refer to the respective pages for the operation.



etc.	Customize Scene (→ 84) ^{*1}
etc.	USER Button Icon (→ 55)
	White Balance (→ 40) ^{*1}
	Shutter Speed Adjustment (→ 44) ^{*1}
	Headphone Volume Adjustment ^{*2}
	5.1 ch Microphone Level (→ 50)

*1 It is not displayed in the Intelligent Auto Mode.

*2 It is displayed only when connected to the headphone terminal.

- If you touch the screen while an operation icon is being displayed or do not touch the icon for a certain period, it will disappear. To display again, touch the screen.

■ Headphone Volume Adjustment

Adjust the volume of the headphone while recording.

1 Display the operation icons and touch .

2 Touch / to adjust the volume.

- Actual volume to be recorded does not change.

3 Touch to exit the setting.



Motion picture/Still picture playback

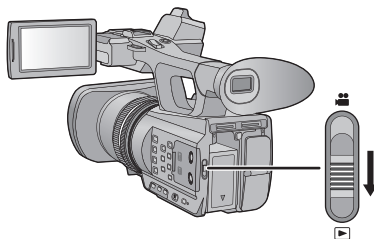

- 1 Change the mode to .
- 2 Touch the play mode select icon **A**.

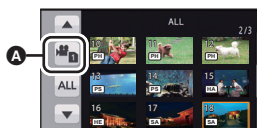

- 3 Select the [MEDIA] and [VIDEO/PICTURE] you wish to play back.
 - Touch [ENTER].

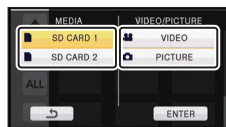

- 4 Touch the scene or the still picture to be played back.
 - The recording format is displayed in the thumbnail display of the motion pictures. (PH, PS, etc.)
 - Next (Previous) page can be displayed by touching / .

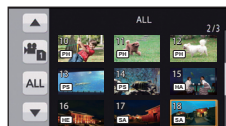

- 5 Select the playback operation by touching the operation icon.
 - If you touch the screen while an operation icon is being displayed or do not touch the icon for a certain period, it will disappear. To display again, touch the screen.



- B** Operation icon

- If you touch the screen while an operation icon is being displayed or do not touch the icon for a certain period, it will disappear. To display again, touch the screen.

Motion picture playback	Still picture playback
▶/ : Playback/Pause	▶/ : Slide show (playback of the still pictures in numerical order) start/pause.
◀◀: Fast rewind playback*	◀ : Plays back the previous picture.
▶▶: Fast forward playback*	▶: Plays back the next picture.
■: Stops the playback and shows the thumbnails.	■: Stops the playback and shows the thumbnails.
▷: Display the direct playback bar (→ 69)	

* When pressed two times, the fast forward/fast rewind speed increases. (The screen display changes from ▶▶ to ▶▶▶.)

■ Change the thumbnail display

While the thumbnail is displayed, the thumbnail display changes in the following order if the zoom lever or the sub zoom lever is operated to Q side or  side.

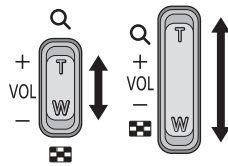

( side)

(Q side)

20 scenes ↔ 9 scenes ↔ 1 scene ↔ Scene information display*

* Detailed information of the scene is displayed when playing back motion pictures. Following information is displayed.

- Start TC
 - Start UB
 - Date
 - Time zone
 - Recording time
 - Format
- 9 scenes display returns if the unit is turned off or the mode is changed.
 - By displaying in 1 scene, recording date and time are displayed when playing back motion pictures, and recording date and file number when playing back still pictures.

■ Speaker/Headphone volume adjustment

Operate the volume lever or the sub zoom lever to adjust the speaker/headphone volume during Motion Picture Playback Mode.

Towards “+”:

Increases the volume

Towards “-”:

Decreases the volume

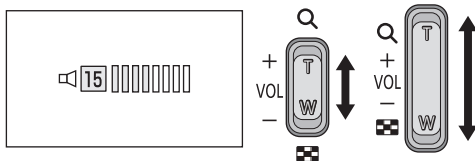

- Sound will be heard only during normal playback.
- If pause play is continued for 5 minutes, the screen returns to the thumbnails.
- When changing from scenes recorded using the recording format [PS] to other scenes or when changing from scenes recorded using the recording format [SA] to other scenes, the screen becomes black for a moment.

Motion picture compatibility





- This unit is based on AVCHD Progressive/AVCHD.
- Even if the devices used have compatible standards, when playback of video recorded using another device is performed using this device, or when video recorded using this device is played back in another device, playback may not proceed normally, or may not be possible. (Please check compatibility in the instruction manual of your device.)



Still picture compatibility

- This unit is compliant with the unified standard DCF (Design rule for Camera File system) established by JEITA (Japan Electronics and Information Technology Industries Association).
- The file format of still pictures supported by this unit is JPEG. (Not all JPEG formatted files will be played back.)
- This unit may degrade or not play back still pictures recorded or created on other products and other products may degrade or not play back still pictures recorded on this unit.

Motion picture playback using operation icon

For details on the basic playback operations, refer to page 65.

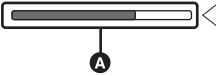
Playback operation	Playback display	Operating steps
Skip playback (to the start of a scene)	<p>During Playback</p> 	<p>Press the ◀◀ or ▶▶ button during playback. (Operation is possible with the wireless remote control only.)</p> 
Slow-motion Playback	<p>During Pause</p> 	<p>With the playback paused, continue touching ◻▶. (◀◻ is for slow rewind playback.) Playback is slow while touching.</p> <ul style="list-style-type: none"> • Normal playback is restored when you touch ▶/◻. • When Slow-motion pictures are played back in reverse, they will be shown continuously at approximately 2/3rd the speed of normal playback (intervals of 0.5 seconds).
Frame-by-frame playback	<p>During Pause</p> 	<p>With the playback paused, touch ◻▶. (Touch ◀◻ to advance the frames one at a time in the reverse direction.)</p> <ul style="list-style-type: none"> • Normal playback is restored when you touch ▶/◻. • When the frames are advanced one at a time in the reverse direction, they will be shown in intervals of 0.5 seconds.

Playback operation	Playback display	Operating steps
<p>Direct playback</p>	<p>During Playback</p> 	<ol style="list-style-type: none"> 1) Touch  to display the direct playback bar A. 2) Touch the direct playback bar or slide it while touching. <ul style="list-style-type: none"> • The playback pauses temporarily and skips to the position touched or slid to while touching. • Playback will start by releasing your touching or sliding finger. • Touch  to display the operation icon. • Direct playback bar cannot be operated with the wireless remote control.



Useful functions

Creating still picture from motion picture

A single frame from the recorded motion picture can be saved as a still picture.

The number of recording pixels of photos created changes depending on the recording format of video taken and the image aspect ratio.

Recording format	Aspect ratio	Picture size
PS/PH/HA/HE	16:9	1920×1080
SA	16:9	640×360
	4:3	640×480

Press the button at the location to be saved as a still picture during the playback.

- It is convenient to use Pause, Slow-motion Playback and Frame-by-frame Playback.
- Date the motion picture was recorded will be registered as date of the still picture.
- Quality will be different from the normal still picture.

Repeat Playback

Playback of the first scene starts after playback of the last scene finishes.

: [VIDEO SETUP] → [REPEAT PLAY] → [ON]

The indication appears on the full screen views.

- All the scenes displayed in the thumbnail will be repeatedly played back.

- Repeat Playback cannot be used for the slide show playback of the still pictures. (→ 66)

Resuming the previous playback

If playback of a scene was stopped halfway, the playback can be resumed from where it was stopped.

: [VIDEO SETUP] → [RESUME PLAY] → [ON]

If playback of a motion picture is stopped,  appears on the thumbnail view of the stopped scene.

- The memorized resume position is canceled if you turn off the unit or change the mode. (The setting of [RESUME PLAY] does not change.)

Playback scenes by the selected format

Scenes recorded with same recording format are played back continuously.

- Change the mode to  and touch the play mode select icon.

Then, set [VIDEO/PICTURE] to [VIDEO]. (→ 65)

1 Touch the format select icon.

2 Touch [SAME FORMAT].

All the scenes are displayed by touching [ALL].

3 Touch the playback recording format.

The scenes recorded on the recording format selected are displayed as thumbnails.

4 Touch the scene to be played back.

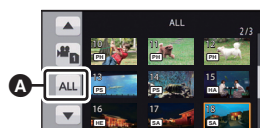

A Format select icon

- It will go back to ALL display when the recording is started by switching to the recording mode.
- It is possible that scenes recorded using other devices may not be displayed in modes other than ALL display.

Playing back still pictures by date

The still pictures recorded on the same day can be played back in succession.

- Change the mode to  and touch the play mode select icon.

Then, set [VIDEO/PICTURE] to [PICTURE]. (→ 65)

1 Touch the date select icon.

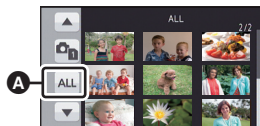

- A Date select icon

2 Touch the playback date.

The still pictures recorded on the date selected are displayed as thumbnails.

3 Touch the still picture to be played back.

- It will return to display all by turning off the unit or operating the mode switch.
- Even if still pictures are recorded on the same day, they are grouped separately when the number of still pictures exceeds 999.
-  is displayed after the date in the list by date for the still pictures created from the motion picture. (→ 70)



Deleting scenes/still pictures

Deleted scenes/still pictures cannot be restored, so perform appropriate confirmation of the contents before proceeding with deletion.

- Change the mode to  and touch the play mode select icon. Then, switch to the thumbnail display of the scenes or still pictures to delete. (→ 65)

1 Select the menu.

: [VIDEO SETUP] or [PICT. SETUP] → [DELETE] → desired setting

[ALL SCENES]:

All the scenes or still pictures displayed as thumbnails can be deleted.
(In case of playing back scenes by recording format or still pictures by date, all the scenes on the selected recording format or still pictures on the selected date will be deleted.)

[MULTI]:

Multiple scenes or still pictures can be selected and deleted.

[SINGLE]:

Single scene or still picture can be selected and deleted.

- Protected scenes/still pictures cannot be deleted.

2 (When [MULTI] is selected in Step 1)

Touch the scene/still picture to be deleted.

- When touched, the scene/still picture is selected and the  indication appears on the thumbnail. Touch the scene/still picture again to cancel the operation.
- Up to 99 scenes can be selected to be deleted.

(When [SINGLE] is selected in Step 1)

Touch the scene/still picture to be deleted.

3 (When [MULTI] is selected in Step 1)

Touch [Delete].

- To continuously delete other scenes/still pictures, repeat Steps 2-3.



When you stop deleting halfway:

Touch [CANCEL] or press MENU button while deleting.

- The scenes or still pictures that have already been deleted when the deletion is canceled cannot be restored.

To complete editing:

Touch [Return] or press MENU button.

-
- Scenes/still pictures that cannot be played back (the thumbnails are displayed as ) cannot be deleted.
 - In case of [ALL SCENES], the deletion may take time if there are many scenes or still pictures.
 - If you delete scenes recorded on other products or still pictures conforming to DCF standard with this unit, all the data related to the scenes/still pictures may be deleted.
 - When still pictures recorded on an SD card by other products are deleted, a still picture (other than JPEG) that cannot be played back on this unit, may be erased.
 - The scene or still picture that is being played back or displayed can be deleted by pressing the  button on the wireless remote control while playing back or displaying the thumbnail (one scene). Screen to select [ALL SCENES], [MULTI], or [SINGLE] is displayed when the  button on the wireless remote control is pressed while displaying the thumbnail (20 scenes or 9 scenes). The scene or the still picture can be deleted by selecting the item and performing steps 2 to 3.

Protecting scenes/still pictures



Scenes/still pictures can be protected so that they are not deleted by mistake.

(Even if you protect some scenes/still pictures, formatting the media will delete them.)

- Change the mode to  .

1 Select the menu.

 : [VIDEO SETUP] or [PICT. SETUP] → [SCENE PROTECT]

2 Touch the scene/still picture to be protected.

- When touched, the scene/still picture is selected and the  indication appears on the thumbnail. Touch the scene/still picture again to cancel the operation.
- Touch [Return] to complete the settings.

Watching Video/Pictures on your TV

Confirm the terminals on your TV and use a cable compatible with the terminals. Image quality may vary with the connected terminals.

- A** High quality
- 1** HDMI terminal
- 2** Component terminal
- 3** Video terminal



- Use the AV multi cable (supplied) or HDMI cable (optional) and check the output settings. (→ 78)
- HDMI is the interface for digital devices. If you connect this unit to a HDMI compatible high definition TV and then play back the recorded high definition images, you can enjoy them in high resolution with high quality sound.

1 Connect this unit to a TV.

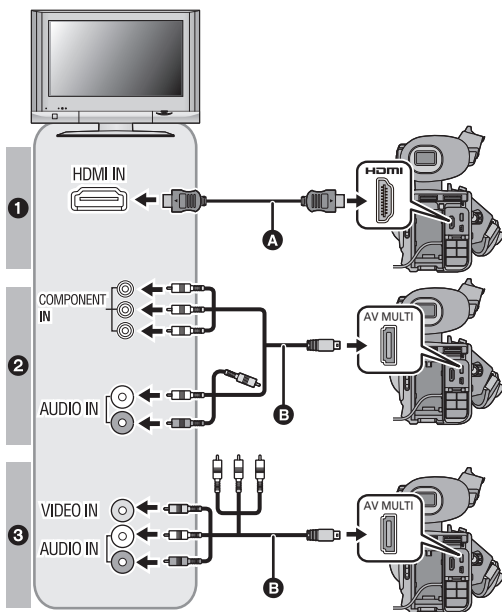

A HDMI cable (optional)

- Be sure to connect to the HDMI terminal.

B AV multi cable (supplied)

Picture quality

- 1** High definition images when connecting to HDMI terminal
- 2** High definition images when connecting to component terminal compatible with 1080i
Standard images when connecting to component terminal compatible with 480i
- 3** Standard images when connecting to video terminal

- Check that the plugs are inserted as far as they go.
- Please use "High Speed HDMI Cables" that have the HDMI logo (as shown on the cover). Cables not conforming to the HDMI standard will not work. Panasonic HDMI cable is recommended. Part No.: RP-CHES15 (1.5 m) (4.9 feet)
- Do not use any other AV multi cables except the supplied one.
- When connecting to the component terminal of the TV, the yellow plug of the AV multi cable is not required.
- When connecting to the AV terminal of the TV, do not connect the component terminal plug of the AV multi cable. Image may not display when the component terminal plug is connected simultaneously.

2 Select the video input on the TV.

- Example:
Select the [HDMI] channel with a HDMI cable.
Select the [Component] or [Video 2] channel with an AV multi cable.
(The name of the channel may differ depending on the connected TV.)
- Check the input setting (input switch) and the audio input setting on the TV. (For more information, please read the operating instructions for the TV.)

3 Change the mode to to play back.

Cables	Reference items
A HDMI cable (optional)	<ul style="list-style-type: none"> • Connecting with a HDMI cable (→ 78) • Listening in 5.1 channel sound (→ 78)
B AV multi cable (supplied)	<ul style="list-style-type: none"> • Connecting with the AV multi cable (→ 78)

- This unit is not compatible with the VIERA Link.

■ **To watch images on a regular TV (4:3) or when both sides of the images do not appear on the screen**

Change the menu setting to display the images correctly. (Check the TV setting.)

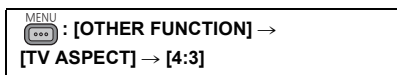

- When aspect ratio is set to [4:3] and this device and a television are connected, sometimes some icons may not be displayed on the television.

Example of images with a [16:9] aspect ratio on a regular TV (4:3)

[TV ASPECT] setting	
[16:9]	[4:3]

- If a wide-screen TV is connected, adjust the aspect setting on the TV. (Refer to the operating instructions of the TV for details.)

■ **To display the on-screen information on the TV**

When the menu setting is changed, the information displayed on the screen (operation icon and Counter display etc.) can be displayed/not displayed on the TV.

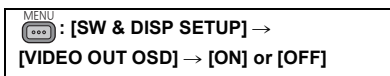

- It can also be switched by the On-screen display button on the wireless remote control. (→ 25)

Connecting with a HDMI cable

Select the desired method of HDMI output.

MENU  : [OTHER FUNCTION] → [HDMI RESOLUTION] → [AUTO]/[1080p]/[1080i]/[480p]

- [AUTO] determines the output resolution automatically based on information from the connected TV.
If the images are not output on the TV when the setting is [AUTO], switch to the method [1080p], [1080i] or [480p] which enables the images to be displayed on your TV. (Please read the operating instructions for the TV.)
- The image quality of [AUTO] differs from that of [1080p], [1080i] and [480p].
- Images may not be displayed on the television for several seconds in some cases, such as when changing between scenes.

Listening in 5.1 channel sound

The audio recorded with the built-in microphone can be played back as 5.1 ch audio by connecting this unit with a 5.1 ch compatible amplifier or TV using a HDMI cable.

For connecting this unit with an AV amplifier or a TV, refer to operating instructions of the AV amplifier or the TV.

- The audio recorded with [MIC SETUP] set to [2ch] will be in stereo (2 ch).

Connecting with the AV multi cable

AV multi connector output setting can be changed.

MENU  : [OTHER FUNCTION] → [AV MULTI] → desired setting

[COMPONENT]: When connecting to the component terminal

[AV OUT]: When connecting to the video terminal

Changing the component output setting

MENU  : [OTHER FUNCTION] → [COMPONENT OUT] → desired setting

[480i]: When connecting to the component terminal on the TV compatible with 480i.
(Playback is in standard quality.)

[1080i]: When connecting to the component terminal on the TV compatible with 1080i.
(Playback is in high definition quality.)

Connecting to a PC (File transfer/nonlinear editing)

When this device and a computer for editing are connected using a USB connection cable, image data in the SD card can be transferred.

- Concerning non-linear editing, refer to the instruction manual of your editing software.
- It is impossible to write data to the SD card on this unit from a PC

Operating environment (mass storage)

■ If using Windows

PC	IBM PC/AT compatible PC
OS	Windows 8 (32 bit/64 bit) Windows 7 (32 bit/64 bit) or SP1 Windows Vista (32 bit) (SP2) Windows XP (32 bit) (SP3)
CPU	Windows 8/Windows 7/Windows Vista: 1 GHz or higher 32-bit (×86) or 64-bit (×64) processor (including compatible CPU) Windows XP: Intel Pentium III 450 MHz or higher or Intel Celeron 400 MHz or higher
RAM	Windows 8/Windows 7: 1 GB or more (32 bit)/2 GB or more (64 bit) Windows Vista Home Basic: 512 MB or more Windows Vista Home Premium/Business/Ultimate/Enterprise: 1 GB or more Windows XP: 512 MB or more (1 GB or more recommended)
Interface	USB port
Other requirements	Mouse or equivalent pointing device

- Even if the system requirements mentioned in these operating instructions are fulfilled, some PCs cannot be used.
- Operation is not guaranteed in the following cases.
 - When 2 or more USB devices are connected to a PC, or when devices are connected through USB hubs or by using extension cables.
 - Operation on an upgraded OS.
 - Operation on an OS other than the one pre-installed.
- This software is not compatible with Microsoft Windows 3.1, Windows 95, Windows 98, Windows 98SE, Windows Me, Windows NT and Windows 2000.
- The USB equipment operates with the driver installed as standard in the OS.

■ If using Mac

PC	Mac
OS	Mac OS X 10.8.1
CPU	Intel Core 2 Duo or better
RAM	2 GB or more
Interface	USB port
Other requirements	Mouse or equivalent pointing device

- Even if the system requirements mentioned in these operating instructions are fulfilled, some PCs cannot be used.
- The USB equipment operates with the driver installed as standard in the OS.

Connecting to a PC

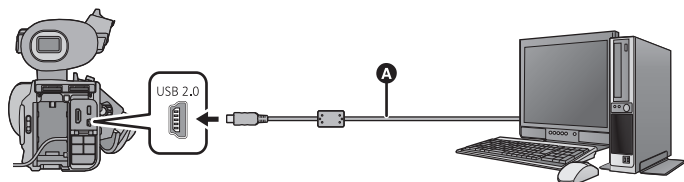

A USB cable (supplied)

- Insert the plugs as far as they will go.
- Insert the SD card.

1 Connect this unit to the AC adaptor.

- Use the AC adaptor to free you from worrying about the battery running down.

2 Turn on the unit.

3 Connect this unit to a PC.

- The USB function selection screen will appear on the screen of the unit.

4 Touch [PC] on the screen of this unit.

- This unit is automatically recognized as an external drive of the PC. (→ 82)
- When you select an option other than [PC], reconnect the USB cable.
- When using the battery, the LCD monitor turns off after about 5 seconds. Touch the screen to turn the LCD monitor on.

-
- Do not use any other USB cables except the supplied one. (Operation is not guaranteed with any other USB cables.)
 - When performing reading/writing between a PC and an SD card, be aware that some SD card slots built into PCs and some SD card readers are not compatible with the SDHC Memory Card or SDXC Memory Card.
 - If you are using an SDXC memory card, some PC may not recognize the data. Make sure your PC supports SDXC cards.

■ To disconnect USB cable safely

(If using Windows)

Select the  icon in task tray displayed on the PC, and then click [Eject AVCCAM Handheld].

- Depending on your PC's settings, this icon may not be displayed.

(If using Mac)

Drag [CAM_SD] disk icon to the [Trash], and then disconnect the USB cable.

About the screen indication of the unit

- Do not disconnect the USB cable, battery, or AC adaptor while the access lamp is on or card access icon () appears on the unit screen.
- If the screen does not change when the unit is operated while connected to a PC, disconnect the battery and/or AC adaptor, wait approximately 1 minute, reconnect the battery and/or AC adaptor, wait approximately 1 minute again, and then turn the unit back on. (Data may be destroyed when above operation is performed while accessing the SD card.)

About the PC display

When the unit is connected to a PC, it is recognized as an external drive.

- Removable disk (Example:  CAM_SD (F:)) is displayed in [Computer].

Data recorded using AVCHD format has excellent compatibility with computers, due to its file form; however, it contains not just image and sound data, but also various important information, and it is associated using a folder structure which is like a figure. If even part of this information is changed or erased, faults may occur; for example, it may not be possible for the data to be recognized as AVCHD data, or it may no longer be possible for the SD card to be used in an AVCHD device.

Data from a computer cannot be written to the SD card of this device.

When transferring data on an SD card to a computer or writing data stored in a computer back to the SD card using an SD card reader/writer, in order to prevent omissions in information, be sure to use the dedicated software AVCCAM viewer. It can be downloaded from the website below.

(Compatible OS: Windows XP/Windows Vista/Windows 7, and OS later than Mac OS X 10.4/Mac OS 10.5/Mac OS 10.6)

<http://pro-av.panasonic.net>

Example folder structure of an SD card:

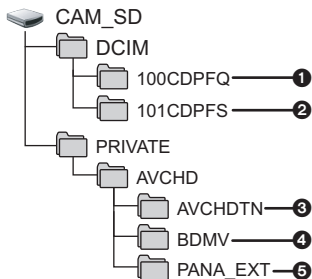

The following data will be recorded.

- ① **JPEG system still pictures (up to 999 still pictures can be recorded. ([11000001.JPG], etc.))**
- ② **JPEG system still pictures created from motion pictures**
- ③ **The motion picture thumbnails**
- ④ **AVCHD format motion picture files ([00000.MTS] etc.)**
- ⑤ **For management**

- Do not delete the SD card's folders. Doing so may make the SD card unusable in this unit.
- When data not supported by this unit has been recorded on a PC, it will not be recognized by this unit.
- Always use this unit to format SD cards.

Dubbing

Dubbing with a Blu-ray disc recorder

- In this manual, “Blu-ray disc recorder” is referred to as “BD recorder”. Insert a memory card containing video shot in AVCHD mode using the camera into a BD recorder manufactured by Panasonic to save the contents in a Blu-ray Disc, DVD, or HDD.

- Use a BD recorder that supports AVCHD. However, dubbing may not be performed even when AVCHD is supported. For details on how to perform dubbing onto a Blu-ray Disc, read the operating instructions of the BD recorder.
- When dubbing of videos shot with the camera is performed on a Blu-ray Disc (BD-RE, BD-R), HDD, or DVD, metadata information supported by the camera will be lost. In order to perform dubbing including metadata information, use the dedicated software AVCCAM viewer. (→ 82)

1 Remove the memory card from the camera after shooting.

Turn the power of the camera off before removing the memory card.

2 Insert the memory card into the memory card slot of the BD/DVD recorder.

For details on how to perform dubbing onto a Blu-ray Disc, read the operating instructions of the BD/DVD recorder.

- This function's default setting is [SCENE1].
- It is possible to switch the scene file by touching [SCN1] to [SCN6] while displaying the operation icons. (→ 64)
- It will return to the default settings when [SCENE] is selected in [INITIAL SET]. (→ 103)

[DETAIL LEVEL]

Adjusts the level of the image outline correction.

- 1 Touch [DETAIL LEVEL].
- 2 Touch [◀]/[▶] to adjust settings.
- 3 Touch [EXIT] to exit the menu screen.

[V DETAIL LEVEL]

Adjusts the degree of vertical outline correction in images.

- 1 Touch [V DETAIL LEVEL].
- 2 Touch [◀]/[▶] to adjust settings.
- 3 Touch [EXIT] to exit the menu screen.

[DETAIL CORING]

Adjusts the level to eliminate the noise of the detail.

- 1 Touch [DETAIL CORING].
 - 2 Touch [◀]/[▶] to adjust settings.
- Setting to – direction gives crisp images but allows a slight increase in noise. Setting in the + direction reduces noise.
- 3 Touch [EXIT] to exit the menu screen.

[CHROMA LEVEL]

Adjusts color density.

- 1 Touch [CHROMA LEVEL].
- 2 Touch [◀]/[▶] to adjust settings.
- 3 Touch [EXIT] to exit the menu screen.

[CHROMA PHASE]

Adjusts color balance.

- 1 Touch [CHROMA PHASE].
- 2 Touch [◀]/[▶] to adjust settings.
- 3 Touch [EXIT] to exit the menu screen.

[COLOR TEMP A ch]

Finely adjusts color temperature after Ach White Balance adjustment. (→ 41)

[COLOR TEMP B ch]

Finely adjusts color temperature after Bch White Balance adjustment. (→ 41)

[MASTER PED]

Adjustment of black level based on the image is performed.

- 1 Touch **[MASTER PED]**.
- 2 Touch **◀/▶** to adjust the black level.
- 3 Touch **[EXIT]** to exit the menu screen.

[AUTO IRIS LEVEL]

Adjusting brightness during the Auto Iris Mode. (→ 42)

[DRS]

Selects the DRS (Dynamic Range Stretcher) function.

It is possible to expand the dynamic range by compressing the video signal level of the highly illuminated area that gets washed out with standard recording.

- 1 Touch **[DRS]**.
- 2 Touch the desired setting item.

[OFF]/[1]/[2]/[3]

- Higher the value, greater the compression level of the highly illuminated area.
- Higher the value, greater the noise of the dark area.

- 3 Touch **[EXIT]** to exit the menu screen.



-
- If there are extremely dark or bright parts or the brightness is insufficient, the effect may not be clear.

[GAMMA]

Tone or contrast of the image is set in accordance with the recorded scenes.

- 1 Touch [GAMMA].
- 2 Touch the desired setting item.

[HD NORM]:	This gamma setting is suitable for high definition picture quality recording.
[LOW]:	This is a gamma setting with gradual slope at the low illuminated area. It will produce tranquil image with sharper contrast.
[SD NORM]:	This is the standard picture quality images setting.
[HIGH]:	This is a gamma setting with sharp slope at the low illuminated area. It will produce brighter image with wider gradation on the low illuminated area with softer contrast.
[B.PRESS]:	Makes the contrast shaper than [LOW].
[CINE-LIKE D]:	This is a gamma setting to make the image look like cinema.
[CINE-LIKE V]:	This is a gamma setting to make the image look like cinema with higher contrast than [CINE-LIKE D].

- Next (Previous) page can be displayed by touching /.
 - When you select [CINE-LIKE D] or [CINE-LIKE V], we recommend setting the iris darker than normal image for optimal results. (→ 42)
- 3 Touch [EXIT] to exit the menu screen.

[KNEE]

To avoid overexposure, select the compression level of the high intensity video signals received through the image sensor.

- 1 Touch [KNEE].
- 2 Touch the desired setting item.

[AUTO]:	Sets up automatically depending on the signal from the image sensor.
[LOW]:	Low setting (Compression starts at approx. 80%.)
[MID]:	Medium setting (Compression starts at approx. 90%.)
[HIGH]:	High setting (Compression starts at approx. 100%.)

- 3 Touch [EXIT] to exit the menu screen.

- The unit goes to [AUTO] and the setting cannot be changed in the following cases:
 - When [DRS] is set to a setting other than [OFF]
 - When [GAMMA] is set to [CINE-LIKE D] or [CINE-LIKE V]

[MATRIX]

Represents the color during the recording.

- 1 Touch **[MATRIX]**.
- 2 Touch the desired setting item.

[NORM1]: Suitable for recording in the open air or under a halogen lamp.

[NORM2]: Suitable for brighter colors than the [NORM1] mode.

[FLUO]: Suitable for recording indoors under fluorescent lamp.

[CINE-LIKE]: Suitable for cinema-like image.

- 3 Touch **[EXIT]** to exit the menu screen.

[SKIN TONE DTL]

[ON]/[OFF]

This makes skin colors appear softer for a more attractive appearance.

This is more effective if you record a person closely from the torso up.

- 1 Touch **[SKIN TONE DTL]**.
- 2 Touch **[ON]**.
- 3 Touch **[EXIT]** to exit the menu screen.

- If the background or anything else in the scene has colors similar to the skin color, they will also be smoothed.
- If the brightness is insufficient, the effect may not be clear.
- If you record a person in the distance, the face may not be recorded clearly. In this case, set [SKIN TONE DTL] to [OFF] or zoom in on the face (close-up) to record.

Recording Setup



MENU : [RECORD SETUP] → desired setting

[REC FORMAT]

Switch the picture quality of the motion pictures to record.

The frame rate and the recording method will vary depending on the recording format.

Recording format	Frame rate	Recording method
[PS 1080/60p]	60p	AVCHD Progressive
[PH 1080/60i]	60i	AVCHD
[PH 1080/30p] ^{*1}	30p	
[PH 1080/24p] ^{*2}	24p	
[HA 1080/60i], [HE 1080/60i], [SA 480/60i] ^{*3}	60i	

*1 Motion picture recorded in [PH 1080/30p] is converted to 1080/60i.

*2 It will output with 1080/60i when this unit is connected to a TV with a HDMI cable (optional).
(Video will be recorded with 1080/24p.)

*3 The image aspect ratio can be changed using [ASPECT]. (→ 92)

- When the frame rate is 60i, high-definition photography can be performed in the order [PH], [HA], [HE], and [SA].
- Smoother motion picture can be recorded with the higher value for the frame rate. [i] and [p] of the frame rate means interlace and progressive respectively.

Interlace (interlacing scanning)

Video signal that divides the effective scanning lines to half and send them alternatively

Progressive (progressive scanning)

High density video signal sending the effective scanning lines simultaneously (It will be higher quality image than the interlace)

- It can record with highest quality image in this unit when set to [PS].

Recordable time using the battery (→ 14)

- This function's default setting is [PH 1080/60i].
- Please refer to page 117 about approximate recordable time.
- When the unit is moved a lot or moved quickly, or when a fast-moving subject is recorded (particularly when recording in [HE] mode), mosaic-type noise may appear at playback.

[2 SLOTS FUNC.]



You can set the auto switch recording and backup recording.

- **Insert SD cards to card slot 1 and card slot 2.**

[OFF]:	Cancel the setting.
[AUTO SW]:	Set the auto switch recording
[BACKUP]:	Set the backup recording



■ Auto switch recording

This is simple relay recording. It is possible to continuously record on the SD card in the other card slot even when the available capacity of the SD card runs out during the recording. Note that there will be a momentary pause in the sound when recording media is switched.

-  is displayed on the media to record the video.  will disappear when the recording media is switched and the auto switch recording is started.
- The number of recording media switches in auto switch recording is limited to one.

■ Backup recording

Same motion picture can be recorded on two SD cards.

-   is displayed on the cards the motion pictures is recorded.
- When [SD CARD 1] is selected as the destination of recording the motion pictures, backup will be recorded on [SD CARD 2].
- It is recommended to record on the SD cards that are same speed class and same capacity when performing the backup recording.

(Auto switch recording)

- Destination to record still pictures will be switched to other SD card after performing the auto switch recording.

(Backup recording)

- Backup recording will not be performed for still pictures.
- When performing backup recording, even in the case where an error has occurred in one of the SD cards and recording has stopped, recording can be continued using the other SD card.
- When there is no more remaining recordable time, backup recording stops. When one of the SD cards has capacity remaining, the recording destination of video and photos changes to the SD card with capacity remaining.

[TIME LAPSE REC]

A scene that moves slowly for long period of time is recorded frame by frame with an interval, and is recorded as a short time motion picture.

One frame is recorded every recording interval that is set. The scene of one second is made up by 30 frames.



- **Switch to manual mode.** (→ 33)

[OFF]:

Cancel the setting.

[1 SECOND]/[10 SECONDS]/[30 SECONDS]/[1 MINUTE]/[2 MINUTES]:

Change the recording interval.

-  appears on the screen.
- After recording, the setting of interval recording is canceled.
- Audio cannot be recorded. ( It will be silent in 2 ch)

Setup example	Setup time (recording interval)	Recording time	Recorded time
Sunset	1 s	Approx. 1 h	Approx. 2 m
Blooming	30 s	Approx. 3 h	Approx. 12 s

- Maximum recordable time is 12 hours.

- Still picture recording cannot be used.
- When the interval recording is set, [REC FORMAT] is set to [HA], and the setting cannot be changed.
- [TC MODE] is set to [NDF] and [TCG] is set to [REC RUN]. (→ 52)
- [TIME LAPSE REC] is canceled in the following cases.
 - If you turn the unit off
 - If you change the mode
- The shortest motion picture recording time is 1 second.
- Color balance and focus may not be adjusted automatically depending on light sources or scenes. If so, manually adjust these settings. (→ 38, 40)

[PRE-REC]

It will switch to the recording screen and record the image and audio from approximately 3 seconds prior to pressing the recording start/stop button when [PRE-REC] is touched.

-  appears on the screen.

- **Aim the unit at the subject beforehand.**
- There is no beep sound.
- PRE-REC is canceled in the following cases.
 - If you turn the unit off
 - If you change the mode
 - After 3 hours have passed
 - Press the MENU button
- Video from 3 seconds prior cannot be recorded when the recording is started within approximately 3 seconds after setting the PRE-REC and switching to recording screen.

- Images displayed on the thumbnail in Playback Mode will differ from the motion pictures displayed at the start of playback.

[TC MODE]

[DF]/[NDF]

Select the compensation mode for the time code. (→ 52)

[TCG]

[FREE RUN]/[REC RUN]

Sets the way the time code will move. (→ 52)

[TC PRESET]

Initial value of the time code can be set. (→ 53)

[UB PRESET]

User Information can be set. (→ 53)

[ASPECT]

Image aspect ratio for the recording format [SA 480/60i] can be changed.

- Set [REC FORMAT] to [SA 480/60i]. (→ 89)

[16:9]/[4:3]

- When using the LCD monitor, when the aspect ratio is set to [4:3], black bands are displayed on the left and right of the screen.

[i.Zoom]

[ON]/[OFF]

This zoom function allows you to maintain high-definition picture quality. (Up to 25×)

[HYBRID O.I.S.]

[ON]/[OFF]

You can set the Hybrid Optical Image Stabilizer. (→ 37)

[AUTO SLOW SHTR]

[ON]/[OFF]

You can record bright pictures even in dark places by slowing the shutter speed.

- The shutter speed is 1/30 or more depending on the ambient brightness.
(The shutter speed is 1/24 or more when the [REC FORMAT] is set to [PH 1080/24p])
- When the shutter speed becomes 1/30, the screen may be seen as if frames are missed and after images may appear.

[WIND NOISE CANCELER]

[ON]/[OFF]

This will reduce the wind noise coming into the built-in microphones while maintaining the realism.

- Set the [MIC SETUP] to anything other than [2ch]. (→ 45)
- You may not see the full effect depending on the recording conditions.

[MIC SETUP]

[SURROUND]/[ZOOM MIC]/[FOCUS MIC]/[2ch]

Recording setting of the built-in microphone can be adjusted. (→ 45)

[5.1ch MIC LEVEL]

[AUTO]/[SET]/[SET+ **ALC**]

When recording, the input level from the built-in microphones can be adjusted. (→ 49)

[BASS SETTING]

Change the lower setting of the built-in microphone (5.1 ch) according to your choice.

- Set the [MIC SETUP] to [SURROUND] or [ZOOM MIC]. (→ 45)

[0dB]/[+3dB]/[+6dB]/[LOWCUT]

- Normally set to [0dB].
- Select [+3dB] or [+6dB] to get strong power feeling at bass level.

[2ch MIC ALC]

[ON]/[OFF]

- Set [MIC SETUP] to [2ch]. (→ 45)

Distortion of the sound can be reduced when the built-in microphone (2 ch) or external microphone is used by setting to [ON]. ([ALC] is displayed on the recording screen) It will record with natural sound when set to [OFF].

- Adjust the audio control knobs (CH1, CH2) to adjust the audio input level.

[EXT. MIC GAIN1]

[-50dB]/[-60dB]

Sets the input level of the external microphone connected to the audio input terminal 1 (XLR 3 pin).

[EXT. MIC GAIN2]

[-50dB]/[-60dB]

Sets the input level of the external microphone connected to the audio input terminal 2 (XLR 3 pin).

Switch and display setting

Menu items displayed are different depending on the position or setting of the mode switch.

MENU : [SW & DISP SETUP] → desired setting

[MEDIA SELECT]



[SD CARD 1] and [SD CARD 2] can be selected separately to record motion pictures or still pictures. (→ 29)

[IRIS RING]



Sets the rotation direction and iris control of the iris ring.

- Switch to manual mode. (→ 33)

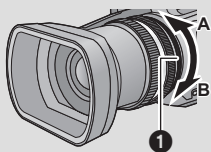

[DOWN OPEN]: Iris will open when it is turned toward B.

[UP OPEN]: Iris will open when it is turned toward A.

- 1 Iris ring

[USER BUTTON SETUP]



Sets the function to assign to the USER buttons. (→ 55)

[USER BUTTON DISPLAY]



[ON]/[OFF]

Switches the display of the set USER button icons. (→ 56)

[ZEBRA DETECT 1]



Selects the brightness level of the left-leaning zebra patterns on the screen.

- 1 Touch [ZEBRA DETECT 1].
 - Touch [YES].
- 2 Touch ◀/▶ to adjust settings.
- 3 Touch [ENTER].
 - Touch [EXIT] to exit the menu screen.

[ZEBRA DETECT 2]



[SET]/[OFF]

Selects the brightness level of the right-leaning zebra patterns on the screen.

1 Touch [ZEBRA DETECT 2].

- Touch [SET].

2 Touch  /  to adjust settings.

3 Touch [ENTER].

- Touch [EXIT] to exit the menu screen.
- Zebra 2 can be displayed by pressing the ZEBRA button after setting. (→ 62)

[MARKER]



[ON]/[OFF]

Displaying of the luminance level display marker can be switched.

- Marker can be displayed by pressing ZEBRA button when set to [ON]. (→ 62)

[GUIDE LINES]



[OFF] / /

You can check if the image is level while recording motion pictures and still pictures. The function can also be used to estimate the balance of the composition.

- The guidelines do not appear on the images actually recorded.
-
- When Focus Assist is set to on, the following occurs. (→ 39)
 - The guidelines are not displayed. (these are displayed on the TV when this unit is connected to TV.)
 - The setting cannot be changed.

[SAFETY ZONE]



[90%]/[OFF]

Display of the range that can be displayed with the common household TV (safety zone) can be switched.

- The safety zone is not displayed on the images that is actually recorded.

[REC COUNTER]



[TOTAL]/[SCENE]

Selects the operation of the Recording Counter during recording. (→ 54)

[VIDEO OUT OSD]



[ON]/[OFF]

The information displayed on the screen (operation icon and counter display etc.) can be displayed/not displayed on the TV. (→ 77)

[DATE/TIME]



[OFF]/[TIME]/[DATE]/[DATE&TIME]

It is possible to change the date and time display mode.

- You can also show or change the date and time display by repeatedly pressing the DATE/TIME button on the wireless remote control. (→ 25)

[DATE FORMAT]



[Y/M/D]/[M/D/Y]/[D/M/Y]

It is possible to change the date format.

[LEVEL METER]



[ON]/[OFF]

- (In Playback Mode)

Change the mode to  and touch the play mode select icon.

Then, set [VIDEO/PICTURE] to [VIDEO]. (→ 65)

Select to display the audio level meter.

[LENS STATUS]



[ON]/[OFF]

Display relating to lens can be switched. (Zoom Display, Optical Image Stabilizer, Focus Display, White Balance, Iris, Gain, Auto Iris, Shutter Speed)

[CARD&BATTERY]



[ON]/[OFF]

Display can be switched between the remaining recordable time of the SD card and the remaining battery capacity indication.

[OTHER DISPLAY]



[ON]/[OFF]

Display which remains displayed even when [USER BUTTON DISPLAY], [GUIDE LINES], [SAFETY ZONE], [DATE/TIME], [LEVEL METER], [LENS STATUS] and [CARD&BATTERY] are set to [OFF] can be switched.

[FACE FRAMING]



Detected faces appear with frames in the Intelligent Auto Mode.

[OFF]:

Cancel the setting.

[PRIMARY]:

Only the prioritized face framing is displayed.

[ALL]:

All face detection framings are displayed.



- Up to 15 frames are indicated. Larger faces and faces nearer to the center of the screen take preference over others.

■ Prioritized face framing

Prioritized face framing is displayed as orange frames. Focus and adjustment of brightness will be performed against the prioritized face framing.

- Prioritized face framing is only displayed with Portrait Mode in the Intelligent Auto Mode.
- The white frame is for face detection only.

- It cannot be set while in the Interval Recording is used.

[POWER LCD]



[ON]/[OFF]

This makes it easier to view the LCD monitor in bright places including outdoors. (→ 20)

[LCD SET]



It adjusts brightness and color density on the LCD monitor. (→ 21)

[EVF SET]



[BRIGHT]/[NORMAL]/[DARK]

Brightness of the viewfinder can be switched. (→ 21)

[SELF SHOOT]



[MIRROR]/[NORMAL]

Switches the mirror function of the LCD monitor when recording yourself. (→ 22)

The image on the LCD monitor is displayed mirrored horizontally during recording of yourself when it is set to [MIRROR].

[EVF COLOR]



[ON]/[OFF]

The recording images or playback images on the viewfinder can be selected between color/black and white. (→ 22)

[SUB REC BUTTON]



Enable/disable of the sub recording start/stop button on the handle can be switched.

[ON]: The sub recording start/stop button is enabled.

[OFF]: The sub recording start/stop button is disabled.

[SUB ZOOM]



Enable/disable of the sub zoom lever on the handle can be switched. Zoom speed will be different depending on the setting.

[OFF]: Sub zoom lever is disabled.

[LOW]: Sub zoom lever is enabled. (Zoom speed: Slow)

[MID]: Sub zoom lever is enabled. (Zoom speed: Standard)

[HIGH]: Sub zoom lever is enabled. (Zoom speed: Fast)

Other Functions

Menu items displayed are different depending on the position or setting of the mode switch.

MENU  : [OTHER FUNCTION] → desired setting

[FORMAT CARD]



The SD card can be formatted. (→ 28)

- Please be aware that if a medium is formatted, then all the data recorded on the medium will be erased and cannot be restored. Back up important data on a PC, disc etc. (→ 79)

[CARD STATUS]



The used space and remaining recordable time of the SD card can be checked.

- Touching [CHANGE MEDIA] switches the unit between the display for the SD card 1 and the display for the SD card 2.
 - When the mode switch is set to  , remaining recordable time for the selected recording mode is displayed.
 - Touch [EXIT] to close the indication.
-
- The SD card requires some space to store information and manage system files, so the actual usable space is slightly less than the indicated value. The usable space is generally calculated as 1 GB=1,000,000,000 bytes. The capacities of this unit, PCs and software are expressed as 1 GB=1,024×1,024×1,024=1,073,741,824 bytes. Therefore, the indicated value of the capacity appears to be smaller.

[REMOTE CONTROL]



[ON]/[OFF]

The wireless remote control (supplied) can be used. (→ 25)

[REC LAMP]



[ON]/[OFF]

The recording lamp lights up during recording and flashes when the unit receives a signal from the wireless remote control. When this is set to [OFF], it does not light during recording.

[CLOCK SET]



Set date and time. (→ 23)

[TIME ZONE]



Set the time difference from Greenwich Mean Time. (→ 23)

[ALERT SOUND]



[OFF]/ (Volume low)/ (Volume high)

Touch screen operation, start and stop of recording can be confirmed with this sound.

2 Beeps for 4 times

When an error occurs. Check the sentence displayed on the screen. (→ 107)

[ECONOMY (BATT)]



[ON]/[OFF]

When about 5 minutes have passed without any operation, this unit automatically turns off to save battery life.

- This unit will not automatically turn off even if the [ECONOMY (BATT)] is set to [ON] in following cases:
 - using the USB cable for PC etc.
 - PRE-REC is used

[ECONOMY (AC)]



[ON]/[OFF]

When connected to AC adaptor about 30 minutes have passed without any operation, this unit automatically turns off.

- This unit will not automatically turn off even if the [ECONOMY (AC)] is set to [ON] in following cases:
 - using the USB cable for PC etc.
 - PRE-REC is used

[QUICK POWER ON]



[ON]/[OFF]

The unit is put into recording pause approx. 2 seconds when the unit is turned on with the mode set to .

- Depending on the recording conditions, start time may be longer than 2 seconds.
- In the quick power on mode, the zoom magnification becomes approximately 1×.

[TV ASPECT]



[16:9]/[4:3]

Change the menu setting to display the images correctly. (Check the TV setting.) (→ 77)

[HDMI RESOLUTION]



[AUTO]/[1080p]/[1080i]/[480p]

Select the desired method of HDMI output. (→ 78)

[AV MULTI]



[COMPONENT]/[AV OUT]

AV multi connector output setting can be changed. (→ 78)

[COMPONENT OUT]



[480i]/[1080i]

Output setting of the component terminal for the AV multi terminal can be changed. (→ 78)

[INITIAL SET]



The menu settings or [CUSTOMIZE SCENE] back to the default setting. (→ 84)

[ALL]: This is for initializing all menus.

[SCENE]: This is for initializing the setting of customize scene.

- Settings for [REC FORMAT], [MEDIA SELECT], [CLOCK SET] and [LANGUAGE] will not be changed.

[SYSTEM INFO]



The version of the firmware of this device is displayed.

[UPDATE]



The firmware of this device is updated. (→ 111)

[OPERATION TIME]



The accumulated operating time of this device is displayed.

[H/PHONE MODE]



Selects the sound heard through the headphones.

[LIVE]: The sound which has been input from the microphone is output as is. This setting is selected when delays in the sound are annoying.

[RECORDING]: The sound in the status which is to be recorded (the sound synchronized with the images) is output.

- When this unit is connected to a TV using the HDMI cable (optional), audio at the time of the [RECORDING] setting is output even if this setting is set to [LIVE].

[LANGUAGE]



You can select the language on the screen display and the menu screen.

Video Setup



- Change the mode to  and touch the play mode select icon. Then, set [VIDEO/PICTURE] to [VIDEO]. (→ 65)

 : [VIDEO SETUP] → desired setting

[REPEAT PLAY]

[ON]/[OFF]

Playback of the first scene starts after playback of the last scene finishes when set to [ON]. (→ 70)

[RESUME PLAY]

[ON]/[OFF]

If playback of a scene was stopped halfway, the playback can be resumed from where it was stopped when set to [ON]. (→ 71)

[SCENE PROTECT]

Scenes can be protected so that they are not deleted by mistake.
(Even if you protect some scenes, formatting the SD card will delete them.) (→ 74)

[DELETE]

Deletes a scene. (→ 73)

Picture Setup



- Change the mode to  and touch the play mode select icon. Then, set [VIDEO/PICTURE] to [PICTURE]. (→ 65)

 : [PICT. SETUP] → desired setting

[SCENE PROTECT]

Still pictures can be protected so that they are not deleted by mistake.
(Even if you protect some still pictures, formatting the SD card will delete them.) (→ 74)

[DELETE]

Deletes a still picture. (→ 73)

Indications

■ Recording indications

Example: AG-AC90PJ

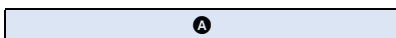
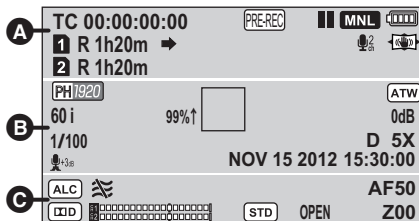

TC 00:00:00:00

Counter display (→ 51)

PRE-REC PRE-REC (→ 91)

← Interval recording (→ 91)

●/II (Red) Recording

II (Green) Recording pause

iA / iD / iA / iC / iF

Intelligent Auto Mode (→ 33)

MNL Manual Mode (→ 33)

||||| Remaining battery power (→ 14)

1 / 2 (White) Recording to card possible (motion picture)

1 / 2 (Green) Card is being recognized (motion picture)

R 1h20m Remaining time for motion picture recording (→ 30)

→ Auto switch recording (→ 90)

↔ Backup recording (→ 90)

5.1 ch Surround Microphone (→ 45)

ZOOM Zoom Microphone (→ 45)

🎤 Focus Microphone (→ 45)

2 ch Stereo Microphone (→ 45)



Image Stabilizer (→ 37)

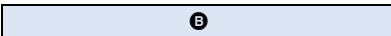

PS1920 / PH1920 / HA1920 / HE1440 / SA

Recording format (→ 89)

ATW / LOCK / P3.2k / P5.6k / Ach / Bch

White Balance (→ 40)

60i/60p/30p/24p Frame rate (→ 89)

99%↑ Luminance level (→ 62)

AGC / 0dB Gain value (→ 42)

1/100 Shutter speed (→ 44)

D 5X Digital zoom (→ 59)

3dB / 6dB / LOW CUT Bass setting (→ 94)

(AG-AC90PJ)

NOV 15 2012 Date indication

15:30:00 Time indication (→ 23)

(AG-AC90P)









11 15 2012 Date indication







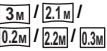





15:30:00 Time indication (→ 23)

(AG-AC90PX)

2012 11 15 Date indication

15:30:00 Time indication (→ 23)

C	
	5.1 ch Microphone Level (ALC) (→ 49)/ 2 ch Microphone ALC (→ 94)
	Wind Noise Canceler (→ 93)
AF50/MF50/ AF 00/MF 00	Focus (→ 38)
	Audio recording format (Dolby Digital) (→ 45)
<div style="display: flex; justify-content: space-between;"> □□□□□□□□□□□□□□□□□□□□ (5.1 ch) </div> <div style="display: flex; justify-content: space-between;"> 1 □□□□□□□□□□□□□□□□□□□□ (2 ch) </div>	
Audio level meter (→ 50)	
	Auto iris mode (→ 42)
	Backlight Compensation (→ 57)
	Spotlight (→ 58)
OPEN/F2.0	Iris value (→ 42)
Z00/Z 99	Zoom magnification (→ 35)
1 / 2 (White)	Card recording possible status (still picture)
	Number of recording pixels for still pictures (→ 31, 70)
In Playback Mode, the picture size is not displayed for still pictures recorded with other products that have different picture sizes from the sizes shown above.	
R3000	Remaining number of still pictures (→ 31)
	Recording still picture
■ Playback indications	
▶/ ▶▶/▶▶▶/◀◀/◀◀◀/▶/◀/▶▶/ ◀◀/▶/◀/ ▶/◀◀	
Display during playback (→ 65, 68)	
TC 00:00:00:00	
Counter Display (→ 51)	
No.10	Scene Number (In Playback Mode)
No.0010	Scene Number (In 1-scene display in thumbnail mode)

(AG-AC90PJ)	
15:30:00	Time indication (→ 23)
NOV 15 2012	Date indication
(AG-AC90P)	
15:30:00	Time indication (→ 23)
11 15 2012	Date indication
(AG-AC90PX)	
15:30:00	Time indication (→ 23)
2012 11 15	Date indication
	Audio recording format (Dolby Digital)
	Audio recording format (Linear PCM)
	Repeat Playback (→ 70)
	Resume Playback (→ 71)
100-0001	Still picture folder/file name
On	Protected motion pictures/still pictures (→ 74)
	
Recording format (→ 65, 89)	
10	Scene Number (In 9-scene display in thumbnail mode)
■ Indication of connection to other devices	
	Accessing the card (→ 82)
■ Confirmatory indications	
-- (Time display)	The built-in battery is low. (→ 23)
	Warning for recording of yourself (→ 22)
	SD card is not inserted.
	SD card is write-protected.
	SD card is non-compatible.
	SD card is full.
	Playback-only SD card

Messages

Major confirmation/error messages to be indicated on the screen in text.

CHECK CARD.

This card is not compatible or it cannot be recognized by the unit.

If this message appears even though motion pictures and still pictures are recorded on an SD card, the card may be unstable. Reinsert the SD card, then turn the unit off and then on again.

INVALID/CANNOT SET.

Since there is a condition to use the function, it is required to cancel/change other settings.

Others

Troubleshooting

It is not a malfunction in following cases

The lens or LCD monitor fog up.	<ul style="list-style-type: none"> This is due to condensation. It is not a breakdown. Please refer to page 2.
A clicking sound is heard when the unit is shaken.	<ul style="list-style-type: none"> This is the sound of the lens moving and is not a defect. This sound will no longer be heard when the unit is turned on and change the mode to .
Object seems to be warped.	<ul style="list-style-type: none"> Object seems to be warped slightly when the object moves across the image very fast, but this is because the unit is using MOS for the image sensor. This is not a malfunction.

Power

Problem	Check points
<p>This unit cannot be turned on.</p> <p>This unit does not stay on long enough.</p> <p>Battery runs down quickly.</p>	<ul style="list-style-type: none"> Charge the battery again to ensure it is sufficiently charged. (→ 12) In cold places, the battery using time becomes shorter. The battery has a limited life. If the operating time is still too short even after the battery is fully charged, the battery has worn out and needs to be replaced.
<p>This unit cannot be operated though it is turned on.</p> <p>This unit does not operate normally.</p>	<ul style="list-style-type: none"> Remove the battery or AC adaptor, wait about 1 minute and then reconnect the battery or AC adaptor. Then about 1 minute later, turn on the unit again. (Conducting the above operation while the media is being accessed may damage the data on the media.) If normal operation is still not restored, detach the power connected, and consult the dealer who you purchased this unit from.

Power

Problem	Check points
<p>“ERROR OCCURRED. PLEASE TURN UNIT OFF, THEN TURN ON AGAIN.” is displayed.</p>	<ul style="list-style-type: none"> ● The unit has automatically detected an error. Restart the unit by turning off and on. ● The unit will be turned off in about 1 minute if the unit is not turned off and on. ● Repair is needed if it is repeatedly displayed even if it is restarted. Detach the power connected, and consult the dealer who you purchased this unit from. Do not attempt to repair the unit by yourself.



Indication

Problem	Check points
<p>Function display (Remaining Display, Counter Display, etc.) is not displayed</p>	<ul style="list-style-type: none"> ● [CARD&BATTERY] or [OTHER DISPLAY] of the [SW & DISP SETUP] is [OFF]. (→ 97) ● Press the COUNTER button to switch the counter display. (→ 51)

Recording

Problem	Check points
<p>The unit arbitrarily stops recording.</p>	<ul style="list-style-type: none"> ● Use an SD card that can be used for motion picture recording. (→ 16) ● The recordable time may have shortened due to the deterioration of the data writing speed or repeated recording and deletion. Using the unit, format the SD card. (→ 28)
<p>Auto Focus function does not work.</p>	<ul style="list-style-type: none"> ● Switch to Intelligent Auto Mode. ● If you are trying to record a scene which is hard to bring into focus in Auto Focus Mode, use the Manual Focus Mode to adjust the focus. (→ 34, 38)
<p>Color or brightness of the image changes, or you may see horizontal bars in the image.</p> <p>The LCD monitor flickers indoors.</p>	<ul style="list-style-type: none"> ● Color or brightness of the image may change, or you may see horizontal bars in the image when the object is recorded under fluorescent light, mercury light or sodium light, etc., but this is not a malfunction. ● Perform following operation. <ul style="list-style-type: none"> – Record in the Intelligent Auto Mode – Set the shutter speed to 1/60 in areas where the power supply frequency is 60 Hz, or 1/100 in areas of 50 Hz.

Playback

Problem	Check points
Scenes/still pictures cannot be played back.	<ul style="list-style-type: none"> Any scenes/still pictures where the thumbnails are displayed as  cannot be played back.
Scenes/still pictures cannot be deleted.	<ul style="list-style-type: none"> Release the protect setting. (→ 74) Any scenes/still pictures where the thumbnails are displayed as  cannot be deleted. If the scenes/still pictures are unnecessary, format the media to erase the data. (→ 28) Please be aware that if a media is formatted then all the data recorded on the media is erased and cannot be recovered. Back up important data on a PC, disc etc.

With other products

Problem	Check points
<p>Although this unit is correctly connected to a TV, images cannot be seen.</p> <p>The images are squeezed horizontally.</p>	<ul style="list-style-type: none"> Please read the operating instructions of your TV and select the channel that matches the input used for the connection. Change the setting of the unit depending on the cable connecting to the TV. (→ 78)
If the SD card is inserted in another device, it is not recognized.	<ul style="list-style-type: none"> Check that the device is compatible with the capacity or type of SD card (SD Memory Card/SDHC Memory Card/SDXC Memory Card) that you inserted. Refer to the operating instructions of the device for details.
When connected by the USB cable, this unit is not detected by the other devices.	<ul style="list-style-type: none"> When connected to other devices using only the battery, reconnect using the AC adaptor.

With a PC

Problem	Check points
When connected by the USB cable, this unit is not detected by the PC.	<ul style="list-style-type: none"> After re-inserting the SD card into the unit, reconnect the supplied USB cable. Select another USB terminal on the PC. Check the operating environment. (→ 79) Connect the supplied USB cable again after restarting the PC and turning on this unit again.
When the USB cable is disconnected, an error message will appear on the PC.	<ul style="list-style-type: none"> To disconnect the USB cable safely, double-click the  icon in the task tray and follow the instructions on the screen.

Others

Problem	Check points
If the SD card is inserted in this unit, it is not recognized.	<ul style="list-style-type: none"> ● If the SD card is formatted on a PC, it may not be recognized by this unit. Use this unit to format SD cards. (→ 28)
The wireless remote control does not function.	<ul style="list-style-type: none"> ● [REMOTE CONTROL] of the [OTHER FUNCTION] is [OFF]. (→ 25) ● The button-type battery of the wireless remote control may be run out. Replace it with a new button-type battery. (→ 25)

■ If scenes do not change smoothly when played back on another device

The images may be still for several seconds at the joins between the scenes if the following operations are performed when multiple scenes have been continuously played back using another unit.

- Just how smoothly the scenes will be played back depends on the playback unit. Depending on the unit used, the images may stop moving and become still for a moment even when none of the following conditions are applicable.
- A continuous recording of motion picture data that exceeds 4 GB may momentarily stop at every 4 GB of data when played back with another device.

Principal reasons for not playing back smoothly

● The recording format [PS] was switched to another recording format when a scene was recorded
● When the scenes were recorded on different dates
● When scenes lasting under 3 seconds have been recorded
● When PRE-REC was used for recording
● When deleting scenes
● When scenes recorded more than 99 scenes on the same date

About recovery

If faulty management information is found, the messages may appear and a repair is performed. (Repairing may take time depending on the error.)

-  is displayed when abnormal management information is detected when the scenes are displayed in thumbnail.

■ AVCCAM Restorer

Restoration can be performed using AVCCAM Restorer.

It can be downloaded from the website below.

<http://pro-av.panasonic.net>

- For details on usage, please read the AVCCAM Restorer Operating Instructions (PDF file).
-

- Use a sufficiently charged battery or the AC adaptor.
- Depending on the condition of the data, it may not be possible to completely repair the data.
- If recovery fails, it will not be possible to play back scenes recorded before the unit turned off.
- When data recorded on another device is recovered, it may not be possible to play back the data on this unit or the other device.
- If recovery fails, turn the unit off and on again after waiting awhile. If recovery fails repeatedly, format a media on the unit. Please be aware that if a media is formatted, then all the data recorded on the media will be erased.
- If the thumbnail information is recovered, displaying the thumbnails may become slower.

Others

Updating the firmware incorporated into the unit

To check the latest information on the firmware and update methods, refer to the following support page on the Panasonic website.

<http://pro-av.panasonic.net>

Cautions for use

About this unit

The unit and the SD card become warm during use. This is not a malfunction.

Keep this unit as far away as possible from electromagnetic equipment (such as microwave ovens, TVs, video games etc.).

- If you use this unit on top of or near a TV, the pictures and/or sound on this unit may be disrupted by electromagnetic wave radiation.
- Do not use this unit near cell phones because doing so may result in noise adversely affecting the pictures and/or sound.
- Recorded data may be damaged, or pictures may be distorted, by strong magnetic fields created by speakers or large motors.
- Electromagnetic wave radiation generated by microprocessors may adversely affect this unit, disturbing the pictures and/or sound.
- If this unit is adversely affected by electromagnetic equipment and stops functioning properly, turn this unit off and remove the battery or disconnect AC adaptor. Then reinsert the battery or reconnect AC adaptor and turn this unit on.

Do not use this unit near radio transmitters or high-voltage lines.

- If you record near radio transmitters or high-voltage lines, the recorded pictures and/or sound may be adversely affected.

Make sure to use the supplied cords and cables. If you use optional accessories, use the cords and the cables supplied with them.

Do not extend the cords and the cables.

Do not spray insecticides or volatile chemicals onto the unit.

- If the unit is sprayed with such chemicals, its body may be marred and the surface finish may peel off.
- Do not leave rubber or plastic products in contact with the unit for a long time.

When you use the unit in a sandy or dusty place such as a beach, do not let sand or fine dust get into the body and terminals of the unit.

Also, keep the unit away from sea water.

- Sand or dust may damage the unit. (Care should be taken when inserting and removing a card.)
- If sea water splashes onto the unit, wipe off the water with a well wrung cloth. Then wipe the unit again with a dry cloth.

When carrying the unit, do not drop or bump it.

- A strong impact can break the unit's casing, causing it to malfunction.
- When carrying this unit, please hold the hand strap or shoulder strap firmly and treat it with care.

Cleaning

- Before cleaning, detach the battery or pull the AC cable from the AC outlet, and then wipe the unit with a soft, dry cloth.
- If the unit is very dirty, dip a cloth in water and squeeze firmly, and then wipe the unit with the damp cloth. Next, dry the unit with a dry cloth.
- Use of benzine, paint thinner, alcohol, or dishwashing liquid may alter the camera body or peel the surface finish. Do not use these solvents.
- When using a chemical dust cloth, follow the instructions that came with the cloth.

When you are not going to use the unit for an extended time

- When storing the unit in a cupboard or cabinet, it is recommended that you place a desiccant (silica gel) in with it.

Do not lift up this unit by the handle with the tripod still attached

- When the tripod is attached, its weight will also affect the unit's handle, possibly causing the handle to break and hurting the user.
- To carry the unit while the tripod is attached, take hold of the tripod.

Do not swing the unit around, shake it by, or allow it hang from the handle

- Do not jar, swing, or shake the unit by its handle. Any strong jolt to the handle may damage the unit or result in personal injury.

Do not allow the cord to drag on the ground or pull a connected cord along the passage

- The cord will be damaged, causing fire or electrical shock, when the cord gets caught by the feet, excite will also cause personal injury.

About the battery

The battery used in this unit is a rechargeable lithium-ion battery. It is susceptible to humidity and temperature and the effect increases the more the temperature rises or falls. In cold areas, the full charge indication may not appear or the low battery indication may appear about 5 minutes after starting use. At high temperatures, the protection function may be triggered, making it impossible to use the unit.

Be sure to detach the battery after use.

- If the battery is left attached, a minute amount of current continues to flow even if the unit is off. Keeping the unit in this state may result in over discharge of the battery. This may result in you not being able to use the battery even after it is charged.
- The battery should be stored in the vinyl bag so metal does not come into contact with the terminals.
- The battery should be stored in a cool place free from humidity, with as constant temperature as possible. (Recommended temperature: 15 °C to 25 °C (59 °F to 77 °F), Recommended humidity: 40%RH to 60%RH)
- Extremely high temperatures or low temperatures will shorten the life of the battery.
- If the battery is kept in high-temperature, high-humidity, or oily-smoky places, the terminals may rust and cause malfunctions.
- To store the battery for a long period of time, we recommend you charge it once every year and store it again after you have completely used up the charged capacity.
- Dust and other matter attached to the battery terminals should be removed.

Prepare spare batteries when going out for recording.

- Prepare batteries enough to last for 3 to 4 times the period you are planning to record for. Cold places such as a ski resort can shorten recording time.

If you drop the battery accidentally, check to see if the terminals are damaged.

- When this unit or battery charger is attached with the terminal part in a deformed state, this unit or battery charger may be damaged.

Do not throw old battery into fire.

- Heating a battery or throwing it into a fire may result in an explosion.

If the operating time is very short even after the battery has been recharged, the battery has worn out. Please purchase a new battery.

About the AC adaptor/battery charger

- If the temperature of the battery is extremely high or extremely low, charging may take time or the battery may not be charged.
- If the charging lamp keeps flashing, make sure that the terminals of the battery or the battery charger are not exposed to dirt, foreign objects or dust, then reconnect them properly.
Disconnect the AC cable from the AC outlet when you remove dirt, foreign objects or dust on the terminals of the battery or the battery charger.
If the charging lamp is still flashing, the temperature of the battery may be extremely high or extremely low or something may be wrong with the battery or battery charger. Contact your dealer.
- If you use the AC adaptor or battery charger near a radio, radio reception may be disturbed. Keep the AC adaptor or battery charger 1 m (3.3 feet) or more away from the radio.
- When using the AC adaptor or battery charger, it may generate whirring sounds. However, this is normal.
- After use, be sure to disconnect the AC cable from the AC outlet. (If you leave this unit connected, the AC adaptor will consume approximately 0.3 W and the battery charger approximately 0.3 W of current.)
- Always keep the electrodes of the AC adaptor, battery charger and battery clean.

About the SD card

When disposing of or giving away the SD card, note that:

- Formatting and deletion of this unit or computer only changes the file management information and does not completely delete the data in the SD card.
- It is recommended that the main SD card is either physically destroyed or the SD card is physically formatted using this unit when disposing of or giving away the SD card.
- To physically format, connect this unit to the AC adaptor, select [OTHER FUNCTION] → [FORMAT CARD] → [SD CARD 1] or [SD CARD 2] from the menu, and touch [YES]. Press and hold recording start/stop button in the following screen for three seconds. Screen to delete the SD card data is displayed, so select [YES] and follow the instruction on the screen.

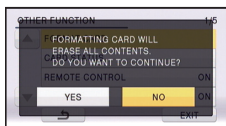

- The customer is responsible for the management of the data in the SD card.

LCD monitor/viewfinder

- When the LCD screen is dirty or condensation has occurred, please wipe it using a soft cloth such as a lens cloth.
- Do not touch the LCD monitor with your finger nails, or rub or press with strong force.
- It may become hard to see or hard to recognize the touch when the LCD protection sheet is affixed.
- When the unit has become very cold, for example due to storage in a cold area, its LCD monitor will be slightly darker than usual immediately after the unit is turned on. The normal brightness will be restored when the unit's internal temperature rises.

Extremely high precision technology is employed to produce the LCD Monitor screen. The result is more than 99.99% effective dots with a mere 0.01% of the dots inactive or always lit. However, this is not a malfunction and does not affect the recorded picture.

Extremely high precision technology is employed to produce the viewfinder screen. The result is more than 99.99% effective dots with a mere 0.01% of the dots inactive or always lit. However, this is not a malfunction and does not affect the recorded picture.

About copyright

■ Carefully observe copyright laws

IMPORTANT

“Unauthorized recording of copyrighted television programs, video tapes and other materials may infringe the right of copyright owners and be contrary to copyright laws.”

■ Licenses

- SDXC Logo is a trademark of SD-3C, LLC.
 - “AVCHD”, “AVCHD Progressive” and the “AVCHD Progressive” logo are trademarks of Panasonic Corporation and Sony Corporation.
 - Manufactured under license from Dolby Laboratories. Dolby and the double-D symbol are trademarks of Dolby Laboratories.
 - HDMI, the HDMI Logo, and High-Definition Multimedia Interface are trademarks or registered trademarks of HDMI Licensing LLC in the United States and other countries.
 - Microsoft®, Windows® and Windows Vista® are either registered trademarks or trademarks of Microsoft Corporation in the United States and/or other countries.
 - Microsoft product screen shot(s) reprinted with permission from Microsoft Corporation.
 - IBM and PC/AT are registered trademarks of International Business Machines Corporation of the U.S.
 - Intel®, Pentium®, Celeron® and Intel®Core™ are trademarks of Intel Corporation in the U.S. and/or other countries.
 - Mac and Mac OS are trademarks of Apple Inc. registered in the U.S. and other countries.
 - Other names of systems and products mentioned in these instructions are usually the registered trademarks or trademarks of the manufacturers who developed the system or product concerned.
- This product is licensed under the AVC patent portfolio license for the personal and non-commercial use of a consumer to (i) encode video in compliance with the AVC Standard (“AVC Video”) and/or (ii) decode AVC Video that was encoded by a consumer engaged in a personal and non-commercial activity and/or was obtained from a video provider licensed to provide AVC Video. No license is granted or shall be implied for any other use. Additional information may be obtained from MPEG LA, LLC. See <http://www.mpegla.com>.
- Separate license contracts must be obtained from MPEG LA where SD Memory Cards containing information recorded with this product are to be distributed to end users for commercial purposes. “End user” refers to persons or organizations handling such contents for personal use.

Recording modes/approximate recordable time

- SD cards are only mentioned with their main memory size. The stated times are the approximate recordable times for continuous recording.

Recording format	[PS 1080/60p]	
Recording method	AVCHD Progressive	
Picture size	1920×1080/60p	
SD card	4 GB	18 min
	16 GB	1 h 20 min
	64 GB	5 h 20 min

Recording format	[PH 1080/60i]	[PH 1080/30p]	[PH 1080/24p]
Recording method	AVCHD		
Picture size	1920×1080/60i	1920×1080/30p	1920×1080/24p
SD card	4 GB	21 min	
	16 GB	1 h 30 min	
	64 GB	6 h	

Recording format	[HA 1080/60i]	[HE 1080/60i]	[SA 480/60i]	
Recording method	AVCHD			
Picture size	1920×1080/60i	1440×1080/60i	720×480/60i	
SD card	4 GB	30 min	1 h 30 min	1 h
	16 GB	2 h	6 h	4 h
	64 GB	8 h	24 h	16 h 30 min

- If recording for long periods, prepare batteries for 3 or 4 times the period you wish to record for. (→ 14)
- The default setting is [PH 1080/60i].
- Maximum continuously recordable time for one scene: 6 hours
- The recording is paused once when the recording time for one scene exceeds 6 hours, and the recording will automatically resume after a few seconds.
- The recordable time may be reduced if recording with a lot of action is recorded or recording of short scene is repeated.

Approximate number of recordable pictures

- SD cards are only mentioned with their main memory size. The stated number is the approximate number of recordable pictures.

Picture size	3m 2304×1296	2.2m 1728×1296	
Aspect ratio	16:9	4:3	
SD card	4 GB	2300	3100
	16 GB	9500	12500
	64 GB	39000	52000

- Maximum number of recordable pictures that can be displayed is 9999. If the number of recordable pictures exceeds 9999, R 9999+ is displayed. The number will not change when the picture is taken until the number of recordable pictures is 9999 or less.
- The memory capacity indicated on the label of an SD card is the total of the capacity for copyright protection and management and the capacity which can be used on the unit, a PC etc.

Panasonic Corporation
Web Site: <http://panasonic.net>

© Panasonic Corporation 2012