

SHARP®

PN-L702B

LCD MONITOR

OPERATION MANUAL

HDMI™
HIGH-DEFINITION MULTIMEDIA INTERFACE

IMPORTANT:

To aid reporting in case of loss or theft, please record the product's model and serial numbers in the space provided. The numbers are located in the rear of the product.

Model No.:

Serial No.:

U.S.A. ONLY

FOR CUSTOMERS IN U.K.

IMPORTANT

The wires in this mains lead are coloured in accordance with the following code:

GREEN-AND-YELLOW:	Earth
BLUE:	Neutral
BROWN:	Live

As the colours of the wires in the mains lead of this apparatus may not correspond with the coloured markings identifying the terminals in your plug proceed as follows:



- The wire which is coloured GREEN-AND-YELLOW must be connected to the terminal in the plug which is marked by the letter **E** or by the safety earth \perp or coloured green or green-and-yellow.
- The wire which is coloured BLUE must be connected to the terminal which is marked with the letter **N** or coloured black.
- The wire which is coloured BROWN must be connected to the terminal which is marked with the letter **L** or coloured red.

Ensure that your equipment is connected correctly. If you are in any doubt consult a qualified electrician.

“WARNING: THIS APPARATUS MUST BE EARTHED.”

IMPORTANT INFORMATION

WARNING: TO REDUCE THE RISK OF FIRE OR ELECTRIC SHOCK, DO NOT EXPOSE THIS PRODUCT TO RAIN OR MOISTURE.

	CAUTION RISK OF ELECTRIC SHOCK DO NOT OPEN	
CAUTION: TO REDUCE THE RISK OF ELECTRIC SHOCK, DO NOT REMOVE COVER. NO USER-SERVICEABLE PARTS INSIDE. REFER SERVICING TO QUALIFIED SERVICE PERSONNEL.		



The lightning flash with arrowhead symbol, within an equilateral triangle, is intended to alert the user to the presence of uninsulated “dangerous voltage” within the product’s enclosure that may be of sufficient magnitude to constitute a risk of electric shock to persons.



The exclamation point within a triangle is intended to alert the user to the presence of important operating and maintenance (servicing) instructions in the literature accompanying the product.

WARNING:

FCC Regulations state that any unauthorized changes or modifications to this equipment not expressly approved by the manufacturer could void the user’s authority to operate this equipment.

NOTE:

This equipment has been tested and found to comply with the limits for Class A digital device, pursuant to Part 15 of the FCC Rules. These limits are designed to provide reasonable protection against harmful interference when the equipment is operated in a commercial environment. This equipment generates, uses, and can radiate radio frequency energy and, if not installed and used in accordance with the instruction manual, may cause harmful interference to radio communications. Operation of this equipment in a residential area is likely to cause harmful interference in which case the user will be required to correct the interference at his own expense.

This product utilizes a CR coin Lithium battery which contains a Perchlorate material. Special handling for this material may apply, California residents, See www.dtsc.ca.gov/hazardouswaste/perchlorate/ Others, consult local environmental officers.

U.S.A. ONLY

IMPORTANT INFORMATION (Continued)



Attention: Your product is marked with this symbol. It means that used electrical and electronic products should not be mixed with general household waste. There is a separate collection system for these products.

EU ONLY

A. Information on Disposal for Users (private households)

1. In the European Union

Attention: If you want to dispose of this equipment, please do not use the ordinary dustbin!

Used electrical and electronic equipment must be treated separately and in accordance with legislation that requires proper treatment, recovery and recycling of used electrical and electronic equipment.

Following the implementation by member states, private households within the EU states may return their used electrical and electronic equipment to designated collection facilities free of charge*. In some countries* your local retailer may also take back your old product free of charge if you purchase a similar new one.

*) Please contact your local authority for further details.

If your used electrical or electronic equipment has batteries or accumulators, please dispose of these separately beforehand according to local requirements.

By disposing of this product correctly you will help ensure that the waste undergoes the necessary treatment, recovery and recycling and thus prevent potential negative effects on the environment and human health which could otherwise arise due to inappropriate waste handling.

2. In other Countries outside the EU

If you wish to discard this product, please contact your local authorities and ask for the correct method of disposal.

For Switzerland: Used electrical or electronic equipment can be returned free of charge to the dealer, even if you don't purchase a new product. Further collection facilities are listed on the homepage of www.swico.ch or www.sens.ch.

B. Information on Disposal for Business Users

1. In the European Union

If the product is used for business purposes and you want to discard it:

Please contact your SHARP dealer who will inform you about the take-back of the product. You might be charged for the costs arising from take-back and recycling. Small products (and small amounts) might be taken back by your local collection facilities.

For Spain: Please contact the established collection system or your local authority for take-back of your used products.

2. In other Countries outside the EU

If you wish to discard of this product, please contact your local authorities and ask for the correct method of disposal.



The battery supplied with this product contains traces of Lead.

For EU:

The crossed-out wheeled bin implies that used batteries should not be put to the general household waste! There is a separate collection system for used batteries, to allow proper treatment and recycling in accordance with legislation. Please contact your local authority for details on the collection and recycling schemes.

For Switzerland:

The used battery is to be returned to the selling point.

For other non-EU countries:

Please contact your local authority for correct method of disposal of the used battery.

Pb
EU ONLY

"BATTERY DISPOSAL"

THIS PRODUCT CONTAINS A LITHIUM PRIMARY (MANGANESE DIOXIDE) MEMORY BACK-UP BATTERY THAT MUST BE DISPOSED OF PROPERLY. PLEASE CONTACT YOUR LOCAL SHARP DEALER OR AUTHORIZED SERVICE REPRESENTATIVE FOR ASSISTANCE IN DISPOSING OF THIS BATTERY.

U.S.A. AND CANADA ONLY

DEAR SHARP CUSTOMER

Thank you for your purchase of a SHARP LCD product. To ensure safety and many years of trouble-free operation of your product, please read the Safety Precautions carefully before using this product.

SAFETY PRECAUTIONS

Electricity is used to perform many useful functions, but it can also cause personal injuries and property damage if improperly handled. This product has been engineered and manufactured with the highest priority on safety. However, improper use can result in electric shock and/or fire. In order to prevent potential danger, please observe the following instructions when installing, operating and cleaning the product. To ensure your safety and prolong the service life of your LCD product, please read the following precautions carefully before using the product.

1. Read instructions — All operating instructions must be read and understood before the product is operated.
2. Keep this manual in a safe place — These safety and operating instructions must be kept in a safe place for future reference.
3. Observe warnings — All warnings on the product and in the instructions must be observed closely.
4. Follow instructions — All operating instructions must be followed.
5. Cleaning — Unplug the power cord from the AC outlet before cleaning the product. Use a dry cloth to clean the product. Do not use liquid cleaners or aerosol cleaners.
6. Attachments — Do not use attachments not recommended by the manufacturer. Use of inadequate attachments can result in accidents.
7. Water and moisture — Do not use the product near water. Do not install the product in a place where water may splash onto it. Be careful of equipment which drains water such as an air-conditioner.
8. Ventilation — The vents and other openings in the cabinet are designed for ventilation. Do not cover or block these vents and openings since insufficient ventilation can cause overheating and/or shorten the life of the product. Do not place the product on a sofa, rug or other similar surface, since they can block ventilation openings. Do not place the product in an enclosed place such as a bookcase or rack, unless proper ventilation is provided or the manufacturer's instructions are followed.
9. Power cord protection — The power cords must be routed properly to prevent people from stepping on them or objects from resting on them.
10. The screen used in this product is made of glass. Therefore, it can break when the product is dropped or applied with impact. Be careful not to be injured by broken glass pieces in case the screen breaks.
11. Overloading — Do not overload AC outlets or extension cords. Overloading can cause fire or electric shock.
12. Entering of objects and liquids — Never insert an object into the product through vents or openings. High voltage flows in the product, and inserting an object can cause electric shock and/or short internal parts. For the same reason, do not spill water or liquid on the product.
13. Servicing — Do not attempt to service the product yourself. Removing covers can expose you to high voltage and other dangerous conditions. Request a qualified service person to perform servicing.
14. Repair — If any of the following conditions occurs, unplug the power cord from the AC outlet, and request a qualified service person to perform repairs.
 - a. When the power cord or plug is damaged.
 - b. When a liquid was spilled on the product or when objects have fallen into the product.
 - c. When the product has been exposed to rain or water.
 - d. When the product does not operate properly as described in the operating instructions.

Do not touch the controls other than those described in the operating instructions. Improper adjustment of controls not described in the instructions can cause damage, which often requires extensive adjustment work by a qualified technician.
 - e. When the product has been dropped or damaged.
 - f. When the product displays an abnormal condition. Any noticeable abnormality in the product indicates that the product needs servicing.
15. Replacement parts — In case the product needs replacement parts, make sure that the service person uses replacement parts specified by the manufacturer, or those with the same characteristics and performance as the original parts. Use of unauthorized parts can result in fire, electric shock and/or other danger.
16. Safety checks — Upon completion of service or repair work, request the service technician to perform safety checks to ensure that the product is in proper operating condition.
17. Wall mounting — When mounting the product on a wall, be sure to install the product according to the method recommended by the manufacturer.
18. Heat sources — Keep the product away from heat sources such as radiators, heaters, stoves and other heat-generating products (including amplifiers).

SAFETY PRECAUTIONS (Continued)

19. Batteries — Incorrect use of batteries may cause the batteries to burst or ignite. A leaky battery may corrode the equipment, dirty your hands or spoil your clothing. In order to avoid these problems, make sure to observe the precautions below:
 - Use the specified batteries only.
 - Install the batteries with due attention to the plus (+) and minus (-) sides of the batteries according to the instructions in the compartment.
 - Do not mix old and new batteries.
 - Do not mix batteries of different types. Voltage specifications of batteries of the same shape may vary.
 - Replace an exhausted battery with a new one promptly.
 - If you will not use the remote control for a long time, remove the batteries.
 - If leaked battery fluid gets on your skin or clothing, rinse immediately and thoroughly. If it gets into your eye, bathe your eye well rather than rubbing and seek medical treatment immediately. Leaked battery fluid that gets into your eye or your clothing may cause a skin irritation or damage your eye.
20. Usage of the monitor must not be accompanied by fatal risks or dangers that, could lead directly to death, personal injury, severe physical damage or other loss, including nuclear reaction control in nuclear facility, medical life support system, and missile launch control in a weapon system.
21. Do not stay in contact with the parts of the product that become hot for long periods of time. Doing so may result in low-temperature burns.

WARNING:

This is a class A product. In a domestic environment this product may cause radio interference in which case the user may be required to take adequate counter measures.

To maintain compliance with EMC regulations, use shielded cables to connect to the following terminals: PC/AV DVI-D output terminal, PC/AV DVI-D input terminal, PC/AV HDMI input terminal, PC D-SUB input terminal, PC RGB input terminals, and RS-232C input/output terminals.

If a monitor is not positioned in a sufficiently stable location, it can be potentially hazardous due to falling. Many injuries, particularly to children, can be avoided by taking simple precautions such as:

- Using fixing devices like wall mount brackets recommended by the manufacturer.
- Only using furniture that can safely support the monitor.
- Ensuring the monitor is not overhanging the edge of the supporting furniture.
- Not placing the monitor on tall furniture (for example, cupboards or bookcases) without anchoring both the furniture and the monitor to a suitable support.
- Not standing the monitors on cloth or other materials placed between the monitor and supporting furniture.
- Educating children about the dangers of climbing on furniture to reach the monitor or its controls.

Especially for child safety

- Don't allow children to climb on or play with the monitor.
- Don't place the monitor on furniture that can easily be used as steps, such as a chest of drawers.
- Remember that children can become excited while watching a program, especially on a "larger than life" monitor. Care should be taken to place or install the monitor where it cannot be pushed, pulled over, or knocked down.
- Care should be taken to route all cords and cables connected to the monitor so that they cannot be pulled or grabbed by curious children.

TIPS AND SAFETY INSTRUCTIONS

- The TFT color LCD panel used in this monitor is made with the application of high precision technology. However, there may be minute points on the screen where pixels never light or are permanently lit. Also, if the screen is viewed from an acute angle there may be uneven colors or brightness. Please note that these are not malfunctions but common phenomena of LCDs and will not affect the performance of the monitor.
- Do not display a still picture for a long period, as this could cause a residual image.
- Never rub or tap the monitor with hard objects.
- Please understand that SHARP CORPORATION bears no responsibility for errors made during use by the customer or a third party, nor for any other malfunctions or damage to this product arising during use, except where indemnity liability is recognized under law.
- This monitor and its accessories may be upgraded without advance notice.
- Do not use the monitor where there is a lot of dust, where humidity is high, or where the monitor may come into contact with oil or steam, as this could lead to fire.
- Ensure that the monitor does not come into contact with water or other fluids. Ensure that no objects such as paper clips or pins enter the monitor as this could lead to fire or electric shock.
- Do not place the monitor on top of unstable objects or in unsafe places. Do not allow the monitor to receive strong shocks or to strongly vibrate. Causing the monitor to fall or topple over may damage it.
- Do not use the monitor near heating equipment or in places where there is likelihood of high temperature, as this may lead to generation of excessive heat and outbreak of fire.
- Do not use the monitor in places where it may be exposed to direct sunlight.
- The AC outlet shall be installed near the equipment and shall be easily accessible.
- Do not touch the screen while the PC is starting up, since it will be detected as a failure of the infrared transmitter/receiver elements and will lead to a malfunction. When this occurs, restart the PC.
- Do not operate the screen with a hard or pointed object such as a fingernail, pen, or pencil.
- Two touch panels cannot be used when two displays are connected to the computer.
Only the touch panel on the display that is set as the primary monitor will be operable.
- If another USB device is connected to the computer to which the touch panel is connected, do not operate the USB device during touch panel input. Input may not take place correctly.
- If two touch panels are used in close proximity to each other, use handwriting mode. The touch pens will interfere with each other and will not operate correctly.
- If the infrared transmitter/receiver becomes dirty, malfunctioning may result. Use a soft cloth to gently wipe dirt off the infrared transmitter/receiver.
- If dust accumulates inside the infrared transmitter/receiver, the product cannot transmit or receive infrared rays properly, resulting in a malfunction. To clean the dust accumulated inside, contact an authorized SHARP servicing dealer or service center (extra charge required).

The Power Cord

- Use only the power cord supplied with the monitor.
- Do not damage the power cord nor place heavy objects on it, stretch it or over bend it. Also, do not add extension cords. Damage to the cord may result in fire or electric shock.
- Do not use the power cord with a power tap. Adding an extension cord may lead to fire as a result of overheating.
- Do not remove or insert the power plug with wet hands. Doing so could result in electric shock.
- Unplug the power cord if it is not used for a long time.
- Do not attempt to repair the power cord if it is broken or malfunctioning. Refer the servicing to the service representative.

Manual Scope

- Microsoft, Windows, Windows Vista and Internet Explorer are registered trademarks of Microsoft Corporation.
- HDMI, the HDMI Logo and High-Definition Multimedia Interface are trademarks or registered trademarks of HDMI Licensing LLC.
- Adobe, Acrobat, and Reader are either registered trademarks or trademarks of Adobe Systems Incorporated in the United States and/or other countries.
- Intel, Celeron, and Intel Core 2 Duo are trademarks or registered trademarks of Intel Corporation or its subsidiaries in the U.S.A. and other countries.
- AMD, AMD Sempron, AMD Athlon, and combinations thereof are trademarks of Advanced Micro Devices, Inc.
- This product comes with RICOH Bitmap Fonts produced and sold by RICOH COMPANY, LTD.
- All other brand and product names are trademarks or registered trademarks of their respective holders.
- Language of OSD menu used in this manual is English by way of example.
- Illustrations in this manual may not exactly represent the actual product or display.

LED Backlight

- The LED backlight in this product has a limited lifetime.
 - * If the screen gets dark or does not turn on, it may be necessary to replace the LED backlight. This LED backlight is exclusive to this product and must be replaced by an authorized Sharp servicing dealer or service center.
 - * Please contact your local Sharp servicing dealer or service center for assistance.

MOUNTING PRECAUTIONS

- This product is for use indoors.
- A mounting bracket compliant with VESA specifications is required.
- Since the monitor is heavy, consult your dealer before installing, removing or moving the monitor.
- Mounting the monitor on the wall requires special expertise and the work must be performed by an authorized SHARP dealer. You should never attempt to perform any of this work yourself. Our company will bear no responsibility for accidents or injuries caused by improper mounting or mishandling.
- This monitor cannot be used in vertical orientation.
- Use the monitor with the surface perpendicular to a level surface. If necessary, the monitor may be tilted up to 20 degrees upward.
- When moving the monitor, be sure to hold it with either both handles or the 4 corners on the bottom of the unit. Do not place your hand on the screen. This may cause product damage, failure, or injury.
- This monitor should be used at an ambient temperature between 41°F (5°C) and 95°F (35°C). Provide enough space around the monitor to prevent heat from accumulating inside.

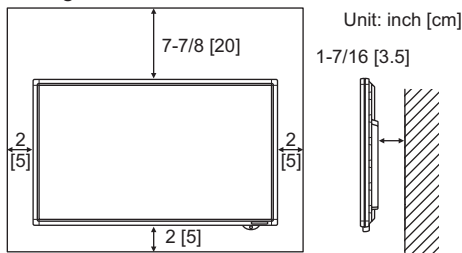

- If it is difficult to provide sufficient space for any reason such as the installation of the monitor inside a housing, or if the ambient temperature may be outside of the range of 41°F (5°C) to 95°F (35°C), install a fan or take other measures to keep the ambient temperature within the required range.
- Temperature condition may change when using the monitor together with the optional equipments recommended by SHARP. In such cases, please check the temperature condition specified by the optional equipments.
- Do not block any ventilation openings. If the temperature inside the monitor rises, this could lead to a malfunction.
- Do not place the monitor on a device which generates heat.
- Do not use the product in locations where the unit is exposed to direct sunlight or other strong light. Since this product operates with infrared rays, such light may cause a malfunction.

Contents

IMPORTANT INFORMATION	3	Touch action	18
DEAR SHARP CUSTOMER	5	Other functions	20
SAFETY PRECAUTIONS	5	Cautionary points	20
TIPS AND SAFETY INSTRUCTIONS	7	Eraser	20
MOUNTING PRECAUTIONS	8	Basic Operation	21
Supplied Components	9	Menu Items	23
System Requirements	9	Displaying the menu screen	23
Part Names	10	Menu item details	24
Connecting Peripheral Equipment	12	Adjustments for PC screen display	30
Connection with a PC or AV equipment	12	Initialization (Reset)/Functional Restriction Setting	
Connection when the PN-ZB01 (optional)		(FUNCTION)	31
is attached	13	Controlling the Monitor with a PC (RS-232C)	32
Connecting the Power Cord	14	PC connection	32
Binding Cables	14	Communication conditions	32
Removing the Handles	14	Communication procedure	32
Preparing the Remote Control Unit	15	Setting of the GAMMA user data.....	35
Installing the batteries	15	RS-232C command table.....	36
Remote control operation range.....	15	Controlling the Monitor with a PC (LAN)	43
Turning Power On/Off	16	Settings to connect to a LAN.....	43
Turning on the main power.....	16	Controlling with a PC.....	45
Turning power on/off	16	Troubleshooting	51
Disabling power on/off operations.....	17	Specifications	53
Touch Pen Preparations/Touch Action	18	Mounting Precautions	
Inserting the battery	18	(For SHARP dealers and service engineers)	57
Touch action and touch mode	18		

For information on the touch panel driver, see the Touch Panel Driver Operation Manual. For information on the Pen Software, see the Pen Software Operation Manual.

Supplied Components

If any component should be missing, please contact your dealer.

- | | | |
|---|---|--|
| <input type="checkbox"/> Liquid Crystal Display Monitor: 1 | <input type="checkbox"/> Pen tip (for touch pen): 2 | <input type="checkbox"/> Tray mounting screws: M5 x 4 / M4 x 2 |
| <input type="checkbox"/> Remote control unit: 1 | <input type="checkbox"/> Touch pen battery | <input type="checkbox"/> Terminal label: 1 |
| <input type="checkbox"/> Cable clamp: 2 | (LR-03 ("AAA" size)): 1 | Used when installing the interface |
| <input type="checkbox"/> Power cord: 1 | <input type="checkbox"/> USB cable: 1 | expansion board PN-ZB01 (optional). |
| <input type="checkbox"/> R-6 battery ("AA" size): 2 | <input type="checkbox"/> Eraser: 1 | <input type="checkbox"/> Cover Sharp logo: 1 |
| <input type="checkbox"/> CD-ROM (Utility Disk for Windows): 1 | <input type="checkbox"/> Tray: 1 | Place this sticker onto the SHARP logo to |
| <input type="checkbox"/> Setup Manual: 1 | <input type="checkbox"/> Tray mounting fitting | cover the logo. |
| <input type="checkbox"/> Touch pen: 1 | (cover / bracket): x 2 | |

* Sharp Corporation holds authorship rights to the Utility Disk program. Do not reproduce it without permission.

* For environmental protection!

Do not dispose of batteries in household waste. Follow the disposal instructions for your area.

System Requirements

To use the touch panel, the touch panel must be connected to a computer, and the touch panel driver and Pen Software must be installed on the computer from the supplied CD-ROM. System requirements for each software program are as follows.

Computer	PC/AT compatible computer with a USB 1.1 port (must be able to supply a 500 mA (5.0 V) current) and able to output a resolution of 1920 x 1080. (CD-ROM drive required for software installation.)
OS	Windows XP (32-bit or 64-bit version), Windows Vista (32-bit or 64-bit version), Windows 7 (32-bit or 64-bit version)
CPU	Intel Celeron or AMD Sempron 1.6 GHz or faster Intel Core 2 Duo or AMD Athlon II X2 2.8 GHz or faster recommended
Memory	At least 2 GB (at least 1 GB for Windows XP)
Free space on hard drive	At least 100 MB (free space separately required for data storage)

To connect the touch panel and install the touch panel driver, see the Touch Panel Driver Operation Manual.

To install the Pen Software, see the Pen Software Operation Manual.

Part Names

■Front view

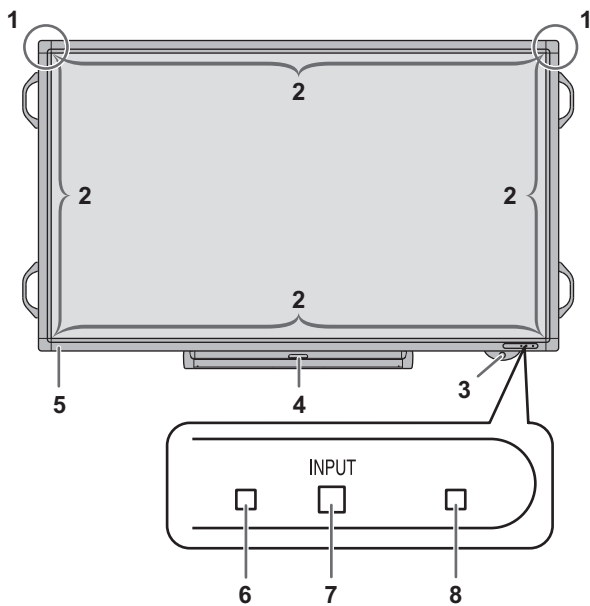

1. Touch pen ultrasonic sensor
2. Infrared transmitter/receiver
3. Power button (See page 16.)
4. Tray
5. Touch panel power LED
6. Remote control sensor (See page 15.)
7. Input switch (See page 21.)
8. Power LED (See page 16.)

■Rear view

When the PN-ZB01 (optional) is attached

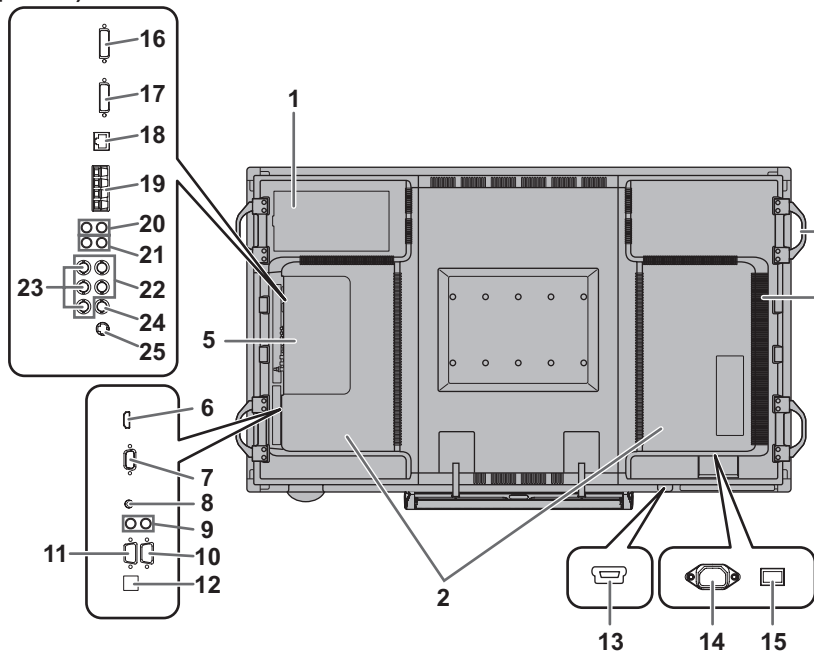

1. **Optional attachment section**
This section is used to connect optional hardware for function expansion. Offering this attachment location is not a guarantee that future compatible hardware attachments will be released.
2. **Speakers**
3. **Handles** (See page 14.)
4. **Vents**
5. **Expansion terminal cover**
Additional input/output terminals are available by attaching the PN-ZB01 interface expansion board (optional).
6. **PC/AV HDMI input terminal** (See page 12.)
7. **PC D-sub input terminal** (See page 12.)
8. **Audio input terminal** (See page 12.)
9. **Audio output terminals** (See page 12.)
10. **RS-232C output terminal** (See page 12.)
11. **RS-232C input terminal** (See page 12.)
12. **Optional terminal**
This terminal is provided for possible future (optional) function expansion. Offering of this terminal is not a guarantee that future expanded functionality will be provided.
13. **USB port**
14. **AC input terminal** (See page 14.)
15. **Main power switch** (See page 16.)

! Caution

- Consult your SHARP dealer for attachment/detachment of optional parts.
- Do not open the expansion terminal cover by yourself. There are high voltage parts inside the cover which may cause an electric shock.

When the PN-ZB01 (optional) is attached

16. **PC/AV DVI-D input terminal** (See page 13.)
17. **PC/AV DVI-D output terminal** (See page 13.)
18. **LAN terminal** (See page 13.)
19. **External speaker terminals** (See page 13.)
20. **Audio 1 input terminals** (See page 13.)
21. **Audio 2 input terminals** (See page 13.)
22. **PC RGB input terminals** (See page 13.)
23. **AV component input terminals** (See page 13.)
24. **AV video input terminal** (See page 13.)
25. **AV S-video input terminal** (See page 13.)

■ Remote control unit

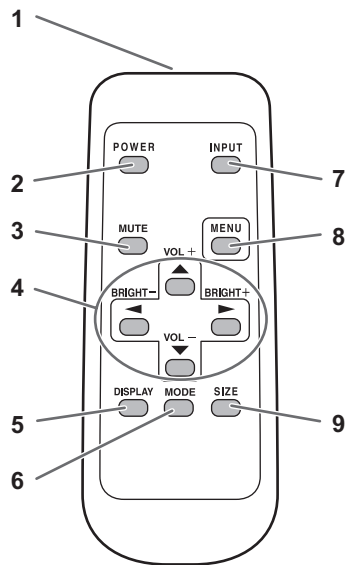

1. Signal transmitter
2. POWER button (See page 16.)
3. MUTE button (See page 21.)
4. VOL +/- buttons (See page 21.)
BRIGHT +/- buttons (See page 21.)
Cursor control (▲ / ▼ / ◀ / ▶) buttons
5. DISPLAY button (See page 21.)
6. MODE button (See page 21.)
7. INPUT button (See page 21.)
8. MENU button (See page 21.)
9. SIZE button (See page 21.)

Connecting Peripheral Equipment

When the PN-ZB01 (optional) is attached

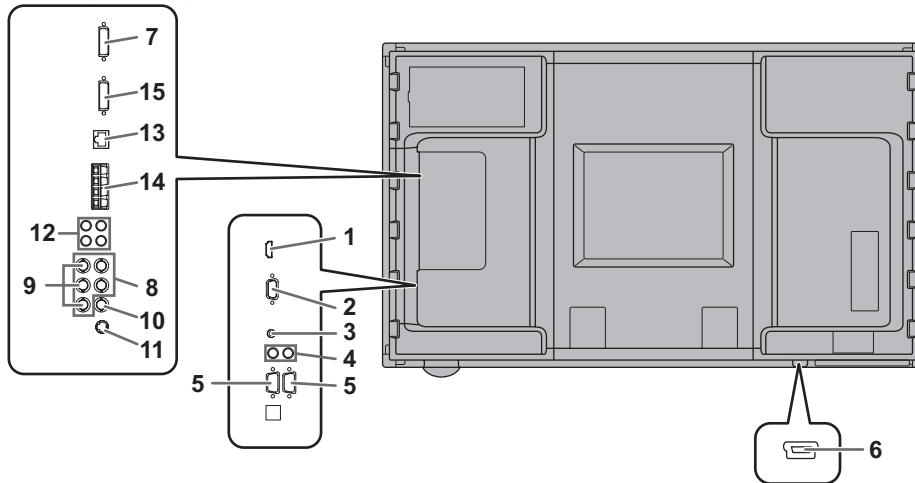

! Caution

- Be sure to turn off the main power switch and disconnect the plug from the power outlet before connecting/disconnecting cables. Also, read the manual of the equipment to be connected.
- Be careful not to confuse the input terminal with the output terminal when connecting cables. Accidentally reversing cables connected to the input and output terminals may cause malfunctions and the other problems.

TIPS

- When using the touch panel, connect the USB cable to the computer. For details, see the Touch Panel Driver Operation Manual.
- Images may not be displayed properly depending on the computer (video card) to be connected.
- A screen with 1920 x 1080 resolution may not be displayed correctly on PC RGB. In this case, check the settings of your computer (video card) to verify that input signals conform to specifications of this monitor. (See page 55.)
- If there is a check box to disable EDID in display control panel, check it when using PC RGB.
- Use the automatic screen adjustment when a PC screen is displayed for the first time using PC D-SUB or PC RGB, or when the setting of the PC is changed. The screen is adjusted automatically when SELF ADJUST in the OPTION menu is set to ON.
- If the audio output from the playback device is connected directly to speakers or other devices, the video on the monitor may appear delayed from the audio portion. Audio should be played through this monitor by connecting the playback device to the monitor's audio input, and connecting the monitor's audio output to the speakers or other devices.
- The audio input terminals used in each input mode are factory-set as follows.

Input mode	Audio input terminal (Factory setting)
PC D-SUB, PC DVI-D, PC RGB	Audio input terminal
AV DVI-D	Audio1 input terminal
AV COMPONENT (BNC), AV S-VIDEO, AV VIDEO (BNC)	Audio2 input terminal
AV COMPONENT (D-SUB), AV VIDEO (D-SUB)	Audio input terminal
PC HDMI, AV HDMI	PC/AV HDMI input terminal

Connection with a PC or AV equipment

1. PC/AV HDMI input terminal

- Use a commercially available HDMI cable (conforming to the HDMI standard).
- Set HDMI of INPUT SELECT on the OPTION menu according to the device to be connected.
- Select the audio input terminal to be used in PC HDMI or AV HDMI of AUDIO SELECT on the OPTION menu. When HDMI is selected, connection to the audio input terminal is unnecessary.

2. PC D-sub input terminal

- Set D-SUB of INPUT SELECT on the OPTION menu according to the device to be connected.
- Common terminal for AV COMPONENT and AV VIDEO.
- When the PN-ZB01 (optional) is attached, select the audio input terminal to be used in PC D-SUB of AUDIO SELECT on the OPTION menu.
- To use with AV VIDEO (D-SUB), connect the green terminal to the device's video output.

3. Audio input terminal

- Use an audio cable without resistance.
- When the PN-ZB01 (optional) is attached, set the audio input terminal used for each input mode in AUDIO SELECT on the OPTION menu.

4. Audio output terminals

- The output sound varies depending on the input mode.
- The volume of the output sound can be fixed by setting AUDIO OUTPUT (RCA) on the OPTION menu.
- It is not possible to control the sound output from the audio output terminals with the AUDIO menu.

5. RS-232C input terminal

RS-232C output terminal

- You can control the monitor from a PC by connecting a commercially available RS-232 straight cable between these terminals and the PC.

6. USB port

- To use the touch panel, connect the touch panel to your computer with the provided USB cable. (Touch Panel Driver Operation Manual.)

Connection when the PN-ZB01 (optional) is attached

The PN-ZB01 expansion board (optional) allows the use of additional connection terminals.

7. PC/AV DVI-D input terminal

- Set DVI of INPUT SELECT on the OPTION menu according to the device to be connected.
- Select the audio input terminal to be used in PC DVI-D or AV DVI-D of AUDIO SELECT on the OPTION menu.

8. PC RGB input terminals

- Set BNC of INPUT SELECT on the OPTION menu to PC RGB when using the PC RGB input terminals.
- Select the audio input terminal to be used in PC RGB of AUDIO SELECT on the OPTION menu.

9. AV component input terminals

- Set BNC of INPUT SELECT on the OPTION menu to AV COMPONENT when using the AV component input terminals.
- Select the audio input terminal to be used in AV COMPONENT of AUDIO SELECT on the OPTION menu.
- Cannot be used when D-SUB in INPUT SELECT on the OPTION menu is set to AV COMPONENT.

10. AV video input terminal

- Select the audio input terminal to be used in AV VIDEO of AUDIO SELECT on the OPTION menu.
- Cannot be used when D-SUB in INPUT SELECT on the OPTION menu is set to AV VIDEO.

11. AV S-video input terminal

- Select the audio input terminal to be used in AV S-VIDEO of AUDIO SELECT on the OPTION menu.

12. Audio1 input terminals / Audio2 input terminals

- Set the audio input terminal to be used in each input mode in AUDIO SELECT on the OPTION menu.

13. LAN terminal

- You can control the monitor from a PC on a network by connecting a commercially available LAN cable between this terminal and a network.

14. External speaker terminals

- To use external speakers, set SPEAKER SELECT on the SETUP menu to EXTERNAL.
- Be sure to use external speakers with an impedance of 6 Ω or greater and a rated input of at least 7 W.

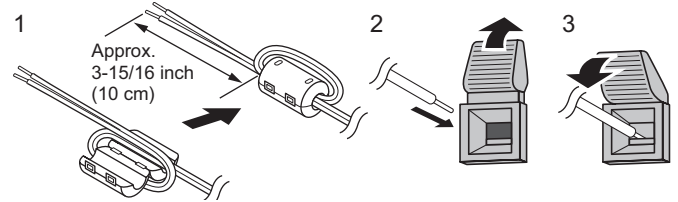

1. Attach a speaker cable core (included with the PN-ZB01) to the end of the speaker cable connected to the monitor.
2. While pushing the tab, insert the tip of the cable.
3. Release the tab.

TIPS

- Be sure to connect the + and - terminals and the left and right speakers properly.
- Avoid short circuiting the + and - terminals.
- When SPEAKER SELECT is set to EXTERNAL, the internal speakers are disabled.

15. PC/AV DVI-D output terminal

- The video of the PC/AV DVI-D input can be output to an external device.
- Outputting HDCP-encrypted video requires an external device which supports HDCP.
- This terminal allows the daisy chain connection of up to 5 monitors.

TIPS

- The length of the signal cables or surrounding environment may affect the image quality.
- The screen may not display properly when using terminals other than PC DVI-D/AV DVI-D for the input mode. In this case, turn off the power to all the monitors connected in a daisy chain and then turn the power on again.
- When connecting monitors in a daisy chain set AUTO INPUT CHANGE to OFF.
- Video output is disabled in the following cases:
When the power is turned off
When the monitor is in input signal waiting mode

Connecting the Power Cord

! Caution

- Do not use a power cord other than the one supplied with the monitor.
1. Turn off the main power switch.
 2. Plug the power cord (supplied) into the AC input terminal.
 3. Plug the power cord (supplied) into the AC power outlet.

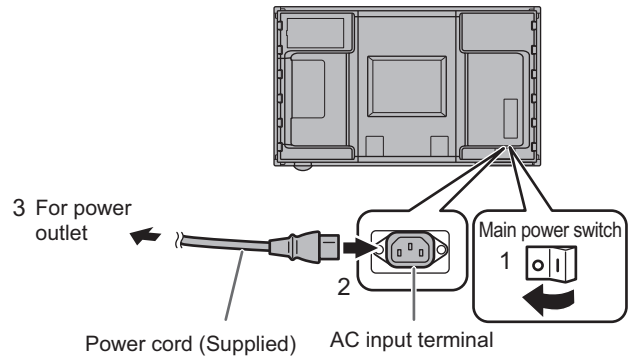

Binding Cables

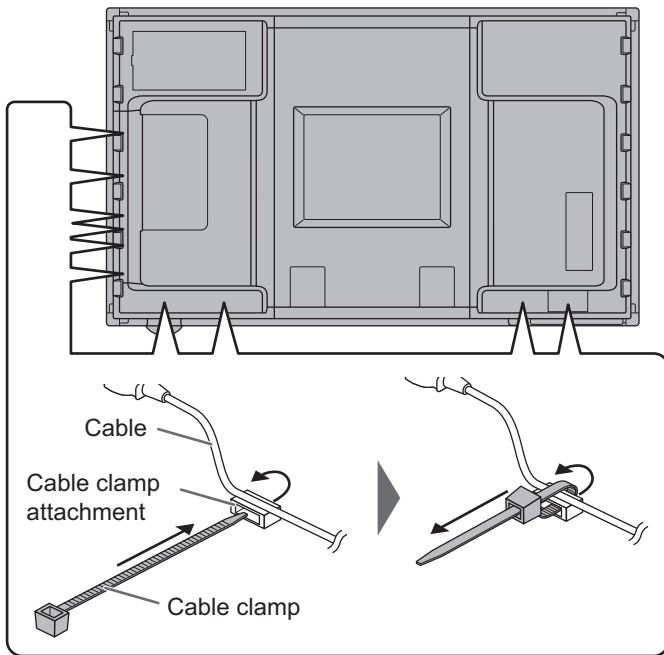

The cables connected to the terminals on the rear of the monitor can be fastened with the cable clamp.

Insert the cable clamp into the cable clamp attachment on the rear of the monitor and fasten the cables.

Removing the Handles

The handles can be removed.

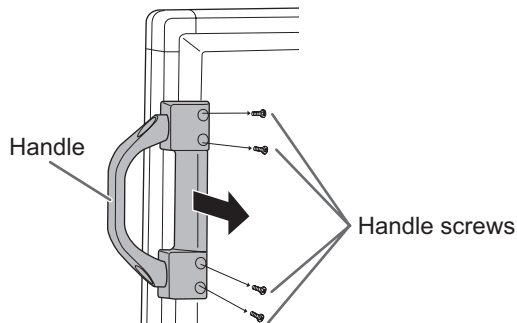

The installation position can be changed.

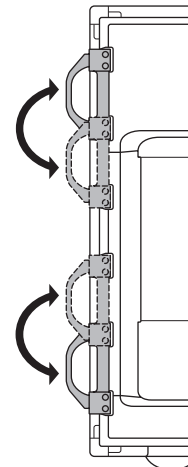

! Caution

- The removable handles and handle screws are for use with this monitor. Do not use them for any other devices.
- To attach handles, be sure to use the handles and handle screws which were removed from the monitor.
- Be sure the handles are attached securely.

Preparing the Remote Control Unit

Installing the batteries

1. Press the cover gently and slide it in the direction of the arrow.

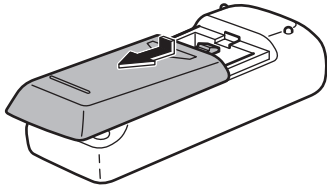

2. See the instructions in the compartment and put in the supplied batteries (R-6 ("AA" size) x 2) with their plus (+) and minus (-) sides oriented correctly.
3. Close the cover.

TIPS

- When the batteries become exhausted, replace them with new (commercially available) batteries.
- The supplied batteries (R-6 ("AA" size) x 2) may become exhausted quickly depending on how they are stored.
- If you will not be using the remote control for a long time, remove the batteries.
- Use manganese or alkaline batteries only.

Remote control operation range

The operation range of the remote control unit is approx. 16.4 feet (5 m) at an angle of approx 10° from the center to the top/bottom/right/left of the remote control sensor.

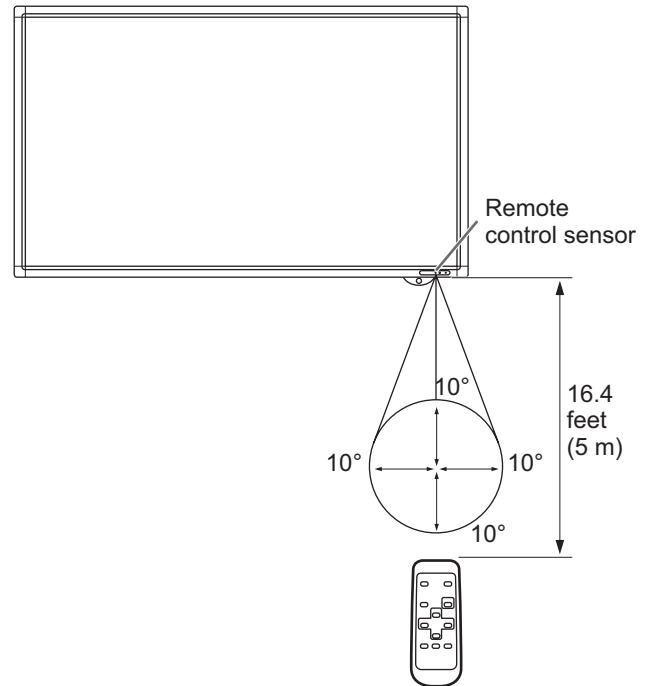

TIPS

- Do not expose the remote control unit to shock by dropping or stepping on it. This could lead to a malfunction.
- Do not expose the remote control unit to liquids, and do not place it in an area with high humidity.
- The remote control unit may not work properly if the remote control sensor is under direct sunlight or strong lighting.
- Objects between the remote control unit and the remote control sensor may prevent proper operation.
- Replace the batteries when they run low as this may shorten the remote control's operation range.
- If a fluorescent light is illuminated near the remote control unit, it may interfere with proper operation.
- Do not use it with the remote control of other equipment such as air conditioner, stereo components, etc.

Turning Power On/Off

! Caution

- Turn on the monitor first before turning on the PC or playback device.

Turning on the main power

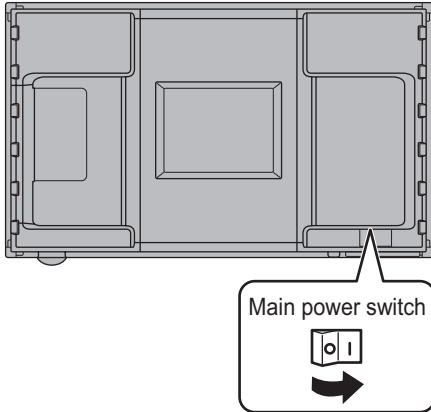

! Caution

- The main power must be turned on/off with the main power switch. Do not connect/disconnect the power cord or turn the breaker on/off while the main power switch is on.
- When switching the main power switch or the POWER button off and back on, always wait for at least 5 seconds.
- For a complete electrical disconnection, pull out the main plug.

Turning power on/off

Press the POWER button to turn the power ON/OFF.

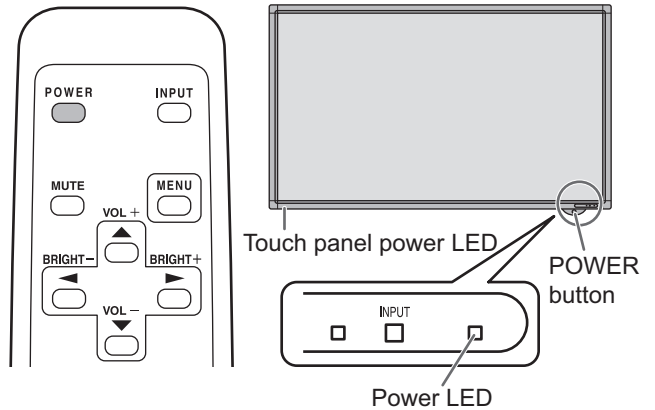

- Status of the power LED

Status	Status of the monitor
Green lit	Power on
Orange lit	Power off (Standby mode)
Green flashing	Input signal waiting mode

- Status of the touch panel power LED

Status	Status of the touch panel
Green lit	Operating normally
Blinking orange Alternately blinking green and orange	Initializing
Off	Touch panel off (power not supplied, etc.)

! Caution

- When switching the main power switch or the POWER button off and back on, always wait for at least 5 seconds. A short interval may result in a malfunction.
- When the touch panel power LED blinks orange or alternately blinks green and orange, the touch panel is being initialized. Do not touch the touch panel at this time. Touching the touch panel may cause malfunctioning.

TIPS

- When the main power switch is off, the monitor cannot be turned on.
- If the monitor is in the input signal standby mode and you press the POWER button on the remote control unit, the monitor enters standby mode.
- Setting the SCHEDULE flashes the power LED alternately in red and orange in standby mode.
- To disable the logo screen from displaying when turning the power ON, set LOGO SCREEN to OFF on the SETUP menu. (See page 26.)

■ Date/time setting

- If the time has yet to be set when the monitor is first turned on, the date/time setting screen appears. Set the date and time.

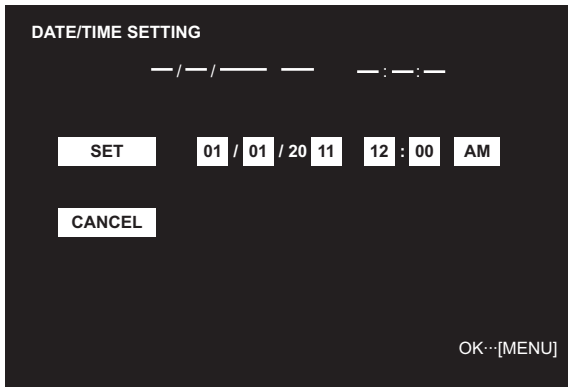

1. Press , , or to select the date and time, and press or to change the numerical values.
 2. Select SET and then press .
- Be sure to set the date and time.
 - The date/time setting screen will close automatically if no operation is performed for about 15 seconds. The date and time can be set using DATE/TIME SETTING from the OPTION menu when the date/time setting screen disappears.

TIPS

- Set the date in "Month/Day/Year" order.
- Set the time on a 12-hour basis.
- The clock is maintained by the internal battery.
- If you already set the time but the date/time setting screen appears when the power is turned on, the internal battery may be exhausted. Please contact your local Sharp servicing dealer or service center for assistance with battery replacement.
- Estimated service life of the internal battery: About 5 years (depending on monitor operation)
- The initial battery was inserted at the factory when the monitor was shipped, so it may run out of power before its expected operation life.

Disabling power on/off operations

Power on/power off operations can be disabled in order to protect the monitor from an accidental power off. Set the ADJUSTMENT LOCK in FUNCTION menu to "ON 2". (See page 31.)

Touch Pen Preparations/Touch Action

Inserting the battery

1. Rotate the battery cap and remove it, and then pull out the cover.

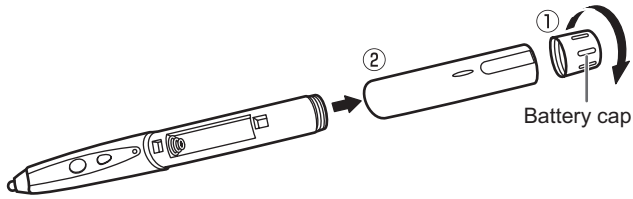

2. Insert the supplied battery (LR-03 ("AAA" size)) in the orientation shown, and attach the cover and battery cap.

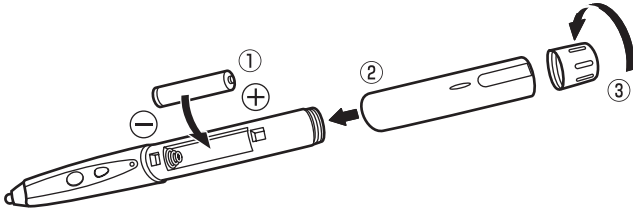

TIPS

- The supplied battery (LR-03 ("AAA" size)) may be exhausted in a short time, depending on how it was stored.
- If the touch pen will not be used for an extended time, remove the battery from the touch pen.
- For the battery, use an alkaline battery.

Touch action and touch mode

Touch panel actions that can be used vary depending on the touch mode setting in the touch panel driver. In Windows XP/Windows Vista, dual touch mode cannot be used.

Touch mode	Single touch mode	Dual touch mode
Single-tap	Yes	Yes
Double-tap	Yes	Yes
Drag-and-drop	Yes	Yes
Flicks	No	Yes
Press-and-hold	No	Yes
Pan	No	Yes
Zoom	No	Yes
Press-and-tap	No	Yes

TIPS

- Settings for touch panel operation such as the touch mode and actions of the function buttons can be changed in the touch panel driver. For details, see the manual for the touch panel driver.
- In Windows 7, if the checkmark has been removed from "Enable multi-touch gestures and inking" in "Pen and touch" in Control Panel, select the checkbox.

Touch action

When the touch panel is touched with the pen, the input mode changes to pen mode. When touched with your finger, the input mode changes to handwriting mode. The input mode is set by default to change automatically (Standard mode).

TIPS

- For the procedures for using the touch pen in the Pen Software, see the Pen Software Operation Manual.

Common finger and pen actions

Single-tap

Same action as left-clicking a mouse.
Touch with your finger/pen.

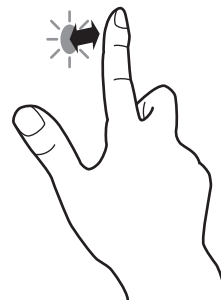

Double-tap*1

Same action as double-clicking a mouse.
Quickly touch twice with your finger/pen.

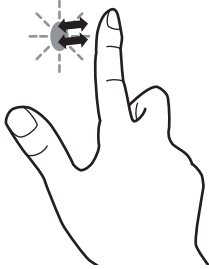

When double-tapping with your finger, be sure to lift your finger sufficiently off the screen after the first tap. If there is insufficient distance between the screen and your finger, double-tap will not take place.

Drag-and-drop

Same action as drag-and-drop with a mouse.
Touch the screen with your finger/pen and move without lifting. When you have finished the movement, lift your finger/pen.

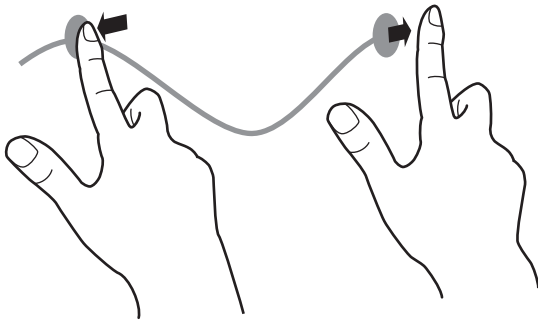

Flicks*2

Flick your finger/pen in the direction of the function you want to use.

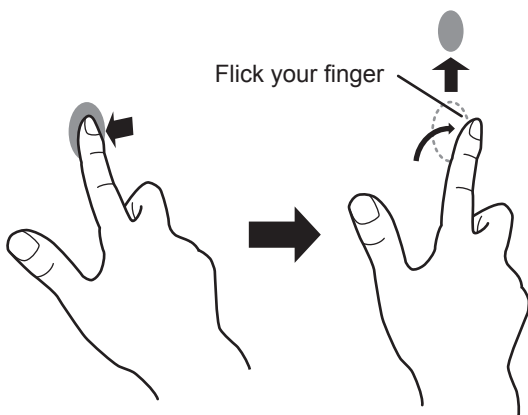

Press-and-hold*2

Same action as right-clicking a mouse.
Press briefly with your finger/pen, and then lift your finger/pen from the screen.

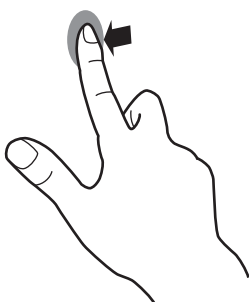

Pan*2

Use in a screen with a scrollbar.
With your finger/pen touching the screen, move in the direction you want to scroll. The screen scrolls in the direction of the movement.

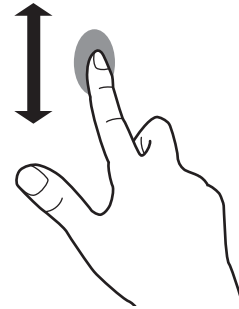

*1 In Windows XP/Windows Vista, the settings can be changed in the touch panel driver.

*2 The settings can be changed in "Pen and touch" of Control Panel in Windows 7. For details, see Windows Help.

■Finger actions

Zoom

Use in a screen that is capable of enlargement/reduction.
Touch the screen with two fingers and move your fingers closer together to reduce the view, or apart to enlarge the view.

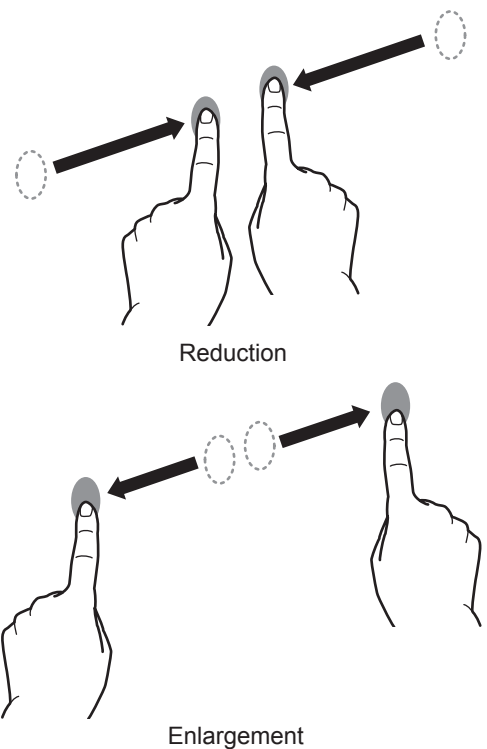

TIPS

- Move your finger diagonally across the screen. If you move your finger horizontally or vertically, the screen may not respond correctly.

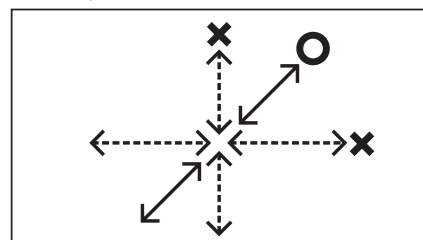

Touch Pen Preparations/Touch Action

Press-and-tap

Same action as right-clicking a mouse.

With one finger touching the screen, tap once (single tap) with another finger.

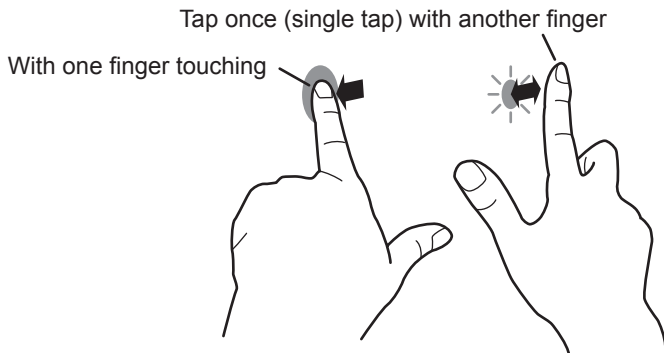

TIPS

- The screen may not respond correctly in the following cases:
 - Touching is too quick
 - The distance between the two points is too short
 - The two points intersect
- Operation with the touch pen is not possible.

■ Pen actions

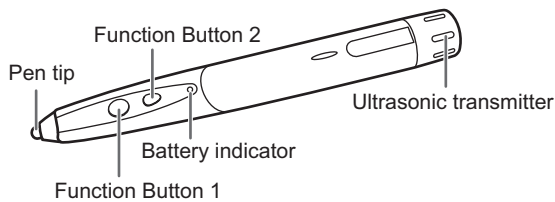

Function Button 1

Pressing Function Button 1 has the same action as right-clicking a mouse.

The battery indicator illuminates.

Function Button 2

In the Pen Software, pressing Function Button 2 has the action that is set in the Pen Software.

The battery indicator illuminates.

TIPS

- Use Function Button 1 and Function Button 2 near the front of the screen. If too far away, operation will not be possible.
- Press Function Button 1 and Function Button 2 slowly and firmly. If pressed too quickly, the action will not be recognized.
- If the pen tip becomes worn or damaged, replace it. Pull out the old pen tip and insert a new pen tip.

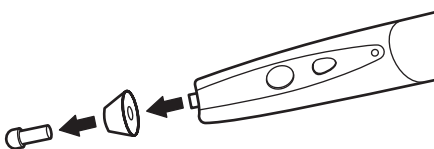

Other functions

In Windows 7, touch pointer and input panel functions can be used.

For information on these functions, see Windows Help.

Touch pointer :

A translucent image of a mouse appears near the point touched. The left/right buttons of the image can be clicked to perform the same actions as left/right clicking a mouse.

Input panel :

A software keyboard and an input panel with handwriting recognition appear on the screen.

In Windows 7 (excluding Starter), the ink function of Microsoft Office can be used.

Handwritten comments can be written, and handwriting can be recognized.

For details, see Microsoft Office Help.

Cautionary points

- Do not use the touch pen for any purpose other than touch panel operation.
- Do not press hard on the pen tip.
- Do not cover the ultrasonic transmitter of the touch pen with your hand or finger.
- Operation will not take place correctly if there is an obstacle between the infrared transmitter/receiver and the touch pen or your finger. Operation will not take place correctly if your fingers or your sleeve is near the screen.
- If the touch pen is held too flat against the screen, the touch position may not be correctly detected.
- If the touch pen does not work at the edge of the screen, move it slowly.
- Do not store with the pen tip of the touch pen or function button pressed. The battery will be exhausted.
- Do not use near a device that emits ultrasonic waves. The touch pen uses ultrasonic waves and may not operate correctly.
- If two touch panels are used in close proximity to each other, use handwriting mode. The touch pens will interfere with each other and will not operate correctly.
- If there is dirt or foreign matter on the tip of the touch pen, remove it. Foreign matter may damage the screen.
- Applications such as a screensaver or media player may cause the resolution to automatically change. If "Resolution Change Notice" is enabled in the touch panel driver, a resolution change message will appear. In this case, disable "Resolution Change Notice", or change the setting in the application so that it does not change the resolution.
- The pen may be out of position in the login screen. In this case, use the keyboard or mouse.
- If the USB cable becomes disconnected, the touch panel may not operate correctly after the cable is reconnected. In this case, restart your computer.

Eraser

The eraser is used with the Pen Software. For the procedure for using the eraser, refer to the Pen Software Operation Manual.

! Caution

- When using the eraser, gently bring the cloth side into contact with the screen. Touching the screen with one of the non-cloth sides will damage the screen.
- If there is any dirt or foreign matter on the surface that contacts the screen, remove it. Foreign matter may damage the screen.

Basic Operation

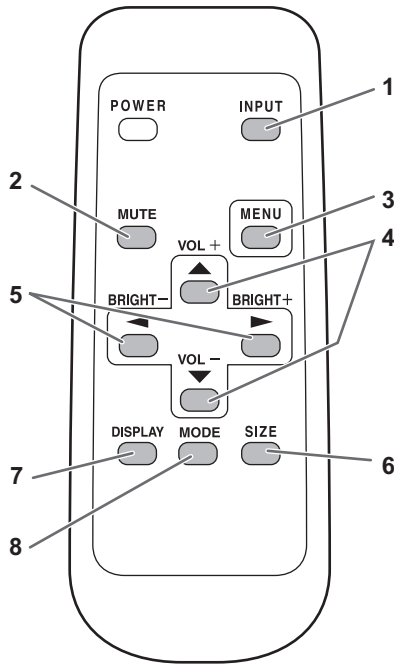

1. INPUT (Input mode selection)

The menu is displayed. Press or to select the input mode, and press to enter.
* You can select the input terminal by pressing the input switch of the monitor.

Input mode	Video	Audio
PC D-SUB	PC D-sub input terminal ^{*1}	Audio input terminal
PC HDMI	PC/AV HDMI input terminal ^{*2}	*3
AV HDMI	PC/AV HDMI input terminal ^{*2}	
AV COMPONENT	PC D-sub input terminal ^{*1}	Audio input terminal
AV VIDEO	PC D-sub input terminal ^{*1}	

When the PN-ZB01 (optional) is attached

Input mode	Video	Audio
PC DVI-D	PC/AV DVI-D input terminal ^{*4}	*3
PC HDMI	PC/AV HDMI input terminal ^{*2}	
PC D-SUB	PC D-sub input terminal ^{*1}	
PC RGB	PC RGB input terminals ^{*5}	
AV DVI-D	PC/AV DVI-D input terminal ^{*4}	
AV HDMI	PC/AV HDMI input terminal ^{*2}	
AV COMPONENT	AV COMPONENT input terminals ^{*5} PC D-sub input terminal ^{*1}	
AV S-VIDEO	AV S-video input terminal	
AV VIDEO	AV video input terminal PC D-sub input terminal ^{*1}	

- *1 Select the terminal to be used in D-SUB of INPUT SELECT. (See page 26.)
- *2 Select the terminal to be used in HDMI of INPUT SELECT. (See page 26.)
- *3 Select the terminal for AUDIO SELECT which is used for audio input. (See page 26.)
- *4 Select the terminal to be used in DVI of INPUT SELECT. (See page 26.)
- *5 Select the terminal to be used in BNC of INPUT SELECT. (See page 26.)

2. MUTE

Turns off the volume temporarily.
Press the MUTE button again to turn the sound back to the previous level.

3. MENU

Displays and turns off the menu screen. (see page 23.)

4. VOL +/- (Volume adjustment)

Pressing or displays the VOLUME menu when the menu screen is not displayed.



Press or to adjust the volume of the sound.
* If you do not press any buttons for about 4 seconds, the VOLUME menu automatically disappears.

5. BRIGHT +/- (Backlight adjustment)

Pressing or displays the BRIGHT menu when the menu screen is not displayed.



Press or to adjust the brightness.
* If you do not press any buttons for about 4 seconds, the BRIGHT menu automatically disappears.

6. SIZE (Screen size selection)

The menu is displayed.
Press or to select the screen size. (See page 22.)

7. DISPLAY

Displays monitor information. When you press this button again, the display disappears.
When the PN-ZB01 (optional) is attached, the display changes from INFORMATION1 → INFORMATION2 → clear display, and so on every time you press this button.

- The display disappears automatically after about 15 seconds.
- is displayed during LAN communication.
- If is displayed in red, there is a duplicate IP address.

8. MODE (Color mode selection)

Each time you press this button, the color mode changes in the following order:

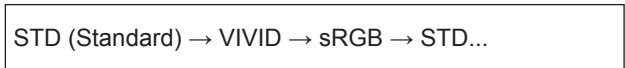

- sRGB applies to PC input only.
sRGB is international standard of color representation specified by IEC (International Electrotechnical Commission). Color conversion is made in taking account of liquid crystal's characteristics and represents color tone close to its original image.

Basic Operation

■Switching the screen size

Even when the screen size is changed, the display may remain the same depending on the input signal.

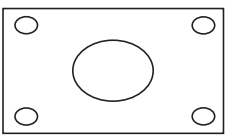
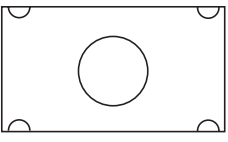
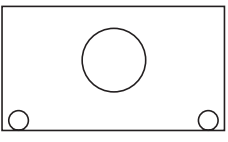
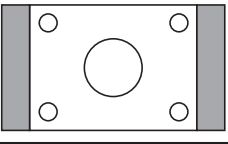
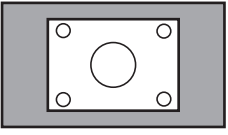
WIDE		PC input	Displays image so it fills the entire screen.
		AV input	An image with a 4:3 aspect ratio is stretched to fill the entire screen.
ZOOM 1		PC input	An image with a 4:3 aspect ratio is enlarged to fill the entire screen without changing the aspect ratio. The edges of the image may be cut off.
		AV input	
ZOOM 2		PC input	Use this size if ZOOM 1 cuts off the subtitles.
		AV input	
NORMAL		PC input	Displays image so it fills the screen without changing the aspect ratio of the input signals.
		AV input	Displays the entire image of the aspect ratio of 4:3 without changing the aspect ratio.
Dot by Dot		PC input	Displays the dots of the signals input from the connected PC as the corresponding dots on the screen.
		AV input	Displays the dots of the input signals as the corresponding dots on the screen.

TIPS

- Using this monitor's screen-size switching or dual-screen display functions to compress or expand the screen for commercial or public viewing in establishments like cafes or hotels may infringe on the rights of the creators, as protected by Copyright Law, so please be careful.
- When dual-screen display is selected, the screen size cannot be changed.
- The appearance of the original video may change if you select a screen size with a different aspect ratio than the original image (e.g. TV broadcast or video input from external equipment).
- When an ordinary non-wide image (4:3) is viewed with the whole screen using the screen-size switching function of this monitor, the edge of the image may be lost or appear distorted. If you wish to respect the creator's intentions, set the screen size to "NORMAL".
- When playing commercial software, parts of the image (like subtitles) may be cropped. In this case select the optimal screen size using the screen-size switching function of this monitor. With some software, there may be noise or distortion at the edges of the screen. This is due to the characteristics of the software, and is not a malfunction.
- Depending on the original image size, black bands may remain at the edges of the screen.

Menu Items

Displaying the menu screen

Video and audio adjustment and settings of various functions are enabled. This section describes how to use the menu items. See pages 24 to 27 for details of each menu items.

Caution

- Do not turn the main power switch off while the menu items are being displayed. Doing so may initialize the settings.

Example of operation

(Adjusting CONTRAST in the PICTURE menu)

- Press to display the menu screen.

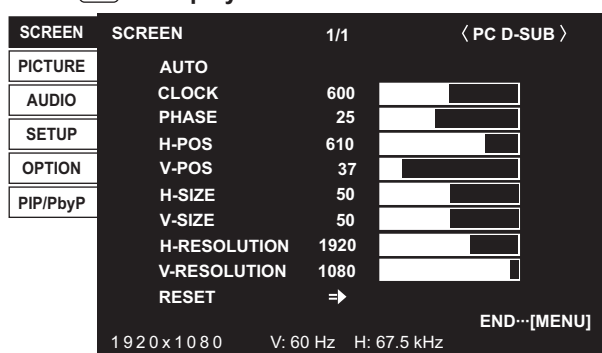

- Press or to select PICTURE, and press .

- Press or to select CONTRAST.

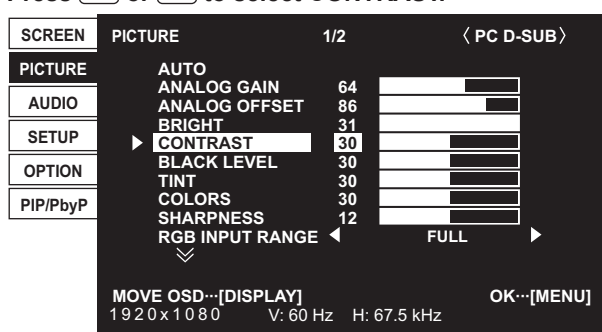

- Press or to adjust the setting.

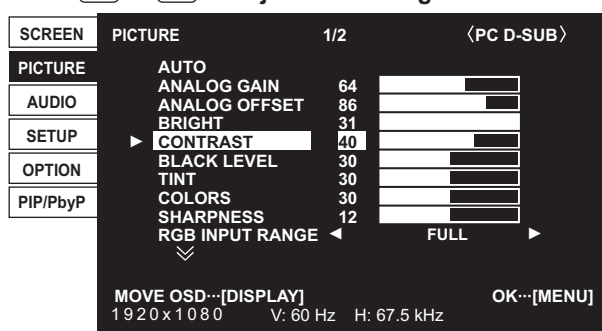

For items that have , press , make settings and then press .

- Press twice to close the menu screen.

TIPS

- The menu will differ depending on the input mode.
- The menu screen will close automatically if no operation is performed for about 15 seconds. (DATE/TIME SETTING, SCHEDULE and LAN SETUP screens will close in about 4 minutes.)

Menu screen display

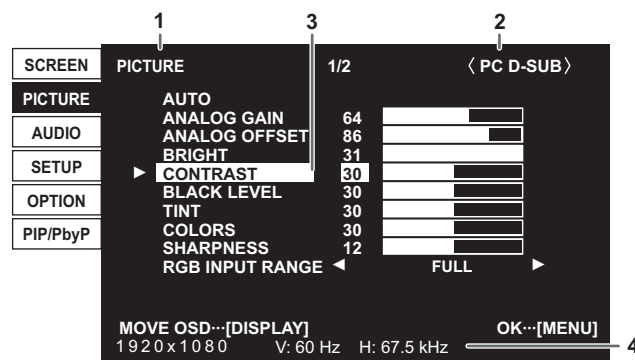

- Name of the menu
- Input mode
- An item being selected (highlighted)
- Screen resolution of input signal, and other data.

TIPS

- Items that cannot be selected appear in gray. (e.g. Function not supported by the current input signal)

Menu Items

The displayed menu items vary depending on whether or not the PN-ZB01 (optional) is attached.

The following menus will be displayed only when the PN-ZB01 (optional) is attached.

Menu	Item	
SETUP	HOT PLUG CONTROL DVI	
	RS-232C/LAN SELECT	
	LAN SETUP	
	SPEAKER SELECT	
OPTION	INPUT SELECT DVI	
	BNC	
	AUDIO SELECT	PC DVI-D
		PC D-SUB
		PC RGB
		AV DVI-D
		AV COMPONENT (BNC)
		AV COMPONENT (D-SUB)
AV S-VIDEO		
AV VIDEO (BNC)		
AV VIDEO (D-SUB)		
PIP/PbyP	PIP SOURCE	

Menu item details

The menu will differ depending on the input mode.

■SCREEN

You can move the menu screen display position each time  is pressed.

AUTO (PC D-SUB/PC RGB)

The CLOCK, PHASE, H-POS, and V-POS are automatically adjusted.

Pressing  performs adjustment.

Use this automatic adjustment when you use the PC D-sub input terminal or PC RGB input terminals to display a PC screen for the first time or when you change the setting of the PC. (See page 30.)

CLOCK (PC D-SUB/PC RGB)

Adjusts frequency for sampling clock for applicable video. Adjust when there is flickering in the form of vertical stripes. When using the adjustment pattern (see page 30), make adjustments so that no vertical stripe noise appears in it.

PHASE (PC D-SUB/PC RGB)

Adjusts sampling clock phase for applicable video. Useful when small characters appear with low contrast and/or there are flickers at corners. When using the adjustment pattern (see page 30), make adjustments so that no horizontal stripe noise appears in it.
* Adjustments to PHASE should be made only after CLOCK has been correctly set.

H-POS

Adjust the horizontal position of the image.

V-POS

Adjust the vertical position of the image.

H-SIZE

Adjust the horizontal size of the image.

V-SIZE

Adjust the vertical size of the image.

H-RESOLUTION (PC D-SUB/PC RGB)

Sets proper horizontal resolution when the resolution of input signals is not recognized properly. (Adjustment may be impossible with some signals.)

V-RESOLUTION (PC D-SUB/PC RGB)

Sets proper vertical resolution when the resolution of input signals is not recognized properly. (Adjustment may be impossible with some signals.)

RESET

Resets the values of the SCREEN menu items to the factory preset values.

Select "ON" and then press .

■PICTURE

You can move the menu screen display position each time  is pressed.

AUTO (PC D-SUB/PC RGB)

The ANALOG GAIN and ANALOG OFFSET are automatically adjusted.

Pressing  performs adjustment.

ANALOG GAIN (PC D-SUB/PC RGB)

Adjusts the bright portions of the video input signal.

ANALOG OFFSET (PC D-SUB/PC RGB)

Adjusts the dark portions of the video input signal.

BRIGHT

Adjusts the backlight brightness. (In PIP mode, the main side setting is reflected in the image.)

CONTRAST

Adjusts the difference between the bright and dark portions of the image.

BLACK LEVEL

Adjusts the entire brightness of the video signals.

TINT

Adjusts the hue. Selecting + changes the color towards green, and selecting - changes it towards magenta.

COLORS

Adjusts the color intensity.

SHARPNESS

Adjusts the sharpness of the image.

RGB INPUT RANGE (PC DVI-D/PC HDMI/PC D-SUB/PC RGB/AV DVI-D/AV HDMI)

Sets the RGB input signal range. When using HDMI set to AUTO, the RGB input signal is detected automatically. Use AUTO normally.

If the RGB input signal range cannot be set appropriately even when using AUTO, set according to the image. When the setting is different, images will be displayed with washed out blacks and compressed gradients.

ADVANCED (AV input)

You can adjust more specifically. (See page 30.)

COLOR MODE

Changes the color mode on the screen. The color mode on the screen can also be changed using a remote control unit. (See page 21.)

* sRGB is PC input only. See page 21 for details.

(In PIP mode, the main side setting is reflected in the image.)

WHITE BALANCE

THRU..... Displays the input signal level as is. (for PC DVI-D/PC HDMI only)

PRESET Selects the color temperature using PRESET.

USER..... Used for adjusting R-/G-/B-CONTRAST and R-/G-/B-OFFSET respectively.

(In PIP mode, the main side setting is reflected in the image.)

PRESET

Selects the color temperature when the WHITE BALANCE is set to PRESET.

The setting values are shown for reference. The color temperature of the screen varies over time.

This function is not intended to keep the color temperature constant.

USER

Adjusts each item when the WHITE BALANCE is set to USER.

R-CONTRAST Adjusts bright-toned red component.
 G-CONTRAST Adjusts bright-toned green component.
 B-CONTRAST Adjusts bright-toned blue component.
 R-OFFSET Adjusts dark-toned red component.
 G-OFFSET Adjusts dark-toned green component.
 B-OFFSET Adjusts dark-toned blue component.

COPY TO USER

Copies the value of white set for PRESET to the USER setting.

Select "ON" and then press .

(In the case other than white, color tone may differ from the PRESET.)

GAMMA

Selects the gamma. USER sets the gamma to the sent value (see page 35). (In PIP mode, the main side setting is reflected in the image.)

DISPLAY COLOR PATTERN

Displays a color pattern. Can be displayed while the menu screen is displayed, so you can refer to the pattern while adjusting the image.

OFF No pattern display.

WHITE White single color pattern display.

RED Red single color pattern display.

GREEN Green single color pattern display.

BLUE Blue single color pattern display.

USER Red/green/blue mixed color pattern display.
 When USER is selected, set each color's level.

RESET

Resets the values of the PICTURE menu items to the factory preset values.

Select "ON" and then press .

■AUDIO**TREBLE**

Adjusts the volume of treble-level sound.

BASS

Adjusts the volume of bass-level sound.

BALANCE

Adjusts the balance of the audio sound between right and left.

RESET

Resets the values of the AUDIO menu items to the factory preset values.

Select "ON" and then press .

■SETUP**OSD H-POSITION**

Adjusts the horizontal display position of menu screen.

OSD V-POSITION

Adjusts the vertical display position of menu screen.

SCREEN MOTION

Residual images are reduced by moving the screen.

PATTERN1 The whole screen moves vertically and horizontally.

PATTERN2 A black screen spreads from the bottom of the screen and then shrinks to the bottom of the screen.

PATTERN3 A black bar moves from the left end to the right end of the screen.

PATTERN4 Black screens appear from both the top and bottom of the screen, and the displayed image is compressed into the central field.

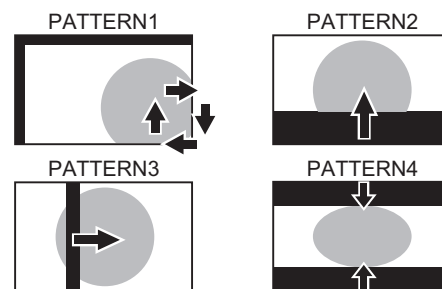
**MOTION TIME 1**

Specify a time period (operating interval) until SCREEN MOTION starts.

MOTION TIME 2

Specify a time period during which SCREEN MOTION operates (time period during which the screen will move).

MONAURAL AUDIO

Outputs audio signals as monaural.

LANGUAGE

Sets the display language for the menu screen.

POWER ON DELAY

You can delay the screen display after the monitor is turned on. The period can be set up to 60 seconds in units of one second. When this function is activated, the power LED flashes (at approx. 1 second interval) in orange. This function is disabled when 0 is specified.

STANDBY MODE

When STANDARD is selected, startup time from standby mode is reduced. Note, however that, more power will be consumed in standby mode.

When LOW POWER is selected, current consumption is reduced while the monitor is in standby mode. Note, however, that the startup time from standby mode becomes longer.

If set to LOW POWER, certain RS-232C commands cannot be used in standby mode, and control via LAN will be disabled.

OFF IF NO OPERATION

Determines whether or not to set the monitor to go into standby mode when there is no operation from the remote control unit, RS-232C commands, or LAN for over 4 hours.

Menu Items

HOT PLUG CONTROL

Sets whether to use hot plug control for the PC/AV HDMI and PC/AV DVI-D input terminals.

RS-232C/LAN SELECT

Selects the method with which to control the monitor from the computer.

ID No. SET

Assigns ID numbers to monitors connected in a daisy chain (see page 33), using RS-232 cables. The numbers 1 to 255 are available for ID numbers. If "0" is set, the system regards this as the state where no ID number is set.

AUTO ASSIGN ID No.

ID No. to be used will be automatically assigned when multiple monitors are connected with RS-232C. Select ON, then press . Perform operations using the first monitor in the daisy chain.

BAUD RATE

Selects the communication speed used for RS-232C communication.

LAN SETUP

Configures the settings to control the monitor from the computer via LAN. (See page 43.)

AUTO ASSIGN FIXED IP ADDR.

Can be enabled when RS-232C/LAN SELECT is LAN and the DHCP CLIENT is OFF. Set DHCP CLIENT to OFF for the monitor connected to the RS-232C output terminal and the daisy chain of connected monitors that follows. Fixed IP addresses are automatically allocated. If the IP address is a duplicate with a network device other than a monitor, individually change the IP address.



SPEAKER SELECT

Selects the speaker to be used.

HDMI AUTO VIEW

When ON is selected, the screen size is adjusted automatically according to the screen size control signal included in the video signal input from the AV HDMI input terminal.

COPY SETTING VALUE





When the monitor has been connected to multiple monitors by RS-232C, the settings in the monitor can be copied to the monitor connected to the RS-232C output terminal and to the daisy chain of connected monitors that follows. Selects the settings to copy with COPY SETTING VALUE TARGET.
"PICTURE" ONLY Copies the PICTURE menu settings.*
ALL Copies all the settings.*
Select the ID No. of the monitor that you would like copy to with COPY TO ID No., then select COPY and press .
If you select ALL, settings will be copied to all monitors. When you would like to confirm the ID No. that is set to the monitor, select ID No. and press . The ID No. will be displayed on the screen.
* Certain setting details such as ANALOG GAIN, ANALOG OFFSET, and DISPLAY COLOR PATTERN cannot be copied.

LOGO SCREEN

Sets whether or not to display the logo screen.

OPTION

DATE/TIME SETTING

Set the date and time. Press  or  to select the date and time, and press  or  to change the numerical values.

Set the date in "Month/Day/Year" order.

Set the time on a 12-hour basis. (Factory default)

DATE/TIME FORMAT

Sets the date/time display format.

DATEMM/DD/YYYY

DD/MM/YYYY

YYYY/MM/DD

(YYYY: Year, MM: Month, DD: Day)

TIMESelect 12- or 24-hour time.

SCHEDULE (See page 29.)

You can turn the power on/off and change the screen brightness at a specified time.

INPUT SELECT

Select the input mode to be used in PC D-Sub input terminal, PC/AV DVI-D input terminal, PC/AV HDMI input terminal and PC RGB/AV component input terminals.

For D-SUB, select SET after selecting the input mode, and then press .

D-SUB and BNC cannot be set to AV COMPONENT at the same time.

If D-SUB is set to AV VIDEO, the AV VIDEO input terminal cannot be used for BNC.

AUDIO SELECT

Selects the terminal used to input audio signals in each input mode.

INPUT SIGNAL (PC D-SUB/PC RGB)

If a computer connected to the PC D-sub/PC RGB input terminal outputs any of the following resolutions, make a selection from the following options.

480 LINES AUTO, 640x480 or 848x480

768 LINES AUTO, 1024x768, 1280x768, or 1360x768

1050 LINES 1400x1050 or 1680x1050

ZOOM2 SPECIAL SETTING (See page 28.)

SCAN MODE (AV input)

Sets the scan mode used for AV mode input.

MODE1 Over-scan display

MODE2 Under-scan display

MODE3 Under-scan display when the input signal is 1080i/p. Otherwise, over-scan display

* Even when MODE1 is selected, under-scan display is used when the input signal is 1080i/p and the screen size is Dot by Dot.

POWER MANAGEMENT

POWER MANAGEMENT determines whether or not to switch modes from no signal to the input signal standby mode.

COLOR SYSTEM (AV S-VIDEO/AV VIDEO)

Select the color system of the AV equipment which is connected to AV S-video and AV video input terminal. (AUTO / PAL / PAL-60 / SECAM / NTSC3.58 / NTSC4.43)

When AUTO is selected, the color system is automatically set according to the input signal.

AUDIO OUTPUT (RCA)

Sets the volume of sound output from the audio output terminals.

When set to VARIABLE 2, sound will not be output from the built-in speaker or the external speaker terminal.

VARIABLE1 You can adjust the volume using VOLUME.
VARIABLE2 You can adjust the volume using VOLUME.
FIXED Fixes the sounds.

AUDIO LEVEL (STEREO MINI)

Selects the maximum audio input level of the audio input terminal.

SELF ADJUST

On a PC D-SUB/PC RGB screen, specify whether to perform screen adjustment automatically or not. When ON is selected, the screen is automatically adjusted when its resolution is 800 x 600 or higher and the timing of input signals changes. "ADJUSTING" appears on the screen during the adjustment. For images with black edges, etc., depending on the signal, adjustment may not be possible. In this case select OFF. (Perform manual adjustment of the screen.)

AUTO INPUT CHANGE

Specify whether to change inputs automatically. When ON is selected and no signal is present in the selected input mode, AUTO INPUT CHANGE automatically changes the selected mode to another mode where a video signal is present.

When video signals exist in multiple input modes, the switching priority is as follows:

PC D-SUB, PC HDMI, AV HDMI, AV COMPONENT and AV VIDEO

When the PN-ZB01 (optional) is attached:

PC DVI-D, PC HDMI, PC D-SUB, PC RGB, AV DVI-D, AV HDMI, AV COMPONENT, AV S-VIDEO and AV VIDEO
(Input mode switching may take 15 seconds or more, depending on the connected equipment. Input signals may not be detected properly and a priority may change, depending on the connected equipment or video signals.)

TOUCH PANEL MODE (PC input)

When the resolution is 1920 x 1080, setting this to ON improves touch panel tracking.

When two screens are displayed, or when V-POS or V-SIZE is adjusted on the SCREEN menu, the screen may become distorted. In this vent, set to OFF.

■PIP/PbyP**PIP MODES**

Sets the display method.

OFFDisplays one screen.

PIPDisplays a sub screen inside a main screen.

PbyPDisplays a main screen and a sub screen in a line.

PbyP2Displays a main screen which measures 1280 pixels in the longest direction and a sub screen in a line.

PIP SIZE

Sets the size of the sub screen in PIP mode.

PIP H-POS

Adjusts the horizontal position of the sub screen in PIP mode.

PIP V-POS

Adjusts the vertical position of the sub screen in PIP mode.

PIP BLEND

In PIP mode, use this menu item to display the sub screen transparently.

PIP SOURCE

Selects the input signal of the sub screen in PIP, PbyP, or PbyP2 mode.

SOUND CHANGE

Sets the sound which is output in PIP, PbyP, or PbyP2 mode. If the main screen is displayed as a full screen by the AUTO OFF function, the sound for the main screen is output even when the sound for the sub screen is specified.

MAIN POS

Sets the position of the main screen in PbyP or PbyP2 mode.

PbyP2 POS

Sets the position of the sub screen in PbyP2 mode.

AUTO OFF

Sets the display method when no signals for the sub screen are input in PIP, PbyP, or PbyP2 mode.

MANUAL Displays a main screen and a black sub screen.

AUTO Displays the main screen as a full screen.

TIPS

- When WHITE BALANCE is set to THRU, BLACK LEVEL, CONTRAST, TINT, COLORS, RGB INPUT RANGE, GAMMA and COPY TO USER cannot be set.
- If COLOR MODE is set to sRGB, the following items cannot be set.
WHITE BALANCE, PRESET, USER, COPY TO USER, and GAMMA
- When the COLOR MODE is set to VIVID, GAMMA can not be adjusted.
- STANDBY MODE cannot be set to LOW POWER when SCHEDULE is effective or when OFF is selected for LED in FUNCTION.
- When displaying the color pattern, it is possible to adjust certain items of the PICTURE menu.
Non-adjustable items cannot be selected.
Audio input from the HDMI input terminal is also not output.

■Dual screen display

You can display the screens of the PC input signal and AV input signal simultaneously.

Set this function with "PIP MODES" in the PIP/PbyP menu.

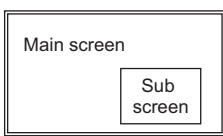
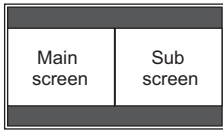
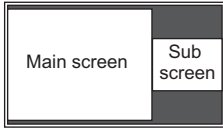
PIP		A sub screen is displayed inside a main screen.
PbyP		A main screen and a sub screen are displayed in a line.
PbyP2		Displays a main screen which measures 1280 pixels in the longest direction and a sub screen in a line.

- * The currently selected input signal is displayed on the main screen.
- * You cannot simultaneously display the screens of signals of the same type, such as two types of PC input signals or two types of AV input signals.
- * The dual screen display cannot be used with the combination of PC DVI-D and AV HDMI or of AV DVI-D and PC HDMI.

TIPS

- You might infringe on a copyright of the author which is protected by copyright law when you display the images of the computer screen and television/VCR simultaneously for profit-making or to show the image to the public.
- The screen size for dual-screen display is the same as the screen size for single-screen display. The Dot by Dot screen is displayed in NORMAL size except when it is set as the PIP main screen.
- When dual-screen display is selected, the SCREEN MOTION function is disabled.
- When dual-screen display is selected, the AUTO INPUT CHANGE function is disabled.
- When dual-screen display is selected, the INPUT SELECT options cannot be set.
- When an interlaced signal (1080i, 480i, video, S-Video) is input to the sub screen, horizontal lines may flicker. If this happens, display the image on the main screen.

■ZOOM2 SPECIAL SETTING

If you connect a laptop computer with any of the following screen resolutions and black bands appear around the screen, set ZOOM2 SPECIAL SETTING of INPUT SIGNAL on the OPTION menu to ON and then select ZOOM2 in the SIZE setting.

This displays the area inside the black band.

Laptop computer resolution	Corresponding signal*1
1280x800	1280x1024, 1280x960, 1400x1050*2
1280x600	1280x720
1024x600	1024x768

*1: This setting is effective only when the screen resolution, including the black band, is one of the resolutions listed above.

*2: Use the automatic screen adjustment.

■ SCHEDULE

You can set the time to switch the monitor on and off.
Set this function with "SCHEDULE" in the OPTION menu. (See page 26.)

SCHEDULE							< PC D-SUB >	
No.	(1) POWER	(2) DAY OF THE WEEK	(3) TIME	(4) INPUT	(5) BRIGHT	(6)		
1	-	--	--	--	--	--	--	--
2	-	--	--	--	--	--	--	--
3	-	--	--	--	--	--	--	--
4	-	--	--	--	--	--	--	--
5	-	--	--	--	--	--	--	--
6	-	--	--	--	--	--	--	--
7	-	--	--	--	--	--	--	--
8	-	--	--	--	--	--	--	--

1920 x 1080 V: 60 Hz H: 67.5 kHz OK--[MENU]

- Press or to select the SCHEDULE number, and press .
- Set the SCHEDULE. (See the description below.)
Press or to select items, and press or to change the setting.
- Press .
SCHEDULE becomes effective.

(1)

- : SCHEDULE effective
- : SCHEDULE not effective

(2) POWER

ON : Switches the monitor on at the specified time.
OFF : Switches the monitor off at the specified time and puts the monitor in standby mode.

(3) DAY OF THE WEEK

Specifies the day of the week to execute the SCHEDULE.

0: ONLY ONCE

Executes the SCHEDULE once on the specified day.
Specify the day of the week to execute the SCHEDULE.

1: EVERY WEEK

Executes the SCHEDULE on the specified day of the week every week. Specify the day of the week to execute the SCHEDULE.
Periodic setting such as "Monday through Friday" is also possible.

2: EVERY DAY

Executes the SCHEDULE every day regardless of the day of the week.

(4) TIME

Specifies the time to execute the SCHEDULE.
Set the time on a 12-hour basis. (Factory default)
Can be entered as 24-hour time using the TIME setting in DATE/TIME FORMAT.

(5) INPUT

Specifies the input mode at power-on. When not specifying, the screen at the previous power-off appears.
Input modes displayed on DVI, HDMI, BNC and D-SUB depend on INPUT SELECT settings.

(6) BRIGHT

Sets the brightness when changing the screen brightness at a specified time.

! Caution

- Do not switch off the main power after setting the SCHEDULE.
- Specify the correct date and time. (See page 26.)
SCHEDULE does not function unless the date and time are specified.
- Check regularly that the set date and time are correct.
- When STANDBY MODE is LOW POWER, SCHEDULE cannot be set.
- When a temperature abnormality occurs and the backlight brightness is reduced, the brightness is not changed even if a schedule set to BRIGHT is executed.

TIPS

- Up to 8 SCHEDULE items can be registered.
- Setting the SCHEDULE flashes the power LED alternately in red and orange in standby mode.
- A SCHEDULE that has a large number has precedence over that of a small number when schedules overlap.
- If D-SUB of INPUT SELECT on the OPTION menu is set to AV VIDEO, the input mode will switch to AV VIDEO (D-SUB) regardless if set to D-SUB or VIDEO.

■ADVANCED items (AV input) (See page 24 for additional Menu item details.)

FLESH TONE

Adjust the hue control.

3D-NR

Reduce the noise of playback images on video. Setting a higher level reduces more noise. However, it may cause blurring on an image.

MPEG-NR

Reduce block noise caused by digital compression.

3D-Y/C (AV VIDEO)

Specify whether to perform 3-dimension Y/C separation. If dot interference or cross-color is occurring in fast-motion scenes, selecting "OFF" may improve the image quality.

C.M.S.-HUE

Adjusts color tone with 6 colors of R (red), Y (yellow), G (green), C (cyan), B (blue), and M (magenta).

C.M.S.-SATURATION

Adjusts color vividness with 6 colors of R (red), Y (yellow), G (green), C (cyan), B (blue), and M (magenta).

C.M.S.-VALUE

Adjusts color brightness with 6 colors of R (red), Y (yellow), G (green), C (cyan), B (blue), and M (magenta).





TIPS

- When FLESH TONE is set to LOW or HIGH, C.M.S.-HUE/-SATURATION/-VALUE cannot be set.

Adjustments for PC screen display

■Automatic adjustment

When you use the PC D-sub input terminal or PC RGB input terminals to display a PC screen for the first time, or when you change the setting of the PC, use the automatic screen adjustment.

1. **Switch the input to PC D-SUB or to PC RGB and display the adjustment pattern.** (See the description below.)
2. Press  and use  or  to display the SCREEN menu.
3. Press  and select "AUTO".
4. Press .

The automatic adjustment is complete in several seconds.
5. Press  twice to close the menu screen.

TIPS

- If the screen cannot be adjusted properly with one automatic adjustment, repeat the automatic adjustment two or three times. Try manual adjustment if necessary.

■Screen display for adjustment

Before making adjustments in the SCREEN menu or PICTURE menu, display an image to brighten the entire screen. If you are using a Windows PC, use the adjustment pattern on the supplied CD-ROM.

Opening the adjustment pattern

The following example is performed in Windows 7.

1. **Load the supplied CD-ROM into the computer's CD-ROM drive.**
2. **Open [CD Drive] in [Computer].**
In Windows XP, open [CD Drive] in [My Computer].
3. **Double-click [Adj_uty.exe] in the [Monitor] folder.**
The adjustment pattern will appear.
Adjust the screen automatically or manually.

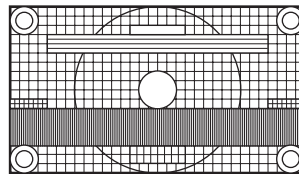





4. **When adjustment is finished, press the [Esc] on the computer's keyboard to quit the adjustment program.**
5. **Eject the CD-ROM from the CD-ROM drive.**

TIPS

- If the display mode on the computer you are using is 65,000 colors, the color levels in the color pattern may appear differently or grayscale may appear to be colored. (This is due to the specifications of the input signal and is not a malfunction.)

Initialization (Reset)/Functional Restriction Setting (FUNCTION)

You can return the settings to their factory-preset values and restrict operations.

1. Hold  down until "F" appears in the upper left corner of the screen.
2. While "F" appears, press , , ,  in that order.

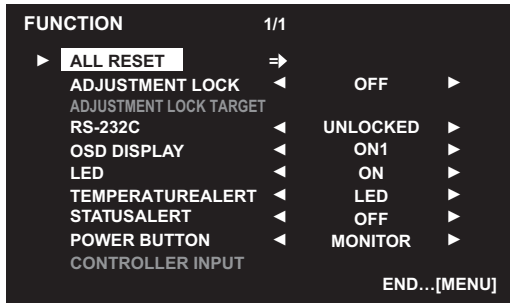



3. Select and set the items.

ALL RESET

Resets the settings to the factory default settings.

Press , select ALL RESET, and then press .

After initialization, turn the main power switch off and then back on.

When the PN-ZB01 (optional) is attached, press , select the resetting method, and then press .

ALL RESET1Resets all the settings to the factory default settings.

ALL RESET2Returns all settings to the factory default settings except for the following items:
LAN SETUP, RS-232C/LAN SELECT, ID No. SET, BAUD RATE, NETWORK, MAIL, SERVICE & SUPPORT, and SNMP (See page 26, and pages 47 to 50.)

ADJUSTMENT LOCK

You can disable operations on the monitor and the remote control unit that use buttons.

OFF ... Enables operation.

ON 1 ..Disables all operations other than turning power on/off and FUNCTION.

ON 2 ..Only the FUNCTION operation is enabled.
Disables all operations other than FUNCTION (not even power on/off).

ADJUSTMENT LOCK TARGET

Sets the target to prohibit operation of with ADJUSTMENT LOCK.

REMOTE CONTROL..... Prohibits remote control operation

MONITOR BUTTONS ... Prohibits monitor button operation

BOTH..... Prohibits remote control and monitor button operation

RS-232C

(RS-232C/LAN when the PN-ZB01 (optional) is attached)

Specifies whether to allow control via RS-232C or LAN (see pages 32 and 43).

OSD DISPLAY

Shows/hides the menu, modes, and messages.

The FUNCTION screen cannot be hidden.

ON 1 Shows all menus, modes, and messages.

ON 2 Hides messages automatically displayed by the display. Shows messages during operation.

OFF Hides all menus, modes, and messages.

LED

Specifies whether to light the power LED.

OFF cannot be selected when STANDBY MODE is LOW POWER.

TEMPERATURE ALERT

Selects the notification method for an abnormal temperature.

OFF Do not notify about an abnormal temperature.

OSD & LED .. When an abnormal temperature is detected, the power LED flashes in red and green alternately and the screen displays a message: TEMPERATURE.

LED..... When an abnormal temperature is detected, the power LED flashes in red and green alternately.

STATUS ALERT

Selects the notification method for a hardware error.

OFF Do not notify about the error.

OSD & LED .. When a hardware error is detected, the power LED flashes in red and the screen displays a message: STATUS [xxxx].

LED..... When a hardware error is detected, the power LED flashes in red.

POWER BUTTON

Normally, leave this setting as MONITOR.

When using an optional part, if instruction appears, change the setting accordingly.

CONTROLLER INPUT

Normally, you do not need to change this setting.

When using an optional part, if instruction appears, change the setting accordingly.

4. Press  to return to the normal screen.

TIPS

- When both abnormal temperature and hardware error are detected, the hardware error notification overrides.
- If TEMPERATURE ALERT or STATUS ALERT is set to OSD&LED, alert messages will appear even if the OSD DISPLAY is set to ON 2 or OFF.

Controlling the Monitor with a PC (RS-232C)

You can control this monitor from a PC via RS-232C (COM port) on the PC.

You can also connect multiple monitors via a daisy chain by using a PC. By assigning ID numbers to each monitor (see page 33), you can make input mode selection/adjustment or can check the status of a specific monitor.

Precautions when the PN-ZB01 (optional) is attached

- To control the monitor via RS-232C, set RS-232C/LAN SELECT to RS-232C.
- You cannot use RS-232C and LAN control simultaneously.

PC connection

One-to-one connection with a PC

Connect with RS-232 straight cable between the PC's COM port (RS-232C connector) and the RS-232C input terminal on the monitor.

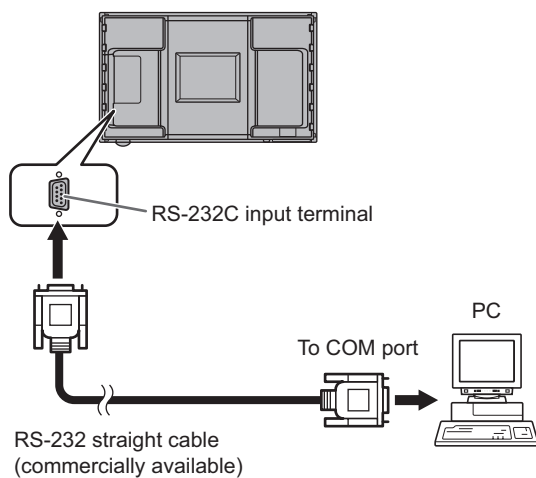

Daisy chain connection... Advanced operation

Connect with RS-232 straight cable between the PC's COM port (RS-232C connector) and the RS-232C input terminal on the first monitor.

Next, connect RS-232 straight cable to the first monitor's RS-232C output terminal and to the second monitor's RS-232C input terminal. Connect in the same way to the third and subsequent monitors.

Up to 25 monitors can be connected. (Depending on the length of the cable used and the surrounding environment.)

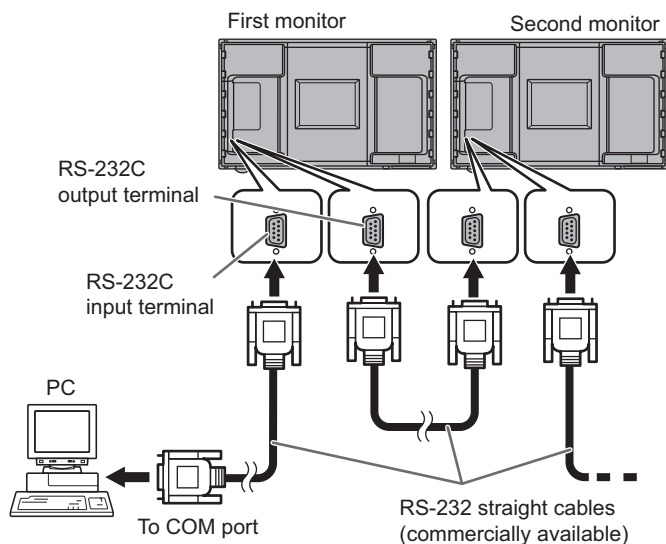

Communication conditions

Set the RS-232C communication settings on the PC to match the monitor's communication settings as follows:

Baud rate	*
Data length	8 bits
Parity bit	None

Stop bit	1 bit
Flow control	None

* Set to the same baud rate as the BAUD RATE setting of SETUP menu. (Initial setting: 38400 bps)

* When connecting multiple monitors in a daisy chain, set all monitors to the same BAUD RATE.

Communication procedure

Command format

When a command is sent from the PC to the monitor, the monitor operates according to the received command and sends a response message to the PC.

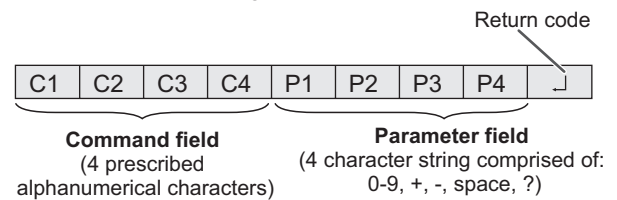

Example: VOLM0030
VOLM _ _ 30

* Be sure to input 4 characters for the parameter. Pad with spaces (" ") if necessary.

("␣" is a return code (0DH, 0AH or 0DH))

Wrong : VOLM30␣

Right : VOLM _ _ 30␣

When inputting a negative value, specify a numerical value in three digits.

Example: AUTC-005

Do not use spaces for MPOS, DATE, and SC01 through SC08. Specify parameters using a specified number of characters.

Example: MPOS010097

If a command has "R" listed for "DIRECTION" in the "RS-232C command table" on page 36, the current value can be returned by using "?" as the parameter.

Example:

VOLM ? ? ? ? ← From PC to monitor (How much is current volume setting?).

30 ← From monitor to PC (Current volume setting: 30).

* If an ID number (see page 33) has been assigned (For example, ID number = 1).

VOLM _ _ _ ? ← From PC to monitor.

30 _ 001 ← From monitor to PC.

Response code format

When a command has been executed correctly

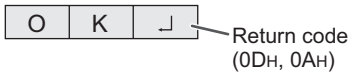

A response is returned after a command is executed.

* If an ID number has been assigned

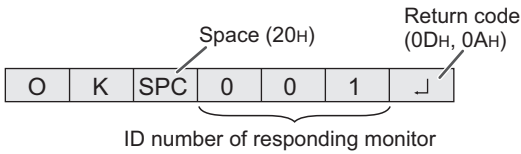

When a command has not been executed

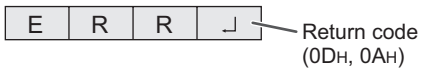

* If an ID number has been assigned

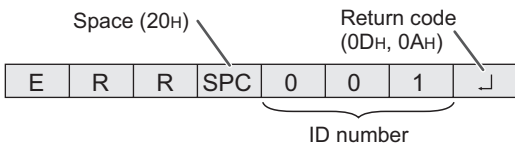

TIPS

- “ERR” is returned when there is no relevant command or when the command cannot be used in the current state of the monitor.
- If communication has not been established for reasons such as a bad connection between the PC and monitor, nothing is returned (not even ERR).
- “ERR” may be returned when a command cannot be received correctly due to interference from the surrounding environment.
Please ensure that the system or software retries the command if this occurs.
- If no monitor has been assigned the designated ID number (e.g. if the command IDSL0002 is used, but no monitor with ID number: 2 is found), no response is returned.

If execution of the command is taking some time



When the following commands are used, “WAIT” is returned. In this case, a value will be returned if you wait a while. Do not send any command during this period.

No ID number is attached to WAIT response.

- Commands which return WAIT:
 1. When repeater control is used
 2. When an IDSL or IDLK command is used
 3. When one of the following commands is used: RSET, INPS, ASNC, WIDE, PXSL, POWR, AGIN, MWIN, MWIP, MWPP

When control via RS-232C is locked (to prevent use) using the operation lock function (see page 31)



When RS-232C/LAN SELECT is set to LAN

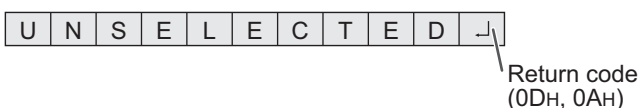

Communication interval

- After OK or ERR is returned, you must send the following commands.

To set a timeout for the command response, specify 10 seconds or longer.

When connecting multiple monitors in a daisy chain, set the timeout to at least the product of the monitor’s position from the computer multiplied by 10 seconds.

Example) 3rd monitor from computer: 30 seconds or longer.

- Provide an interval of 100 ms or more between the command response and the transmission of the next command.

VOLM0020

OK

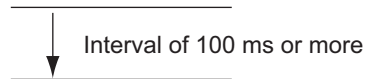

INPS0001

WAIT

OK

TIPS

- When executing ALL RESET, set the timeout period to 30 seconds or longer.
- When turning the power on while the POWER ON DELAY function is in use, set the timeout period to the POWER ON DELAY period + 10 seconds or longer.

Advanced operation

This section explains commands for daisy chain connection. The basic communication procedure is the same as in the “One-to-one connection with a PC” section.

ID numbers

You can assign a unique ID number to each monitor (see page 26). This allows you to control a particular monitor in a daisy chain of monitors.

You can assign ID numbers either from the menu screen or from the PC using RS-232 cable.

[Example]

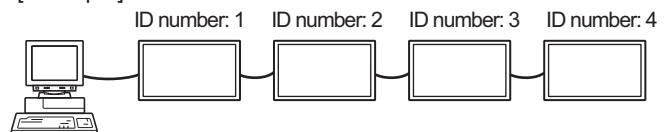

If monitors are connected as shown above, you can execute commands like “Set the volume of the monitor with ID 4 to 20”.

When controlling monitors linked in a daisy chain by designating ID numbers, you should basically avoid any duplication of ID numbers.

ID numbers do not have to be assigned in ascending order starting from the PC. They can also be connected as shown below.

[Example]

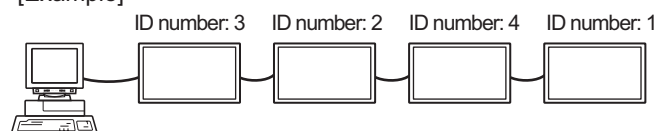

Controlling the Monitor with a PC (RS-232C)

■ Commands for ID control

The command examples shown on this page assume the following connection and ID number set up.

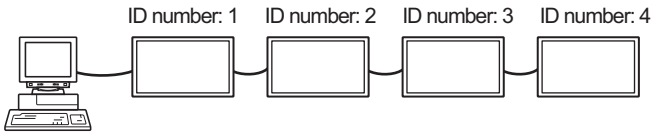

IDSTA monitor receiving this command sets its own ID number in the parameter field.

Example:

IDST0001

OK _ 001 ← The ID number of this monitor is set to 1.

TIPS

You can automatically assign ID numbers by using the IDST command with the Repeater control (see “Repeater control” on page 35).

For example, using the command “IDST001+” automatically sets the ID numbers, as shown below.

[Example]

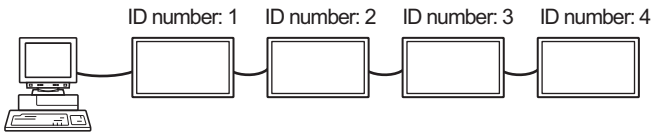

IDST001 + ← ID setting command with repeater control

WAIT

OK _ 001 ← “OK” response from ID number: 1

OK _ 002 ← “OK” response from ID number: 2

OK _ 003 ← “OK” response from ID number: 3

OK _ 004 ← “OK” response from ID number: 4 (End)

IDSLThe parameter of this command sets the ID number of the monitor. The monitor is subject to the next command.

Example:

IDSL0002 ← The next command is for the monitor with ID number: 2.

WAIT ← Searching for monitor with ID number: 2

OK _ 002 ← Found monitor with ID number: 2

VOLM0030 ← Sets volume of monitor with ID number: 2 to 30.

WAIT ← Processing

OK _ 002 ← OK response from monitor with ID number: 2

VOLM0020 ← Sets volume to 20.

OK _ 001 ← The volume of the monitor with ID number: 1 (the one directly connected to the PC) is set to 20.*

* The IDSL command is effective only once, for the immediately succeeding command.

IDLKThe parameter of this command sets the ID number of the monitor. The monitor is subject to all subsequent commands.

Example:

IDLK0002 ← Following commands are for the monitor with ID number: 2.

WAIT ← Searching for monitor with ID number: 2

OK _ 002 ← Found monitor with ID number: 2

VOLM0030 ← Sets volume of monitor with ID number: 2 to 30.*

WAIT ← Processing

OK _ 002

VOLM0020 ← Sets volume of monitor with ID number: 2 to 20.*

WAIT

OK _ 002

IDLK0000 ← Canceling fixed ID number setting

WAIT ← Canceling IDLK

OK _ 002 ← Cancellation complete

VOLM0010

OK _ 001 ← The volume of the monitor with ID number: 1 (the one directly connected to the PC) is set to 10. (IDLK is canceled.)

* The IDLK command remains effective until it is canceled, or power is shut off.

IDCK.....Provides screen display of the ID number currently assigned to a monitor, and the ID number currently set for IDLK (if any).

Example:

(After executing IDLK0002)

IDCK0000 ← (Parameter has no meaning.)

ID : 001 IDLK : 002 ← Returned response. The ID number is also displayed on the monitor screen.

IDCK000 + ← Repeater control. (If a command is used with repeater control, ID designation using IDSL or IDLK is canceled.)

WAIT

ID : 001 IDLK : 000

ID : 002 IDLK : 000

ID : 003 IDLK : 000

ID : 004 IDLK : 000

■ Repeater control

This system has a function to allow setting of multiple monitors connected in a daisy chain using a single command. This function is called repeater control. You can use Repeater control function without assigning ID numbers.

[Example]

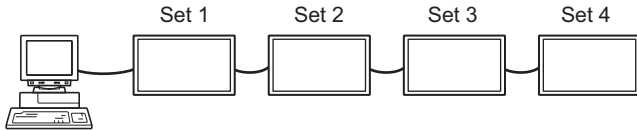

* If monitors are connected as shown above, you can execute a command like "Set all monitors' input settings to PC D-SUB".

■ Repeater control command

Repeater control is achieved by setting the **FOURTH CHARACTER** of the parameter to "+".

Example:

VOLM030 + ← Sets volume of all monitors to 30.

In repeater control, responses are returned by all the connected monitors.

If you want to determine that a value has been returned by a specific set, assign ID numbers to each monitor in advance. When some monitors do not return their responses, the probable cause is that the monitors could not receive the command or command processing is not complete. Do not send a new command.

Example: (When 4 monitors are connected, and assigned ID numbers: 1 through 4)

```
VOLM030 +
WAIT
OK _ 001
OK _ 002
OK _ 003
OK _ 004 ← If 4 monitors are connected in
a chain, reliable operation can
be ensured by sending a new
command only after a reply
has been returned by 4th (last)
monitor.
```

Repeater control can also be used for reading settings.

Example:

```
VOLM ??? +
WAIT
10 _ 001
20 _ 002
30 _ 003
30 _ 004
```

Volume settings for all monitors are returned.

Setting of the GAMMA user data

■ To transfer the GAMMA user data

Use the user data transfer commands (UGRW, UGGW and UGBW). For each of the R, G and B colors, divide the total 512 pieces of user data into 16 blocks, and transfer 32 pieces of data with each command.

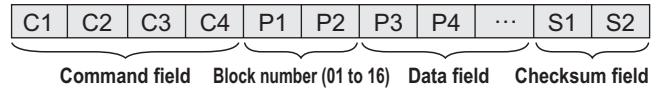

Example: To transfer the data of block 1 (0 to 31 levels) of red (R) data

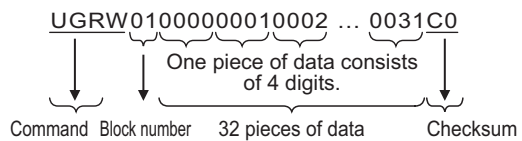

- * If data is less than 4 digits, add a "0" (zero) to make it 4 digits.
- * The checksum field is the character string (ASCII) data of lower-order one byte which indicates the sum of the block number and 32 pieces of data in hexadecimal (0 to F).

■ Saving the GAMMA user data

Use the user data save command (UGSV) to save the transferred user data in the monitor.

If the data is not saved, it will be cleared when:

- The main power switch is off
- STANDBY MODE is LOW POWER and the monitor enters standby mode

■ Activating the GAMMA user data

To activate the transferred user data, select **USER** for **GAMMA** of the **PICTURE** menu, or send the corresponding RS-232C command.

■ Checking the GAMMA user data

Use the user data read commands (UGRR, UGGR and UGBR) to return 512 pieces of user data for each of the R, G and B colors. Divide the data into 16 blocks and return 32 pieces of data with each command. The value to be returned is not the value stored in the monitor, but the value in the temporary memory for display. (These values are the same when the user data save command (UGSV) above has been sent.)

TIPS

- The user data is not initialized by **RESET** of the **PICTURE** menu. To initialize the user data, use **ALL RESET** of the **FUNCTION** menu.
- The **GAMMA** user data initialize command (UGRS) allows the initialization of the user data only.

TIPS

- If repeater control is used during ID designation (IDSL, IDLK), the ID designation is canceled.

Controlling the Monitor with a PC (RS-232C)

RS-232C command table

How to read the command table

- Command: Command field (See page 32.)
 Direction: W When the "Parameter" is set in the parameter field (see page 32), the command functions as described under "Control/Response Contents".
 R The returned value indicated under "Reply" can be obtained by setting "????", "???" or "???" (repeater control) in the parameter field (see page 32).
 Parameter: Parameter field (See page 32.)
 Reply: Response (Returned value)
 *1: "●" indicates a command which can be used in power standby mode regardless of the STANDBY MODE setting.
 "○" indicates a command which cannot be used in power standby mode when STANDBY MODE is set to LOW POWER.
 "-" indicates a command which cannot be used in power standby mode regardless of the STANDBY MODE setting.
 *2: PN-ZB01 (optional) limitations
 (A) When PN-ZB01 (optional) is not attached, (B) When PN-ZB01 (optional) is attached.
 ○ : The command can be used.
 - : Error (ERR)

Power control/Input mode selection

Function	Command	Direction	Parameter	Reply	Control/Response contents	*1	*2		
							(A)	(B)	
POWER CONTROL	POWR	W	0		Switches to standby mode.				
			1		Returns from standby mode.				
		R		0		Standby mode	●	○	○
				1		Normal mode			
				2		Input signal waiting mode			
INPUT MODE SELECTION	INPS	W	0		Toggle change for input mode. Terminals not selected in INPUT SELECT cannot be selected.		○	○	
			1		PC DVI-D "ERR" when AV DVI-D is selected for DVI of INPUT SELECT.		-	○	
			2		PC D-SUB "ERR" when other than PC D-SUB is selected for D-SUB of INPUT SELECT.		○	○	
			3		AV COMPONENT (BNC) / AV COMPONENT (D-SUB) "ERR" when other than PC RGB is selected for BNC of INPUT SELECT, and when other than AV COMPONENT is selected for D-SUB of INPUT SELECT.		○	○	
			4		AV VIDEO (BNC) / AV VIDEO (D-SUB)	●	○	○	
			6		PC RGB "ERR" when AV COMPONENT is selected for BNC of INPUT SELECT.		-	○	
			7		AV DVI-D "ERR" when PC DVI-D is selected for DVI of INPUT SELECT.		-	○	
			8		AV S-VIDEO		-	○	
			9		AV HDMI		○	○	
			10		PC HDMI "ERR" when AV HDMI is selected for HDMI of INPUT SELECT.		○	○	
		R		1		PC DVI-D			
				2		PC D-SUB			
				3		AV COMPONENT			
				4		AV VIDEO			
				6		PC RGB	●	○	○
				7		AV DVI-D			
				8		AV S-VIDEO			
				9		AV HDMI			
				10		PC HDMI			

Controlling the Monitor with a PC (RS-232C)

SCREEN menu

Function		Command	Direction	Parameter	Reply	Control/Response contents	*1	*2	
							(A)	(B)	
AUTO		ASNC	W	1		When the input mode is PC D-SUB, PC RGB.			
CLOCK		CLCK	WR	0-1200	0-1200	When the input mode is PC D-SUB, PC RGB. Varies depending on the signal.			
PHASE		PHSE	WR	0-63	0-63	When the input mode is PC D-SUB, PC RGB.			
POSITIONING	POSITION OF THE LONGEST DIRECTION	HPOS	WR	0-100	0-100	0-800 on PC D-SUB, PC RGB. Varies depending on the signal.			
	POSITION OF THE SHORTEST DIRECTION	VPOS	WR	0-100	0-100	0-200 on PC D-SUB, PC RGB. Varies depending on the signal.			
SIZE	POSITION OF THE LONGEST DIRECTION	HSIZ	WR	0-100	0-100		-	○	○
	POSITION OF THE SHORTEST DIRECTION	VSIZ	WR	0-100	0-100				
RESOLUTION	LONGEST DIRECTION RESOLUTION	HRES	WR	300-1920	300-1920	When the input mode is PC D-SUB, PC RGB. Only even numbers are valid for parameters. Varies depending on the signal.			
	SHORTEST DIRECTION RESOLUTION	VRES	WR	200-1200	200-1200				
RESET		ARST	W	1					

Controlling the Monitor with a PC (RS-232C)

PICTURE menu

Function	Command	Direction	Parameter	Reply	Control/Response contents	*1	*2 (A) (B)
AUTO	AGIN	W	1		When the input mode is PC D-SUB, PC RGB.	-	
ANALOG GAIN	ANGA	WR	0-127	0-127	When the input mode is PC D-SUB, PC RGB.		
ANALOG OFFSET	ANOF	WR	0-127	0-127	When the input mode is PC D-SUB, PC RGB.		
CONTRAST	CONT	WR	0-60	0-60			
BLACK LEVEL	BLVL	WR	0-60	0-60			
TINT	TINT	WR	0-60	0-60			
COLORS	COLR	WR	0-60	0-60			
SHARPNESS	SHRP	WR	0-24	0-24			
RGB INPUT RANGE (AV HDMI)	AHDR	WR	0-2	0-2	0: AUTO, 1: FULL, 2: LIMITED		
RGB INPUT RANGE (PC HDMI)	PHDR	WR	0-2	0-2	0: AUTO, 1: FULL, 2: LIMITED		
RGB INPUT RANGE (AV DVI)	ADVR	WR	1-2	1-2	1: FULL, 2: LIMITED		
RGB INPUT RANGE (PC DVI)	PDVR	WR	1-2	1-2	1: FULL, 2: LIMITED		
RGB INPUT RANGE (D-SUB)	PDSR	WR	1-2	1-2	1: FULL, 2: LIMITED		
RGB INPUT RANGE (PC BNC)	PBRR	WR	1-2	1-2	1: FULL, 2: LIMITED		
ADVANCED (When the input mode is AV.)	FLESH TONE	FLES	WR	0-2	0-2	0: OFF, 1: LOW, 2: HIGH	
	3D-NR	TDNR	WR	0-2	0-2	0: OFF, 1: LOW, 2: HIGH	
	MPEG-NR	MPNR	WR	0-1	0-1	0: OFF, 1: ON	
	3D-Y/C	YCSP	WR	0-1	0-1	0: OFF, 1: ON (When the input mode is AV VIDEO)	
	C.M.S.-HUE	CMHR	WR	-10-10	-10-10	R	
						Y	
						G	
						C	
						B	
						M	
						CRST	W
	C.M.S.-SATURATION	CMSR	WR	-10-10	-10-10	R	
						Y	
						G	
						C	
						B	
						M	
						CRST	W
	C.M.S.-VALUE	CMVR	WR	-10-10	-10-10	R	
						Y	
G							
C							
B							
M							
CRST						W	3
COLOR MODE	BMOD	WR	0	0	STD		
			2	2	VIVID		
			3	3	sRGB (When the input mode is PC)		
WHITE BALANCE	THRU	CTMP	WR	0	0	When the input mode is PC DVI-D/PC HDMI.	
	PRESET			1-18	1-18	From 1: approximately 3,000K to 15: approximately 10,000K (500K steps) 16: approximately 5,600K, 17: approximately 9,300K, 18: approximately 3,200K	
	USER			99	99		
	R-CONTRAST	CRTR	WR	0-256	0-256	"ERR" when CTMP is not set to 99.	
	G-CONTRAST	CRTG	WR	0-256	0-256		
	B-CONTRAST	CRTB	WR	0-256	0-256		
	R-OFFSET	OFSR	WR	-127-127	-127-127		
	G-OFFSET	OFSG	WR	-127-127	-127-127		
	B-OFFSET	OFSB	WR	-127-127	-127-127		
COPY TO USER	CPTU	W	0		Copies a preset value to the user setting.	-	
GAMMA	GAMM	WR	0-2	0-2	0: 1.8, 1: 2.2, 2: 2.4(during PC input) 0: LIGHT 2, 2: DARK (during AV input)		
			4-6	4-6	4: USER, 5: 2.0, 6: STD (during PC input) 4: USER, 5: LIGHT 1, 6: STD (during AV input)		
DISPLAY COLOR PATTERN	PTDF	WR	0	0	No pattern display.		
			1	1	White single color pattern display.		
			2	2	Red single color pattern display.		
			3	3	Green single color pattern display.		
			4	4	Blue single color pattern display.		
			99	99	Red/green/blue mixed color pattern display. Set each color's level with RED, GREEN, BLUE.		
RED	PTDR	WR	0-15	0-15	"ERR" when PTDF is not set to 99.		
GREEN	PTDG	WR	0-15	0-15			
BLUE	PTDB	WR	0-15	0-15			
RESET	ARST	W	2			-	

Controlling the Monitor with a PC (RS-232C)

AUDIO menu

Function	Command	Direction	Parameter	Reply	Control/Response contents	*1	*2	
							(A)	(B)
TREBLE	AUTR	WR	-5-5	-5-5				
BASS	AUBS	WR	-5-5	-5-5		○	○	○
BALANCE	AUBL	WR	-10-10	-10-10				
RESET	ARST	W	3			-		

SETUP menu

Function	Command	Direction	Parameter	Reply	Control/Response contents	*1	*2	
							(A)	(B)
OSD H-POSITION	OSDH	WR	0-100	0-100				
OSD V-POSITION	OSDV	WR	0-100	0-100		○		
SCREEN MOTION	SCSV	WR	0-4	0-4	0: OFF, 1-4: PATTERN1-4	○		
MOTION TIME 1	MTIM	WR	0-20	0-20		○		
MOTION TIME 2	PATTERN1	MINT	10-990	10-990	Per 10 seconds	○		
	PATTERN2-4	MINT	5-20	5-20	Per second	○		
MONAURAL AUDIO	MONO	WR	0-1	0-1	0: OFF, 1: ON	○		
LANGUAGE	LANG	WR	14	14	ENGLISH	○	○	○
			1	1	DEUTSCH			
			2	2	FRANÇAIS			
			3	3	ITALIANO			
			4	4	ESPAÑOL			
			5	5	РУССКИЙ			
POWER ON DELAY	PWOD	WR	0	0	OFF	○		
			1-60	1-60	ON			
STANDBY MODE	STBM	WR	0-1	0-1	0: STANDARD, 1: LOW POWER ("ERR" when SCHEDULE is effective or OFF is selected for LED.)	○		
OFF IF NO OPERATION	ATOF	WR	0-1	0-1	0: OFF, 1: ON	○		
HOT PLUG CONTROL (DVI)	HPCT	WR	0-1	0-1	0: OFF, 1: ON	○	-	○
HOT PLUG CONTROL (HDMI)	HPCH	WR	0-1	0-1	0: OFF, 1: ON	○	○	○
RS-232C/LAN SELECT	CTLS	WR	0-1	0-1	0: RS-232C 1: LAN	○	-	○
ID NUMBER	ID NO. SETTING	IDST	W	0-255		○	○	○
					R			
	ID NO. SETTING (ONCE)	IDSL	W	1-255		○	○	○
					0			
	ID NO. SETTING (SUBSEQUENT)	IDLK	W	1-255		○	○	○
0								
ID CHECK	IDCK	W	0	ID : xxx IDLK : yyy				
BAUD RATE	BAUD	WR	0-2	0-2	0: 9600bps, 1: 19200bps, 2: 38400bps	○	○	○
SPEAKER SELECT	SPSL	WR	0-1	0-1	0: Internal speaker, 1: External speaker	○	-	○
HDMI AUTO VIEW	HDAW	WR	0-1	0-1	0: OFF, 1: ON	○	○	○
			0	0	Copy to all monitors.			
SETTING COPY MODE	CPMD	WR	0	0	Copy to all monitors.	○	○	○
			1-225	1-225	Copy to the monitor with the set ID Number.			
SETTING COPY TARGET	CPTG	WR	0	0	Copies the PICTURE menu settings.	○	○	○
			1	1	Copies all the settings.			
LOGO SCREEN	BTSC	WR	0-1	0-1	0: OFF, 1: ON			

Controlling the Monitor with a PC (RS-232C)

OPTION menu

Function	Command	Direction	Parameter	Reply	Control/Response contents	*1	*2 (A) (B)
DATE/TIME SETTING	DATE	WR	AABBCCDDEE	AABBCCDDEE	AA: Year, BB: Month, CC: Day, DD: Time, EE: Minute		
DATE DISPLAY FORMAT	DTFT	WR	0-2	0-2	0: YYYY/MM/DD, 1: MM/DD/YYYY, 2: DD/MM/YYYY YYYY: Year, MM: Month, DD: Day		
TIME DISPLAY FORMAT	TMFT	WR	0-1	0-1	0: 24-HOUR TIME, 1: 12-HOUR TIME		
SCHEDULE	SC01-SC08	WR	ABCDEFGHIJGH	ABCDEFGHIJGH	Schedule of a specified number A: Schedule 0 = Not effective, 1 = Effective B: Power 0 = OFF, 1 = ON C: Day of the week 1 0 = Only once, 1 = Every week, 2 = Every day D: Day of the week 2 0 = Sunday, 1 = Monday through 6 = Saturday, 9 = Not exist E: Day of the week 3 0 = Sunday, 1 = Monday through 6 = Saturday, 9 = Not exist F: Time 00-23 G: Minute 00-59 H: Input 0 = Not specified, 1 = PC DVI-D/AV DVI-D, 2 = PC D-SUB, 3 = PC RGB/AV COMPONENT, 4 = AV VIDEO, 5 = AV S-VIDEO, 6 = PC HDMI/AV HDMI "ERR" when LOW POWER is selected for STANDBY MODE.	○	○ ○
SCHEDULE BRIGHTNESS	SB01-SB08	WR	0-31 99	0-31 99	Screen brightness to change Disable brightness setting		
INPUT SELECT	DVI	DVSL	WR	0-1	0-1	0: PC DVI-D, 1: AV DVI-D	○ -
	BNC	BNSL	WR	0-1	0-1	0: PC RGB, 1: AV COMPONENT	○ -
	D-SUB	SLDS	WR	0-2	0-2	0: PC D-SUB, 1: AV COMPONENT, 2: AV VIDEO	○ ○
	HDMI	HDSL	WR	0-1	0-1	0: PC HDMI, 1: AV HDMI	○ ○
AUDIO SELECT	PC DVI-D	ASDP	WR	1-3	1-3	1: AUDIO(STEREO MINI), 2: AUDIO1(RCA), 3: AUDIO2(RCA)	-
	PC HDMI	ASHP	WR	0-1	0-1	0: HDMI, 1: AUDIO(STEREO MINI)	○
				2-3	2-3	2: AUDIO1(RCA), 3: AUDIO2(RCA)	-
	PC D-SUB	ASAP	WR	1-3	1-3	1: AUDIO(STEREO MINI) 2: AUDIO1(RCA), 3: AUDIO2(RCA)	○
	PC RGB	ASCP	WR	1-3	1-3	1: AUDIO(STEREO MINI), 2: AUDIO1(RCA), 3: AUDIO2(RCA)	-
	AV DVI-D	ASDA	WR	1-3	1-3	1: AUDIO(STEREO MINI), 2: AUDIO1(RCA), 3: AUDIO2(RCA)	- ○
	AV HDMI	ASHA	WR	0-1	0-1	0: HDMI, 1: AUDIO(STEREO MINI)	○ ○
				2-3	2-3	2: AUDIO1(RCA), 3: AUDIO2(RCA)	-
	AV COMPONENT (BNC)	ASCA	WR	1-3	1-3	1: AUDIO(STEREO MINI), 2: AUDIO1(RCA), 3: AUDIO2(RCA)	-
	AV COMPONENT (D-SUB)	ASC2	WR	1-3	1-3	1: AUDIO(STEREO MINI), 2: AUDIO1(RCA), 3: AUDIO2(RCA)	○
	AV S-VIDEO	ASSA	WR	1-3	1-3	1: AUDIO(STEREO MINI), 2: AUDIO1(RCA), 3: AUDIO2(RCA)	-
	AV VIDEO (BNC)	ASVA	WR	1-3	1-3	1: AUDIO(STEREO MINI), 2: AUDIO1(RCA), 3: AUDIO2(RCA)	-
AV VIDEO (D-SUB)	ASV2	WR	1-3	1-3	1: AUDIO(STEREO MINI), 2: AUDIO1(RCA), 3: AUDIO2(RCA)	○	
INPUT RESOLUTION (PC)	RESOLUTION CHECK	PXCK	R		-	Returns current resolution in the form of hhh, vvv.	
	PIXEL SETTING (PC D-SUB, PC RGB)	PXSL	WR	1	1	768) 1360 x 768	
				2	2	768) 1280 x 768	
				3	3	768) 1024 x 768	
				5	5	480) 848 x 480	
				6	6	480) 640 x 480	
				7	7	1050) 1680 x 1050	
				8	8	1050) 1400 x 1050	
				9	9	768) AUTO	○ ○
				10	10	480) AUTO	
INPUT RESOLUTION (AV)	RESOLUTION CHECK	RESO	R		-	480i, 480p, 1080i, 720p, 1080p, VGA, etc.	-
ZOOM2 SPECIAL SETTING (PC D-SUB, PC RGB)	Z2SP	WR	0-1	0-1	0: OFF, 1: ON	○	
SCAN MODE	SCAN	WR	0-2	0-2	0: MODE1, 1: MODE2, 2: MODE3 (When the input mode is AV)	○	
POWER MANAGEMENT (PC)	PMNG	WR	0-1	0-1	0: OFF, 1: ON	○	
POWER MANAGEMENT (AV)	PMAG	WR	0-1	0-1	0: OFF, 1: ON	○	
COLOR SYSTEM	CSYS	WR	0-5	0-5	0: AUTO, 1: PAL, 2: PAL-60, 3: SECAM, 4: NTSC3.58, 5: NTSC4.43	○ ○ ○	
AUDIO OUTPUT(RCA)	AOUT	WR	0-2	0-2	0: VARIABLE1, 1: FIXED, 2: VARIABLE2	○	
AUDIO LEVEL(STEREO MINI)	AIVP	WR	0-1	0-1	0: 1.0Vrms, 1: 0.5Vrms	○	
SELF ADJUST	AADJ	WR	0-1	0-1	0: OFF, 1: ON	○ ○ ○	
AUTO INPUT CHANGE	AINC	WR	0-1	0-1	0: OFF, 1: ON	○	
TOUCH PANEL MODE	GMDP	WR	0-1	0-1	0: OFF, 1: ON (When the input mode is PC)	○	

Controlling the Monitor with a PC (RS-232C)

PIP/PbyP menu

Function	Command	Direction	Parameter	Reply	Control/Response contents	*1	*2	
						(A)	(B)	
PIP MODES	MWIN	WR	0-3	0-3	0: OFF, 1: PIP, 2: PbyP, 3: PbyP2	○		
PIP SIZE	MPSZ	WR	1-64	1-64		○		
PIP POS	MHPS	W	0-100			○		
						R	0-100	
PIP POS	MVPS	W	0-100			○		
						R	0-100	
PIP POS LD+SD BATCH	MPOS	W	0-100,0-100		Specify the position in MPOSxxxxyy format. (xxx: Longer side, yyy: Shorter side position)	○		
		R		0-100,0-100	Returns a response in (xxx,yyy) format. (xxx: Longer side, yyy: Shorter side position)	○		
PIP BLEND	MWBL	WR	0-15	0-15		○		
PIP SOURCE	MWIP	WR	1	1	PC DVI-D		-	○
			2	2	PC D-SUB		○	○
			3	3	AV COMPONENT (BNC) / AV COMPONENT (D-SUB)		○	○
			4	4	AV VIDEO (BNC) / AV VIDEO (D-SUB)		○	○
			6	6	PC RGB	○	-	○
			7	7	AV DVI-D		-	○
			8	8	AV S-VIDEO		-	○
			9	9	AV HDMI		○	○
			10	10	PC HDMI		○	○
			SOUND CHANGE	MWAD	WR	1-2	1-2	1: MAIN, 2: SUB
MAIN POS (Main screen)	MWPP	WR	0-1	0-1	0: POS1, 1: POS2	○		
PbyP2 POS (Sub screen)	MW2P	WR	0-2	0-2	0: POS1, 1: POS2, 2: POS3	○		
AUTO OFF	MOFF	WR	0-1	0-1	0: MANUAL, 1: AUTO	○		

Initialization/Functional Restriction Setting (FUNCTION) menu

Function	Command	Direction	Parameter	Reply	Control/Response contents	*1	*2	
						(A)	(B)	
ALL RESET	RSET	W	0		0: ALL RESET	-	○	-
			0-1		0: ALL RESET 1, 1: ALL RESET 2	-	-	○
ADJUSTMENT LOCK	ALCK	WR	0-2	0-2	0: OFF, 1:ON1, 2:ON2	○		
ADJUSTMENT LOCK TARGET	ALTG	WR	0-2	0-2	0: REMOTE CONTROL, 1: MONITOR BUTTONS, 2: BOTH	○		
OSD DISPLAY	LOSD	WR	0-2	0-2	0: ON1, 1: OFF, 2: ON2	○		
LED	OFLD	WR	0-1	0-1	0: ON, 1: OFF "ERR" when LOW POWER is selected for STANDBY MODE.	○	○	○
TEMPERATURE ALERT	TALT	WR	0-2	0-2	0: OFF, 1: OSD & LED, 2: LED	○		
STATUS ALERT	SALT	WR	0-2	0-2	0: OFF, 1: OSD & LED, 2: LED	○		
POWER BUTTON	PBTN	WR	0-1	0-1	0: MONITOR, 1: CONTROLLER	○		
CONTROLLER INPUT	PCIP	WR	0-2	0-2	0: D-SUB, 1: HDMI ("ERR" when MONITOR is selected for POWER BUTTON.)	○	○	○
					2: DVI-D ("ERR" when MONITOR is selected for POWER BUTTON.)	○	-	○

Controlling the Monitor with a PC (RS-232C)

Others

Function	Command	Direction	Parameter	Reply	Control/Response contents	*1	*2	
						(A)	(B)	
SCREEN SIZE (PC)	WIDE	WR	1-5	1-5	1: WIDE, 2: NORMAL, 3: Dot by Dot, 4: ZOOM1, 5: ZOOM2	○		
SCREEN SIZE (AV)	WIDE	WR	1-5	1-5	1: WIDE, 2: ZOOM1, 3: ZOOM2, 4: NORMAL, 5: Dot by Dot	○		
VOLUME	VOLM	WR	0-31	0-31		○		
MUTE	MUTE	WR	0-1	0-1	0: OFF, 1: ON	-		
INFORMATION	MODEL	INF1		Value		●		
	SERIAL NO	SRNO		Value				
BRIGHT	VLMP	WR	0-31	0-31		○		
TEMPERATURE SENSOR	DSTA	R		0	Internal temperature normal			
				1	Internal temperature abnormal (Standby mode)			
				2	Internal temperature abnormal (Temperature is normal now, but it was abnormal during operation.)	●		
				3	Internal temperature abnormal (Brightness of the backlight decreases.)			
				4	Temperature sensor abnormal		○	○
TEMPERATURE ACQUISITION	ERRT	R		Value	Temperature at temperature sensors 1 through 3 are returned in the following forms: [Sensor 1], [Sensor 2], [Sensor 3] Indicates a temperature sensor abnormality when "126" is returned.	○		
CAUSE OF LAST STANDBY MODE	STCA	W	0		Initialization			
		R	0	No detectable error has occurred				
			1	Standby mode by POWER button				
			2	Main power off by the main power switch				
			3	Standby mode by RS-232C or LAN	●			
			4	Waiting mode by No Signal				
			6	Standby mode by abnormal temperature				
			8	Standby mode by SCHEDULE setting				
			20	Standby mode by OFF IF NO OPERATION setting				

Commands for setting of the GAMMA user data

Function	Command	Direction	Parameter	Reply	Control/Response contents	*1	*2	
						(A)	(B)	
RED GAMMA DATA TRANSFER	UGRW	W	aa: 01-16		aa: Block number			
GREEN GAMMA DATA TRANSFER	UGGW	W	cc: 00-FF		xxxx: 32 pieces of user data			
BLUE GAMMA DATA TRANSFER	UGBW	W			cc: Checksum (ASCII data) of the block number and user data			
RED GAMMA DATA READ	UGRR	W	1-16	xxxx ... xxxx	xxxx: User data of 32 pieces	○	○	○
GREEN GAMMA DATA READ	UGGR	W	1-16	(xxxx: 32 pieces)				
BLUE GAMMA DATA READ	UGBR	W	1-16	xxxx: 0000-1023				
USER DATA INITIALIZE	UGRS	W	0		Initialize the user data.			
USER DATA SAVE	UGSV	W	0		Save the user data in the monitor.			

Controlling the Monitor with a PC (LAN)

When the PN-ZB01 (optional) is attached, your monitor can be connected to a LAN allowing you to control it from a PC on the LAN.

You can also configure the monitor to send e-mail notification when it has a problem.

The connection requires a commercially available LAN cable (UTP cable, Category 5, straight through).

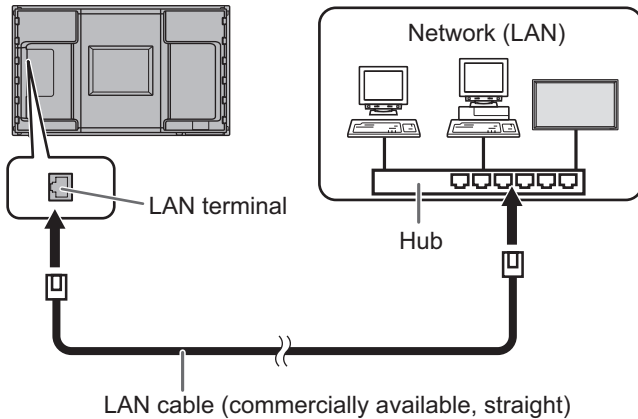

TIPS

- You must assign an IP address to the monitor by following the procedures in “Settings to connect to a LAN”. (See the description on the right.)
- Your PC must be installed with Internet Explorer (version 7.0 or later).
- To control the monitor via LAN, set RS-232C/LAN SELECT to LAN. (See page 26.)
- You cannot use RS-232C and LAN control simultaneously.

Initializing personal information

- When the PN-ZB01 (optional) is attached, personal information such as e-mail addresses can be registered in the monitor. Before transferring or disposing of the monitor, initialize all settings by selecting ALL RESET 1. (See page 31.) Note that ALL RESET 2 will not initialize e-mail addresses and other settings.

Settings to connect to a LAN

Set the monitor's IP address and subnet mask to match the settings of your LAN.

These settings can be made on either the monitor or a PC connected to the monitor.

The settings depend on the configuration of your LAN. Ask your LAN administrator for details.

■ To set on the monitor

Set RS-232C/LAN SELECT on the SETUP menu to LAN, and then set the LAN SETUP options. (See page 26.)

After setting each item, select SET and press .

DHCP CLIENT

If your LAN has a DHCP server and you wish to obtain an address automatically, change this setting to ON.

To set the address manually, set this to OFF.

IP ADDRESS

If the DHCP CLIENT is set to OFF, specify an IP address.

Press or to select items, and press or to change the values.

SUBNET MASK

If the DHCP CLIENT is set to OFF, specify the subnet mask.

Press or to select items, and press or to change the values.

DEFAULT GATEWAY

If the DHCP CLIENT is set to OFF, specify the default gateway.

If you are not using a gateway, specify “0.0.0.0”.

Press or to select items, and press or to change the values.

RESET

Resets the values of the LAN settings to the factory preset values.

Select ON and then press .

TIPS

- When the IP address is set manually, the IP addresses of the monitor connected to the RS-232C output terminal and the daisy chain of connected monitors that follows can be assigned automatically. (See page 26.)

Controlling the Monitor with a PC (LAN)

■ To set from a PC

When the monitor is connected to a PC, LAN settings can be configured via PC.

Set up process

- (1) Connect your monitor to a PC
- (2) Specify the PC's IP address
- (3) Configure the monitor's LAN settings

(1) Connecting your monitor to a PC

Connect a commercially available crossover LAN cable (UPT cable, Category 5) to the LAN port on the PC and this monitor.

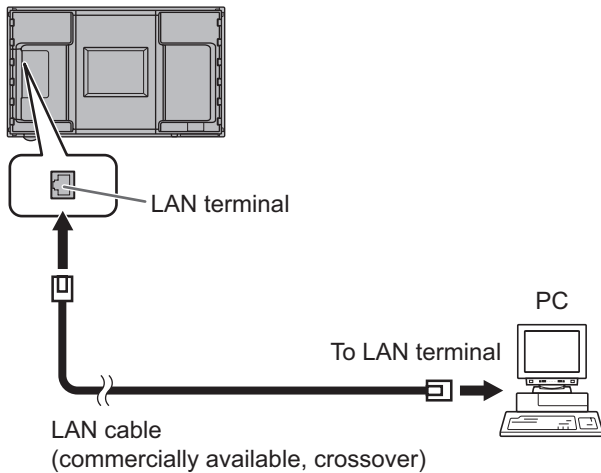

(2) Specifying the PC's IP address

To configure the monitor's LAN settings, you must temporarily change the settings on the PC.

This explanation is based on Windows 7.

1. Log on to the PC with an administrator account.
2. Click [Start], and then click "Control Panel".
3. Click "View network status and tasks" in "Network and Internet".
In "Classic View", click "Network and Sharing Center".
4. Click "Local Area Connection" and then "Properties".
5. Click "Internet Protocol Version 4 (TCP/IPv4)" and then "Properties".
6. Make a note of the current IP address, subnet mask, and default gateway settings.
Make sure you write this information now as you will be changing the IP address, subnet mask, and default gateway settings back to these settings afterwards.

7. Temporarily change the IP address and subnet mask.
To access the monitor as it is shipped from the factory, set as follows.

- IP Address: 192.168.150.1
- Subnet Mask: 255.255.255.0
- Default Gateway: (leave blank)

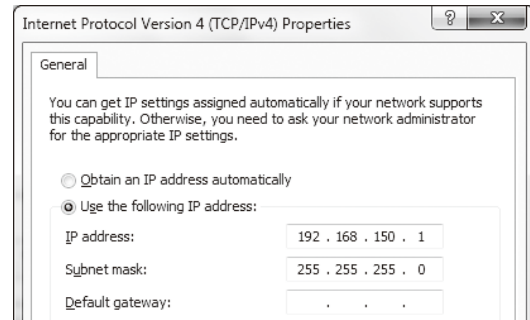

8. Click [OK] and then reboot the PC.

TIPS

- This monitor is factory preset as shown below.
(When DHCP CLIENT is set to OFF)
IP Address : 192.168.150.2
Subnet Mask : 255.255.255.0
Default Gateway : 0.0.0.0

(3) Configuring the monitor's LAN settings

Access the monitor using Internet Explorer.

Controlling the monitor

1. Turn the power ON to the monitor.
2. Set RS-232C/LAN SELECT on the SETUP menu to LAN.
3. Set DHCP CLIENT to OFF in LAN SETUP on the SETUP menu.

PC operation

4. Launch Internet Explorer, in the "Address" box type "http://192.168.150.2/" and press the Enter key.



- You will be prompted to enter a user name and password.
5. Leave the user name and password boxes blank and click [OK].

6. Click on "LAN SETUP" under NETWORK.

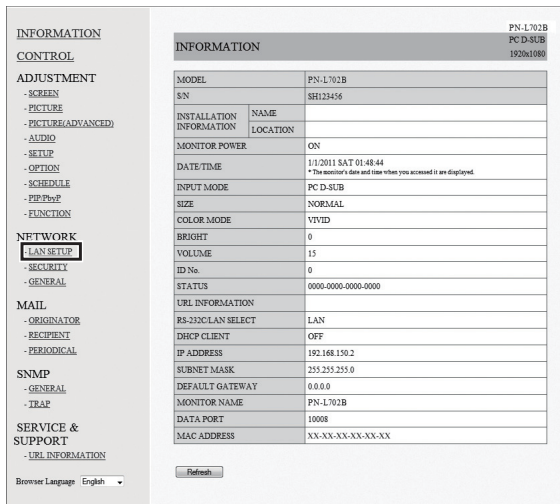

7. Specify the "DHCP CLIENT", "IP ADDRESS", etc.

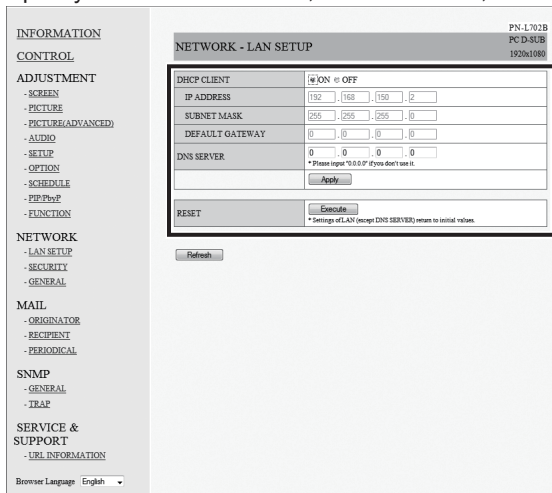

DHCP CLIENT

If your LAN has a DHCP server and you wish to obtain an address automatically, change this setting to "ON". To set the address manually, set this to "OFF".

IP ADDRESS

If the DHCP CLIENT is set to "OFF", specify an IP address.

SUBNET MASK

If the DHCP CLIENT is set to "OFF", specify the subnet mask.

DEFAULT GATEWAY

If the DHCP CLIENT is set to "OFF", specify the default gateway. If you are not using a default gateway, specify "0.0.0.0".

8. When the setting is changed, click [Apply].
9. Check the message and click [OK].
10. Exit Internet Explorer.
11. Restore the PC's IP address jotted in Step 6, "(2) Specifying the PC's IP address".
12. Connect the monitor and the PC to the LAN.

! Caution

- Wait 10 seconds after clicking [OK] before proceeding.
- When operating using the remote control unit or similar, click [Refresh].

TIPS

- When the IP address is set manually, the IP addresses of the monitor connected to the RS-232C output terminal and the daisy chain of connected monitors that follows can be assigned automatically. (See page 26.)

Controlling with a PC

■ Basic operation

You use Internet Explorer on a PC on the LAN to control the monitor.

1. Launch Internet Explorer on the PC.
2. In the "Address" box, type "http://" followed by your monitor's IP address followed by "/", then press the Enter key. You can confirm the IP address with the DISPLAY function.



When prompted to enter a user name and password, type the user name and password that you specified in the security settings (see page 47), and click [OK].

If you did not make any security settings, leave the spaces blank and click on [OK].

3. You can check, control, and change the monitor's status and settings by clicking the menu items on the left side of the screen.

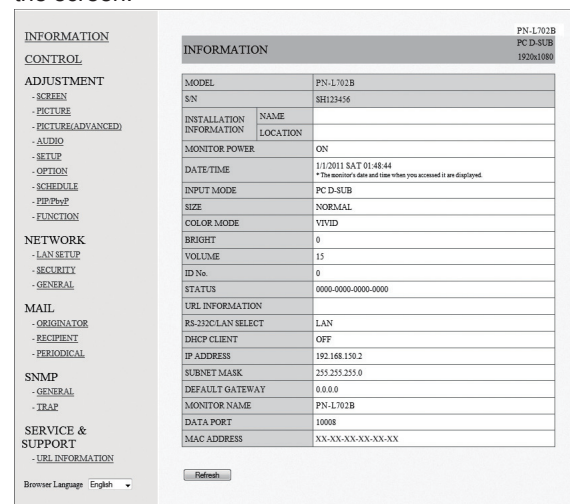

- If you see an [Apply] button next to a setting, click it after you change that setting.

TIPS

- See pages 46 to 50 for details on each setting.
- If you click [Refresh] before the screen finishes updating the current display, the "Server Busy Error" will appear. Wait for a moment before operating your monitor again.
- You cannot operate the monitor while it is warming up.
- If "DHCP CLIENT" is set to "ON", press  on the remote control unit two times and then check the monitor's IP address.

Controlling the Monitor with a PC (LAN)

■ INFORMATION

Information about this monitor appears.

INFORMATION		PN-L702B PC D-SUB 1920x1080
INFORMATION		
MODEL	PN-L702B	
S/N	SH123456	
INSTALLATION INFORMATION		
NAME		
LOCATION		
MONITOR POWER	ON	
DATE/TIME	11/2011 SAT 01:48:44 <small>*The monitor's date and time when you accessed it are displayed.</small>	
INPUT MODE	PC D-SUB	
SIZE	NORMAL	
COLOR MODE	VIVID	
BRIGHT	0	
VOLUME	15	
ID No.	0	
STATUS	0000-0000-0000-0000	
URL INFORMATION		
RS-232C/LAN SELECT	LAN	
DHCP CLIENT	OFF	
IP ADDRESS	192.168.150.2	
SUBNET MASK	255.255.255.0	
DEFAULT GATEWAY	0.0.0.0	
MONITOR NAME	PN-L702B	
DATA PORT	10008	
MAC ADDRESS	XX-XX-XX-XX-XX-XX	
<input type="button" value="Refresh"/>		

■ CONTROL

You can control the operations corresponding to the buttons (POWER INPUT SIZE) on the remote control unit. (See page 21.)

CONTROL		PN-L702B PC D-SUB 1920x1080
CONTROL		
MONITOR POWER	<input checked="" type="radio"/> ON <input type="radio"/> OFF	
INPUT MODE	PC D-SUB	
SIZE	NORMAL	
COLOR MODE	VIVID	
BRIGHT	0	
VOLUME	15	
MUTE	<input type="radio"/> ON <input checked="" type="radio"/> OFF	
<input type="button" value="Refresh"/>		
<small>* Please click [Refresh] button to check the setting of each item after you change it.</small>		

■ ADJUSTMENT

You can adjust these settings which are also available on the monitor's menu.

- SCREEN (See page 24.)
- PICTURE (See page 24.)
- PICTURE (ADVANCED) (See page 30.)
- AUDIO (See page 25.)
- SETUP (See page 25.)
- OPTION (See page 26.)
- SCHEDULE (See page 29.)
- PIP/PbyP (See page 27.)
- FUNCTION (See page 31.)

ADJUSTMENT - SCREEN		PN-L702B PC D-SUB 1920x1080
ADJUSTMENT - SCREEN		
AUTO	<input type="button" value="Execute"/>	
CLOCK	620	
PHASE	63	
H.POS	592	
V.POS	37	
H.SIZE	50	
V.SIZE	50	
H.RESOLUTION	1920	
V.RESOLUTION	1080	
<input type="button" value="Execute"/>		
<small>* Settings of the SCREEN adjustment return to initial values.</small>		
<input type="button" value="Refresh"/>		
<small>* Please click [Refresh] button to check the setting of each item after you change it.</small>		

TIPS

- After changing DISPLAY COLOR PATTERN to OFF, click [Refresh] to correctly retrieve the status of the monitor.

TIPS

- In standby mode, Power ON is the operation available.

■ NETWORK (LAN SETUP)

This screen allows you to set the settings necessary when the monitor is connected to a LAN.

PN-L701B
PC D-SUB
1920x1080

NETWORK - LAN SETUP

DHCP CLIENT: ON OFF

IP ADDRESS: 192 . 168 . 150 . 2

SUBNET MASK: 255 . 255 . 255 . 0

DEFAULT GATEWAY: 0 . 0 . 0 . 0

DNS SERVER: 0 . 0 . 0 . 0
* Please input "0.0.0.0" if you don't use it.

RESET: * Settings of LAN (except DNS SERVER) return to initial values.

Browser Language: English

DHCP CLIENT

If your LAN has a DHCP server and you wish to obtain an address automatically, change this setting to "ON". To set the address manually, set this to "OFF".

IP ADDRESS

If the DHCP CLIENT is set to "OFF", specify an IP address.

SUBNET MASK

If the DHCP CLIENT is set to "OFF", specify the subnet mask.

DEFAULT GATEWAY

If the DHCP CLIENT is set to "OFF", specify the default gateway.
If you are not using a default gateway, specify "0.0.0.0".

DNS SERVER

Specify the DNS server address.
If you are not using a DNS server, specify "0.0.0.0".

RESET

Clicking [Execute] returns all of the LAN SETUP settings to the factory-preset values except for the DNS SERVER setting.

TIPS

- When the IP address is set manually, the IP addresses of the monitor connected to the RS-232C output terminal and the daisy chain of connected monitors that follows can be assigned automatically. (See page 26.)

■ NETWORK (SECURITY)

This screen allows you to specify the security-related settings.

PN-L701B
PC D-SUB
1920x1080

NETWORK - SECURITY

USER NAME: *MAX 8 characters

PASSWORD: *MAX 8 characters

PASSWORD(CONFIRMATION): * Please input the same password once again.

* This user name / password is for accessing via Web browser and Telnet.

ACCEPT IP ADDRESS: All IP Addresses From only specific IP addresses

IP ADDRESS 1: 0 . 0 . 0 . 0 * Please input "0.0.0.0" if you don't use it.

IP ADDRESS 2: 0 . 0 . 0 . 0 * Please input "0.0.0.0" if you don't use it.

IP ADDRESS 3: 0 . 0 . 0 . 0 * Please input "0.0.0.0" if you don't use it.

Browser Language: English

USER NAME / PASSWORD

Sets up a user name and password to restrict access to this monitor.

After entering a user name and password, click [Apply].

ACCEPT IP ADDRESS

You can limit access to this monitor by registering IP addresses of PCs that should have access.

To limit access, specify the option "From only specific IP addresses". Otherwise, to allow access from any PC, specify "All IP Addresses".

IP ADDRESS 1 to 3

If "ACCEPT IP ADDRESS" is set to "From only specific IP addresses", enter the IP addresses that you want to allow.

TIPS

- The USER NAME and PASSWORD can be up to 8 alphanumeric characters or symbols.
- To cancel the user name and/or password after it has been set, make the box empty and click [Apply].

Controlling the Monitor with a PC (LAN)

■ NETWORK (GENERAL)

This screen allows you to specify the general LAN settings.

PNL702B
PC D-SUB
1920x1080

MONITOR NAME: PNL702B
*MAX 16 characters

AUTO LOGOUT TIME: 0 minutes
* From 1 to 65535
If you set 0, the function is disabled.

DATA PORT: 1008
* From 1025 to 65535

SEARCH PORT: 5008
* From 1025 to 65535

INSTALLATION INFORMATION
NAME: *MAX 50 characters
LOCATION: *MAX 100 characters

Apply Refresh

MONITOR NAME

Specify a name for this monitor as it should appear on the Internet Explorer screen.

AUTO LOGOUT TIME

Specify the time (in minutes) to elapse before automatically disconnecting this monitor from the network.
Specify in minutes from 1 to 65535. A value of '0' will disable this function.

DATA PORT

Specify the TCP port number to use for exchanging data with the monitor.
Specify a value from 1025 to 65535.

SEARCH PORT

Specify the port number to use when searching for this monitor.
Specify a value from 1025 to 65535.

INSTALLATION INFORMATION (NAME/LOCATION)

Specify the information to display for this monitor in the Internet Explorer window.

TIPS

- The MONITOR NAME can be up to 16 alphanumeric characters or symbols.
- Enter up to 50 characters in the NAME field in the INSTALLATION INFORMATION.
- Enter up to 100 characters in the LOCATION field in the INSTALLATION INFORMATION.

■ MAIL (ORIGINATOR)

This screen allows you to configure the e-mail sent periodically or when the monitor has an error.
The settings depend on the configuration of your LAN. Ask your LAN administrator for details.

PNL702B
PC D-SUB
1920x1080

SMTP SERVER: *MAX 64 characters

ORIGINATOR E-MAIL ADDRESS: *MAX 64 characters

ORIGINATOR NAME: *MAX 64 characters

AUTHENTICATION: NONE POP before SMTP

POP SERVER: No need the setting. *MAX 64 characters

ACCOUNT NAME: No need the setting. *MAX 64 characters

PASSWORD: *MAX 64 characters

Apply Refresh

SMTP SERVER

Specify the SMTP server address for sending e-mail.
* When using a domain name, make sure to specify the DNS server as well. (See page 47.)

ORIGINATOR E-MAIL ADDRESS

Specify the e-mail address for this monitor.
This address becomes the e-mail address of the originator.

ORIGINATOR NAME

Specify the name for the originator.
This name appears in the "Originator Name" field of the e-mail.

AUTHENTICATION

Specify the authentication method to use when sending e-mail.

POP SERVER

If the "AUTHENTICATION" method is "POP before SMTP", specify the POP server address.

ACCOUNT NAME / PASSWORD

If the "AUTHENTICATION" method is "POP before SMTP", specify the account name and password to connect to the POP server.

TIPS

- You can enter up to 64 alphanumeric characters or symbols for the ORIGINATOR E-MAIL ADDRESS, ORIGINATOR NAME, ACCOUNT NAME, and PASSWORD.
- The SMTP SERVER and POP SERVER can be up to 64 characters.
The following characters can be used: a-z, A-Z, 0-9, - , .

MAIL (RECIPIENT)

This screen allows you to specify the recipients of the e-mail sent periodically or when the monitor has an error.

PN-L702B
PC D-SUB
1920x1080

MAIL - RECIPIENT

No.	RECIPIENT E-MAIL ADDRESSES <small>*Add 64 characters</small>	CONDITION			CONFIRMATION
		PERIODICAL	TEMPERATURE	HARDWARE	
1		<input type="checkbox"/>	<input type="checkbox"/>	<input type="checkbox"/>	<input type="button" value="Test"/>
2		<input type="checkbox"/>	<input type="checkbox"/>	<input type="checkbox"/>	<input type="button" value="Test"/>
3		<input type="checkbox"/>	<input type="checkbox"/>	<input type="checkbox"/>	<input type="button" value="Test"/>

Attach the log file to a TEMPERATURE/HARDWARE error e-mail.
* attach no log file to a PERIODICAL report e-mail.

RECIPIENT E-MAIL ADDRESSES

Specify the e-mail addresses to send error notification e-mail to.

CONDITION

Specify the conditions to send mails.
When you check PERIODICAL, specify the date and time to send the mails in the PERIODICAL setting.

CONFIRMATION

Sends test e-mail.
This allows you to confirm that the e-mail settings are configured properly.

Attach the log file to a TEMPERATURE/HARDWARE error e-mail.

When this option is checked, a log is added to the mail which notifies a temperature or status error.

TIPS

- The RECIPIENT E-MAIL ADDRESSES can be up to 64 alphanumeric characters or symbols.

MAIL (PERIODICAL)

When PERIODICAL for CONDITION of MAIL (RECIPIENT) is checked, set the date and time to send the mail.

PN-L702B
PC D-SUB
1920x1080

MAIL - PERIODICAL

DAY OF THE WEEK: SUN MON TUE WED THU FRI SAT
* Please check the day of the week sending e-mail.

TIME: 1. --:--:--
2. --:--:--
3. --:--:--
4. --:--:--
* Time sending an e-mail.

DAY OF THE WEEK

Specify the day of the week to send the periodical mails.

TIME

Specify the time of the day to send the periodical mails.

! Caution

- Do not turn off the main power when you set to send the periodical mails.
- Specify the correct date and time. (See page 26.)
If the date and time settings are incorrect, the periodical mail is not sent properly.
- Regularly confirm that the specified date and time is correct.
- When LOW POWER is selected for STANDBY MODE, periodical mails will not be sent in standby mode.

Controlling the Monitor with a PC (LAN)

■ SNMP

You can configure settings related to SNMP.

SNMP SETTING

Set whether to enable or disable SNMP.

VERSION

Set the version of the SNMP to be supported.

COMMUNITY NAME 1 to 3

Set the name of the community required for the access.

USER 1 to 3

Set the user name, password, authentication method and other options required for access.

TRAP SETTING

Set whether to enable or disable the trap function. When this function is enabled, a trap will be sent when the monitor is turned on.

TRAP SETTING OF AUTHENTICATION ERROR

Set whether the trap function sends a notification when authentication fails.

TRAP ADDRESS & PORT

Set the destination address and port number of the notification sent by the trap function.

! Caution

- After you set SNMP, click [Switch the main power of monitor off and on now.] or turn off the monitor and then turn it on again with the main power switch. When the monitor restarts, wait about 30 seconds and then start the next operation.
- If the IP address is changed while the SNMP function is operational, turn off the monitor and then turn it on again with the main power switch.

TIPS

- Depending on the SNMP settings, a short delay may occur before the SNMP is usable. (About 2 minutes)
- Up to 16 alphanumeric letters and symbols can be used for the community name, user name and password.

■ SERVICE & SUPPORT (URL INFORMATION)

You can display a specific URL in the URL INFORMATION field on the INFORMATION screen when an error occurs in the monitor. (See page 46.)

URL INFORMATION

Enter the URL to display on the INFORMATION screen when an error occurs on the monitor.

Up to 64 alphanumeric characters or symbols can be used.

CONDITION

Specify the condition to display the URL.

CONFIRMATION

The home page of the specified URL is displayed.

You can check whether the URL you entered is correct.

TIPS

- It is also possible to specify the message text, such as the name of a contact or a telephone number, to be displayed instead of the linked URL.

Troubleshooting

If you are experiencing any problem with your display, before calling for service, please review the following troubleshooting tips.

There is no picture or sound.

- Is the power cord disconnected? (See page 14.)
- Is the main power switch off? (See page 16.)
- Is the monitor in standby mode (the power LED illuminating in orange)? (See page 16.)
- Make sure correct input mode is selected. (See page 21.)
- If any external equipment is connected, make sure the equipment is operating (playing back).

Remote control does not work.

- Are the batteries inserted with polarity (+,-) aligned? (See page 15.)
- Are the batteries exhausted?
- Point the remote control unit toward the monitor's remote control sensor. (See page 15.)
- Is the menu display hidden or is operation disabled? (See page 31.)

Sound from left and right speakers is reversed.

Sound is heard from only one side.

- Are audio cables connected properly? (See pages 12 to 13.)
- Make sure audio cables for external speakers are connected properly: left and right cables may be reversed or one of the two cables may not be connected. (See page 13.)
- Check the setting of BALANCE for AUDIO menu. (See page 25.)

There is a picture but no sound.

- Is the sound muted?
- Make sure the volume is not set to minimum.
- Are audio cables connected properly?
- Is the setting of AUDIO SELECT on the OPTION menu correct? (See page 26.)
- Is the setting of SPEAKER SELECT on the SETUP menu correct? (See page 26.)

Unstable video.

- The signal may be incompatible.
- Try the automatic screen adjustment when the PC D-sub input terminal or PC RGB input terminals are used.
- If the top and bottom of the image are not horizontally aligned, set TOUCH PANEL MODE on the OPTION menu to OFF.

The video from the PC/AV HDMI input terminal does not appear properly.

- Is the setting for HDMI of INPUT SELECT on the OPTION menu correct? (See page 26.)
- Is the HDMI cable HDMI standard compliant? The monitor will not work with cables that are not standard compliant.
- Is the input signal compatible with this monitor? (See page 55.)

The video from the PC/AV DVI-D input terminal does not appear properly.

- Is the setting for DVI of INPUT SELECT on the OPTION menu correct? (See page 26.)
- Is the input signal compatible with this monitor? (See page 55.)
- Turn off the power to the connected equipment and then turn the power on again.
- If the monitors are connected in a daisy chain, turn off the power to all the monitors connected in a daisy chain and then turn the power on again.

The video from PC D-SUB, PC RGB, AV COMPONENT, or AV VIDEO does not appear correctly.

- Is the setting for BNC or D-SUB of INPUT SELECT on the OPTION menu correct? (See page 26.)
- Is the input signal compatible with this monitor? (See page 55.)

Control buttons do not work.

There is no picture.

- Load noises from outside may be interfering with normal operation. Turn off the power and turn it on after waiting at least 5 seconds, and then check the operation.

The input mode changes automatically.

- When the AUTO INPUT CHANGE is ON and no signal is present in a selected input mode, the AUTO INPUT CHANGE automatically changes the selected mode to a mode where a video signal is present.
The input mode may change in the following cases:
 - When a computer is in standby mode.
 - When video play is stopped with a playback device.

The touch panel does not respond.

- Is the USB cable connected properly? (Touch Panel Driver Operation Manual)
- Has the touch panel driver been installed? (Touch Panel Driver Operation Manual)
- Has the pen tip of the touch pen become worn? Replace the pen tip. (See page 20.)
- Is the battery inserted in the wrong orientation (+, -) in the touch pen? (See page 18.)
- Is the touch pen battery exhausted?

The response of the touch screen is slow.

Some parts of the screen do not respond.

- Is the screen exposed to direct sunlight or other strong light? The touch panel uses infrared rays and thus may not operate correctly.
- Is there an obstacle between the infrared transmitter/receiver and the touch pen or your finger? An obstacle will prevent correct operation. If your fingers or a sleeve are too close to the screen, correct operation will not be possible.
- Is the infrared transmitter/receiver dirty? Gently wipe off any dirt with a soft cloth.
- If the touch panel is touched with a small tip less than about 3/16 inch (4 mm) x 3/16 inch (4 mm), the touch may not be detected by infrared and correct operation will not take place.
- When starting your computer or connecting the USB cable, do not touch the touch panel. If you touch the touch panel, this may be detected as an element failure in the infrared transmitter/receiver and incorrect operation will result.

Power LED flashes red.

“STATUS [xxxx]” appears in the corner of the screen.



- Hardware has a problem. Turn off the monitor and request repair from your SHARP dealer.
(When STATUS ALERT is set to OSD & LED. This varies depending on the setting.)

The touch panel power LED lights red.

- Hardware has a problem. Turn off the monitor and request repair from your SHARP dealer.

Troubleshooting

When "AUTO DIMMING" is displayed.

- When the internal temperature of the monitor rises excessively, the brightness of the backlight automatically decreases in order to prevent a further temperature rise. If you attempt to use   to adjust the brightness while the monitor is in this state, "AUTO DIMMING" is displayed and you cannot change the brightness.
- Remove the cause of the excessive temperature rise.

The monitor makes a cracking sound.

- You may occasionally hear a cracking sound from the monitor. This happens when the cabinet slightly expands and contracts according to change in temperature. This does not affect the monitor's performance.

The Power LED is flashing in red and green alternately.

When "TEMPERATURE" is displayed in the corner of the screen.

- When the internal temperature of the monitor rises excessively, the brightness of the backlight decreases automatically in order to prevent high-temperature-related problems. When this occurs, "TEMPERATURE" is displayed on the screen and the Power LED flashes red and green alternately. (When TEMPERATURE ALERT is set to OSD & LED. This varies depending on the setting.)
- If the internal temperature rises further, the monitor automatically enters standby mode. (The Power LED continues flashing red and green alternately.)
- Remove the cause of the excessive temperature rise.
 - If the monitor enters standby mode due to a rise in temperature, to return to normal display, turn the power switch off and then back on again. The monitor, however, will enter standby mode again if the cause of the temperature rise is not eliminated. (See page 8.)
 - Check whether the monitor is placed at a location where a quick rise in temperature is likely. Internal temperature rises quickly if the vents on the monitor are blocked.
 - Internal temperature rises quickly if dust accumulates inside the monitor or around the vents. Remove dust if possible. Ask SHARP dealer about removing internal dust.

Specifications

■Product Specifications

Model		PN-L702B	
LCD component		70" Class [69-1/2 inch (176.6cm) diagonal] TFT LCD	
Max. resolution	(pixels)	1920 x 1080	
Max. colors		Approx. 1.06 billion colors	
Pixel pitch		0.802 mm (H) × 0.802 mm (V)	
Viewing angle		160° right/left/up/down (contrast ratio ≥ 10)	
Screen active area		inch (mm) 60-9/16 x 34-1/16 (1538.9 x 865.6)	
Computer input signal		Digital (DVI 1.0 standard-compliant), Analog RGB (0.7 Vp-p) [75 Ω]	
Sync signal		Horizontal/vertical separate (TTL: positive/negative), Sync-on-green, Composite sync (TTL: positive/negative)	
Video color system		NTSC (3.58MHz)/NTSC (4.43MHz)/PAL/PAL-60/SECAM	
Plug and play		VESA DDC2B	
Power management		VESA DPMS, DVI DMPM	
Input terminals	PC/AV	Digital	HDMI x 1
	PC	Analog	Mini D-sub 15 pin, 3 rows x 1
	Audio		3.5 mm mini stereo jack x 1
	Serial (RS-232C)		D-sub 9 pin x 1
When PN-ZB01 (optional) is attached	PC/AV	Digital	DVI-D 24 pin (HDCP compatible) x 1
	PC	Analog	BNC *1*2 x 1
	AV	Composite video	BNC x 1
		S-video	x 1
	Component	BNC (Y, Cb/Pb, Cr/Pr) *1 x 1	
Audio		RCA pin (L/R) x 2	
Output terminals	Audio		RCA pin (L/R) x 1
	Serial (RS-232C)		D-sub 9 pin x 1
When PN-ZB01 (optional) is attached	PC/AV	Digital	DVI-D 24 pin x 1
	External speaker		7 W + 7 W [6 Ω]
LAN terminal [When PN-ZB01 (optional) is attached]		10 BASE-T/100 BASE-TX	
Speaker output		7 W + 7 W	
Touch Panel	Detection method		Infrared blocking detection method
	Detection area	inch (mm)	60-9/16 x 34-1/16 (1538.9 x 865.6)
	PC connector		USB (1.1 compliant)
	Power supply		Supplied from USB
	Touch pen		Ultrasonic communication method
Power requirement		AC 100 V - 240 V, 2.8 A, 50/60 Hz	
Operating temperature *3*4		41°F to 95°F (5°C to 35°C)	
Operating humidity*4		20% to 80% (no condensation)	
Power consumption (Maximum / input signal waiting mode *5 / standby mode *6)		235 W / 1.0 W / 1.0 W	
Power consumption [When PN-ZB01 (optional) is attached]		240 W	
Dimensions (excluding protrusions)		inch (mm) Approx. 64-7/8 (W) x 4-9/16 (D) x 38-11/16 (H) (1,648 x 116 x 982)	
Weight		lbs. (kg) Approx. 154.3 (70)	
Weight [PN-ZB01 (optional)]		lbs. (kg) Approx. 1.102 (0.5)	

*1 Cannot be used simultaneously.

*2 Does not support plug and play.

*3 Temperature condition may change when using the monitor together with the optional equipments recommended by SHARP. In such cases, please check the temperature condition specified by the optional equipments.

*4 In addition, check the requirements of the computer and other devices to be connected, and make sure that all requirements are satisfied.

*5 When AUTO INPUT CHANGE is set to OFF.

*6 When STANDBY MODE is set to STANDARD. When STANDBY MODE is set to LOW POWER: 0.5 W

As a part of our policy of continuous improvement, SHARP reserves the right to make design and specification changes for product improvement without prior notice. The performance specification figures indicated are nominal values of production units. There may be some deviations from these values in individual units.

Specifications

■ Dimensional Drawings

Note that the values shown are approximate values.

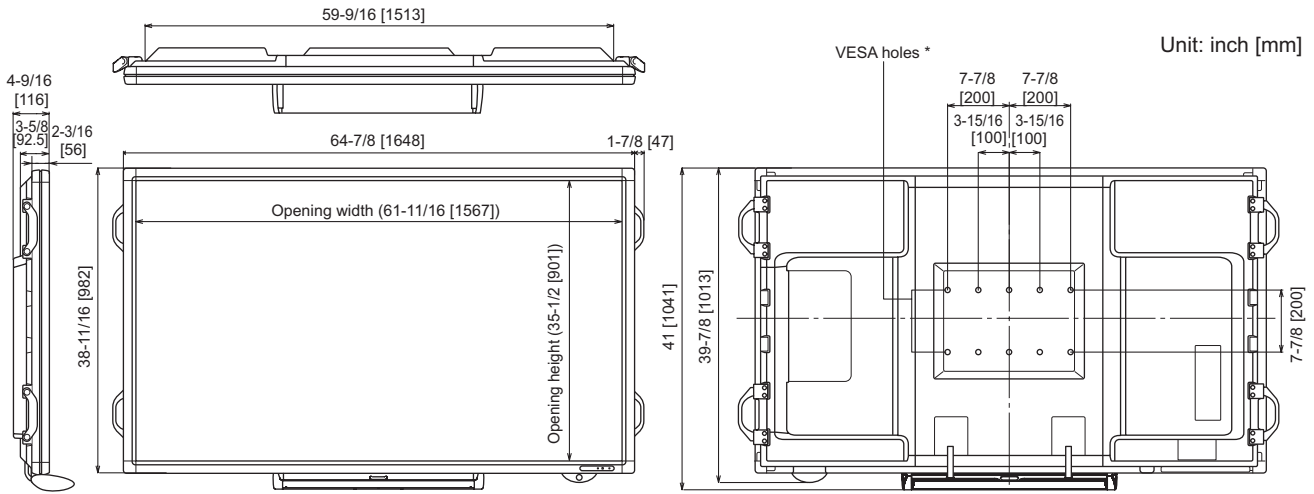

When mounting the monitor, be sure to use a wall-mount bracket that complies with the VESA-compatible mounting method. SHARP recommends using M6 screws and tighten the screws. Note that screw hole depth of the monitor is 3/8 inch (10 mm). Loose mounting may cause the product to fall, resulting in serious personal injuries as well as damage to the product. The screw and hole should come together with over 5/16 inch (8 mm) length of thread. Use a bracket which has been approved for UL1678 standard, and which can endure at least 4 times or more the weight of the monitor.

■ Power management

This monitor conforms to VESA DPMS and DVI DMPM. Both your video card and computer must support the same standard in order for the monitor's power management function to work.

DPMS: Display Power Management Signaling

DPMS	Screen	Power consumption	Hsync	Vsync
ON STATE	Display	235 W*1	Yes	Yes
STANDBY	No display	1.0 W*1*2	No	Yes
SUSPEND			Yes	No
OFF STATE			No	No

*1 When PN-ZB01 (optional) is not connected.
 *2 When AUTO INPUT CHANGE is set to OFF.

DMPM: Digital Monitor Power Management

DMPM	Screen	Power consumption
Monitor ON	Display	235 W*1
Active OFF	No display	1.0 W*1*2

■ DDC (plug and play)

The monitor supports the VESA DDC (Display Data Channel) standard. DDC is a signal standard for plug and play between monitors and computers. Information about resolution and other parameters is exchanged between the two. This function can be used if the computer supports DDC and it has been configured to detect plug-and-play monitors. There are several types of DDC, depending on the communication method used. This monitor supports DDC2B.

■Compatible signal timing (PC)

Screen resolution		Hsync	Vsync	Dot frequency	Digital		Analog (D-SUB/RGB*2)
					DVI*2	HDMI	
VESA	640 × 480	31.5kHz	60Hz	25.175MHz	Yes	Yes	Yes
		37.9kHz	72Hz	31.5MHz	Yes	Yes	Yes
		37.5kHz	75Hz	31.5MHz	Yes	Yes	Yes
	800 × 600	35.1kHz	56Hz	36.0MHz	-	-	Yes
		37.9kHz	60Hz	40.0MHz	Yes	Yes	Yes
		48.1kHz	72Hz	50.0MHz	Yes	Yes	Yes
		46.9kHz	75Hz	49.5MHz	Yes	Yes	Yes
	848 × 480	31.0kHz	60Hz	33.75MHz	Yes	-	Yes
	1024 × 768	48.4kHz	60Hz	65.0MHz	Yes	Yes	Yes
		56.5kHz	70Hz	75.0MHz	Yes	Yes	Yes
		60.0kHz	75Hz	78.75MHz	Yes	Yes	Yes
	1152 × 864	67.5kHz	75Hz	108.0MHz	Yes	Yes	Yes
	1280 × 768	47.8kHz	60Hz	79.5MHz	Yes	-	Yes
		60.3kHz	75Hz	102.25MHz	Yes	-	Yes
	1280 × 800	49.7kHz	60Hz	83.5MHz	Yes	Yes	Yes
	1280 × 960	60.0kHz	60Hz	108.0MHz	Yes	Yes	Yes
	1280 × 1024	64.0kHz	60Hz	108.0MHz	Yes	Yes	Yes
		80.0kHz	75Hz	135.0MHz	Yes	Yes	Yes
	1360 × 768	47.7kHz	60Hz	85.5MHz	Yes	Yes	Yes
1400 × 1050	65.3kHz	60Hz	121.75MHz	Yes	Yes	Yes	
1440 × 900	55.9kHz	60Hz	106.5MHz	Yes	-	Yes	
1600 × 1200*1	75.0kHz	60Hz	162.0MHz	Yes	Yes	Yes	
1680 × 1050	65.3kHz	60Hz	146.25MHz	Yes	Yes	Yes	
1920 × 1200*1	74.0kHz	60Hz	154.0MHz	Yes	Yes	Yes	
Wide	1280 × 720	44.7kHz	60Hz	74.4MHz	Yes	Yes	Yes
		66.3kHz	60Hz	148.5MHz	Yes	Yes	Yes
	1920 × 1080	67.5kHz	60Hz	148.5MHz	Yes	Yes	Yes
US TEXT	720 × 400	31.5kHz	70Hz	28.3MHz	Yes	Yes	Yes
Sun	1024 × 768	48.3kHz	60Hz	64.13MHz	-	-	Yes
		53.6kHz	66Hz	70.4MHz	-	-	Yes
		56.6kHz	70Hz	74.25MHz	-	-	Yes
	1152 × 900	61.8kHz	66Hz	94.88MHz	-	-	Yes
		71.8kHz	76.2Hz	108.23MHz	-	-	Yes
	1280 × 1024	71.7kHz	67.2Hz	117.01MHz	-	-	Yes
		81.1kHz	76Hz	134.99MHz	-	-	Yes
1600 × 1000	68.6kHz	66Hz	135.76MHz	-	-	Yes	

*1 Displays a reduced image, except in Dot by Dot. In Dot by Dot, the image will be cut down to panel size then displayed.

*2 Available when the PN-ZB01 (optional) is attached.

* All are compliant only with non-interlaced.

* Depending on the connected PC, images may not be displayed properly even if the compatible signal described above is input.

* The frequency values for the Sun are reference values.

■Compatible signal timing (AV)

Screen resolution	Frequency	DVI-D*	HDMI	Component
1920 × 1080p	24Hz	-	Yes	-
	50Hz	Yes	Yes	Yes
	59.94Hz	Yes	Yes	Yes
	60Hz	Yes	Yes	Yes
1920 × 1080i	50Hz	Yes	Yes	Yes
	59.94Hz	Yes	Yes	Yes
	60Hz	Yes	Yes	Yes
1280 × 720p	50Hz	Yes	Yes	Yes
	59.94Hz	Yes	Yes	Yes
	60Hz	Yes	Yes	Yes
720 × 576p	50Hz	Yes	Yes	Yes
720 × 480p	59.94Hz	Yes	Yes	Yes
	60Hz	Yes	Yes	Yes
640 × 480p(VGA)	59.94Hz	Yes	Yes	-
	60Hz	Yes	Yes	-
720(1440) × 576i	50Hz	-	Yes	Yes
720(1440) × 480i	59.94Hz	-	Yes	Yes
	60Hz	-	Yes	Yes

* Available when the PN-ZB01 (optional) is attached.

Specifications

■PC/AV DVI-D input terminal pins

(DVI-D 24 pin)

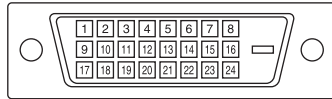

No.	Function	No.	Function
1	TMDS data 2-	13	N.C.
2	TMDS data 2+	14	+5V
3	TMDS data 2/4 shield	15	GND
4	N.C.	16	Hot-plug detection
5	N.C.	17	TMDS data 0-
6	DDC clock	18	TMDS data 0+
7	DDC data	19	TMDS data 0/5 shield
8	N.C.	20	N.C.
9	TMDS data 1-	21	N.C.
10	TMDS data 1+	22	TMDS clock shield
11	TMDS data 1/3 shield	23	TMDS clock+
12	N.C.	24	TMDS clock-

■PC/AV HDMI input terminal pins

(HDMI™ Connector)

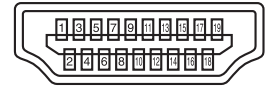

No.	Function	No.	Function
1	TMDS data 2+	11	TMDS clock shield
2	TMDS data 2 shield	12	TMDS clock-
3	TMDS data 2-	13	CEC
4	TMDS data 1+	14	N.C.
5	TMDS data 1 shield	15	SCL
6	TMDS data 1-	16	SDA
7	TMDS data 0+	17	DDC/CEC GND
8	TMDS data 0 shield	18	+5V
9	TMDS data 0-	19	Hot-plug detection
10	TMDS clock+		

■PC D-sub input terminal pins

(Mini D-sub 15 pin)

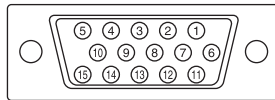

No.	Function	No.	Function
1	Red video signal input	9	+5V
2	Green video signal input	10	GND
3	Blue video signal input	11	N.C.
4	N.C.	12	DDC data
5	GND	13	Hsync signal input
6	GND for red video signal	14	Vsync signal input
7	GND for green video signal	15	DDC clock
8	GND for blue video signal		

■RS-232C input terminal pins

(D-sub 9 pin)

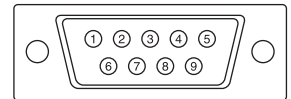

No.	Function	No.	Function
1	N.C.	6	N.C.
2	Transmitted data	7	N.C.
3	Received data	8	N.C.
4	N.C.	9	N.C.
5	GND		

■PC/AV DVI-D output terminal pins

(DVI-D 24 pin)

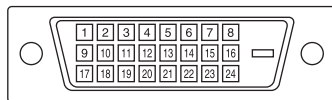

No.	Function	No.	Function
1	TMDS data 2-	13	N.C.
2	TMDS data 2+	14	+5V
3	TMDS data 2/4 shield	15	GND
4	N.C.	16	Hot-plug detection
5	N.C.	17	TMDS data 0-
6	DDC clock	18	TMDS data 0+
7	DDC data	19	TMDS data 0/5 shield
8	N.C.	20	N.C.
9	TMDS data 1-	21	N.C.
10	TMDS data 1+	22	TMDS clock shield
11	TMDS data 1/3 shield	23	TMDS clock+
12	N.C.	24	TMDS clock-

■RS-232C output terminal pins

(D-sub 9 pin)

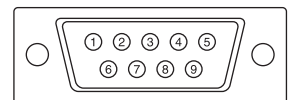

No.	Function	No.	Function
1	N.C.	6	N.C.
2	Received data	7	N.C.
3	Transmitted data	8	N.C.
4	N.C.	9	N.C.
5	GND		

Mounting Precautions (For SHARP dealers and service engineers)

- When installing, removing or moving the monitor, ensure that this is carried out by at least 4 people.
- Be sure to use a wall-mount bracket designed or designated for mounting the monitor.
- This monitor is designed to be installed on a concrete wall or pillar. Reinforced work might be necessary for some materials such as plaster / thin plastic board / wood before starting installation.
This monitor and bracket must be installed on a wall which can endure at least 4 times or more the weight of the monitor.
Install by the most suitable method for the material and the structure.
- To attach a VESA-compliant mounting bracket, use M6 screws that are 5/16 inch (8 mm) to 3/8 inch (10 mm) longer than the thickness of the mounting bracket.
- After mounting, please carefully ensure the monitor is secure, and not able to come loose from the wall or mount.
- Do not use any screw holes other than VESA holes for installation.

■Attaching the Tray

1. Remove the cover from the back of the monitor.

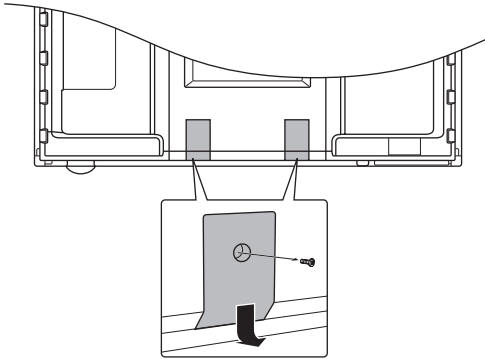

2. Secure the tray mounting fitting.

Secure using the screw removed in step 1 and 2 M5 tray mounting screws (supplied).

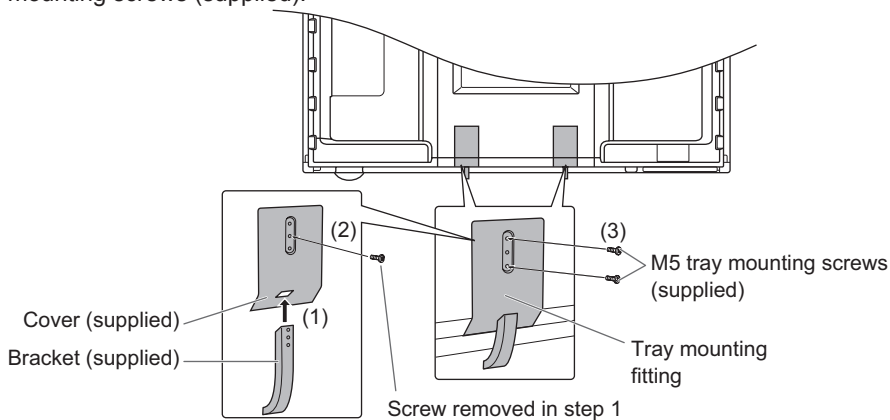

3. Secure the tray.

Insert the tray into the tray mounting fitting and secure with 2 M4 tray mounting screws (supplied).

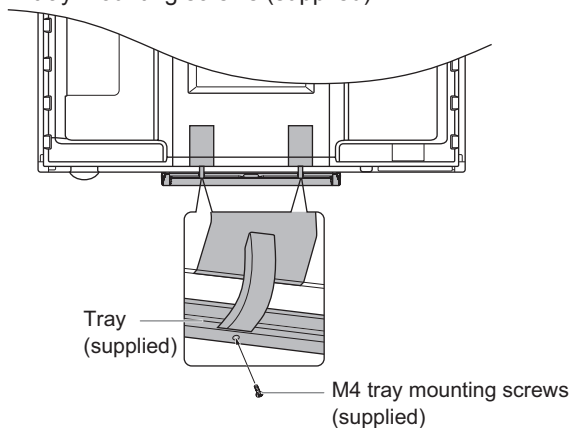

SHARP[®]
SHARP CORPORATION