

SHURE Microflex[®]

MX400D



MX418D



MX412D

MX400D

Desktop Microphones

Shure Microflex® MX400D Series microphones are miniature electret condenser gooseneck microphones with a desktop base and a 3 m (10 ft.) cable. Desktop base allows microphones to be used in multi-purpose rooms where quick setup is required, or where permanent installation is impractical.

Features

- Wide dynamic range and frequency response for accurate sound reproduction
- Interchangeable cartridges that provide a choice of polar pattern for each application
- Programmable mute button and LED indicator
- Logic input and output terminals for remote control or use with automatic microphone mixers
- Balanced, transformerless output for increased immunity to noise over long cable runs
- RF filtering

MX400 Series Model Variations

MX400 microphones are available with 305 mm (12 in.) or 457 mm (18 in.) goosenecks.

- “S” models include a mute button and LED.
- “D” models include a desktop base with programmable mute button and LED and logic input and output.
- “SE” models feature a surface mount flange with side-exit cable.

The polar pattern of the included cartridge is indicated by a model number suffix:

/C Cardioid

/S Supercardioid

/N Cartridge not included

Interchangeable Cartridges

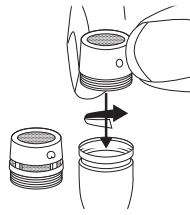

Microflex microphones use interchangeable cartridges that allow you to choose the polar pattern for different installations.



R183 Omnidirectional

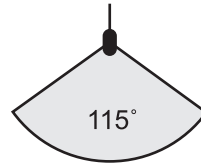

R184 Supercardioid

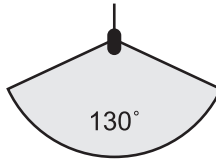

R185 Cardioid

Snap-Fit Windscreen

- Snap into the groove below the cartridge.
- To remove, spread the gap with a screwdriver or thumbnail.
- Provides 30 dB of “pop” protection.

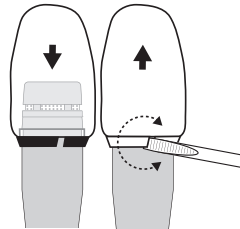

Microphone Placement

- Aim the microphone toward the desired source, such as the talker.
- Aim it away from any unwanted source, such as a loudspeaker.
- Place the microphone within 15 to 30cm (6 to 12 in.) of the desired sound source.
- Always use the supplied windscreen or optional metal windscreen to control breath noise.
- If four or more microphones will be open at the same time, use of an automatic mixer, such as the Shure SCM810 or SCM410, is recommended.

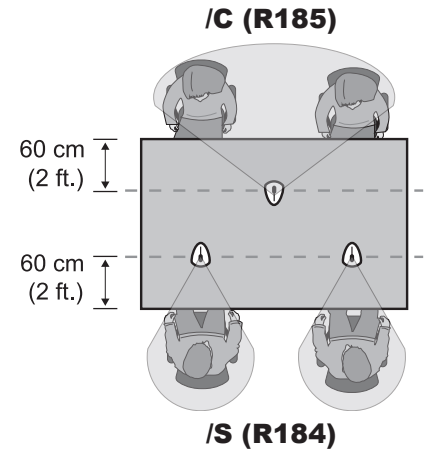

Securing to a Surface

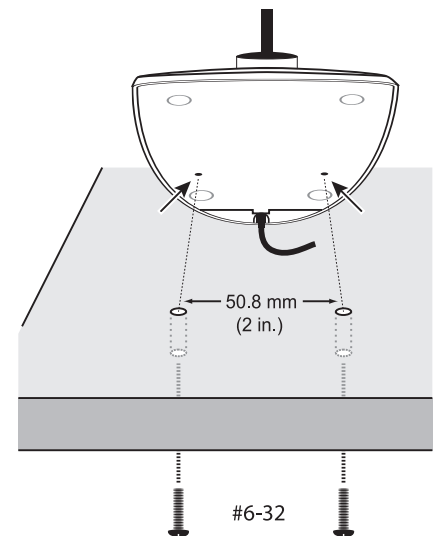

DIP Switches

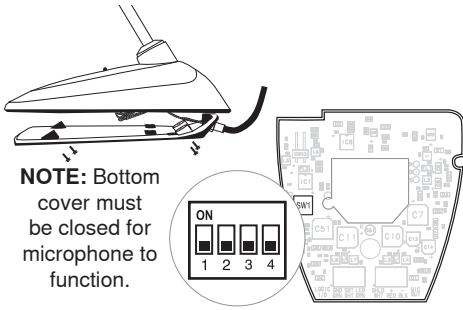

Use the DIP switches to configure logic settings and mute button behavior.

The DIP switches are covered with a piece of clear tape at the factory. Remove tape to modify the switch settings.

	OFF (factory default)	ON
1	Momentary	Toggle
2	Push-to-mute	Push-to-talk
3	Mute button enabled, LED illuminates when mic is active	Disable mute button (microphone always on), logic controls LED
4	--	--

Wiring Diagram

NOTE: Audio and logic ground are connected at microphone base.

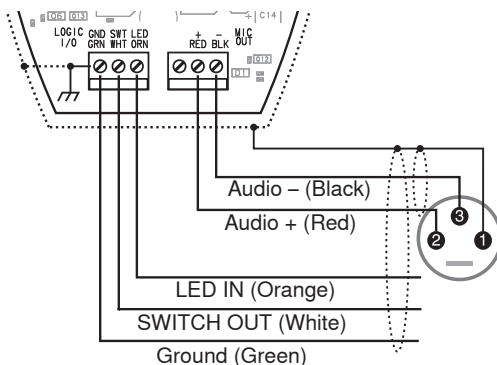

Mute Button Configuration

Use DIP switches 1 and 2 to configure the mute button, as follows.

Be sure to set DIP switch 3 **off** (factory default) so that the mute button controls audio from the microphone.

Switch Function	DIP Switch Setting
Momentary: push-to-mute (as shipped).	
Momentary: push-to-talk	
Toggle: (Push On/Push Off): Mic is active when powered on	
Toggle: (Push On/Push Off): Mic is mute when powered on	

Connecting to an Automatic Mixer

Use these settings if connecting the microphone to an automatic mixer or other device that mutes audio and controls the LED.

1. Connect logic leads to the automatic mixer. Connect the LED IN to the gate output to illuminate the LED when that channel is gated on.
2. Set DIP switch 3 on. This disables the mute button (the microphone passes audio regardless of whether the button is pressed or not).
3. Set DIP switch 1 to configure how the mute button sends SWITCH OUT logic:

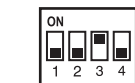

Momentary:
push = 0 Vdc,
release = 5 Vdc

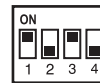

Toggle:
initial = 5 Vdc,
push = 0 Vdc

Logic Wiring

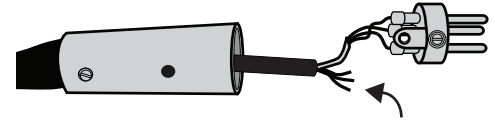

Green (LOGIC GROUND): Connects to the logic ground of an automatic mixer, switcher, or other equipment.

Orange (LED IN): Set DIP switch 3 on to use LED IN. When shorted to LOGIC GROUND, the LED turns on.

White (SWITCH OUT): Provides TTL logic (0 Vdc or 5 Vdc) in response to the mute button. Set DIP switch 1 for momentary or toggle. When phantom power is applied, logic initializes high (5 Vdc). DIP switch 2 has no effect on SWITCH OUT.

Changing SWITCH OUT to Always Momentary

Use the following modification in situations where your logic interface requires momentary closure of the SWITCH OUT, but you want the mute button to toggle the microphone (DIP switch 1 ON, 3 OFF):

1. Access the circuit board inside the microphone base.
2. Remove the resistor at R45 and reinstall it at location R46.

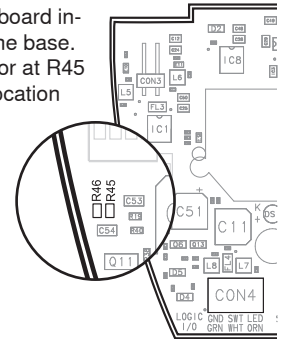

Specifications

Type

Condenser (electret bias)

Frequency Response

50–17000 Hz

Polar Pattern

MX412D/C, MX418D/C: Cardioid
MX412D/S, MX418D/S: Supercardioid

Output Impedance

EIA Rated at 150 Ω (180 Ω actual)

Output Configuration

Active balanced

Sensitivity (at 1 kHz, open circuit voltage)

Cardioid: -34 dBV/Pa (21 mV)
Supercardioid: -33 dBV/Pa (24 mV)
1 Pascal=94 dB SPL

Maximum SPL (1 kHz at 1% THD, 1 kΩ load)

Cardioid: 123 dB
Supercardioid: 122 dB

Equivalent Output Noise (A-weighted)

Cardioid: 29 dB SPL
Supercardioid: 28 dB SPL

Signal-to-Noise Ratio (referenced at 94 dB SPL at 1 kHz)

Cardioid: 65 dB
Supercardioid: 66 dB

Dynamic Range (1 kΩ load at 1 kHz)

94 dB

Common Mode Rejection (10 Hz to 100 kHz)

45 dB minimum

Preamplifier Output Clipping Level (1% THD)

-6 dBV (0.5 V)

Polarity

Positive sound pressure on diaphragm produces positive voltage on pin 2 relative to pin 3 of output XLR connector.

Net Weight

MX412D: 0.81 kg (1.80 lbs)
MX418D: 0.82 kg (1.82 lbs)

Packaged Weight

MX412D: 1.63 kg (3.62 lbs)
MX418D: 1.64 kg (3.64 lbs)

Logic Connections

LED IN: Active low ($\leq 1.0V$), TTL compatible.
Absolute maximum voltage: -0.7V to 50V.
LOGIC OUT: Active low ($\leq 1.0V$), sinks up to 20mA, TTL compatible. Absolute maximum voltage: -0.7V to 50V (up to 50V through 3kΩ).

Mute Switch Attenuation

-50 dB minimum

Cable

3 m (10 ft) attached cable with shielded audio pair terminated at a 3-pin male XLR and three unterminated conductors for logic control

Environmental Conditions

Operating Temperature: -18–57 °C (0–135 °F)
Storage Temperature: -29–74 °C (-20–165 °F)
Relative Humidity: 0–95%

Power Requirements

11–52 Vdc phantom, 2.0 mA

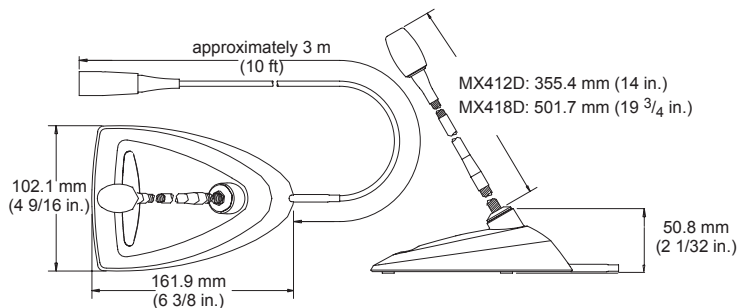

Furnished Accessories

Snap-fit Foam Windscreen (1 furnished, 4 in replacement kit)	RK412WS
--	---------

Optional Accessories

Foam Ball Windscreen	A99WS
Metal Locking Windscreen	A412MWS
Custom Logic Cable (specify length)	95B2509

Replacement Parts

Omnidirectional Cartridge (Black)	R183B
Supercardioid Cartridge (Black)	R184B
Cardioid Cartridge (Black)	R185B

CERTIFICATION

Eligible to bear CE Marking. Conforms to European EMC Directive 2004/108/EC. Meets Harmonized Standards EN55103-1:1996 and EN55103-2:1996, for residential (E1) and light industrial (E2) environments.

The Declaration of Conformity can be obtained from:

Authorized European representative:
Shure Europe GmbH
Headquarters Europe, Middle East & Africa
Department: EMEA Approval
Wannenacker Str. 28
D-74078 Heilbronn, Germany
Phone: +49 7131 72 14 0
Fax: +49 7131 72 14 14
Email: EMEAsupport@shure.de

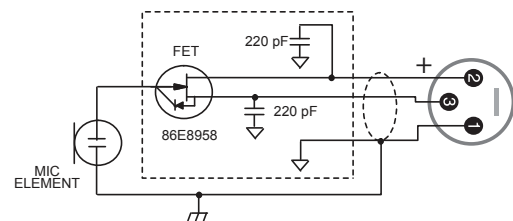

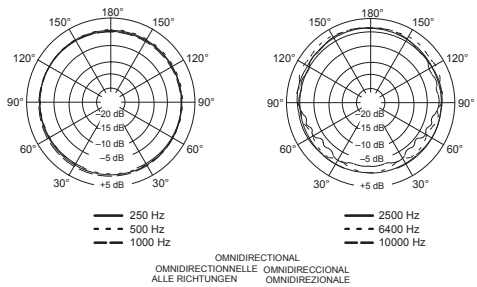
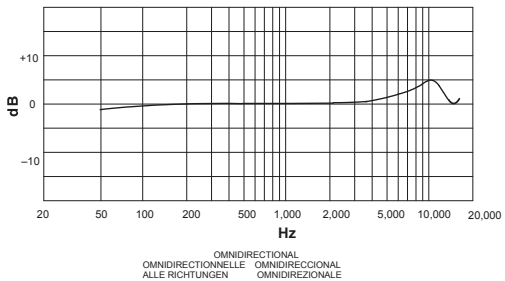
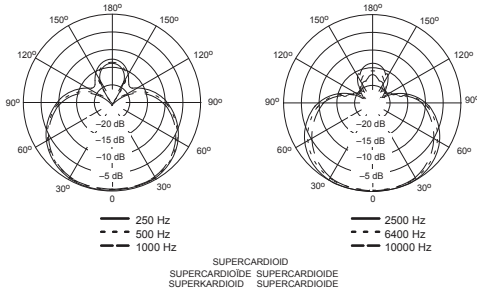
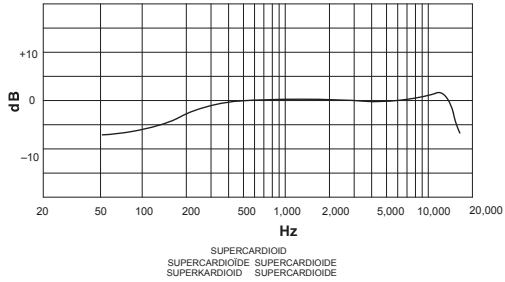
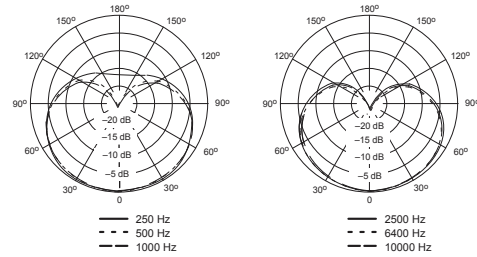
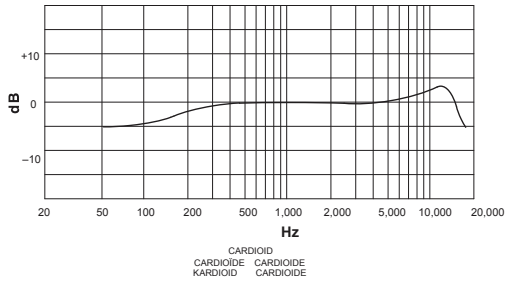

SHURE®

SHURE Incorporated <http://www.shure.com>
 United States, Canada, Latin America, Caribbean:
 5800 W. Touhy Avenue, Niles, IL 60714-4608, U.S.A.
 Phone: 847-600-2000
 U.S. Fax: 847-600-1212
 Intl Fax: 847-600-6446
 Europe, Middle East, Africa:
 Shure Europe GmbH, Phone: 49-7131-72140
 Fax: 49-7131-721414
 Asia, Pacific:
 Shure Asia Limited, Phone: 852-2893-4290
 Fax: 852-2893-4055

SHURE Incorporated <http://www.shure.com>
 États-Unis, Canada, Amérique latine, Caraïbes:
 5800 W. Touhy Avenue, Niles, IL 60714-4608, U.S.A.
 Téléphone : 847-600-2000
 Télécopie aux États-Unis : 847-600-1212
 Télécopie internationale : 847-600-6446
 Europe, Moyen-Orient, Afrique:
 Shure Europe GmbH, Téléphone : 49-7131-72140
 Télécopie : 49-7131-721414
 Asie, Pacifique:
 Shure Asia Limited, Téléphone : 852-2893-4290
 Télécopie : 852-2893-4055

SHURE Incorporated <http://www.shure.com>
 Estados Unidos, Canadá, Latinoamérica, Caribe:
 5800 W. Touhy Avenue, Niles, IL 60714-4608, EE.UU.
 Teléfono: 847-600-2000 (dentro de los EE.UU.)
 Fax: 847-600-1212
 Fax internacional: 847-600-6446
 Europa, Medio Oriente, Africa:
 Shure Europe GmbH, teléfono: 49-7131-72140
 Fax: 49-7131-721414
 Asia, Pacífico:
 Shure Asia Limited, teléfono: 852-2893-4290
 Fax: 852-2893-4055

SHURE Incorporated <http://www.shure.com>
 Stati Uniti, Canada, America latina, Caraibi:
 5800 W. Touhy Avenue, Niles, IL 60714-4608, U.S.A.
 Numero telefonico: 847-600-2000
 Fax U.S.A.: 847-600-1212
 Fax internazionale: 847-600-6446
 Europa, Medio Oriente, Africa:
 Shure Europe GmbH, numero telefonico: 49-7131-72140
 Fax: 49-7131-721414
 Asia, Pacifico:
 Shure Asia Limited, numero telefonico: 852-2893-4290
 Fax: 852-2893-4055