

UFM230/230L

UHF Filter/Amplifier Module

TECHNICAL DATA

- 230 MHz passband from 537 to 768 MHz centered at 653 MHz (TV channels 25-63)
- Ceramic resonator filters
- GaAsFET RF amplifier
- +41dBm 3rd order intercept
- Switching regulator for 8-16V power at constant power dissipation to minimize heat at high voltage
- Jumpers set gain at +5dB, +8dB or +12dB
- Powered from external DC source or phantom power from UMC16B multicoupler and Venue receivers
- Includes 6 ft DC locking style mating



The UFM230 is used to configure antenna systems requiring long cable runs or distribution to multiple receivers. RF filtering before gain minimizes intermodulation (IM) products and prevents overload. Two transmission line ceramic resonators at the input provide filtering with a 230 MHz bandwidth, followed by 12dB of gain using a high quality GaAsFET RF amplifier with an excellent +41dBm output IP3.

A switching regulator is used in the power supply to control current consumption over an input voltage range of 8 to 16 volts. The regulator maintains low current consumption and low heat dissipation which is especially useful in mobile field production applications.

The housing is constructed of cast aluminum with a brushed aluminum cover plate. Two rugged BNC connectors and a threaded, locking power jack provide secure connections for reliability in field production and long-term installations.

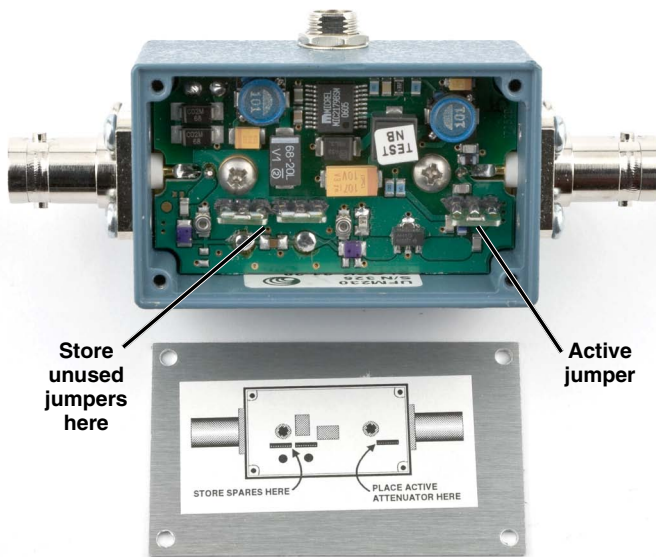

The gain of the RF amplifier can be adjusted to +12dB, +8dB or +5dB and using the 0, -4 and -7 jumpers. Remove the four screws and the bottom cover for access to the internal connections and jumpers.

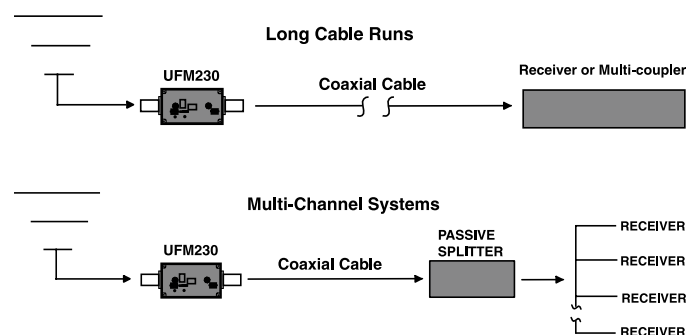
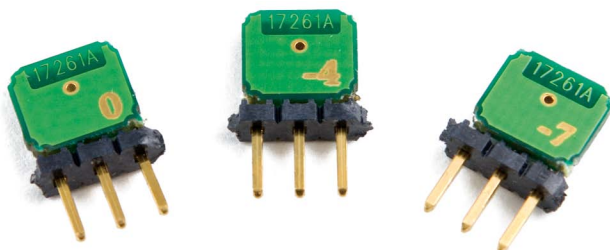

The UFM230 is placed near the antenna to apply gain ahead of long cable runs, or to compensate for splitter loss in a multi-channel signal distribution system.

Calculating Required Gain

Long Cable Runs

Connect the UFM230 input to the antenna with a short coaxial cable and the output to the long coaxial cable. Set the jumpers to achieve a gain value as close as possible to the loss in the long coaxial cable run.

Multi-channel Signal Distribution

An effective antenna multicoupler can be configured with the UFM230 and a passive splitter. Simply add up the loss through the coaxial cable and the output on the splitter and set the jumpers in the UFM230 for a gain value as close to the loss as possible.

For example, using a 4-way passive splitter (ZFSC41) with 6 dB of loss at each output and a coaxial cable (ARG15) with 2 dB of loss, the total loss is 8 dB between the antenna and the receiver input. In this case, the 4 dB attenuator reduces the 12 dB of gain in the amplifier to the 8 dB of gain that is needed ($12 - 4 = 8$).

Powering Options

Power can be supplied from external 8 to 16 VDC through the locking connector on the side panel, or from “phantom power” supplied by the UMC16B multicoupler or a Venue receiver.

Specifications

Third Order Intercept:	+27 dBm @ input (+41 dBm output)
Inputs:	RF In - BNC DC In - 2.1 mm locking power jack
Output:	RF out - BNC (and phantom power in)
Freq Range:	UFM230: 537 - 768 MHz UFM230L: 470 - 692 MHz
Filter Bandwidth:	230 MHz, factory set.
RF Gain:	+12 dB with 0dB attenuator +8 dB with 4dB attenuator +5 dB with 7dB attenuator
Power Requirements:	8V to 16V DC at the input jack; auto reset poly fuse protection circuit; constant power switching supply <ul style="list-style-type: none">• 8V DC (125 to 145 mA)• 12V DC (83 to 106 mA)• 14.4V DC (69 to 89 mA)• 16V DC (60 to 80 mA)
Phantom Powering:	DC voltage supplied via coaxial cable by UMC16B or VRM input jack or BIAS-T power inserter (70 to 80 mA)
Power Consumption:	1 Watt nominal (switching regulator)
Dimensions:	2.26 x 1.39 x 1.14 inches (not including BNCs)
Weight:	3.3 ozs

CE Compliance

This product meets the CE Compliance Standards - EN55022 and EN55082-1:1998. A copy of the Declaration of Conformity may be requested from your dealer or by contacting the factory directly.



581 Laser Road NE • Rio Rancho, NM 87124 USA • www.lectrosonics.com
(505) 892-4501 • (800) 821-1121 • fax (505) 892-6243 • sales@lectrosonics.com

Optional Accessories

Lectrosonics Passive Splitters Loss

ZSC24 (2-way)	3 dB
ZSC41 (4-way)	6 dB
ZSC843 (8-way)	9 dB

Lectrosonics Coaxial Cables Loss

ARG2	1 dB
ARG15	2 dB
ARG25	1.9 dB
ARG50	2.8 dB
ARG100	4.6 dB

FCC Compliance

This device complies with Part 15 of the FCC Rules. Operation is subject to the following two conditions: (1) This device may not cause harmful interference, and (2) this device must accept any interference received, including interference that may cause undesired operation.

The UFM230 and UFM230L have been tested and found to comply with the limits for a Class B digital device, pursuant to Part 15 of the FCC Rules. These limits are designed to provide reasonable protection against harmful interference in a residential installation. However, there is no guarantee that interference will not occur in a particular installation. This equipment generates, uses and can radiate radio frequency energy and, if not installed and used in accordance with the instructions, may cause interference to radio receivers. Changes or modifications to this equipment not expressly approved by Lectrosonics, Inc. could void the user's authority to operate it.

If this equipment does cause harmful interference to radio or television reception, which can be determined by turning the equipment off and on, the user is encouraged to try to correct the interference by one or more of the following measures:

- Reorient or relocate the receiving antenna
- Increase the separation between this equipment and receiver
- Connect this equipment into an outlet on a circuit different from that which the receiver is connected
- Consult the dealer or an experienced radio/TV technician for help