





LCD Commercial Widescreen The LG EzSign TV

47LD452B
42LD452B
37LD452B
32LD452B



The Best Award winner from the Commercial Integrator magazine for digital signage hardware, the LG EzSign TV is an innovation in digital signage that can entertain while maximizing the impact of your message. Create your own signage content by using your PC and the free EzSign software. Transfer that content by using a USB drive and plug it in to the EzSign TV to run content in the form of a billboard - no additional hardware is needed. Advertisement, information, and a live television broadcast can be arranged on the same screen to attract attention and deliver specific messaging to your customers.

FEATURES

- Digital Signage Function with Free S/W
- Public Display Settings - Cloning Capable
- EcoSmart™  Energy Saving Levels
- RoHS COMPLIANT 
- Auto Sensing Remote Jack Pack (RJP) Compatible*
- Pro:Centric™ ST
- DYNAMIC CONTRAST RATIO 60,000:1
- NATIVE DISPLAY RESOLUTION
1920 x 1080 full HD 1080p (37"/42"/47" class)
1366 x 768 (32" class)
- BUILT-IN ATSC/NTSC/QAM CLEAR TUNER
- INVISIBLE SPEAKER SYSTEM
Hidden speaker grilles
- LG'S EXCLUSIVE XD ENGINE®
- Multi Remote IR Code
- USB 2.0 Media Host for photos and music
- USB CLONING
- CLEAR VOICE II
- REAL CINEMA™
- 2 HDMI™ INPUTS WITH HDCP V.1.3 with deep color
- 2 year Limited Warranty (parts and labor)

*NOTE: Contact your LG Sales representative on the RJPs that are compatible with the LD452B series.

ENERGY GUIDE
↓

The estimated annual energy cost determined in accordance with 16 CFR Part 305.5 for models 47LD452B, 42LD452B, 37LD452B & 32LD452B are \$26, \$20, \$17 & \$15, respectively.

**Your energy cost depends on your utility rates and use. The estimated cost is based on 11 cents per kWh and 5 hours of use per day. For more information, visit www.ftc.gov/energy."

*FTC Television labeling rule (18 CFR Part 305, as added by 76 Fed. Reg. 1038 (Jan 6, 2011)).

LGsolutions.com





LIFE'S GOOD...

WHEN IT'S GREEN.

LG is committed to improving product development, manufacturing and usage to meet the demand for environmentally friendlier products. Our LD452B televisions have technologies to reduce power consumption and in return increase cost savings per room. We've also placed limits in the amounts of harmful materials used in these televisions.

- **EcoSmart**
Energy Saving Levels - Manually select your choice for the brightness level for the television.
- **RoHS Compliant** - Meets directive on restriction of hazardous substances.

FEATURES

LG'S SIGNAGE TECHNOLOGY MEETS THE TELEVISION LG EZSIGN TV

COST EFFECTIVE. SIMPLE. HIGHLY EFFECTIVE.



COST EFFECTIVE

No need to buy a media player - Create your own signage content by using your PC and the free EzSign software. Transfer that content by using a USB flash drive and plug it in to the EzSign TV to run it



CUSTOMIZED TO YOUR NEEDS - Signage content can be specific to your business

The LG EzSign TV allows you to create your own signage content and make revisions on the fly.



FAST AND EASY - Edit content quickly and easily

Select one of the pre-installed content templates. Apply images and add texts on it. It's that simple.



VARIETY - Pick and choose from a broad range of template designs

The LG EzSign TV gives you the power to choose and change according to your needs.

LG EZSIGN SOFTWARE - Simple 4 step procedure

STEP1 Choose a Template

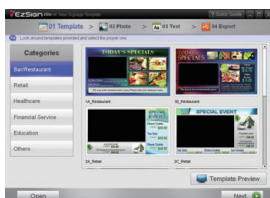

STEP2 Add Photos

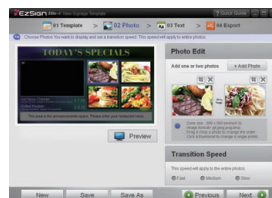

STEP3 Edit the Text

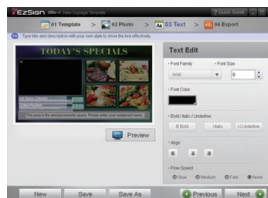

STEP4 Export to USB

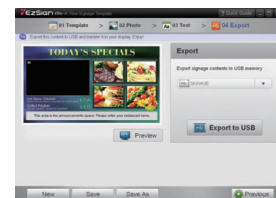

ENERGY SAVING LEVELS

Manually select your choice for the brightness level for the television. By selecting Minimum, Medium, or Maximum, the power consumption will be reduced and an increase in energy savings can be achieved. (Note: Selecting minimum level may slightly increase power consumption on some models)

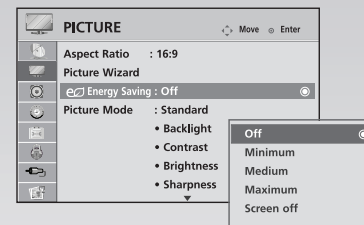

CONNECTIVITY

As a versatile addition to the TV viewing experience, LG's optional autosensing Remote Jack Packs (RJP)*, can serve as a multimedia hub that can be installed conveniently on a table or in a wall. Connect portable devices such as a laptop, mp3 player, or a digital camera to display images, play video or music from the set.



PUBLIC DISPLAY SETTINGS

When used in public areas, these HDTVs can be easily programmed by the installer to have the TV turn on at a specified channel/volume level, set the minimum/maximum volume, lock out the control panel/remote, set the aspect ratio, and return to a factory reset. By using Power Management, these displays can be programmed to turn off if there has been no activity (remote or control panel buttons) for a preset time (1-7) hours.

Public Display Setting	
Public Display Mode	No
Start Channel	No
Ch. Type	TV
Major	2
Minor	0
Minimum Volume	0
Maximum Volume	100
Start Volume Level	No
Power Management Setting	No
Key Management	1
Factory Reset	0
Aspect Ratio	0

USB CLONING

USB cloning will allow for easy transfer of Public Display Settings from the "Master TV" to an unlimited number of same type televisions.

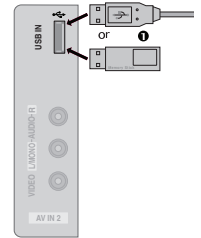

invisible SPEAKER

SOUND IS HEARD, NOT SEEN

Enjoy a combination of smart technology and stylish design with the invisible speaker system custom tuned by audio expert Mr. Mark Levinson. This unique system provides a clean, polished look and an enhanced auditory experience by increasing the sweet spot and providing a wider sound field.



MOUNTING HOLES ON STAND

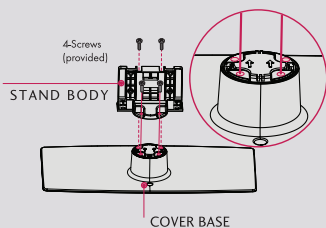

DIMENSIONS

47LD452B
42LD452B

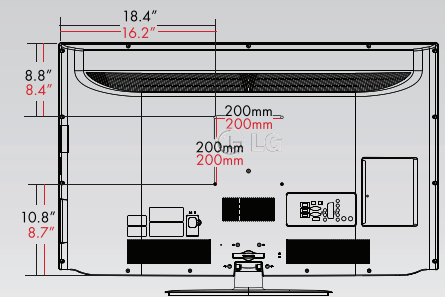
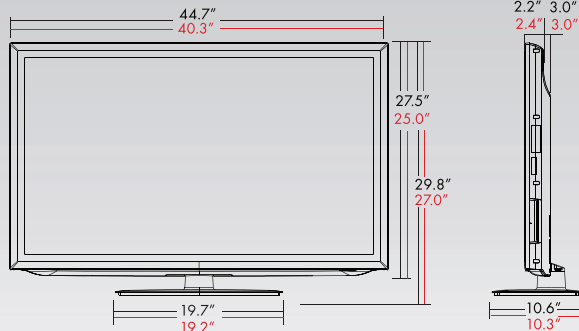

37LD452B
32LD452B

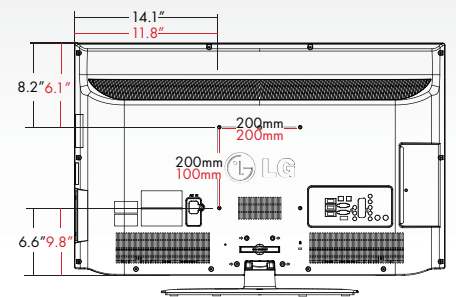
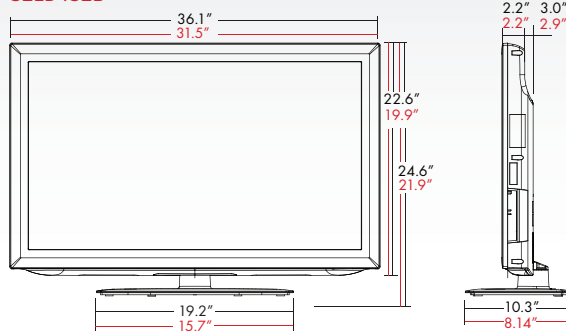

REAR

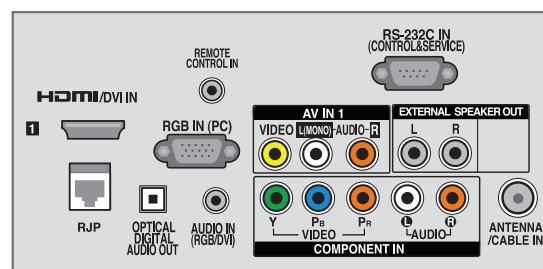

SIDE



47LD452B	47" class (47.0" measured diagonally)
42LD452B	42" class (42.0" measured diagonally)
37LD452B	37" class (37.0" measured diagonally)
32LD452B	32" class (31.5" measured diagonally)

SPECIFICATIONS

LCD SPECIFICATION

Screen Size (Class)	47" class (47.0" measured diagonally) 42" class (42.0" measured diagonally) 37" class (37.0" measured diagonally) 32" class (31.5" measured diagonally)
Native Display Resolution	1920 x 1080 (37", 42", 47" class) 1366 x 768 (32" class)
Dynamic Contrast Ratio	60,000:1
Viewing Angle	178°/178°
Color Reproduction	10 Bit
Response Time (G to G)	4ms
True Viewing Angle	Yes
Life Span (Typical)	60,000 hrs
BROADCASTING SYSTEM	
Analog	Yes
ATSC/NTSC/Clear QAM	Yes
MPEG4	Yes
VIDEO	
Aspect Ratio	16:9
Aspect Ratio Correction	6 Modes (16:9/Just scan/Set by program/4:3/Zoom/Cinema Zoom)
Color Temperature Control	3 Modes (Cool/Medium/Warm)
Picture Status Mode	7 Modes (Vivid/Standard/Cinema/Sport/Game/Expert 1/Expert 2)
Just Scan (0% over scan)	
HDMI Component	1080i/1080p/720p
RF/DTV	1080i/720p
24p Real Cinema (24p 5.5/2.2 Pull down)	Yes
Eye Care (Anti Dazzling)	Yes
Fresh White	Yes
Expert Mode/ ISF Ready	Yes
Picture Wizard	Yes
AV Mode (Cinema/Game/Sport)	Yes
xvCC	Yes
DTV Signal Strength	Yes
AUDIO	
Audio Output	10W x 2
Invisible Speaker System Details	1 Way 2 Speaker
Dolby Digital 5.1 Decoder	Yes
Surround System Type	Infinite Sound
Bass/Treble/Balance Controls	Yes
Auto Volume Leveler	Yes
EZ Sound Mode/SSM	5 Modes
Clear Voice II	Yes
SPECIAL FEATURES	
XD Engine	Yes
Energy Saving Modes	Yes (Backlight Control, Video Mute)
EPG(SI)	Yes (Pro:Centric)
1080p Source Input	Yes HDMI/Component (60/30/24p), RGB (WXGA)
A/V Input Navigation	Yes
Input Labeling/Sub-title	Yes
LG SIMPLINK™ (HDMI CEC)	Yes
Parental Control w/V-Chip	Yes
Key Lock/Child Lock	Yes
Customizable Closed Caption/Sub-title	Yes
Splash Image - Logo (on start up)	Yes
Multi Remote IR code (Bed1/2/3/4)	Yes
Auto-Sensing RJP compatible	Yes (with select RJP versions)
Bed 1/Bed 2/ Bed 3/ Bed 4 Control	Yes
PictureWizard	Yes
TVLink-Protocol (Tuner, Loader)	Yes
USB Cloning (USB Link Loader)	Yes
1080p Source Input	
HDMI	60p/30p/24p
Component	60p/30p/24p
RGB	WXGA
Quick View (Flashback)	Yes
e-Streamer	Yes (for shop mode)
OSD Language	4 (English/Spanish/French/Korean)
Quick Menu (Round Type-8 menus selectable)	Yes (Aspect Ratio/SAP/ Picture Mode/ Sound Mode/Audio/Sleep Timer/Ch Add/USB Eject)
Alvin UI	Yes
Function Menu	Yes
Installation Menu	Yes (v2.6)

CONVENIENCE FEATURES

Auto Tuning/Programming	Yes
Channel Add/Delete	Yes
Favorite Channel Programming	Yes
Auto/Manual Clock	Yes
On/Off Timer	Yes
Sleep Timer	Yes
Auto Off/Auto Sleep (When no video is present)	Yes

AUDIO/VIDEO INPUTS/OUTPUTS

RF In (Antenna/Cable)	1
L/R Audio/Composite Video In	1 (rear), 1 (side)
HD Component Video In (Y, Pb, Pr) + L/R Audio	1
Digital Audio Out (Optical)	1
HDMI/HDCP Input (V1.3 with Deep Color)	1 (side), 1 (rear)
RGB In (D-Sub 15pin) - PC	1 (1920 x 1080)
PC Audio Input	1
RS-232c In (Control/Service)	1
USB 2.0 Input	1 (side) Media Host (JPEG, MP3), Cloning, and Service

Remote Control Port In	1
RJ45 (for RJP interface - non PIP)	1

CABINET/ACCESSORIES

Cabinet Color	Glossy Black
Swivel Stand (degrees)	+20°/-20°
Top Side Mounting Screw	Yes
TORX Security Screw (2 each)	Yes
Power Indicator	Yes (on/off)
Fire Retardant Cabinet Material	Yes
Kensington Security System Slot	Yes
VESA Mount Compatible	Yes
Remote Control	Yes

POWER

Voltage, Hz	100V - 240V, 50/60 Hz
Stand-by Mode (typ.)	0.2W (EPA 4.0)
Power Consumption Max	180W (32" class), 200W (37" class), 260W (42" class), 330W (47" class)

Power Consumption Typical	78W (32" class), 95W (37" class), 115W (42" class), 138W (47" class)
---------------------------	--

Dynamic Power Savings	Yes
Static Power Savings	Yes

REQUIRED APPROVALS

RoHS Compliant	Yes
UL, cUL, NOM	Yes

DIMENSIONS & WEIGHT

TV without stand (WxHxD)	31.5" x 19.9" x 2.9" (32" class) 36.1" x 22.6" x 3.0" (37" class) 40.3" x 25.0" x 3.0" (42" class) 44.7" x 27.5" x 3.0" (47" class)
--------------------------	--

TV with stand (WxHxD)	31.5" x 21.9" x 8.1" (32" class) 36.1" x 24.6" x 10.3" (37" class) 40.3" x 27.0" x 10.3" (42" class) 44.7" x 29.8" x 10.6" (47" class)
-----------------------	---

Shipping Dimensions (WxHxD)	38.0" x 23.2" x 7.5" (32" class) 39.2" x 26.0" x 9.0" (37" class) 43.6" x 30.3" x 9.0" (42" class) 48.8" x 31.6" x 10.0" (47" class)
-----------------------------	---

TV without stand weight	17.9 lbs (32" class) 23.8 lbs (37" class) 29.8 lbs (42" class) 38.6 lbs (47" class)
-------------------------	--

TV with stand weight	20.1 lbs (32" class) 27.6 lbs (37" class) 33.3 lbs (42" class) 43.0 lbs (47" class)
----------------------	--

Shipping weight	24.9 lbs (32" class) 35.1 lbs (37" class) 41.7 lbs (42" class) 52.7 lbs (47" class)
-----------------	--

SERVICE/LIMITED WARRANTY

UPC CODE	
32LD452B	7 19192 90239 8
37LD452B	7 19192 90378 4
42LD452B	7 19192 90242 8
47LD452B	7 19192 90243 5

Required PC spec for installation: Pentium M or 4 CPU, 512MB RAM, Windows XP sp2, 200MB HDD



All screen images are simulated. Dimensions and weights are approximate. Design, features and specifications subject to change without notice.

© Copyright 2011 LG Electronics USA, Inc. All Rights Reserved. "LG Life's Good" is a registered trademark of LG Corp. XD Engine is a registered trademark of LG Electronics, Inc. HealthView and EcoSmart are trademarks of LG Corp. Dolby and the double-D symbol are registered trademarks of Dolby Laboratories. SRS and the SRS symbol, TruSurround XT and WOW are trademarks or registered trademarks of SRS Labs, Inc. VESA is a trademark of Video Electronics Standards Association. All other product and brand names are trademarks or registered trademarks of their respective companies.

Printed in the USA. November 2011

LGsolutions.com

LG Electronics U.S.A., Inc.
Commercial Displays
2000 Millbrook Drive
Lincolnshire, IL 60069

Customer Service: 888.865.3026
www.LGsolutions.com/support

Contact your LG Regional Sales Representative
Vertical Markets: 800.897.8788
Channel: 800.897.8871
Hospitality: 800.228.1236
E-mail: info@LGsolutions.com

SPEC_LD452B_111103_PR



LG
Life's Good