

MF-104M ANALOG DELAY

USER'S MANUAL



WELCOME TO THE WORLD OF MOOGERFOOGER ANALOG EFFECTS MODULES!

Your MF-104M Analog Delay is a rugged, professional-quality instrument, designed to be at home on stage or in the studio. Its great sound and jaw-dropping effects come from state-of-the-art analog circuitry, designed and handcrafted by our team at Moog Music in Asheville, North Carolina.

The MF-104M is rooted in the analog wizardry of Bob Moog's Moogerfooger designs. It is a direct descendent of the original Moog® modular synthesizers and professional rack effects.

Housed in a rugged steel and hardwood enclosure, your MF-104M Analog Delay features an all-analog signal path. Its finely-tuned frequency response and overload contours produce the sound quality of the best vintage delay devices.

The MF-104M Delay Line incorporates a dual-range Bucket Brigade Device (BBD) providing a range of delay times from 40 milliseconds to 800 milliseconds. A multi-waveform Low Frequency Oscillator (LFO) enables you to create a variety of effects including chorus, pitch shifting, and vibrato by modulating the Delay Line.

Several of the performance parameters are voltage-controllable. This means you can use expression pedals like the Moog EP2, a MIDI-to-CV converter or any other source of control voltage, such as Moogerfoogers to play your MF-104M.

In addition, the front panel rotary controls and switches can be controlled through the use of MIDI and the LFO can be synced to a MIDI Clock.

While you can use it on the floor like a conventional effects box, your Analog Delay is much more versatile. Its sound quality and versatility is higher than most fixed-function "stomp boxes" you may be accustomed to. You will find that your Analog Delay is a deep electronic musical resource that offers a very large range of analog sound processing possibilities.

GETTING STARTED

Let's get started by unpacking and setting up your MF-104M. Here are some simple instructions on how to plug in and try your new MF-104M.

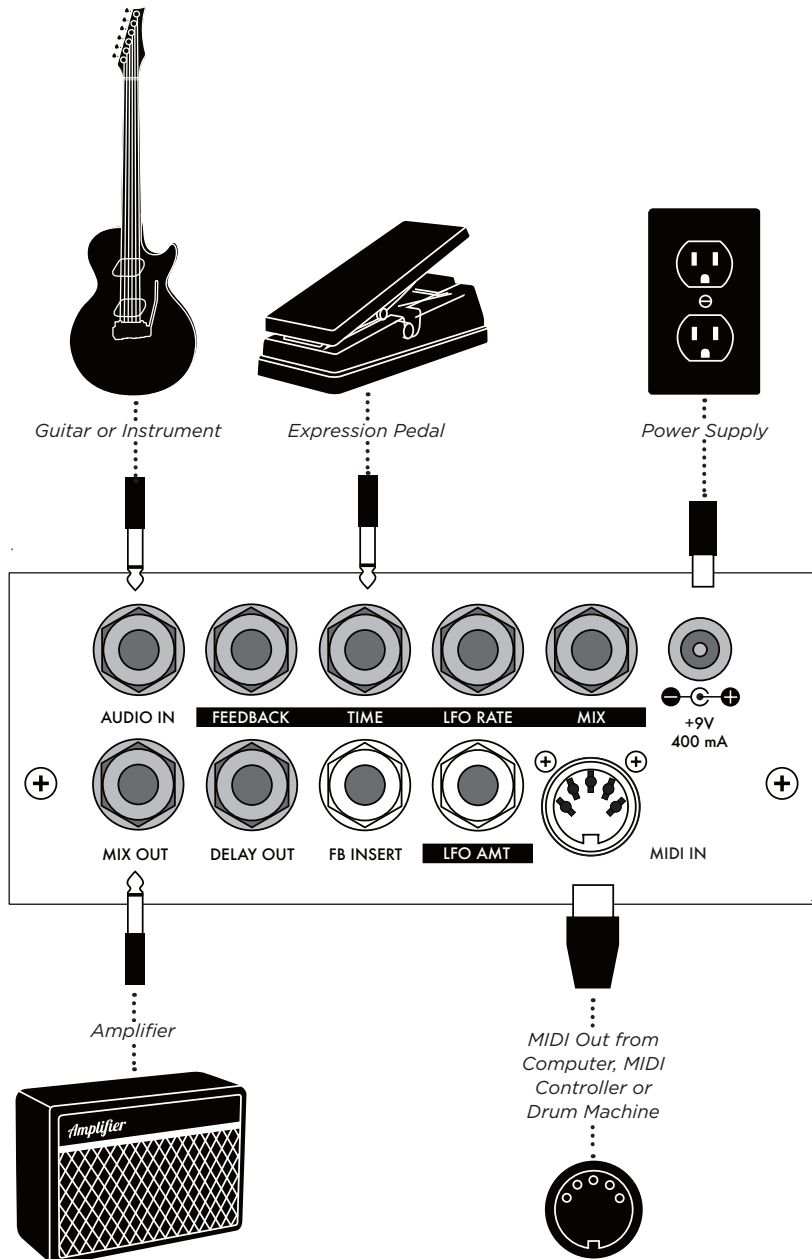

Unpacking

1. Remove your new Moogerfooger from the packaging and allow it a few moments to get its land legs after the long journey to its new home.
2. Inside the box you'll find your Analog Delay, AC adapter, warranty card, and this manual. Save the box in case you ever need to ship your MF-104M back to Moog Music.

3. Don't forget to register your Analog Delay. Why? Moog is constantly updating its products. The only way to know about an update is by registering. The easiest way is by visiting: www.moogmusic.com/register

Connecting

1. Connect an instrument cable from your sound source to the **AUDIO IN** jack on your MF-104M. You can feed virtually any instrument or line-level signal through your MF-104M.
2. If you plan on using MIDI, connect a MIDI cable from the out on the MIDI controller of your choice to the MF-104M's MIDI IN.

NOTE: The Analog Delay defaults to MIDI Channel one. Make sure your MIDI controller is transmitting on MIDI Channel one.

3. Connect an instrument cable from the **MIX OUT** jack to a line-level input on your amp or mixer.
4. Using the supplied power adapter, plug the cord into the **+9V** jack. Then, plug the power adapter itself into a wall receptacle.

NOTE: The MF-104M requires a power supply of +9VDC, CENTER POSITIVE, rated for at least 400mA.

5. Once the power supply is plugged in your Moogerfooger is ready to work. You'll notice that the **BYPASS** indicator is red. This indicates the effect is **OFF**.

THE MF-104M FRONT PANEL

The **FRONT PANEL** of the MF-104M Analog Delay contains the performance controls and LED indicators.

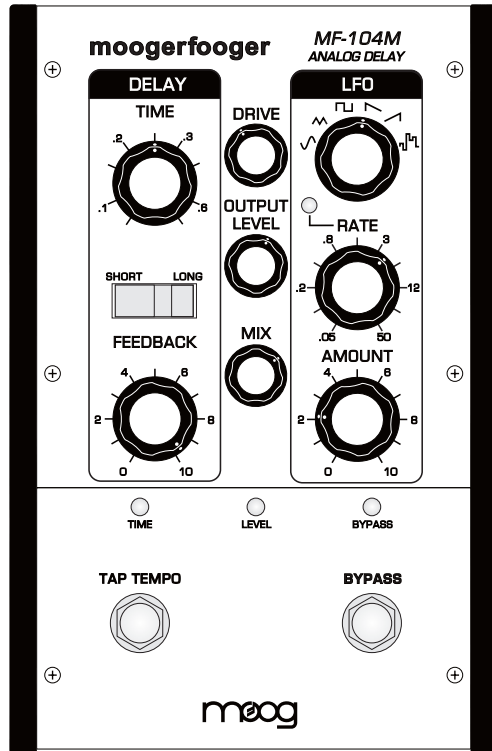

DELAY LINE CONTROLS (LEFT PANEL):

TIME - Adjusts delay times from 40ms to 400ms in Short mode and 80ms to 800ms in Long mode.

RANGE - Selects between Short and Long delay times and bright or dark filter. The Short setting is brighter while the Long setting is darker.

FEEDBACK - Provides continuous control from no feedback to greater than infinite. *NOTE: Feedback settings above 8 can cause the unit to self-oscillate.*

LEVEL CONTROLS (CENTER PANEL):

DRIVE - Allows 35 dB of adjustment of the input signal for optimum signal path, level matching and overdriving sound sources.

OUTPUT - Allows gain and attenuation of output signal for compatibility with a wide range of input devices.

MIX - Crossfader control for blending wet and dry signals to the output.

LFO CONTROLS (RIGHT PANEL):

LFO - Six-position rotary switch selects the LFO wave shape for delay time modulation. Select from Sine, Triangle, Square, Ramp, Sawtooth, and Sample and Hold modulation.

LFO RATE - Adjusts the LFO rate from 0.05 Hz to 50 Hz (wider range available via control voltages and MIDI).

LFO AMOUNT - Controls the amount of LFO modulation of the delay time.

NOTE: More details on these controls can be found on page 17.

THE MF-104M BACK PANEL

The **BACK PANEL** has all the connection points for sending audio signals in and out, control voltage inputs, MIDI input, and power supply connector.

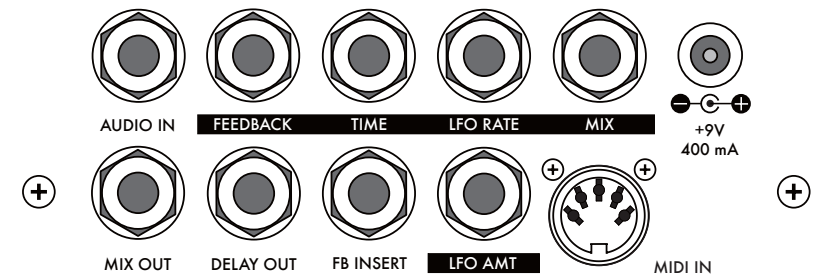

AUDIO IN - 1/4" TS jack. Accepts any instrument level to line level audio signal.

MIX OUT - 1/4" TS jack. Adjustable output level for instrument or line level output.

DELAY OUT - 1/4" TS jack. Supplies wet-only output.

FEEDBACK, TIME, LFO RATE, MIX, LFO AMOUNT - All are 1/4" TRS jacks that accept Moogerfooger EP-2 (or equivalent) expression pedals, or 0-5VDC control voltages from either two-circuit (TS) or three-circuit (TRS) 1/4" jacks.

FEEDBACK INSERT - Supplies line-level send and return via a 1/4" TRS jack for inserting effects into the feedback loop of the Delay line

MIDI IN - Accepts a 5-pin DIN input for controlling the MF-104M via MIDI.

+9VDC POWER JACK - Accepts standard 9 volt center positive barrel power adaptor (power adaptor included). 400mA minimum required.

NOTE: More details on these connections can be found on page 20.

SETTING LEVELS

1. Turn your amp or monitor on, then, turn its volume control down but not off.

2. On the MF-104M, turn all controls except the **MIX** and **OUTPUT LEVEL** to their far left position. Turn the **MIX** knob to 12:00 and the **OUTPUT LEVEL** to 9:00 as shown in **Figure 1**.

3. Press the **BYPASS** switch so the **BYPASS LED** turns green (**Figure 2**). This means the effect is **ON**. If you press and hold the **BYPASS** switch, you'll see the LED change from red to orange or green. Orange or green indicate that the effect is on but in different modes. For now we'll focus on Normal.

- **NORMAL MODE** - Green LED
- **SPILLOVER MODE** - Orange LED
- **OFF** - Red LED

4. While playing your instrument (or signal source) turn the **DRIVE** control clockwise as in **Figure 3** until the **LEVEL LED** stays green with occasional orange flashes on peaks.

Note: Red indicates clipping - this is OK if you want to use the Drive control to add some distortion.

5. Tap the **BYPASS** switch until the **BYPASS** indicator is red. This means the effect is **OFF** (bypassed).

6. Play your instrument or source again. Then adjust the **OUTPUT LEVEL** control until the overall volume with the effect on and with the effect bypassed is the same. You may have to switch the effect off and on a few times and make small adjustments. Once you find the sweet spot keep those knobs set to maximize fidelity and signal-to-noise ratio.

Since we know you are eager to start hearing what your Analog Delay can do, let's dig in, learn a little, and hear how the Delay Line and LFO work together to create some amazing sounds.

If you really need some instant gratification skip to page 13 for some great setups.



FIGURE 1

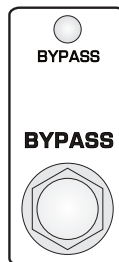

FIGURE 2



FIGURE 3

DIGGING IN

As you already know by now the MF-104M has a Delay Line and a LFO. To demonstrate how they work we'll first check out the Delay Line with the LFO off. Next, we'll go over the LFO with the Delay Line at the minimum setting. Then, we'll put them together to create some magic.

NOTE: It only seems like magic. In actuality it's some serious know how on the part of Moog's product design team.

GETTING TO KNOW THE DELAY LINE

As you go through this section, adjust controls as shown in the illustrations on the right side of the page to hear how different Delay Line settings affect the audio output.

Adjust the Delay Line settings as shown in **Figure 4** then play your instrument. That's the classic "slapback" echo. Now increase the **FEEDBACK** control to 5 and play your instrument again. You'll hear a fast series of decaying echoes.

As you increase the **FEEDBACK** more of the delayed signal gets sent back through the Bucket Brigade Device which means a longer series of repeats.

Adjust the settings again as shown in **Figure 5** and start jamming. There's that slapback again but the delayed sound is darker (has less treble). Now increase the **FEEDBACK** to 5. Play while listening to the echoes and you'll really notice the difference, even if your ears are a little cooked from a recent overdose of decibels.

Your Analog Delay was designed with an area of overlap in the **SHORT** and **LONG** delay ranges, with the **SHORT** range having a higher frequency response. This provides the ability to fine tune the tonal characteristics of the delayed sound (see **Figure 6**).

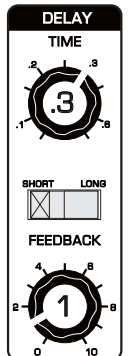

FIGURE 4

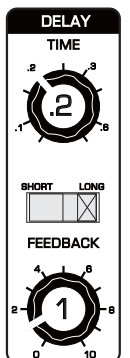

FIGURE 5

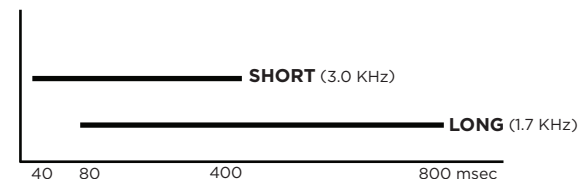

FIGURE 6

Adjust the **FEEDBACK** as shown in *Figure 7*, and tap the **BYPASS** switch to turn the effect **OFF**. Then press and hold the **BYPASS** switch until the LED turns orange. The MF-104M is now in **SPILLOVER** mode.

Play your instrument to build up some echoes in the Delay Line. Now tap the **BYPASS** switch to turn the effect off while continuing to play. The signal from your instrument will not be sent through the effect but any audio currently in the circuit will continue to sound as if the effect were on. Pressing and holding the **BYPASS** button for two seconds toggles your Analog Delay between modes.

- In **NORMAL** mode, turning the effect **OFF** shuts off audio from the Delay Line. Any new signals bypass the effect.

- In **SPILLOVER** mode, turning the effect **OFF** allows audio currently in the Delay Line to continue while any new signals bypass the effect.

Play your instrument while turning the **TIME** control as in *Figure 8*. You'll hear the pitch of the delayed signal change briefly and then return to pitch.

As you change the **DELAY TIME** the signal becomes stretched or compressed as it goes through the delay circuit, thereby speeding up or slowing down the vibrations.

When you change the **DELAY TIME** you are changing the clock rate of an oscillator that determines how fast signals go through the individual circuits in the Bucket Brigade Device (see *Figure 9*).

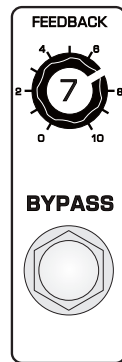

FIGURE 7

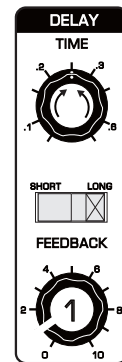

FIGURE 8

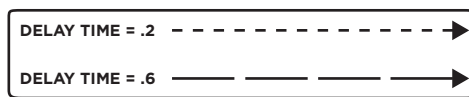

FIGURE 9

Take a little time to experiment with various settings of the **DELAY TIME**, **SHORT/LONG** switch, and **FEEDBACK**.

Here are some things you will notice:

- Changing the **SHORT/LONG** switch position either halves or doubles the **DELAY TIME** and thus compresses or stretches the delayed signal currently in the Delay Line by a factor of two. This results in the pitch of the delayed signal being shifted up or down an octave.

- The **FEEDBACK** control creates the series of echoes by mixing a portion of

the delayed signal back into the Delay Line. With the control set to about 8, the echoes sustain indefinitely. With the **FEEDBACK** control set above 8, the echoes build up chaotically into some amazing electronic textures that can be both edgy and blurry at the same time.

GETTING TO KNOW THE LFO

This section demonstrates how the LFO modulates the Delay Line.

Adjust all Delay controls as shown in *Figure 10*. Press the **BYPASS** control to bypass the effect (**BYPASS** LED = Red).

Play your instrument for a few seconds. Tap the **BYPASS** switch again to turn the effect back on and play some more. Hear the difference? This is due to the fact that with the effect on the Delay Line is still in the circuit and is creating a very short (40 millisecond) echo of the signal.

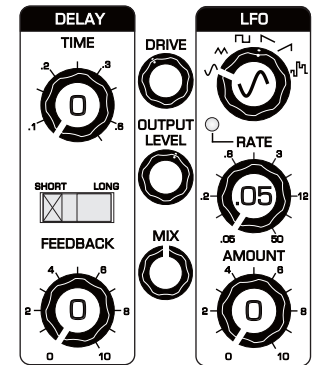

FIGURE 10

Adjust your LFO controls as shown in *Figure 11*. Play your instrument and you'll hear a classic chorus effect. How does this happen?

We just noted that changing the **DELAY TIME** changes how fast signals go through BBD in the Delay Line. And, you'll remember that changing the **TIME** will cause pitch shifting of audio already in the Delay Line due to time compression and expansion of the signal.

In the MF-104M the LFO is used to modify (or modulate) the rate at which signals go through the BBD based on the chosen **WAVEFORM**, **RATE**, and **AMOUNT**. In this example of a chorus effect, the LFO is smoothly modulating the **TIME** with a slowly changing sine wave of low amplitude (small peaks and troughs). Because the sine wave is "gentle", only minor pitch shifting occurs.

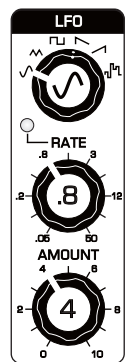

FIGURE 11

Adjust the LFO settings as shown in **Figure 12**. Play your instrument again and you will hear the delayed signal quickly sliding up and down an octave, somewhat like a siren. With the **AMOUNT** and **RATE** increased, the sine wave has greater amplitude and is cycling faster thus modulating the delayed signal more profoundly. If the pitch change is not quite an octave you might need to fine tune these settings slightly.

Increase the **AMOUNT** slowly and, at a setting of around 9, you will find the point where the pitch of the delayed signal goes up and down by two octaves.

Let's use another **WAVEFORM** and check out the differences.

Adjust the settings on your MF-104M as shown in **Figure 13**. The delayed signal will bounce up and down one octave without sliding, or for you more classical types, with no glissando. In theory, a square wave has no slope (**See Figure 14**).

It goes directly from peak to trough to peak without transition. Thus there is no sliding of the pitch. But in practice there is a brief transition phase which creates odd harmonics and adds a definite edge or crispness to the tone. If the octave is not quite right, fine tune the **AMOUNT** slightly.



FIGURE 14

Take a few minutes to experiment with different **WAVEFORM**, **RATE**, and **AMOUNT** settings.

Since it's always good to know the waves before you ride, here are some brief descriptions, listed from left to right on the **WAVEFORM** control:

- Sine**- A periodic wave that smoothly transitions from peak to trough with no harmonics. Creates vibrato and tremolo effects when used to modulate another signal.

- Triangle**- A periodic wave creates a triangle shape in moving from peak to trough. Creates similar effects to a sine wave when modulating another signal but with a sharper tone due to the generation of odd harmonics.

- Square**- A wave that alternates almost instantaneously between two

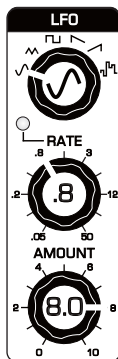

FIGURE 12

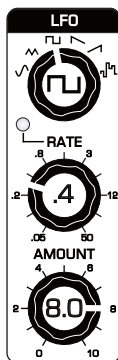

FIGURE 13

states. Creates octave and other pitch shifting effects when used to modulate another signal.

- Sawtooth**- A wave that very quickly reaches a peak and then ramps down more slowly.

- Ramp**- A type of sawtooth wave that ramps up slowly to a peak then drops down quickly.

- Sample And Hold** - Also known as a random step, a square-ish wave that randomly changes from up and down state and wave height (amplitude).

PUTTING IT ALL TOGETHER

Having the ability to combine your instrument or source signal with a delayed signal that is also modulated is one way in which the MF-104M stands apart. The following four setups contain some familiar uses of the Delay Line with the LFO providing an interesting twist. And speaking of twist, these setups are just begging for some serious knob turning, expression pedal wiggling, and other creative high jinks.

The front panel controls are referred to as performance controls for a reason: They are meant to be played. Your MF-104M Analog Delay is a musical instrument in itself.

1. STRETCHING TAPE

Classic tape style delay with a stretching effect courtesy of triangle wave modulation. Try plugging a Moog EP-2 expression pedal into the Rate CV jack and use it to speed up or slow down that stretching effect.

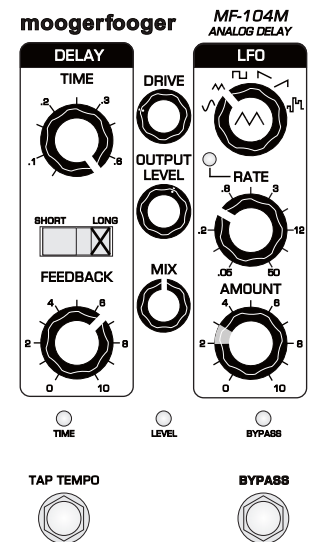

2. VIBROLAY

A spatial vintage style delay with triangle wave vibrato added to the trails. Try quick notes or chords combined with held notes. Use the Rate and Amount knobs to add different flavor and feel.

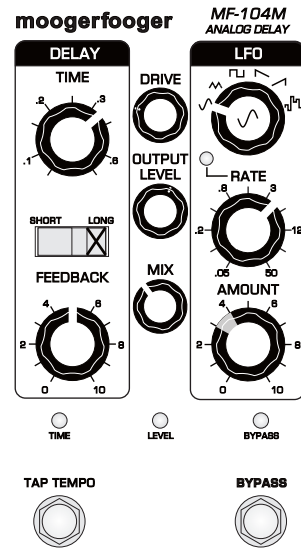

3. STAIR STEPPER

This Ramp modulated preset will have notes working their way through the roof. Play a note and let the delay do the rest. Use the Short/Long switch for even more musical mangling.

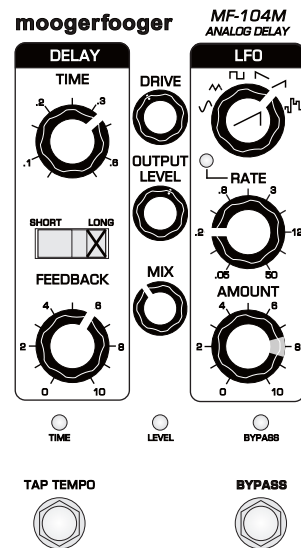

4. SQUARE ROOT

Prepare for octave action with this awesome square wave mod. Each note will rhythmically jump up and down a full octave for percussive bliss. Assign Tap Tempo to the LFO Rate and stomp away.

Note: If the pitch change is not quite an octave you might need to fine tune these settings slightly.

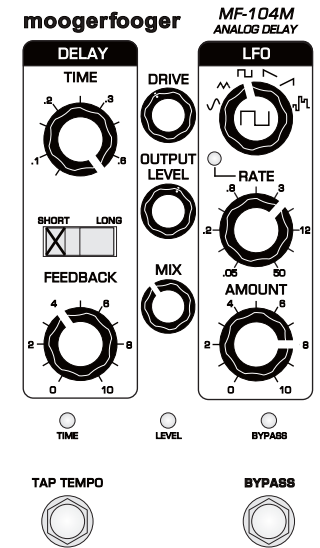

A NOTE ABOUT TAP TEMPO

The **TAP TEMPO** switch on your Analog Delay can be used to control either the **DELAY TIME** or the **LFO RATE**. To set a tempo, simply tap the switch at the desired tempo, in quarter notes. After the third tap the MF-104M will start calculating the tempo and keep the average tempo as you continue to tap. To start over, wait five seconds and then press the **TEMPO** switch three times to set a new tempo. To revert to using the front panel control, turn either the **TIME** knob or **LFO RATE** knob (depending on which tempo you are setting).

- Pressing and holding the **TAP TEMPO** control for at least one second toggles the Tap Tempo function between the **LFO RATE** and **DELAY TIME**.

- The LED indicator for the function being controlled by Tap Tempo will flash green and flash in sync with the chosen tempo.

SOME HELPFUL TIPS

- You can use the **DRIVE** control to create some warm analog distortion of the input if you so choose.

- By using the **TAP TEMPO** control to tap very slowly or very quickly, you can set “illegal” tempos that go outside of the designed ranges of the LFO and BBD. Doing so creates aliasing artifacts that can sound like ring modulation. It isn't pretty but it can sound very cool. Please use judiciously.

ABOUT ANALOG DELAYS

A delay circuit produces a replica of an audio signal a short time after the original signal is received. If you listen to the original (direct) signal and the delayed signal together, the delayed signal will sound like an echo of the direct. To make a whole series of echoes that die out gradually, you feed the delayed output signal back to the input. You can determine how far apart the echoes are by adjusting the delay time of the delay circuit, and you can adjust how fast the echoes die out by adjusting the amount of feedback from the delay. In addition, you can determine how loud echoes are by adjusting the mix between the direct signal and the delayed signal.

During the early 1970s, large-scale semiconductor analog delay circuits came into being. These are called Bucket Brigade Delay (BBD) chips, because they function by passing the audio waveform down a chain of several thousand circuit cells, which is analogous to water being passed by a bucket brigade to put out a fire. Each cell in the chip introduces a tiny delay. The total time delay depends on the number of cells and on how fast the waveform is “clocked”, or moved from one cell to the next.

In the MF-104M, the LFO creates a control voltage that is used to modulate the time function of the delay. The BBDs in the Delay Line contain 8192 “buckets”. With the time unmodulated the signal spends the same amount of time in each bucket based on the selected delay time. With the time modulated by the LFO, the time is no longer constant (or static) and audio signals already in the buckets get time compressed or stretched. A good analogy for picturing this is a clock with a sweep hand to show the seconds. Imagine that you could hold the sweep hand and either slow it down or speed it up. Yet, when you let it go the sweep hand instantly went to the correct position on the clock face. In a sense, this is how the LFO modulates the Delay Line.

In an analog delay the input can be set to saturate gradually, limiting the maximum signal level and introducing some low level distortion. This actually enhances the sound quality over what you would have if the MF-104M produced no distortion whatsoever.

THE MF-104M FRONT PANEL

This section provides more in-depth descriptions of the controls and indicators on the MF-104M front panel.

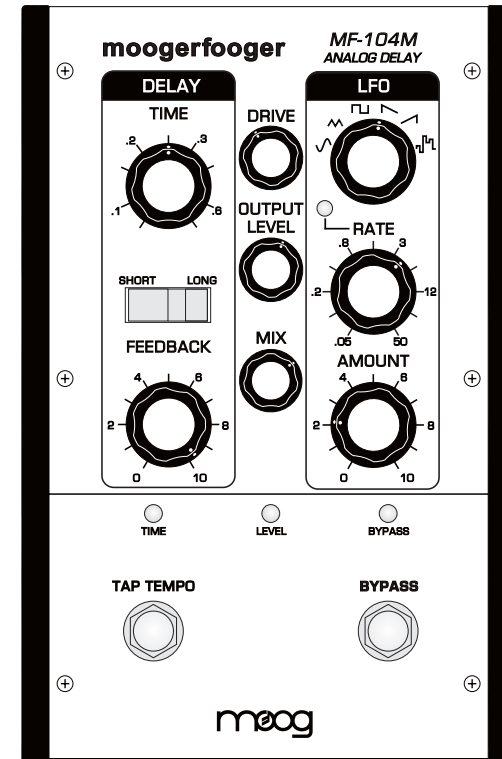

DRIVE CONTROL - Sets the input sensitivity of the Analog Delay. This control is only active when the effect is **ON** or in **SPILLOVER** mode. The available gain runs approximately 35dB. The Analog Delay is designed to work with instrument to line-level signals.

LEVEL LED - Works in conjunction with the **DRIVE** control. Red indicates clipping. Orange flashes indicate the start of overload. Green indicates the presence of signal at or below the nominal level.

*NOTE: For most instruments, the best approach is to set the **DRIVE** level so the **LEVEL LED** stays consistently green with only peaks in the orange. It is okay to drive the Analog Delay into clipping/distortion if that sound is desired. When using an instrument with a wide dynamic range, you may want to insert a compressor or limiter prior to the input of the Analog Delay for the best signal-to-noise ratio without clipping.*

OUTPUT LEVEL - Sets the strength of the Analog Delay output at the **MIX OUT** and **DELAY OUT** jacks. This control is only active when the effect is on or in Spillover mode. The **OUTPUT LEVEL** control is designed so that an overall boost, attenuation or zero gain state can be achieved with any **DRIVE** setting.

MIX - Sets the ratio of dry (signal as input) to wet (effected) signal. This control is only active when the effect is on. Set fully counterclockwise it allows only the dry signal to pass to the **MIX** output. The full clockwise position allows only the wet signal to pass to the **MIX** output. Any position between the two will blend wet and dry signal to the output. The **DELAY OUT** signal is not affected by the **MIX** control.

*Note: If you're applying a sustained steady pitch to the MF-104M and the **MIX** control is set near 12:00, you may find that the direct and delayed signals alternately reinforce and cancel each other in rapid succession as the **DELAY TIME** is varied. This is a normal result of mixing a steady pitch with a delayed replica of itself. It is the analog-delay equivalent of "standing waves" in a reverberant room.*

DELAY TIME - Sets the length of delay from the BBD Delay Line based on the **SHORT/LONG** (Delay Range) switch setting. In **SHORT** mode, with **AMOUNT** set to 0, the delay time changes from approximately 40ms to 400ms nominal. In **LONG** mode the available span is from approximately 80ms to 800ms nominal. The **DELAY TIME** is modulated via the LFO to create various effects.

Since the delay's internal anti-alias filter must change for the delay time, the **SHORT** setting will yield a higher frequency response for the same delay time as **LONG**. Switching from **SHORT** to **LONG** will reduce the sound in the "feedback loop" one octave, while switching the other direction will double the pitch and time of the loop sound.

FEEDBACK - Sets the amount of Delay Line output fed back into the input of the Bucket Brigade Device. The feedback is variable from off, slapback or single repeats, to continuous repeats (at about the 3:00 setting). When turned past 3:00, the **FEEDBACK** provides for self-oscillation and swelling delay sounds.

WARNING: *The Analog Delay Feedback control is able to drive the Delay Line into self-oscillation. This means the Analog Delay is capable of producing sounds without any audio signal present. Tones produced by self-oscillating feedback may be much stronger than normal signal levels. **Please watch your speakers and ears.** Oscillation typically begins at the 3:00 position.*

LFO WAVEFORM - Selects the LFO waveform for modulation of the Delay Time. There are six waveforms available: Sine, Triangle, Square, Sawtooth, Ramp and Sample and Hold (Random Stepped) waveforms.

Note: No modulation will be heard with the LFO AMOUNT set to zero.

LFO RATE - Sets the frequency of modulation of the Delay Line by the LFO. The **RATE** can be varied from .05 Hz to about 50 Hz. The **LFO RATE** LED indicates both the **RATE** and **WAVEFORM** of the current LFO settings. The LED is red when the **RATE** is set from the front panel, green when the rate is set by the **TAP TEMPO** switch, and orange when the **LFO** is synced to MIDI clock. When synced to MIDI clock, the **RATE** control is quantized to select only rhythmic subdivisions of the MIDI clock tempo.

LFO AMOUNT - Sets the overall amount of modulation of the Delay Line by the LFO.

*Note: As the LFO Amount increases, the functional range of the **DELAY TIME** control is decreased, so that the maximum and minimum delay times are not exceeded.*

BYPASS - Used to turn the effect **ON** and **OFF**. When the effect is on the Bypass LED is green. When the effect is in **SPILLOVER** mode the **BYPASS** LED is orange. When the effect is off the **BYPASS** LED is red.

TAP TEMPO - Dedicated switch used for setting the **DELAY TIME** or the **LFO RATE** to a musical tempo.

To initiate Tap Tempo control of the **DELAY TIME**, press the **TAP TEMPO** switch three times with the tempo you want (quarter notes). On the third press, the **TIME LED** will change to Green, and the **DELAY TIME** will change rates to match the timing of the switch presses.

If you continue to press the **TAP TEMPO** switch, the **TIME** will be set by a running average of the time between switch presses. To start over, wait five seconds and then press the **TAP TEMPO** switch three times to set a new tempo.

To revert the unit to front panel control, simply turn the **TIME** control. The **TIME LED** will turn red, and the **DELAY TIME** will set by the panel control.

To initiate Tap Tempo control of the LFO, press and hold the **TAP TEMPO** switch for at least one second. The LFO LED will flash green to show that the tap tempo is now routed to the LFO and not the **DELAY TIME**. To change back, press and hold the **TAP TEMPO** switch again until the **TIME** indicator flashes green.

When Tap Tempo is routed to the LFO pressing the switch three times or more will set the LFO rate to match the tap time. Turning the **RATE** knob reverts the unit back to front panel control.

Note: When either destination (time or LFO) is synchronized to MIDI Clock messages, Tap Tempo is disabled for that destination only.

TIME INDICATOR LED - Flashes red to indicate the delay time. It will flash green to indicate that it is synced to Tap Tempo and orange when it is controlled by MIDI.

THE MF-104M BACK PANEL

This section provides greater detail of the connection points on the MF-104M back panel.

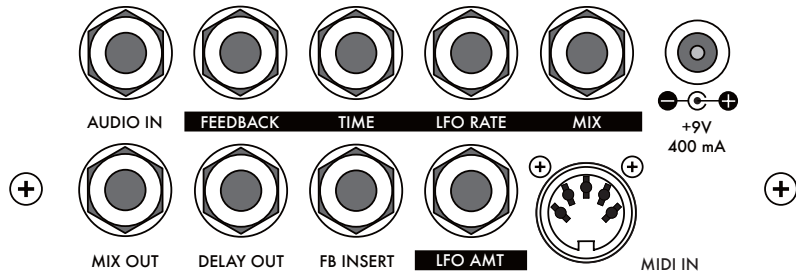

AUDIO IN - This 1/4" jack provides high impedance, unbalanced audio input. The Analog Delay accepts signals ranging from instrument to line level.

MIX OUT - This 1/4" jack provides an unbalanced audio output. When the effect is on, this output carries the dry and wet signal blend set on the front panel **MIX** control. The level is determined by the **DRIVE** and **OUTPUT** level controls. When the effect is off, the input signal passes only through a high-quality buffer on its way to the output.

DELAY OUT - This 1/4" jack provides an unbalanced audio output. This is a wet-only output, in phase with the **MIX** output. The level is affected by the **OUTPUT LEVEL** knob but not the **MIX** knob. This output can be used as a second output in **STEREO** applications or as a feed for phasing effects.

FEEDBACK (FB) INSERT - This 1/4" TRS jack is designed to be used with a standard insert cable to process the BBD feedback signal path separately from the dry signal path. This is an unbalanced, line level output and input. The BBD output signal appears at the tip of the jack, and the return to the device is applied to the ring of the jack.

Because these are line level signals, some means of attenuation or amplification may be required if using devices designed for lower signal levels, such as typical guitar stomp boxes.

*Note: Unlike the classic MF-104SD and MF-104Z, the **FEEDBACK** insert is placed before the first delay in the feedback.*

FEEDBACK - 1/4" TRS jack that can be used with a Moog EP-2 expression pedal, or a 0V to +5V control voltage on a standard TS cable. A setting of 0 volts or ground allows for no feedback while a 5V setting gives infinite feedback. To change the feedback amount from zero to infinite via control voltage or expression pedal, set the **FEEDBACK** control to 12:00 position.

TIME - 1/4" TRS jack that can be used with a Moog EP-2 expression pedal, or a 0V to +5V control voltage on a standard TS cable. To change the **DELAY TIME** for a selected range from longest to shortest via control voltage or expression pedal, set the **DELAY TIME** control to 12:00 position.

LFO RATE - 1/4" TRS jack that can be used with a Moog EP-2 expression pedal, or a 0V to +5V control voltage on a standard TS cable.

To use an expression pedal to modify the LFO Rate (0.05 Hz to 50 Hz) set the **LFO RATE** to 12:00 position. Rotate the **LFO RATE** knob counterclockwise. With a 0V control voltage applied to the LFO Rate CV input, the LFO Rate can be reduced to half of the minimum panel rate. (.025 Hz) Now rotate the **LFO RATE** control fully Clockwise. With a +5V control voltage applied to the LFO Rate CV input, the LFO Rate can be increased to double the maximum panel rate. (100 Hz)

LFO AMOUNT - 1/4" TRS jack that can be used with a Moog EP-2 expression pedal, or a 0V to +5V control voltage on a standard TS cable. To modify the **LFO AMOUNT** from minimum to maximum via control voltage or expression pedal, set the **LFO AMOUNT** control to 12:00 position.

MIX - 1/4" TRS jack that can be used with a Moog EP-2 expression pedal, or a 0V to +5V control voltage on a standard TS cable. To change the Mix from dry to wet via control voltage or expression pedal set the **MIX** control to 12:00 position.

MIDI IN - Standard 5-pin DIN for receiving MIDI messages from another MIDI device such as a MIDI controller or a sequencer. Refer to the MIDI section of this manual for use of the Analog Delay with other MIDI devices.

POWER - For connecting to the supplied power adapter. *Note: Use only the proper power supply to avoid damage to the device. Make sure your power supply has the correct Input voltage specifications for your country:*

- 120VAC/60 Hz for the US and Canada
- 230VAC/ 50 Hz for Europe and South America

The output of the adapter is +9VDC and the adapter should be capable of supplying a minimum of 400mA. The +9VDC is applied to the tip (center) of a barrel connector plug w/ 5.5mm outer diameter and 2.1mm inner diameter. The barrel (outside) of the plug is the ground (-).

CIRCUIT CONFIGURATION

The figure below is a simplified block diagram of the MF-104M Analog Delay.

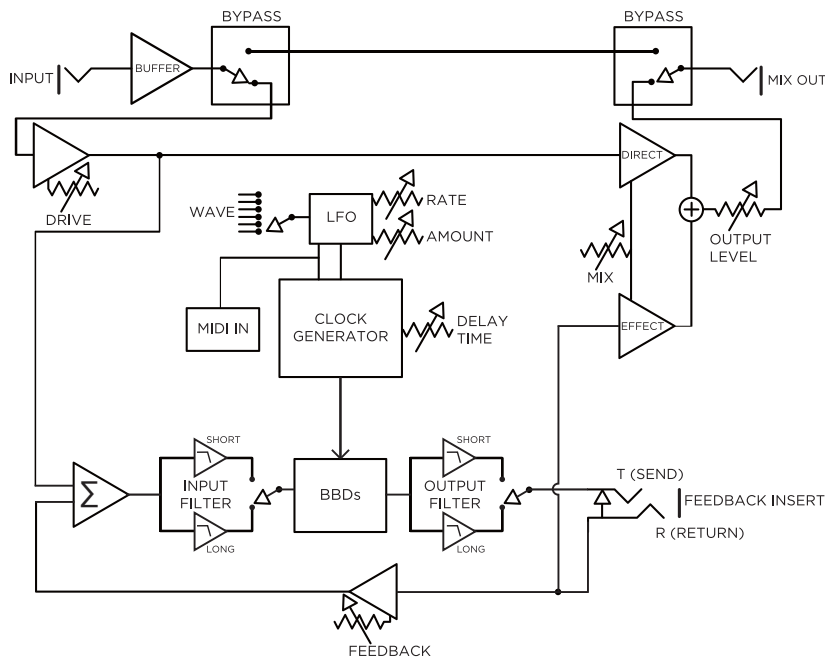

MIDI CONTROL OF THE MF-104M

The following section explains the MIDI implementation of the MF-104M. For information about what MIDI is and how it works, you can go to the following web page for tutorials: www.midi.org/aboutmidi/tutorials.php

MIDI CHANNEL

The default MIDI Channel for the MF-104M is Channel one. To change this, press and hold both the **TAP TEMPO** and **BYPASS** switches. While holding both, send a MIDI Channel mode message to the Analog Delay on the desired MIDI channel. The **TIME LED** will flash yellow indicating that the message has been received. The MF-104M will now only receive MIDI messages on that channel. The current MIDI Input channel is stored in memory on power down.

Note: MIDI Clock and System Exclusive messages are NOT Channel Mode messages, and are received by the Analog Delay regardless of the current MIDI Input Channel.

MIDI CONTROL CHANGE (CC) MESSAGES

The settings of the Analog Delay can be controlled by MIDI Control Change (CC) messages. In addition to the front panel controls, there are a number of advanced features that can be enabled and edited with CC messages.

A MIDI CC message has both a CC number from 0-127 and a value from 0-127. The CC values that affect panel controls replace the physical setting of the front panel controls. When the corresponding front panel control is changed after receiving a MIDI CC message, the value will return to that panel control. MSB/LSB refers to 14-bit MIDI which uses a pair of CC messages to obtain higher resolution control. Use the MSB CC numbers to control these parameters at 7-bit resolution. *Note: Moving a panel control while receiving MIDI CC messages for that same control will result in conflicting values.*

THE FOLLOWING CC MESSAGES CORRESPOND TO PANEL CONTROLS:

CC NUMBER	PARAMETER	VALUES
7(MSB), 39(LSB)	Output Level	0-16383 (MSB, LSB)
12(MSB), 44(LSB)	Time	0-16383 (MSB, LSB)
13(MSB), 45(LSB)	Feedback	0-16383 (MSB, LSB)
14(MSB), 46(LSB)	Mix	0-16383 (MSB, LSB)
15(MSB), 47(LSB)	LFO Rate	0-16383 (MSB, LSB)
16(MSB), 48(LSB)	LFO Amount	0-16383 (MSB, LSB)
102	LFO Waveform	0-15=Sine, 16-31=Triangle 32-47=Square, 48-63=Saw 64-79=Ramp, 80-95=S&H 96-127=Smooth S&H
86	Range(Fast/Slow)	0=Slow, 64=Fast (Moves 1 Octave)
80	Bypass on/off	0-63=Bypassed, 64-127=Active

THE FOLLOWING CC MESSAGES DO NOT CORRESPOND TO FRONT PANEL CONTROLS, BUT EXTEND THE ANALOG DELAY'S CAPABILITIES.

CC NUMBER	PARAMETER	VALUES
5(MSB), 37(LSB)	Time Slew Rate	0-16383 (MSB, LSB)
83	Pitch Bend Amount	0 = Off, 16 = 2 Semi 32 = 3 Semi, 48 = 4 Semi 64 = 5 Semi, 80 = 7 Semi 96 = 12 Semi, 112 = 24 Semi
85	Filter Bright/Dark	0-63 = Bright 64-127 = Dark (Only adjusts filter, does not affect range)
87	Delay Time Multiplier	0-31=Norm, 32-63=x2 64-95=x4, 96-127=x8
89	Delay Time MIDI Sync Enable	0-63 = Disabled 64-127 = Enabled
105	LFO Phase Reset	Any Value=Reset LFO Phase to 0.
107	LFO Clock Divisions	(See Separate table)

CC NUMBER	PARAMETER	VALUES
108	Enable LFO MIDI Sync	0-63 = Disabled 64-127 = Enabled
109	Enable LFO Note Reset	0-63 = Disabled 64-127 = Enabled
110	Enable MIDI Note Spillover	0-63 = Disabled 64-127 = Enabled
113	MIDI Note Mode	0-41 = Off 42-83 = Absolute 84-127 = Relative
114	MIDI Tap Tempo A	Any CC Value = a tap
115	MIDI Tap Tempo B	(value > 63) = a tap
117	Time/MIDI LED Select	0-63 = Time LED 64-127 = MIDI LED
119	Enable Mod Wheel to LFO Amount	0-63 = Disabled 64-127 = Enabled

LFO CLOCK DIVISIONS (CC#71)

CC#71 VALUE	CLOCK DIVISION	CC#71 VALUE	CLOCK DIVISION
0-5	4 Whole	64-69	1/2 T
6-11	3 Whole	70-75	1/4
12-17	2 Whole	76-81	1/8 Dot
18-23	WH + 1/2 Dot	82-87	1/4 T
24-29	WH + 1/2	88-93	1/8
30-34	WH + 1/4	94-98	1/16 Dot
35-40	WH	99-104	1/8 T
41-46	1/2 Dot	105-110	1/16
47-52	WH T	111-116	1/16 T
53-58	1/2	117-122	1/32
59-63	1/4 Dot	123-127	1/32 T

MIDI NOTE MODES

The MF-104M delay time can be controlled from MIDI Note On messages. When this mode is enabled the unit receives a MIDI "Note On" message. The "Note ON" number determines the Delay time. The unit responds to MIDI note numbers 0 to 90. The MIDI Note On Velocity value is ignored.

In Absolute mode each MIDI note corresponds to a delay time value. In Relative mode, the delay base time is set by the Time knob, external CV, or Time MIDI CC. MIDI notes higher or lower than C4 will change the delay

time to a musical fraction or multiple of the base time (MIDI note 60/C4 does not change the delay time).

Ex: C3 doubles the delay time (and pitches down any audio in the delay line by an octave) and C5 halves the delay time (pitching any audio in the delay line up by an octave).

DELAY TIME MULTIPLIER

The Delay Time Multiplier multiplies the delay time by 2, 4 or 8 vastly extending delay time. This feature is for obtaining unusual/lo-fi echo effects. When the delay time is increased past the default maximum delay time available on the front panel, the BBD Clock signal will be audible.

MIDI CLOCK SYNC

Both Delay Time and LFO Rate can be synchronized to MIDI System Real-time Clock messages. These messages are 24 ppq messages that can be sent via MIDI computer sequencers or from drum machines. To enable the sending of these messages, consult the user manual for your MIDI device. When the Analog Delay receives MIDI Clock messages, the corresponding LED turns Orange to indicate that it is synchronized to the MIDI Clock tempo. When the LFO is synchronized to a MIDI Clock tempo, the LFO can be set to divisions of this tempo. This is either from the front panel LFO Rate control, or from MIDI CC# 107. Delay Time MIDI sync is enabled via CC# 89.

Note: Delay Time MIDI Clock Sync overrides MIDI Note Mode. If the Delay Time is synchronized to MIDI Clock, then time changes due to MIDI Note Mode are ignored.

MIDI SYSEX MESSAGES

Used for updating or finding out the unit's firmware version. For more information about this, refer to user notes with any firmware updates posted in the Analog Delay section of the Moog Music website.

CONTROL VOLTAGE INPUTS

- All CV input jacks are 1/4" tip-ring-sleeve phone jacks. The sleeve is grounded and the ring terminals are supplied with +5 volts which is current-limited. The tip terminals receive the variable voltages from the pedals.
- An expression pedal for use with the MF-104M should contain a 50K Ohm or lower linear taper potentiometer.
- Applying a varying voltage to a pedal control input jack has the same effect as turning the corresponding knob. With the panel controls set to mid-position, a voltage control of about 5 volts is equal to turning the corresponding knob through its entire range.
- Note that with the Analog Delay, you may use standard TS cables for control voltages at the same time as Expression pedals.



WARRANTY AND SERVICE INFO

LIMITED WARRANTY

Moog Music warrants that its products will be free from defects in materials and workmanship, and shall conform to specifications current at the time of shipment, for a period of one year from date of purchase. During the one-year period, any defective products will be repaired or replaced, at Moog Music's option, on a return-to-factory basis. This Warranty covers defects that Moog Music determines are no fault of the user.

RETURNING YOUR MF-104M FOR REPLACEMENT/REPAIR

You must obtain prior approval and an RMA number from Moog Music before returning any product to us. Wrap your MF-104M carefully and pack it with the power adapter in its original carton. The warranty will not be honored if the product is not properly packed. Send it to Moog Music with transportation and insurance charges paid. A reasonable cost for service, materials and return freight will be charged to replace materials defective through the fault of the user, or for which the one year warranty period has expired. Transportation and insurance charges from Moog Music to your United States address, of products repaired or replaced under warranty will be paid by Moog Music.

Note: Specifications subject to change without notice.

Moog®, and Moogerfooger® are registered trademarks of Moog Music Inc.

©2012 Moog Music Inc

MOOG MUSIC INC. 160 Broadway St. Asheville, NC 28801

P: (828) 251-0090 **E:** info@moogmusic.com **W:** www.moogmusic.com