

MESA/BOOGIE[®]

TRANSATLANTIC[™]



TA-30[™]

Owner's Manual

Hello from the Tone Farm

Congratulations on your choice of the TransAtlantic TA-30 and Welcome to the MESA/Boogie Family. The instrument you have chosen may well redefine the Brit amp genre by including preamp and power options that seem near impossible for an amplifier with such a humble footprint and manageable poundage. This TransAtlantic follows the architecture of its lower powered sibling, the TA-30, that's been blowing the minds of critics and players alike and adds a more robust power section, gorgeous tube Reverb and an assignable/bypassable Effects Loop. The extra horsepower and feature set on the TA-30 brings the TransAtlantic concept - and more importantly Tone - out of the studio and into the world of pro gigging.

Two footswitchable Channels navigate the Atlantic with stylistic flair and give you a passport to the best British and American preamp sounds in two straightforward groups of five controls. The Five Preamp Modes (2 in Ch.1 and 3 in Ch. 2) are selected with a simple mini toggle located in the top position of stacked toggles in each Channel. Along with this array of iconic preamps the TA-30 offers three amazing power choices in each Channel, each of which allow you to perfectly tune the power to enhance the preamp Mode chosen for a given footswitchable sound. The result of all this flexibility is a fully capable live-performance amp with an uncanny sense of direction; that can also be switched down to 15 watts for lower volume power-clip applications or late-night sessions.

Our 40 year commitment to excellence along with our solemn promise to musicians - to treat each of them as we ourselves would wish to be treated - guarantees you an experience that will make you feel truly justified in your choice. We're confident your new amplifier will have you smiling and inspired within minutes of plugging in for the first time. However, what's really gratifying is that you will be finding new and inspiring sounds years after the price of admission has faded from memory and the TRANSATLANTIC continues to unveil its true worth.

It's with our sincere thanks for trusting us with your TONE and our best wishes for all your musical endeavors that we welcome you home. Should you ever need assistance or guidance we're here to help. You now have in your hands an instrument of limitless expression. Our hope is that it takes you and your playing to new and unimagined places throughout your musical journey. From all of us here at MESA...Enjoy!

TRANSATLANTIC™

TABLE OF CONTENTS

OVERVIEW _____	1-2
HELPFUL HINTS _____	2-3

FRONT PANEL CONTROLS & FEATURES

THE MODES: NORMAL, TOP BOOST _____	3
THE MODES: TWEED, HI 1, HI 2 _____	4-5
POWER MODES: MULTI-WATT POWER _____	5-6
INPUT _____	7
FOOTSWITCH _____	7
VOLUME / GAIN _____	7-8
GAIN / PULL BOOST _____	8
TREBLE _____	8-9
BASS _____	9
REVERB _____	9
FX & REV / BYPASS _____	10
CUT / PULL MASTER _____	10-11
CHANNEL SELECT _____	11
MASTER: CHANNEL 2 _____	11
POWER: OFF / ON & STANDBY _____	12

REAR PANEL CONTROLS, SWITCHES & JACKS

A.C. RECEPTACLE _____	13
FUSE _____	13
SEND / RETURN _____	13
SPEAKERS _____	14

FACTORY SAMPLE SETTINGS & PERSONAL SETTINGS SHEETS _____	15-18
TUBE MAINTENANCE & DIAGNOSIS _____	19-23
BIAS ADJUSTMENT: A feature article by Randall Smith _____	24-26
SPEAKER IMPEDANCE & POSSIBLE HOOK-UP SCHEMES - Amps to Speaker Cab _____	27-32
TRIODES, PENTODES & IRISHMEN: A feature article on the workings of tubes _____	33-35
TUBE DESCRIPTION & TASK CHART _____	36
PARTS SHEET _____	37

IMPORTANT SAFETY INSTRUCTIONS

Read these instructions.

Keep these instructions.

Heed all warnings.

Follow all instructions.

Do not use this apparatus near water.

Clean only with dry cloth.

Do not block any ventilation openings. Install in accordance with the manufacturer's instructions.

Do not install near any heat sources such as radiators, heat registers, stoves, or other apparatus (including amplifiers) that produce heat.

Do not defeat the safety purpose of the polarized or grounding-type plug. A polarized plug has two blades with one wider than the other. A grounding type plug has two blades and a third grounding prong. The wide blade or the third prong are provided for your safety. If the provided plug does not fit into your outlet, consult an electrician for replacement of the obsolete outlet.

Protect the power cord from being walked on or pinched particularly at plugs, convenience receptacles, and the point where they exit from the apparatus.

Only use attachments/accessories specified by the manufacturer.

Unplug this apparatus during lightning storms or when unused for long periods of time.

Refer all servicing to qualified service personnel. Servicing is required when the apparatus has been damaged in any way, such as power-supply cord or plug is damaged, liquid has been spilled or objects have fallen into the apparatus, the apparatus has been exposed to rain or moisture, does not operate normally, or has been dropped.

To insure proper ventilation always make sure there is at minimum four inches (101.6mm) of space behind the rear of the apparatus. The ventilation should not be impeded by covering the ventilation openings with items, such as newspapers, tablecloths, curtains, etc. Do not impede ventilation by placing objects on top of the apparatus which extend past the rear edge of its cabinet.

No naked flame sources, such as lighted candles, should be placed on the apparatus.

The apparatus shall not be exposed to dripping or splashing and no objects filled with liquids, such as vases, shall be placed on the apparatus.

WARNING: To reduce the risk of fire or electric shock, do not expose this apparatus to rain or moisture.

The AC plug is the mains disconnect. The plug should remain accessible after installation.

WARNING: EU: permission from the Supply Authority is needed before connection.

WARNING: Always make sure proper load is connected before operating the amplifier. Failure to do so could pose a shock hazard and may result in damage to the amplifier.

Do not expose amplifier to direct sunlight or extremely high temperatures.

Always insure the amplifier is properly grounded. Always unplug AC power cord before changing fuse, tubes or removing chassis. Use only same type and rating when replacing fuse.

Avoid direct contact with heated tubes. Keep amplifier away from children.

To avoid damaging your speakers and other playback equipment, turn off the power of all related equipment before making the connections.

Do not use excessive force when handling buttons, switches and controls. Do not use solvents such as benzene or paint thinner to clean the unit.

Always connect to an AC power supply that meets the power supply specifications listed on the rear of the unit. Export models: always insure unit is wired for proper voltage. Make certain grounding conforms with local standards.

YOUR AMPLIFIER IS LOUD! EXPOSURE TO HIGH SOUND VOLUMES MAY CAUSE PERMANENT HEARING DAMAGE!

Your Mesa/Boogie Amplifier is a professional instrument. Please treat it with respect and operate it properly.

READ AND FOLLOW INSTRUCTIONS OF PROPER USAGE.

TRANSATLANTIC™

Instruction Manual

Overview:

While the TA-30 control layout is rather sparse (for a MESA), there is a lot more going on internally than might be apparent at first glance. Make no mistake, this is not a low line offering, but rather a power experiment in the world of simplicity. In every way the TA-30 stands proud alongside our larger multi channel offerings with the same components, build quality, versatility and performance... an equal in every way except weight and mass.

The two Channels offer Mode choices that roam the Atlantic with Channel 1 focusing on the British side of the Pond and Channel 2 incorporating both British and American sounds.

Channel 1 offers two Modes that pay tribute to the Vox heritage; a lower gain NORMAL Mode that delivers shimmering higher head-room clean sounds and TOP BOOST, our take on one of the most iconic Brit sounds ever, that excels at clipped rhythm and lead sounds. Channel 2 packs three selectable Modes and this Channel alone offers more stylistically divergent landscapes than many whole amps. TWEED follows the Southern Cal vintage line to deliver gorgeous clean chording sounds that have more low end and breathy air than Channel 1 NORMAL - and yet clips smooth and furry when pushed. From there HI 1 jumps back to the U.K for a Brit style higher-gain Mode that, when set lower, romps on vintage crunch rhythm sounds with stripped urgency. HI 1 also delivers searing high gain solo sounds that retain a crisp, definitive attack as the GAIN control is cranked. Finally, another crossing and you're back in Petaluma, CA for the smooth warmth of the high gain Boogie lead voice found in HI 2. This Mode adds low-end girth and sweetens the attack frequencies to produce a fatter, rounder tone that is great for single note work.

The TA-30 incorporates a new GAIN BOOST feature in Channel 2 that takes it into new and uncharted waters, enabling it to scuttle even the most extreme Rock and Metal sounds with one well-aimed pull on the GAIN pot trigger. This boost of gain empowers all three Modes in Channel 2 and delivers a take-no-prisoners assault on the senses...especially in HI 1 AND 2.

Add to all this preamp versatility our patented Multi-Watt Power and you have the ultimate tools to craft a sound that is all yours. Multi-Watt allows you to match one of three perfect power-response characteristics to each of the Modes and footswitch between two iconic sounds.

FRONT VIEW: TRANSATLANTIC TA-30

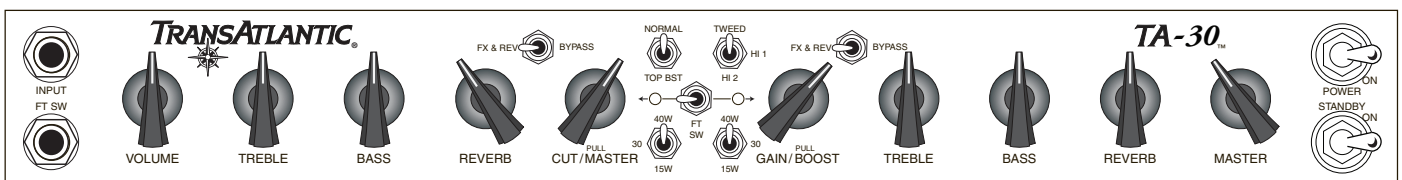

REAR VIEW: TRANSATLANTIC TA-30 Combo



REAR VIEW: TRANSATLANTIC TA-30 Head



OVERVIEW: *(Continued)*

The 15W position on the Multi-Watt™ mini toggle in each Channel captures the old world magic of 15 watts running in Class A which - along with being ultimately clippable - emphasizes a truly precious blend of warmth and lined-up, chiming harmonics at low playing volumes.

The 30 watt setting brings aboard two more tubes while remaining in Class A while it pumps up the wattage for the perfect blend of iconic vintage response, manageable power and sweet, smooth clip.

From there things take a leap forward in time and power to our Patented Dyna-Watt™ power in the upper 40W position. This incredibly dynamic power scheme switches the wiring style to Class AB and allows the headroom to increase dramatically by unleashing a burst of power at the instant of attack. Voltage is stored-up and released in a time-specific burst from the power supply continuously as you play, creating punch headroom and tight-tracking authority well beyond your expectations.

The Hard-Bypassable Series Effects Loop allows you to interface outboard processing without degrading your signal for effects such as chorus, delay flange or anything that doesn't sound right on the "front end" (between the guitar and amp). The TA-30's Loop works well with both Pedal and Rackmount processors and provides ample headroom and drive to accommodate both with Toneful finesse. All this control over both the preamp architecture and power section wiring styles combined with the simplicity of the Gain and Tone Controls create a package that allows for instant gratification and long-term exploration. How you choose to enjoy the Trans Atlantic is your call, but we feel confident that no matter what type of stylistic arena you find yourself in, the tools are here for you to craft your own signature version of these classic sounds.

HELPFUL HINTS:

1. Cut the cable tie that holds the AC Power Cord to the Rear Tube Cover and connect it to a Grounded AC wall socket.
2. Connect the Stereo ¼" Footswitch Cable to the Front Panel ¼" jack labeled FOOTSWITCH using the supplied Stereo Cable.
3. Set the amplifier (and at least one speaker cabinet) on the floor you will be standing (or sitting on) while playing to complete the coupling circle that occurs. This will make the amplifier sound better, as well as feel better to play, because the sympathetic loop created by the transmission from your hands to the guitar to the amp to your guitar to your hands remains unbroken.
4. Remember that when you are setting up the controls for Mode Switching with the Footswitch, using the controls in their middle to upper middle ranges (11:00 – 2:00) will provide the best Tone and volume levels between the Modes. This region helps the compromise between sounds remain as small as possible.
5. When powering up (especially from cold), always allow the power tubes time to warm up before hitting them with high voltage (STANDBY ON and playing). Turn POWER to ON, wait at least 30 seconds, then turn STANDBY to ON.
6. The center mini toggle labeled FT SW provides manual access to the Channels when the Footswitch is not connected. Left calls up Channel 1, right calls up Channel 2. **To use the Footswitch to access the Channels, select the FT SW (center position) and connect the Footswitch to the jack on the left bottom of the Faceplate labeled FT SW.**
7. A good general rule to follow; As the GAIN goes up, the BASS should come down. This will help prevent low-end flub and tubbiness and keep the attack tracking tighter. This is especially true in the TOP BOOST Mode of Channel 1 and the TWEED Mode of Channel 2 when searching for pushed sounds that lie somewhere between clean and dirty.
8. The CUT control in Channel 1 has a PULL MASTER function that allows you to run with the traditional "no master" architecture or, pull the CUT control and use that pot as a MASTER volume control for more overdriven sounds at lower playing volumes. When in the MASTER-Active mode, the CUT control is hard-wired to a medium setting that is balanced between open and compressed.

HELPFUL HINTS: (Continued)

9. You will experience more footswitching noise (pop) when switching between Channels when only one is set to the 15W power setting. This is due to the more radical voltage changes that occur when knocking the power section down to the 15W level from one of the higher power modes. (Using both Channels in 15W will not create excess noise as the voltage doesn't change). May we suggest when configuring your Channels for live performance footswitching applications, try using the 30 and 40W power modes whenever possible as the voltage swings are not as great. This will provide the quietest footswitching performance.
10. It is normal to experience a slight increase in background hum when using the 30 watt Power Mode in Channel 1 NORMAL and TOP BOOST. This is a result of the power amp "listening harder" to the preamp because the Class A wiring of this Power Mode has the output tubes biased "more on" even when they are not amplifying a signal.

Now that you have an overview of the **TA-30**, let's get more specific with the Modes and controls to learn how they can help you achieve the sounds you are looking for.

THE MODES:

CHANNEL 1:

NORMAL: This mode takes its architecture from the TOP BOOST circuitry and removes gain, adds brightness and fills out the bottom with a little more air and dimension. It works best for clean work and provides substantially more headroom than TOP BOOST.

NORMAL is the choice when you need more stripped urgent clean sounds that will tuck up nicely in a mix. It is probably not the best choice for overdriven or clipped rhythm sounds as there is not quite enough gain to smooth out the jagged edges, and because of the added brightness it can sound a bit toward the ragged and buzzy when pushed too hard, especially with weaker pickups.

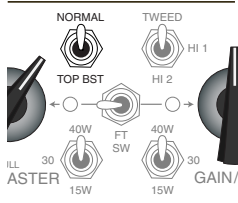

TOP BOOST: This Mode represents our tribute to the amazing legacy of the British darling VOX. The TOP BOOST circuit has appeared in countless Boutique renderings of the last 20 years and is considered one of the must have staples in classic Rock guitar. Out of respect we chose to refrain from treading on this hallowed ground until such time as we could bring something worthwhile to the party... not to simply duplicate, but rather enhance this iconic sound. Well, with the inclusion of our patented Multi-Watt™ Channel Assignable Power and several other "trade secrets" we've unearthed over the last 40 years of amp design, the time has come to redefine a classic. Only you can be the judge if we've added something beautiful to the original, but our comparisons and the comments of our brothers in tone around the world... including our English ones, leave us feeling pleased with a job well done.

TOP BOOST is great for many things from urgent jangly cleans with a bit of attitude, to full on saturated solo sounds, but probably its greatest asset is seen when riding the edge of clip. This Mode can transition almost seamlessly from clean to saturation with just the input from your pick - for there are many subtle graduations in the **TA-30** within this historically small realm that now widen it to create an entire empire - instead of a narrow, hard to fine-tune border region.

The choices found in the Multi-Watt Power switch greatly expand this edge of clip area and adds color to the mix along with harmonic and volume changes. For the most traditional response the 15 and 30W settings will provide the best blend of characteristics and the

THE MODES: (CONTINUED)

best balance of volume versus clippability. If you've ever played an AC 15 or AC30 you will instantly fall into familiar territory where the subtle changes in your picking can push things in and out of clip with amazing expression. The 15W and 30W Power Modes also work well with TOP BOOST for using the guitar's Volume control to take you from clean to varying degrees of saturation by rolling up and down without losing the sweet harmonic top end spectrum.

The 15W Power Mode will provide a sweeter blend of upper harmonics and allow you to bring the onset of clip down to lower volume levels. Watch the BASS control setting in 15W as the lower power is not capable of managing high levels of GAIN and BASS together. If you intend to run the GAIN control high when in 15W, don't be surprised to see your BASS control below 10:00 – or even off – to achieve tight tracking bottom end response. The (Dyna-Watt) 40W Power Mode will respond the opposite way and allow you to run both GAIN and BASS higher than in either 15W or 30W Modes. This mode is probably better suited to when you are using TOP BOOST for either really clean (GAIN 10:00 or below) or really heavy sounds (GAIN above 3:00) where you need the bottom end tight and percussive. In these two regions the extra power and headroom, along with the accentuation in the upper mids that comes with this burst of attack-instant-voltage-release, really focuses things and adds authority.

CHANNEL 2:

TWEED: This is the lowest gain of the three Modes in Channel 2 and is aimed at clean and edge of clip sounds. It draws the framework of its circuit architecture from the early tweed amps from Southern Cal and then gets a healthy dose of magic from the 40 years of little secrets we've discovered to arrive at a beyond vintage level of Tone and performance.

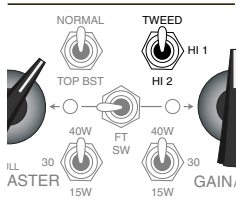

When using TWEED for clean work the 30W and 40W (Dyna-Watt) Power Modes provide the best blend of sparkle, warmth and headroom – with the 40W being the obvious choice for live performance high headroom clean situations. To explore the world of soft clip sounds in TWEED, set the GAIN high (3:00 – 5:30), the BASS low (8:00 – 10:30) and ponder the differences between 15W and 30W until you find just the right response for your needs.

Just keep in mind that it is always a good idea when looking for overdriven sounds, especially in the TWEED and NORMAL Modes, to reduce the BASS setting as you increase the GAIN control. This will avoid flubbiness and keep the attack tight and focused.

HI 1: We're back across the water again for a high gain tribute to the "other" great British amp and HI 1 captures all the tight attack, thumpy, tight bottom and midrange cut that these amps are famous for. HI 1 is the choice anytime you need attack and a higher, quicker feeling bottom end response.

Many players prefer this circuit for crunch or overdriven rhythmic playing, citing its percussive nature tracks tighter in the hands and is more defined in a mix. It also shines for use with shorter scale mahogany guitars that have a woodier, throatier top end and more lower midrange as a dominant part of their character.

When looking for single note solo sounds in HI 1 it may be necessary to run the TREBLE a little lower than you would for high gain chording, say somewhere in the 9:30 – 10:30 range to soften the attack and round out the notes a bit for a smoother more vocal character. When dialing up lower gain sounds in HI 1, whether for chording or lead work, try setting the BASS rather high - 1:30 – 3:30 – to add air and girth to the sound. In general you can apply the BASS a little more liberally in HI 1 than in some of the other Modes as the increased upper midrange attack present here will keep things tighter longer and the frequency of BASS is a bit higher than in HI 2, so it can follow the attack a little easier in the time domain.

As far as power-matching, HI 1 is pretty friendly with all three choices, however 30W and 40W showcase the classic Brit response best with 30W leaning toward smoother soloing and 40W excelling at tight percussive chording. The 15W position works good for lower to medium gain soloing, but don't expect it to be as tight or percussive for the rhythmic work as the two higher power Multi-Watt Modes.

THE MODES: (CONTINUED)

HI 2: Grab your suitcase, as again we cross the Atlantic on our tour of the world's most classic guitar sounds. This time we're back to Sonoma County, famous for wine and high gain guitar sounds. HI 2 is all about Boogie. Smooth, round attack, molten sustain and lined up layers of harmonics. This Mode is all about soloing. While you are welcome to explore its virtues for chording, it is single notes that most benefit from the deeper lows, slightly tucked mids and higher harmonic landscape found in this classic sound.

In the Trans Atlantic however, for continuity's sake, we've leaned just a pinch in the direction of HI 1 – slightly higher mid frequencies, a little more attack and a touch higher BASS than in other Boogie lead modes for two reasons. First, lower power amplifiers are simply not capable of pushing (steering/controlling) sub-low frequencies like their high power counterparts. They choke and lose definition when the BASS is too low and use all their available power trying to drag the low frequencies around. Second, guitarists – for the most part - are extremely conservative when it comes to sounds. Since most of us grew up listening to the same references, we want to hear easily identifiable classic sounds that fit into a category when we try an amp or guitar. We've seen over the years that players tend to stumble when there is a sound or mode in an amp that strays very far outside the "basic vibe" or style they perceive to be its "thing". For this reason we found it instantly more digestible to more players when we keep things more closely related.

So in HI 2 you will find all the desirable qualities of your favorite Boogie high gain Mode, but find them fine-tuned in a way that sits beautifully alongside the British flavor of HI 1. Plenty of difference to be recognizable... but not so different that it sticks out and feels out of place.

Power-wise HI 2 works well with all three Multi-Watt™ choices. For bold authority and the greatest dynamic content, the 40W Mode would be the choice. If you want a more liquid feel and more upper harmonic content, 30W is your ticket. And for all out insanity at lower volumes for tracking, there is always the 15W Mode with its greater potential to add power Tube overdrive/clip. Don't overlook the 15W setting for lower gain solo sounds... especially in the studio. Some awesome lower gain Blues sounds are possible by setting the GAIN control low, say 10:00 – 11:00 and cranking the MASTER in the 15W Mode. You might have to reduce the BASS a bit to keep the attack focused, but it's very expressive with a different harmonic signature than getting all the gain from the preamp.

POWER MODES: MULTI-WATT™ POWER

While the **TA-30** is a veritable treasure chest of preamp sounds with the five different circuits tucked away in its hold, the Tone shaping choices don't, by any means, stop there. We always say "it's 50% front end and 50% power". The power section in any amp has a great deal to do with its response, character and feel and the TA-30 is just as well endowed in the power play as it is with preamp choices.

Our patented Multi-Watt™ Power allows not only the choice of Class of Operation, but also a choice in Wiring Configuration. You get three distinctly different power sections – each with its own character and feel to link - per Channel - with the preamp sounds you have crafted.

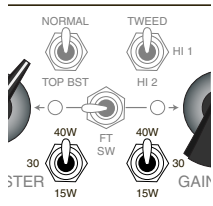

The **TA-30** steps up the power of the TransAtlantic™ platform and brings it to a stage-ready place that can cover all but the largest venues without the need for additional power. The patented Multi-Watt™ feature on the TA-30 climbs the power scale by adding two more power tubes that create everything from classic 15 and 30 watt CLASS A choices, to our patented Dyna-Watt™ Power that pumps out 40 watts of almost unbelievable headroom for this output rating. Dyna-Watt™ has been appearing on lower power MESA amplifiers since 1986

when we released our STUDIO 22 combo. We've been using it ever since to shock people with an instantaneous burst of headroom and power present at the attack of the notes.

Here in the 40 Watt Mode, a "surplus" of voltage is "stored-up" in the power supply and released in a flash – creating an instantaneous burst of headroom - each time you hit the strings. This added headroom keeps the attack explosive and exciting. Then, as the power supply is charging back up, you feel a juicy sag on the strings – just for an instant – and your fingers rejoice in an easy to play, yet powerful-sounding dance within this time-specific field of electricity.

THE MODES: (CONTINUED)

Be sure to check out the 40 Watt Mode for clean sounds in Channel 2 TWEED and tight-tracking crunch rhythm in HI 1. The headroom and faster response of Dyna-Watt™ really empowers these two Modes and creates some bold, punchy and tight-tracking sounds.

15 WATT This setting uses two of the four power tubes wired in CLASS A to produce the ultimate in sweet vintage clip-ability. This Mode, while it doesn't possess the headroom of the other two choices, does transition to clip in a truly magical way. The soft-clip region that appears before the sound becomes totally saturated is especially great for furry chording and purring, smooth single note work. Both Modes in Channel 1 and the TWEED Mode in Channel 2 work extremely well for these styles and showcase the true expressiveness of this iconic power displacement.

30 WATT Also wired in CLASS A, the 30 Watt Mode utilizes all four output tubes for a bolder, tighter, more powerful version of this classic Brit-style power section. With an obvious tip of the hat to the historically important AC30, the TransAtlantic allows you to apply this vintage magic to all of the Preamp Modes in the **TA-30** with equal and wonderful results. The added power of these "American-voiced" preamp modes allows you to roam the globe instantaneously and use the 30 Watt Power Mode to create your own signature sounds that combine the best qualities of both continents, amp-wise.

Be sure to check out the 30 Watt Mode for higher volume clipped rhythm sounds in both Modes of Channel 1 and single note solo sounds in TOP BOOST. It also works great for clipped rhythm sounds in TWEED of Channel 2. Definitely explore the possibilities in HI 1 and 2 as well, for this higher power, more gutsy CLASS A output delivers some "wickedly sweet" solo sounds with the right blend of preamp gain and output drive.

40 WATT This Mode is all about punch. As mentioned in the intro to this section, Dyna-Watt™ delivers punch when you need it – at the attack of the note, and soulful little-amp bounce and sag as the note decays. This time-specific power response creates an output section of incredible versatility. It shines for clean rhythm work because it shovels horsepower when you need to cut through the mix, but also allows the sound to retain its vintage character and easy to play, inviting feel. Dyna-Watt™ adds chameleon-like adaptability to the overall package, allowing you to tune the power response to produce bold and authoritative statements that don't hurt and sound harsh. This patented Power Mode will widen the palette of sounds at your disposal as it works equally well for both clean and overdriven applications.

Of special note are the Dyna-Watt™ applications for the NORMAL Mode in Channel 1 and all the Modes in Channel 2. The added tight-tracking presence of the 40 Watt Mode enhances the clean sounds in NORMAL and TWEED - adding punch and headroom - while also keeping the bass frequencies tighter and adding aggressive mids for high gain work in HI 1 and 2.

FRONT PANEL: Controls & Features

INPUT: This is the instrument **INPUT** jack. This jack feeds the preamp and since the *TRANSATLANTIC* is a high gain amplifier and therefore very sensitive, always use a high quality shielded cable between the instrument and the amplifier. This will prevent unwanted noise and microphonic cable sounds.

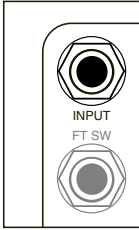

FOOTSWITCH: This 1/4 inch stereo jack is for connection of the Channel Select Footswitch. When the **FOOTSWITCH** is connected here with the provided stereo cable, the Channels and FX Loop can be controlled remotely.

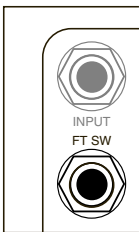

VOLUME / GAIN: These are the main front end controls in the preamp, no matter what Channel or Mode you are in, and they meter the amount of tube drive or saturation present in the signal. These controls are called by different names (**VOLUME**) in Channel 1 and (**GAIN**) in Channel 2, but they function in the same way and do essentially the same job... control the gain in the preamp. Their location in the circuit moves around depending on which Mode is called up, but their function remains the same - they determine the attack character, headroom and ultimately – how clean or dirty a given sound will be. For simplicity, from here forward we will use the word **GAIN** to speak of the front end control in both Channels - even though it is labeled **VOLUME** in Channel 1.

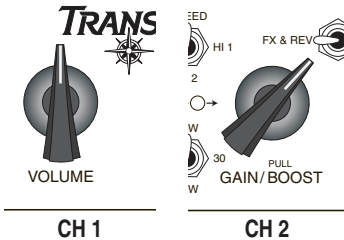

The **GAIN** also brings in and out upper harmonic content, depending on where it is set. As a general rule, the lower the setting – the more upper harmonics there are passing through. As you increase the **GAIN**, the natural tube saturation and compression fills in the sound, making things darker and more “round”. This trait can be used to your advantage – and in fact serves the practical applications well – as it means that lower gain clean sounds remain open and dynamic with abundant harmonics, while higher gain lead sounds get more compressed, warmer and more vocal.

Using the **GAIN** control tastefully, with finesse and always with the Power Mode choice in mind is critical to achieving the best overall Tone. Unlike a 100 watt amplifier, the *TA-30* is often adding some amount of overdrive or soft-clip into the mix – that’s part of its mid-wattage attraction – so it’s crucial to take that into account to keep your attack intact and preserve the dynamic content of your sound.

IMPORTANT ! Many of the *TA-30*’s best sounds are found with the **GAIN** control set in its middle range – somewhere in the 11:00 – 2:00 region. You’ll be pleased to discover all the nuance and expression found here – especially when you learn to use the Power Modes as part of your Tone Crafting regimen. You’ll quickly find so much shaping power across those three hours (11:00 – 2:00) on the **GAIN**’s Tone Clock that you may seldom roam the higher regions as the balance between preamp and power is truly magical here.

If you do need to run the **GAIN** in its upper region for high gain heavy styles, then your best plan of action is to stick with the **40W Power Mode** - as this will keep the low end as tight as possible and track the dynamic passages with more accuracy. However,

FRONT PANEL: Controls & Features *(Continued)*

don't expect the same type of response you would find with these heavier sounds as you would from a 100 watt amp. The **TA-30** is indeed mighty in its class... but those little EL84's can't handle massive amounts of both preamp gain and huge low end like an amp running the larger octal-based 6L6 or EL34 type power tubes. Running the GAIN control high in the 30W and 15W Modes is perfectly fine to do, it just won't keep the attack as focused... especially when you increase the playing loudness.

NOTE - CHANNEL 1: In Channel 1 the VOLUME control is both the front end (GAIN) control and the playing loudness or "master" control as well. We wanted to pay tribute to these sounds in the most reverent way and there was no master volume control on the original amplifiers - so as you turn up the VOLUME control in CHANNEL 1 - you are adding (gain) saturation AND turning up the playing volume. Purists have long identified with this "no master" scheme - citing its more urgent response, clarity and dynamic touch sensitivity. We agree with these observations to some degree - for these types of circuits - but there is little doubt that the trade-off for this stripped "no-master" approach is difficult to overlook when it comes to the flexibility department.

So we gave you a choice by including a cool new feature for this type of circuit. When you need the old-school response of the original "no-master" scheme and the gain versus volume issues that inherently arise from this scenario are not a problem... crank it up and Rock!

But for those times when you **do** need control over the gain and saturation independent of the playing volume... pull the CUT control out and... problem solved, you now have a MASTER volume control! The CUT is preset to about 1/3 of the way on (rolling off just a little top end) and the same pot now functions as a fully independent MASTER volume control.

Again... **Pushed In, the CUT/PULL MASTER control functions as a CUT control** (rolling off high frequencies as you increase the control clockwise - almost like a reverse PRESENCE control). **Pulled Out, the CUT/PULL MASTER control becomes an independent MASTER volume.**

This "mod" to the original "vintage" architecture greatly enhances the flexibility of both NORMAL and TOP BOOST Modes and allows you to use them for many more sounds and footswitchable scenarios. It opens up the landscape for these sounds to be applied in new ways and allows them to interface to the modern world of footswitchable sounds and yet retain their expressive charm and harmonic identity.

CHANNEL 2: GAIN / PULL BOOST

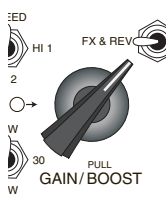

The **TA-30** incorporates a new GAIN BOOST feature appearing as a pull-pot on Channel 2's GAIN control. This powerful feature takes the **TA-30** into new and uncharted high-gain waters, enabling it to scuttle even the most extreme Rock and Metal sounds with one well-aimed pull of the GAIN pot pull-trigger. The boost of focused gain across a well defined region empowers all three Modes in Channel 2 (though slightly less radical in TWEED) and delivers a take-no-prisoners assault on the senses...especially in the HI 1 and 2 Modes. Just remember to adjust the BASS control accordingly - especially as you use the BOOST in the higher region of the GAIN control to avoid flubbiness and retain the focus and clarity of the attack.

TREBLE:

This control, while being the second most powerful control in the preamp, is very simple to operate... and when you've dialed in a little too much, it's easy to tell right away. The TREBLE controls how much of the high frequencies in the preamp will be blended into the signal. This is another control to use in the middle ranges to produce the best balance of tone and noise. The TREBLE can bring in unwanted noise (hiss) when set to the extreme high end of its range (3:00 - 5:30) so avoid setting the TREBLE this high whenever possible.



Like the GAIN, the best sounds are found with the TREBLE in its middle range where an equal blend of highs from here are mixed in with the lows from the BASS (and GAIN). If you need things brighter in CHANNEL 1 - try leaving the CUT control set low (9:00 - 7:00). The top end that comes from there comes later down the line in the signal path - closer to the power section - and will produce less likelihood of noise and task the preamp tubes less.

FRONT PANEL: Controls & Features *(Continued)*

Very high settings of the TREBLE control will increase the likelihood of microphonic tubes to start making noise and begin ringing or feeding back. It just adds too much top end into the signal path early and this is then amplified again and again making any sensitive tubes show their weaker side. This will be most critical in TOP BOOST in Channel 1 and both HI 1 and HI 2 in Channel 2 where the higher gain present will put more scrutiny on the preamp tubes.

In the TOP BOOST Mode of Channel 1 and the HI 1 Mode of Channel 2 you may find that the TREBLE wants to be set a bit lower than in some of the other modes and it is not uncommon to find it set below 11:00 for many great sounds... especially solo tones.

BASS: The BASS is probably the simplest control on the **TA-30** and it simply dials in low frequencies to the mix in the preamp section. It is a less “volatile” Tone control than the TREBLE in that high settings will only cause an unbalanced sound, and not some other “stress” issue on the tubes. There is not really even a danger in speaker damage due to extreme settings as there might be in some higher power amps - as the power available in the **TA-30** is not usually considered high enough to be dangerous to most speakers with the exception of possibly the most extreme volume settings in the 40 watt Power Mode with low wattage speakers.

VTIC™



BASS

Really, the main thing to keep in mind regarding the setting of the BASS control is to avoid dialing in too much and creating a flubby sound with compromised attack characteristics. Remember the old rule we mentioned earlier in the HELPFUL HINTS section... as the GAIN goes up the BASS should come down. While this is pretty general and maybe too all-encompassing, keeping it in mind will help you get to a great sound faster.

It is especially important not to run the BASS too high when searching for clipped sounds in the NORMAL (and sometimes TOP BOOST) Mode of Channel 1 and the TWEED Mode of Channel 2. When the GAIN is maxed out here things can get kind of ugly in the low end fast.

REVERB: This rotary pot controls the mix of the REVERB effect and allows you to dial in the perfect amount of sweet, all-tube, analog spring Reverb. This control will only affect the sound when the REVERB circuit is switched into the signal path by taking both the REVERB and EFFECTS LOOP out of the BYPASS Mode. To activate the REVERB and the EFFECTS LOOP, select FX & REV on each Channel’s REV/LOOP mini-toggle just to the left and right of the center cluster of Preamp and Power switches.

FX & REV



REVERB

Any amount of the Reverb effect can be dialed in here... from a faint, ambient background embellishment all the way up to a fully drenched “surf” effect where the notes swirl in a cavernous wash of ringing harmonics.

There is a REVERB BYPASS jack on the Rear Panel (Bottom Rear Of Combo Chassis) that accepts a standard ¼ “ phono plug and by connecting a simple tip-to-ground type latching switch to this jack the REVERB can be triggered on and off. The EFFECTS LOOP must still be in the circuit for the REVERB to work and triggering this REVERB jack with the FX & REV switch in BYPASS will not turn the REVERB On.

NOTE: REVERB Footswitches are available through your local MESA/Boogie Dealer or if you live too far from one, from us directly.

NOTE: USE ONLY SHIELDED CABLE FOR THE REVERB BYPASS FOOTSWITCH.

FRONT PANEL: Controls & Features *(Continued)*

FX & REV / BYPASS:

This mini-toggle is responsible for engaging both the EFFECTS LOOP circuitry and the analog all-tube REVERB circuit. With a simple flick of a switch the entire signal path is re-routed at the end of both Channel 1 and Channel 2's preamp and additional tube stages are inserted to accommodate the EFFECTS LOOP's SEND and RETURN stages as well as the REVERB's send and return path. This might sound like basic architecture found in virtually all modern amplifiers, but the TA-30 presented a huge challenge when it comes to interfacing these two commonplace insert points.

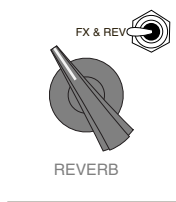

The hurdle lies in combining Channel 1- whose vintage architecture provides no place to derive or re-insert Reverb and Loop circuitry, coupled with a power section that relies on a super-sensitive “input/driver” and no negative feedback – and Channel 2 that employs a more modern power section that is less sensitive and has negative feedback. The difference in power sensitivity is huge and attaining a suitable balance between these two power section responses is very tricky. And yet essential, since the LOOP and REVERB circuitry must be mixed back in right at this junction in spite of the opposite character of their response.

Luckily that's what we been doing for the last 40 years. Solving problems just like these and creating a new way to achieve what you need when you step on the proverbial footswitch. Delivering Tone without compromise and seamless interfacing.

You will notice very little if any tonal difference between the FX & REV position of the switch and BYPASS. Countless hours went into achieving that. If you do hear a difference, it is probable that you will have the same opinion that all of us and the players we polled had... the Loop and Rev add a small amount of tube “sauce” or “juice” that is preferable as it seems to extend both Low end and high end response and increase “three-dimensionality” a tiny bit. Most leave the Loop and Rev engaged all the time.

Both SEND and RETURN jacks (found on the Rear Panel of the Head and Bottom Panel of the Combo) are switching type jacks that close (connect) the Loop circuitry when nothing is inserted (no outboard effects processing used) into the EFFECTS LOOP.

NOTE: If you intend to use the EFFECTS LOOP as a patch point – either for a preamp send (from the SEND jack) or a power amp input (into the RETURN jack) – you must have a plug inserted into BOTH SEND and RETURN jacks to open the circuit. You can just use a guitar cable and leave the other end hanging or a shorted plug... just so long as something is inserted into the unused jack.

When you engage the FX & REV circuitry and trigger the LOOP “on” from the Footswitch, you are essentially taking the SEND and RETURN jacks in and out of the signal path - meanwhile the Loop circuitry is remaining in the signal path at all times. This is essential to allow the REVERB circuit to remain in the signal path even when the Loop is not in use.

It is normal to experience an increase in background noise (hum) when engaging the LOOP and REV in Channel 1 – especially in the 30 Watt Power selection. This is a result of the increased sensitivity and added gain in the driver/power section of Channel 1.

It is also normal to experience a “trailing pop” from the Channel Select Footswitch (or manual Front Panel Toggle) when switching back to Channel 1 with a Delay (or very long Digital Reverb sounds) in the Loop. The higher the setting of the Delay mix (a very wet blend) dialed up, the more pop you will most likely experience. This “trailing pop” will be exacerbated by settings between the Channels that see the Channel1 VOLUME (and/or CUT/MASTER pulled) at a higher volume (listening) level than that of Channel 2.

This audible pop in the delay sound is again the result of added driver sensitivity and gain in Channel 1's power section and unavoidable due to it's vintage no-master circuit architecture and sonic character. This “delayed pop” is caused by the miniscule click of the switching relay being amplified greatly when switching from a return/driver stage that utilizes negative feedback and where the power sensitivity is lower gain and “more normal” (Channel 2)... to a very different return/driver stage with no negative feedback and huge gain (Channel 1).

This is one of the many challenges - and unfortunately unsolvable quirks, due to plain physics, of combining vintage architecture with

FRONT PANEL: Controls & Features *(Continued)*

modern circuitry. Perhaps this is why other builders rarely – if ever - attempt it. We took the challenge and are able to get the two extremely different styles of circuits to co-exist beautifully - and after much toil - have removed 99% of the objectionable idiosyncrasies created out of this tricky melding of opposites. For that last 1%... like we do, you will probably find the amazing palette of sounds and stylistic flexibility of this combination well worth the minor occasional distraction.

CUT (knob pushed in): This push-pull control is only found in Channel 1 and is responsible for determining the blend of high frequencies allowed to pass in the power section of Channel 1. It works backward of most controls in that when it is increased (clock-wise) you are increasing the “cut” of the high frequencies and therefore the sound is becoming darker and less bright. This takes some getting used to if you haven’t used one of these circuits before. It really is like a reverse PRESENCE control and if you think of it as such, it may help you in navigating the possibilities found here.

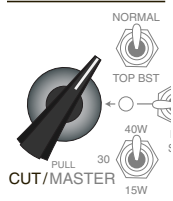

The taper of the pot used in the CUT control is a very slow one and was chosen because it is rare that you will use the control at its very highest (most rolled-off) setting. This way there is more fine resolution available to allow you to dial in just the right amount of “cut”. The only time you might find the extreme high region of the CUT appropriate is for fat single note solo sounds where it can remove huge amounts of sizzle and make things sound fat and round.

PULL MASTER (knob pulled out): As mentioned in the VOLUME/GAIN control description, the CUT control is fitted with an ingenious “mod” to the original “vintage” architecture and incorporates a pull pot that, when engaged, transforms the CUT into a MASTER volume control. When the MASTER function is engaged, the CUT is preset automatically to a setting of around 1/3 or in other words - 11:00 and this may not be altered as long as the control is pulled out and the MASTER is active.



NOTE: *If this setting just will not work for you and you need to use the MASTER ACTIVE mode for most of your applications, call us and we can send you a part for a nominal charge that - when installed by a competent technician at your expense – can either increase or decrease the “preset CUT setting” when your MASTER is active. Please work with this a while before calling us to do this though... this preset value was arrived at through extensive testing with many types of players and you may be surprised that while the CUT is not adjustable in this scenario, it works well for most sounds and styles.*

This feature greatly enhances the flexibility of Channel 1 and allows you to, unlike the original, use these sounds for an extremely wide array of both classic and modern sounds. It also allows you to create many more footswitchable Channel matches than would have otherwise been possible. And as for the purists you may come across who - in probable jealousy – try to point out the original version’s urgency, openness and dynamic character, you can politely agree, smile and then walk over and push in the MASTER and ask them if they want to try your “vintage” rendering.

When you need the old-school response of the original “no-master” circuit - and the gain versus volume issues that inherently arise from this scenario are not a problem - the original vintage architecture can’t be beat. But when you need independent control over both gain and volume, there is little doubt that whatever the (miniscule) tonal trade-off for this stripped “no-master” approach is easy to overlook when it comes with the incredible flexibility it grants in return.

FRONT PANEL: Controls & Features *(Continued)*

CHANNEL SELECT:

This toggle switch allows you to select the desired Channel when the Footswitch is not in use. As you've probably discovered, this switch operates left to right (horizontally) whereas the Mode switches operate vertically.

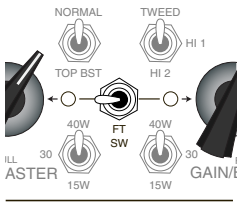

Select the center "FTSW" position to activate the Footswitch when it is connected. The center position brings up Channel 1 as the default setting.

MASTER: CHANNEL 2

This control is the volume control at the end of the preamp that enables you to control the front end preamp level (with the GAIN Control) and consequently drive and saturation amounts - independently of the playing volume. This flexibility is critical for both crafting a wide variety amazing sounds that are accessible at any volume and footswitchable compatibility between Channels.

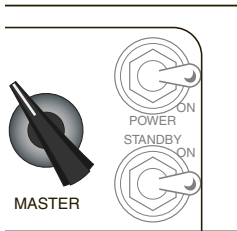

There is no real correct setting for the MASTER and no real reason not to run it either very low or very high for different applications. The most important job it handles is giving you the power to match the volume levels created in Channel 1 - whether you are using any of the three Modes in Channel 2 for a vast array of diverse footswitchable sounds from the two channels.

You may want to apply the GAIN rule here as well when using the MASTER very high with or without high GAIN settings; the higher the GAIN (and maybe MASTER) the lower the BASS setting... just to avoid flubbiness and a compromised attack.

POWER SWITCH:

This switch delivers the A.C. power to the **TRANSATLANTIC**. Make sure the unit is grounded (all three terminals of the A.C. power cord must be connected whenever possible to avoid injury to the user as well as to the amplifier). Also, make sure that the proper voltage requirements are present at the A.C. wall socket receptacle.

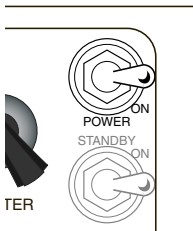

NOTE: As a reminder, *never alter the A.C. power cord in any way for possible damage to the amplifier may occur not to mention the possibility of a fire outbreak.*

STANDBY:

Perfect for set breaks... this toggle switch also serves an even more important purpose. In the Standby position the tubes are at idle so that during power up they may warm up before being put to use. Before Power is switched on make sure the **STANDBY** switch is in the Standby position.

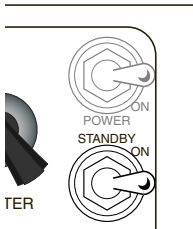

Wait at least 30 seconds and then flip the **STANDBY** switch to the ON position. This prevents tube problems and increases their toneful life substantially.

Well, that's about it for the CONTROLS. Now it's up to your sense of adventure and your willingness to explore. Whatever your style, your ability and your application, we sincerely wish you many inspired hours of discovery as you put the **TRANSATLANTIC** to good use in all your musical endeavors!

REAR PANEL:

REAR VIEW: TRANSATLANTIC TA-30 Head / Bottom Panel Combo



A.C. RECEPTACLE:

The removable “Euro” Style” A.C. cord that is supplied with the *TRANSATLANTIC* makes set-ups and tear-downs after the gig a snap. Additional heavy duty cords are available should you ever need one...simply call us and we can ship one directly to you for a nominal charge, plus shipping cost. Make sure the A.C. cord is firmly in its socket (receptacle) before powering up the amplifier.

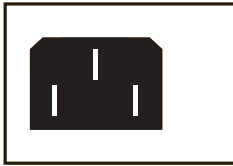

NOTE: NEVER ALTER THE THREE PRONG POWER CORD IN ANY WAY.

FUSE:

This is the A.C.'s (Alternating Current) main fuse and provides protection from outside A .C. fluctuations as well as power tube failure damage. Should the **FUSE** blow, replace it with the same rating in a Slo-Blo type package. The domestic U.S. version requires a 2 amp Slo-Blo **FUSE**. A power tube short or failure is often the cause of a blown **FUSE**...Follow the cold start procedure mentioned in the ON/STANDBY switch section and watch the power tubes as you flip the STANDBY to the ON position. If a power tube is going bad or is arcing you will see it! Flip the STANDBY switch to Standby immediately and replace the faulty power tube and the **FUSE** if necessary.



If you see nothing abnormal as you switch the STANDBY on, it is possible that a power tube shorted temporarily and blew the **FUSE**. If this is the case it may work again normally. To be safe, you might want to replace just the adjacent tube or all power tubes in the “shotgun” troubleshooting tradition and save the replaced set as spares. Spare fuses are a must for the fabled cord bag along with your spare tubes. Always carry both for they could be worth their weight in gold someday.

SEND / RETURN:

As mentioned earlier, these are the patch points for the EFFECTS LOOP and all outboard processing that is not wah, compression or gain-inducing should be connected here. Delay, Reverb, Chorus, Flange and any other time-based effects usually work better in the EFFECTS LOOP than in the guitar’s signal path (on the front-end before the INPUT).

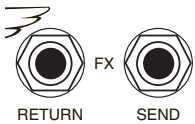

Be sure to use the highest quality shielded cable of the shortest length possible when connecting your processors to the EFFECTS LOOP. See the Front Panel Section on FX & REV / BYPASS earlier in this manual for more information.

Connect as follows:

(1st) Processor’s Input to **TA-30** SEND – (Last) Processor’s Output to **TA-30** RETURN

The **TA-30** Footswitch will toggle the SEND and RETURN jacks on and off when the FX & REV / BYPASS Front Panel switch is set to “FX & REV”. The FX button on the Footswitch will only respond to take the effects in and out of the mix when the Loop circuitry is engaged via the Front Panel.

NOTE: Remember that both *SEND* and *RETURN* jacks are “switching type” and both must be “opened” with a patch cable for the *SEND* to be used as a “preamp output” or the *RETURN* to accept a “power amp input” signal. See Front Panel section under FX & REV / BYPASS for more information.

REAR PANEL: (Continued)

SPEAKERS:

This section is dedicated to speaker outputs and as you see there are two different speaker impedances provided for with combinations that allow for most common guitar cabinetry. Combos (both 1x12 and 2x12) are shipped with an 8 Ohm load connected to the 8 Ohm output which is preferable. If you wish to connect an additional 8 Ohm cabinet, simply remove the internal speaker(s) from the 8 Ohm jack and plug both internal Combo speaker(s) and the new additional 8 Ohm cabinet into the two 4 Ohm jacks. This will retain the preferred 8 Ohm load to the amplifier.



If you have a Head version of the **TA-30** we recommend an 8 Ohm load whenever possible for the best tonal results and response. If you have a different impedance cabinet you prefer, don't worry – the **TA-30** will happily accommodate your alternate cabinetry needs. Connect one 16 Ohm (usually 2x12 or 4x12) cabinet to the 8 Ohm output and you're good to go with the only compromise being that you won't have the full 40 watts available for clean headroom. Usually that's not an issue - since the amp is so loud and the additional (2 or 4) speakers put out so much more sound anyway - that the difference in wattage goes unnoticed. Connect one 4 Ohm cabinet to one of the 4 Ohm Outputs. It is not generally recommended to connect two 4 Ohm cabinets to the two 4 Ohm Outputs as this will create a 2 Ohm load that will sound soft and mushy and wear your power tubes at an accelerated rate.

REVERB BYPASS JACK:

This ¼" jack accepts a standard male phono-type plug and can be used to toggle the REVERB effect in and out of the signal path with a separate (not included) standard latching type footswitch. Like the LOOP, the REVERB circuitry stays in the signal path all the time and the jack just mutes the REVERB effect at its return mix stage.

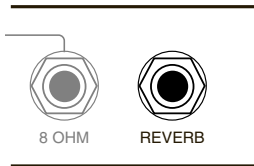

While not included, a separate REVERB Footswitch can be ordered either through your local MESA/Boogie Dealer or directly from us by contacting our Customer Service Department. When ordering, please be sure to specify which model of amplifier it is to be used with and also that it should be a "shielded" mono cable for use with the **TA-30**.

NOTE: A shielded (standard instrument) cable must be used to connect the footswitch to the REVERB jack.

That covers the features, outputs and functions of your **TRANSATLANTIC TA-30**...now it's up to your imagination as to how best to utilize all this expressive power. If you have any questions or concerns unanswered in this guide, please feel free to call our Customer Service department and ask for a Product Specialist who will be glad to help you get the answers you need. *Cheers and Enjoy!*

SAMPLE SETTINGS

Spanky Clean / Blues Vibe

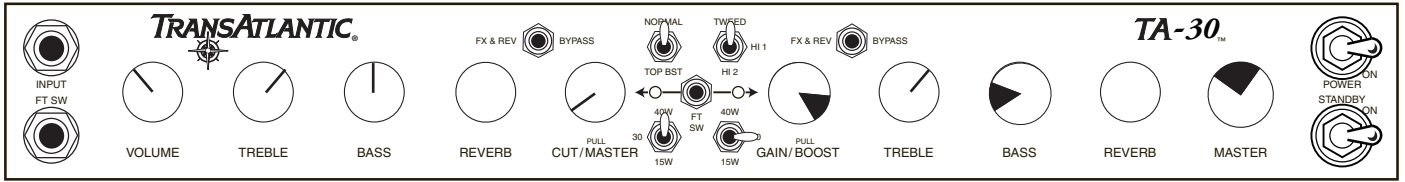

CUT
(knob pushed in)
30W or 15W

Clean Punch / Brit Crunch

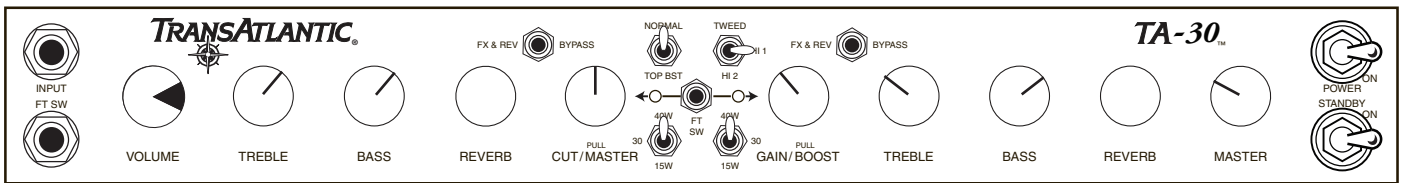

CUT
(knob pushed in)

Classic Brit Clean & Lead

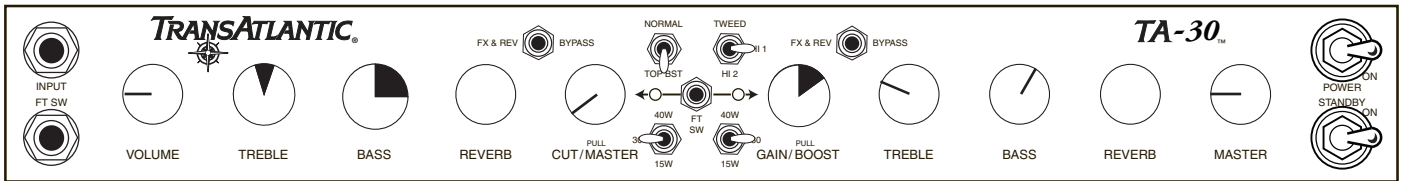

CUT
(knob pushed in)

Brit Break Up / Boogie Lead

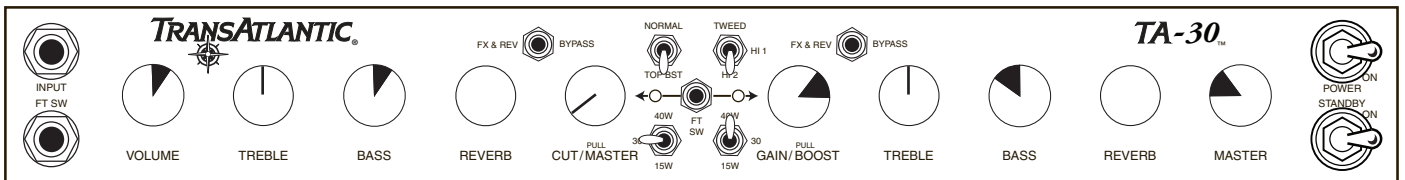

CUT
(knob pushed in)

SAMPLE SETTINGS

AC Solo / Vintage Clean

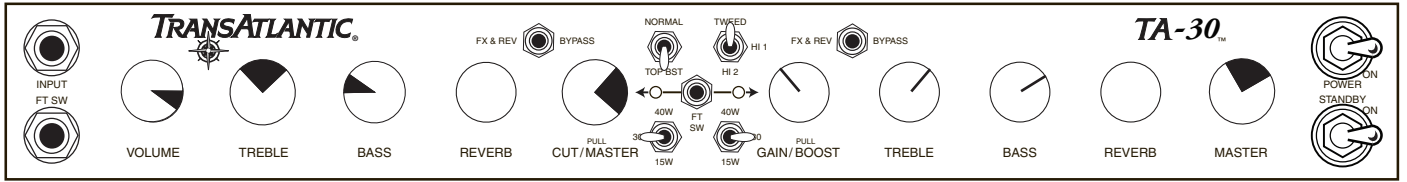

CUT
(knob pushed in) *or* *Pull Master As Needed*

AC Grind / Saturated Brit

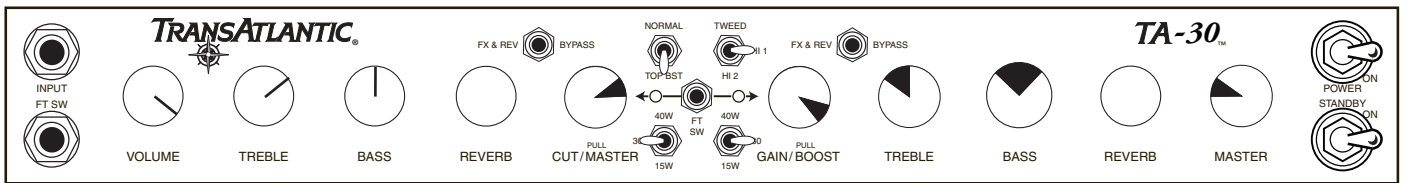

CUT
(knob pushed in) *or* *Pull Master As Needed*

Old School Bright Grind / Fat Clip

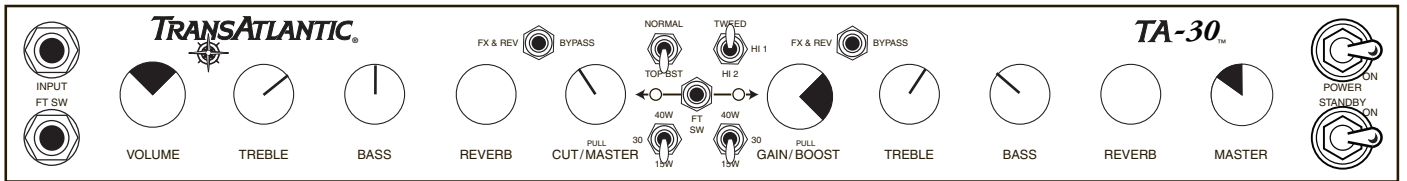

Pull Master As Needed
(knob pulled out)

Bright Edgy Clean / Burning Boogie

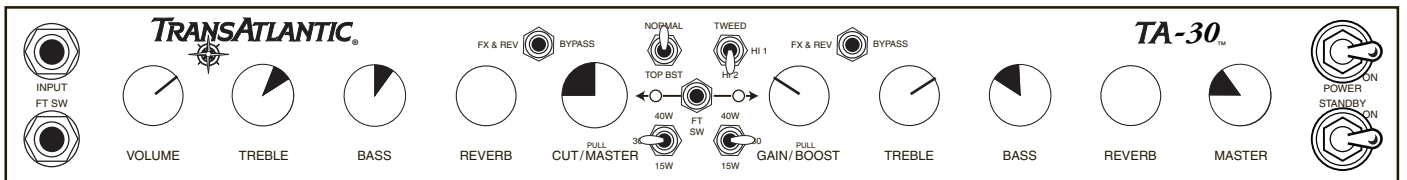

Pull Master As Needed (knob pulled out) *Pull Boost As Needed* (knob pulled out)

USER SETTINGS

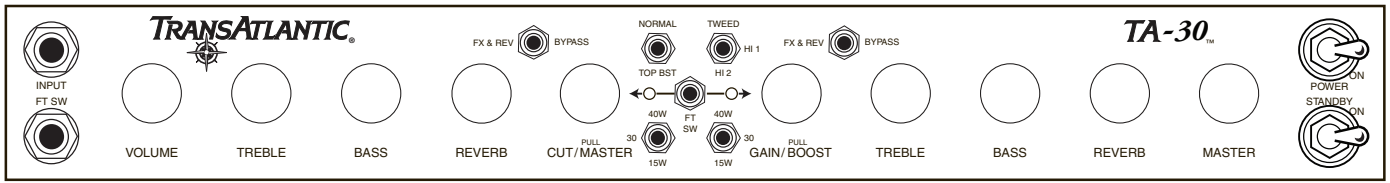
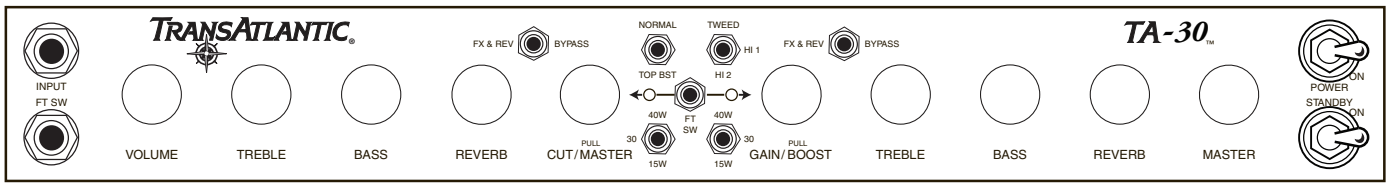
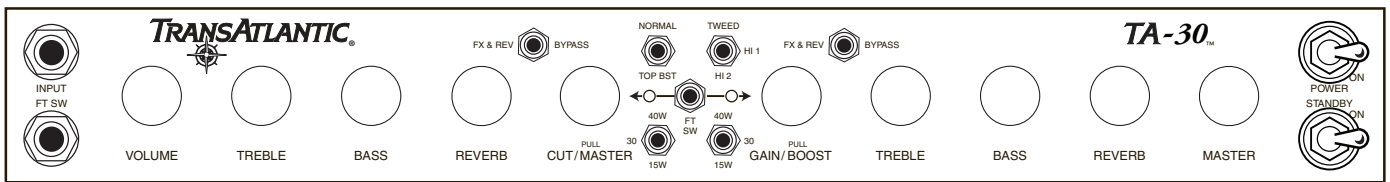
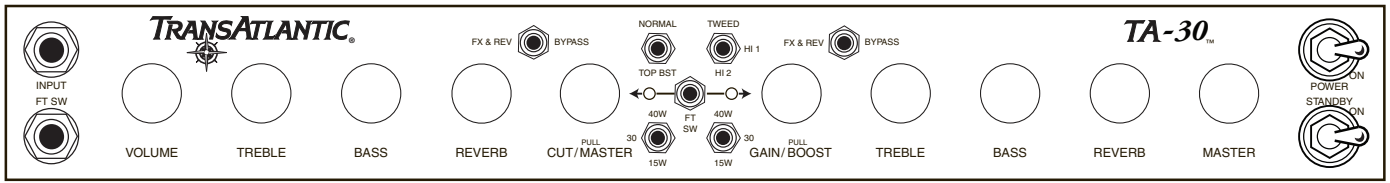

USER SETTINGS

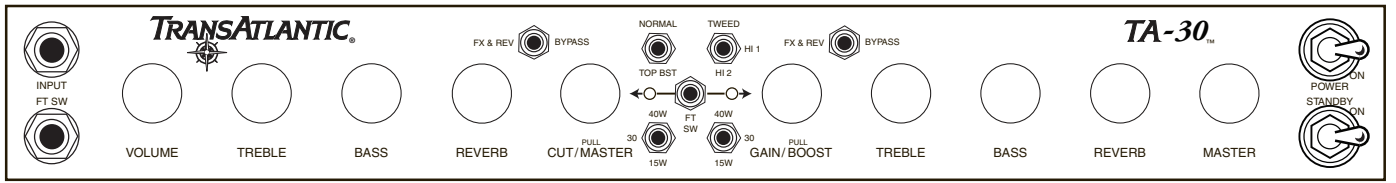
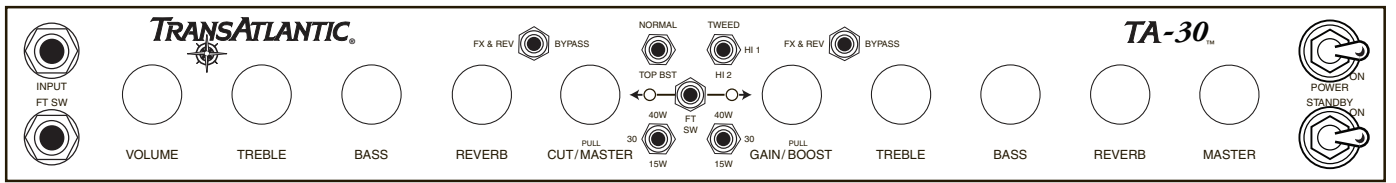
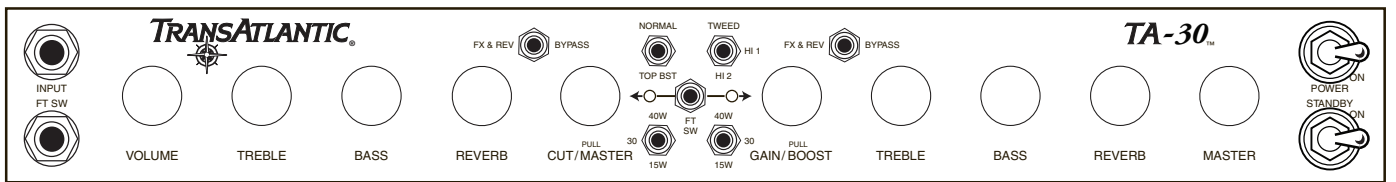
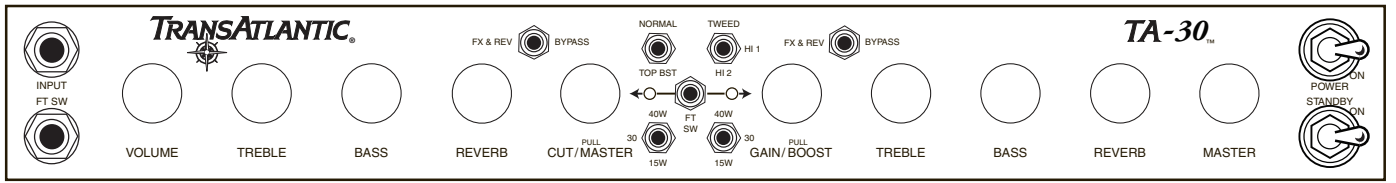

TUBE ACCESS:

Both preamp and power tubes are easily accessible on both Combo and Head versions of the TransAtlantic TA-30 through the removal of a few standard Phillips head screws and removal of the Tube Access Panel (Combo) or top Hood (Head). This means that should you ever need to replace a noisy or microphonic preamp tube or change out worn power tubes, you can do so in a matter of minutes with the only tool required being a Phillips screwdriver.

NOTE: ! Warning ! Vacuum Tubes Get HOT During Use! It is always best to perform tube maintenance with the amplifier turned off and the tubes allowed to cool before starting. If you must leave the amplifier on for trouble shooting or tonal comparisons during tube swapping – Always flip the STANDBY switch to STANDBY BEFORE STARTING and use a rag or leather gloves to grab the hot tubes. **DO NOT GRAB THE HOT TUBES WITH BARE FINGERS – THEY CAN CAUSE SEVERE BURNS WHEN AT OPERATING TEMPERATURE.**

COMBO VERSION: Preamp tubes sit horizontally on the tube sockets that are mounted to the component side of the circuit board inside the chassis pan. To access them, remove the Tube Access Panel's six Phillips head screws and carefully pry the vented panel away from the recessed cut-out in the vinyl covered wood panel with either your fingernail or the tip of a flathead screwdriver covered with a thin cloth (so as not to scratch either panel). After replacing tubes re-attach the Tube Access Panel and check that the Phillips screws are securely tightened... but do not use excessive force and strip the Phillips head.

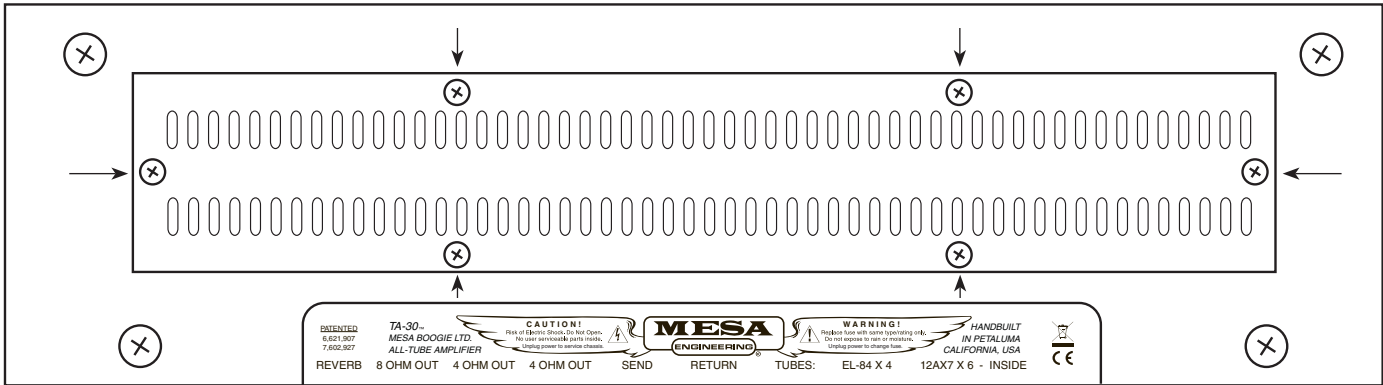

Power Tubes are located in the Tube Cage on the (bottom) Rear of the chassis and can be accessed by gently pulling the four plastic stand-off clips away from the cage and carefully removing the cage. It is easier to replace the power tubes and line up the pins correctly when the amplifier is upside down and you can easily see the tube sockets. Alternatively you can put the amp up on a tall table and get below the chassis and shine a light up into the back of the amplifier. We strongly recommend one of these two methods as they will save your wrists, back and keep you from bending up the pins on tubes. Never force tubes into the socket. If the pins are lined up you can easily insert them into their proper position. You can gently rock them back and forth into place once the pins are aligned with no harm to the tube or the socket..

NOTE: ! Warning ! The risk for electrical shock exists when the Tube Access Panel is removed. It is always recommended to turn the amplifier off and remove the A.C. Power Cord from the wall A.C. Outlet before removing the Tube Access Panel.

NOTE: ! Do not touch any circuitry components inside the chassis when replacing tubes. Never stick any metal objects inside the amplifier chassis. Refer to a qualified Service Technician for all other service issues other than tube replacement.

TUBE ACCESS:

HEAD VERSION:

Preamp tubes sit vertically upside down on the bottom of the circuit board and are accessed from the bottom of the chassis by turning the head upside down (with the handle in its stowed position) and removing the Phillips head screws in bottom panel and removing it.

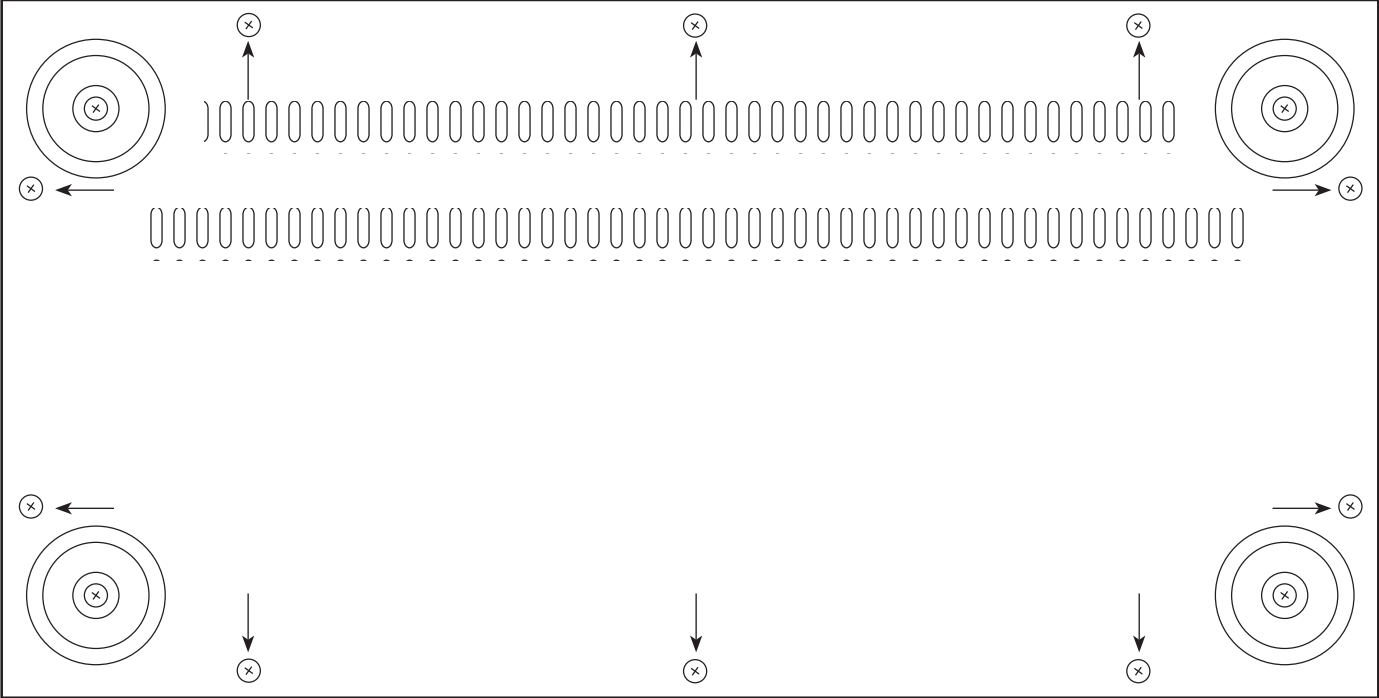

NOTE: ! Warning ! The risk for electrical shock exists when the Bottom Panel is removed. It is always recommended to turn the amplifier off and remove the A.C. Power Cord from the wall A.C. Outlet before removing the Bottom Panel.

NOTE: ! Do not touch any circuitry components inside the chassis when replacing tubes. Never stick any metal objects inside the amplifier chassis. Refer to a qualified Service Technician for all other service issues other than tube replacement.

When replacing the bottom panel, be sure to orient the panel so the vents are closest to the front of the amplifier. The screw hole holes will only line up in this position.

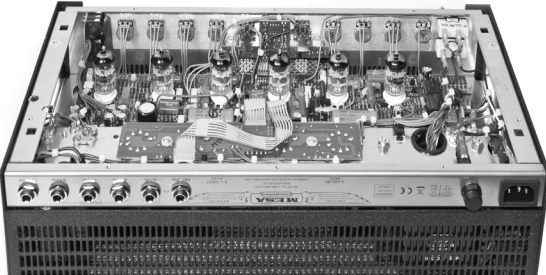

Bottom panel removed for preamp tube maintenance.

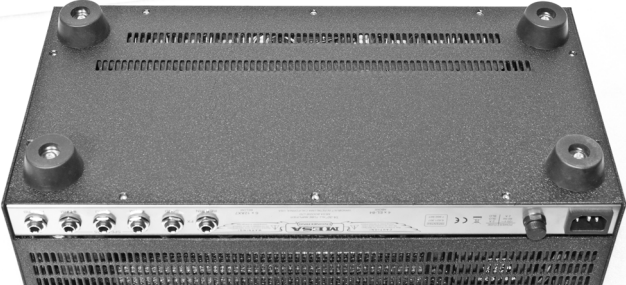

Bottom panel correctly replaced.

Removing the *TRANSATLANTIC* Cover for Power Tube Replacement

****** Before removing cover make sure the amplifier is powered off and the AC cord is unplugged.**

Power tubes sit vertically on the top side of the chassis and can be accessed by removing the Phillips screws on both the left and right sides of the upper protective Hood.

Remove the four screws from the left and right side of the amplifier.



Caution: There are three pairs of wires connecting the chassis to the cover. **Do not** lift the cover straight up. With the rear of the amplifier facing toward you, carefully lift the cover and tilt to the left maintaining close distance between the chassis and left side of the cover.



Once the cover is free from chassis, carefully rest the cover on its left side. As an extra precaution, you may place the feet of the amplifier on the cover to keep it from tipping over and pulling out the connecting wires (see close-up photo below).

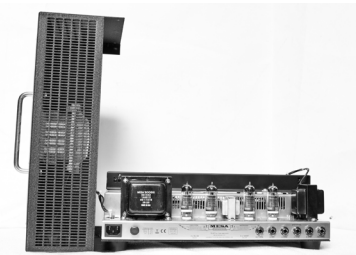

After completing tube maintenance, reverse the above steps to replace the cover. Be sure the wires on the left side of the chassis are tucked in and not pinched between the cover and the chassis as you slide the cover back into place.



Note: Use care when completing these steps as a careless act can scratch the chassis or cover.

NOTE: ! Warning ! Vacuum Tubes Get HOT During Use! It is always best to perform tube maintenance with the amplifier turned off and the tubes allowed to cool before starting. If you must leave the amplifier on during tube swapping for trouble shooting or tonal comparisons – Always flip the STANDBY switch to STANDBY BEFORE STARTING and use a rag or leather gloves to grab the hot tubes. DO NOT GRAB THE HOT TUBES WITH BARE FINGERS – THEY CAN CAUSE SEVERE BURNS WHEN AT OPERATING TEMPERATURE.

NOTE: When removing tubes be sure to rock them gently back and forth while pulling the tube away from the socket. When inserting tubes, make sure the gap in the pins line up with the gap in the pin holes on the tube socket before applying pressure.

TUBE NOISE & MICROPHONICS:

You may occasionally experience some form of tube noise or microphonics. Certainly no cause for alarm, this quirky behavior comes with the territory and the Tone. Much like changing a light bulb, you don't need a technician to cure these types of minor user serviceable annoyances and in fact, you'll be amazed at how easy it is to cure tube problems...by simply swapping out a pre-amp or power tube!

First may we suggest that you set the amplifier up on something so that you can get to the tubes comfortably without having to bend down. It also helps to have adequate lighting as you will need to see the tube sockets clearly to swap tubes. **Use caution and common sense when touching the tubes after the amplifier has been on as they may be extremely hot!** If they are hot and you don't want to wait for them to cool off, try grasping them with a rag and also note that the glass down around the bulbous silvery tip is considerably less hot which makes it easier to handle. Gently rock the tube back and forth as you pull it away from its socket.

DIAGNOSING POWER TUBE FAILURE:

There are two main types of tube faults: shorts and noise. Both large and small tubes may fall prey to either of these problems but diagnosis and remedy is usually simple.

If a fuse blows, the problem is most likely a shorted power tube and shorts can either be mild or severe. In a mildly shorted tube the electron flow has overcome the control grid and excess current flows to the plate. You will usually hear the amp become distorted and begin to hum slightly. If this occurs, quickly look at the power tubes as you switch the amp to STANDBY and try to identify one as glowing red hot. It is likely that two of a pair will be glowing since the "shorted" tube will pull down the bias for its adjacent mates, but one tube may be glowing hotter — and that one is the culprit. The other two are often fine — unless they've been glowing bright red for several minutes.

Because there is no physical short inside the tube (just electrons rioting out of control) merely switching to STANDBY for a few moments then back to ON will usually cure the problem...at least temporarily. Watch the tubes carefully now. Should the problem recur, the intermittent tube will visibly start to over heat before the others and thus it can be identified. It should be replaced with one from the same color batch, shown on its label. Call us and we will send one out to you.

The severe short is not nearly so benign. In the worst cases, a major arcing short occurs between the plate and the cathode with visible lightning inside the glass and a major noise through the speaker. If this is seen to happen, IMMEDIATELY turn the amp to STANDBY. By this time the fuse probably will have blown. Such a short is usually caused by a physical breakdown inside the tube including contaminate coming loose or physical contact (or near contact) between the elements. Replace it and the fuse with the proper slo-blo type and power up the amp using the power up procedure as we described earlier in this manual.

TUBE NOISE:

Often caused by contamination within in a tube, the culprit can usually be identified, and by lightly tapping on the glass, you will probably hear the noise change. Hearing some noise through the speakers while tapping on the 12AX7's is normal however. And the one nearer the INPUT will always sound louder because its output is being further amplified by the second 12AX7.

The power tubes should be all but quiet when they are tapped. If crackling or hissing changes with the tapping, you have probably found the problem. To confirm a noisy power tube, merely put the amp on Standby, remove it from its socket and turn it back on. It will cause no damage to run the amplifier briefly with one power tube missing. You may notice a slight background hum, however, as the push-pull becomes unbalanced. Whenever you are trying to diagnose a suspect tube, keep your other hand on the POWER and STANDBY switches ready to shut them off instantly in the unlikely case you provoke a major short.

If you think you've located a problem tube but aren't sure, we recommend substituting the suspect with a new one just to be sure of your diagnoses. You will be doing yourself and us a big favor by just following the simple guidelines previously mentioned regarding tube replacement. You'll probably be successful with much less effort than is required to disconnect everything and haul the unit to a technician who will basically perform the same simple tests. If the tubes are still within their six-month warranty period, we will happily send you a replacement. Just note the color designation on the tube label so that we can send you the appropriate match.

DIAGNOSING PRE-AMP TUBE PROBLEMS:

Because your amplifier is an all tube design, it is quite possible that you will at some point experience minor pre-amp tube noise. Rest assured - this is no cause for alarm and you can take care of the problem yourself in a matter of minutes by simply swapping tubes.

Let us begin by saying; It is a "very good" idea to keep at least a couple of spare pre-amp tubes on hand at all times to insure uninterrupted performance. These minor pre-amp tube problems can take many forms but can generally be described in two categories: Noise and Microphonics. Noise can be in the form of crackling, sputtering, white noise/hiss and/or hum. Microphonic problems usually appear in the form of a ringing or high pitched squealing that gets worse as the gain or volume is increased thus are more noticeable in the higher gain "HI" modes. Microphonic problems are easily identified because the problem is still present even with the instruments' volume off or unplugged altogether - unlike pick-up feedback which ceases as the instrument is turned down. Microphonic noise is caused by mechanical vibration and shock: think of banging a microphone around and you'll understand where the word came from.

The best way to approach a pre-amp tube problem is to see if it occurs only in one specific mode or channel. This should lead you to the tube needing replacement. Then all that remains is to swap the suspect tube for a known good performer. If you cannot narrow down the trouble to a specific mode or channel, the problem may be the small tube that drives the power tubes which is operational in all modes and channels. Though rare, a problem with the driver tube would show up in all aspects of performance - so if you can't narrow the problem down to being mode or channel specific, you may want to try replacing the driver tube. Driver problems generally show themselves in the form of crackling or hum in all modes of performance and/or weak overall output from the amplifier. Occasionally an anemic driver tube will cause the amplifier to sound flat and lifeless, but this is somewhat uncommon, as worn power tubes are a more likely suspect for this type of problem.

Sometimes making the diagnosis is more trouble than it's worth and it's faster and easier to merely replace the small pre-amp tubes ONE AT A TIME with a replacement known to be good. But MAKE SURE you keep returning the tubes to their original socket until you hit the one that cures the problem. You'll notice that tubes located nearer to the INPUT jack always sound noisier...but this is because they are at the start of the chain and their noise gets amplified over and over by the tubes that follow. The tube that goes into this "input socket" (usually labeled V1) needs to be the least noisy of the bunch. The tube that goes at the end of the preamp chain - just ahead of the power tubes - can be quite noisy without causing any problem at all. The tubes in your amp have already been located in the most appropriate sockets and this is why you should NEVER pull them all out at once and ALWAYS swap them one at a time. ALWAYS return a perfectly good tube to its original socket. Also it's a good idea to put the amp on STANDBY when swapping tubes to reduce the heat build up in the tubes themselves and to prevent explosive noises (which can still occur even if you are pulling the tubes away from their sockets gently) from coming through the speaker.

Remember, take your time, be patient and chances are real good that you can fix your amp yourself by finding and replacing the bad tube. It kills us to see someone who has shipped their amp back to us...and all it needed was a simple tube replacement! If you must send back your amp, remove the chassis from the cabinet by unscrewing the four mounting bolts on the bottom top. The chassis then slides back like a drawer and comes out from the back. Remove the big power tubes and mark them according to their location from left to right 1, 2 etc. They need to be wrapped separately with plenty of wadded up newspaper around them and put in a smaller box within the larger carton. Remove the Rectifier tubes and wrap them also. You can leave the preamp tubes in or remove them and wrap them separately being sure to label their location. (See Tube Task Chart.)

To wrap the chassis, use plenty of tightly wadded up newspaper so there is at least six inches of "crush space" between the chassis and the cardboard box. Bubble wrap also works well, but please DON'T use styrene peanuts - they will shift during transit and get lodged inside your electronics as well as allowing your amp to end up at the bottom of the box unprotected and possibly damaged.

Pre-amp tubes don't normally wear out as a rule. Therefore, it is not a good idea to change them just for the sake of changing them. If there isn't a problem - don't fix it. If there is no result from your substitutions, it may be possible that you have more than one problematic tube. Though rare, this does happen and though it makes the troubleshooting process a little more intimidating, it is still possible to cure the problem yourself.

NOTE: *It is normal to hear a slight metallic ringing sound when tapping on the preamp tubes. As long as the tube does not break into oscillation or start crackling or any other form of bizarre noise, it is considered normal and functional.*

BIAS ADJUSTMENT: *(Part of a continuing series)*

An Article written by Randall Smith that we thought you might find interesting.

Here's a question we often hear:

"Why doesn't *Mesa* put bias adjustments in their amplifiers?"

Well, there's a short answer and a long answer to this question.

The short answer is that during my 12 years of repairing Fenders, one of the most frequent problems I saw was bias controls that were either set wrong or that had wandered out of adjustment due to vibration. As any honest tech will tell you, there's lot's of easy money to be made by sprinkling "holy water" on amplifiers ... uh, what I meant to say is "Your amp needed biasing." See what I mean? What customer is going to argue with that?

It only takes a moment and a volt meter: The Fender diagram shows how: "Adjust this trim pot for - 52 volts." That's it. Nothing more.

Now don't be fooled into thinking that tubes "draw" more or less bias, they don't. The way a bias supply is connected to a tube is akin to a dead end road, it just trails off to nowhere without really completing a circuit. It's a static voltage and regardless of what tube is in the socket — or even if the tubes aren't plugged in at all, it doesn't change the bias voltage a bit.

So the end of the short answer is this: Since a bias supply needs to put out the right voltage and never vary, I wanted to build amplifiers that were individually hard wired to the correct values and NEVER needed adjustment. And for 25 years, that's how *MESA/Boogies* have been built.

Time to change tubes? Just plug our tubes into any one of our amps and you're DONE. No tech needed. NO bills and no BS about biasing. And most important: The bias is RIGHT because it can't change!

Now, you want the long answer? Here's more information on how our hard-wired bias avoids trouble. Please read on.

But first, let's make an important distinction. Our business is designing and building high performance amplifiers. And for this we need tubes whose variance is within a narrow range. Our warehouse is full of rejects ...oh, they work — they just don't perform within our tolerance range. We have a very sophisticated computer - based tube testing system (nicknamed "Robotube") that matches and measures tubes over seven important parameters. It can even predict which tubes are likely to have a shortened lifetime — even though they work perfectly during the test.

Because our business is building quality amps, we can afford to reject a lot of wayward tubes. The guys you hear complaining because *Boogies* don't have bias adjusters are primarily in the business of selling tubes - not amps. They don't want to throw away 30 percent of their inventory, so they promote the idea that tubes outside our parameters can be used to "customize" amplifiers and they criticize us because our amps can't be adjusted to accommodate their out-of-*MESA* tolerance tubes.

Now you might be thinking, "But I thought you just said that tubes don't "draw" bias, therefore they don't effect the bias supply and thus it doesn't need to be adjustable." When you set the bias (whether it's by selecting the right resistors, as we do, or adjusting a trimmer — which is quicker) what you are doing is establishing the correct amount of idle CURRENT that flows through the power tubes. But you can't adjust the current directly, you can only change it by adjusting the amount of bias VOLTAGE that goes onto the tubes' control grids. Voltage and current are NOT the same. Current is the AMOUNT of electricity, the "quantity" — and is measured

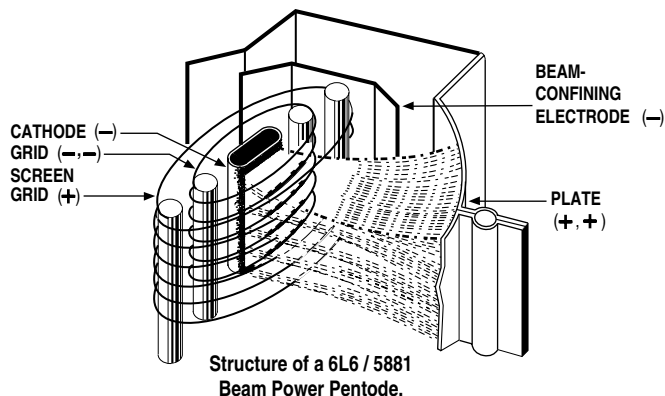

in amperes. Voltage is the degree of electric charge — like the “pressure” to use the old water analogy. Let me illustrate how different voltage and current are:

When you scrape your feet across a carpeted floor in dry, wintery conditions, your body can become charged with 50,000 to 100,000 volts of static electricity. And when you reach for the door knob, a spark jumps and you feel it! The voltage is super high but the current (measured in micro-amps) is tiny - otherwise you would die from electrocution.

Contrast this with your car battery, which puts out a mere 12 volts. You can lay your hands right across the terminals and not feel a thing. Yet the amount of current available can run to several hundred amperes .. enough to turn over a cold engine and get it started.

So current and voltage are two totally separate electrical parameters — though when you multiply them together, you get POWER, which is measured in watts.

When you set the bias of an amplifier, you are adjusting the static VOLTAGE at the control grid of the tube in order to produce a desired amount of idle CURRENT flowing to the tube’s plate. A small change in grid voltage, produces a large change in the amount of current flowing — and that’s basically how a tube works. Say that again because it’s super important: A small change in voltage at the grid causes a large change in current flowing to the plate. See, that’s the essence of amplification: A small change causing a large change. And here it’s a small voltage change causing a large current change.

The bias conditions are what determines how much current flows through the big power tubes when you’re not playing. And what drives your speakers is fluctuations in that current flow when you ARE playing. If the amount of current increases and decreases 440 times per second, then you’ll hear an A note. If the fluctuations in current flow are large and still at 440 per second, you’ll hear an A that is LOUD!

But for purposes of biasing, it’s the amount of “plate current” flowing with no signal applied that’s important. Unfortunately current is hard to measure because the circuit must be interrupted — as in “cut the wire” — and the meter spliced “in series” with the broken circuit. But measuring VOLTAGE is easy. It is not necessary to interrupt the circuit because a voltage reading can be taken in PARALLEL with the circuit intact.

Thus, as a matter of convenience, most bias settings are given in volts at the grid ... even though current through the plate is the important factor. In fact plate current is so inconvenient (and dangerous) to measure that Fender doesn’t even state what the correct value should be. They only give the grid voltage that will produce that current. (That’s the minus 52.) But that only happens if the tubes being used are “in spec.”

As long as the tubes ARE “in spec”, the right bias voltage will always give the correct plate “CURRENT” — but then there’s no need for the bias voltage to be adjustable!

If the tubes are NOT in spec, then the only proper way to re-set the bias is to cut the circuit and measure the current while adjusting the bias ... but no manufacturer I know even STATES the desired current value! Be that as it may, when the original bias voltage is altered far enough, it will compensate for the tube’s abnormal performance and the correct amount of idle current flow may then be restored. Clearly this is something most repair techs should not attempt.

Some newer amps have LED indicators connected to the circuit which will turn on when the right threshold of current flow has been reached. This is an improvement, and almost worthy if you’re willing to accept resistors and lights added into your amplifier’s audio path — which we aren’t.

The other “advantage” of this system is that it allows some amp manufacturers to avoid matching their power tubes. The thinking is that adjusting the bias to each tube separately eradicates the inherent differences between the tubes by insuring that the same current flows through each one.

BIAS ADJUSTMENT: *(Continued)* Again, this has some merit .. but it's still not as good as using tubes that are matched in the first place because compensating for the mis-match causes the push-pull circuit itself to become unbalanced. Two wrongs don't really make a right.

Some of the other recommended biasing, "methods" — such as — “.. tubes running red hot, increase the bias .. sounds harsh and runs too cool, turn it down ...” are guesswork at best. Luckily, one of the great things about tube amps is that they can usually stand some abuse without causing any real harm ... at least not immediately. But don't these alterations imply that you are second-guessing the amp designer and that there's a better set of operating conditions that the designer missed but the tube sellers have discovered?

Now some players may like the sound of their amp altered by tubes with extreme characteristics and with the bias set to help compensate. But often it is the mere novelty of change that they're really responding to and when the amp goes back to the proper original way, we've seen them be far happier still!

Because every part in every one of our designs has been meticulously evaluated, compared and stressed over — no matter how seemingly insignificant it might be. And with every design we look for a “sweet spot” where all the parameters — including the bias — come together to give the best sonic performance, consistently and reliably. Every part and voltage is important — yet no one complains that these other parameters aren't available for tinkering.

Consider our patented *Simul-Class* circuitry where there are two different bias voltages used for separate pairs of power tubes ... and changing one voltage also changes the other. Great care goes into getting this just right and we think we'd be asking for trouble to have it adjustable for the world to play with ... unless you like paying to have your amp messed up. Sorry, I meant to say, “Uh, ... your amp needed biasing.”

If that doesn't appeal to you, then merely plug a matched set of *MESA* tubes into one of our amps and you're ready for tone. Guaranteed. You'd be amazed at the number of service calls we field every day that lead to a diagnosis of out-of-tolerance, non-spec tube problems. To think these would be prevented by including a bias adjustment is something of an insult to you and us. If you put the wrong size tires on your car, do you think changing the pressure will make them right?

Please, don't think this is a blanket indictment of the other guys selling tubes — it isn't. And their tubes aren't all bad either. It just doesn't make sense to pay more of your hard earned cash for tubes that were probably made in the same Russian or Chinese factory and which have the possibility of being outside the performance window we select for your amp. And it pains us to hear the hype and mystique built up around biasing when twenty-five years of evidence affirms our decision to make bias circuits that “never need adjustment”. How much money and trouble that has saved *MESA/Boogie* players you couldn't estimate.

Our rigorously tested and hand selected tubes are available at your nearest *MESA/Boogie* Pro Center or from us directly. Nobody offers better price, quality or warranty than we do ... so why swerve?

Cheers!
MESA/Boogie Ltd.

SPEAKER IMPEDANCE MATCHING & HOOK-UP GUIDE:

IMPEDANCE: Wiring up speakers to provide the most effective load and making sure that all of them are in phase will help in creating the best sound possible. This is not too difficult, as long as you understand a few things about loading and how to connect your speakers to provide an optimal resistive load.

MESA/Boogie amplifiers can handle 4 and 8 ohms effectively. Never run below 4 ohms in a tube amplifier unless you are absolutely certain that the system can handle it properly; this can cause damage to the Output transformer. A few amplifiers can handle 2 ohms effectively without damaging them (for example the *MESA'S Bass 400+*). You can always have a higher resistance (16 ohms, for example) without damaging results, but too low of a resistance will likely cause problems.

MIS-MATCHING: When running a higher resistance (for example: 8 ohm output into 16 ohm cabinet), a slightly different feel and response will be eminent. A slight mismatch can provide a darker smoother tone with a little less output and attack. This response is a result of the amplifier running a bit cooler. Sometimes when using more than one cabinet a mismatch will be the only option.

WHAT IS MY CABINETS IMPEDANCE: If you have only a single speaker, you just match that single speakers impedance to the amplifier, and you are done. In many cases, you will have a number of speakers, and then you must calculate the "load" that the amplifier will need to support. There are generally three ways to wire multiple speakers together. They are as follows:

SERIES: When you wire (hook-up) speakers in Series, the speakers resistance (as measured in ohms) is additive - i.e. putting two 8 ohm speakers in Series results in a 16 ohm load.

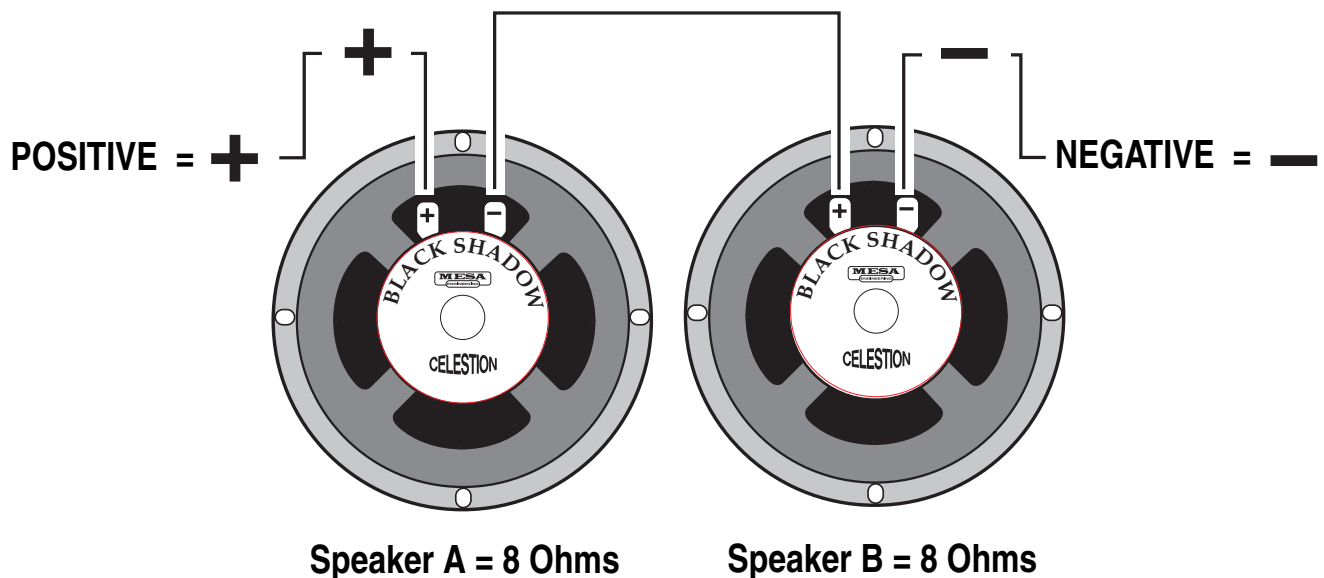

SERIES: Connect the Negative side of Speaker A to the Positive side of Speaker B

SPEAKER IMPEDANCE MATCHING & HOOK-UP GUIDE: (Continued)

PARALLEL: When wiring in parallel, the resistance of the speakers decreases. Two 8 ohm speakers wired in (hooked-up) Parallel results in a 4 ohm load. It's easy to calculate the effect of a resistive load when all the speakers are all the same resistance. It is really not suggested to wire different resistive load values in Parallel (8 and 4, 16 and 8 etc.) The formula for figuring the total impedance in Parallel is the multiplication of the two loads divided by the sum of the two loads - i.e. putting two 8 ohm speakers in Parallel results in a 4 ohm load. Connect the Positive side of Speaker A to the Positive side of Speaker B - Connect the Negative side of Speaker A to the Negative side of Speaker B.

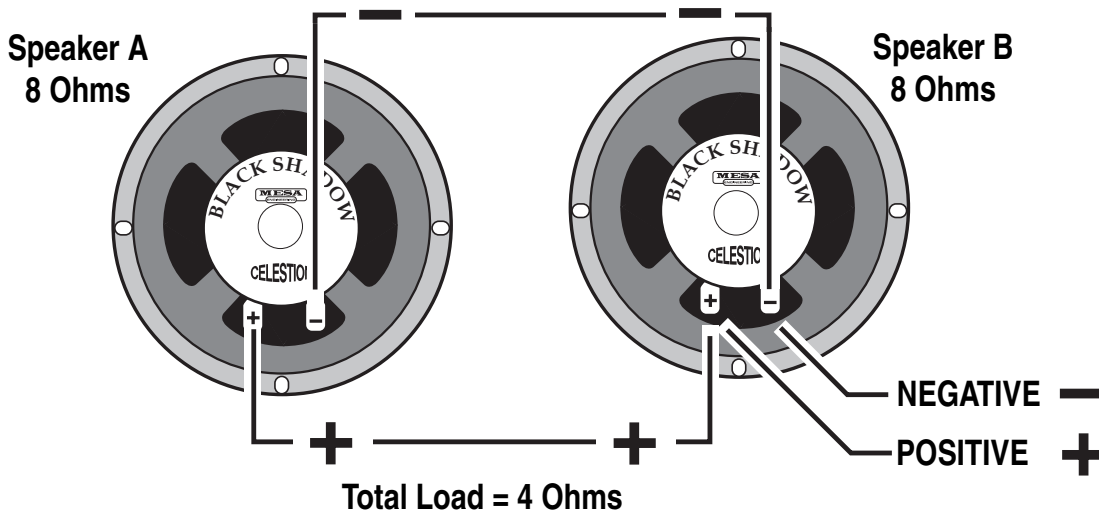

COMBINATION OF SERIES & PARALLEL: This is really just two sets of Series wired speakers connected in Parallel. This is how you maintain a consistent load with multiple speakers. The importance of this is more evident when you have more than one cabinet to connect to your amplifier. This is when you need to figure out the loads and how to wire them up without applying too low of a resistance on the amplifier.

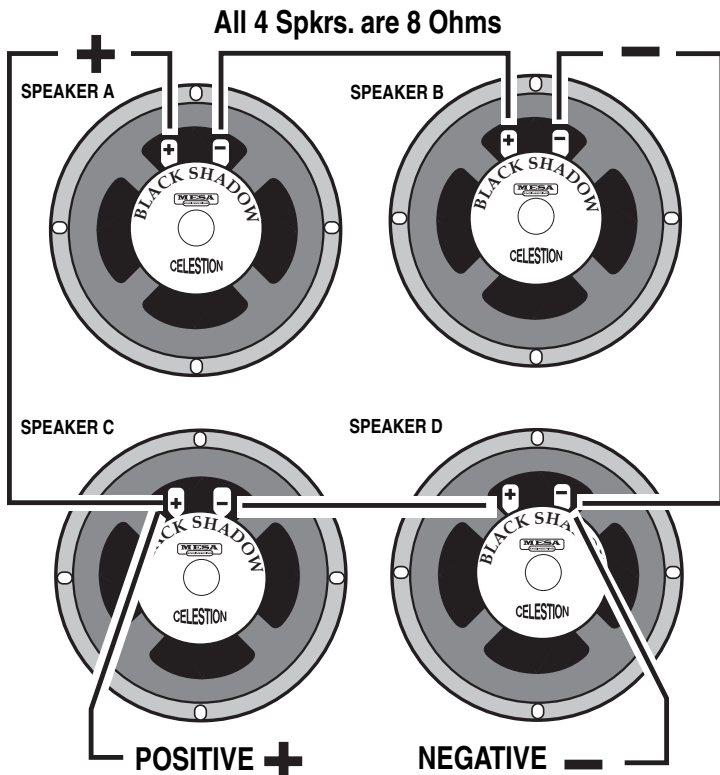

Simply connect the Positive side of Speaker A to the Positive side of Speaker C.

Connect the Negative side of Speaker A to the Positive side of Speaker B. Next, connect the Negative side of Speaker C to the Positive side of Speaker D.

And lastly, connect the Negative side of Speaker B to the Negative side of Speaker D.

4 Eight (8) Ohm speakers wired in Series Parallel = a Total Load of 8 Ohms.

WIRING SCHEMES...Amplifier to Speaker Cabinets

1

2

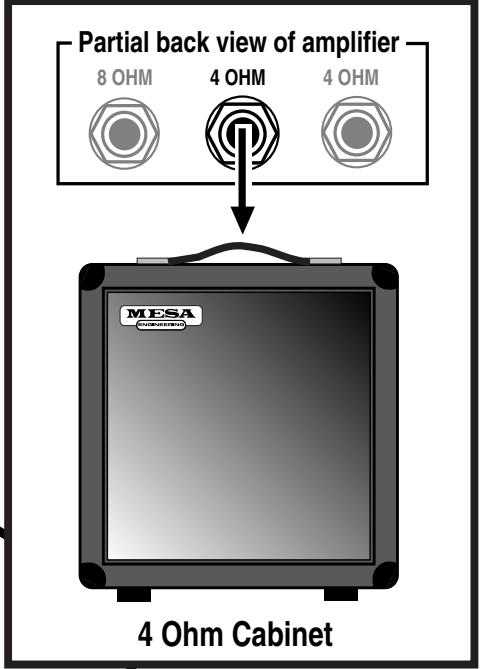
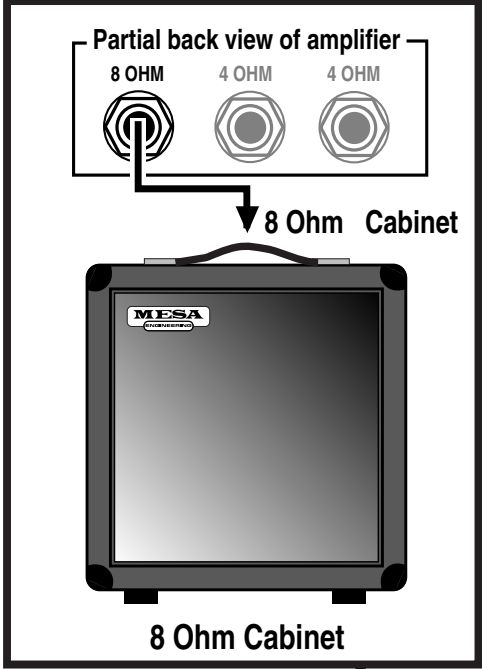

3

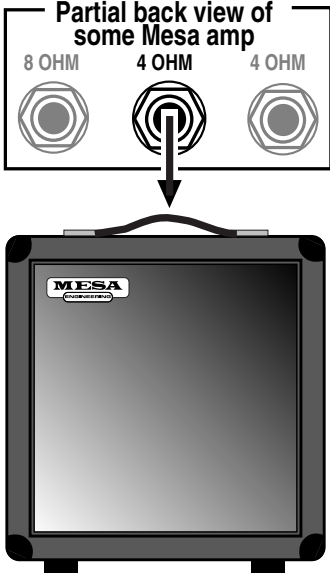

4

5

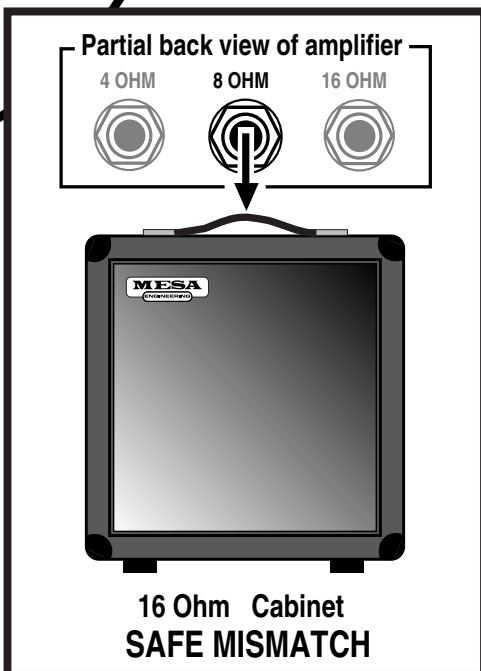
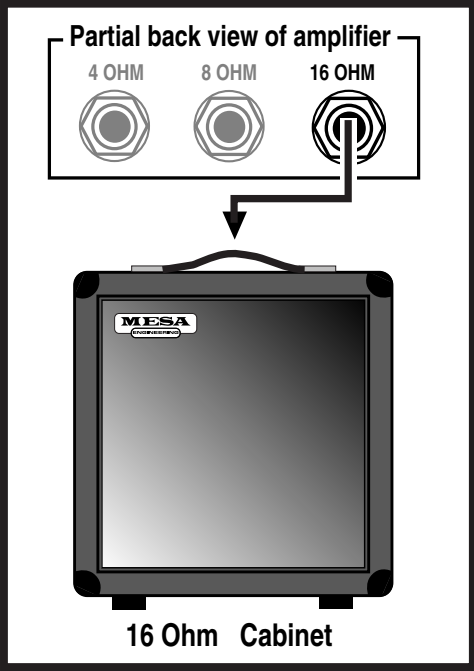

WIRING SCHEMES...Amplifier to Speaker Cabinets

6

7

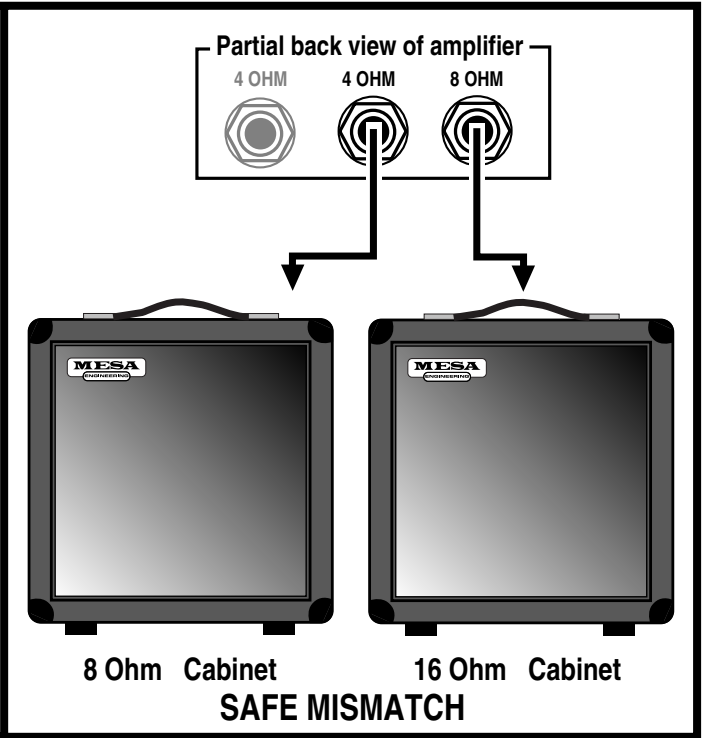
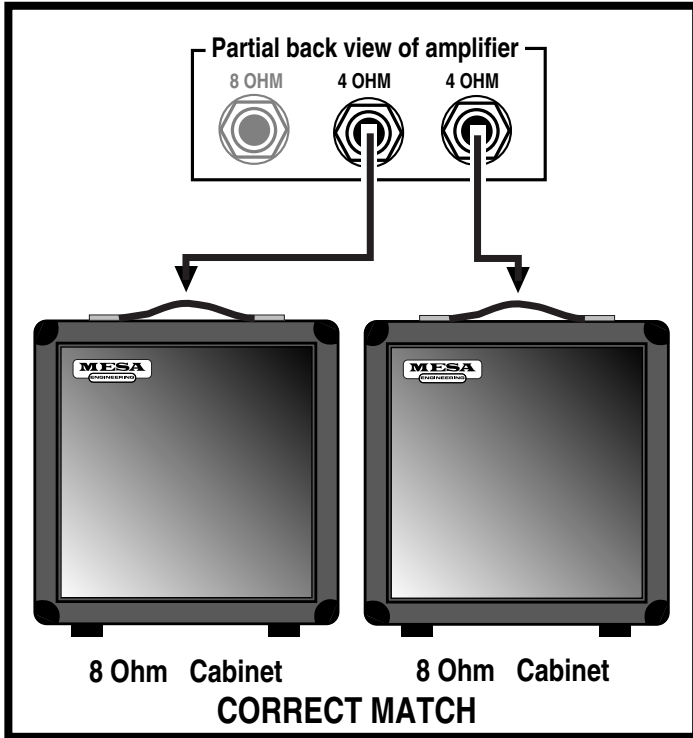

8

9

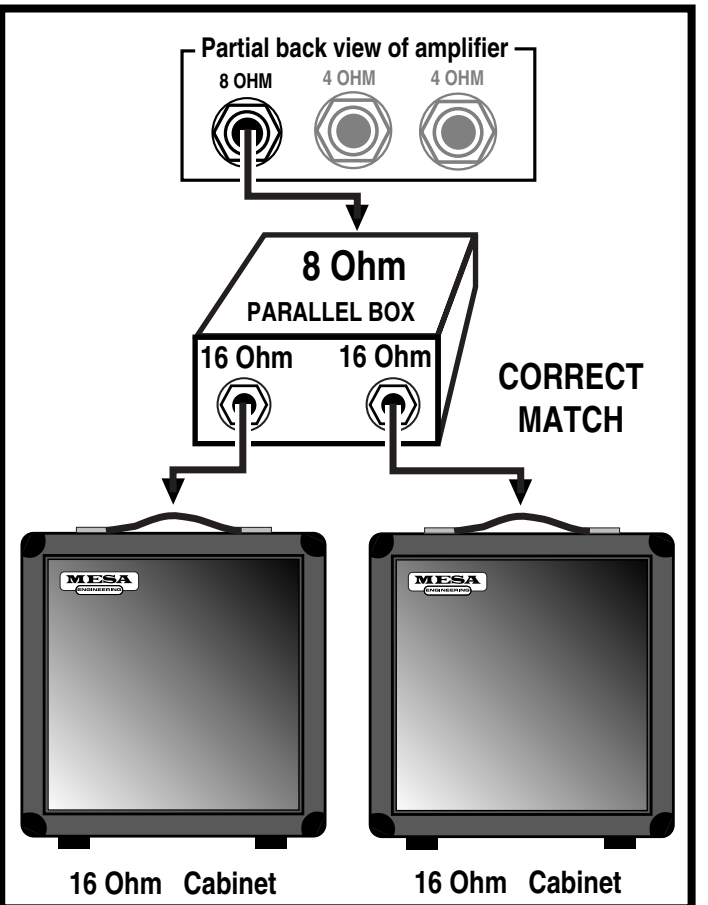
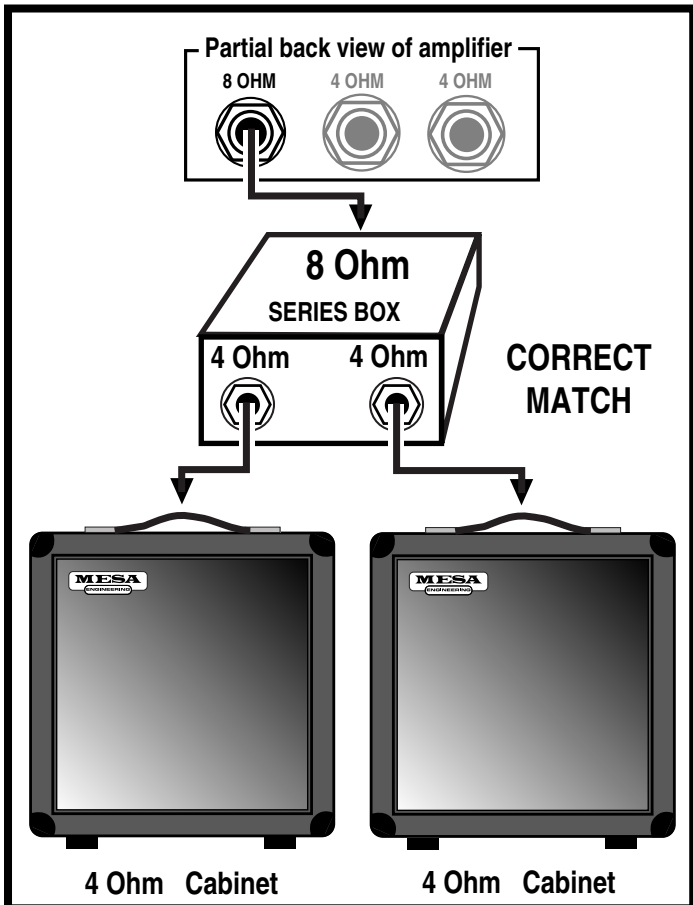

WIRING SCHEMES...Amplifier to Speaker Cabinets

10

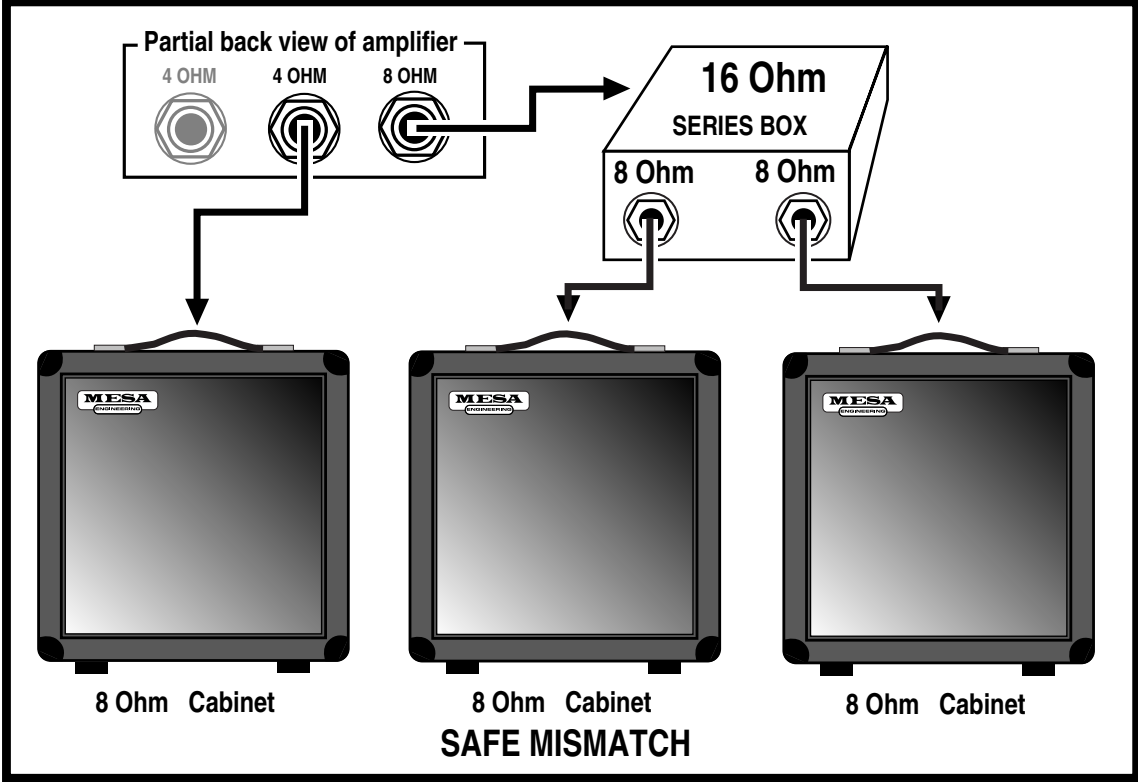

11

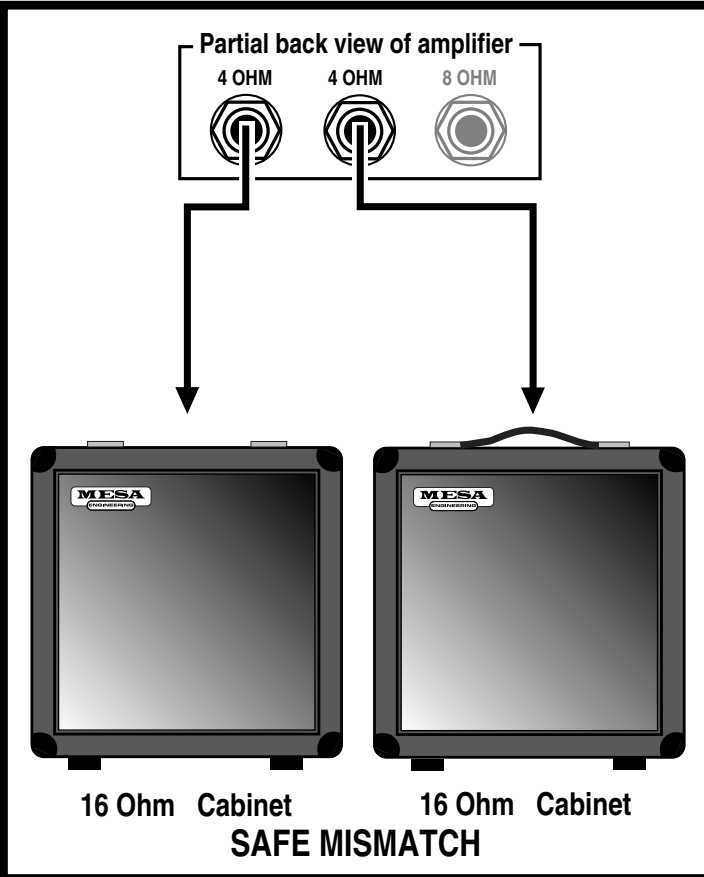

12

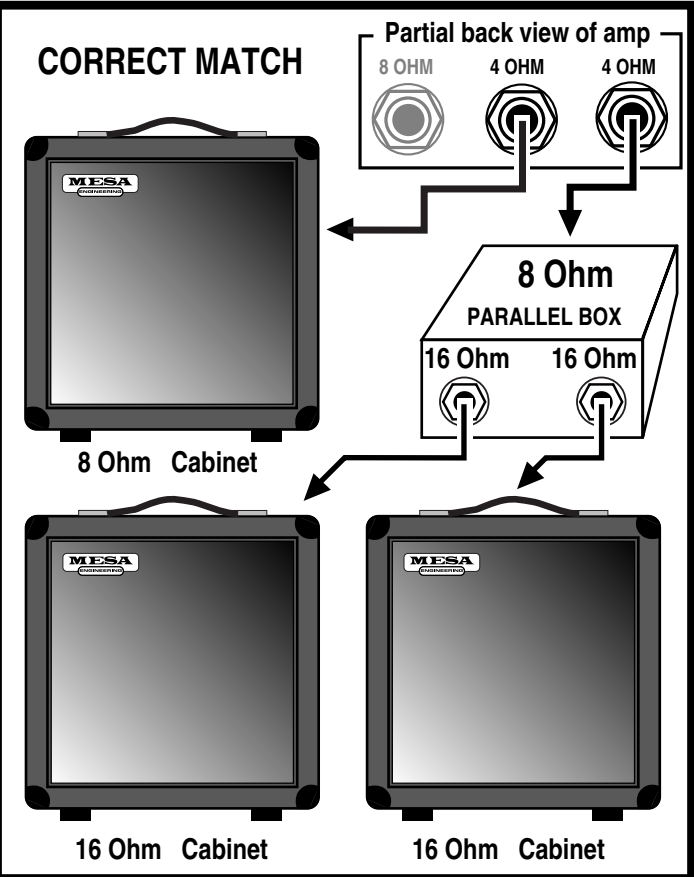

WIRING SCHEMES...Amplifier to Speaker Cabinets

13

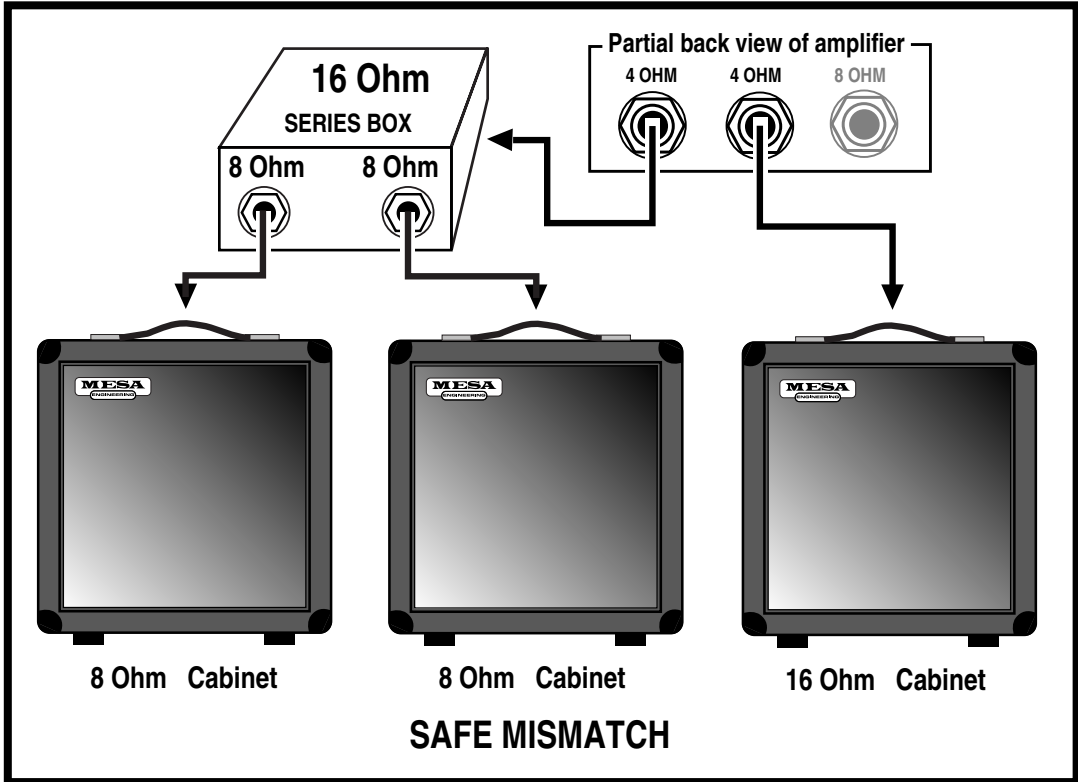

14

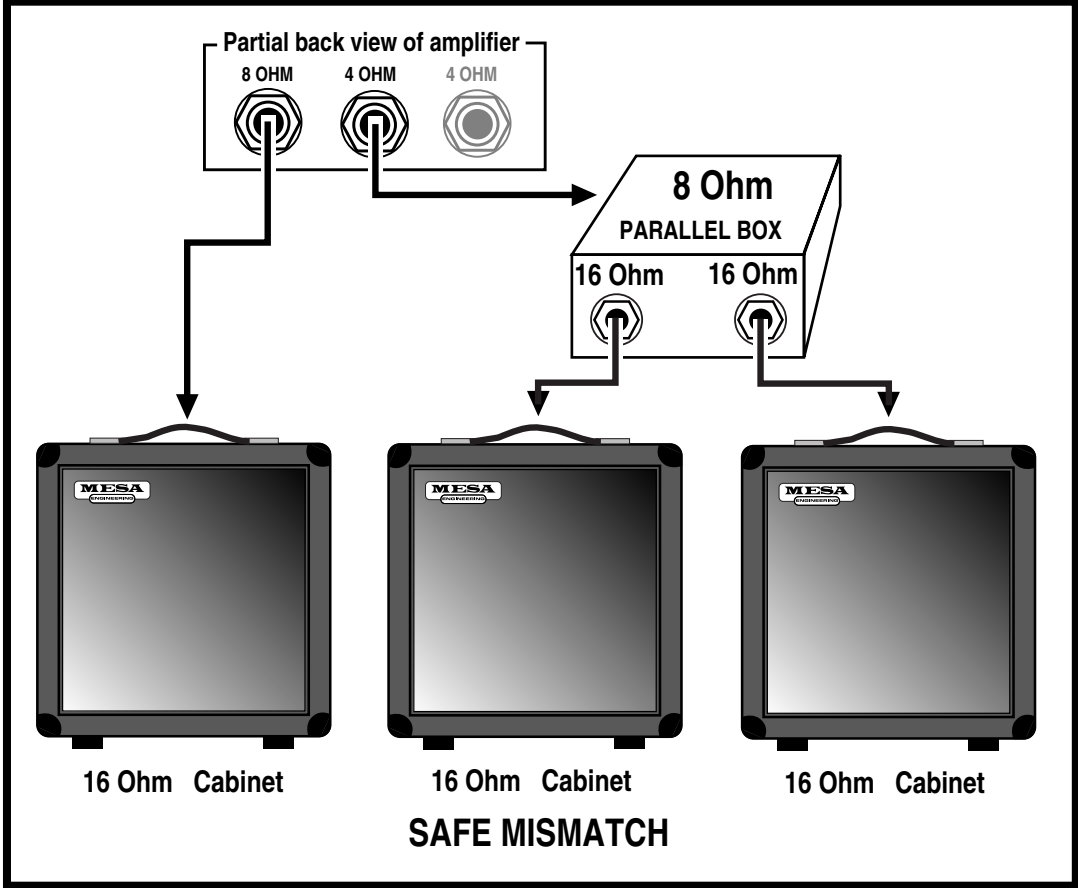

ON TRIODES, PENTODES & IRISHMEN:

With apologies to Friends and Relatives from the Emerald Isle - who will make their appearance soon enough - the humor which follows is dedicated to the memories of Spec McAuliff and Fae (Rafael) McNally, two of the True Greats.

As their numerical references suggest, the terms Diode, Triode and Pentode indicate the number of elements within the vacuum tube i.e. two, three or five. All tubes also require a filament or heater which is not included in the count. Its purpose is to excite electrons from the cathode coating by raising the temperature such that they are able to boil out of the electron-rich coating material and form a cloud of free electrons in the vacuum space surrounding the cathode.

Although the term filament and heater are often used interchangeably, there are specific differences: A filament is a directly heated cathode where cathode coating is applied directly to the heating element. Examples are 5U4 twin diode rectifier and 300B triode amplifier tubes. A heater, on the other hand, is a heating element which is separate from the cathode and is usually inserted within the tubular cathode sleeve. Examples are 12AX7 twin triode amplifier and 6V6 or EL84 beam power pentode tubes. In all cases this fundamental aspect of each tube's construction is clearly visible, especially when the heating element is glowing red hot.

The cathode, then, would be considered the first numbered element because it is the source of the electrons. The word itself is from the Greek literally meaning completely down, which implies a sense of central origin - like the center of the earth where Tone begins. It might be said that an ecstatic audiophile experiences a positive catharsis, his soul being purified when his system transports him to Audio Nirvana. The only trouble with taking this positive imagery too far is that the cathode is, unfortunately, negative... at least electrically speaking. However this is easily remembered since virtually all musicians and audiophiles have also experienced the more common negative catharsis when they emerge from the emotional rebirth kicking and screaming in rage and frustration.

Once heated, the intrinsically negative electrons are energetic little fellows of almost no mass. Thus they may be accelerated almost instantaneously and will travel through a vacuum a nearly the speed of light. Being of like, negative charge, they tend to repel one another and thus within the electron cloud surrounding the cathode, there is much jostling and elbowing as each one tries to maintain his distance from all the others... unless there is a strong and universal attraction from an outside influence.

Visualize, if you will, a group of sub-atomic Irishmen milling about and in a repellent, negative state of mind. All are scowling and none wants to have anything to do with the other. Now introduce a strong attraction say, a public bar, and you can easily picture an orderly, if rapid movement of the lot in a single direction. This is what happens when a positively charged element called the anode or plate is introduced into the vacuum.

The plate is the large metal element most prominently visible through the glass of an electron tube. It is the outermost element of a tube's structure and it surrounds all the others. The cathode is at the center radiating electrons outwards. As higher and higher positive voltage is applied to the plate, the attraction for the electrons surrounding the cathode is increased and with nothing standing in the way, full uninhibited flow to the plate occurs... sort of like removing the doors and offering free drinks to the crowd of surly Irishmen milling around outside. As electrons flow to the plate, the space charge will continually be replenished by further 'boiling' of the hot, electron-rich cathode as you can easily imagine other Irishmen impatiently taking up the places of those who've gone inside - until the entire village is deserted.

Now, where do they come from and how do they emerge? Well, a grand and elegant lady once showed me how to revive flat champagne: She dropped a raisin into the glass. There was a dramatic and immediate increase in effervescence with the introduction of a cathoding surface. Thousands of tiny bubbles suddenly appeared - and continued to flow from the raisin. Of course the bubbles were made up of gas dissolved in the beverage, but the analogy makes it easy to visualize the loosely bound electrons dissolved in the rich cathode coating as they effervesce from its heated surface.

But back to the electron flow. If the electrons are strongly attracted to a positively charged plate, then it follows that they are strongly repelled by a negatively charged plate and they are. Thus, if an alternating current - such as comes from a transformer - is applied to the plate, electrons will flow only during the times when the plate is positively charged. During periods of negative plate charge, electron flow is stopped and the space charge of electrons remains compressed in the area around the cathode.

ON TRIODES, PENTODES & IRISHMEN: (Continued)

Thus a diode tube - one with a cathode and an anode - is mostly used to rectify alternating current into direct current by passing it without restriction, but in one direction only. This also explains why closing time is strictly enforced at Irish pubs: During normal operation, the traffic flow is similarly unimpeded and uni-directional toward the bar and this process rectifies the work-day negativity. It goes without saying that no one leaves as long as the atmosphere around the bar remains positively charged.

TRIODES:

This section is a continuing technical treatise on the workings of Irish Pubs but to make it easier for the layman to understand, it is explained in terms of vacuum tube technology. Enter the original bar - free beer and no doors. Well, it turns out that some control over the flow can be a necessary and useful advantage. This led to the invention of those swinging louvered saloon doors which are open at the top and bottom. They are patterned after the control grid of the vacuum tube, which is a loosely wound coil of thin wire located between the cathode and the plate.

In a Triode the plate is always positively charged with high voltage D.C. and even though the grid is blocking the path, those negative electrons can still FEEL the strong attraction - just as the Irishmen can see in through the louvers of the bar doors. They know what pleasures lie beyond, but to get there requires overcoming the negative influences controlling the access. This negative influence is typically called a Bias. In electronic terms that means the grid is supplied with a voltage which is slightly MORE NEGATIVE than the already negative electrons. The more negative the Bias, the more it tends to neutralize the attraction of the plate and repel the electrons back toward the cathode.

The Irish can be similarly charged with Bias, but unless you are Irish yourself, this type of Biasing may be more difficult to understand. The effect is similar though: The more negative the Bias, the more it impedes forward progress. Generally speaking though, the electronic Bias of the grid is easiest to overcome, and for two main reasons: First, the Bias is set - like the bar doors - to allow some passage. Second, the grid is mostly NOT THERE, like the louvered doors which are mostly open spaces. Unlike the plate which is solid, the grid is like a coiled bed spring. It can create a repelling field but mostly it's empty space in between widely separated windings of wire. It's very easy to control the electrons as they pass through the grid's force field: Changing the grid voltage only slightly will have an enormous effect on how much current flows through... and that's what AMPLIFICATION is: a small change in voltage at the grid causing a large change in current flowing to the plate.

The purpose of the louvered bar doors is similar to that of the grid, namely, to give momentary pause while still revealing the promise within. Hesitation mostly gives way to temptation, but there are those few stalwart Irishmen who think twice and decide to come back later. Most just pause slightly then go on through. That is the purpose of the bar doors: to prevent everyone from crowding in all at once - and as the door is made less of a barrier, wider spaces between the louvers, more of the bar's attractive influence is felt outside thus amplifying the customer flow and increasing the crowd at the bar.

PENTODES:

Occasionally though, bar doors - even the louvered type - were found to be too effective, and too many customers turned away. Something further was needed to increase the attraction of the bar and overcome the resistance created by the door. Thus the cocktail waitress was invented.

Once again the idea was inspired by the vacuum tube. It had been discovered in some tubes, often large power types, that the distance to the plate was too great to attract enough electrons past the negative influence of the control grid. So another grid coil of fine wire was inserted between the first grid and the plate. This was called the screen grid and carrying a highly positive charge, it functioned as a "bait" for the plate.

In a properly designed power tube such as an EL84 or a 6V6, the windings of the screen grid are precisely aligned to fall in the shadow of the control grid. This way the electrons responding to the pull of the screen grid are lined up in sheets as they pass between windings of the inner control grid... only to find that they have been fooled! Once past the control grid and drawn toward the screen grid, they discover...there's almost nothing there. The path they're on has them aligned to zing straight through the spaces BETWEEN screen grid windings. So rather than a close and personal encounter, they just fly on past - and once they're out that far, there's no stopping them. The influence of the plate takes over and - being solid metal and of the highest positive attraction - it is at this final destination that the electrons congregate.

PENTODES: *(Continued)*

Thus the proper cocktail waitress - visible through the louvers - is scantily clad so as to be all the more effective at reinforcing the attractive influence of her bar and by being located in between the door and the bar, she serves as bait to lure customers past the door's negative influence. Once through the door however, it is the rare Irishman who actually comes in personal contact with the cocktail waitress as, for all intents and purposes, she - like the screen grid - turns out to be a vanishing illusion. Yet, having come this far, the solid influence of the bar itself now takes over and attracts the customers to congregate, having happily reached their destination.

If you're still following this and haven't lost track of the count, you'll know we're still one element short of the five needed to make a Pentode. This last part is a pair of beam-confining shields which being negatively charged, serve to direct the flow right toward the plate. This is much the way a short entrance hall to the bar prevents wandering accidentally into the Men's room on the way.

Once at the bar though, the circuit is complete and the process of soul-nourishing works its ritual magic. Biases having been overcome, illusory nightingales having vanished, the spirits truly soar and the once surly Irishmen now are filled with warmth, wit and kindred friendship, enjoying the music and glowing nicely with their heaters on.

With appreciative thanks to the inhabitants of the Land of the Leprechaun, we have now concluded our little diversion into the mechanics of proper bar lay-out.

A feature article by Randall Smith
Designer / President

TRANSATLANTIC TA-30

TA-30 - Combo

BEFORE CHANGING TUBES FLIP POWER SWITCH TO OFF

Tube Replacement

CONTROLS ▲

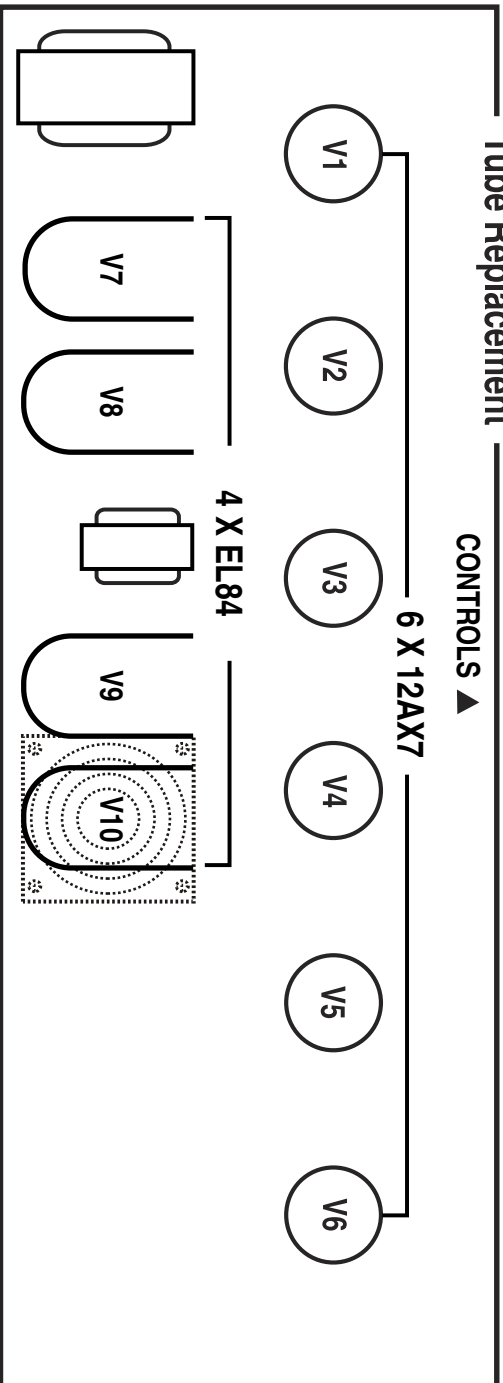

To maintain warranty use Mesa/Boogie tubes when replacement is necessary
 1317 Ross Street • Petaluma, California 94954 • (707) 778-6565

Preamp Tubes	
V1A&B	- Ch 1 Input Stage
V2A&B	- Input Stage for Ch2 - 2nd Gain Stage for Ch2
V3A&B	- Tone Control Driver for Ch's 1&2
V4A&B	- Driver/Phase Inverter
V5A	- Loop Return Stage
V5B	- Reverb Mixer
V6A	- Reverb Return Gain Stage
V6B	- Reverb Send Stage

Power Tubes	
40 Watts = V7-V10	
30 Watts = V7-V10	
15 Watts = V8, V9	

FRONT PANEL: TRANSATLANTIC TA-30

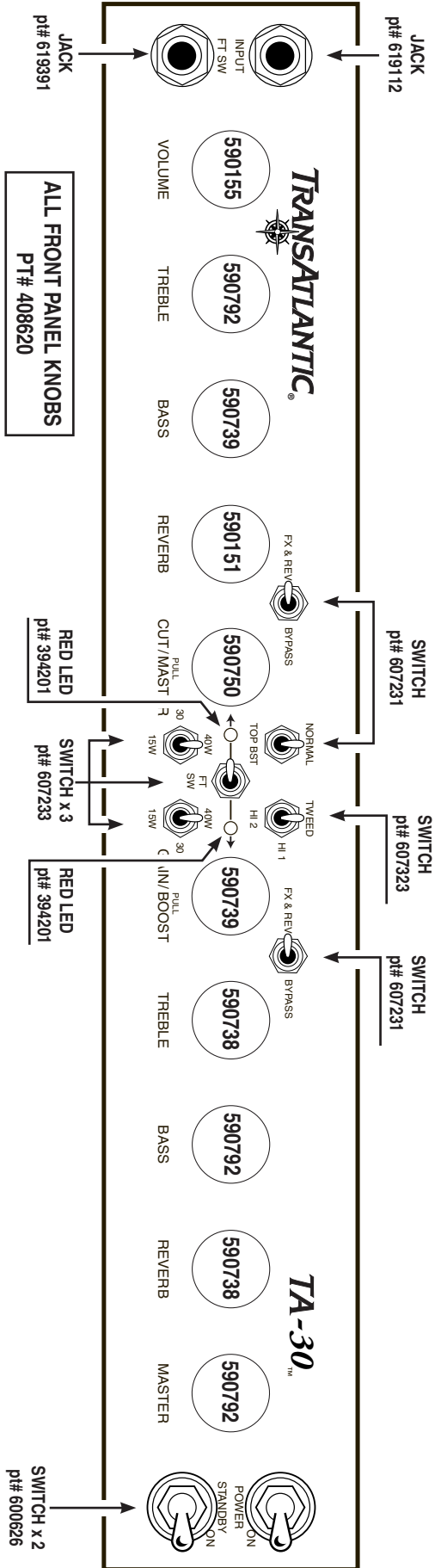

ALL FRONT PANEL KNOBS
PT# 408620

REAR PANEL: TRANSATLANTIC TA-30 Head

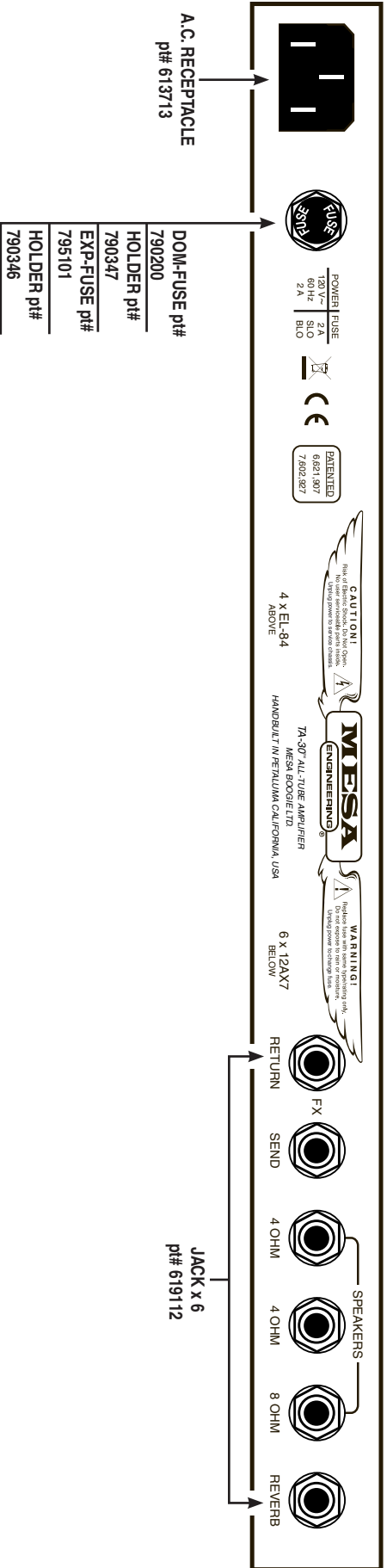

- DOM-FUSE pt# 790200
- HOLDER pt# 790347
- EXP-FUSE pt# 795101
- HOLDER pt# 790346

NOTES:

MESA/BOOGIE

The Spirit of Art in Technology

Thank you for trusting MESA/Boogie to be your amplifier company and we wish you many years of toneful enjoyment from this handbuilt all tube instrument.

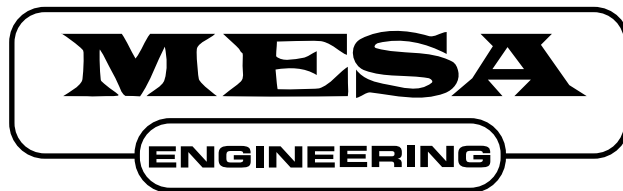

The Spirit of Art in Technology



(707) 778-6565 FAX NO. (707) 765-1503

1317 Ross Street Petaluma, CA 94954

USA