

MESA/BOOGIE[®]
TRANSATLANTIC[™]



Owner's Manual

Hello from the Tone Farm

Congratulations on your choice of the TRANSATLANTIC TA-15 and Welcome to the MESA/Boogie Family. The instrument you have chosen redefines the micro amp genre by including preamp and power options that seem near impossible for an amplifier with such a humble footprint. However, don't judge this dynamo by its size, but rather by the incredible Tone it produces that will allow you to access new levels of inspiration and expression.

Two footswitchable Channels cross the Atlantic with seamless finesse and give you a passport to the best British and American preamp sounds in two straightforward groups of four controls. The five preamp modes (2 in Ch.1 - 3 in Ch. 2) are selected with a simple mini toggle located in the top position in each Channel. Along with this array of iconic preamps the TA-15 offers three amazing power choices in each Channel, each of which allow you to perfectly tune the power to enhance each of the the preamp Modes. The result of all this flexibility is a fully capable live performance amp that would fit in your lunchbox, as well as a recording chameleon that can morph into virtually any classic you might need in the studio.

Our 40 year commitment to excellence along with our solemn promise to musicians - to treat each of them as we ourselves would wish to be treated - guarantees you an experience that will make you feel truly justified in your choice. We're confident your new amplifier will have you smiling and inspired within minutes of plugging in for the first time. However, what's really gratifying is that you will be finding new and inspiring sounds years after the price of admission has faded from memory and the TRANSATLANTIC continues to unveil its true worth.

It's with our sincere thanks for trusting us with your TONE and our best wishes for all your musical endeavors that we welcome you home. Should you ever need assistance or guidance we're here to help. You now have in your hands an instrument of limitless expression. Our hope is that it takes you and your playing to new and unimagined places throughout your musical journey. From all of us here at MESA...Enjoy!

TRANSATLANTIC™

TABLE OF CONTENTS

OVERVIEW _____	1-2
HELPFUL HINTS _____	2-3

FRONT PANEL CONTROLS & FEATURES

THE MODES: NORMAL, TOP BOOST _____	3
THE MODES: TWEED, HI 1, HI 2 _____	4-5
POWER MODES: MULTI-WATT POWER _____	5-6
INPUT _____	7
FOOTSWITCH _____	7
VOLUME / GAIN _____	7-8
TREBLE _____	8
BASS _____	9
CUT / PULL MASTER _____	9
CHANNEL SELECT _____	10
MASTER: CHANNEL 2 _____	10
POWER: OFF / ON & STANDBY _____	10

REAR PANEL CONTROLS, SWITCHES & JACKS

FUSE _____	11
A.C. RECEPTACLE _____	11
SPEAKERS _____	11

FACTORY SAMPLE SETTINGS & PERSONAL SETTINGS SHEETS _____	12-15
TUBE MAINTENANCE & DIAGNOSIS _____	16-17
BIAS ADJUSTMENT: A feature article by Randall Smith _____	18-20
SPEAKER IMPEDANCE & POSSIBLE HOOK-UP SCHEMES - Amps to Speaker Cab _____	21-26
TRIODES, PENTODES & IRISHMEN: A feature article on the workings of tubes _____	27-29
TUBE DESCRIPTION & TASK CHART _____	30
PARTS SHEET _____	31

IMPORTANT SAFETY INSTRUCTIONS

Read these instructions.

Keep these instructions.

Heed all warnings.

Follow all instructions.

Do not use this apparatus near water.

Clean only with dry cloth.

Do not block any ventilation openings. Install in accordance with the manufacturer's instructions.

Do not install near any heat sources such as radiators, heat registers, stoves, or other apparatus (including amplifiers) that produce heat.

Do not defeat the safety purpose of the polarized or grounding-type plug. A polarized plug has two blades with one wider than the other. A grounding type plug has two blades and a third grounding prong. The wide blade or the third prong are provided for your safety. If the provided plug does not fit into your outlet, consult an electrician for replacement of the obsolete outlet.

Protect the power cord from being walked on or pinched particularly at plugs, convenience receptacles, and the point where they exit from the apparatus.

Only use attachments/accessories specified by the manufacturer.

Unplug this apparatus during lightning storms or when unused for long periods of time.

Refer all servicing to qualified service personnel. Servicing is required when the apparatus has been damaged in any way, such as power-supply cord or plug is damaged, liquid has been spilled or objects have fallen into the apparatus, the apparatus has been exposed to rain or moisture, does not operate normally, or has been dropped.

To insure proper ventilation always make sure there is at minimum four inches (101.6mm) of space behind the rear of the apparatus. The ventilation should not be impeded by covering the ventilation openings with items, such as newspapers, tablecloths, curtains, etc. Do not impede ventilation by placing objects on top of the apparatus which extend past the rear edge of its cabinet.

No naked flame sources, such as lighted candles, should be placed on the apparatus.

The apparatus shall not be exposed to dripping or splashing and no objects filled with liquids, such as vases, shall be placed on the apparatus.

WARNING: To reduce the risk of fire or electric shock, do not expose this apparatus to rain or moisture.

The AC plug is the mains disconnect. The plug should remain accessible after installation.

WARNING: EU: permission from the Supply Authority is needed before connection.

WARNING: Always make sure proper load is connected before operating the amplifier. Failure to do so could pose a shock hazard and may result in damage to the amplifier.

Do not expose amplifier to direct sunlight or extremely high temperatures.

Always insure the amplifier is properly grounded. Always unplug AC power cord before changing fuse, tubes or removing chassis. Use only same type and rating when replacing fuse.

Avoid direct contact with heated tubes. Keep amplifier away from children.

To avoid damaging your speakers and other playback equipment, turn off the power of all related equipment before making the connections.

Do not use excessive force when handling buttons, switches and controls. Do not use solvents such as benzene or paint thinner to clean the unit.

Always connect to an AC power supply that meets the power supply specifications listed on the rear of the unit. Export models: always insure unit is wired for proper voltage. Make certain grounding conforms with local standards.

YOUR AMPLIFIER IS LOUD! EXPOSURE TO HIGH SOUND VOLUMES MAY CAUSE PERMANENT HEARING DAMAGE!

Your Mesa/Boogie Amplifier is a professional instrument. Please treat it with respect and operate it properly.

READ AND FOLLOW INSTRUCTIONS OF PROPER USAGE.

TRANSATLANTIC™

Instruction Manual

Overview:

While the **TA-15** control layout is rather sparse (compared to some MESA's), there is a lot more going on internally than might be apparent at first glance. Make no mistake, this is not a low line offering, but rather a power experiment in the world of micro. In every way the **TA-15** stands proud alongside any of our larger multi channel offerings with the same components, build quality, versatility and performance... an equal in every way except mass.

The two Channels offer Mode choices that roam the Atlantic with Channel 1 focusing on the British side of the Pond and Channel 2 incorporating both British and American sounds.

Channel 1 offers two Modes that pay tribute to the Vox heritage; a lower gain **NORMAL** Mode that delivers shimmering higher headroom clean sounds and **TOP BOOST**, our take on one of the most iconic Brit sounds that excels at clipped rhythm and lead sounds.

Channel 2 packs three Modes and this Channel alone offers more stylistically divergent landscapes than many whole amps. **TWEED** follows the Southern Cal vintage line to deliver gorgeous clean chording sounds that have more low end and breathy air than Channel 1's **NORMAL** mode and yet, clips smooth and furry when pushed. From there **HI 1** jumps back to the U.K. for a Brit style higher gain Mode that, when set lower, romps on vintage crunch rhythm sounds with stripped urgency. It also delivers searing high gain solo sounds that retain a crisp, definitive attack as the GAIN control is cranked. Finally, another crossing and you're back in Petaluma, CA for the smooth warmth of the high gain Boogie lead voice found in **HI 2**. This Mode adds low end girth and sweetens the attack frequencies to produced a fatter, rounder tone that is great for single note work.

Add to all this preamp versatility our patented Multi-Watt™ Power and you have the ultimate tools to craft a sound that is all yours. Multi-Watt allows you to match one of three perfect power response characteristics to each of the Modes and footswitch between two iconic sounds.

The 5W position on the mini toggle in each Channel captures the old world magic of 5 watts running in Single-Ended Class A which along with being ultimately clippable, emphasizes the even order 2nd harmonic and produces a truly precious blend of warmth and lined-up, chiming harmonics at low playing volumes.

FRONT VIEW: TRANSATLANTIC TA-15

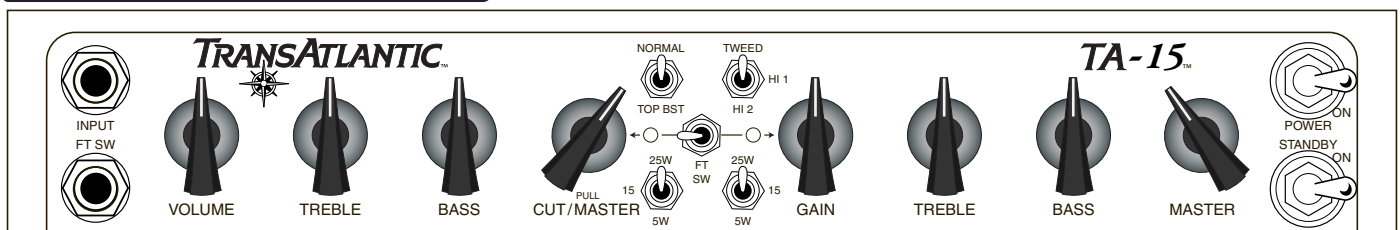

REAR VIEW: TRANSATLANTIC TA-15

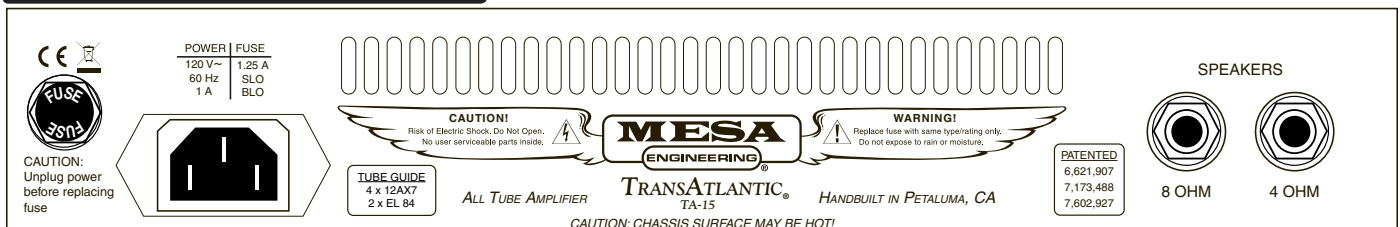

OVERVIEW: (Continued)

The 15 setting brings on a Push-Pull wiring scheme while remaining in Class A and pumps up the wattage for the perfect blend of vintage sound, manageable power and sweet, smooth clip.

From there things take a leap forward in time and power to our Patented Dyna-Watt™ power in the upper 25W position. This incredibly dynamic power scheme switches the wiring style to Class AB and allows the headroom to increase dramatically – more than you would ever expect from a 25 watt amp - by unleashing a burst of power at the instant of attack. Voltage is stored and released in a time-specific burst in the power supply as you play, creating punch headroom and tight-tracking authority well beyond your expectations of a “little amp”.

All this control over both the preamp architecture and power section wiring styles combined with the simplicity of the Gain and Tone Controls create a package that allows for instant gratification and long-term exploration. How you choose to enjoy the **TRANSATLANTIC TA-15** is your call, but we feel confident that no matter what type of stylistic arena you find yourself in, the tools are here for you to craft your own signature version of these classic sounds.

HELPFUL HINTS:

1. Cut the cable tie that holds the AC Power Cord to the Rear Tube Cover and connect it to a Grounded AC wall socket.
2. Connect the Mono ¼” Footswitch Cable to the Front Panel ¼” jack labeled FOOTSWITCH using the supplied Mono Cable.
3. Set the amplifier (and at least one speaker cabinet) on the floor you will be standing (or sitting on) while playing to complete the coupling circle that occurs. This will make the amplifier sound better, as well as feel better to play, because the sympathetic loop created by the transmission from your hands to the guitar to the amp to your guitar to your hands remains unbroken.
4. When powering up (especially from cold), always allow the power tubes time to warm up before hitting them with high voltage (STANDBY ON and playing). Turn POWER to ON, wait at least 30 seconds, **then** turn STANDBY to ON.
5. The center mini toggle labeled FT SW provides manual access to the Channels when the Footswitch is not connected. Left calls up Channel 1, right calls up Channel 2. **To use the Footswitch to access the Channels, select the FT SW (center position) and connect the Footswitch to the jack on the left bottom of the Faceplate labeled FT SW.**
6. A good general rule to follow; As the GAIN goes up, the BASS should come down. This will help prevent low-end flub and tubbiness and keep the attack tracking tighter. This is especially true in the TOP BOOST Mode of Channel 1 and the TWEED Mode of Channel 2 when searching for pushed sounds that lie somewhere between clean and dirty.
7. The CUT control in Channel 1 has a PULL MASTER function that allows you to run with the traditional “no master” architecture or, pull the CUT control and use that pot as a MASTER volume control for more overdriven sounds at lower playing volumes. When in the MASTER-Active mode, the CUT control is hard-wired to a medium setting that is balanced between open and compressed.
8. You will experience more footswitching noise (pop) when switching between Channels when only one is set to the 5W power setting. This is due to the more radical voltage changes that occur when knocking the power section down to the 5W level from one of the higher power modes. (Using both Channels in 5W will not create excess noise as the voltage doesn’t change). May we suggest when configuring your Channels for live performance footswitching applications, try using the 15 and 25W power modes whenever possible as the voltage swings are not as great. This will provide the quietest footswitching performance.

Now that you have an overview of the **TA-15**, let’s get more specific with the Modes and controls to learn how they can help you achieve the sounds you are looking for.

THE MODES:

CHANNEL 1:

NORMAL: This mode takes its architecture from the TOP BOOST circuitry and removes gain, adds brightness and fills out the bottom with a little more air and dimension. It works best for clean work and provides substantially more headroom than TOP BOOST. NORMAL is the choice when you need more stripped urgent clean sounds that will tuck up nicely in a mix. It is probably not the best choice for overdriven or clipped rhythm sounds as there is not quite enough gain to smooth out the jagged edges, and because of the added brightness it can sound a bit toward the ragged and buzzy when pushed too hard with weaker pickups.

TOP BOOST: This Mode represents our tribute to the amazing legacy of the British darling VOX. The TOP BOOST circuit has appeared in countless Boutique renderings of the last 20 years and is considered one of the must have staples in classic Rock guitar. Out of respect we chose to refrain from treading on this hallowed ground until such time as we could bring something worthwhile to the party... not to simply duplicate, but rather enhance this iconic sound. Well, with the inclusion of our patented Multi-Watt™ Channel Assignable Power and several other “trade secrets” we’ve unearthed over the last 40 years of amp design, the time has come to redefine a classic. Only you can be the judge if we’ve added something beautiful to the original, but our comparisons and the comments of our brothers in tone around the world... including our English ones, leave us feeling pleased with a job well done.

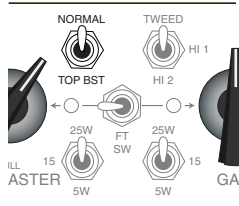

TOP BOOST is great for many things from urgent jangly cleans with a bit of attitude to full on saturated solo sounds, but probably its greatest asset is seen when riding the edge of clip. It seems to transition almost seamlessly from clean to saturation for there are many subtle graduations within this usually small realm that widen it to resemble an entire empire - instead of a narrow, hard to fine-tune band.

The choices found in the Multi-Watt Power switch greatly expand this edge-of-clip area and adds color to the mix along with harmonic and volume changes. For the most traditional response the 15W setting will provide the best blend of characteristics and the best balance of volume versus clippability. If you’ve ever played an AC 15 you will instantly fall into familiar territory where the subtle changes in your picking can push things in and out of clip with amazing expression. The 15W Power Mode also works well with TOP BOOST for using the guitar’s Volume control to take you from clean to varying degrees of saturation by rolling up and down without losing the sweet harmonic top end spectrum.

The 5W Power Mode will provide a sweeter blend of upper harmonics and allow you to bring the onset of clip down to very low volume levels. Watch the BASS control setting in 5W as the lower power is not capable of managing high levels of GAIN and BASS together. If you intend to run the GAIN control high when in 5W don’t be surprised to see your BASS control below 10:00 – or even off – to achieve tight tracking bottom end response. The (Dyna-Watt) 25W Power Mode will respond the opposite way and allow you to run both GAIN and BASS higher than in either 5W or 15W Modes. This mode is probably better suited to when you are using TOP BOOST for either really clean (GAIN 10:00 or below) or really heavy sounds (GAIN above 3:00) where you need the bottom end tight and percussive. In these two regions the extra power and headroom along with the accentuation in the upper mids that comes with this burst of attack-instant voltage release really focuses things and adds authority.

THE MODES: (CONTINUED)

CHANNEL 2:

TWEED: This is the lowest gain of the three Modes in Channel 2 and is aimed at clean and edge of clip sounds. It draws the framework of its circuit architecture from the early tweed amps from Southern Cal and then gets a healthy dose of magic from the 40 years of little secrets we've discovered to arrive at a beyond vintage level of Tone and performance.

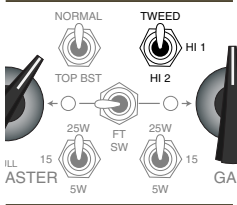

When using TWEED for clean work the 15W and 25W (Dyna-Watt) Power Modes provide the best blend of sparkle, warmth and headroom – with the 25W being the obvious choice for live performance situations. To explore the world of soft clip sounds in TWEED, set the GAIN high (3:00 – 5:30), the BASS low (8:00 – 10:30) and ponder the differences in 5W and 15W until you find just the right response for your needs.

Just keep in mind that it is always a good idea when looking for overdriven sounds, especially in the TWEED and NORMAL Modes, to reduce the BASS setting as you increase the GAIN control. This will avoid flubbiness and keep the attack tight and focused.

HI 1: We're back across the water again for a high gain tribute to the *other* great British amp and HI 1 captures all the tight attack, thumpy, tight bottom and midrange cut for which these amps are famous. HI 1 is the choice anytime you need attack and a higher, quicker feeling bottom end response.

Many players prefer this circuit for crunch or overdriven rhythmic playing, citing its percussive nature tracks tighter in the hands and is more defined in a mix. It also shines for use with shorter scale mahogany guitars that have a woodier, throatier top end and more lower midrange as a dominant part of their character.

When looking for single note solo sounds in HI 1 it may be necessary to run the TREBLE a little lower than you would for high gain chording, say somewhere in the 9:30 – 10:30 range to soften the attack and round out the notes a bit for a smoother more vocal character. When dialing up lower gain sounds in HI 1, whether for chording or lead work, try setting the BASS rather high - 1:30 – 3:30 – to add air and girth to the sound. In general, you can apply the BASS a little more liberally in HI 1 than in some of the other Modes as the increased upper midrange attack present here will keep things tighter longer and the frequency of BASS is a bit higher than in HI 2, so it can follow the attack a little easier in the time domain.

As far as power matching, HI 1 is pretty friendly with all three choices, however 15W and 25W showcase the classic Brit response best with 15W leaning toward smoother soloing and 25W excelling at tight percussive chording. The 5W position works good for lower to medium gain soloing, but don't expect it to be as tight or percussive for the rhythmic work as the two higher power Modes.

HI 2: Grab your suitcase, as again we cross the Atlantic on our tour of the world's most classic guitar sounds. This time we're back to Sonoma County, famous for wine and high gain guitar sounds. HI 2 is all about Boogie. Smooth, round attack, molten sustain and lined up layers of harmonics. This Mode is all about soloing. While you are welcome to explore its virtues for chording, it is single notes that most benefit from the deeper lows, slightly tucked mids and higher harmonic landscape found in this classic sound.

In the **TRANSATLANTIC** however, for continuity's sake, we've leaned just a pinch in the direction of HI 1 – slightly higher mid frequencies, a little more attack and a touch higher BASS than in other Boogie lead modes for two reasons. First, lower power amplifiers are simply not capable of pushing (steering/controlling) sub-low frequencies like their high power counterparts. They choke and lose definition when the BASS is too low and use all their available power trying to drag the low frequencies around. Second, guitarists – for the most part - are extremely conservative when it comes to sounds. Since most of us grew up listening to the same references, we want to hear easily identifiable classic sounds that fit into a category when we try an amp or guitar. We've seen over the years that players tend to stumble when there is a sound or mode in an amp that strays very far outside the "basic vibe" or style they perceive to be its "thang". For this reason we found it instantly more digestible to more players when we keep things more closely related.

THE MODES: (CONTINUED)

So in HI 2 you will find all the desirable qualities of your favorite Boogie high gain Mode, but find them fine tuned in a way that sits beautifully alongside the British flavor of HI 1. Plenty of difference to be recognizable... but not so different that it sticks out and feels out of place.

Power-wise HI 2 works well with all three choices. For bold authority and the greatest dynamic content, the 25W would be the choice. If you want a more liquid feel and more upper harmonic content, 15W is your ticket. And for all out insanity at whisper volumes for tracking there is always 5W with the greater potential to add power Tube overdrive. Don't overlook the 5W setting for lower gain solo sounds... especially in the studio. Some awesome lower gain Blues sounds are possible by setting the GAIN control low, say 10:00 – 11:00 and cranking the MASTER in the 5W Mode. You might have to reduce the BASS a bit to keep the attack focused, but it's very expressive with a different harmonic signature than getting all the gain from the preamp.

POWER MODES: MULTI-WATT™ POWER

While the **TRANSATLANTIC TA-15** is a veritable treasure chest of preamp sounds with the five different circuits tucked away in its hold, the Tone shaping choices don't, by any means, stop there. We always say "it's 50% front end and 50% power". The power section in any amp has a great deal to do with its response, character and feel. The **TA-15** is just as well endowed in the power play as it is in preamp choices.

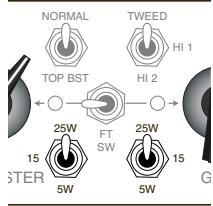

Our patented Multi-Watt™ Power allows not only the choice of Class of Operation, but also a choice in Wiring Configuration. You get three distinctly different power sections – each with its own character and feel to link - per Channel - with the preamp sounds you have crafted. The 5W and 15 W are old school classic power sections with their own signature voice and response and the **TA-15** would be amazing with these two alone. But we

had another patented secret up our sleeve and along with these two vintage-minded gems we've included a 25W Dyna-Watt™ power Mode.

Dyna-Watt™ has been appearing on lower power MESA amplifiers since 1986 when we released our STUDIO 22 combo. We've been using it ever since to shock people with an instantaneous burst of headroom and power present at the attack of the notes. Dyna-Watt stores and releases a burst of extra power and then sags in a time specific curve to deliver the boldness and punch of a big amp, with the light weight and friendly clip-ability of a low power amp. This addition allows the **TRANSATLANTIC** to be much more than a cute little desktop recording or practice amp, but rather a chameleon that can handle a diverse style of applications from low volume practicing to studio ace to medium size performance amp depending on how you choose to interface cabinetry.

5W: CLASS A SINGLE ENDED

This lowest output Mode is by no means the weakest. Its Class A biasing and Single-Ended wiring configuration produce the most vintage clip characteristics with a super smooth transition into power overdrive and an emphasis on the even order 2nd harmonic. The 2nd is an octave above the note you are playing and is the sweetest, most musical of all. Single-Ended wiring cancels out the harsher 3rd harmonic and allows the 2nd to put the angels touch on your tone. Low volume clean playing is absolutely gorgeous in this Mode in NORMAL or TWEED and may well become your favorite for practicing as you save your ears for the gigs.

The 5W setting is also great for overdriven sounds and when used with a degree of restraint on the GAIN control, can produce some of the best recording sounds ever. Remember that the 5W Mode can't drive the same amount of low end with control as the other two Power Modes and if you try the same sounds that work with those without adjusting both GAIN and BASS, you may end up with mush. The power section will inevitably be adding some additional overdrive and the BASS will not be able to stay tight. It's a good idea to craft tones with the power available in mind with the Mode you have chosen at all times. It is 50% responsible for the end result and if you learn to use both preamp and power Modes in harmony, you will find the **TA-15** to be one of the most expressive and versatile amps anywhere.

THE MODES: (CONTINUED)

15W: CLASS A CLASS A power has long been touted the Holy Grail of power wiring schemes for all out Tone and there is good reason. It produces an extremely smooth transition into clip, lush harmonics and an angelic quality to the sound. When pushed to clip, it responds with soft transients and never sounds harsh ever at the extremes. The **TA-15** puts this to good use by combining it with some of the most classic preamp circuits to allow a collection of the most sought after vintage circuits to exist in one very portable instrument.

The 15W Mode is great for both clean and overdrive sounds with enough power to provide ample headroom but low enough sweet sounding power to ride the edge of soft clip easily and controllably. This 15W Mode works great for players who prefer using the guitar's Volume control to step seamlessly in and out of the soft clip realm. This concept works well in both the two low gain preamp Modes NORMAL and TWEED as well as the three higher gain choices. The most dynamically responsive however will be TWEED (and to some degree NORMAL) as TWEED has just enough gain at the top of its range to assist in being the perfect zone between clean and drive.

The 15 W Mode is by far our favorite for the TOP BOOST preamp Mode and this combination holds true to the legendary circuit and performance this Mode pays tribute to. This power choice sweetens the jangly harmonics and cutting high mids present in the preamp and sounds open and bouncy as you roam between soft clip and all out overdrive. It is especially cool when the GAIN is cranked for single note soloing as the harmonic content is lush and creates an easy to play feel. Just remember to dial back the BASS a bit to keep things tracking well.

The same goes for using 15W in combination with HI 1 and 2. This combo produces a beautiful harmonic richness, but watch the amount of BASS you dial in, for it can get "slow" real fast if your not careful. Remember that these lower power settings simply don't have the horsepower to lead a bass-heavy signal around with any confidence.

25W: DYNA-WATT™ POWER As we mentioned earlier Dyna-Watt™ has been appearing on lower power MESA amplifiers since 1986 when we released our STUDIO 22 combo. This patented power harness delivers way more sonic impact that you would expect from an amp of this power rating and it does so with shocking speed and clarity.

It's all about dynamics! By storing up extra energy, releasing it at the instant of attack and then allowing the power to sag at a specific rate, a dynamic envelope is created that translates into a musical bounce. The strings come alive and everything has a bouncy, alive feel. Along with this tactile benefit there is the increase in perceived headroom and, because this extra energy is available at the instant of attack, Dyna-Watt can manage larger amounts of low end than that of your more commonly-wired 25W power section or the 5W and 15W Power Modes.

For clean work 25W has the headroom and spank to get over other instruments in a mix (in a situation realistic to its obvious limitations). It will stay the tightest at the upper limits of the **TA-15's** powerband as well as having more bold midrange punch and attack.

When searching for high gain sounds – especially for heavy, tight rhythm parts - that can track well and stay percussive Dyna-Watt is definitely the choice. This will allow you to dump in the maximum amount of GAIN and BASS and still have some dynamic control over things. It also works well for low gain Bluesy solo sounds where you want to jab in and out dynamically, sparring with the vocal to create an exciting interplay.

FRONT PANEL: Controls & Features

INPUT: This is the instrument **INPUT** jack. This jack feeds the preamp and since the *TRANSATLANTIC* is a high gain amplifier and therefore very sensitive, always use a high quality shielded cable between the instrument and the amplifier. This will prevent unwanted noise and microphonic cable sounds.

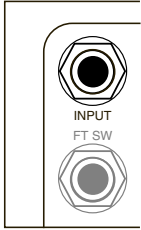

FOOTSWITCH: This 1/4 inch stereo jack is for connection of the Channel Select Footswitch. When the **FOOTSWITCH** is connected here with the provided mono cable, the Channels can be controlled remotely.

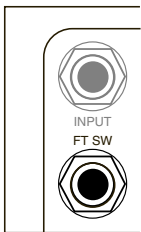

VOLUME / GAIN: These are the main front end controls in the preamp, no matter what Channel or Mode you are in, and they meter the amount of tube drive or saturation present in the signal. These controls are called by different names (**VOLUME**) in Channel 1 and (**GAIN**) in Channel 2, but they function in the same way and do essentially the same job... control the gain in the preamp. Their location in the circuit moves around depending on which Mode is called up, but their function remains the same - they determine the attack character, headroom and ultimately – how clean or dirty a given sound will be. For simplicity, from here forward we will use the word **GAIN** to speak of the front end control in both Channels - even though it is labeled **VOLUME** in Channel 1.

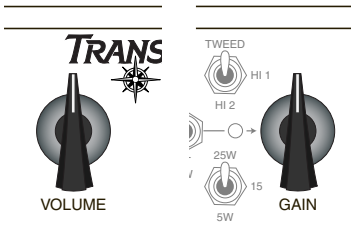

The **GAIN** also brings in and out upper harmonic content, depending on where it is set. As a general rule, the lower the setting – the more upper harmonics there are passing through. As you increase the **GAIN**, the natural tube saturation and compression fills in the sound, making things darker and more “round”. This trait can be used to your advantage – and in fact serves the practical applications well – as it means that lower gain clean sounds remain open and dynamic with abundant harmonics, while higher gain lead sounds get more compressed, warmer and more vocal.

Because the *TA-15* is essentially a low power instrument (even though it’s loud), using the **GAIN** control tastefully, with finesse and always with the Power Mode choice in mind is critical to achieving the best overall Tone. Unlike a 100 watt amplifier, the *TA-15* is most always adding some amount of overdrive or soft-clip into the mix – that’s part of its attraction – so it’s crucial to take that into account to keep your attack intact and preserve the dynamic content of your sound.

IMPORTANT ! Many of the *TA-15*’s best sounds are found with the **GAIN** control set in its middle range – somewhere in the 11:00 – 2:00 region. You’ll be pleased to discover all the nuance and expression found here – especially when you start to use the Power Modes as part of your Tone Crafting regimen. You’ll quickly find so much shaping power across those three hours (11:00 – 2:00) on the **GAIN**’s Tone Clock that you may seldom roam the higher regions as the balance between preamp and power is truly magical here.

If you do need to run the **GAIN** in its upper region for high gain heavy styles, then your best plan of action is to stick with the 25W Power Mode - as this will keep the low end as tight as possible and track the dynamic passages with more accuracy. However, don’t

FRONT PANEL: Controls & Features *(Continued)*

expect the same type of response you would find with these heavier sounds as you would from a 100 watt amp. The **TA-15** is indeed mighty in its class... but those little EL84's can't handle massive amounts of both preamp gain and huge low end like an amp running the larger octal-based 6L6 or EL34 type power tubes. Running the GAIN control high in the 15W and 5W Modes is perfectly fine to do, it just won't keep the attack very focused... especially as you increase the playing loudness.

NOTE - CHANNEL 1: *In Channel 1 the VOLUME control is both the front end (GAIN) control and the playing loudness or "master" control as well. We wanted to pay tribute to these sounds in the most reverent way and there was no master volume control on the original amplifiers - so as you turn up the VOLUME control in CHANNEL 1 - you are adding (gain) saturation AND turning up the playing volume. Purists have long identified with this "no master" scheme - citing its more urgent response, clarity and dynamic touch sensitivity. We agree with these observations to some degree - for these types of circuits - but there is little doubt that the trade-off for this stripped "no-master" approach is difficult to overlook when it comes to the flexibility department.*

So we gave you a choice by including a cool new feature for this type of circuit. When you need the old-school response of the original "no-master" scheme and the gain versus volume issues that inherently arise from this scenario are not a problem... crank it up and Rock!

But for those times when you **do** need control over the gain and saturation independent of the playing volume... pull the CUT control out and... problem solved, you now have a MASTER volume control! The CUT is preset to about 1/3 of the way on (rolling off just a little top end) and the same pot now functions as a fully independent MASTER volume control.

Again... **Pushed In, the CUT/PULL MASTER control functions as a CUT control** (rolling off high frequencies as you increase the control clockwise - almost like a reverse PRESENCE control). **Pulled Out, the CUT/PULL MASTER control becomes an independent MASTER volume.**

This "mod" to the original "vintage" architecture greatly enhances the flexibility of both NORMAL and TOP BOOST Modes and allows you to use them for many more sounds and footswitchable scenarios. It opens up the landscape for these sounds to be applied in new ways and allows them to interface to the modern world of sounds and yet retain their expressive charm and harmonic identity.

TREBLE: This control, while being the second most powerful control in the preamp, is very simple to operate... and when you've dialed in a little too much, it's easy to tell right away. The TREBLE controls how much of the high frequencies in the preamp will be blended in to the signal. This is another control to use in the middle ranges to produce the best balance of tone and noise. The TREBLE can bring in unwanted noise (hiss) when set to the extreme high end of its range (3:00 - 5:30) so avoid setting the TREBLE this high whenever possible.



Like the GAIN, the best sounds are found with the TREBLE in its middle range where an equal blend of highs from here are mixed in with the lows from the BASS (and GAIN). If you need things brighter in CHANNEL 1 - try leaving the CUT control set low (9:00 - 7:00). The top end that comes from there comes later down the line in the signal path - closer to the power section - and will produce less likelihood of noise and task the preamp tubes less.

Very high settings of the TREBLE control will increase the likelihood of microphonic tubes to start making noise and begin ringing or feeding back. It just adds too much top end into the signal path early and this is then amplified again and again making any sensitive tubes show their weaker side. This will be most critical in TOP BOOST in Channel 1 and both HI 1 and HI 2 in Channel 2 where the higher gain present will put more scrutiny on the preamp tubes.

In the TOP BOOST Mode of Channel 1 and the HI 1 Mode of Channel 2 you may find that the TREBLE wants to be set a bit lower than in some of the other modes and it is not uncommon to find it set below 11:00 for many great sounds... especially solo tones.

FRONT PANEL: Controls & Features *(Continued)*

BASS: The BASS is probably the simplest control on the **TA-15** and it simply dials in low frequencies to the mix in the preamp section. It is a less “volatile” Tone control than the TREBLE in that high settings will only cause an unbalanced sound, and not some other “stress” issue on the tubes or circuit. There is not really even a danger in speaker damage due to extreme settings as there might be in some higher power amps - as the power available in the **TA-15** is not usually considered high enough to be dangerous to most speakers.

VTIC™



Really, the main thing to keep in mind regarding the setting of the BASS control is to avoid dialing in too much and creating a flubby sound with compromised attack characteristics. Remember the old rule we mentioned earlier in the HELPFUL HINTS section... as the GAIN goes up the BASS should come down. While this is pretty general and maybe too all-encompassing, keeping it in mind will help you get to a great sound faster.

It is especially important not to run the BASS too high when searching for clipped sounds in the NORMAL (and sometimes TOP BOOST) Mode of Channel 1 and the TWEED Mode of Channel 2. When the GAIN is maxed out here things can get kind of ugly in the low end fast.

CUT (knob pushed in): This push-pull control is only found in Channel 1 and is responsible for determining the blend of high frequencies allowed to pass in the power section in that Channel. It works backward of most controls in that when it is increased (clockwise) you are increasing the “cut” of the high frequencies and therefore the sound is becoming darker and less bright. This takes some getting used to if you haven’t used one of these circuits before. It really is like a reverse PRESENCE control and if you think of it as such, it may help you in navigating the possibilities found here.



The taper of the pot used in the CUT control is a very slow one and was chosen because it is rare that you will use the control at its very highest (most rolled-off) setting. This way there is more fine resolution available to allow you to dial in just the right amount of “cut”. The only time you might find the extreme high region of the CUT appropriate is for fat single note solo sounds where it can remove huge amounts of sizzle and make things sound fat.

PULL MASTER (knob pulled out): As mentioned in the VOLUME/GAIN control description, the CUT control is fitted with an ingenious “mod” to the original “vintage” architecture and incorporates a pull pot that, when engaged, transforms the CUT into a MASTER volume control. When the MASTER function is engaged, the CUT is preset automatically to a setting of around 1/3 or in other words - 11:00 and this may not be altered as long as the control is pulled out and the MASTER is active.

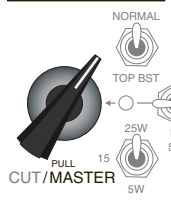

This feature greatly enhances the flexibility of Channel 1 and allows you to, unlike the original, use these sounds for an extremely wide array of both classic and modern sounds. It also allows you to create many more footswitchable Channel matches than would have otherwise been possible. And as for the purists you may come across who - in probable jealousy – try to point out the original version’s urgency, openness and dynamic character, you can politely agree, smile and then walk over and push in the MASTER and ask them if they want to try your “vintage”

rendering.

When you need the old-school response of the original “no-master” circuit - and the gain versus volume issues that inherently arise from this scenario are not a problem - the original vintage architecture can’t be beat. But when you need independent control over both gain and volume, there is little doubt that whatever the (miniscule) tonal trade-off for this stripped “no-master” approach is easy to overlook when it comes with the incredible flexibility it grants in return.

FRONT PANEL: Controls & Features *(Continued)*

CHANNEL SELECT: This 3 position mini toggle allows manual selection of the Channels when the Footswitch is not connected. Set it to the center FT-SW position to use the Channel Select Footswitch.

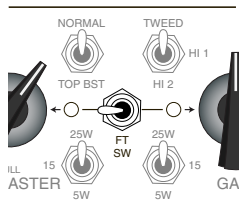

MASTER: CHANNEL 2 This control is the volume control at the end of the preamp that enables you to control the front end preamp level (with the GAIN Control) and consequently drive and saturation amounts - independently of the playing volume. This flexibility is critical for both crafting a wide variety amazing sounds that are accessible at any volume and footswitchable compatibility between Channels.

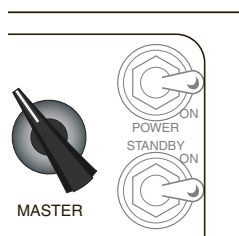

There is no real correct setting for the MASTER and no real reason not to run it either very low or very high for different applications. The most important job it handles is giving you the power to match the volume levels created in Channel 1 - whether you are using any of the three Modes in Channel 2 for a vast array of diverse sounds.

You may want to apply the GAIN rule here as well when using the MASTER very high with or without high GAIN settings; the higher the GAIN (and maybe MASTER) the lower the BASS setting... just to avoid flubbiness and a compromised attack.

POWER SWITCH: This switch delivers the A.C. power to the **TRANSATLANTIC**. Make sure the unit is grounded (all three terminals of the A.C. power cord must be connected whenever possible to avoid injury to the user as well as to the amplifier). Also, make sure that the proper voltage requirements are present at the A.C. wall socket receptacle.

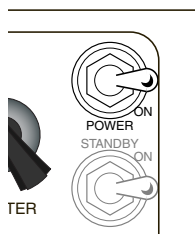

NOTE: As a reminder, never alter the A.C. power cord in any way for possible damage to the amplifier may occur not to mention the possibility of a fire outbreak.

STANDBY: Perfect for set breaks... this toggle switch also serves an even more important purpose. In the Standby position the tubes are at idle so that during power up they may warm up before being put to use. Before Power is switched on make sure the **STANDBY** switch is in the Standby position.

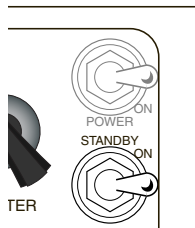

Wait at least 30 seconds and then flip the **STANDBY** switch to the ON position. This prevents tube problems and increases their toneful life substantially.

Well, that's about it for the CONTROLS. Now it's up to your sense of adventure and your willingness to explore. Whatever your style, your ability and your application, we sincerely wish you many inspired hours of discovery as you put the **TRANSATLANTIC** to good use in all your musical endeavors!

REAR PANEL:

REAR VIEW: TRANSATLANTIC TA-15

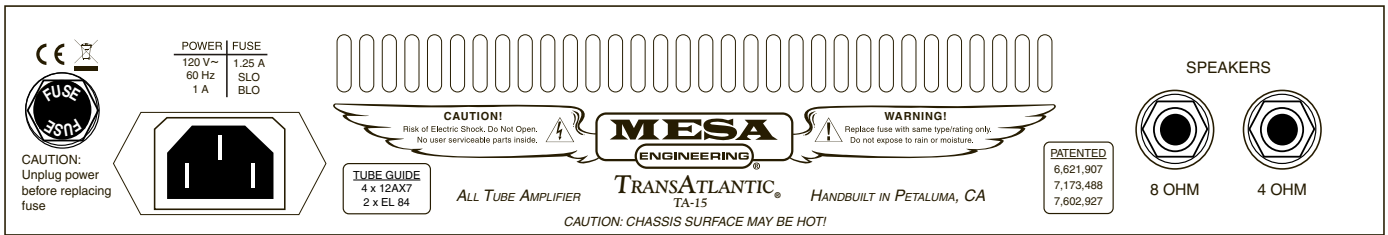

Now that we have reviewed the features and controls of the Front Panel and you have a handle on how they interact to achieve the sound *you* want, let's move to the Rear Panel and cover the features found there.

FUSE:

This is the A.C.'s (Alternating Current) main fuse and provides protection from outside A .C. fluctuations as well as power tube failure damage. Should the **FUSE** blow, replace it with the same rating in a Slo-Blo type package. The domestic U.S. version requires a 1.25 amp Slo-Blo **FUSE**. A power tube short or failure is often the cause of a blown **FUSE**...Follow the cold start procedure mentioned in the ON/STANDBY switch section and watch the power tubes as you flip the STANDBY to the ON position. If a power tube is going bad or is arcing you will see it! Flip the STANDBY switch to Standby immediately and replace the faulty power tube and the **FUSE** if necessary.

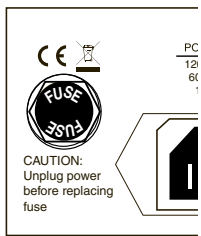

If you see nothing abnormal as you switch the STANDBY on, it is possible that a power tube shorted temporarily and blew the **FUSE**. If this is the case it may work again normally. To be safe, you might want to replace just the adjacent tube or all power tubes in the "shotgun" troubleshooting tradition and save the replaced set as spares. Spare fuses are a must for the fabled cord bag along with your spare tubes. Always carry both for they could

be worth their weight in gold someday.

A.C. RECEPTACLE:

The removable "Euro" Style" A.C. cord that is supplied with the *TRANSATLANTIC* makes set-ups and tear-downs after the gig a snap. Additional heavy duty cords are available should you ever need one...simply call us and we can ship one directly to you for a nominal charge, plus shipping cost. Make sure the A.C. cord is firmly in its socket (receptacle) before powering up the amplifier.

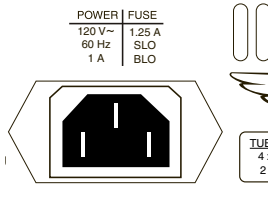

NOTE: NEVER ALTER THE THREE PRONG POWER CORD IN ANY WAY.

SPEAKERS:

The *TransAtlantic TA-15* provides one 8 ohm and one 4 ohm speaker output. This enables you to use many different combinations of speaker setups. You should experiment with different loading conditions as there may be a certain impedance mismatch that produces a sound you may prefer to the correct load condition. This will not hurt the amplifier, however mismatching in the higher direction will wear the power tubes faster. You will find sample speaker wiring diagrams later in this manual and when you get time it would be a good idea to browse this section to understand more about different ways you can use your *TA-15* with alternate speaker combinations. We build many different types of Extension Speaker Cabinets, all with unique characteristics.

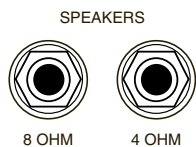

That covers the features, outputs and functions of your *TRANSATLANTIC TA-15*...now it's up to your imagination as to how best to utilize all this expressive power. If you have any questions or concerns unanswered in this guide, please feel free to call our Customer Service department and ask for a Product Specialist who will be glad to help you get the answers you need. *Cheers and Enjoy!*

SAMPLE SETTINGS

Spanky Clean / Blues Vibe

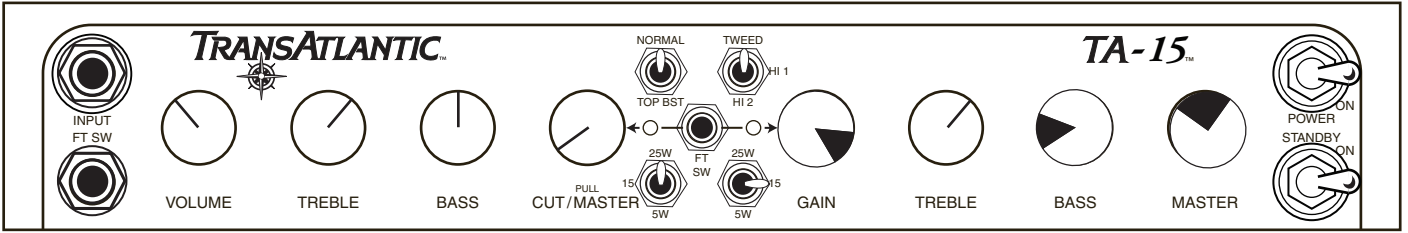

CUT
(knob pushed in) 15W or 5W

Clean Punch / Brit Crunch

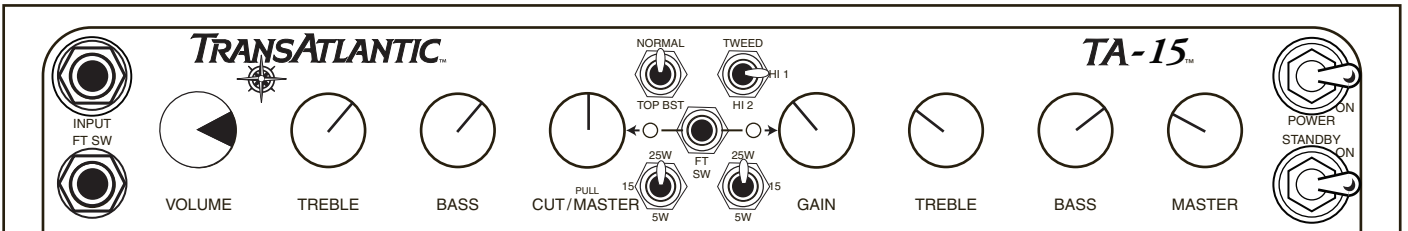

CUT
(knob pushed in)

Classic Brit Clean & Lead

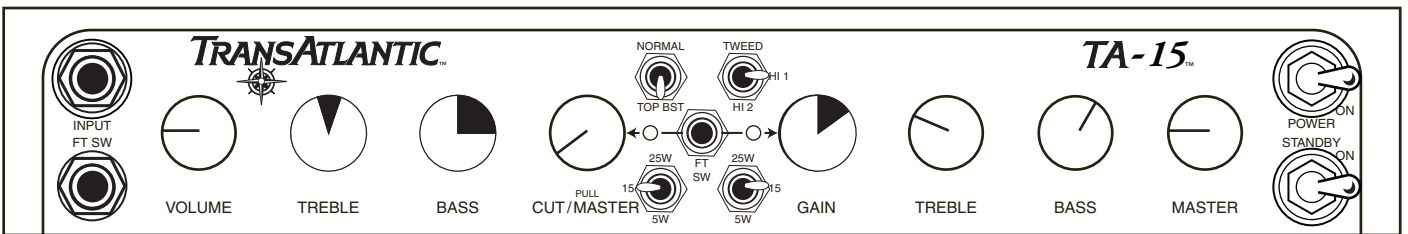

CUT
(knob pushed in)

Brit Break Up / Boogie Lead

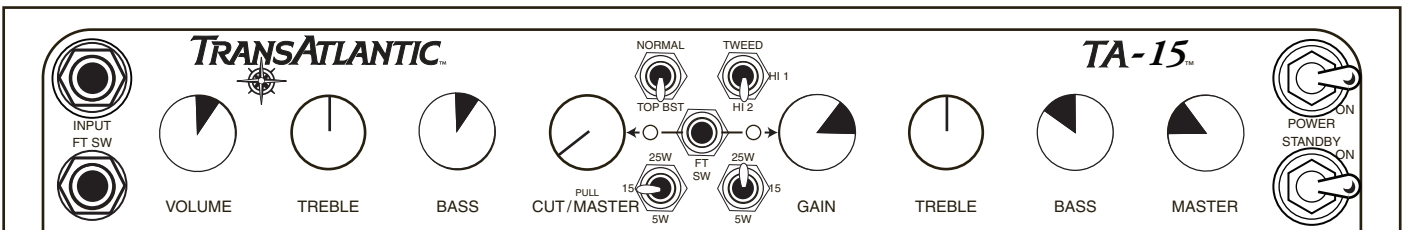

CUT
(knob pushed in)

SAMPLE SETTINGS

AC Solo / Vintage Clean

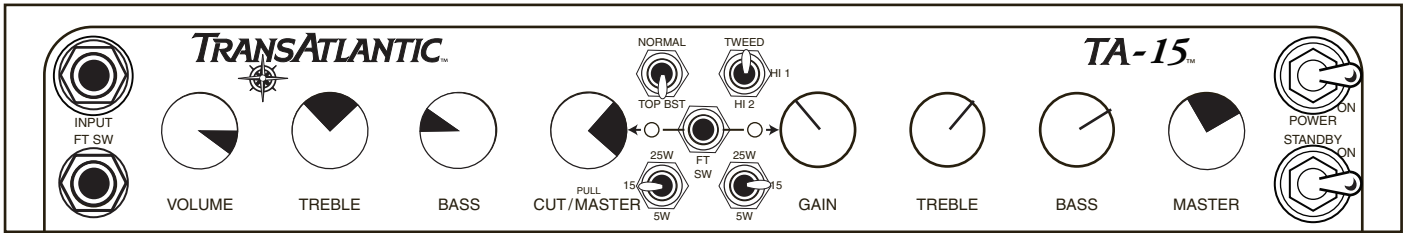

CUT
(knob pushed in) or *Pull Master As Needed*

AC Grind / Saturated Brit

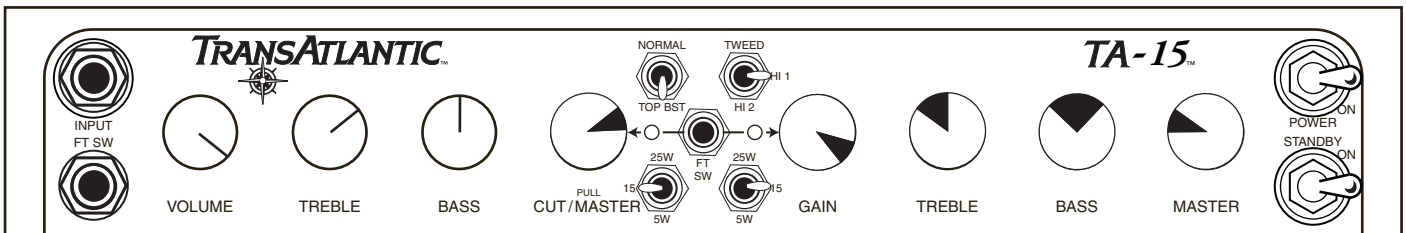

CUT
(knob pushed in) or *Pull Master As Needed*

Old School Bright Grind / Fat Clip

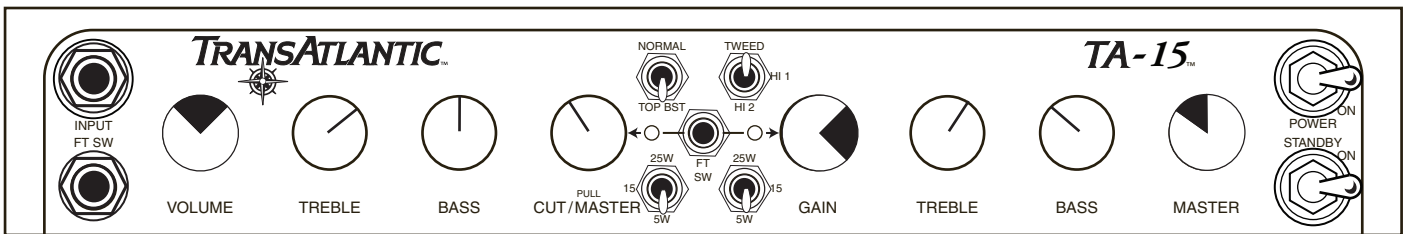

Pull Master As Needed
(knob pulled out)

Bright Edgy Clean / Burning Boogie

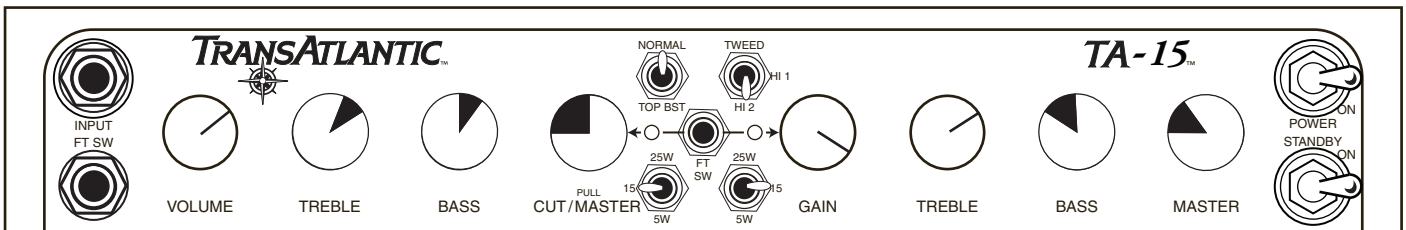

Pull Master As Needed
(knob pulled out)

USER SETTINGS

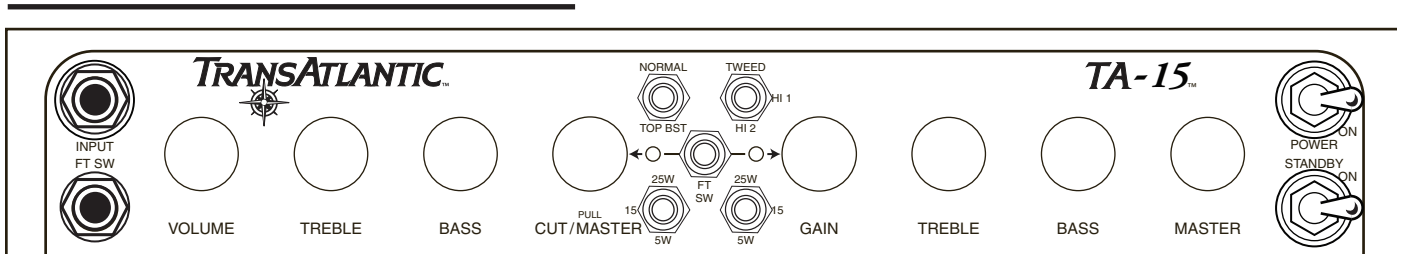
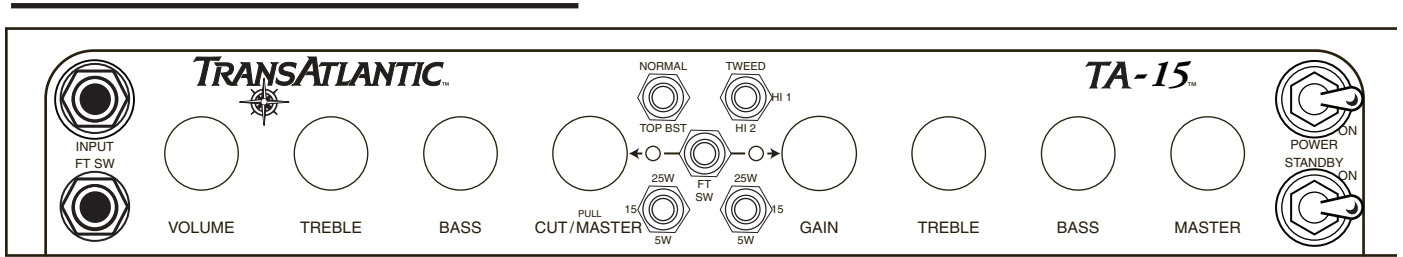
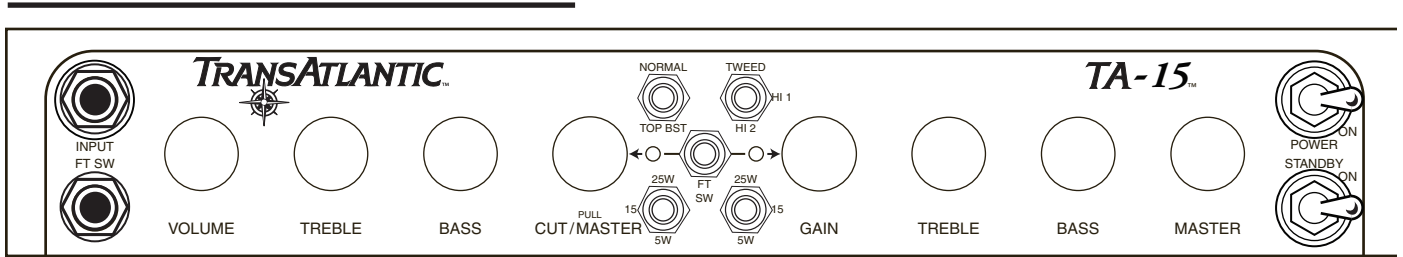
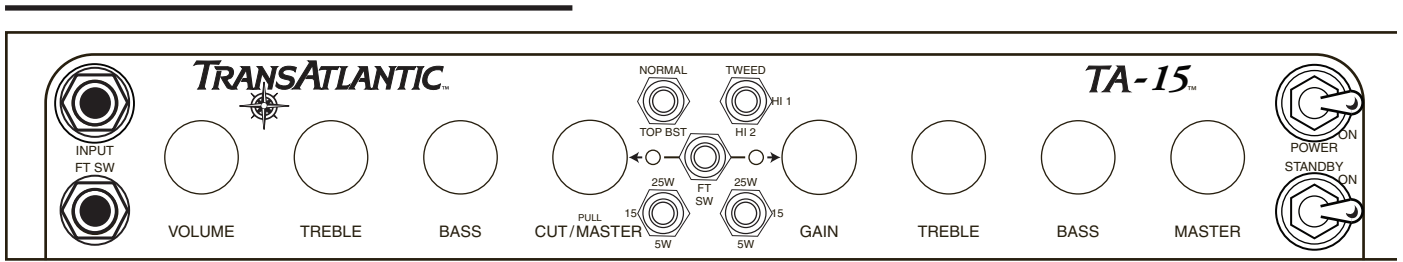

USER SETTINGS

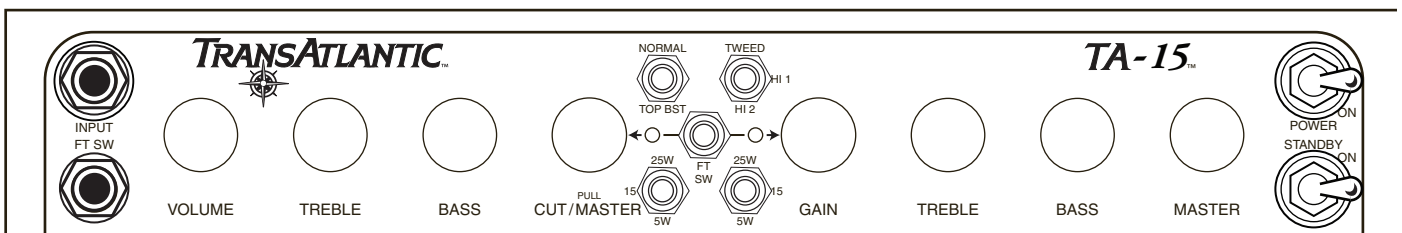
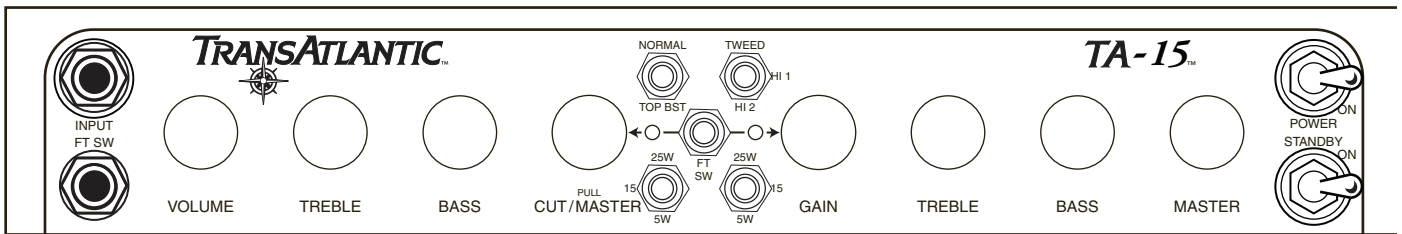
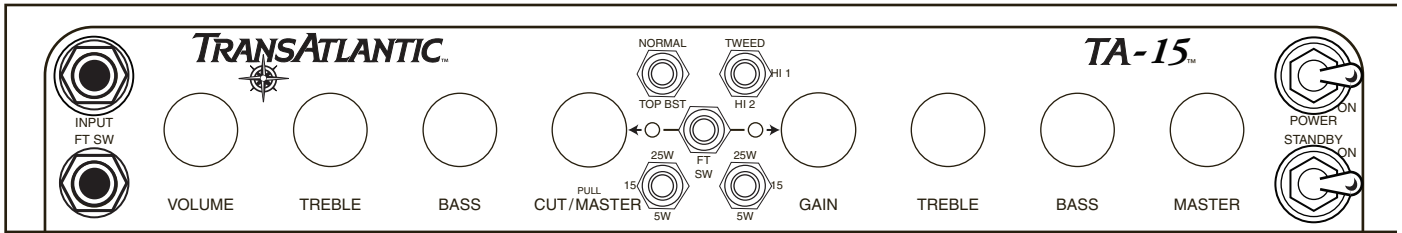
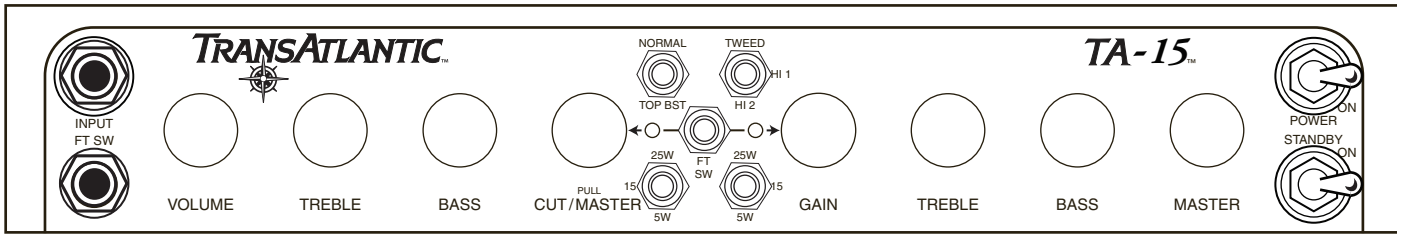

TUBE NOISE & MICROPHONICS: You may occasionally experience some form of tube noise or microphonics. Certainly no cause for alarm, this quirky behavior comes with the territory and the Tone. Much like changing a light bulb, you don't need a technician to cure these types of minor user serviceable annoyances and in fact, you'll be amazed at how easy it is to cure tube problems...by simply swapping out a pre-amp or power tube!

First may we suggest that you set the amplifier up on something so that you can get to the tubes comfortably without having to bend down. It also helps to have adequate lighting as you will need to see the tube sockets clearly to swap tubes. **Use caution and common sense when touching the tubes after the amplifier has been on as they may be extremely hot!** If they are hot and you don't want to wait for them to cool off, try grasping them with a rag and also note that the glass down around the bulbous silvery tip is considerably less hot which makes it easier to handle. Gently rock the tube back and forth as you pull it away from its socket.

DIAGNOSING POWER TUBE FAILURE: There are two main types of tube faults: shorts and noise. Both large and small tubes may fall prey to either of these problems but diagnosis and remedy is usually simple.

If a fuse blows, the problem is most likely a shorted power tube and shorts can either be mild or severe. In a mildly shorted tube the electron flow has overcome the control grid and excess current flows to the plate. You will usually hear the amp become distorted and begin to hum slightly. If this occurs, quickly look at the power tubes as you switch the amp to STANDBY and try to identify one as glowing red hot. It is likely that two of a pair will be glowing since the "shorted" tube will pull down the bias for its adjacent mates, but one tube may be glowing hotter — and that one is the culprit. The other two are often fine — unless they've been glowing bright red for several minutes.

Because there is no physical short inside the tube (just electrons rioting out of control) merely switching to STANDBY for a few moments then back to ON will usually cure the problem...at least temporarily. Watch the tubes carefully now. Should the problem recur, the intermittent tube will visibly start to over heat before the others and thus it can be identified. It should be replaced with one from the same color batch, shown on its label. Call us and we will send one out to you.

The severe short is not nearly so benign. In the worst cases, a major arcing short occurs between the plate and the cathode with visible lightning inside the glass and a major noise through the speaker. If this is seen to happen, IMMEDIATELY turn the amp to STANDBY. By this time the fuse probably will have blown. Such a short is usually caused by a physical breakdown inside the tube including contaminate coming loose or physical contact (or near contact) between the elements. Replace it and the fuse with the proper slo-blo type and power up the amp using the power up procedure as we described earlier in this manual.

TUBE NOISE: Often caused by contamination within in a tube, the culprit can usually be identified, and by lightly tapping on the glass, you will probably hear the noise change. Hearing some noise through the speakers while tapping on the 12AX7's is normal however. And the one nearer the INPUT will always sound louder because its output is being further amplified by the second 12AX7.

The power tubes should be all but quiet when they are tapped. If crackling or hissing changes with the tapping, you have probably found the problem. To confirm a noisy power tube, merely put the amp on Standby, remove it from its socket and turn it back on. It will cause no damage to run the amplifier briefly with one power tube missing. You may notice a slight background hum, however, as the push-pull becomes unbalanced. Whenever you are trying to diagnose a suspect tube, keep your other hand on the POWER and STANDBY switches ready to shut them off instantly in the unlikely case you provoke a major short.

If you think you've located a problem tube but aren't sure, we recommend substituting the suspect with a new one just to be sure of your diagnoses. You will be doing yourself and us a big favor by just following the simple guidelines previously mentioned regarding tube replacement. You'll probably be successful with much less effort than is required to disconnect everything and haul the unit to a technician who will basically perform the same simple tests. If the tubes are still within their six-month warranty period, we will happily send you a replacement. Just note the color designation on the tube label so that we can send you the appropriate match.

DIAGNOSING PRE-AMP TUBE PROBLEMS:

Because your amplifier is an all tube design, it is quite possible that you will at some point experience minor pre-amp tube noise. Rest assured - this is no cause for alarm and you can take care of the problem yourself in a matter of minutes by simply swapping tubes.

Let us begin by saying; It is a "very good" idea to keep at least a couple of spare pre-amp tubes on hand at all times to insure uninterrupted performance. These minor pre-amp tube problems can take many forms but can generally be described in two categories: Noise and Microphonics. Noise can be in the form of crackling, sputtering, white noise/hiss and/or hum. Microphonic problems usually appear in the form of a ringing or high pitched squealing that gets worse as the gain or volume is increased thus are more noticeable in the higher gain "HI" modes. Microphonic problems are easily identified because the problem is still present even with the instruments' volume off or unplugged altogether - unlike pick-up feedback which ceases as the instrument is turned down. Microphonic noise is caused by mechanical vibration and shock: think of banging a microphone around and you'll understand where the word came from.

The best way to approach a pre-amp tube problem is to see if it occurs only in one specific mode or channel. This should lead you to the tube needing replacement. Then all that remains is to swap the suspect tube for a known good performer. If you cannot narrow down the trouble to a specific mode or channel, the problem may be the small tube that drives the power tubes which is operational in all modes and channels. Though rare, a problem with the driver tube would show up in all aspects of performance - so if you can't narrow the problem down to being mode or channel specific, you may want to try replacing the driver tube. Driver problems generally show themselves in the form of crackling or hum in all modes of performance and/or weak overall output from the amplifier. Occasionally an anemic driver tube will cause the amplifier to sound flat and lifeless, but this is somewhat uncommon, as worn power tubes are a more likely suspect for this type of problem.

Sometimes making the diagnosis is more trouble than it's worth and it's faster and easier to merely replace the small pre-amp tubes ONE AT A TIME with a replacement known to be good. But MAKE SURE you keep returning the tubes to their original socket until you hit the one that cures the problem. You'll notice that tubes located nearer to the INPUT jack always sound noisier...but this is because they are at the start of the chain and their noise gets amplified over and over by the tubes that follow. The tube that goes into this "input socket" (usually labeled V1) needs to be the least noisy of the bunch. The tube that goes at the end of the preamp chain - just ahead of the power tubes - can be quite noisy without causing any problem at all. The tubes in your amp have already been located in the most appropriate sockets and this is why you should NEVER pull them all out at once and ALWAYS swap them one at a time. ALWAYS return a perfectly good tube to its original socket. Also it's a good idea to put the amp on STANDBY when swapping tubes to reduce the heat build up in the tubes themselves and to prevent explosive noises (which can still occur even if you are pulling the tubes away from their sockets gently) from coming through the speaker.

Remember, take your time, be patient and chances are real good that you can fix your amp yourself by finding and replacing the bad tube. It kills us to see someone who has shipped their amp back to us...and all it needed was a simple tube replacement! If you must send back your amp, remove the chassis from the cabinet by unscrewing the four mounting bolts on the bottom top. The chassis then slides back like a drawer and comes out from the back. Remove the big power tubes and mark them according to their location from left to right 1, 2 etc. They need to be wrapped separately with plenty of wadded up newspaper around them and put in a smaller box within the larger carton. Remove the Rectifier tubes and wrap them also. You can leave the preamp tubes in or remove them and wrap them separately being sure to label their location. (See Tube Task Chart.)

To wrap the chassis, use plenty of tightly wadded up newspaper so there is at least six inches of "crush space" between the chassis and the cardboard box. Bubble wrap also works well, but please DON'T use styrene peanuts - they will shift during transit and get lodged inside your electronics as well as allowing your amp to end up at the bottom of the box unprotected and possibly damaged.

Pre-amp tubes don't normally wear out as a rule. Therefore, it is not a good idea to change them just for the sake of changing them. If there isn't a problem - don't fix it. If there is no result from your substitutions, it may be possible that you have more than one problematic tube. Though rare, this does happen and though it makes the troubleshooting process a little more intimidating, it is still possible to cure the problem yourself.

NOTE: *It is normal to hear a slight metallic ringing sound when tapping on the preamp tubes. As long as the tube does not break into oscillation or start crackling or any other form of bizarre noise, it is considered normal and functional.*

BIAS ADJUSTMENT: *(Part of a continuing series)*

An Article written by Randall Smith that we thought you might find interesting.

Here's a question we often hear:

"Why doesn't *Mesa* put bias adjustments in their amplifiers?"

Well, there's a short answer and a long answer to this question.

The short answer is that during my 12 years of repairing Fenders, one of the most frequent problems I saw was bias controls that were either set wrong or that had wandered out of adjustment due to vibration. As any honest tech will tell you, there's lot's of easy money to be made by sprinkling "holy water" on amplifiers ... uh, what I meant to say is "Your amp needed biasing." See what I mean? What customer is going to argue with that?

It only takes a moment and a volt meter: The Fender diagram shows how: "Adjust this trim pot for - 52 volts." That's it. Nothing more.

Now don't be fooled into thinking that tubes "draw" more or less bias, they don't. The way a bias supply is connected to a tube is akin to a dead end road, it just trails off to nowhere without really completing a circuit. It's a static voltage and regardless of what tube is in the socket — or even if the tubes aren't plugged in at all, it doesn't change the bias voltage a bit.

So the end of the short answer is this: Since a bias supply needs to put out the right voltage and never vary, I wanted to build amplifiers that were individually hard wired to the correct values and NEVER needed adjustment. And for 25 years, that's how *MESA/Boogies* have been built.

Time to change tubes? Just plug our tubes into any one of our amps and you're DONE. No tech needed. NO bills and no BS about biasing. And most important: The bias is RIGHT because it can't change!

Now, you want the long answer? Here's more information on how our hard-wired bias avoids trouble. Please read on.

But first, let's make an important distinction. Our business is designing and building high performance amplifiers. And for this we need tubes whose variance is within a narrow range. Our warehouse is full of rejects ...oh, they work — they just don't perform within our tolerance range. We have a very sophisticated computer - based tube testing system (nicknamed "Robotube") that matches and measures tubes over seven important parameters. It can even predict which tubes are likely to have a shortened lifetime — even though they work perfectly during the test.

Because our business is building quality amps, we can afford to reject a lot of wayward tubes. The guys you hear complaining because *Boogies* don't have bias adjusters are primarily in the business of selling tubes - not amps. They don't want to throw away 30 percent of their inventory, so they promote the idea that tubes outside our parameters can be used to "customize" amplifiers and they criticize us because our amps can't be adjusted to accommodate their out-of-*MESA* tolerance tubes.

Now you might be thinking, "But I thought you just said that tubes don't "draw" bias, therefore they don't effect the bias supply and thus it doesn't need to be adjustable." When you set the bias (whether it's by selecting the right resistors, as we do, or adjusting a trimmer — which is quicker) what you are doing is establishing the correct amount of idle CURRENT that flows through the power tubes. But you can't adjust the current directly, you can only change it by adjusting the amount of bias VOLTAGE that goes onto the tubes' control grids. Voltage and current are NOT the same. Current is the AMOUNT of electricity, the "quantity" — and is measured

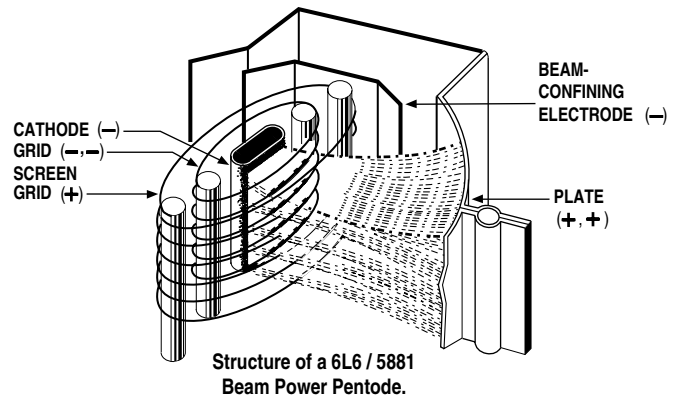

in amperes. Voltage is the degree of electric charge — like the “pressure” to use the old water analogy. Let me illustrate how different voltage and current are:

When you scrape your feet across a carpeted floor in dry, wintery conditions, your body can become charged with 50,000 to 100,000 volts of static electricity. And when you reach for the door knob, a spark jumps and you feel it! The voltage is super high but the current (measured in micro-amps) is tiny - otherwise you would die from electrocution.

Contrast this with your car battery, which puts out a mere 12 volts. You can lay your hands right across the terminals and not feel a thing. Yet the amount of current available can run to several hundred amperes .. enough to turn over a cold engine and get it started.

So current and voltage are two totally separate electrical parameters — though when you multiply them together, you get POWER, which is measured in watts.

When you set the bias of an amplifier, you are adjusting the static VOLTAGE at the control grid of the tube in order to produce a desired amount of idle CURRENT flowing to the tube’s plate. A small change in grid voltage, produces a large change in the amount of current flowing — and that’s basically how a tube works. Say that again because it’s super important: A small change in voltage at the grid causes a large change in current flowing to the plate. See, that’s the essence of amplification: A small change causing a large change. And here it’s a small voltage change causing a large current change.

The bias conditions are what determines how much current flows through the big power tubes when you’re not playing. And what drives your speakers is fluctuations in that current flow when you ARE playing. If the amount of current increases and decreases 440 times per second, then you’ll hear an A note. If the fluctuations in current flow are large and still at 440 per second, you’ll hear an A that is LOUD!

But for purposes of biasing, it’s the amount of “plate current” flowing with no signal applied that’s important. Unfortunately current is hard to measure because the circuit must be interrupted — as in “cut the wire” — and the meter spliced “in series” with the broken circuit. But measuring VOLTAGE is easy. It is not necessary to interrupt the circuit because a voltage reading can be taken in PARALLEL with the circuit intact.

Thus, as a matter of convenience, most bias settings are given in volts at the grid ... even though current through the plate is the important factor. In fact plate current is so inconvenient (and dangerous) to measure that Fender doesn’t even state what the correct value should be. They only give the grid voltage that will produce that current. (That’s the minus 52.) But that only happens if the tubes being used are “in spec.”

As long as the tubes ARE “in spec”, the right bias voltage will always give the correct plate “CURRENT” — but then there’s no need for the bias voltage to be adjustable!

If the tubes are NOT in spec, then the only proper way to re-set the bias is to cut the circuit and measure the current while adjusting the bias ... but no manufacturer I know even STATES the desired current value! Be that as it may, when the original bias voltage is altered far enough, it will compensate for the tube’s abnormal performance and the correct amount of idle current flow may then be restored. Clearly this is something most repair techs should not attempt.

Some newer amps have LED indicators connected to the circuit which will turn on when the right threshold of current flow has been reached. This is an improvement, and almost worthy if you’re willing to accept resistors and lights added into your amplifier’s audio path — which we aren’t.

The other “advantage” of this system is that it allows some amp manufacturers to avoid matching their power tubes. The thinking is that adjusting the bias to each tube separately eradicates the inherent differences between the tubes by insuring that the same current flows through each one.

BIAS ADJUSTMENT: *(Continued)* Again, this has some merit .. but it's still not as good as using tubes that are matched in the first place because compensating for the mis-match causes the push-pull circuit itself to become unbalanced. Two wrongs don't really make a right.

Some of the other recommended biasing, "methods" — such as -".. tubes running red hot, increase the bias .. sounds harsh and runs too cool, turn it down ..." are guesswork at best. Luckily, one of the great things about tube amps is that they can usually stand some abuse without causing any real harm ... at least not immediately. But don't these alterations imply that you are second-guessing the amp designer and that there's a better set of operating conditions that the designer missed but the tube sellers have discovered?

Now some players may like the sound of their amp altered by tubes with extreme characteristics and with the bias set to help compensate. But often it is the mere novelty of change that they're really responding to and when the amp goes back to the proper original way, we've seen them be far happier still!

Because every part in every one of our designs has been meticulously evaluated, compared and stressed over — no matter how seemingly insignificant it might be. And with every design we look for a "sweet spot" where all the parameters — including the bias — come together to give the best sonic performance, consistently and reliably. Every part and voltage is important — yet no one complains that these other parameters aren't available for tinkering.

Consider our patented *Simul-Class* circuitry where there are two different bias voltages used for separate pairs of power tubes ... and changing one voltage also changes the other. Great care goes into getting this just right and we think we'd be asking for trouble to have it adjustable for the world to play with ... unless you like paying to have your amp messed up. Sorry, I meant to say, "Uh, ... your amp needed biasing."

If that doesn't appeal to you, then merely plug a matched set of *MESA* tubes into one of our amps and you're ready for tone. Guaranteed. You'd be amazed at the number of service calls we field every day that lead to a diagnosis of out-of-tolerance, non-spec tube problems. To think these would be prevented by including a bias adjustment is something of an insult to you and us. If you put the wrong size tires on your car, do you think changing the pressure will make them right?

Please, don't think this is a blanket indictment of the other guys selling tubes — it isn't. And their tubes aren't all bad either. It just doesn't make sense to pay more of your hard earned cash for tubes that were probably made in the same Russian or Chinese factory and which have the possibility of being outside the performance window we select for your amp. And it pains us to hear the hype and mystique built up around biasing when twenty-five years of evidence affirms our decision to make bias circuits that "never need adjustment". How much money and trouble that has saved *MESA/Boogie* players you couldn't estimate.

Our rigorously tested and hand selected tubes are available at your nearest *MESA/Boogie* Pro Center or from us directly. Nobody offers better price, quality or warranty than we do ... so why swerve?

Cheers!
MESA/Boogie Ltd.

SPEAKER IMPEDANCE MATCHING & HOOK-UP GUIDE:

IMPEDANCE: Wiring up speakers to provide the most effective load and making sure that all of them are in phase will help in creating the best sound possible. This is not too difficult, as long as you understand a few things about loading and how to connect your speakers to provide an optimal resistive load.

MESA/Boogie amplifiers can handle 4 and 8 ohms effectively. Never run below 4 ohms in a tube amplifier unless you are absolutely certain that the system can handle it properly; this can cause damage to the Output transformer. A few amplifiers can handle 2 ohms effectively without damaging them (for example the *MESA'S Bass 400+*). You can always have a higher resistance (16 ohms, for example) without damaging results, but too low of a resistance will likely cause problems.

MIS-MATCHING: When running a higher resistance (for example: 8 ohm output into 16 ohm cabinet), a slightly different feel and response will be eminent. A slight mismatch can provide a darker smoother tone with a little less output and attack. This response is a result of the amplifier running a bit cooler. Sometimes when using more than one cabinet a mismatch will be the only option.

WHAT IS MY CABINETS IMPEDANCE: If you have only a single speaker, you just match that single speakers impedance to the amplifier, and you are done. In many cases, you will have a number of speakers, and then you must calculate the "load" that the amplifier will need to support. There are generally three ways to wire multiple speakers together. They are as follows:

SERIES: When you wire (hook-up) speakers in Series, the speakers resistance (as measured in ohms) is additive - i.e. putting two 8 ohm speakers in Series results in a 16 ohm load.

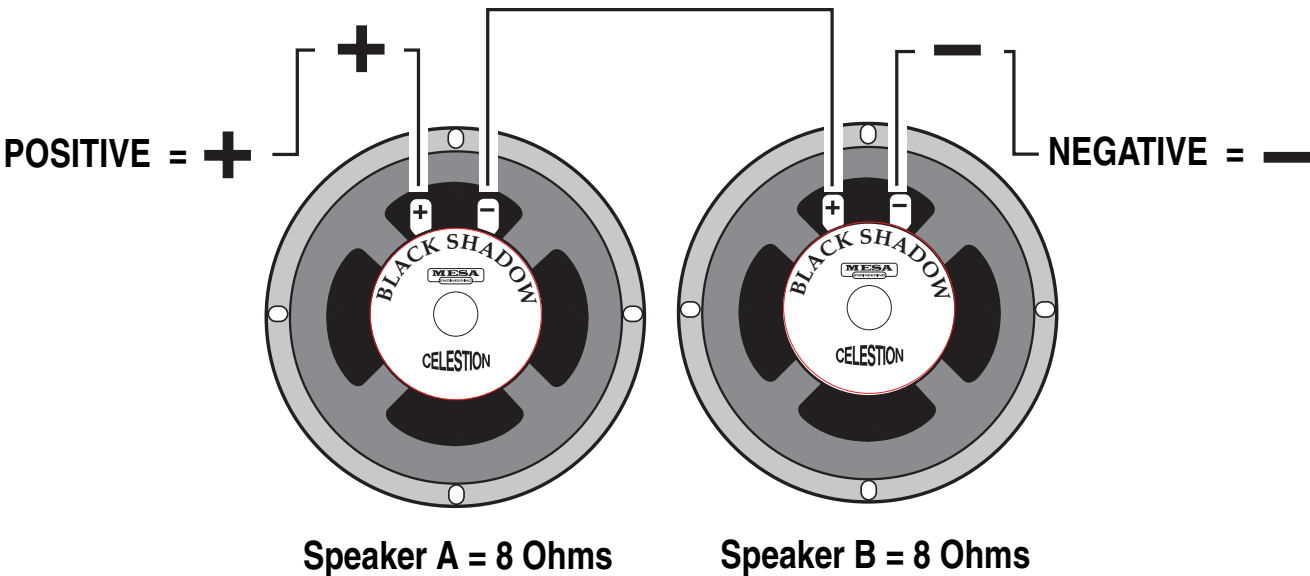

SERIES: Connect the Negative side of Speaker A to the Positive side of Speaker B

SPEAKER IMPEDANCE MATCHING & HOOK-UP GUIDE: (Continued)

PARALLEL: When wiring in parallel, the resistance of the speakers decreases. Two 8 ohm speakers wired in (hooked-up) Parallel results in a 4 ohm load. It's easy to calculate the effect of a resistive load when all the speakers are all the same resistance. It is really not suggested to wire different resistive load values in Parallel (8 and 4, 16 and 8 etc.) The formula for figuring the total impedance in Parallel is the multiplication of the two loads divided by the sum of the two loads - i.e. putting two 8 ohm speakers in Parallel results in a 4 ohm load. Connect the Positive side of Speaker A to the Positive side of Speaker B - Connect the Negative side of Speaker A to the Negative side of Speaker B.

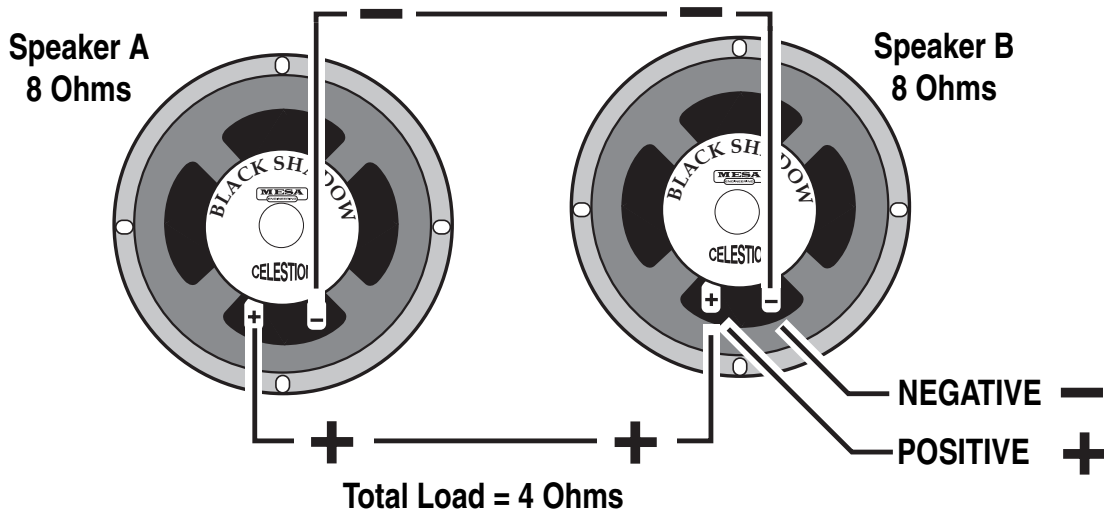

COMBINATION OF SERIES & PARALLEL: This is really just two sets of Series wired speakers connected in Parallel. This is how you maintain a consistent load with multiple speakers. The importance of this is more evident when you have more than one cabinet to connect to your amplifier. This is when you need to figure out the loads and how to wire them up without applying too low of a resistance on the amplifier.

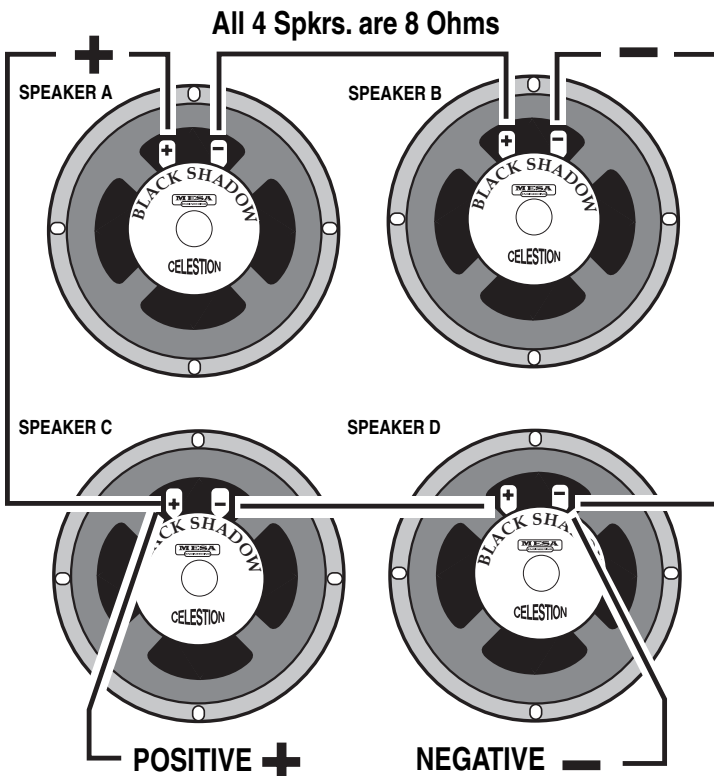

Simply connect the Positive side of Speaker A to the Positive side of Speaker C.

Connect the Negative side of Speaker A to the Positive side of Speaker B. Next, connect the Negative side of Speaker C to the Positive side of Speaker D.

And lastly, connect the Negative side of Speaker B to the Negative side of Speaker D.

4 Eight (8) Ohm speakers wired in Series Parallel = a Total Load of 8 Ohms.

WIRING SCHEMES...Amplifier to Speaker Cabinets

1

2

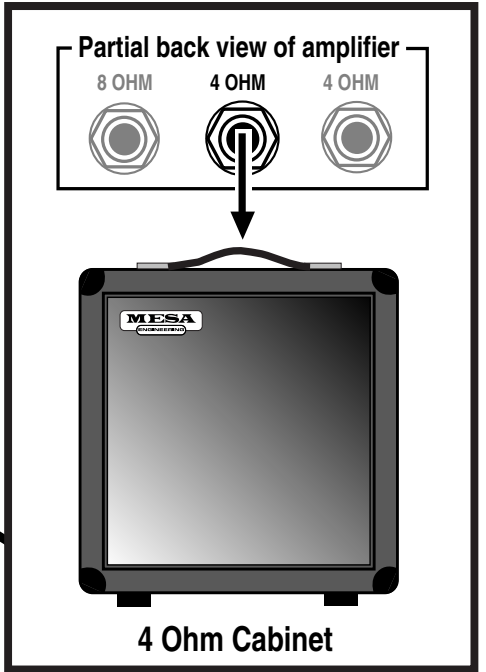
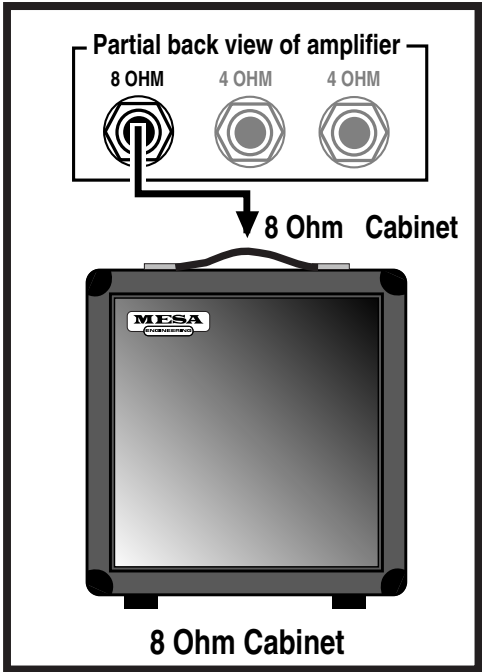

3

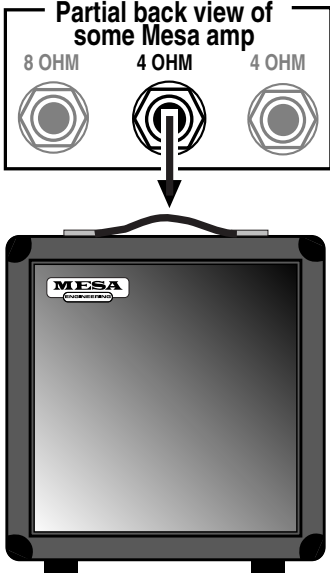

4

5

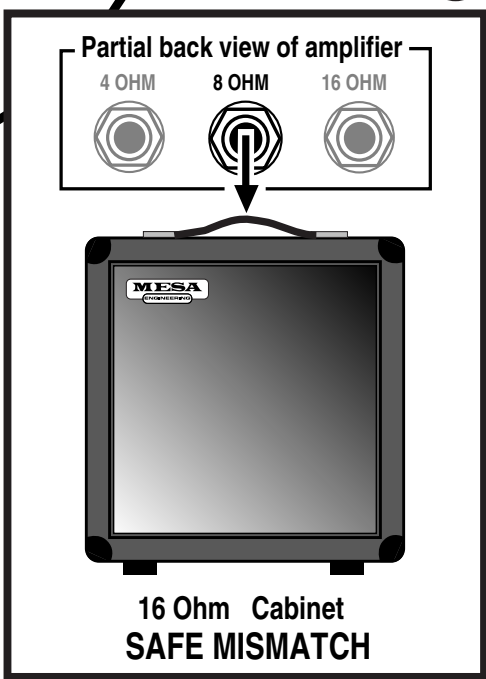
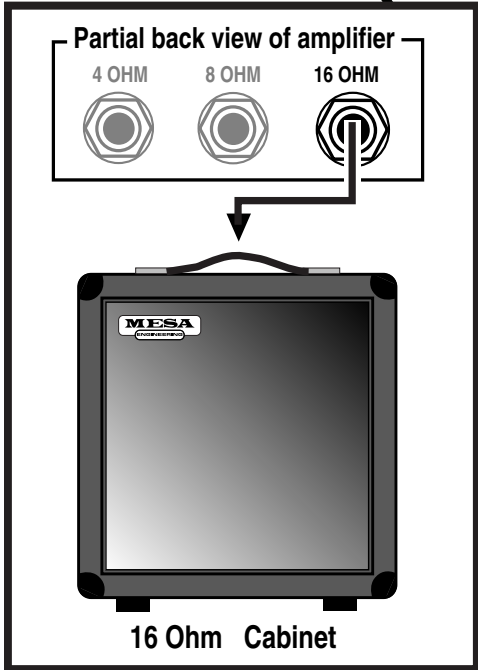

WIRING SCHEMES...Amplifier to Speaker Cabinets

6

7

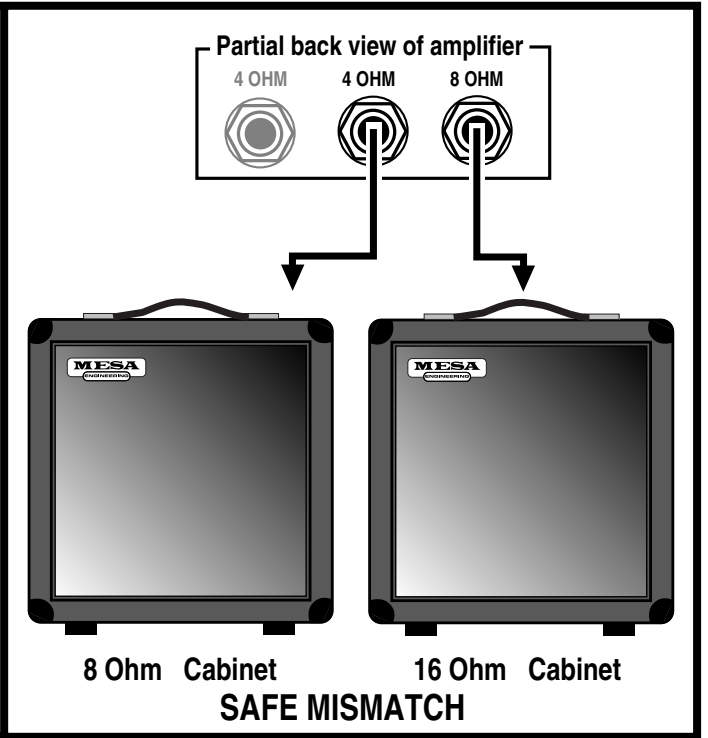
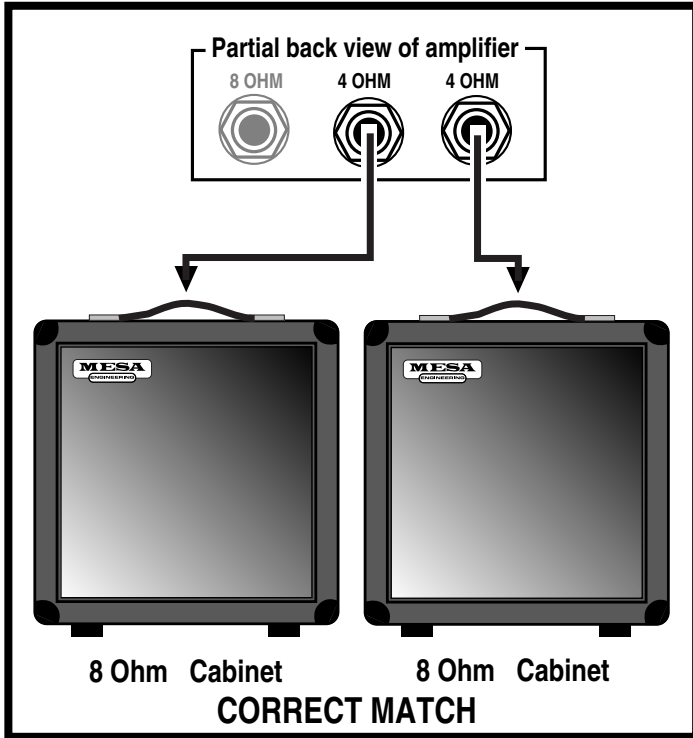

8

9

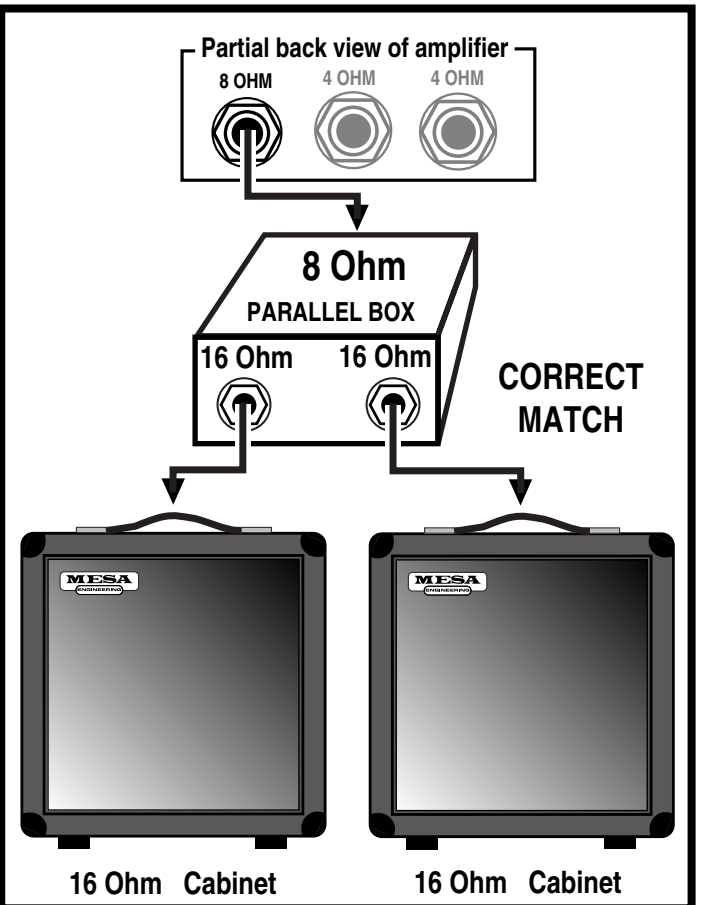
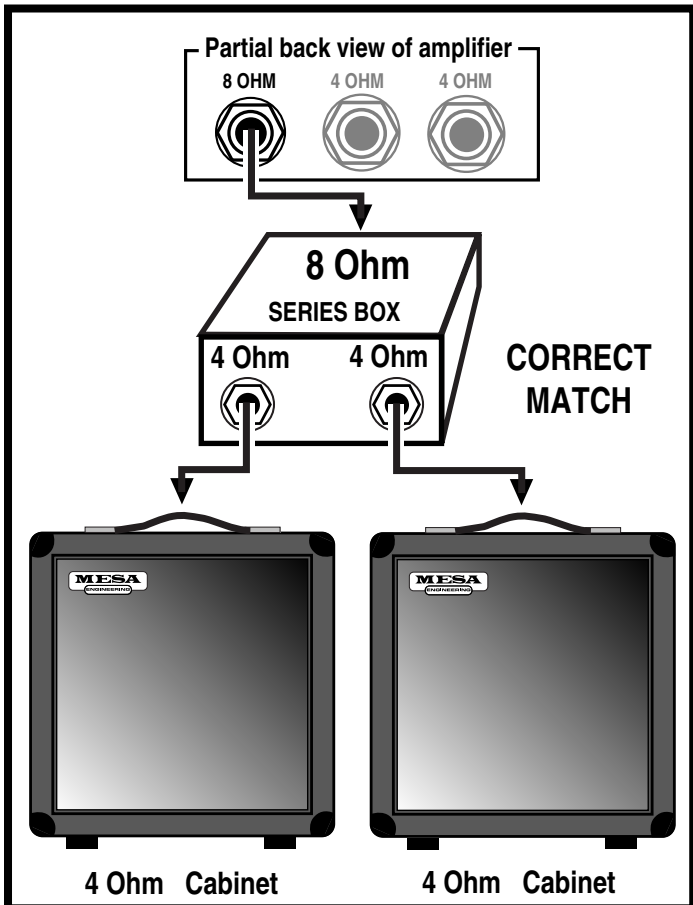

WIRING SCHEMES...Amplifier to Speaker Cabinets

10

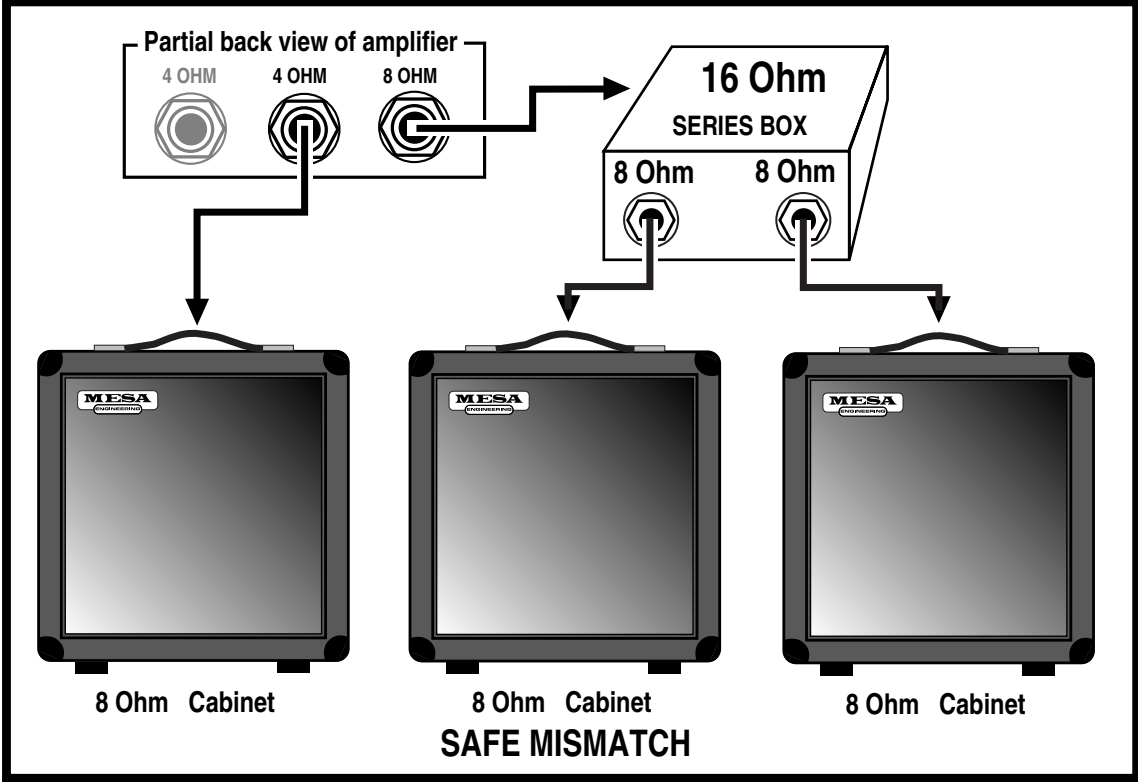

11

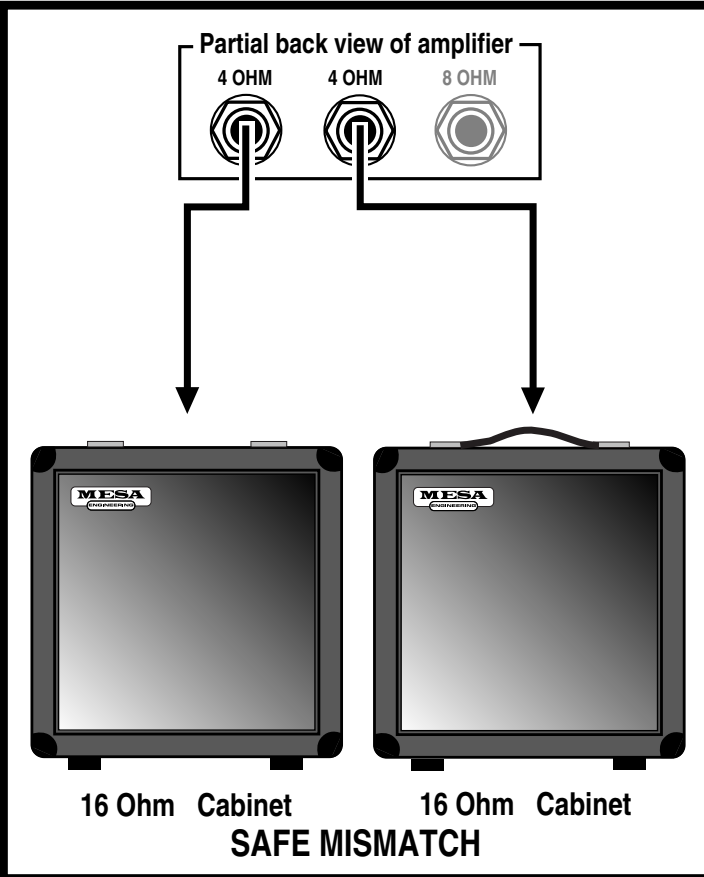

12

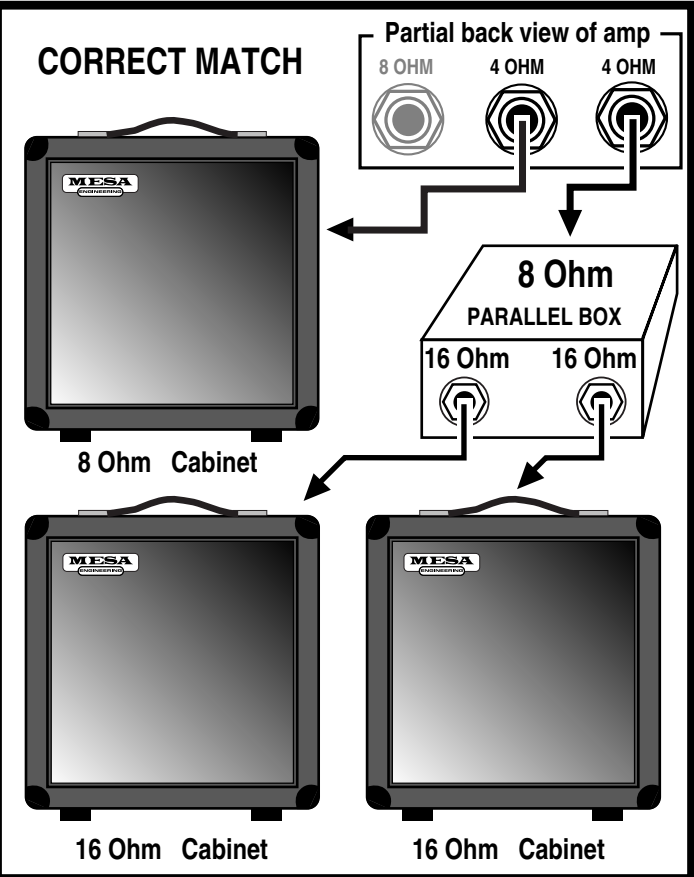

WIRING SCHEMES...Amplifier to Speaker Cabinets

13

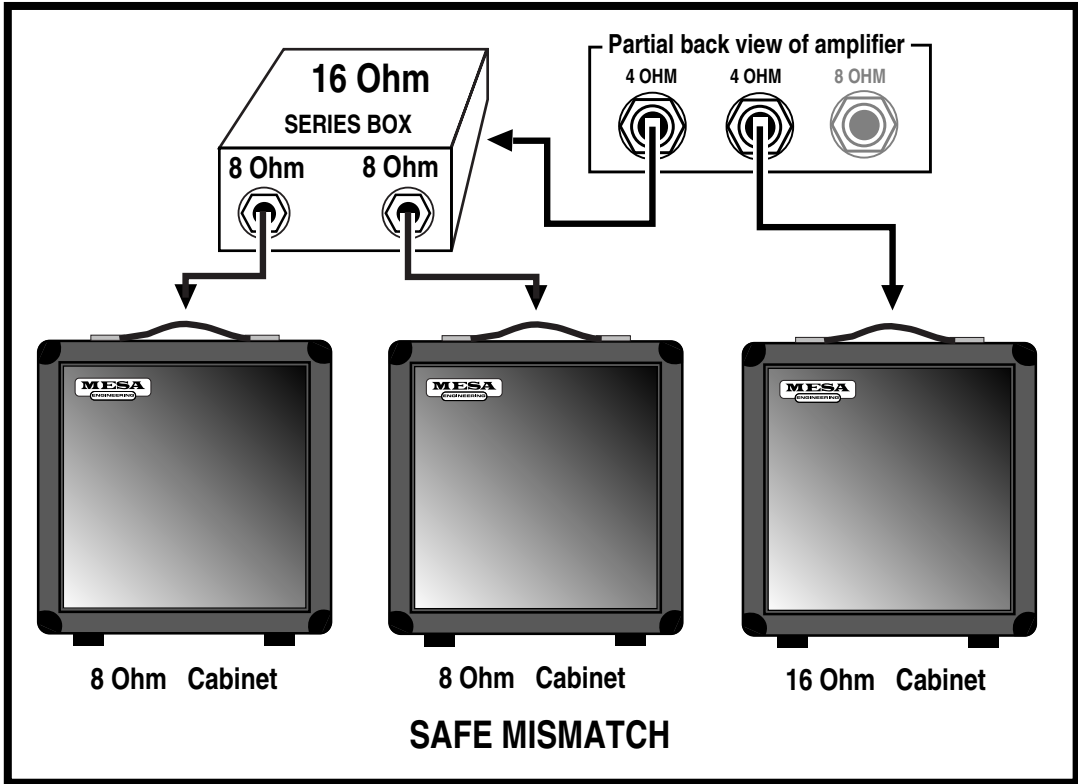

14

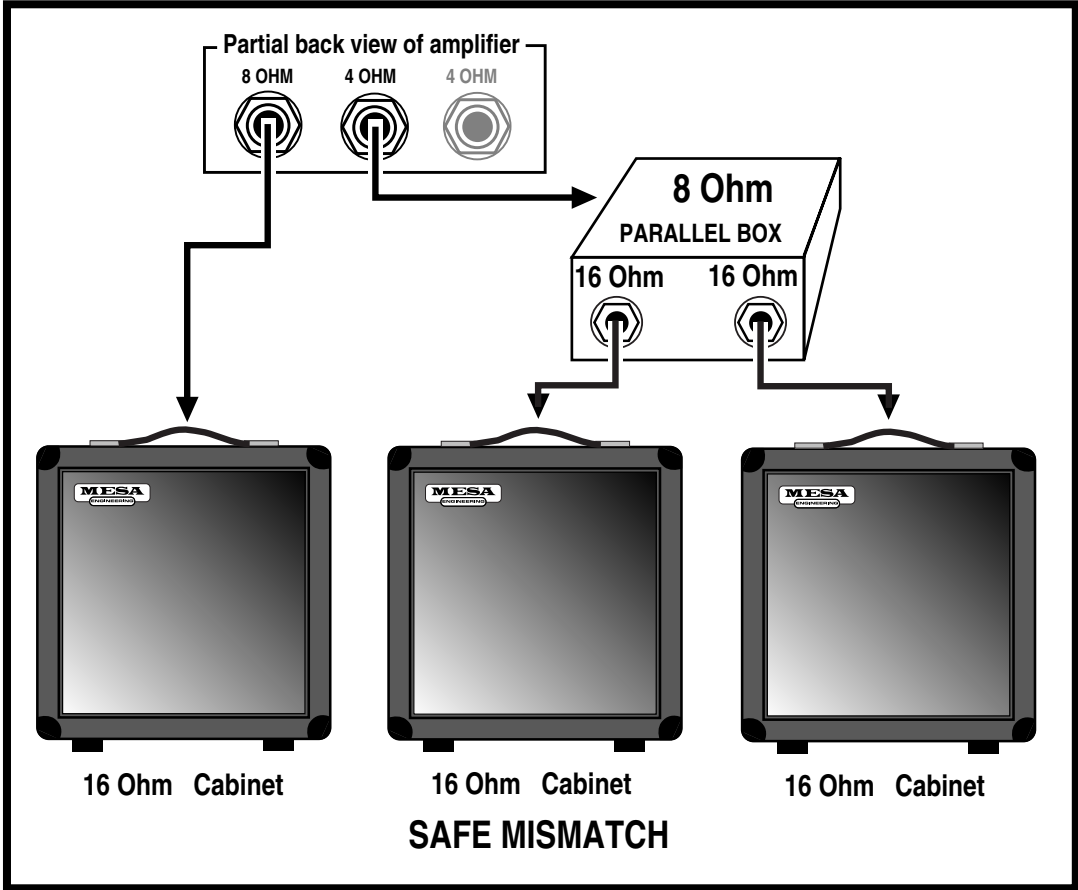

ON TRIODES, PENTODES & IRISHMEN:

With apologies to Friends and Relatives from the Emerald Isle - who will make their appearance soon enough - the humor which follows is dedicated to the memories of Spec McAuliff and Fae (Rafael) McNally, two of the True Greats.

As their numerical references suggest, the terms Diode, Triode and Pentode indicate the number of elements within the vacuum tube i.e. two, three or five. All tubes also require a filament or heater which is not included in the count. Its purpose is to excite electrons from the cathode coating by raising the temperature such that they are able to boil out of the electron-rich coating material and form a cloud of free electrons in the vacuum space surrounding the cathode.

Although the term filament and heater are often used interchangeably, there are specific differences: A filament is a directly heated cathode where cathode coating is applied directly to the heating element. Examples are 5U4 twin diode rectifier and 300B triode amplifier tubes. A heater, on the other hand, is a heating element which is separate from the cathode and is usually inserted within the tubular cathode sleeve. Examples are 12AX7 twin triode amplifier and 6V6 or EL84 beam power pentode tubes. In all cases this fundamental aspect of each tube's construction is clearly visible, especially when the heating element is glowing red hot.

The cathode, then, would be considered the first numbered element because it is the source of the electrons. The word itself is from the Greek literally meaning completely down, which implies a sense of central origin - like the center of the earth where Tone begins. It might be said that an ecstatic audiophile experiences a positive catharsis, his soul being purified when his system transports him to Audio Nirvana. The only trouble with taking this positive imagery too far is that the cathode is, unfortunately, negative... at least electrically speaking. However this is easily remembered since virtually all musicians and audiophiles have also experienced the more common negative catharsis when they emerge from the emotional rebirth kicking and screaming in rage and frustration.

Once heated, the intrinsically negative electrons are energetic little fellows of almost no mass. Thus they may be accelerated almost instantaneously and will travel through a vacuum a nearly the speed of light. Being of like, negative charge, they tend to repel one another and thus within the electron cloud surrounding the cathode, there is much jostling and elbowing as each one tries to maintain his distance from all the others... unless there is a strong and universal attraction from an outside influence.

Visualize, if you will, a group of sub-atomic Irishmen milling about and in a repellent, negative state of mind. All are scowling and none wants to have anything to do with the other. Now introduce a strong attraction say, a public bar, and you can easily picture an orderly, if rapid movement of the lot in a single direction. This is what happens when a positively charged element called the anode or plate is introduced into the vacuum.

The plate is the large metal element most prominently visible through the glass of an electron tube. It is the outermost element of a tube's structure and it surrounds all the others. The cathode is at the center radiating electrons outwards. As higher and higher positive voltage is applied to the plate, the attraction for the electrons surrounding the cathode is increased and with nothing standing in the way, full uninhibited flow to the plate occurs... sort of like removing the doors and offering free drinks to the crowd of surly Irishmen milling around outside. As electrons flow to the plate, the space charge will continually be replenished by further 'boiling' of the hot, electron-rich cathode as you can easily imagine other Irishmen impatiently taking up the places of those who've gone inside - until the entire village is deserted.

Now, where do they come from and how do they emerge? Well, a grand and elegant lady once showed me how to revive flat champagne: She dropped a raisin into the glass. There was a dramatic and immediate increase in effervescence with the introduction of a cathoding surface. Thousands of tiny bubbles suddenly appeared - and continued to flow from the raisin. Of course the bubbles were made up of gas dissolved in the beverage, but the analogy makes it easy to visualize the loosely bound electrons dissolved in the rich cathode coating as they effervesce from its heated surface.

But back to the electron flow. If the electrons are strongly attracted to a positively charged plate, then it follows that they are strongly repelled by a negatively charged plate and they are. Thus, if an alternating current - such as comes from a transformer - is applied to the plate, electrons will flow only during the times when the plate is positively charged. During periods of negative plate charge, electron flow is stopped and the space charge of electrons remains compressed in the area around the cathode.

ON TRIODES, PENTODES & IRISHMEN: (Continued)

Thus a diode tube - one with a cathode and an anode - is mostly used to rectify alternating current into direct current by passing it without restriction, but in one direction only. This also explains why closing time is strictly enforced at Irish pubs: During normal operation, the traffic flow is similarly unimpeded and uni-directional toward the bar and this process rectifies the work-day negativity. It goes without saying that no one leaves as long as the atmosphere around the bar remains positively charged.

TRIODES:

This section is a continuing technical treatise on the workings of Irish Pubs but to make it easier for the layman to understand, it is explained in terms of vacuum tube technology. Enter the original bar - free beer and no doors. Well, it turns out that some control over the flow can be a necessary and useful advantage. This led to the invention of those swinging louvered saloon doors which are open at the top and bottom. They are patterned after the control grid of the vacuum tube, which is a loosely wound coil of thin wire located between the cathode and the plate.

In a Triode the plate is always positively charged with high voltage D.C. and even though the grid is blocking the path, those negative electrons can still FEEL the strong attraction - just as the Irishmen can see in through the louvers of the bar doors. They know what pleasures lie beyond, but to get there requires overcoming the negative influences controlling the access. This negative influence is typically called a Bias. In electronic terms that means the grid is supplied with a voltage which is slightly MORE NEGATIVE than the already negative electrons. The more negative the Bias, the more it tends to neutralize the attraction of the plate and repel the electrons back toward the cathode.

The Irish can be similarly charged with Bias, but unless you are Irish yourself, this type of Biasing may be more difficult to understand. The effect is similar though: The more negative the Bias, the more it impedes forward progress. Generally speaking though, the electronic Bias of the grid is easiest to overcome, and for two main reasons: First, the Bias is set - like the bar doors - to allow some passage. Second, the grid is mostly NOT THERE, like the louvered doors which are mostly open spaces. Unlike the plate which is solid, the grid is like a coiled bed spring. It can create a repelling field but mostly it's empty space in between widely separated windings of wire. It's very easy to control the electrons as they pass through the grid's force field: Changing the grid voltage only slightly will have an enormous effect on how much current flows through... and that's what AMPLIFICATION is: a small change in voltage at the grid causing a large change in current flowing to the plate.

The purpose of the louvered bar doors is similar to that of the grid, namely, to give momentary pause while still revealing the promise within. Hesitation mostly gives way to temptation, but there are those few stalwart Irishmen who think twice and decide to come back later. Most just pause slightly then go on through. That is the purpose of the bar doors: to prevent everyone from crowding in all at once - and as the door is made less of a barrier, wider spaces between the louvers, more of the bar's attractive influence is felt outside thus amplifying the customer flow and increasing the crowd at the bar.

PENTODES:

Occasionally though, bar doors - even the louvered type - were found to be too effective, and too many customers turned away. Something further was needed to increase the attraction of the bar and overcome the resistance created by the door. Thus the cocktail waitress was invented.

Once again the idea was inspired by the vacuum tube. It had been discovered in some tubes, often large power types, that the distance to the plate was too great to attract enough electrons past the negative influence of the control grid. So another grid coil of fine wire was inserted between the first grid and the plate. This was called the screen grid and carrying a highly positive charge, it functioned as a "bait" for the plate.

In a properly designed power tube such as an EL84 or a 6V6, the windings of the screen grid are precisely aligned to fall in the shadow of the control grid. This way the electrons responding to the pull of the screen grid are lined up in sheets as they pass between windings of the inner control grid... only to find that they have been fooled! Once past the control grid and drawn toward the screen grid, they discover...there's almost nothing there. The path they're on has them aligned to zing straight through the spaces BETWEEN screen grid windings. So rather than a close and personal encounter, they just fly on past - and once they're out that far, there's no stopping them. The influence of the plate takes over and - being solid metal and of the highest positive attraction - it is at this final destination that the electrons congregate.

PENTODES: *(Continued)*

Thus the proper cocktail waitress - visible through the louvers - is scantily clad so as to be all the more effective at reinforcing the attractive influence of her bar and by being located in between the door and the bar, she serves as bait to lure customers past the door's negative influence. Once through the door however, it is the rare Irishman who actually comes in personal contact with the cocktail waitress as, for all intents and purposes, she - like the screen grid - turns out to be a vanishing illusion. Yet, having come this far, the solid influence of the bar itself now takes over and attracts the customers to congregate, having happily reached their destination.

If you're still following this and haven't lost track of the count, you'll know we're still one element short of the five needed to make a Pentode. This last part is a pair of beam-confining shields which being negatively charged, serve to direct the flow right toward the plate. This is much the way a short entrance hall to the bar prevents wandering accidentally into the Men's room on the way.

Once at the bar though, the circuit is complete and the process of soul-nourishing works its ritual magic. Biases having been overcome, illusory nightingales having vanished, the spirits truly soar and the once surly Irishmen now are filled with warmth, wit and kindred friendship, enjoying the music and glowing nicely with their heaters on.

With appreciative thanks to the inhabitants of the Land of the Leprechaun, we have now concluded our little diversion into the mechanics of proper bar lay-out.

A feature article by Randall Smith
Designer / President

TRANSATLANTIC TA-15

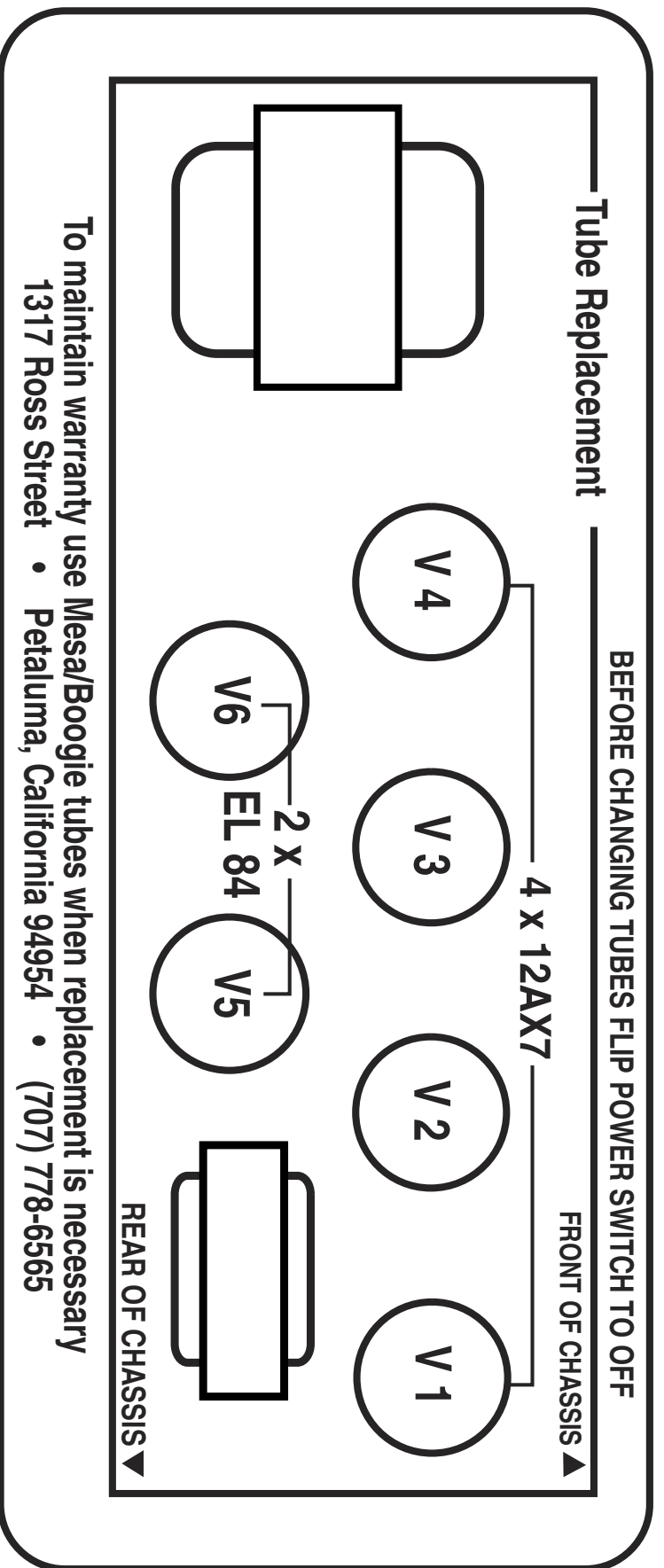

Preamp Tubes	Power Tubes
V1A&B - Parallel Input Stages for Ch1	25 Watts = V5, V6
V2A - Input Stage for Ch2	15 Watts = V5, V6
V2B - 2nd Gain Stage for Ch2	5 Watts = V6
V3A&B - Tone Control Driver for Ch's 1 & 2	
V4A&B - Driver/Phase Inverter	

FRONT PANEL: TRANSATLANTIC TA-15

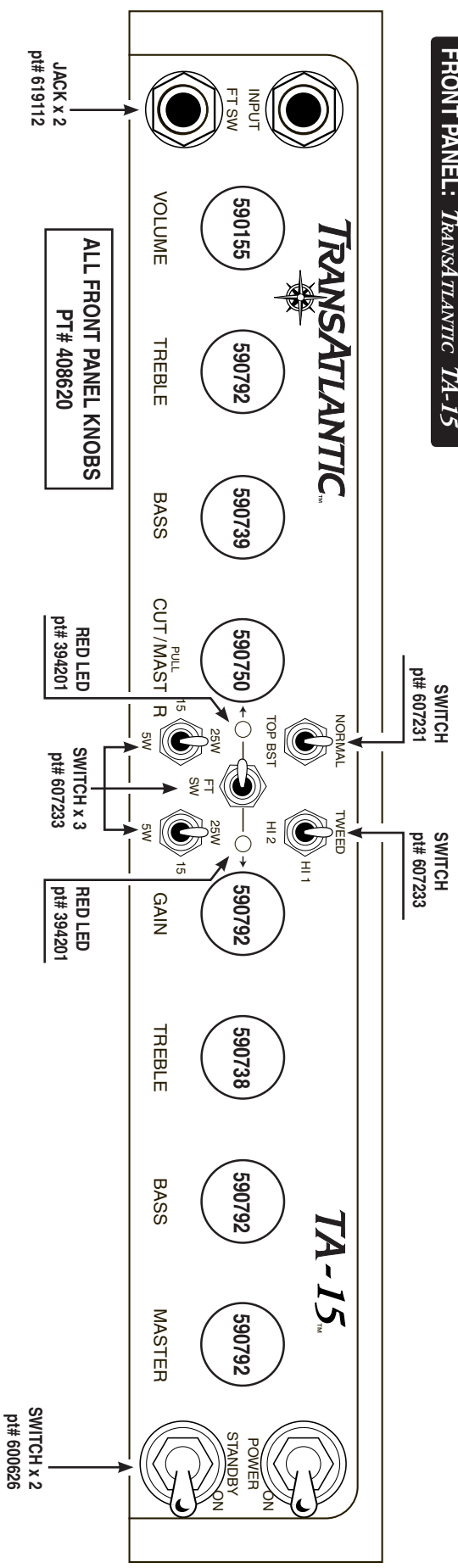

REAR PANEL: TRANSATLANTIC TA-15

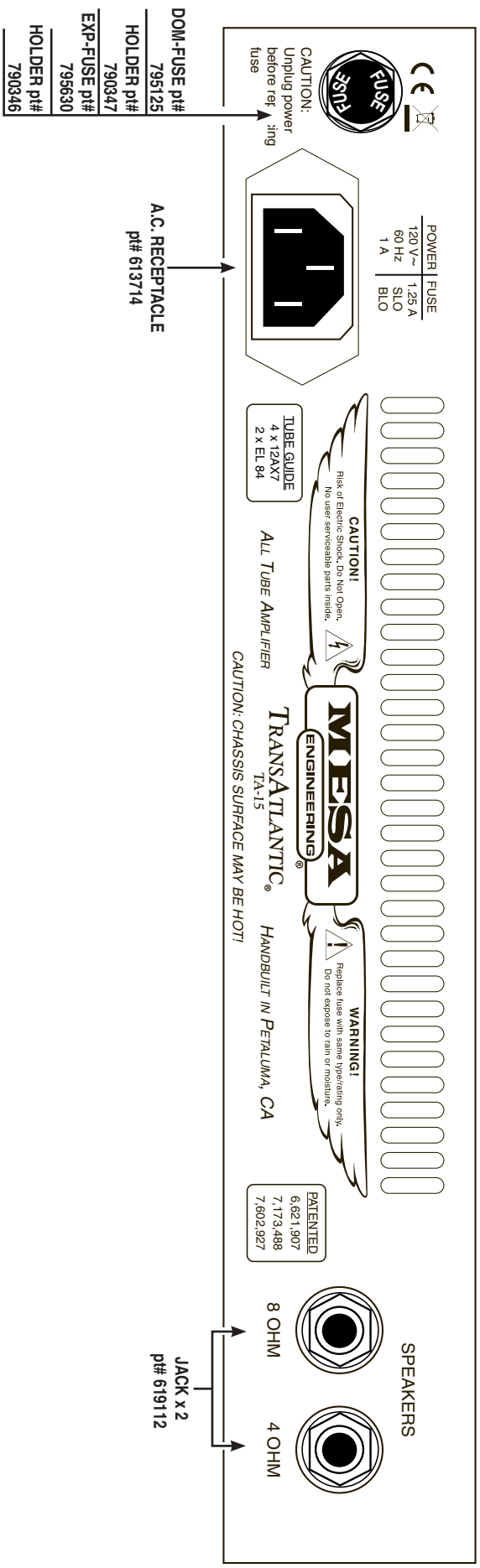

NOTES:

MESA/BOOGIE

The Spirit of Art in Technology

Thank you for trusting MESA/Boogie to be your amplifier company and we wish you many years of toneful enjoyment from this handbuilt all tube instrument.

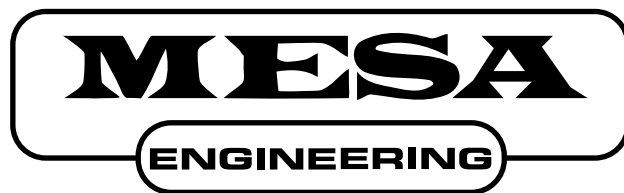

The Spirit of Art in Technology



(707) 778-6565 FAX NO. (707) 765-1503

1317 Ross Street Petaluma, CA 94954

USA