

Canon

DIGISUPER 22 **XS**

XJ22x7.3B IE-D 7.3-161mm 1:1.8



NEW *Compact Studio Lens*

“An epoch-making lens based on a completely new concept to be used for Portable HD/SD Studio Cameras.”



DIGISUPER 22

XJ22x7.3B IE-D 7.3-161mm 1:1.8



NEW-COMPACT STUDIO LENS



Corresponding to the world's trend of using a portable camera in HD Studio Systems, Canon introduces a new concept for a Studio Lens. The DIGISUPER 22 xs is a "Compact HD Studio lens" which was specifically designed to be used with a portable camera. By adopting technologies developed from Canon's long history, the DIGISUPER 22 xs is superior in both optical performance and ease of operation, compared with HD portable lenses as well as all previous SDTV Studio Box Type Lenses.

The DIGISUPER 22 xs provides higher optical performance compared with the portable lenses and at the same time, owing to the compact size, it offers higher versatility when used with a portable camera as opposed to the large box type lenses.

Advanced Operation

By adopting an "Encoder Servo System", the maximum servo speed has been improved to; Zoom: 0.5sec, Focus: 1.5sec. Also, the new encoder system enables the lens to be easily integrated into virtual studio applications.

Diverse Functions

The DIGISUPER 22 xs is equipped with an informational display, which will enable you to use diverse digital functions, easily and precisely.

*Listed below are the typical three functions of Canon's diverse digital functions.

High Optical Performance

The DIGISUPER 22 xs offers higher contrast and resolution compared with portable lenses and at the same time, reducing the Focus Breathing to a zero level.

Compact Size & Light Weight

In order to realize the best capabilities from the camera/lens combination, the lens was specifically designed to be as compact and light as possible.

*Please refer to the diagram below. The lens dimensions are given on the back page.

Crossover Compatibility

Available optionally is the dual aspect ratio switching system, "Crossover", for switchable 16:9/4:3 cameras.

Accessories

The DIGISUPER 22 xs can be used with our current Studio/Field lens controllers as well as those for our ENG lenses such as the "ZSD-300D & FPD-400D".

At the same time, the lens also offers compatibility with our new digital demands by use of a conversion cable.

Shuttle Shot



By memorizing any two focal lengths, the lens can automatically "shuttle" between the two points, moving in either direction.



Framing Preset



An angle of view can be preset in either of two memories and the lens will zoom to that position by pushing a simple button. During a performance, framing preset will reproduce the zoom position decided upon at the rehearsal. It's easy to repeat the same zoom as often as you like at the highest speed or in a preset zoom speed.



Speed Preset



A specific zoom speed can be preset in memory and it is possible to repeat the zoom speed as often as you like by pushing a simple button.



Constant Angle Focusing System

The zooming effect of focus is the phenomena where the picture size (angle of view) changes when focusing. However, a CPU calculates and controls the zoom when focusing in order to counteract these phenomena. Thus the DIGISUPER series has ZERO zooming effect of focus.

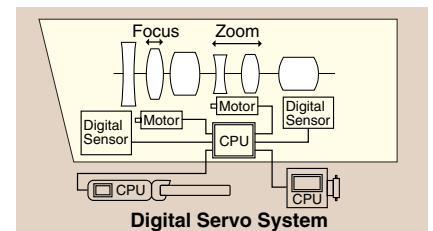

Compact Size

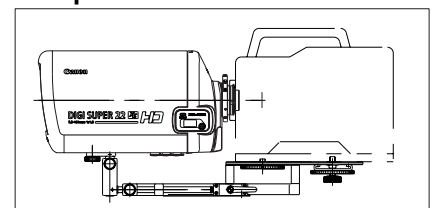

*The SUP-400 supporter is included as a standard component with the lens.

INTERNAL

FOCUSING SYSTEM

- (Advanced 3 group IF system)
- Realization of wide-angle with reduced distortion.
- Minimized variation of chromatic aberration while focusing.
- Anti-Dust, Anti-Fog, thanks to a perfectly airtight Internal Focusing System.
- Minimized variation of the centre of gravity through focus movement.

HD OPTICAL PERFORMANCE

- Computer aided design in order to meet the higher level demanded by HDTV.

WIDE ANGLE OF 7.3mm WITH REDUCED DISTORTION

COUNTERMEASURES AGAINST "GHOSTING" AND "FLARES"

- New coatings and anti-reflection paint achieve the elimination of "ghosting" and "flares".

"CAFS"

-Constant Angle Focusing System-

- When focus is operated, the angle of view is maintained by synchronizing zoom movement.

ZOOM RATIO:22X

CROSSOVER COMPATIBILITY (Optional)

- For use with 16:9/4:3 switchable cameras.

3 - POSITION TURRET

- (built in extender, master lens, crossover unit).
- Micro Computer Controlled Turret.



INFORMATIONAL DISPLAY FOR DIVERSE DIGITAL FUNCTIONS



20PIN CONNECTORS FOR VERSATILE ZOOM/FOCUS CONTROLLERS

CONNECTOR FOR VIRTUAL STUDIO APPLICATIONS

NEW GENERATION DIGITAL SERVO SYSTEM

SERVO SYSTEM MATCHING ROBOTIC REQUIREMENTS

- High resolution zoom and focus servo 13 bit repeatability

10 BIT IRIS COMPATIBILITY

- High resolution iris control.

WIDE DYNAMIC RANGE OF ZOOM AND FOCUS SERVO SPEED

- From ultra slow to high speed. Max. speed: Zoom 0.5 sec, Focus 1.5 sec.

COUNTERMEASURES AGAINST RADIO FREQUENCY NOISE(INTERFERENCE)

PC SYSTEM (OPTION)

SPECIFICATIONS

	NORMAL4:3		16:9		SWITCHABLE 4:3		
	1.0X	2.0X	1.0X	2.0X	1.0X	1.2X	2.4X
Built-in Extender	1.0X	2.0X	1.0X	2.0X	1.0X	1.2X	2.4X
Zoom Ratio	22X						
Range of Focal Length	7.3-161mm	14.6-322mm	7.3-161mm	14.6-322mm	6-132mm	7.3-161mm	14.6-322mm
Maximum Relative Aperture	1:8 at 7.3~111.5mm 1:2.6 at 161mm	1:3.6 at 14.6~223mm 1:5.2 at 322mm	1:8 at 7.3~111.5mm 1:2.6 at 161mm	1:3.6 at 14.6~223mm 1:5.2 at 322mm	1:1.8 at 6.0~110.5mm 1:2.15 at 132mm	1:1.8 at 7.3~111.5mm 1:2.6 at 161mm	1:3.6 at 14.6~223mm 1:5.2 at 322mm
Angular Field of View	62.2°x48.7° 3.1°x2.3°	33.5°x25.5° 1.6°x1.2°	66.7°x40.6° 3.4°x1.9°	36.4°x21.0° 1.7°x1.0°	62.2°x48.7° 3.1°x2.3°	52.5°x 40.6° 2.6°x 1.9°	27.7°x21.0° 1.3°x1.0°
Minimum object Distance(M.O.D.)	0.8m from front lens vertex (with macro ; M.O.D.: 0.1m)						
Object Dimensions at M.O.D.	107.8x80.9cm at 7.3mm 4.8x3.6cm at 161mm	53.9x40.5cm at 14.6mm 2.4x1.8cm at 322mm	118.1x66.4cm at 7.3mm 5.2x2.9cm at 161mm	59.1x33.2cm at 14.6mm 2.6x1.5cm at 322mm	107.8x80.9cm at 6.0mm 4.8x3.6cm at 132mm	88.5x66.4cm at 7.3mm 3.9x2.9cm at 161mm	44.3x33.2cm at 14.6mm 2.0x1.5cm at 322mm
Size	165(W)x175(H)x336(L)mm						
Mass	6.1kg (13.42lbs)						
Crossover Type	Option						

RECOMMENDED LENS SYSTEM

With Current ENG Demand (Standard)

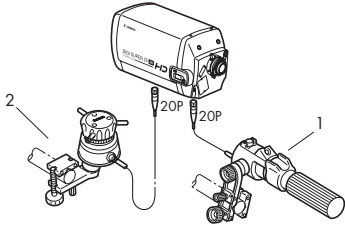

Kit Detail

No.	DESCRIPTION
1	Digital Zoom Demand ZSD-300D
2	Digital Focus Demand FPD-400D

With New Digital Demand

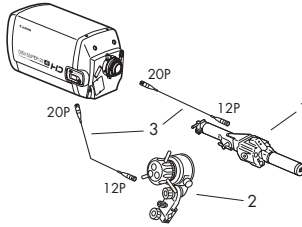

Kit Detail

No.	DESCRIPTION
1	Digital Zoom Demand ZDJ-P01
2	Digital Focus Demand FDJ-P01
3	Conversion Cable BDC-20

With Current Field/Studio Demand

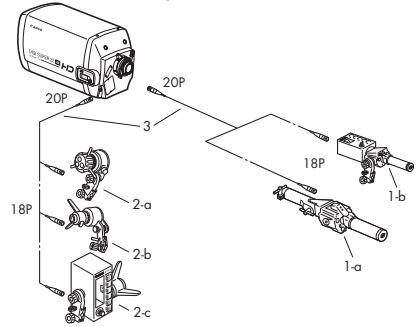

Kit Detail

No.	DESCRIPTION
1-a	Digital Zoom Demand ZDJ-D02
1-b	Digital Zoom Demand W Pre-set Box ZPJ-D02
2-a	Digital Focus Demand FDJ-D02
2-b	Digital Focus Demand Propeller Type FDJ-D12
2-c	Digital Focus Demand W Pre-set Box FPJ-D12
3	Conversion Cable BDC-10

PC SYSTEM

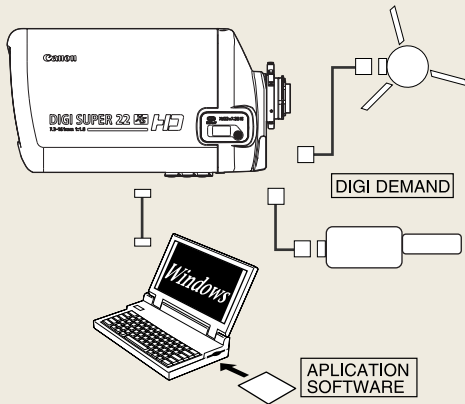

DIMENSIONS

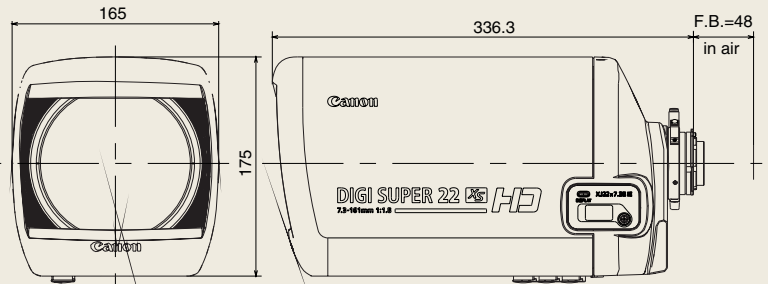

North & South America

Canon U.S.A., Inc.
Broadcast and Communications Div. (Headquarters)
400 Sylvan Avenue Englewood Cliffs, NJ 07632
Tel:(201)816-2900/(800)321-4388
Fax:(201)816-2909
Email:bctv@cusa.canon.com
http://www.canonbroadcast.com/

Chicago
100 Park Blvd. Itasca, IL 60143
Tel:(630)250-6231 Fax:(630)250-0399

Atlanta
5625 Oakbrook Pkwy. Norcross, GA 30093
Tel:(770)849-7895 Fax:(770)849-7888

Los Angeles
15955 Alton Parkway Irvine, CA 92618
Tel:(949)753-4330 Fax:(949)753-4337

Dallas
3200 Regent Blvd. Irving, TX 75063
Tel:(972)409-8871 Fax:(972)409-8869

Latin America
Tel:(954)349-6975 Fax:(201)816-2909

Canada
Canon Canada, Inc.
Optics Division
6390 Dixie Road
Mississauga, Ontario, L5T 1P7, Canada
Tel:(905)795-2012 Fax:(905)795-2140

Europe/Africa/Middle East

Canon Europa N.V.
Broadcast and Communications Div.
Bovenkerkenweg 59-61
1185 XB Amstelveen
Tel:+31(0)20-5458905 Fax:+31(0)20-5458203
Email:tvprod@canon-europa.com
http://www.canon-europa.com/tv-products

Australia
Canon Australia Pty. Ltd.
Optical Products Division
1 Thomas Holt Drive, North Ryde, NSW 2113,
Australia
Tel:+61(0)2-9805-2000 Fax:+61(0)2-9805-2444

China
Canon (China) Co., Ltd.
Optical Products Division
15F South Tower, Beijing Kerry Center, 1 Guang Hua
Road,
Chao Yang District, 100020, Beijing, China
Tel:(010)8529-8488 ex 133 Fax:(010)8529-6606
http://www.canon.com.cn

Asia/Japan
Canon Inc. (Broadcast Equipment Group)
20-2, Kiyohara-Kogyo-Danchi, Utsunomiya-shi,
Tochigi-ken, 321-3292, JAPAN
Tel:+81(0)28-667-8669 Fax:+81(0)28-667-8672

<http://www.canon.com/bctv/>

Canon

Specifications subject to change without notice