



DVS 8 / DVS 8t

TANNOY®



Product Description

Designed for a wide variety of discrete medium scale sound reinforcement applications, the Tannoy DVS 8 is an ultra compact surface mount loudspeaker of exceptional value and acoustic performance. A full bandwidth loudspeaker designed for commercial, professional and residential applications where environmental durability and high quality sound reproduction are required. For both indoor and limited outdoor use, these speakers are ideally suited to stereo or monaural background or foreground music systems in such applications as diverse as theme park attractions, retail premises, restaurants and cafes, hotel lobbies and bars, corporate audio visual, residential developments and houses of worship.

The point-source design comprises a 200mm (8.00") mid bass driver with a coaxially mounted 19mm (0.75") high frequency section mounted in a stylish injection moulded surface-mount enclosure manufactured from ABS material. The new device is certified for water and dust ingress protection to IP64 standard and is currently pending UL Listed status (UL-1480) making it a perfectly capable performer in challenging interior areas such as swimming pools, saunas or work areas where unusually high levels of dust or moisture may be present, as well as most outdoor applications where extreme environmental or harsh weather conditions are not a typical concern.

The highly durable and scuff resistant, high impact ABS enclosure is available in black or white painted finish and comes with an integral mild steel grille designed with optimum aesthetic sensitivity in mind. A steel mounting bracket is included, which fits easily to the device via finger-tightened plastic screw-nut on the top and bottom of the enclosure, making installation quick and hassle-free. Thanks to the point-source driver design, the DVS 8 can be mounted vertically or horizontally without compromising the dispersion and coverage control.

Transformer version – the DVS 8t

The DVS 8t model option is equipped with an internally mounted low insertion loss line transformer for 70V or 100V distributed sound applications. Wattage taps are configurable to the following settings via a rotary tapping switch, which is located on the back panel.

70V: 60W / 30W / 15W / 7.5W
100V: 60W / 30W / 15W

Features

- 200mm (8") coaxial transducer for high performance and durability
- 110 degree controlled conical dispersion for optimum coverage
- Exceptional performance to value ratio
- Weather resistant rated IP64 to EN60529 (IEC529)
- Stylish, durable ABS enclosure available in black or white
- Phase coherent design for superior vocal articulation and music reproduction
- No crossover required, ensuring better phase, impedance and sensitivity response and increased durability
- Painted steel yoke bracket supplied.
- Five year loudspeaker warranty
- Low insertion loss 60W transformer for use in distributed audio installations (DVS 8t only)

Applications

- Indoor and outdoor commercial, professional and residential installations
- High level stereo or monaural background or foreground music and speech paging systems
- Theme parks
- Theme bars
- Reception / waiting rooms
- Airports, convention centres and hotels
- Business music systems
- Boardrooms and offices
- Retail outlets and shopping malls
- Restaurants and cafes
- Corporate audio visual
- Residential developments

Tannoy (Direct UK)
TCGI (ROW sales)
TCGA (Americas sales)
Tannoy Middle East

T: 00 44 (0) 1236 420199
T: 00 45 8742 7000
T: 00 1 (519) 745 1158
T: 00 971 (04) 4401208

E: enquiries@tannoy.com
E: info@tcgroup-international.com
E: info@tcgroup-americas.com
E: enquiries@tannoy.com

tannoy®.com



DVS 8 / DVS 8t

TANNOY®

TECHNICAL SPECIFICATIONS

System	DVS 8	
Frequency Response (-3dB) ⁽¹⁾	75Hz - 20kHz	
Frequency Range (-10dB) ⁽¹⁾	60Hz - 30kHz	
System Sensitivity (1W @1m) ⁽²⁾	90dB	
Dispersion (-6dB)	80 degrees conical	
Transducers	Coaxial 200mm (8.0") mineral loaded cone material 19mm (0.75")	
Low Frequency		
High Frequency		
Crossover	3.4kHz - 2nd order LF, 1st order HF	
Directivity Factor (Q)	12.3 averaged 1kHz to 10kHz	
Directivity Index (DI)	10.0 averaged 1kHz to 10kHz	
Rated Maximum SPL ⁽²⁾	108dB (average) 114dB (peak)	
Power Handling		
Average	70W	
Programme	140W	
Peak	280W	
Recommended Amplifier Power	140W @ 6 Ohms	
Nominal Impedance	6 Ohms	
Distortion		
10% Full Power (6.48V)	2nd Harmonic	3rd Harmonic
250Hz	0.891%	0.217%
1kHz	0.235%	0.643%
10kHz	0.666%	0.093%
1% Full Power (2.05V)	2nd Harmonic	3rd Harmonic
250Hz	0.236%	0.192%
1kHz	0.051%	0.409%
10kHz	0.217%	0.081%

Notes

- (1) Average over stated bandwidth. Measured at 1 metre on axis in an anechoic chamber
- (2) Unweighted pink noise input, measured at 1 metre in an anechoic chamber

A full range of measurements, performance data, and Ease™ Data can be downloaded from www.tannoy.com

Tannoy operates a policy of continuous research and development. The introduction of new materials or manufacturing methods will always equal or exceed the published specifications, which Tannoy reserves the right to alter without prior notice. Please verify the latest specifications when dealing with critical applications.

Construction

Enclosure	ABS
Grille	Steel, plated and painted
Connectors	Euroblock type removable locking connector with screw terminals with "loop through" facility
Transformer setting	Rotary switch
Supplied Accessories	Yoke bracket
Dimensions (H x W x D)	451.8 x 290.0 x 296.0mm (17.78" x 11.42" x 11.65")
Net Weight	5.3kg (11.67lbs)
Shipped weight	14.6kg (32.16lbs)
Packed quantity	2

Transformer Version

specifications as above except:

Transformer Taps (rear rotary switch)

70V	60W / 30W / 15W / 7.5W / OFF & Low Impedance operation
100V	60W / 30W / 15W / OFF & Low Impedance operation

Net Weight	6.3kg (13.88lbs)
Shipped weight	16.6kg (36.56lbs)
Packed quantity	2

Ordering Information

PART NUMBER	MODEL NAME	COLOUR	PACKED QUANTITY
8001 6270	DVS 8	BLACK	2
8001 6271	DVS 8	WHITE	2
8001 6280	DVS 8t	BLACK	2
8001 6281	DVS 8t	WHITE	2

Tannoy (Direct UK)
TCGI (ROW sales)
TCGA (Americas sales)
Tannoy Middle East

T: 00 44 (0) 1236 420199
T: 00 45 8742 7000
T: 00 1 (519) 745 1158
T: 00 971 (04) 4401208

E: enquiries@tannoy.com
E: info@tcgroup-international.com
E: info@tcgroup-americas.com
E: enquiries@tannoy.com

tannoy.com



1m on-axis Frequency Response

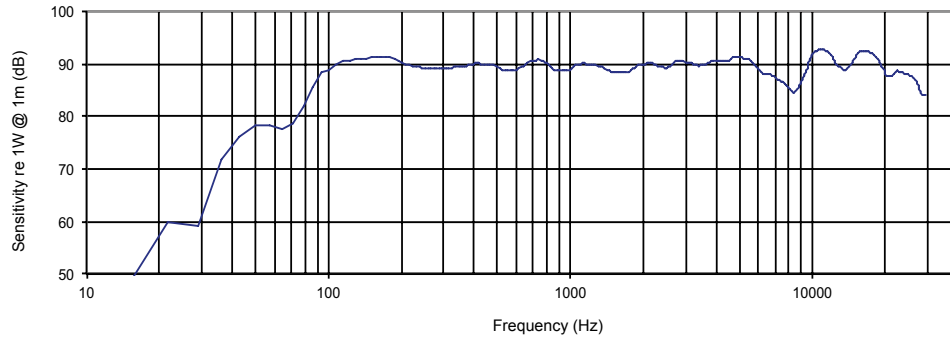

**ANECHOIC
FREQUENCY
RESPONSE**

Impedance vs frequency

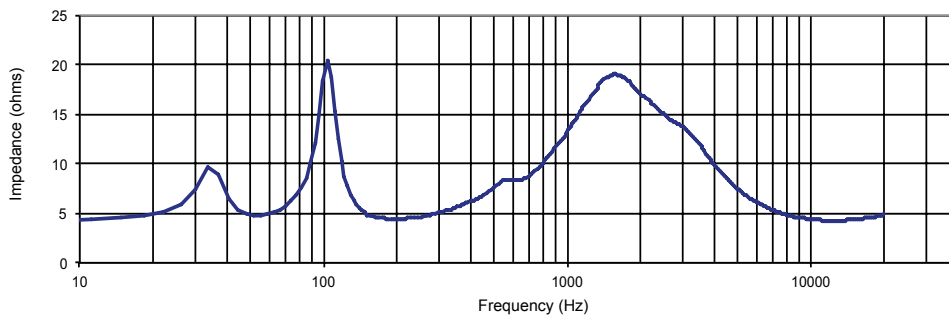

IMPEDANCE

Horizontal Off-axis Frequency Response

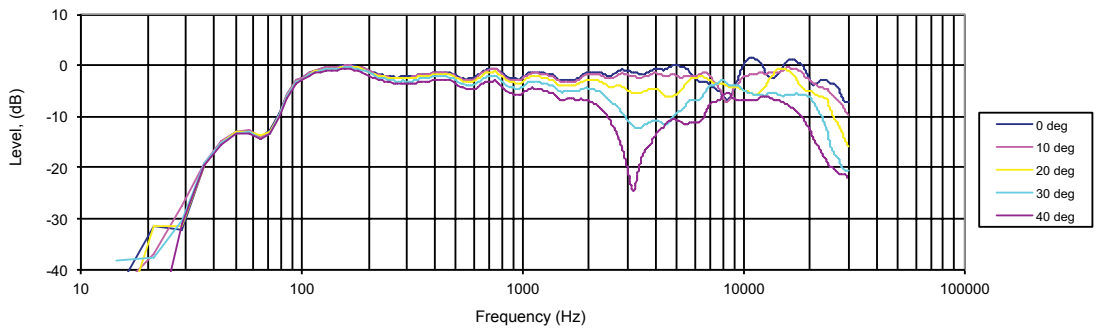

**HORIZONTAL
OFF-AXIS
RESPONSE**

Tannoy (Direct UK)
TCGI (ROW sales)
TCGA (Americas sales)
Tannoy Middle East

T: 00 44 (0) 1236 420199
T: 00 45 8742 7000
T: 00 1 (519) 745 1158
T: 00 971 (04) 4401208

E: enquiries@tannoy.com
E: info@tcgroup-international.com
E: info@tcgroup-americas.com
E: enquiries@tannoy.com

tannoy®.com



Upper Vertical Off-axis Frequency Response

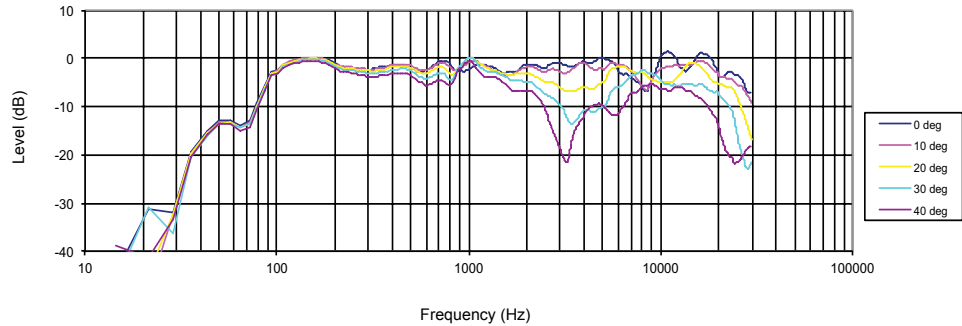

UPPER VERTICAL OFF-AXIS RESPONSE

Lower Vertical Off-axis Frequency Response

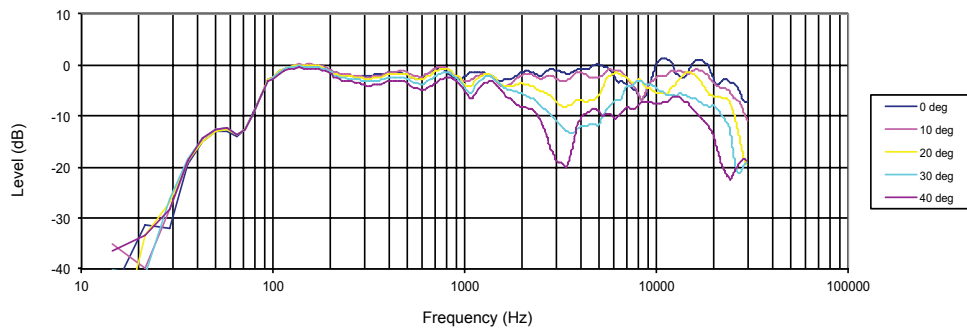

LOWER VERTICAL OFF-AXIS RESPONSE

Beamwidth vs Frequency

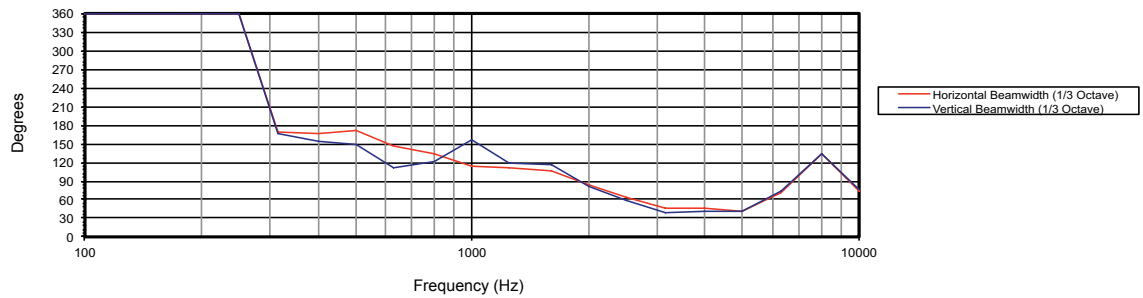

BEAMWIDTH

Tannoy (Direct UK)
 TCGI (ROW sales)
 TCGA (Americas sales)
 Tannoy Middle East

T: 00 44 (0) 1236 420199
 T: 00 45 8742 7000
 T: 00 1 (519) 745 1158
 T: 00 971 (04) 4401208

E: enquiries@tannoy.com
 E: info@tcgroup-international.com
 E: info@tcgroup-americas.com
 E: enquiries@tannoy.com

tannoy®.com



DVS 8 / DVS 8t

TANNOY®

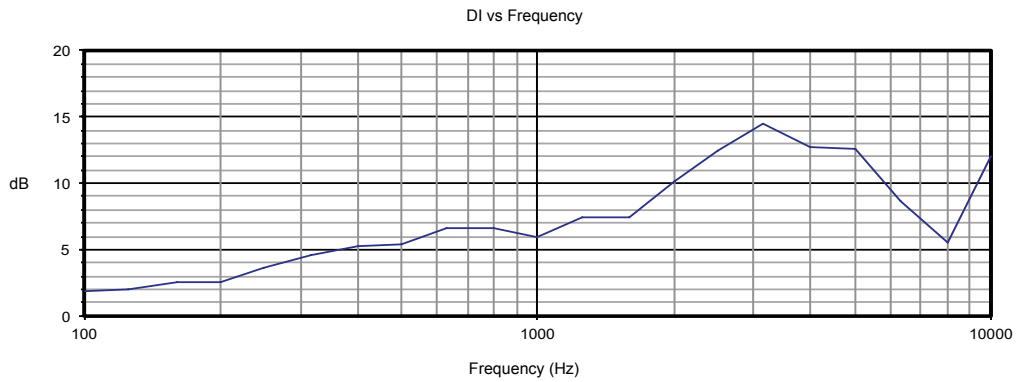

DIRECTIVITY INDEX

Tannoy (Direct UK)
TCGI (ROW sales)
TCGA (Americas sales)
Tannoy Middle East

T: 00 44 (0) 1236 420199
T: 00 45 8742 7000
T: 00 1 (519) 745 1158
T: 00 971 (04) 4401208

E: enquiries@tannoy.com
E: info@tcgroup-international.com
E: info@tcgroup-americas.com
E: enquiries@tannoy.com

tannoy®.com



DVS 8 / DVS 8t

TANNOY®

PERFORMANCE MEASUREMENTS POLAR PLOTS (1/3 OCTAVE) HORIZONTAL

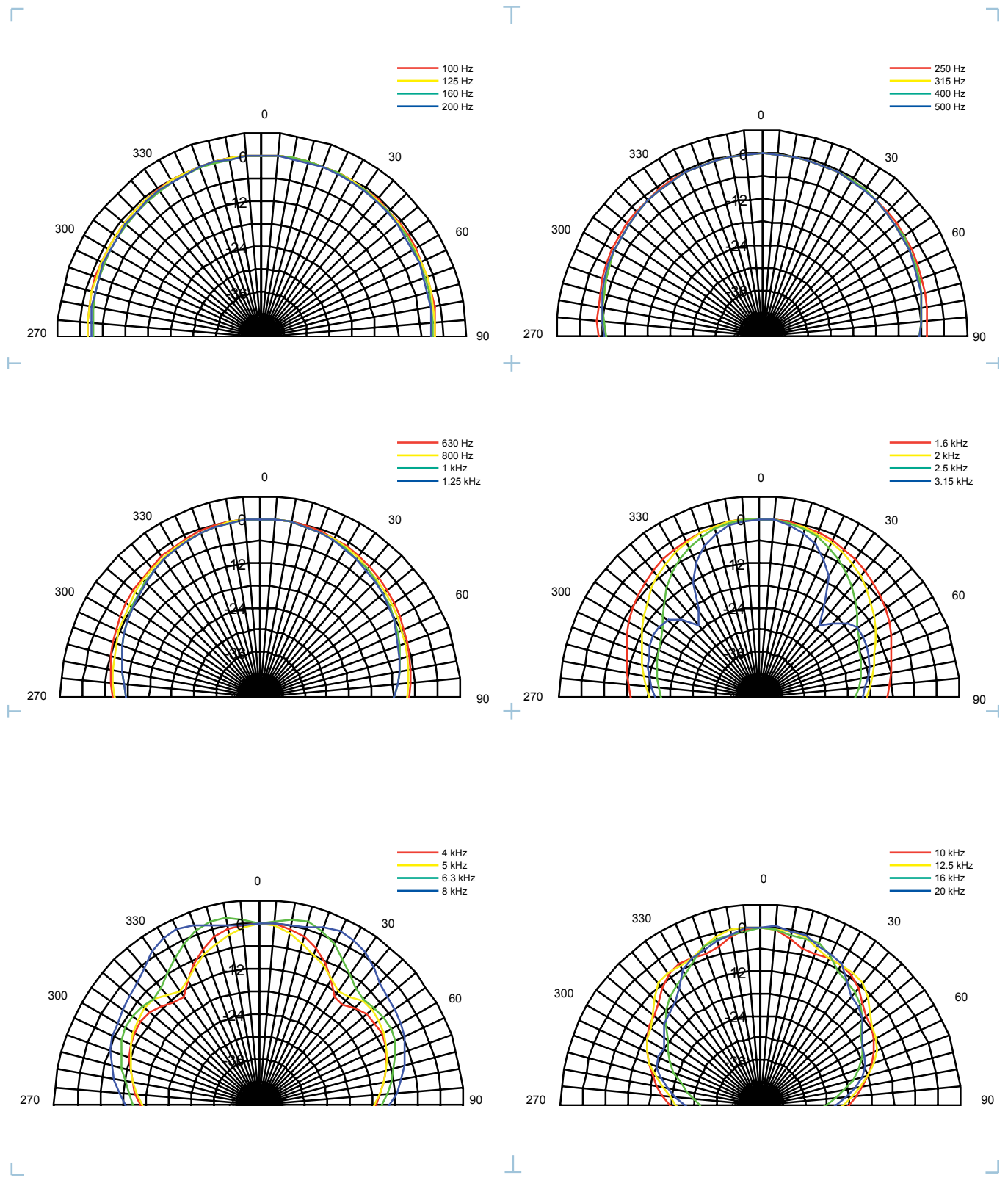

Tannoy (Direct UK)
 TCGI (ROW sales)
 TCGA (Americas sales)
 Tannoy Middle East

T: 00 44 (0) 1236 420199
 T: 00 45 8742 7000
 T: 00 1 (519) 745 1158
 T: 00 971 (04) 4401208

E: enquiries@tannoy.com
 E: info@tcgroup-international.com
 E: info@tcgroup-americas.com
 E: enquiries@tannoy.com

tannoy®.com



DVS 8 / DVS 8t

TANNOY®

PERFORMANCE MEASUREMENTS POLAR PLOTS (1/3 OCTAVE) VERTICAL

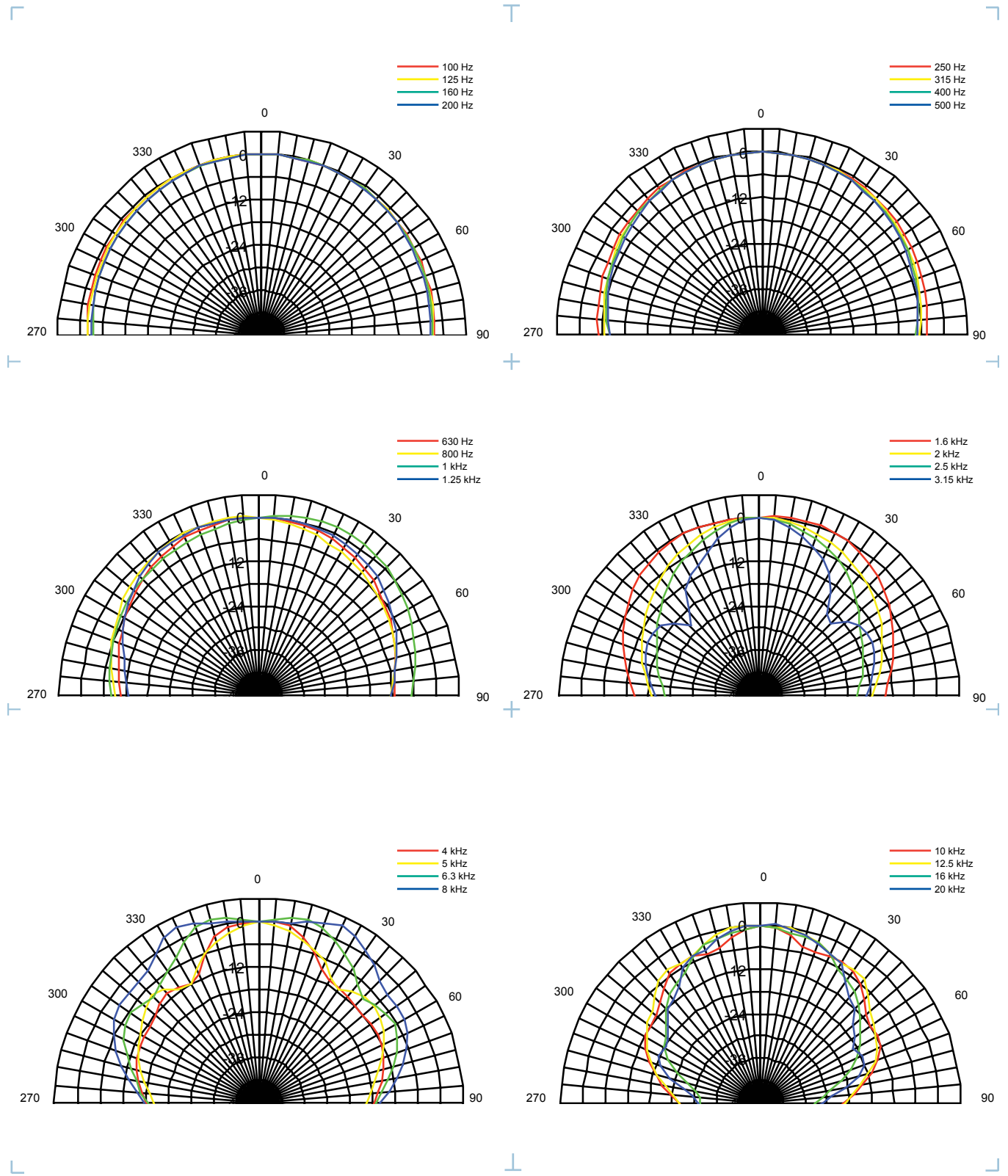

Tannoy (Direct UK)
 TCGI (ROW sales)
 TCGA (Americas sales)
 Tannoy Middle East

T: 00 44 (0) 1236 420199
 T: 00 45 8742 7000
 T: 00 1 (519) 745 1158
 T: 00 971 (04) 4401208

E: enquiries@tannoy.com
 E: info@tcgroup-international.com
 E: info@tcgroup-americas.com
 E: enquiries@tannoy.com

tannoy®.com



DVS 8 / DVS 8t

TANNOY®

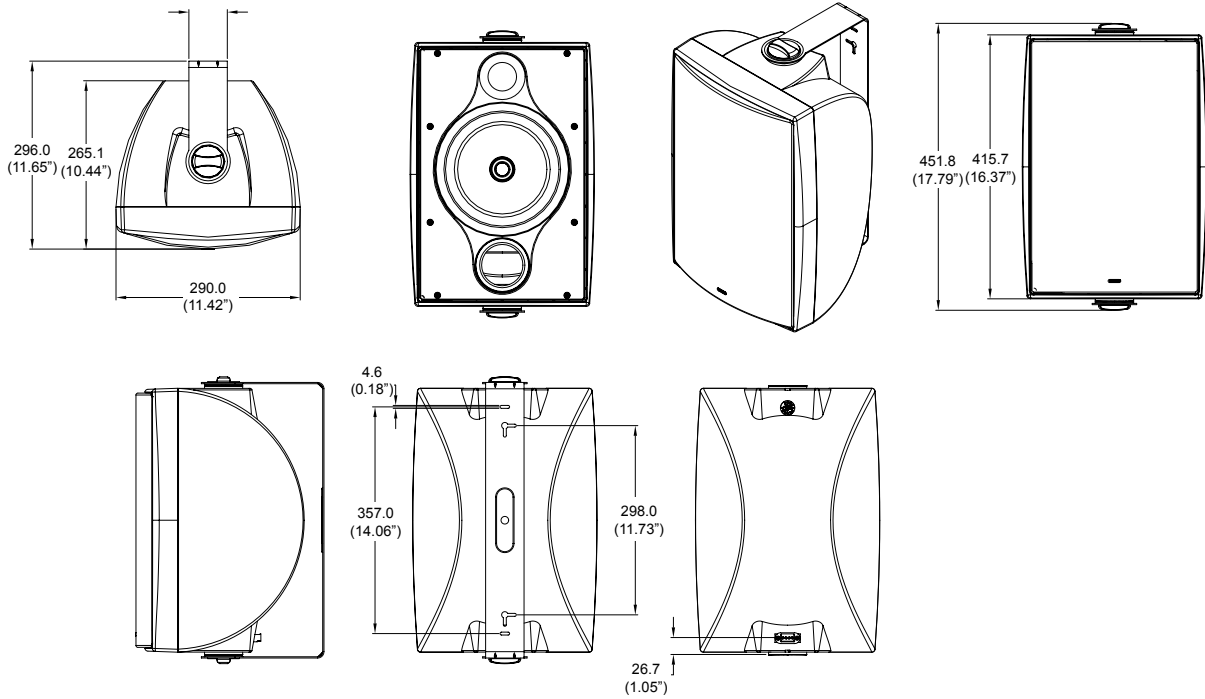

SUPPLIED ACCESSORIES

DVS 8 Yoke Bracket

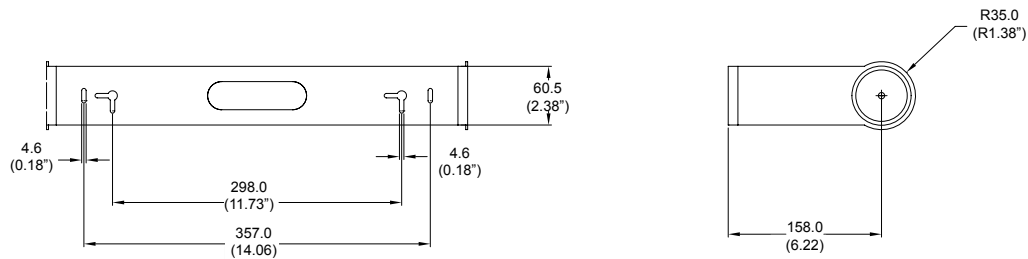
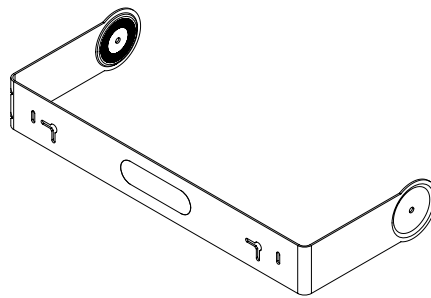
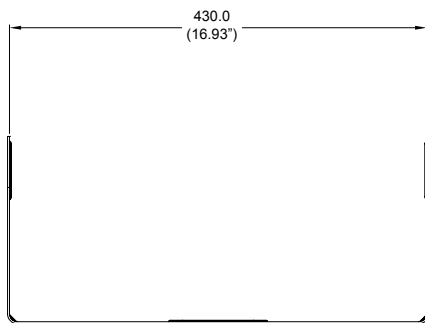

Tannoy (Direct UK)
 TCGI (ROW sales)
 TCGA (Americas sales)
 Tannoy Middle East

T: 00 44 (0) 1236 420199
 T: 00 45 8742 7000
 T: 00 1 (519) 745 1158
 T: 00 971 (04) 4401208

E: enquiries@tannoy.com
 E: info@tcgroup-international.com
 E: info@tcgroup-americas.com
 E: enquiries@tannoy.com

tannoy®.com



Architectural specifications DVS 8

The weather resistant, surface mount speaker system shall consist of a 200mm (8.00") mineral loaded mid bass driver with coaxially mounted 19mm (0.75") high frequency unit and passive frequency dividing network optimally tuned vented, injection moulded high impact polystyrene (HIPS) enclosure IP64 to EN60529. The protective grille shall be constructed from aluminium with a weather resistant coating.

Performance of the DVS 8 surface mount speaker shall meet or exceed the following criteria: The system shall have a conical coverage pattern of 80 degrees (-6dB). Frequency response measured on axis shall be 75Hz-20kHz (-10dB) from rated sensitivity, average over stated bandwidth. Measured 1 metre in an anechoic chamber) with no equalisation. Sensitivity shall be 90dB (1W=2.45V for 6 Ohms). Long term power handling capacity as defined in EIA-426B test shall be 70W, recommended amplifier power 140W. The nominal system impedance shall be 6 Ohms (in low impedance setting).

A termination recess shall be integrated with the rear panel, a removable Euroblock type locking connector with screw terminals to secure wire termination with "loop through" facility shall be provided. A yoke mounting bracket shall be included with the speaker system.

The dimensions shall not exceed (H)451.8 x (W)290.0 x (D)296.0mm (17.78" x 11.42" x 11.65")

The surface mount system shall be the DVS 8

Architectural specifications DVS 8t

The weather resistant, surface mount speaker system shall consist of a 100mm (4.00") mineral loaded mid bass driver with coaxially mounted 19mm (0.75") high frequency unit and passive frequency dividing network optimally tuned vented, injection moulded high impact polystyrene (HIPS) enclosure IP64 to EN60529. The protective grille shall be constructed from aluminium with a weather resistant coating.

Performance of the DVS 8t surface mount speaker shall meet or exceed the following criteria: The system shall have a conical coverage pattern of 90 degrees (-6dB). Frequency response measured on axis shall be 75Hz-20kHz (-10dB) from rated sensitivity, average over stated bandwidth. Measured 1 metre in an anechoic chamber) with no equalisation. Sensitivity shall be 87dB (1W=2.45V for 6 Ohms). Long term power handling capacity as defined in EIA-426B test shall be 90W, recommended amplifier power 180W. The nominal system impedance shall be 6 Ohms (in low impedance setting).

The DVS 8t speaker system shall be equipped with a 60W high performance line transformer for use with 70.7 or 100 Volt distributed audio systems with 60W / 30W / 15W / 7.5W*Watt, OFF and low impedance settings.

A removable Euroblock type locking connector with screw terminals to secure wire termination with "loop through" facility shall be provided. A yoke mounting bracket shall be included with the speaker system.

The dimensions shall not exceed (H)451.8 x (W)290.0 x (D)296.0mm (17.78" x 11.42" x 11.65")

The surface mount system shall be the DVS 8t

*70 Volt only



DVS 8 / DVS 8t

TANNOY®

NOTES

Tannoy (Direct UK)
TCGI (ROW sales)
TCGA (Americas sales)
Tannoy Middle East

T: 00 44 (0) 1236 420199
T: 00 45 8742 7000
T: 00 1 (519) 745 1158
T: 00 971 (04) 4401208

E: enquiries@tannoy.com
E: info@tcgroup-international.com
E: info@tcgroup-americas.com
E: enquiries@tannoy.com

tannoy®.com

