

# ***Network Camera***

---

## **User's Guide**

Software Version 1.0

**IPELA** *ExwavePRO*

**SNC-DM110/SNC-DS10**

**SNC-DM160/SNC-DS60**

**SNC-CM120/SNC-CS20**

---

# Table of Contents

---

## Overview

Features .....	4
How to Use This User's Guide .....	5
System Requirements .....	5

---

## Preparation

Assigning the IP Address to the Camera .....	6
Assigning an IP address using the IP Setup Program .....	6
When using Windows XP Service Pack 2 .....	8
When using Windows Vista .....	10
Accessing the Camera Using the Web Browser	13
Basic Configuration by the Administrator .....	15

---

## Operating the Camera

Administrator and User .....	16
Logging in to Homepage — Welcome Page .....	17
Logging in as a user .....	17
Displaying the Administrator menu directly .....	18
About viewers .....	18
Configuration of Main Viewer .....	19
Main menu .....	19
Camera control section .....	19
Monitor image section .....	20
Controlling the Monitor Image .....	21
Monitoring the camera image .....	21
Zooming in the monitor image .....	22
Capturing a Monitor Image .....	22
Capturing a monitor image .....	22
Saving the captured image .....	23
Operating the Camera Using SolidPTZ (SNC-DM110 / DM160 / CM120 only) .....	23
Controlling via the control panel .....	23
Panning and tilting by clicking the monitor image .....	24
Panning, tilting and zooming by specifying the area .....	24
Zooming an image by the camera zoom bar .....	24
Displaying the preset area of the image .....	24
Controlling the Camera on a Full Image (SNC-DM110 / DM160 / CM120 only) .....	25
Displaying a specified point in the monitor window .....	25
Using the Trigger Button .....	26
Sending a monitor image via e-mail .....	26

Sending a monitor image to an FTP server .....	26
Recording a camera image as a still image .....	26
Controlling alarm output 1, 2 .....	26
Controlling Day/Night function (SNC-DM160 / DS60 / CM120 / CS20 only) .....	26
Playing the audio file stored in the camera .....	27

---

## Adminstrating the Camera

Basic Operations of Administrator Menu .....	28
How to setup the Administrator menu .....	28
Configuration of Administrator menu .....	29
Configuring the System — System Menu .....	30
System Tab .....	30
Date & time Tab .....	32
Installation Tab .....	33
Initialize Tab .....	34
System log Tab .....	35
Access log Tab .....	35
Setting the Camera Image and Audio — Camera Menu .....	35
Common Tab .....	35
Picture Tab .....	36
Sense up Tab (SNC-DM110 / DM160 / DS60 / CM120 / CS20 only) .....	38
Video codec Tab .....	40
Streaming Tab .....	44
Configuring the Network — Network Menu .....	46
Network Tab .....	46
Dynamic IP address notification Tab — Notifying the IP Address .....	47
Using the 802.1X Authentication Function — 802.1X Menu .....	49
System configuration of 802.1X network .....	49
Common Tab — Basic setting of 802.1X authentication function .....	49
Client certificate Tab .....	50
CA certificate Tab .....	51
Setting the 802.1X authentication function — Example of Windows Server 2003 .....	51
Setting the User — User Menu .....	54
Setting the Security — Security Menu .....	55
Saving the SolidPTZ Display Area and Action — Preset position Menu (SNC-DM110 / DM160 / CM120 only) .....	56
Position Tab — Saving pan/tilt/zoom position .....	56
Tour Tab — Setting a tour .....	57
Sending an Image via E-mail — e-Mail (SMTP) Menu .....	59
Common Tab — Setting the e-Mail (SMTP) Function .....	59
Alarm sending Tab — Setting the e-mail sending mode when detecting the alarm .....	60

Periodical sending Tab — Setting the periodical e-mail sending mode .....	61
<b>Sending Images to FTP Server — FTP client Menu .....</b>	<b>62</b>
Common Tab — Setting the FTP client function .....	62
Alarm sending Tab — Setting the FTP client action when detecting the alarm .....	63
Periodical sending Tab — Setting the periodical FTP client activity .....	64
<b>Recording Images in Memory — Image memory Menu .....</b>	<b>65</b>
Common Tab — Setting the image memory function .....	65
Alarm recording Tab — Setting the Image memory function when detecting the alarm ...	66
Periodical recording Tab — Setting the periodical recording mode .....	67
Folder structure of image memory .....	67
<b>Downloading Images from the Camera — FTP server Menu .....</b>	<b>68</b>
<b>Setting the Alarm Output— Alarm output Menu .....</b>	<b>69</b>
Alarm out 1, 2 Tab .....	69
<b>Outputting Audio Linked to Alarm Detection — Voice alert Menu .....</b>	<b>70</b>
Voice alert 1, 2, 3 Tab .....	70
<b>Setting the Operations from the Viewer — Trigger Menu .....</b>	<b>71</b>
<b>Setting the Schedule — Schedule Menu .....</b>	<b>73</b>
<b>Setting the Alarm Buffer — Alarm buffer Menu .....</b>	<b>74</b>
<b>Setting the Motion Detection Function — Motion detection Menu .....</b>	<b>75</b>
Setting Tab .....	75

---

## Others

<b>Using the Supplied IP Setup Program .....</b>	<b>78</b>
Starting the IP Setup Program .....	78
Bandwidth control Tab .....	78
Date time Tab .....	79
Rebooting the Camera .....	79
<b>Using the SNC audio upload tool — Transmitting Audio to Camera .....</b>	<b>80</b>
Installing the SNC audio upload tool .....	80
Connecting the Camera to the Computer .....	80
Using the SNC audio upload tool .....	80
<b>Using the SNC video player — Playing Video/ Audio File Recorded with Camera .....</b>	<b>85</b>
Installing the SNC video player .....	85
Using the SNC video player .....	86

<b>Using the SNC privacy masking tool — Masking a Camera Image .....</b>	<b>87</b>
Installing the SNC privacy masking tool .....	87
Using the SNC privacy masking tool .....	87
Setting a privacy mask .....	88
<b>Using the Custom Homepage Installer .....</b>	<b>89</b>
Uploading the homepage to the camera using the Custom Homepage Installer .....	89
<b>Assigning the IP Address to the Camera Using ARP Commands .....</b>	<b>91</b>
<b>Using the SNMP .....</b>	<b>92</b>
1. Inquiry Commands .....	92
2. Setting Commands .....	92
<b>Specifications .....</b>	<b>93</b>
<b>Glossary .....</b>	<b>94</b>
<b>Index .....</b>	<b>97</b>

# Features

- High-resolution, high-sensitivity image thanks to ExwavePRO technology complementary filter progressive scan CCD
- Easy focus adjustment with iris open button and focus assist functions
- Improved alarm accuracy by using the intelligent motion detection function that ignores environmental noise
- Delivers JPEG 30 fps and MPEG4 30 fps images simultaneously on VGA size by using a high-quality encoder
- Sets the correct exposure in harsh lighting conditions by setting the variable gamma
- Crops the image from the Quad-VGA 1280 × 960 view image by using the SolidPTZ function as if it were PTZ control. (SNC-DM110 / DM160 / CM120 only)
- Improved sensitivity at night by using the Light funnel function. (SNC-DM110 / DM160 / CM120 only)

## NOTICE TO USERS

© 2008 Sony Corporation. All rights reserved. This manual or the software described herein, in whole or in part, may not be reproduced, translated or reduced to any machine readable form without prior written approval from Sony Corporation.

SONY CORPORATION PROVIDES NO WARRANTY WITH REGARD TO THIS MANUAL, THE SOFTWARE OR OTHER INFORMATION CONTAINED HEREIN AND HEREBY EXPRESSLY DISCLAIMS ANY IMPLIED WARRANTIES OF MERCHANTABILITY OR FITNESS FOR ANY PARTICULAR PURPOSE WITH REGARD TO THIS MANUAL, THE SOFTWARE OR SUCH OTHER INFORMATION. IN NO EVENT SHALL SONY CORPORATION BE LIABLE FOR ANY INCIDENTAL, CONSEQUENTIAL OR SPECIAL DAMAGES, WHETHER BASED ON TORT, CONTRACT, OR OTHERWISE, ARISING OUT OF OR IN CONNECTION WITH THIS MANUAL, THE SOFTWARE OR OTHER INFORMATION CONTAINED HEREIN OR THE USE THEREOF.

Sony Corporation reserves the right to make any modification to this manual or the information contained herein at any time without notice.

The software described herein may also be governed by the terms of a separate user license agreement.

- “IPELA” and **IPELA** are trademarks of Sony Corporation.
- “ExwavePRO” and **ExwavePRO** are trademarks of Sony Corporation.
- Microsoft, Windows, Internet Explorer and MS-DOS are registered trademarks of Microsoft Corporation in the United States and/or other countries.
- Java is a trademark of Sun Microsystems, Inc. in the United States and other countries.
- Intel, Core and Pentium are registered trademarks of Intel Corporation or its subsidiaries in the United States and other countries.
- Adobe, Acrobat and Adobe Reader are trademarks of Adobe Systems Incorporated in the United States and/or other countries.

All other company and product names are trademarks or registered trademarks of the respective companies or their respective makers.

# How to Use This User's Guide

This User's Guide explains how to operate the Network Camera from a computer.

The User's Guide is written to be read on the computer display.

As this section gives tips on using the User's Guide, read it before you operate the camera.

## Jumping to the related page

When you read the User's Guide on the computer display, click on the sentence to jump to the related page.

## Software display examples

Note that the displays shown in the User's Guide are explanatory examples. Some displays may be different from the ones which appear as you operate the application software.

The illustrations of the camera and menu display in the User's Guide mainly show the SNC-DM160 as an example.

## Printing the User's Guide

Depending on your system, certain displays or illustrations in the User's Guide, when printed out, may differ from those as portrayed on your screen.

## Installation Manual (printed matter)

The supplied Installation Manual describes the names and functions of parts and controls of the Network Camera, connecting examples and how to set up the camera. Be sure to read the Installation Manual before operating.

# System Requirements

	SNC-DM110 SNC-DM160 SNC-CM120	SNC-DS10 SNC-DS60 SNC-CS20
CPU	Intel Pentium 4 3 GHz or higher Intel Core 2 Duo 2 GHz or higher	Intel Pentium 4 2.4 GHz or higher Intel Core 2 Duo 1.8 GHz or higher
Memory	1 GB or more	
OS	Microsoft Windows XP, Windows Vista	
Web browser	Microsoft Internet Explorer Ver. 6.0, 7.0	
Display resolution (recommended)	1600 × 1200 pixels or more	1280 × 1024 pixels or more

## Preparation

The Preparation section explains what the administrator has to prepare for monitoring images after installation and connection of the camera.

# Assigning the IP Address to the Camera

To connect the camera to a network, you need to assign a new IP address to the camera when you install it for the first time.

You can assign an IP address in two ways:

- Using the IP Setup Program stored in the supplied CD-ROM (see this page)
- Using the ARP (Address Resolution Protocol) commands (see page 91)

This section explains how to assign an IP address to the camera using the supplied setup program and how to configure the network.

Before starting, connect the camera, referring to “Connecting the Camera to a Local Network” in the supplied Installation Manual.

Consult the administrator of the network about the assigned IP address.

### Notes

- The IP Setup Program may not operate correctly if you use a personal firewall or antivirus software in your computer. In that case, disable the software or assign an IP address to the camera using another method. For example, see “Assigning the IP Address to the Camera Using ARP Commands” on page 91.
- If you are using Windows XP Service Pack 2 or Windows Vista, disable the Windows Firewall function. Otherwise the IP Setup Program will not operate correctly. For the setting, see “Configuring Windows Firewall” in “When using Windows XP Service Pack 2” on page 9 or “Configuring Windows Firewall” in “When using Windows Vista” on page 11.

## Assigning an IP address using the IP Setup Program

- 1** Insert the CD-ROM in your CD-ROM drive. A cover page appears automatically in your Web browser. If it does not appear automatically in the Web browser, double-click on the index.htm file on the CD-ROM.

When you are using Windows Vista, pop-up “AutoPlay” may appear. For details, “Installing software” in “When using Windows Vista” on page 10.

- 2** Click the **Setup** icon of **IP Setup Program**. The “File Download” dialog opens.

When you are using Windows XP Service Pack 2 or Windows Vista, a message regarding the active contents may appear. For details, see “Installing software” in “When using Windows XP Service Pack 2” on page 8 or “Installing software” in “When using Windows Vista” on page 10.

- 3** Click **Open**.

### Note

If you click “Save this program to disk” on the “File Download” dialog, you will not be able to perform set up correctly. Delete the downloaded file, and click the **Setup** icon again.

- 4** Install the IP Setup Program on your computer using the wizard. If the Software License Agreement is displayed, read it carefully and click **Accept** to continue with the installation.
- 5** Start the IP Setup Program.

When you are using Windows Vista, message “User Account Control – An unidentified program wants access to your computer” may appear. In this case, click **Allow**.

The program detects the network cameras connected to the local network and lists them on the Network tab window.

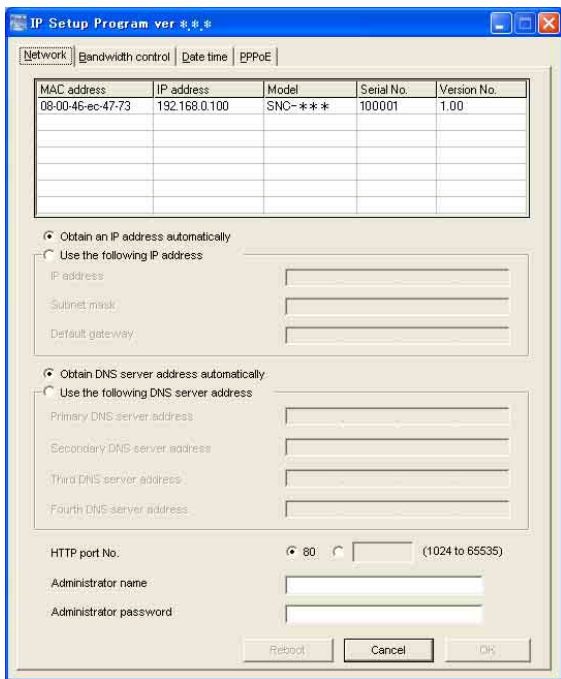

- 6 Click on the camera in the list to which you want to assign a new IP address.

MAC address	IP address	Model	Serial No.	Version No.
08-00-46-ec-47-73	192.168.0.100	SNC-***	100001	1.00

The network settings for the selected camera are displayed.

- 7 Set the IP address.

**To obtain the IP address automatically from a DHCP server:**

Select **Obtain an IP address automatically**.

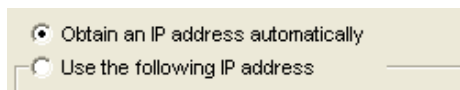

The IP address, Subnet mask and Default gateway are assigned automatically.

**To specify the IP address manually:**

Select **Use the following IP address**, and type the IP address, Subnet mask and Default gateway in the relevant boxes.

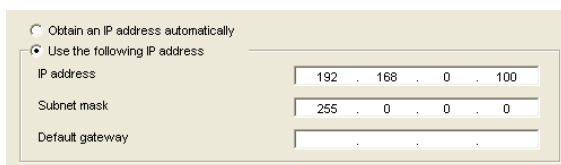

### Note

When you select **Obtain an IP address automatically**, make sure that the DHCP server is operating on the network.

- 8 Set the DNS server address.

**To obtain the DNS server addresses automatically:**

Select **Obtain DNS server address automatically**.



**To specify the DNS server addresses manually:**

Select **Use the following DNS server address**, and type the Primary DNS server address and Secondary DNS server address in the relevant boxes.

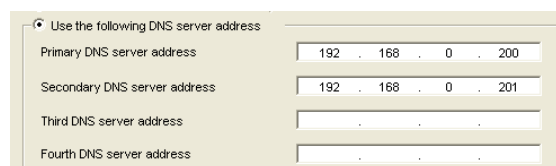

### Note

The Third DNS server address and Fourth DNS server address are invalid for this camera.

- 9 Set the HTTP port No.



Normally, select **80** for the HTTP port No. To use another port number, type the port number between 1024 and 65535 in the text box.

- 10 Type the Administrator name and Administrator password.



The factory settings of both items are “admin.”

### Note

You cannot change the Administrator name and Administrator password in this step. To change these items, see “Setting the User — User Menu” on page 54.

- 11 Confirm that all items are correctly set, then click **OK**.

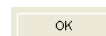

If “Setting OK” is displayed, the IP address is correctly assigned.



**12** To access the camera directly, double-click the camera name in the list.

MAC address	IP address	Model	Serial No.	Version No.
08-00-46-ec-47-73	192.168.0.100	SNC-***	100001	1.00

**Tips**

- The factory setting of the camera network is as follows.  
IP address: 192.168.0.100  
Subnet mask: 255.0.0.0
- When you select the camera in the network tab and right-click **Copy**, and the camera’s **MAC address, DHCP/FIXED\*, IP address, Port number, Model name, Serial number** and **Version number** can be copied in the clipboard. When you hold down **Ctrl** and press **a**, you can select all cameras in the network tab.

\* **DHCP** stands for a DHCP setting. **FIXED** stands for a fixed IP address.

The welcome page of the network camera is displayed on the Web browser.

**Display sample: SNC-DM160**

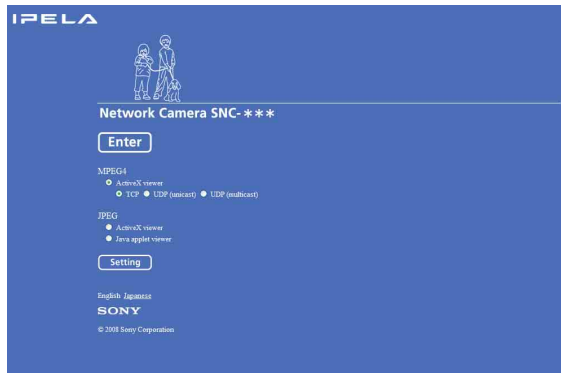

**Note**

If the IP address is not set correctly, the welcome page does not appear after step 12. In that case, try to set the IP address again.

## When using Windows XP Service Pack 2

### Installing software

A warning message regarding the active contents may appear when you install software such as IP Setup Program from CD-ROM. In this case, operate as follows:

Example: In case of IP Setup Program

If message “Internet Explorer” appears, click **Yes**.



If message “File Download – Security Warning” appears, click **Run**.



**Note**

If you select **Save** in the “File Download – Security Warning” dialog, you will not be able to perform installation correctly. Delete the downloaded file, and click the **Setup** icon again.



If message “Internet Explorer – Security Warning” appears, click **Run**.



The software installation starts.

## Installing ActiveX Control

During installation of ActiveX Control, the information bar or “Security Warning” may appear. In this case, operate as follows:

If message “Information Bar” appears, click **OK**.



If the information bar appears, click on the bar and select **Install ActiveX Control...**



If “Internet Explorer – Security Warning” appears, click **Install**.



The installation of ActiveX Control starts. When installation is completed, the main viewer or the Motion detection menu appears.

## Configuring Windows Firewall

The IP Setup Program or SNC audio upload tool may not operate correctly depending on the configuration of Windows Firewall. (No cameras are shown in the list even if they are detected.) In this case, confirm the Windows Firewall configuration as follows:

Example: In case of IP Setup Program

- 1 Select **Control Panel** from the Start menu of Windows.
- 2 Select **Security Center** of the working field.
- 3 Select **Windows Firewall** and select **Off** in the Windows Firewall dialog.

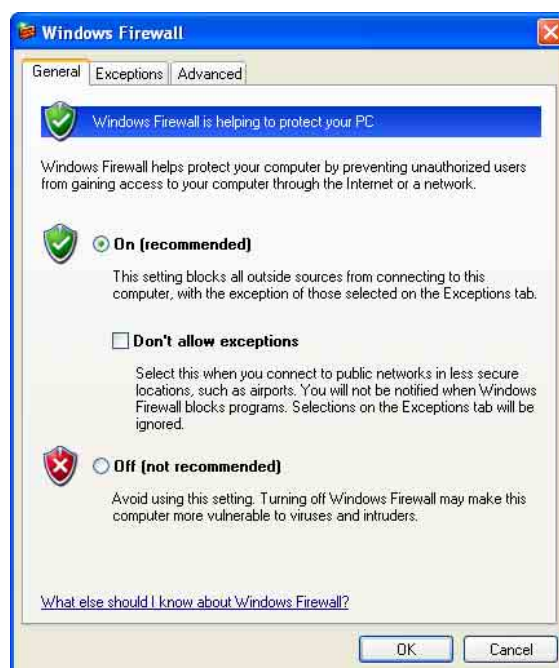

The cameras will be displayed in the list.

If you want to keep Windows Firewall **On**, continue with the following steps.

- 4 Select the “Exceptions” tab.

## 5 Select Add Program....

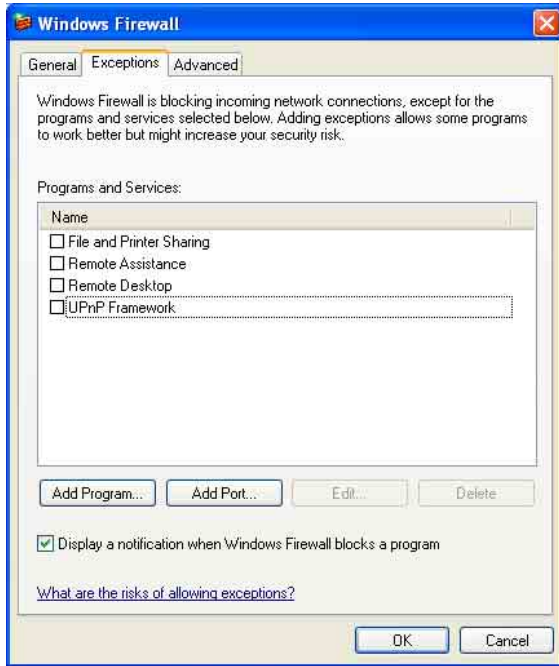

## 6 In the Add Program dialog, select IP Setup Program and click OK.

Then the IP Setup Program is added to the Programs and Services list.

## 7 Click OK.



When the above procedure is completed, the cameras connected in the local network are displayed in the IP Setup Program.

## When using Windows Vista

### Installing software

A warning message regarding the active contents may appear when you install software such as IP Setup Program from CD-ROM. In this case, operate as follows:

Example: In case of IP Setup Program

If pop-up “AutoPlay” appears when a CD-ROM is inserted into the CD-ROM drive, click **Install or run program**.



### Note

If you click **Open folder to view files**, Web browser will not open automatically. In this case, double-click the “index.htm” file in the CD-ROM.

If message “Internet Explorer” appears, click **Yes**.



If message “File Download – Security Warning” appears, click **Run**.

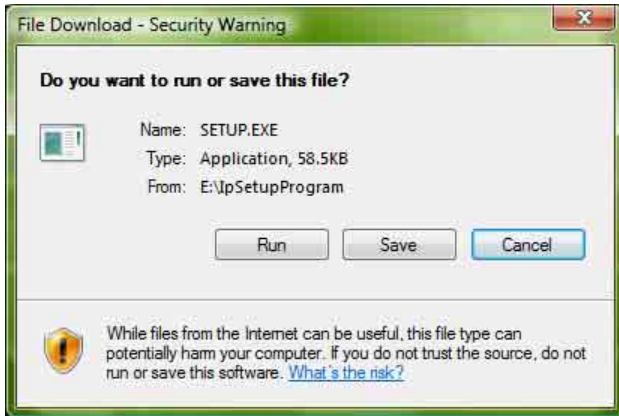

### Note

If you select **Save** in the “File Download – Security Warning” dialog, you will not be able to perform installation correctly. Delete the downloaded file, and click the Setup icon again.

If message “Internet Explorer – Security Warning” appears, click **Run**.



If message “User Account Control – An unidentified program wants access to your computer” appear, click **Allow**.

The software installation starts.

## Starting the software

When you start software such as IP Setup Program, message “User Account Control – An unidentified program wants access to your computer” may appear. In this case, click **Allow**.

## Installing ActiveX Control

During installation of ActiveX Control, the information bar or “Security Warning” may appear. In this case, operate as follows:

If message “Information Bar” appears, click **OK**.



If the information bar appears, click on the bar and select **Install ActiveX Control...**

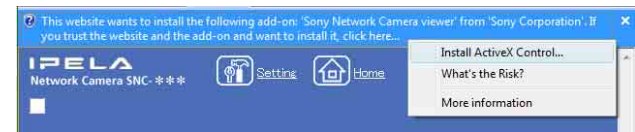

If message “User Account Control – Windows needs your permission to continue” appear, click **Continue**.

If “Internet Explorer – Security Warning” appears, click **Install**.



The installation of ActiveX Control starts. When installation is completed, the main viewer or the Motion detection menu appears.

## Configuring Windows Firewall

The IP Setup Program or SNC audio upload tool may not operate correctly depending on the configuration of Windows Firewall. (No cameras are shown in the list even if they are detected.) In this case, confirm the Windows Firewall configuration as follows:

Example: In case of IP Setup Program

- 1 Select **Control Panel** from the Start menu of Windows.
- 2 Click **Windows Firewall**.
- 3 Select **Turn Windows Firewall on or off**. “User Account Control – Windows needs your permission to continue” may appear. In this case, click **Continue**.

#### 4 Select **Off** in the “General” tab.

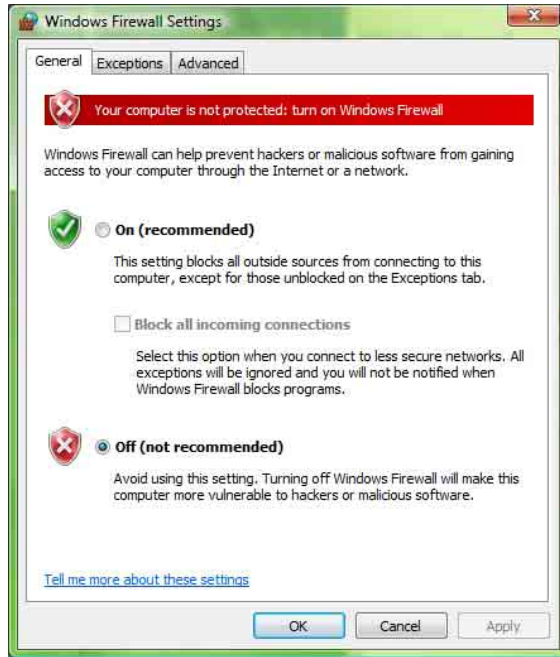

The cameras will be displayed in the list.

If you want to keep Windows Firewall **On**, continue with the following steps.

#### 5 Select the “Exceptions” tab.

#### 6 Select **Add Program...**

#### 7 If the Add Program dialog appears, select **IP Setup Program** and click **OK**.



Then the IP Setup Program is added to the Program or port list.

#### 8 Click **OK**.

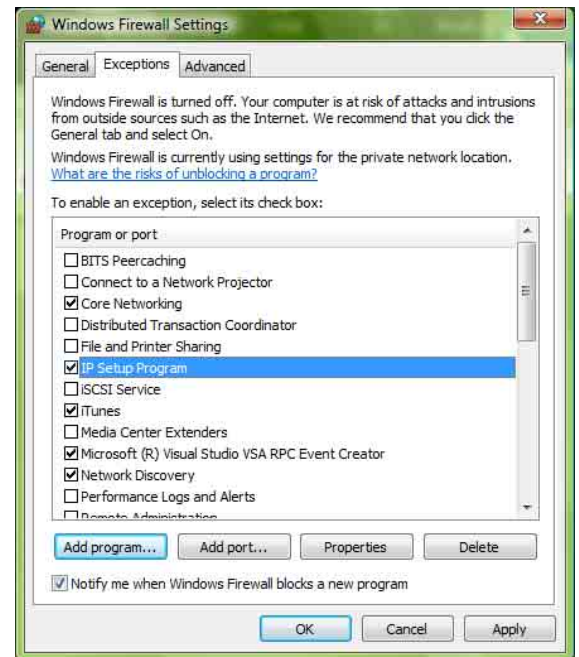

When the above procedure is completed, the cameras connected in the local network are displayed in the IP Setup Program.

# Accessing the Camera Using the Web Browser

After the IP address has been assigned to the camera, check that you can actually access the camera using the Web browser installed on your computer. Use Internet Explorer as the Web browser.

- 1 Start the Web browser on the computer and type the IP address of the camera in the URL box.

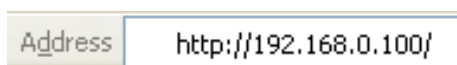

The welcome page of the network camera is displayed on the Web browser.

## Display sample: SNC-DM160



- 2 Click **Enter**.  
The main viewer is displayed.



If the main viewer is displayed correctly, accessing the camera is confirmed.

## When the main viewer of the camera is displayed for the first time

When you click **Enter**, “Security Warning” is displayed. When you click **Yes**, ActiveX control is installed and the main viewer is displayed.



## Notes

- If **Automatic configuration** is enabled in the Local Area Network (LAN) Settings of Internet Explorer, the image may not be displayed. In that case, disable **Automatic configuration** and set the Proxy server manually. For the setting of the Proxy server, consult your network administrator.
- When you install ActiveX Control, you should be logged in to the computer as Administrator.
- When you are using Windows XP Service Pack 2 or Windows Vista, the information bar or “Security Warning” may appear as you click **Enter**. For details, see “Installing ActiveX Control” in “When using Windows XP Service Pack 2” on page 9 or “Installing ActiveX Control” in “When using Windows Vista” on page 11.

## Tip

Every page of this software is optimized as display character size **Medium** for Internet Explorer.

## To display the welcome page and the main viewer correctly

To operate the welcome page and the main viewer correctly, set the security level of the Internet Explorer to **Medium** or lower, as follows:

- 1 Select **Tools** from the menu bar for Internet Explorer, then select **Internet Options** and click the **Security** tab.
- 2 Click the **Internet** icon (when using the camera via the Internet) or **Local intranet** icon (when using the camera via a local network).

- 3 Set the slider to **Medium** or lower. (If the slider is not displayed, click **Default Level**.)

### **When using antivirus software, etc. on the computer**

- When you use antivirus software, security software, personal firewall or pop-up blocker on your computer, the camera performance may be reduced, for example, the frame rate for displaying the image may be lower.
- The Web page displayed when you log in to the camera uses JavaScript. The display of the Web page may be affected if you use antivirus software or other software described above on your computer.

# Basic Configuration by the Administrator

You can monitor the camera image by logging in with the initial conditions set for this network camera. You can also set various functions according to the installing position, network conditions or purpose of the camera. We recommend you configure the following items before monitoring images from the camera.

Setting contents	Setting menu
Synchronize the date and time of the camera with those of the computer.	Date & time Tab (page 32)
Prepare a full image. (SNC-DM110 / DM160 / CM120 only)	Capture full image (page 34)
Select whether to use the audio input.	Audio input (page 35)
Select the white balance mode according to the installing position (surrounding light).	White balance (page 36)
Set the brightness of the image sent from the camera.	Exposure (page 36)
Set the format and size of the image sent from the camera.	Video codec Tab (page 40)
Select the quality of the image sent from the camera.	Video codec Tab (page 40)
Set the user access right for the camera.	User Menu (page 54)
Set a place to be watched beforehand. (SNC-DM110 / DM160 / CM120 only)	Preset position Menu (page 56)
Make the setting for sending the monitor image attached to an e-mail.	e-Mail (SMTP) Menu (page 59)

## Operating the Camera

The Operating the Camera section explains how to monitor the image from the camera using your Web browser. Use Internet Explorer as the Web browser.

The functions of the camera should be set by the Administrator. For the setting of the camera, see “Administering the Camera” on page 28.

## Administrator and User

This network camera identifies the people who log in as the **Administrator** or **User**.

The **Administrator** can use all the functions of this network camera including camera setting. The **User** can use the functions for monitoring the image and audio from the camera, and controlling the camera. The **Viewer mode** setting is used to restrict the user's access rights. There are five types of users.

Each type of user can use the corresponding functions below.

Function	Administrator	User				
		Full	Pan/Tilt <sup>4)</sup>	Preset position <sup>4)</sup>	Light	View
Monitor a live image	●	●	●	●	●	●
View the date and time	●	●	●	●	●	●
Receive the audio	●	●	●	●	●	●
Control the image view size	●	●	●	●	●	–
Zoom an image using the digital zoom	●	●	●	●	●	–
Save a still image in the computer	●	●	●	●	●	_ 1)
Call the Preset position <sup>2)</sup>	●	●	●	●	–	–
Perform the pan/tilt/zoom operation <sup>2)</sup>	●	●	●	–	–	–
Control the frame rate (Available in JPEG mode only)	●	●	–	–	–	–
Send an image file to the FTP server	●	●	–	–	–	–
Send an image attached to an e-mail	●	●	–	–	–	–
Record an image in the memory	●	●	–	–	–	–
Control the alarm output of the I/O port on the camera	●	●	–	–	–	–
Switch the Day/Night function mode <sup>3)</sup>	●	●	–	–	–	–
Play an audio file (Voice alert)	●	●	–	–	–	–
Control the setting menu	●	–	–	–	–	–

● Usable –Not usable

1) This function is usable with the Java applet viewer.

2) Available only when SolidPTZ is enabled on SNC-DM110 / DM160 / CM120.

3) Available for SNC-DM160 / DS60 / CM120 / CS20.

4) Available for SNC-DM110 / DM160 / CM120.

The access rights of the administrator and the user can be set in “Setting the User — User Menu” of the Administrator menu on page 54.



# Logging in to Homepage — Welcome Page

## Logging in as a user

- 1 Start the Web browser on your computer and type the IP address of the camera you want to monitor.

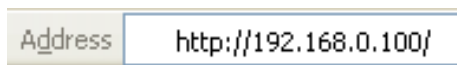

The welcome page of the network camera is displayed on the Web browser.

### Display sample: SNC-DM160

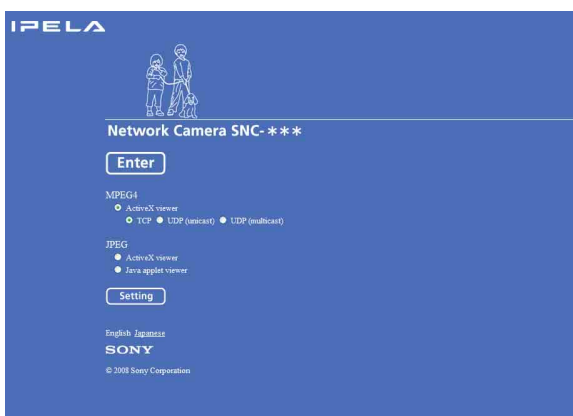

### Note

If the welcome page does not start correctly, the security level of the Internet Explorer may be set to higher than **Medium**. See “To display the welcome page and the main viewer correctly” on page 13 and check the security level.

- 2 Select the viewer.  
You can select ActiveX viewer when the video codec is MPEG4, and ActiveX viewer or Java applet viewer when the video codec is JPEG.

### With SNC-DM110 / DM160 / CM120

When you select an item including **MPEG4 - OFF** on **Image size** (page 40) in the Video codec tab, you can see the image only on JPEG.



- 3 When you select ActiveX viewer on MPEG4 in step 2, select the communication port for the video/audio data.  
Click to select **TCP**, **UDP (unicast)** or **UDP (multicast)**.  
Normally select **TCP**.

**TCP:** This is normally selected.

When **TCP** is selected as the communication port, HTTP communication is adopted for video/audio communications.

HTTP is the protocol used for reading the usual Web page.

In an environment capable of reading Web pages, you can watch or listen to the video/audio by selecting the TCP port.

**UDP (unicast):** When **UDP (unicast)** is selected as the communication port, RTP (Real-time Transport Protocol) is adopted for video/audio communications. Since RTP is the protocol for running video/audio data, the video/audio playback is smoother than when TCP (HTTP) is selected. If a firewall is installed between the camera and the computer, or depending on the network environment, the video/audio may not play back properly when **UDP (unicast)** is selected. In that case, select **TCP**.

**UDP (multicast):** This protocol is selectable when **Multicast streaming** (page 45) is **On**. When **UDP (multicast)** is selected as the communications port, RTP (Real-time Transport Protocol) and UDP multicast techniques are adopted for video/audio communications. By selecting it, the network communications load of the camera can be reduced. If a router that does not correspond to the multicast or a firewall is installed between the camera and the computer, the video/audio may not play back properly. In that case, select **TCP** or **UDP (unicast)**.

### Notes

- The function may not operate correctly when you use personal firewall software or antivirus

software on your computer. In that case, disable the software or select the TCP mode.

- If you are using Windows XP Service Pack 2 or Windows Vista, disable “Windows Firewall.” For details, see “Configuring Windows Firewall” in “When using Windows XP Service Pack 2” on page 8 or “Configuring Windows Firewall” in “When using Windows Vista” on page 10.

#### 4 Click **Enter**.

The main viewer appears.

#### Display sample: SNC-DM160

##### With the ActiveX viewer (JPEG)



Control the camera from the main viewer.

## Displaying the Administrator menu directly

When the administrator sets the camera functions, the Administrator menu can be opened directly from the welcome page.

- 1 Select the viewer language on the welcome page. Click **English** or **Japanese** at the bottom of the welcome page.
- 2 Click **Setting** on the welcome page. The following dialog appears.



- 3 Enter the user name and password for Administrator, then click **OK**.

The user name “admin” and the password “admin” are set at the factory for the Administrator. You can change them using the User menu of the Administrator menu (see page 54).

The Administrator menu appears in other window.

#### Display sample: SNC-DM160

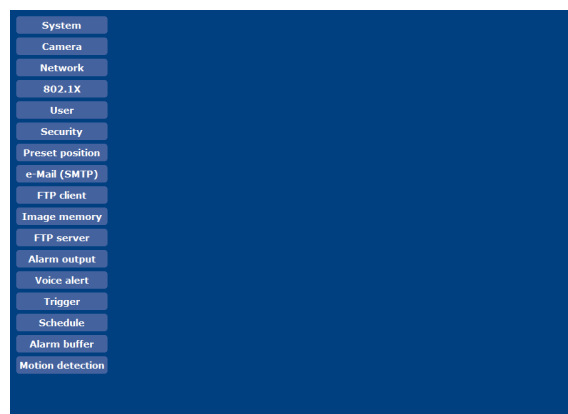

## About viewers

You can use the following viewers.

### ActiveX viewer

This viewer can monitor the camera image in the **JPEG** or **MPEG4** video codec.

You must install this viewer when you access the main viewer for the first time.

#### When you display the main viewer of the camera for the first time

When you log in the network camera using ActiveX viewer for the first time (by clicking **Enter** to enter the main viewer), the Security Warning appears. Click **Yes** and install ActiveX Control. You can use all the functions of the viewer with ActiveX Control.

### Java applet viewer

You can select this viewer when the camera image is in **JPEG**. The frame rate is lower than the ActiveX viewer. The Java applet viewer operates only when Java is installed and Java (Sun) is enabled. If it does not operate correctly, check whether the Java has been installed successfully and Java (Sun) is enabled.

When the Java applet viewer is displayed, the dialog about digital-signature identification is also displayed. Click **Run** to go on.

For the verified Java version, contact your authorized Sony dealer.

### To check the Java version

Select **Tools** from the menu bar of Internet Explorer, then select **Internet Options** and click the **Advanced mode** tab. Check the version of Java displayed in **Java (Sun)**. If **Java (Sun)** is not displayed, it means that Java is not installed. You need to install Java.

### To enable Java Plug-in

Example: In case of Java Plug-in Ver. 1.6.0\_01

Check “Use JRE 1.6.0\_01 for <applet> (requires restart)” in “Java (Sun)”.

### To install Java Plug-in

Download Java 2 Runtime Environment, Standard Edition (JRE) from the website of Sun Microsystems, Inc., and install it by following the instructions on the installer.

#### Notes

- If **Automatic configuration** is enabled in the Local Area Network (LAN) Settings of Internet Explorer, the camera image may not be displayed. In that case, disable **Automatic configuration** and set the Proxy server manually. For the setting of the Proxy server, consult your network administrator.
- When you install ActiveX Control, you should be logged in to the computer as the Administrator.

#### Tip

Every page of this software is optimized for display character size **Medium** for Internet Explorer.

## Configuration of Main Viewer

This section explains the functions of the parts and controls of the main viewer. For a detailed explanation on each part or control, see the specified pages.

### Display sample: SNC-DM160

#### Main viewer using ActiveX viewer (JPEG)

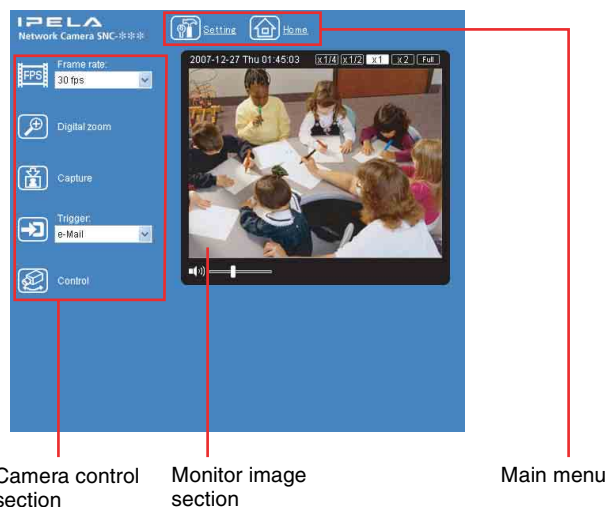

Camera control section

Monitor image section

Main menu

## Main menu



### Setting

Click to display the Administrator menu. (page 28)  
You can operate this function only when logging in as the administrator.



### Home

Displays the welcome page.

## Camera control section

### Frame rate



(Displayed only when the camera image is in JPEG.)

Selects the frame rate to transmit images. (page 21)



## Digital zoom

Click to change the size of the digital zoom. (page 22)



## Capture

(Displayed in the main menu when the Java applet viewer is used.)

Click to capture a still image shot by the camera and to store it in the computer. (page 22)

## Trigger



(Displayed only when the camera **Viewer mode** (page 55) is set to **Full** and one or more triggers are enabled in the Trigger menu (page 71).)

Select the function you want to use from the drop-down list and click . The selected function is activated. The selectable functions are as follows:

- send the still images attached to an e-mail (page 26)
- send the still images to an FTP server (page 26)
- record the still image files in the built-in memory (page 26)
- control the alarm output (page 26)
- switch the Day/Night function on/off (SNC-DM160 / DS60 / CM120 / CS20 only) (page 26)
- play the audio file stored in the camera (page 27)



## Control (SNC-DM110 / DM160 / CM120 only)

(Displayed only when the SolidPTZ function is On. (page 42))

Click to operate the camera using the pan, tilt and zoom functions.

Click to change this icon to , and you can operate pan/tilt/zoom on the monitor or control panel (page 23).

## Preset position (SNC-DM110 / DM160 / CM120 only)

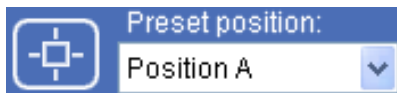

(Displayed only when the SolidPTZ function is On (page 42) and preset position of the camera is registered.)

Select the **Preset position** name from the drop-down list. The camera will move to the preset display range

that you have stored in memory using the Preset position menu.

## Monitor image section



### Monitor window

The image shot by the camera is shown here.

### View size

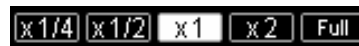

Selects the view size to be displayed. (page 22)

### Date and time

The date and time is displayed here.

### Volume



(Displayed when **Audio input** (page 35) is set to **On**.)

Drag the bar to adjust the volume.

When you click the icon changes to and the audio output stops.

To output the audio, click again.

### Note

If does not appear when the Java applet viewer is used, Audio encode may not be set to **G.711 (64 kbps)** (page 36), or Java may not be installed

correctly. To check if Java is installed correctly, refer to “Java applet viewer” of “About viewers” on page 18.

# Controlling the Monitor Image

You can monitor the camera image on the monitor window of the main viewer.

## Monitoring the camera image

- 1 Log in to the homepage to display the main viewer. To log in, see “Logging in as a user” on page 17.



- 2 Select the frame rate (only when the camera image is in **JPEG**).

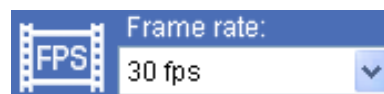

Click the **Frame rate** list box to select the frame rate for transmitting the image. Selectable frame rates are as follows.

1, 2, 3, 4, 5, 6, 8, 10, 15, 20, 25, 30 fps

“fps” is a unit indicating the number of frames transmitted per second.

For example, if you select **30 fps**, the image is sent at the maximum speed of the connected line (30 fps maximum).

### Note

The selected value indicates the maximum number of frame rate that can be transmitted.

The number of frames actually transmitted may vary depending on network environments and

camera settings (image size and image quality settings).

- 3 Select the view size.

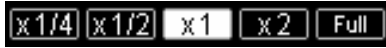

Select **x 1/4**, **x 1/2**, **x 1**, **x 2** or **Full** at the top of the image. The monitor is displayed by the view size as you selected.

The selected image size button flips.

**x 1:** Displayed in the selected image size selected on **Image size** in the camera menu (page 40).

**x 2:** Available only when the view size is 640 × 480 (VGA) size or less.

**Full:** A full image is displayed with one click.

When you return to the normal screen from the full image, right-click or click **ESC** on the keyboard.

#### Note

When the full image is displayed, you cannot operate pan/tilt/zoom with SolidPTZ function. (SNC-DM110 / DM160 / CM120 only)

## Zooming in the monitor image

- 1 Click . With the ActiveX viewer, a green frame indicates the range to be zoomed in.
- 2 Click the point you want to zoom in. The image is magnified about twice with the clicked point at the center.



The digital zoom icon changes to .

- 3 To cancel zooming in, click .

## Capturing a Monitor Image

You can capture an image being monitored as a still image and save it in the computer.

### Capturing a monitor image

- 1 Display the camera image in the monitor window.
- 2 Click . The still image of the moment you click is captured, and this still image is displayed in the capture window.

#### With the ActiveX viewer



#### With the Java applet viewer



- 3 To close the capture window, click **Cancel** or **Close**.

## Saving the captured image

### With the ActiveX viewer

- 1 Capture the monitor image.
- 2 Click **Save**.  
The **Save As** dialog appears.

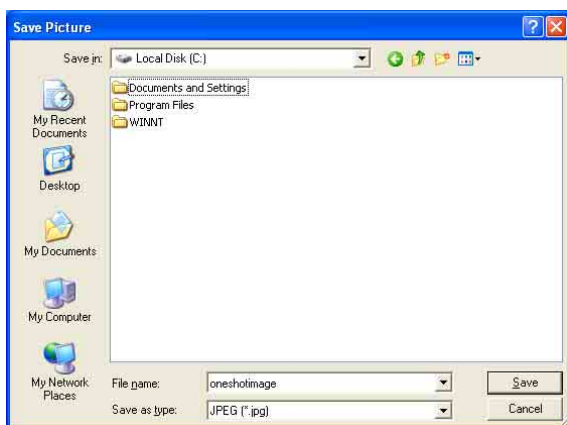

- 3 Select **JPEG** or **BITMAP** as **Save as type**.
- 4 Type the **File name** and specify **Save in**, then click **Save**.

### With the Java applet viewer

- 1 Capture the monitor image.
- 2 Right-click the mouse to display the menu and select **Save Picture As...**.  
The **Save Picture** dialog appears.

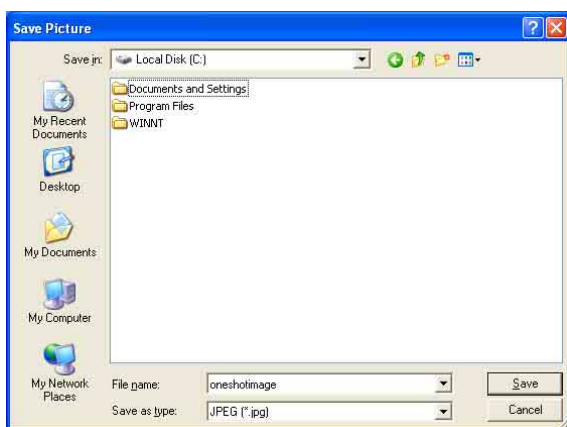

- 3 Select **JPEG** or **BITMAP** as **Save as type**.
- 4 Type in **File name** and specify **Save in**, then click **Save**.

## Operating the Camera Using SolidPTZ (SNC-DM110 / DM160 / CM120 only)

You can operate pan/tilt/zoom with the SolidPTZ function.

SolidPTZ reduces or crops an image shot in Quad-VGA (1280 × 960) while adjusting the image position and ratio. The pan/tilt/zoom effect is seen on the screen although the camera and lens do not actually move. This function helps in effectively monitoring the image range while saving the network bandwidth or the recording area.

### Notes

- When the SolidPTZ is disabled (page 42), you cannot operate pan/tilt/zoom or preset position.
- **Available pan-tilt range**  
This function is controlled by reducing and/or cropping an image shot in Quad-VGA size. If the image is zoomed to WIDE, you can get only a small pan-tilt range and pan/tilt does not work at the WIDE end.
- **Available zoom range**  
When an image is zoomed in to the TELE end, the image size is the same as the actual image shot in Quad-VGA (× 1). You cannot zoom an image beyond what it actually is.  
The image ratio when zoomed out to the WIDE end is different depending on the output image size set. (For example, when the VGA output image size is set, the image can be zoomed out to half.)

## Controlling via the control panel

You can operate pan, tilt and zoom by using the control panel for the monitor image currently displayed.

- 1 Click  to display , and the control panel. With another click of , the control panel is displayed again.

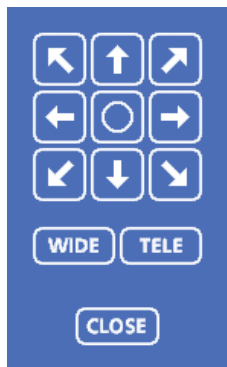

- 2** Control each function using the displayed control panel.



### Pan/Tilt control

Click the arrow button of the direction in which you want to move the camera. Keep it pressed to move the display area of the image continuously. To return to the home position, click . You can select the operation mode of the 8-direction arrow buttons for panning and tilting in PTZ mode of the System menu (page 31).

### Zoom control

Click **WIDE** to zoom out, and click **TELE** to zoom in. Zooming continues while the button remains pressed.

#### Note

When **Exclusive control mode** of the System menu is set to **On** and you click , the remaining time that you are authorized to operate the camera is displayed. If you cannot get the control, the icon switches to  and the waiting time is displayed.

## Panning and tilting by clicking the monitor image

Click on the monitor image, and the display area moves so that the clicked portion is positioned at the center of the display.

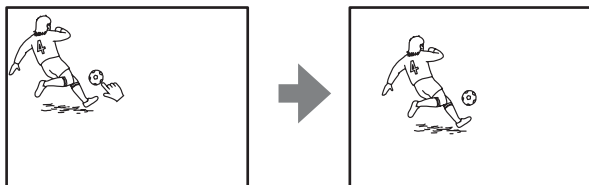

## Panning, tilting and zooming by specifying the area

Click and hold the left button of the mouse on the monitor image and drag the mouse diagonally to draw a

red frame around the portion you want to enlarge. The framed portion is positioned at the center of the display and is zoomed in.

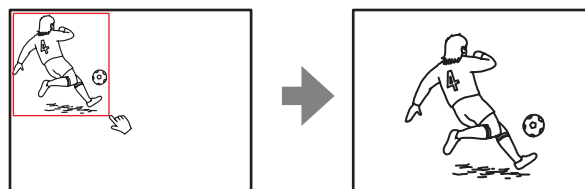



## Zooming an image by the camera zoom bar

When you have authorization to control this function, the zoom bar is displayed below the monitor window. You can specify a location to be zoomed by clicking the zoom bar.

The zoom bar is either displayed or turned off by clicking  below the bar.



 **WIDE end:** Click to move the zoom to WIDE end (same magnification).

 **TELE end:** Click to move the zoom to TELE end.

## Displaying the preset area of the image

Select a preset position name from the **Preset position** drop-down list. The display area that you have stored in memory is displayed using the Preset position menu (page 56). When you click this icon after the control panel moves the display area, the image previously selected from the preset position list box reappears.

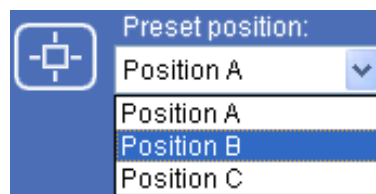

#### Note

The **Preset position** list box is not displayed when no preset position is memorized.



# Controlling the Camera on a Full Image (SNC-DM110 / DM160 / CM120 only)

When you have authorization to control the camera, the full image is displayed under the monitor window. The full image is a still image that shows the entire shooting range of the camera in reduced size. When you click on the full image, the clicked portion is displayed in the monitor window.



### Note

When the SolidPTZ is disabled (page 42), you cannot control the camera on a full image.

### To create a full image

Create a full image using **Capture full image** in the Initialize tab of the System menu.  
*For details, see page 34.*

### Tip

When the camera is moved or when the layout around the camera is changed, you should create the full image again.

# Displaying a specified point in the monitor window

1 Create a full image and display it.



2 Click the point you want to watch in the full image. The current image at the selected point is displayed in the monitor window. You can see a green frame on the full image. This indicates the image currently displayed in the motion window you are watching.



The current situation is displayed in the monitor window at the clicked point.

### To turn off the full image

When you click , the full image and the zoom bar disappear.

## Using the Trigger Button

You can operate various functions of the camera simply by clicking  (trigger) in the main viewer.

### Sending a monitor image via e-mail

You can send a captured still image by attaching it to an e-mail.

To use this function, you need to make **e-Mail (SMTP)** active and set the address in the Trigger menu of the Administrator menu properly (page 71).

- 1 Display the image on the monitor window.
- 2 Select **e-Mail** from the trigger drop-down list.

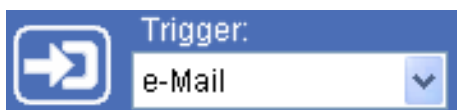



- 3 Click . The still image of the moment you click is captured, and your e-mail with the image file attached is sent to the specified mail address.

### Sending a monitor image to an FTP server

You can send a captured still image to the FTP server. To use this function, you need to make **FTP client** active and set the address in the Trigger menu of the Administrator menu properly (page 71).

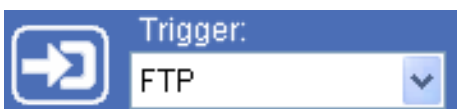
- 1 Display the image on the monitor window.
- 2 Select **FTP** from the trigger drop-down list.



- 3 Click . The still image of the moment you click is captured, and the image file is sent to the FTP server.

### Recording a camera image as a still image

You can capture a camera image as a still picture and record it in the built-in memory.

To use this function, you need to make **Image memory** active and set the details in the Trigger menu of the Administrator menu (page 71).

- 1 Display the image on the monitor window.
- 2 Select **Image memory** from the trigger drop-down list.

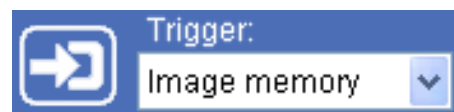

- 3 Click . The still image of the moment you click is captured, and the image file is recorded.

### Controlling alarm output 1, 2

You can control Alarm output 1, 2.

To use this function, you need to make **Alarm output 1** or **Alarm output 2** active in the Trigger menu of the Administrator menu (page 72).

- 1 Display the image on the monitor window.
- 2 Select **Alarm output1** or **Alarm output2** from the trigger drop-down list.

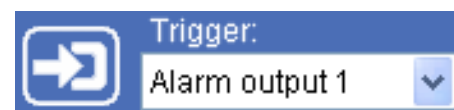

- 3 Click . The alarm output is switched by clicking. The alarm output mode can be selected from **Toggle** or **Timer** of **Alarm output 1, 2** in the Trigger menu (page 72).

#### Tip

For the connection of peripheral devices to the alarm output of the I/O port, see the supplied Installation Manual.

### Controlling Day/Night function (SNC-DM160 / DS60 / CM120 / CS20 only)

You can control the Day/Night function On (night mode) and Off (day mode).

To use this function, you need to make **Day/Night** active in the Trigger menu of the Administrator menu (page 72).

- 1 Display the image on the monitor window.

- 2 Select **Day/Night** from the trigger drop-down list.



- 3 Click . Each click switches the Day/Night function alternately between On (night mode) and Off (day mode).

**Note**

If **Day/Night mode** in the Trigger-Day/Night menu (page 72) is set to **Auto**, you cannot control the Day/Night function by clicking .

## Playing the audio file stored in the camera

You can play the audio file previously stored in the camera using the SNC audio upload tool. To use this function, you need to make **Voice alert1**, **Voice alert2** and **Voice alert3** active in the Trigger menu of the Administrator menu (page 72).

- 1 Display the image on the monitor window.
- 2 Select **Voice alert1**, **Voice alert2** or **Voice alert3** from the trigger drop-down list.

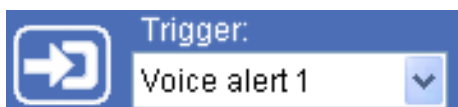

- 3 Click . Playback of the selected audio file starts and the playback sound is output from the speaker connected to the camera.

## Administering the Camera

The Administering the Camera section explains how to set the functions of the camera by the Administrator. For the monitoring of the camera image, see “Operating the Camera” on page 16.

This section explains the basic operations and each option of the Administrator menu.

### Note on the display of menu options

The setting menus of this unit will clearly display only the setting options that you can currently select. The grayed out options cannot be selected.

## Basic Operations of Administrator Menu

You can use the Administrator menu to set all functions to suit the user's needs.

Click **Setting** in the welcome page or  in the main viewer to display the Administrator menu.

### How to setup the Administrator menu

- 1 Log in the homepage to display the welcome page. You can learn how to log in on page 17 “Logging in as a user”.
- 2 Select the viewer language on the welcome page. Click **English** or **Japanese** at the bottom of the welcome page.
- 3 Click **Setting** on the welcome page. The authentication dialog appears. Enter the user name and password for Administrator. Administrator menu appears.

The user name “admin” and password “admin” are set at the factory for the Administrator.

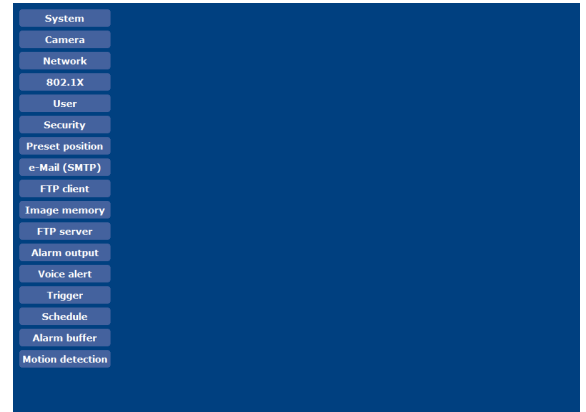

The following steps also display the Administrator menu.

- ① Click **Enter** in the welcome page to display the main viewer.
- ② Click  in the main viewer.
- ③ Enter the user name and password for Administrator.

- 4 Click the menu name (example: System) on the left side of the Administrator menu. The clicked menu appears.

Example: “System” menu



- 5 Select the required tab above the menu, and set each setting option in the tab.

Example: “Date & time” tab of “System” menu

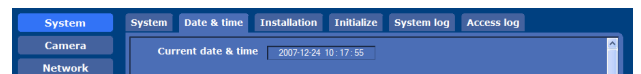

See pages 26 to 74 for details of the menu tabs and setting options.

- 6 After setting, click **OK**. The settings you have made become active.

Click **Cancel** to invalidate the set values and return to the previous settings.

### Buttons common to every menu

The following buttons are displayed on all the menus. The functions of the buttons are the same on every menu.



Click this button to validate the settings.

Cancel

Click this button to invalidate the set values and return to the previous settings.

## General notes on menus

- After changing a setting on a menu, wait at least 10 seconds before turning off the power of the camera. If the power is turned off immediately, the changed setting may not be stored correctly.
- When the camera settings are changed while watching the main viewer, some settings cannot be restored. To reflect the change on the opening main viewer, click **Refresh** of the web browser.

## Configuration of Administrator menu

### Display sample: SNC-DM160



### System

Displays the System menu. (“Configuring the System — System Menu” on page 30)

### Camera

Displays the Camera menu for setting the camera image and audio. (“Setting the Camera Image and Audio — Camera Menu” on page 35)

### Network

Displays the Network menu for setting the network connection. (“Configuring the Network — Network Menu” on page 46)

### 802.1X

Displays the 802.1X menu for connecting the camera to the network configured in compliance with the 802.1X standard for port authentication. (“Using the 802.1X Authentication Function — 802.1X Menu” on page 49)

### User

Displays the User menu for setting the log in user name and password. (“Setting the User — User Menu” on page 54)

### Security

Displays the Security menu for specifying a computer that is allowed to connect to the camera. (“Setting the Security — Security Menu” on page 55)

### Preset position (SNC-DM110 / DM160 / CM120 only)

Displays the Preset position menu to register a position you want to save. “Tour function”, which rotates the registered positions, is also set here. (“Saving the SolidPTZ Display Area and Action — Preset position Menu (SNC-DM110 / DM160 / CM120 only)” on page 56)

### e-Mail (SMTP)

Displays the e-Mail (SMTP) menu for sending an e-mail. (“Sending an Image via E-mail — e-Mail (SMTP) Menu” on page 59)

### FTP client

Displays the FTP client menu for sending an image/ audio file, etc. to an FTP server. (“Sending Images to FTP Server — FTP client Menu” on page 62)

### Image memory

Displays the Image memory menu for recording an image/audio file, etc. in the built-in memory. (“Recording Images in Memory — Image memory Menu” on page 65)

### FTP server

Displays the FTP server menu for setting the FTP server function of the camera. (“Downloading Images from the Camera — FTP server Menu” on page 68)

### Alarm output

Displays the Alarm output menu for setting the alarm out terminal of the camera. (“Setting the Alarm Output — Alarm output Menu” on page 69)

### Voice alert

Displays the Voice alert menu for playing the audio file stored in the camera in synchronization with alarm detection by the sensor input or the motion detection function. (“Outputting Audio Linked to Alarm Detection — Voice alert Menu” on page 70)

### Trigger

Displays the Trigger menu for operations when you click the trigger button in the main viewer. (“Setting the Operations from the Viewer — Trigger Menu” on page 71)

### Schedule

Displays the Schedule menu for the Sense up function, Preset position function, e-Mail (SMTP) function, FTP

client function, Image memory function and Alarm out function, Voice alert function and so on. (“Setting the Schedule — Schedule Menu” on page 73)

### Alarm buffer

Displays the Alarm buffer menu for the buffer that records the image and audio related to alarm detection. (“Setting the Alarm Buffer — Alarm buffer Menu” on page 74)

### Motion detection

Displays the Motion detection menu for the motion detection function built into the camera. (“Setting the Motion Detection Function — Motion detection Menu” on page 75)

# Configuring the System — System Menu

When you click **System** in the Administrator menu, the System menu appears.

Use this menu to perform the principal settings of the software.

The System menu has six tabs: **System**, **Date & time**, **Installation**, **Initialize**, **System log** and **Access log**.

## System Tab

Display sample: SNC-DM160

### Title bar name

Type a name of up to 32 characters to be displayed on the title bar. The characters typed here are displayed on the title bar of the Web browser.

### Welcome text

Type any text of up to 1024 characters in HTML format to show on the welcome page. Use the <BR> tag for a line break. (A line break is equivalent to 2 characters.)

### Serial number

The serial number of the camera is displayed.

### Software version

The software version of this camera is displayed.

### Homepage

Select the homepage to be displayed when you enter the camera IP address in your browser’s web address box.

**Default:** Displays the homepage stored in the camera.

**Custom:** Displays your individual homepage.

You can display your favorite homepage stored in the built-in flash memory.

To store the HTML file of the homepage in the built-in flash memory, use the Custom Homepage Installer included in the supplied CD-ROM.

To learn how to use of the Custom Homepage Installer, see page 89.

To display your individual homepage, perform the following operation:

- 1** Select **Custom**.
- 2** Type the path of the HTML file using up to 64 characters in the text box on the right of **Path**.

**Tip**

Even when you select **Custom**, the homepage inside the camera can be displayed by typing the following URL in the address box of your Web browser.

Example: When the IP address of the camera is set to 192.168.0.100

http://192.168.0.100/en/index.html

**Exclusive control mode (SNC-DM110 / DM160 / CM120 only)**

Controls the authority to operate pan, tilt, zoom and some other functions of the camera.

- On:** Only one user has control authority. Set the operation time for one user in **Operation time**. If a user tries to operate a function during operation by another user, the authority is controlled by the settings of **Operation time** and **Maximum wait number**.
- Off:** Multiple users can control pan, tilt and zoom at the same time. When multiple users control these functions at the same time, the last operation has priority.

**Operation time**

Sets the time length for a user who has control authority. The selectable range is from **10** to **600** seconds. This is effective when **Exclusive control mode** is **On**.

**Maximum wait number**

Sets the number of users who are permitted to wait for their turn for control authority during operation by one user. The selectable number is from **0** to **10**. This is effective when **Exclusive control mode** is **On**.

**Notes**

- To use **Exclusive control mode**, the date and time of the camera and the connected computer must be set correctly at first.
- To use **Exclusive control mode**, do not disable the web browser Cookie. When it is disabled, this mode cannot be used.
- When you change the **Exclusive control mode** setting, click **Refresh** on the web browser to reflect the change when opening the main viewer.

**PTZ mode (SNC-DM110 / DM160 / CM120 only)**

Select the pan/tilt control mode using the 8-direction arrow buttons (page 24) and the zoom control mode using the TELE/WIDE button (page 24).

Select **Normal** or **Step**.

**Normal:** When you click the mouse button, panning, tilting or zooming operation starts, and the operation continues while you hold down the mouse button. To stop the operation, release the mouse button.

**Step:** Each time you click the mouse button, the image moves (panning, tilting or zooming). If you keep the mouse button held down for more than 1 second, the operation mode is temporarily changed to **Normal**. When you release the mouse button, the image operation stops and the **Step** mode is restored.

When you select **Step**, **Pan/Tilt level** and **Zoom level** are selectable.

**Pan/Tilt level:** Select the image transition level from **1** to **10** by clicking the 8-direction arrow button for panning/tilting. Selecting **10** provides the maximum transition level.

**Zoom level:** Select the image transition level from **1** to **10** by clicking **WIDE** or **TELE** for zooming. Selecting **10** provides the maximum transition level.

**Sensor input mode**

Specify the detection mode of the signal input to the sensor input terminal of the camera.

**Normally open:** Detects alarm when the sensor input is short-circuited.

**Normally closed:** Detects alarm when the sensor input is open-circuited.

**OK/Cancel**

See “Buttons common to every menu” on page 28.

## Date & time Tab

### Current date & time

Displays the date and time set on the camera.

#### Note

After you have purchased the camera, be sure to check the date and time of the camera and set them if necessary.

### PC clock

Displays the date and time set on your computer.

### Date & time format

Select the format of date and time to be displayed in the main viewer from the drop-down list.

You can select the format between **yyyy-mm-dd hh:mm:ss** (year-month-day hour:minute:second), **mm-dd-yyyy hh:mm:ss** (month-day-year hour:minute:second), and **dd-mm-yyyy hh:mm:ss** (day-month-year hour:minute:second).

### Adjust

Select how to set the date and time.

**Keep current setting:** Select if you do not need to set the date and time.

**Synchronize with PC:** Select if you want to synchronize the camera's date and time with those of the computer.

**Manual setting:** Select if you want to set the camera's date and time manually.  
Select the year, month, date, hour, minute and second from each drop-down list.

**Synchronize with NTP:** Select if you want to synchronize the camera's date and time with those of the time server called NTP server (Network Time Protocol). Set the **NTP server name** and the **Interval**.

### NTP server name

Type the host name or IP address of the NTP server, using up to 64 characters.

### Interval

Select an interval between **1** and **24** hours at which you want to adjust the camera's time referring to the NTP server's time. The set interval is a guide, and does not indicate the exact time.

#### Note

The setting time may not match with the exact time according to the network environment.

### Time zone

Set the time difference from Greenwich Mean Time in the area where the camera is installed.

Select the time zone in the area where the camera is installed from the drop-down list.

### Automatically adjust clock for daylight saving time changes

When you select it, the clock is automatically adjusted according to the daylight saving time of the selected time zone.

#### Note

If the time zone selected in **Time zone** is different from that set on the computer, the time is adjusted using the time zone difference and set on the camera.

### Superimpose

Select whether to superimpose **camera ID** and/or **Date & time** on the image or not.

They are also superimposed on images recorded by the Pre-alarm or Post-alarm function.

### Camera ID

Checking this box allows you to superimpose the specified characters. Enter up to 20 characters.

### Date & time

Checking this box allows you to superimpose the date and time.

### Style

Select the style of the superimposed item between **Border** and **Background**.

### Position

Select the position of the superimposed item from among **Top-left**, **Top-right**, **Bottom-left** and **Bottom-right**



## Notes

- When you superimpose the image, the image frame rate may be reduced.
- The size of the superimposed characters is reduced if the image size is set to less than **640 × 480 (VGA)** or less.
- When you have changed the **Date & Time** setting, click **Refresh** of the Web browser to reflect the change on the opening main viewer.
- Enter alphanumeric characters, - (hyphen), / (slash), \_ (under score), : (colon) and a space for the camera ID.
- When the image size is set to **JPEG - 1280 × 960 (Quad-VGA) : MPEG4 - OFF : JPEG cropping available** (page 40), you cannot set superimpose.

## OK/Cancel

See “Buttons common to every menu” on page 28.

## Installation Tab

You can perform the settings related on the installation.

### Display sample: SNC-DM160

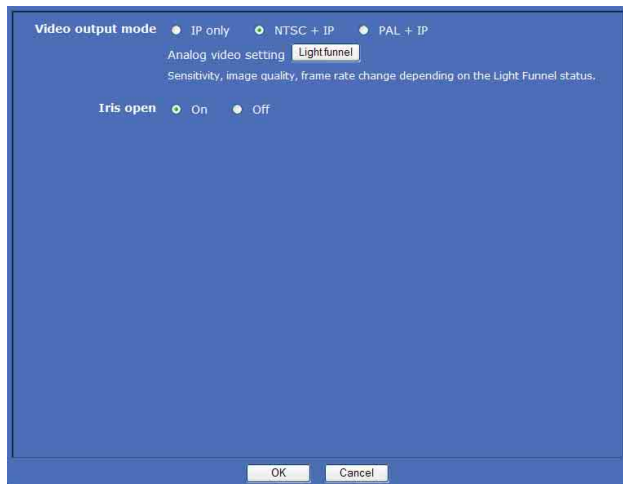

## Video output mode

You can set the output signal from the analog video output connector of the camera.

**IP only:** Outputs via network only.

**NTSC + IP:** Outputs with NTSC signal system.

The image setting output from the network is limited. When this mode is selected, **Analog video setting** is enabled and set. (SNC-DM110 / DM160 / CM120 only)

**PAL + IP:** Outputs with PAL signal system. The image setting output from the network is limited. When this mode is selected, **Analog video setting** is enabled and set. (SNC-DM110 / DM160 / CM120 only)

## Note

When **Video output mode** is **NTSC + IP** or **PAL + IP**, the setting items for the image output from the network are limited. For details, see **Video codec** tab. (page 40)

## Tip

**Video output mode** can be changed by the switch on the camera. For details, refer to the supplied Installation Manual.

### Analog video setting (SNC-DM110 / DM160 / CM120 only)

You can set about the analog output image. When you switch the status of Light funnel function, the sensitivity, image quality and frame rate of the analog output image are changed.

When you click **Light funnel**, the Light funnel mode setting menu is displayed.

### Display sample: SNC-DM160

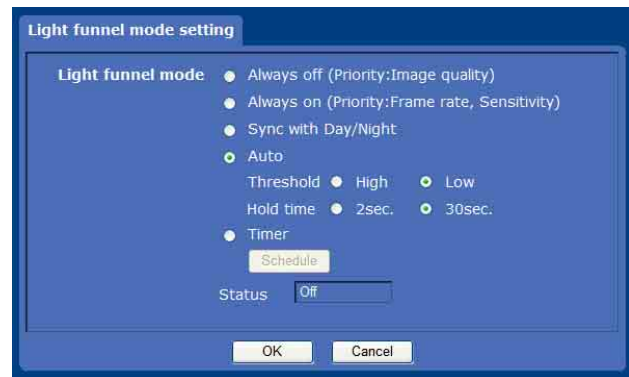

When the image quality has priority, select **Always off (Priority: Image quality)**. When the frame rate and sense have priority, select **Always on (Priority: Frame rate, sensitivity)**. For other items or settings, see **Sense up** tab of “Camera menu” (page 38).

## Note

The Light funnel setting is applied for the image output from the network.

## Iris open

You can open the iris of the auto iris lens for focus adjustment.

**On:** Opens iris.

**Off:** Without iris open.

When you set Iris open to On, the focus assist indicator appears to show the degree of focus adjustment.

When **Video output mode** is **NTSC + IP** or **PAL + IP**, the focus assist indicator appears on the image output from the analog video output connector. When **Video output mode** is **IP only**, the focus assist indicator appears on the image output from the network.

## Tips

- You can switch **Iris open** on the camera switch. For details, refer to the supplied Installation Manual.
- For using the focus assist indicator, refer to the supplied Installation Manual.
- When you reboot the camera, **Iris open** will automatically switched to **Off**.

## OK/Cancel

See “Buttons common to every menu” on page 28.

## Initialize Tab

### Display sample: SNC-DM160

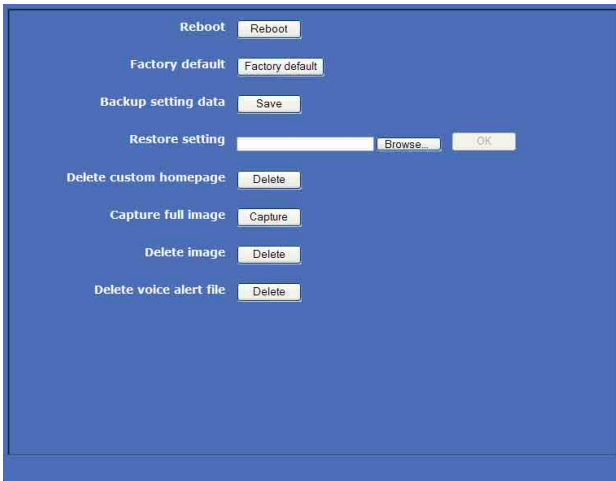

## Reboot

Reboots the camera.

Click **Reboot**, and the message “This Camera will be rebooted. Are you sure?” appears. Click **OK** to reboot the camera. It takes about two minutes to start again.

## Factory default

Resets the camera to the factory settings.

Click **Factory default**, and the message “Setup data will be initialized. Are you sure?” appears. When you click **OK**, the network indicator on the camera starts to blink. After adjustments of the default settings have finished, the camera reboots automatically. Do not turn off the camera until the camera reboots.

## Tip

The camera can also be reset to the factory settings by turning on the power of this unit while pressing the reset switch on the camera. For details, refer to the supplied Installation Manual.

## Backup setting data

Saves the setting data of the camera in a file.

Click **Save**, and follow the instructions on the Web browser to specify the folder and save the setting data of the camera.

The file name preset at the factory is as follows:

SNC-DM110: snc-dm110.cfg  
SNC-DS10: snc-ds10.cfg  
SNC-DM160: snc-dm160.cfg  
SNC-DS60: snc-ds60.cfg  
SNC-CM120: snc-cm120.cfg  
SNC-CS20: snc-cs20.cfg

## Restore setting

Loads the stored setting data of the camera.

Click **Browse** and select the file in which the setting data is stored. Then, click **OK**, and the camera is adjusted according to the loaded data and restarted.

## Notes

- With **Restore setting**, some items in the Network menu (page 46) cannot be restored.
- The following items cannot be stored or restored with **Backup setting data** or **Restore setting**.
  - audio files uploaded using SNC audio upload tool
  - a full image recorded in the camera (SNC-DM110 / DM160 / CM120 only)
  - a homepage created using Custom Homepage Installer
  - a client certificate and CA certificate to be used in the 802.1X authentication function

## Delete custom homepage

By pressing **Delete**, you can delete the homepage recorded in the flash memory of the camera with Custom Homepage Installer (page 89).

## Capture full image (SNC-DM110 / DM160 / CM120 only)

When you click **Capture**, a full image covering the entire shooting range is shot and saved to the camera. The full image is captured regardless of the image size and crop settings.

## Note

Main viewer image may be interrupted or image and/or audio files may not be created correctly during image capturing.

## Delete image (SNC-DM110 / DM160 / CM120 only)

By pressing **Delete**, you can delete the full image recorded in the camera.

## Delete voice alert file

Click **Delete** to delete all the audio files stored in the camera using SNC audio upload tool (page 80).

### Notes

- Clicking **Delete** deletes all the stored audio files simultaneously. To delete a specified audio file only, perform deletion of the audio file in the corresponding Voice alert tab of the Voice alert menu (page 70).
- Before deleting the audio file, set **Voice alert** to **Off** in each tab of the Voice alert menu (page 70).

## System log Tab



The data of the software activity of the camera is recorded in this log. It includes data that is useful when a problem occurs. Click **Reload** to reload the latest data.

## Access log Tab



The access record of the camera is displayed. Click **Reload** to reload the latest data.

# Setting the Camera Image and Audio

## — Camera Menu

When you click **Camera** in the Administrator menu, the Camera menu appears.

Use this menu to set the functions of the camera. The Camera menu consists of the following tabs: SNC-DM110 / DM160 / DS60 / CM120 / CS20: **Common, Picture, Sense up, Video codec, Streaming** SNC-DS10: **Common, Picture, Video codec, Streaming**

## Common Tab

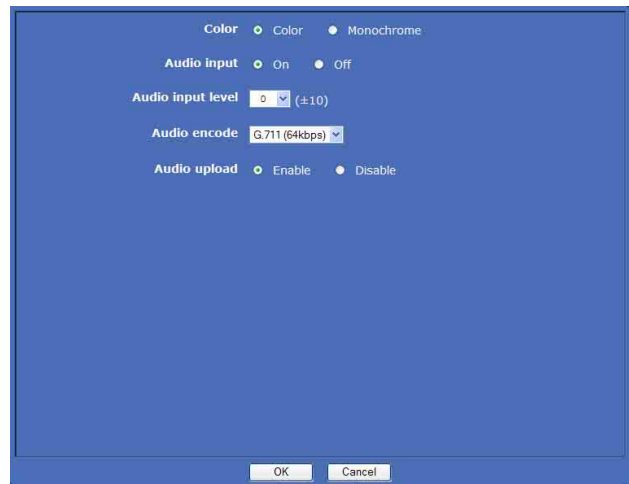

### Color

Select **Color** or **Monochrome** for the image.

### Audio input

Select whether you are going to send the audio from the AUDIO connector. Select **On** to send the audio from this network camera.

### Note

When you change the **Audio input** setting, click **Refresh** on the Web browser to reflect the change when opening the main viewer.

### Audio input level

Set the volume level of the audio input from the AUDIO connector. It is adjustable from **-10** to **+10**.

## Note

You cannot change the audio input level when you select LINE with the AUDIO IN selector on the camera.

## Audio encode

Select the bit rate when you send the audio from the AUDIO connector. **G.711 (64kbps)**, **G.726 (40kbps)**, **G.726 (32kbps)**, **G.726 (24kbps)** or **G.726 (16kbps)** can be selected.

## Note

If the bit rate is set to other than **G.711(64kbps)**, no audio is output when you use the Java applet viewer.

## Audio upload

Using the SNC audio upload tool stored in the supplied CD-ROM, you can output the audio that is input to the computer's audio input terminal from the speaker connected to the line output jack of the camera. Select **Enable** to output the audio from the speaker.

## OK/Cancel

See "Buttons common to every menu" on page 28.

## Picture Tab

You can set the color condition, exposure, etc. of the camera.

### Display sample: SNC-CM120

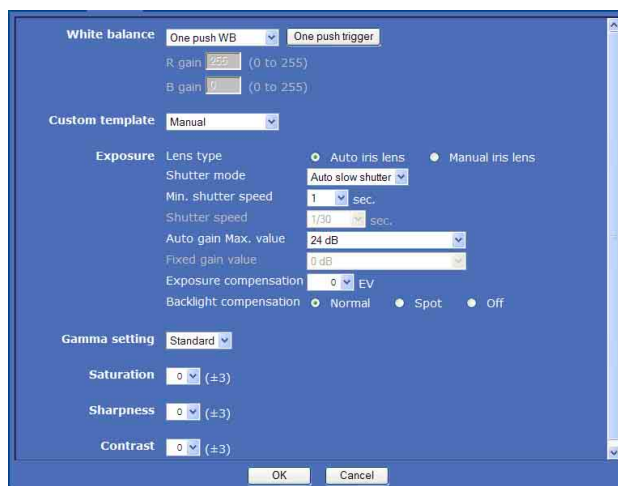

## White balance

Select the white balance mode.

**ATW:** Automatically adjusts to re-create the original color, as this mode is unsusceptible to lighting conditions. (approximately 2000 K to 10000 K)

**ATW-PRO:** Automatically adjusts the color to be closest to the image you are viewing. (approximately 3000 K to 7500 K)

**Tungsten bulb:** Adjust the white balance for shooting indoors under the tungsten bulb. (approximately 3200 K)

**Daylight:** Adjusts the white balance for shooting outdoors in daylight. (approximately 5800 K)

**Fluorescent lamp:** Adjust the white balance for shooting indoors under a three-band daylight fluorescent lamp.

**Mercury lamp:** Adjusts the white balance for shooting under a high-pressure mercury lamp.

**One push WB:** The **One push trigger** button becomes active. Click the button to adjust the white balance instantly.

**Manual:** When this option is selected, **R gain** and **B gain** become active. Selectable gain values are from 0 to 255.

## Custom template

When you select a custom template, **Exposure compensation**, **Backlight compensation** and **Gamma setting** are set optimally depending on shooting situations.

You can select the following situations: **Manual**, **Entrance**, **Office**, **Platform (Indoor)**, **Platform (Outdoor)**, **Basement car park**, **Multistory car park**. When you select **Manual**, **Exposure compensation**, **Backlight compensation** and **Gamma setting** are set to the user set values.

## Notes

- When you select a custom template, **Shutter mode** is automatically set to the following modes:
  - Auto Slow shutter:** On SNC-DM110 / DS10 / DM160 / DS60, or when **Lens type** is **Auto iris lens** on SNC-CM120 / CS20.
  - Auto (Slow shutter on):** When **Lens type** is **Manual iris lens** on SNC-CM120 / CS20.
- When **Shutter mode**, **Exposure compensation**, **Backlight compensation** or **Gamma setting** is changed, the custom template turns back to **Manual** automatically.

## Exposure

You can set the exposure.

### Lens type (SNC-CM120 / CS20 only)

Select the lens, **Auto iris lens** or **Manual iris lens**. **Shutter mode** items change depending on the selected lens. For details, see **Shutter mode**.

**Auto iris lens:** Select when the auto iris lens is installed.  
**Manual iris lens:** Select when the fixed iris lens is installed.

**Note**

If **Manual iris lens** is selected in **Lens type** when the auto iris lens is installed, the iris on the lens becomes fully open. Even if you select **Auto iris lens** in **Lens type** when the fixed iris lens is installed, auto exposure adjustment is not performed as long as the fixed iris lens is installed.

**Shutter mode**

Select the type of shutter speed control. The selectable items depend on the **Lens type** setting.

**With SNC-DM110 / DS10 / DM160 / DS60 or when Lens type is Auto iris lens on SNC-CM120 / CS20**

**Auto slow shutter:** The camera sets the exposure by the auto iris lens and auto gain adjustment. Auto exposure setting including the long exposure mode is performed according to the lighting conditions. When this option is selected, **Min. shutter speed**, **Auto gain Max. value**, **Exposure compensation** and **Backlight compensation** become active. The adjustable shutter speeds are from the **Min. shutter speed** value to 1/30 second.

**Manual:** The camera fixes the shutter speed and performs auto exposure setting by the auto iris lens and auto gain adjustment. When this option is selected, **Shutter speed** becomes active.

**Flickerless:** You can select this option when the image flickers due to a fluorescent lighting. When this option is selected, the flicker is reduced by fixing the shutter speed to 1/50 second. The camera sets the exposure by the auto iris lens and auto gain adjustment.

**When Lens type is Manual iris lens on SNC-CM120 / CS20**

**Auto (Slow shutter on):** The camera sets the exposure by auto shutter speed adjustment and auto gain adjustment. Auto exposure setting including the long exposure mode is performed according to the lighting conditions.

When this option is selected, **Min. shutter speed**, **Auto gain Max. value**, **Exposure compensation** and **Backlight compensation** become active. The adjustable shutter speeds are from **Min. shutter speed** value to 1/10000 second.

**Auto (Slow shutter off):** The camera sets the exposure by auto shutter speed adjustment and auto gain adjustment. The long exposure is not performed even if the lighting condition changes. The adjustable shutter speeds are from 1/30 second. to 1/10000 second.

**Manual:** The camera fixes the shutter speed and performs the auto exposure setting by auto gain adjustment.

When this option is selected, **Shutter speed** becomes active.

**Flickerless:** You can select this option when the image flickers due to fluorescent lighting. When this option is selected, the flicker is reduced by fixing the shutter speed to 1/50 second. Auto exposure setting is performed by auto gain adjustment.

**Min. shutter speed**

Select the minimum value of the auto slow shutter from the drop-down list. Selectable shutter speeds are 1, 1/2, 1/4, 1/8 and 1/15 second.

**Shutter speed**

Select the shutter speed of the camera from the drop-down list.

Selectable shutter speeds are 1, 1/2, 1/4, 1/8, 1/15, 1/30, 1/50, 1/60, 1/100, 1/250, 1/500, 1/1000, 1/2000, 1/4000 and 1/10000 second.

When you select 1, 1/2, 1/4, 1/8 and 1/15, **Fixed gain value** becomes active.

When you select 1/30, 1/50, 1/60, 1/100, 1/250, 1/500, 1/1000, 1/2000, 1/4000 and 1/10000, **Auto gain Max. value**, **Exposure compensation** and **Backlight compensation** become active.

**Auto gain Max. value**

Select the maximum gain value for auto exposure setting from the drop-down list.

**With SNC-DM110 / DM160 / CM120**

You can select from **0 dB, 6 dB, 12 dB, 18 dB, 24 dB, 30 dB (Light funnel on : 30 dB)** and **30 dB (Light funnel on : 36 dB)**. When you select **0 dB**, gain up is not performed.

For the Light funnel function, see **Sense up** tab on page 38.

**With SNC-DS10 / DS60 / CS20**

You can select from **0 dB, 6 dB, 12 dB, 18 dB, 24 dB, 30 dB** and **36 dB**. When you select **0 dB**, gain up is not performed.

**Fixed gain value**

Select the fixed gain value from the drop-down list.

**With SNC-DM110 / DM160 / CM120**

Select the fixed gain value from the drop-down list. You can select from **0 dB, 6 dB, 12 dB, 18 dB, 24 dB, 30 dB (Light funnel on : 30 dB)** and **30 dB (Light funnel on : 36 dB)**. When you select **0 dB**, gain up is not performed.

For the Light funnel function, see **Sense up** tab on page 38.

### With SNC-DS10 / DS60 / CS20

You can select from **0 dB, 6 dB, 12 dB, 18 dB, 24 dB, 30 dB** and **36 dB**. When you select **0 dB**, gain up is not performed.

### Exposure compensation

Select the exposure compensation value from the drop-down list and adjust the brightness of auto exposure setting. It is brighter when a larger value is selected, and it is darker when a smaller value is selected. Selectable values are as follows:

+3.0, +2.6, +2.3, +2.0, +1.6, +1.3, +1.0, +0.6, +0.3, 0, -0.3, -0.6, -1.0, -1.3, -1.6, -2.0, -2.3, -2.6, -3.0 (EV)

### Backlight compensation

Select the backlight compensation.

**Normal:** The camera judges the backlight situations on the whole image. If the image is under backlight situation, the camera compensates the exposure automatically for a brighter image. Select this option when the image is under backlight situation.

**Spot:** The camera judges the backlight situations in the center of the image. If the image is under backlight situation, the camera compensates the exposure automatically. For a brighter image Select this option when the center of the image is especially monitored.

**Off:** The camera does not perform the exposure setting according to the backlight situations.

#### Note

When you set **Normal** or **Spot** in the backlight compensation, hunting may be generated depending on the situations. In this case, set it to **Off**.

### Gamma setting

Select the gamma curve in the camera from the following seven options according to the subject and shooting conditions.

**Standard:** This setting is suitable for many shooting conditions.

**Scene 1:** This setting allows shooting without losing details in dark and bright portions when shooting subjects with a strong brightness contrast simultaneously such as shadow and sunlight parts.

**Scene 2:** This setting has a better effect than Scene 1.

**Scene 3:** This setting allows shooting a dark subject brighter when shooting subjects with a strong brightness contrast simultaneously such as shadow and sunlight parts.

**Scene 4:** Gamma compensation is not performed with this setting. It is suitable for adding image processing to the shot image.

**Scene 5:** This setting prevents white-out of a bright subject.

**Scene 6:** This setting is suitable for using a display system having gamma value 1.8.

### Saturation

Select the saturation in 7 steps, from **-3** to **+3**. Selecting **+3** provides the image with the highest saturation.

### Sharpness

Select the sharpness in 7 steps, from **-3** to **+3**. Selecting **+3** provides the image with the highest sharpness.

### Contrast

Select the contrast in 7 steps, from **-3** to **+3**. Selecting **+3** provides the image with the highest contrast.

### OK/Cancel

See “Buttons common to every menu” on page 28.

## Sense up Tab (SNC-DM110 / DM160 / DS60 / CM120 / CS20 only)

Use this tab to set the Sense up function of the camera.

### Display sample: SNC-DM160

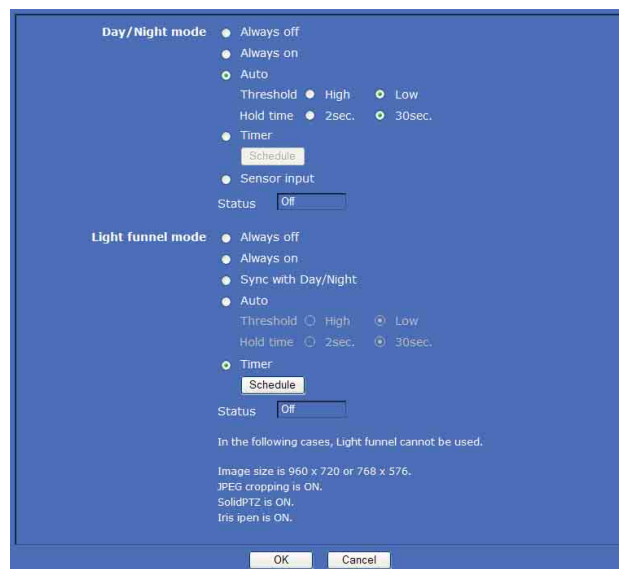

### Day/Night mode (SNC-DM160 / DS60 / CM120 / CS20 only)

Select the day/night mode from among five modes.

**Always off:** Always works in day mode.

**Always on:** Always works in night mode.

**Auto:** Normally works in day mode. It switches automatically to night mode in a dark place.

Switching timing can be set with the following parameters.

### Threshold

Select **High** or **Low** for the brightness to switch the night mode.

### Hold time

Select **2sec.** or **30sec.** for the response time to switch to the brightness level.

**Timer:** Normally the camera works in day mode. It switches to night mode at the time that you have you set in the Schedule menu.

Click **Schedule** and the setting menu for the effective period is displayed. (“Setting the Schedule — Schedule Menu” on page 73)

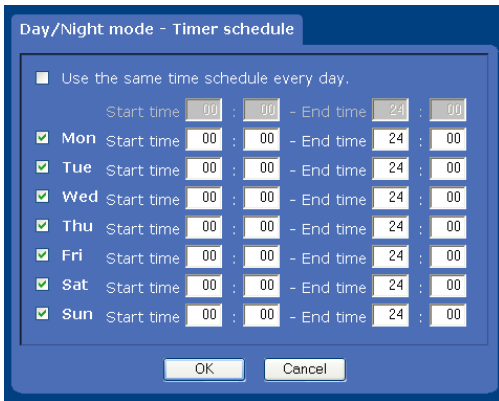

**Sensor input:** Controls the day/night mode by synchronizing it with the sensor input.

### Status

Shows the current status of day/night function.

**On:** The camera works in night mode.

**Off:** The camera works in day mode.

### Note

When you set **Auto** in **Day/Night mode**, the following phenomenon may occur.

- When **Exposure** in **Picture Tab** is set as follows, the camera does not switch to night mode.
  - **Shutter mode** is **Manual** and **Shutter speed** is 1/15 second or less.
  - **Shutter mode** is **Manual**, **Shutter speed** is 1/30 second or more and **Auto gain Max.value** is **18 dB** or less.
  - **Shutter mode** is other than **Manual** and **Auto gain Max.value** is **18 dB** or less.
- When the camera switches to night mode, hunting may occur depending on the conditions. In this case, use **Timer** mode to set the time to switch, **Sensor input** mode to switch according to the lighting or **Always on** and **Always off** mode to switch day/night mode.
- When **Light funnel mode** is set to **Auto**, the camera first switches automatically to night mode in dark conditions, and then switches to Light funnel on if it gets darker. The camera first switches to Light funnel

off in light conditions, and then switches to day mode if it gets lighter. (SNC-DM160 / CM120 only)

- When the camera switches Light funnel off by the Schedule menu setting in **Timer**, or **Light funnel mode** switches from **Always on** to **Always off** during day mode, the camera may switch to night mode for a while and then return to day mode immediately. (SNC-DM160 / CM120 only)
- When the camera switches Light funnel on by the Schedule menu setting in **Timer**, or **Light funnel mode** switches from **Always off** to **Always on** during night mode, the camera may switch to day mode for a while and then return to night mode immediately. (SNC-DM160 / CM120 only)

### Light funnel mode (SNC-DM110 / DM160 / CM120 only)

Light funnel increases the image sensitivity by combining the charge from adjacent pixels in a CCD. In this camera, one pixel is produced by a combined charge equivalent to 2 × 2 pixels on the 1280 × 960 image. This effect results in a low resolution but the high sensitivity. The mode combining a summed charge is “Light funnel on”, and the mode without combined charge is “Light funnel off”.

### Notes

- Light funnel does not work when the followings are set:
  - The image size is **JPEG - 960 × 720 : MPEG4 - OFF** or **JPEG - 768 × 576 : MPEG4 - OFF**.
  - JPEG cropping is On.
  - SolidPTZ is On.
  - Iris open is On.
- You may feel the image resolution is reduced when the Light funnel is On.
- The image file may not be created correctly during switching the Light funnel modes.

Light funnel function has the following six modes:

**Always off:** Always works in Light funnel off.

**Always on:** Always works in Light funnel on.

**Sync with Day/Night (SNC-DM160 / CM120 only):**

Switches Light funnel mode linked with the switch of day/night. This option sets Light funnel off in day mode, and Light funnel on in night mode.

**Auto:** Normally works in Light funnel off. It switches automatically to Light funnel on in a dark place.

Switching timing can be set with the following parameters.

### Threshold

Select **High** or **Low** for the brightness to switch the Light funnel on.

### Hold time

Select **2sec.** or **30sec.** for the response time to switch to the brightness level.

**Timer:** Set the Light funnel on/off using the timer.

When the time set in **Timer schedule** menu comes, the camera switches to Light funnel on. The camera works in Light funnel off in the other settings.

Click **Schedule**, and the setting menu for the effective period is displayed.

See “Setting the Schedule — Schedule Menu” on page 73.

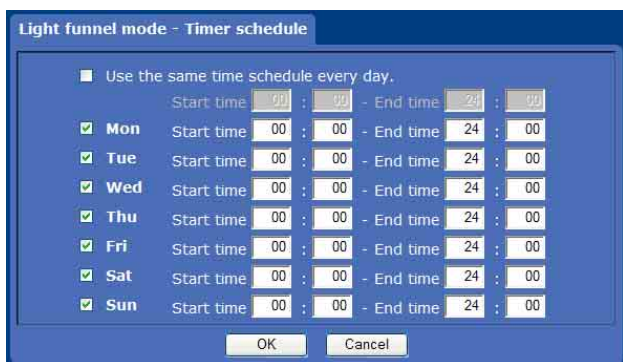

### Status

Shows the current status of Light funnel function.

**On:** The camera works on Light funnel on.

**Off:** The camera works on Light funnel off.

### Notes

When you set **Auto** in **Light funnel mode**, the following phenomenon may occur.

- When **Exposure** in **Picture Tab** is set as follows, the camera does not switch to Light funnel on.
  - **Shutter mode** is **Manual** and **Shutter speed** is 1/15 second or less.
  - **Shutter mode** is **Manual**, **Shutter speed** is 1/30 second or more and **Auto gain Max.value** is 18 dB or less.
  - **Shutter mode** is other than **Manual** and **Auto gain Max.value** is 18 dB or less.
- When the camera switches to Light funnel on, hunting may occur depending on the conditions. In this case, use **Timer** mode to set the time to switch, **Sensor input** mode to switch according to the lighting or **Always on** and **Always off** mode to switch the Light funnel mode.
- When **Day/Night mode** is set to **Auto**, the camera switches to night mode in dark conditions, and then switches to Light funnel off if it gets darker. The camera first switches to Light funnel off in light conditions, and then switches to day mode if it gets lighter. (SNC-DM160 / CM120 only)
- When **Day/Night mode** is set to **Timer** or **Sensor input**, the camera switches to Light funnel on as long as the night mode is set. Set the night mode with

**Schedule**, **Sensor input** or **Trigger** (page 26) menu. If the camera switches to day mode by these settings during Light funnel on, the camera switches automatically to Light funnel off regardless of the amount of light. (SNC-DM160 / CM120 only)

- When the camera switches to night mode by trigger settings, or switches from **Always off** to **Always on** in **Day/Night mode** during Light funnel on, the camera may switch to Light funnel off for a while and then return to Light funnel on immediately according to the lighting. (SNC-DM160 / CM120 only)
- When the camera switches from **Always on** to **Always off** in **Day/Night mode** during Light funnel off, or switches to day mode by trigger settings, the camera may switch to Light funnel on for a while and then return to Light funnel off immediately according to the lighting. (SNC-DM160 / CM120 only)

### OK/Cancel

See “Buttons common to every menu” on page 28.

## Video codec Tab

Use this tab to set the items for the video codec.

### Display sample: SNC-DM160

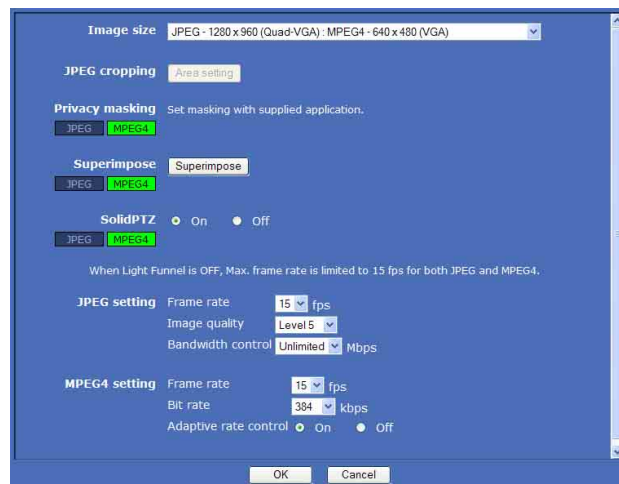

### With SNC-DM110 / DM160 / CM120

#### Image size

Select the image size output from the camera and the JPEG image cropping using the following setting:

- JPEG - 1280 × 960 (Quad-VGA) : MPEG4 - OFF : JPEG cropping available
- JPEG - 1280 × 960 (Quad-VGA) : MPEG4 - OFF
- JPEG - 1280 × 960 (Quad-VGA) : MPEG4 - 640 × 480 (VGA)
- JPEG - 1280 × 960 (Quad-VGA) : MPEG4 - 384 × 288



- JPEG - 1280 × 960 (Quad-VGA) : MPEG4 - 320 × 240 (QVGA)
- JPEG - 960 × 720 : MPEG4 - OFF
- JPEG - 768 × 576 : MPEG4 - OFF
- JPEG - 640 × 480 (VGA): MPEG4 - 640 × 480 (VGA)
- JPEG - 384 × 288 : MPEG4 - 384 × 288
- JPEG - 320 × 240 (QVGA) : MPEG4 - 320 × 240 (QVGA)

### Notes

- JPEG image cropping becomes active only when JPEG output size is 1280 × 960 (Quad-VGA) and MPEG4 is OFF.
- Superimpose works only when JPEG image cropping is Off. When the image size is **JPEG - 1280 × 960 (Quad-VGA) : MPEG4 - OFF : JPEG image cropping available** (page 40), you cannot set the superimpose.
- Light funnel does not work when the followings are set:
  - Image size is **JPEG - 960 × 720 : MPEG4 - OFF** or **JPEG - 768 × 576 : MPEG4 - OFF**.
  - JPEG image cropping is On (With **JPEG - 1280 × 960 (Quad-VGA) : MPEG4 - OFF : JPEG cropping available**)
  - SolidPTZ is On.
  - Iris open is On.
- When the JPEG output image size is set to 1280 × 960 (Quad-VGA), the output image changes to 640 × 480 (VGA) regardless of the setting during Light funnel on.
- When Light funnel is off, the maximum frame rate is 15 (fps). If you set a value more than 15 (fps), the image is output by 15 (fps).
- When **Video output mode** (page 33) is set to **NTSC + IP** or **PAL + IP**, or **Iris open is On** (page 33), cropping, superimpose, privacy masking and SolidPTZ are disabled regardless of the settings.



- When **Video output mode** (page 33) is set to **NTSC + IP**, or **PAL + IP** and **Iris open** is **Off** (page 33), the output image size is fixed as follows regardless of settings:

Light funnel mode	JPEG	MPEG4
Light funnel on	640 × 480 (VGA)	640 × 480 (VGA)
Light funnel off	1280 × 960 (Quad-VGA)	Off

- When **Iris open** is set to **On**, the output image size is fixed at **JPEG - 1280 × 960 (Quad-VGA) : MPEG4 - OFF** and Light funnel off regardless of settings.
- According to the output image size setting, superimpose, privacy masking and SolidPTZ have codec requirements. For details, refer to the following table.

	SolidPTZ		Superimpose		Privacy masking	
	JPEG	MPEG4	JPEG	MPEG4	JPEG	MPEG4
JPEG - 1280 × 960 (Quad-VGA) : MPEG4 - OFF : JPEG cropping available	–	–	–	–	●	–
JPEG - 1280 × 960 (Quad-VGA) : MPEG4 - OFF	–	–	●	–	●	–
JPEG - 1280 × 960 (Quad-VGA) : MPEG4 - 640 × 480 (VGA)	–	●	–	●	–	●
JPEG - 1280 × 960 (Quad-VGA) : MPEG4 - 384 × 288	–	●	–	●	–	●
JPEG - 1280 × 960 (Quad-VGA) : MPEG4 - 320 × 240 (QVGA)	–	●	–	●	–	●
JPEG - 960 × 720 : MPEG4 - OFF	●	–	●	–	●	–
JPEG - 768 × 576 : MPEG4 - OFF	●	–	●	–	●	–
JPEG - 640 × 480 (VGA) : MPEG4 - 640 × 480 (VGA)	●	●	●	●	●	●
JPEG - 384 × 288 : MPEG4 - 384 × 288	●	●	●	●	●	●
JPEG - 320 × 240 (QVGA) : MPEG4 - 320 × 240 (QVGA)	●	●	●	●	●	●

● Usable – Not usable

## With SNC-DS10 / DS60 / CS20

### Image size

Select the image size output from the camera with the following setting:

- JPEG - 768 × 576 : MPEG4 - 640 × 480 (VGA)
- JPEG - 640 × 480 (VGA) : MPEG4 - 640 × 480 (VGA)
- JPEG - 640 × 480 (VGA) : MPEG4 - 384 × 288
- JPEG - 640 × 480 (VGA) : MPEG4 - 320 × 240 (QVGA)
- JPEG - 384 × 288 : MPEG4 - 640 × 480 (VGA)
- JPEG - 320 × 240 (QVGA) : MPEG4 - 640 × 480 (VGA)
- JPEG - 384 × 288 : MPEG4 - 384 × 288
- JPEG - 320 × 240 (QVGA) : MPEG4 - 320 × 240 (QVGA)

## Notes

- JPEG - 768 × 576 is configured by zooming in a JPEG - 640 × 480 (VGA) image. You may have the impression that the image resolution is reduced.
- **Video output mode** (page 33) is set to **NTSC + IP** or **PAL + IP**, or **Iris open** is **On** (page 33), superimpose and privacy masking are disabled regardless of the settings. The output image size is fixed at 640 × 480 (VGA) on JPEG and MPEG4 regardless of the setting.
- According to the output image size setting, superimpose and privacy masking have codec requirements. For details, refer to the following table.

	Superimpose/Privacy masking	
	JPEG	MPEG4
JPEG - 768 × 576 : MPEG4 - 640 × 480 (VGA)	●	–
JPEG - 640 × 480 (VGA) : MPEG4 - 640 × 480 (VGA)	●	●
JPEG - 640 × 480 (VGA) : MPEG4 - 384 × 288	–	●
JPEG - 640 × 480 (VGA) : MPEG4 - 320 × 240 (QVGA)	–	●
JPEG - 384 × 288: MPEG4 - 640 × 480 (VGA)	●	–
JPEG - 320 × 240 (QVGA): MPEG4 - 640 × 480 (VGA)	●	–
JPEG - 384 × 288 : MPEG4 - 384 × 288	●	●
JPEG - 320 × 240 (QVGA) : MPEG4 - 320 × 240 (QVGA)	●	●

● Usable – Not usable

## JPEG cropping (SNC-DM110 / DM160 / CM120 only)

When you select **JPEG - 1280 × 960 (Quad-VGA) : MPEG4 - OFF : JPEG cropping available** in the image size setting, cropping the image and displaying the required part of the image lead to a reduction in the volume of data transmission and network load. When you click **Area setting**, you can specify the cropping area.

### Cropping an image

- 1 Select **JPEG - 1280 × 960 (Quad-VGA) : MPEG4 - OFF : JPEG cropping available** in **Image size**.
- 2 Click **Area setting**.  
The area setting window appears.
- 3 Specify the cropping area.  
Click the left button of the mouse on the still image and drag it diagonally. The red frame that appears as you drag indicates the cropping area.
- 4 Click OK at the bottom of the window.  
The cropped image is displayed in the main viewer.
- 5 Click  to close the area setting window.

## Notes

- When you select **JPEG - 1280 × 960 (Quad-VGA) MPEG4 - OFF: JPEG image cropping available** in **Image size**, **Area setting** becomes inactive.
- Motion detection operates for the image in its original image size that is not cropped even if cropping is set to On.

## Privacy masking

The codec with which the privacy masking function is usable is shown in green. The privacy masking function can be set with “Installing the SNC privacy masking tool” (page 87).

## Notes

- When you set the privacy masking function, the image frame rate may be reduced.
- The motion detection function is performed with the image which is set before the privacy masking is activated.
- When the masking image is quite different from the masking color, the image may be blurred.

## Superimpose

The codec with which the superimpose function is usable is shown in green. Click **Superimpose** (page 32) and **Date & time** tab appears, and you can set superimpose.

### Notes

- When superimpose is activated, the image frame rate may be reduced.
- The Superimpose function does not work when JPEG image cropping is enabled. (SNC-DM110 / DM160 / CM120 only)

## SolidPTZ (SNC-DM110 / DM160 / CM120 only)

To activate the SolidPTZ function, select **On**. The codec with which the SolidPTZ function is usable is shown in green

### Notes

- Some image size settings cannot activate this function.
- After you have set SolidPTZ On, Motion detection operates for the original image size before the SolidPTZ setting.

## JPEG setting / MPEG4 setting

Set the details of the video codecs according to the image size setting. Select the items of **JPEG setting** or **MPEG4 setting** to be set according to the mode setting.

### Frame rate

Set the frame rate of the image. Selectable frame rate values are as follows.

1, 2, 3, 4, 5, 6, 8, 10, 15, 20, 25, 30 (fps)

“fps” is a unit indicating the number of frames transmitted per second.

### Note

When Light funnel is off, the maximum frame rate is 15 (fps). A higher setting is not accepted. (SNC-DM110 / DM160 / CM120 only)

### Image quality

Select the JPEG image quality. Selectable values are from **Level 1** to **Level 10**. **Level 10** gives the best image quality.

### Bandwidth control

Limits the network bandwidth of JPEG image data output from the camera. Selectable values are as follows:

0.5, 0.6, 0.7, 0.8, 0.9, 1.0, 2.0, 3.0, 4.0 (Mbps), and Unlimited

### Note

Audio may be interrupted depending on the selected bandwidth. In that case, select a wider bandwidth.

### Bit rate

When you set MPEG4, you can specify the bit rate for image transmission per line. The higher the values set, the higher the image quality. Selectable values are as follows:

64, 128, 256, 384, 512, 768, 1024, 1536, 2048 (kbps)

### Adaptive rate control

Adjusts the image frame rate or bit rate automatically to play smooth images to the connected computer environment. If **On** is selected, the MPEG4 image rate is automatically adjusted.

### Notes

- The actual frame rate and bit rate may be different according to the image size, shooting scene or network condition.
- When **Adaptive rate control** is set to **On**, the maximum transmission rate will be the values set in **Frame rate** and **Bit rate**.

## OK/Cancel

See “Buttons common to every menu” on page 28.

## Streaming Tab

Use this tab to set the items for unicast or multicast streaming.

The screenshot shows a configuration window with a blue background. It is divided into two sections: "Unicast streaming" and "Multicast streaming".

- Unicast streaming:**
  - Video port number: 50000 (1024 to 65534)
  - Audio port number: 50002 (1024 to 65534)
- Multicast streaming:**
  - On/Off toggle:  On  Off
  - Multicast address: [Empty text box]
  - Video port number: 60000 (1024 to 65534)
  - Audio port number: 60002 (1024 to 65534)
  - TTL: 1 (1 to 255)

At the bottom of the window, there are two buttons: "OK" and "Cancel".

## Unicast streaming

Specify the communication port numbers of the MPEG4/H.264 video data and audio data to be used when **UDP (unicast)** or **UDP (multicast)** is selected on the welcome page.

### Video port number

Specify the communication port number of the MPEG4 video data. It is initially set to 50000. Specify an even number from 1024 to 65534. Two port numbers (the number specified here and an odd number with 1 added to the specified number) are actually used for video data communication and control.

### Audio port number

Specify the communication port number of the audio data. It is initially set to 50002. Specify an even number from 1024 to 65534. Two port numbers (the number specified here and an odd number with 1 added to the specified number) are actually used for audio data communication and control.

#### Note

Specify different numbers for the video port number and the audio port number.

## Multicast streaming

Set whether the camera uses multicast streaming for MPEG4 video data and audio data or not. It reduces the transmission load on the camera by making the computer of the same segment network receive the same transmitting data.

Select **On** to allow and **Off** not to allow multicast sending.

When you select **On**, set **Multicast address**, **Video port number** and **Audio port number** properly.

### Multicast address

Type the multicast address used on the Multicast streaming.

### Video port number

Specify the communication port number of the MPEG4 video data used for the Multicast streaming. It is initially set to 60000. Specify an even number from 1024 to 65534. Two port numbers (the number specified here and an odd number with 1 added to the specified number) are actually used for video data communication and control.

### Audio port number

Specify the audio port number used for the Multicast streaming. It is initially set to 60002. Specify an even number from 1024 to 65534. Two port numbers (the number specified here and an odd number with 1 added

to the specified number) are actually used for audio data communication and control.

#### Note

Specify different numbers for the video port number and the audio port number.

### TTL

Specify the number of times multicast streaming packet could pass the router.

### OK/Cancel

See “Buttons common to every menu” on page 28.

# Configuring the Network

## — Network Menu

When you click **Network** in the Administrator menu, the Network menu appears.

Use this menu to configure the network to connect the camera and the computer.

The Network menu consists of two tabs: **Network** and **Dynamic IP address notification**.

### Network Tab

This section provides the menus for connecting the camera through the network cable.

#### MAC address

Displays the MAC address of the camera.

#### IP address

Configure the IP address.

**Obtain an IP address automatically (DHCP):** Select this option when a DHCP server is installed on the network to allow IP address assignment. With this setting, the IP address is assigned automatically.

**Use the following IP address:** Select this option when you set a fixed IP address. With this setting, specify the **IP address**, **Subnet mask** and **Default gateway** manually.

#### Note

When you select **Obtain an IP address automatically (DHCP)**, make sure that a DHCP server is operating on the network.

#### IP address

Type the IP address of the camera.

#### Subnet mask

Type the subnet mask.

#### Default gateway

Type the default gateway.

#### DNS server

Configure the DNS server address.

**Obtain DNS server address automatically:** Select this option to obtain the IP address of DNS server automatically. It can be set only when **Obtain an IP address automatically (DHCP)** is selected in the Network tab.

**Use the following DNS server address:** Select this when you set a fixed address as the IP address of the DNS server. With this setting, specify the addresses on **Primary DNS server** and **Secondary DNS server** manually.

#### Note

When you select **Obtain DNS server address automatically**, make sure that a DHCP server is operating on the network.

#### Primary DNS server

Type the IP address of the primary DNS server.

#### Secondary DNS server

Type the IP address of the secondary DNS server, if necessary.

#### Host name

Type the host name of the camera to be transmitted to the DHCP server. This setting is valid only when **Obtain an IP address automatically (DHCP)** is selected in the Network tab.

#### Domain suffix

Type the domain suffix of the camera to be transmitted to the DHCP server. This setting is valid only when **Obtain an IP address automatically (DHCP)** is selected in the Network tab.

#### Note

The domain suffix is sent to the DHCP server as FQDN (Fully Qualified Domain Suffix) information when **Host name** is set.

#### HTTP port number

Normally select **80**. If you want to use a port number other than 80, select the text box and type a port number between 1024 and 65535.

**Note**

When you have set the **HTTP port number** to a number other than 80 in the Network menu or in the IP Setup Program, access the camera again by typing the IP address of the camera on your Web browser as follows:

Example: when the HTTP port number is set to 8000



**OK/Cancel**

See “Buttons common to every menu” on page 28.

**Dynamic IP address notification Tab — Notifying the IP Address**

When **Obtain an IP address automatically (DHCP)** is selected in the Network tab, you can send notification of completion of the network settings using the SMTP or HTTP protocol.



**e-Mail (SMTP) notification**

Select **On** to send an e-mail when the DHCP setting is completed.

**SMTP server name**

Type the name or IP address of the SMTP server for sending an e-mail, using up to 64 characters.

**Authentication**

Select the authentication required when you send an e-mail.

**Off:** Select if no authentication is required when an e-mail is sent.

**On:** Select if authentication is required when an e-mail is sent. Select one of the authentication methods from the following and specify the **POP server name**, **User name** and **Password** as required.

**SMTP:** Select when SMTP authentication is required.

**POP before SMTP:** Select when POP before SMTP authentication is required.

**Note**

When you set **Authentication** to **On**, make sure to select either or both **SMTP** or/and **POP before SMTP**.

**POP server name**

It is necessary when **POP before SMTP** is selected for **Authentication**.

Type the POP (receiving mail) server name using up to 64 characters. Or type the IP address of the POP server. This setting is necessary when the SMTP server that sends e-mails performs authentication using the POP user account.

**User name, Password**

Type the user name and password of the user who owns the mail account using up to 64 characters. This setting is necessary when the SMTP server that sends e-mails performs authentication.

**Recipient e-mail address**

Type the recipient e-mail address using up to 64 characters. You can specify only one recipient e-mail address.

**Administrator e-mail address**

Type the e-mail address of the camera administrator using up to 64 characters. This is used as the reply address or the address for a system mail from the mail server.

**Subject**

Type the subject/title of the e-mail using up to 64 characters.

**Message**

Type the text of the e-mail using up to 384 characters. (A line break is equivalent to 2 characters.) You can describe the information of the acquired IP address, etc. using the special tags mentioned below.

## HTTP notification

Select **On** to output a command to the HTTP server when the DHCP setting is completed. Using this function, you can configure a useful system, for example, to view the access log stored in the HTTP server or start an external CGI program.

## URL

Specify the URL to send HTTP requests, using up to 256 characters. The URL is normally written as follows:

```
http://ip_address[:port]/path?parameter
```

**ip\_address:** Type the IP address or host name of the host to which you want to connect.

**[:port]:** Specify the port number to which you want to connect. If you want to use the established port number 80, you do not need to input this value.

**path:** Type the command.

**parameter:** Type the command parameter if necessary. You can use the special tags mentioned below for the parameters.

## Proxy server name

When you send HTTP requests via a proxy server, type the name or IP address of the proxy server, using up to 64 characters.

## Proxy port number

Specify the port number when you send HTTP requests via the proxy server. Set a port number between 1024 and 65535.

## Method

Select the HTTP method **GET** or **POST**.

## OK/Cancel

See “Buttons common to every menu” on page 28.

## About the special tags

You can use the following five special tags to allow notification of the settings acquired by DHCP, such as an IP address. Type the tags in the parameter section of the URL that you described in the Message field of the HTTP.

### <IP>

Use this tag to embed the IP address acquired by DHCP in the text or parameter.

### <HTTPPORT>

Use this tag to embed the specified HTTP server port number in the text or parameters.

### <MACADDRESS>

Use this tag to embed the MAC address of the interface whose IP address was acquired by DHCP, in the text or parameter.

### <MODELNAME>

Use this tag to embed the camera's model name in the text or parameter.

### <SERIAL>

Use this tag to embed the camera's serial number in the text or parameter.



# Using the 802.1X Authentication Function

## — 802.1X Menu

When you click **802.1X** in the Administrator menu, the 802.1X menu appears.

Use this menu to configure the port-based authentication in compliance with the 802.1X standard.

The 802.1X menu consists of three tabs: **Common**, **Client certificate** and **CA certificate**.

### Note

To use the 802.1X authentication function, you need knowledge of the 802.1X authentication and digital certificate. To establish an 802.1X network, you need to configure the authenticator, access point, authentication server and other elements. For details on these settings, refer to the manual of the corresponding equipment.

## System configuration of 802.1X network

The following figure shows a general system configuration of an 802.1X network.

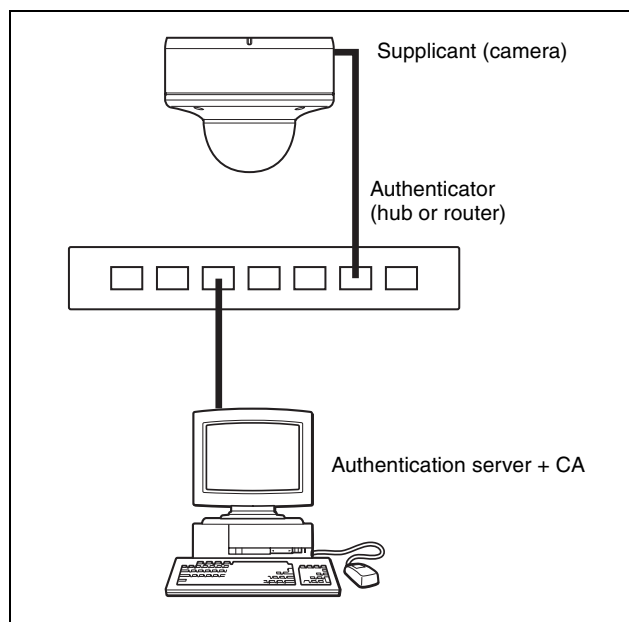

### Supplicant

A supplicant is a device that connects to the authentication server to join the network. This camera serves as a supplicant in the 802.1X network. The supplicant can enter the 802.1X network after the appropriate authentication by the authentication server.

### Authenticator

An authenticator forwards certificate request data or response data that the supplicant or authentication server issues to the other party. Normally a hub or router serves as an authenticator.

### Authentication server

An authentication server has a database of connecting users and verifies if the supplicant is a correct user or not. It is also called RADIUS server.

### CA (Certificate Authority)

A CA issues and manages certificates of the authentication server (CA certificates) and user certificates. The CA is essential for certificate-based user authentication. Normally a CA is located inside an authentication server.

### Note

This camera supports only the EAP-TLS mode in which the supplicant and the server authenticate each other using the certificate. This mode requires a CA that issues the certificate.

## Common Tab – Basic setting of 802.1X authentication function

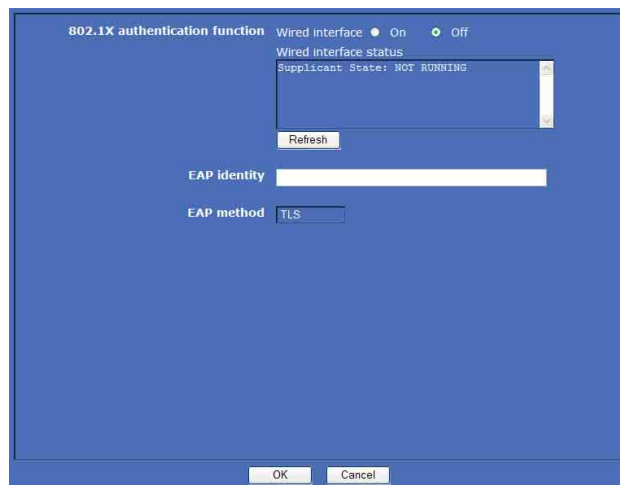

### 802.1X authentication function

This item is used for enabling/disabling the 802.1X authentication function for ports. The status can also be checked here.

### Wired interface

To activate the 802.1X authentication function for wired ports, select **On**.

### Wired interface status

Shows the authentication status of the 802.1X authentication function for wired ports. Click **Refresh** to update the status.

### EAP identity

Type the user name to identify the client in the 802.1X authentication server using 3 to 253 characters.

### EAP method

Shows the authentication method used with the authentication server. It is fixed as this camera supports only the TLS method.

### OK/Cancel

See “Buttons common to every menu” on page 28.

## Client certificate Tab

You can import a client certificate to the camera or export a certificate request.

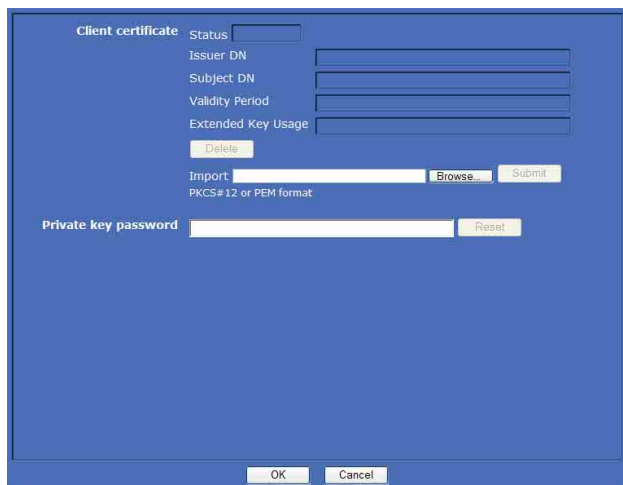

### Client certificate

Import, display or delete the client certificate.

#### To import the client certificate

Click **Browse...** to select the client certificate to be imported. Then click **Submit**, and the selected file will be imported to the camera.

#### Note

The import process becomes invalid if the selected file is not a client certificate or the imported client certificate is not allowed.

### To display the information of the client certificate

When the client certificate has been saved in the camera correctly, its information appears on **Status**, **Issuer DN**, **Subject DN**, **Validity Period** and **Extended Key Usage**.

**Status:** Shows if the status of the client certificate is valid or invalid.

**Valid** means the client certificate is correctly stored and set.

**Invalid** means the client certificate is not correctly stored and set.

Possible causes of **Invalid** are the following:

- When the private key password included in the client certificate is not specified correctly
- When the private key password is specified in spite of the fact that the key pair in the client certificate is not encrypted.
- When the key pair is not included in the client certificate.

#### Note

When the client certificate to be imported is of PKCS#12 format and the private key password is not set correctly, “<Put correct private key password>” is displayed in the boxes of **Issuer DN**, **Subject DN**, **Validity Period** and **Extended Key Usage**. Specify the correct private key password to confirm the information of the certificate.

#### To delete the client certificate

Click **Delete**, and the client certificate stored in the camera will be deleted.

#### Private key password

Type the password for the private key information included in the client certificate using up to 50 characters.

Leave the text box blank if the private key information included in the client certificate is not encrypted.

If no private key password is set in the camera, the text box is active to allow entering of a password.

If a private key password is already set, it is displayed with turned letters.

#### Reset

To change the private key password, click this button. The current password is cleared and the password text box is active to allow a new password entry.

#### Note

Click **Cancel** at the bottom of the menu if you want to cancel changing the private key password after clicking **Reset**. Doing so restores the other setting items in the Client certificate tab to the previous settings.

## OK/Cancel

See “Buttons common to every menu” on page 28.

## CA certificate Tab

You can import a trusted CA certificate (server certificate or route certificate) to the camera. Up to four certificates from trusted CAs can be imported to the camera. Only the PEM format is supported.

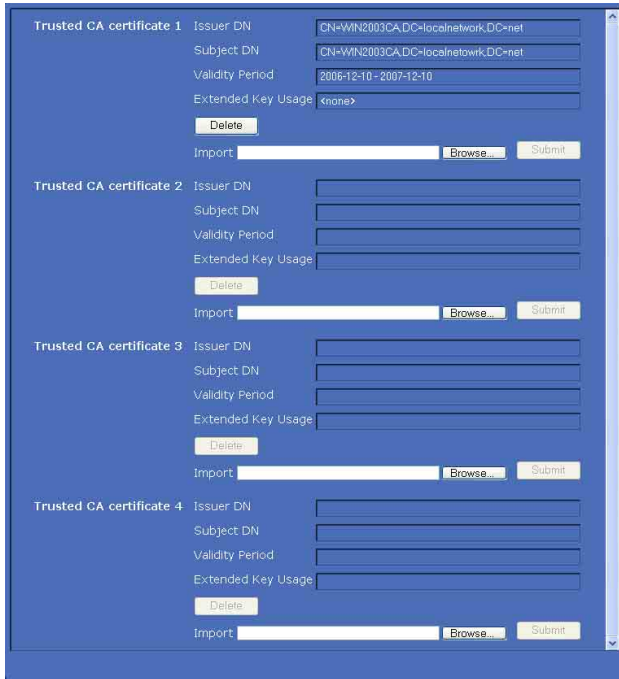

The screenshot shows a web interface for importing CA certificates. It features four sections, each labeled 'Trusted CA certificate' followed by a number (1 through 4). Each section contains the following fields: 'Issuer DN', 'Subject DN', 'Validity Period', and 'Extended Key Usage'. Below these fields is a 'Delete' button. At the bottom of each section is an 'Import' field with a 'Browse...' button and a 'Submit' button. The first section (Trusted CA certificate 1) has pre-filled values: Issuer DN: CN=WIN2003CA.DC=localnetwork.DC=net, Subject DN: CN=WIN2003CA.DC=localnetwork.DC=net, Validity Period: 2006-12-10 - 2007-12-10, and Extended Key Usage: <none>.

### To import the CA certificate

Click **Browse...** to select the CA certificate to be imported.

Then click **Submit**, and the selected file will be imported to the camera.

#### Note

Import process becomes invalid if the selected file is not a CA certificate.

### To display the information of the CA certificate

When the CA certificate has been saved in the camera correctly, its information appears on **Issuer DN**, **Subject DN**, **Validity Period** and **Extended Key Usage**.

### To delete the CA certificate

Click **Delete**, and the CA certificate stored in the camera will be deleted.

## Setting the 802.1X authentication function – Example of Windows Server 2003

This section explains how to configure the authentication server and CA using Microsoft Windows Server 2003.

#### Note

As this section describes authentication based on the user interface in English on Windows Server 2003, the UI terminology and page configuration may be different depending on the version of the Operating System or Service Pack and patch update status.

### Before setting

Perform the following settings before configuring an 802.1X network.

#### Active Directory (domain controller)

The following setting example is based on the assumption that the Active Directory has been configured.

#### Windows IAS configuration

To add the IAS (Internet Authentication Service), perform the following steps:

- 1 Configure **Remote access/VPN server** in **Manage Your Server** of Windows Server 2003.
- 2 Open **Add or Remove Programs** from **Control Panel** of Windows menu.
- 3 Install **Internet Authentication Service** in **Add/Remove Windows Components**.

#### CA configuration

To configure the CA, perform the following steps:

- 1 Open **Add or Remove Programs** from **Control Panel** of Windows menu.
- 2 Select **Add/Remove Windows Components**.
- 3 Add **Certificate Services** in the Component menu.
- 4 Select **Enterprise root CA** on **CA Type**, and proceed to next.
- 5 Type the name of CA on **Common Name for this CA**, and configure the CA.

## Creating a security group for Active Directory

- 1 Open **Active Directory Users and Computers** from **Administrative Tools** of Windows menu.
- 2 Select **Users** of the domain with which you want to perform 802.1X connection.
- 3 Select **New** from the context menu, then select **Group** and configure the group for 802.1X connection.  
For example, the group “Wired\_802.1X\_Group” is assumed for explanation purposes.

## Configuring the Internet Authentication Service

- 1 Open **Internet Authentication Service** from **Administrative Tools** of Windows menu.
- 2 Click **Register Server in Active Directory** on the operation menu.
- 3 Read the displayed precautions carefully and click **OK** to accept them.

Then, continue to configure the EAP-TLS policy.

- 4 Select **Remote Access Policy** and right-click.
- 5 Select **New** from the context menu, and select **Remote Access Policy** to open the “New Remote Access Policy Wizard.”
- 6 Select **Set up a custom policy**.
- 7 Set the following items:  
**Policy name:** Type “Allow 802.1X Access” as an example.  
**Policy conditions:** Click **Add** and add the following items:
  - NAS Port-Type: Ethernet, Wireless-IEEE802.11, Wireless-Other and Virtual (VPN)
  - Windows-Groups: Wired\_802.1X\_Group**Permissions:** Select **Grant remote access permission**.  
**Edit Profile:**
  - Dial-in Constraints tab: Specify the session time out period during which the client is allowed to be connected, as required.
  - Authentication tab: Delete checks from all the boxes. Click **EAP Method** and add **Smart Card or other certificates**.

Then, continue to configure the RADIUS client.

- 8 Select **RADIUS Clients** and right-click.
- 9 Select **New RADIUS Client** from the context menu.
- 10 Set the following items:  
**Friendly name:** Type “authenticator” as an example.  
**Client address (IP or DNS):** IP address of the authenticator  
**Client-Vender:** RADIUS Standard  
**Shared secret:** Specify the shared secret to be set in the authenticator.

## Adding a user

- 1 Open **Active Directory Users and Computers** from **Administrative Tools** of Windows menu.
- 2 Select **Users** of the domain with which you want to add a user and right-click.
- 3 Select **New** from the context menu, then select **User**.
- 4 Set the following items to configure a new user:  
For example, the log-on user name “1XClient” is assumed for explanation purposes.  
**First name:** 1XClient  
**User logon name:** 1XClient@<domain name>  
**Password:** Specify a password. Then select **Password never expires** in account options.
- 5 Select the user to be added and right-click.
- 6 Select **Properties** from the context menu.
- 7 Set the following items:  
**Dial-in tab:** Select **Allow access in Remote Access Permission (Dial-in or VPN)**  
**Member Of tab:** Add “Wired\_802.1X\_Group.”

The preparations for configuring a 802.1X network are now completed.

Proceed to issue the certificate to be imported to the camera.

## Issuing the CA certificate

Prepare a Windows client PC (called “client PC” hereafter) to temporarily store the certificate, and configure so that the client PC and Windows Server 2003 computer can be connected through the network.

- 1 Start Internet Explorer on the client PC.
- 2 Type the CA’s URL in the address bar, and click **Go To**.

The CA's URL is normally as follows:

http://<address of the CA>/CertSrv/

The "Microsoft Certificate Services" page opens.

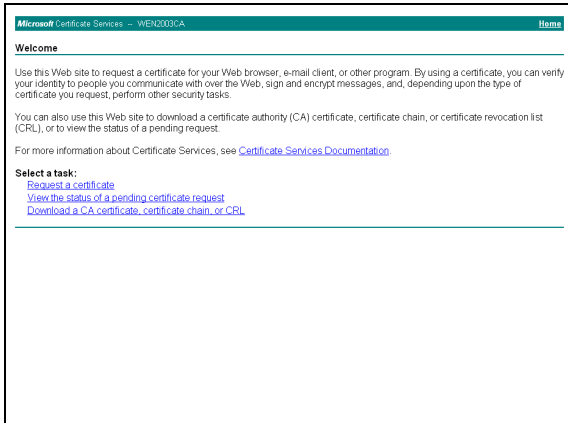

### Note

If the Microsoft Certificate Service page does not appear using the URL above, check the following:

- Is the service of Web site enabled on Internet Information Service (IIS)?
- Is Certificate Services enabled?
- Does the firewall or antivirus software setting on the client PC block connection?
- Are the network configuration and Internet Explorer setting on the client PC correct?

- 3** When Internet Explorer prompts entering the log-in user and password, type the user name as follows. Example: when the user name is "1XClient" and the domain name "localnetwork.net"

1XClient@localnetwork.net

- 4** Click **Download a CA certificate, certificate chain, or CRL**.

- 5** Select **Base 64** in **Encoding method** and click **Download CA certificate**. The "File Download" dialog opens.

- 6** Specify the file storage location and save the CA certificate.

After saving the CA certificate, import it to the camera. Then the CA certificate import procedure is completed.

## Downloading the client certificate

- 1** Start Internet Explorer on the client PC and type the CA's URL in the address bar.

The CA's URL is normally as follows:

http://<address of the CA>/CertSrv/

- 2** Click **Go To**.

- 3** Type the log-in user name and password correctly, and the "Microsoft Certificate Services" page opens.

- 4** Click **Request a certificate, advanced certificate request** and **Create and submit a request to this CA** in sequence.

- 5** Set the following items.

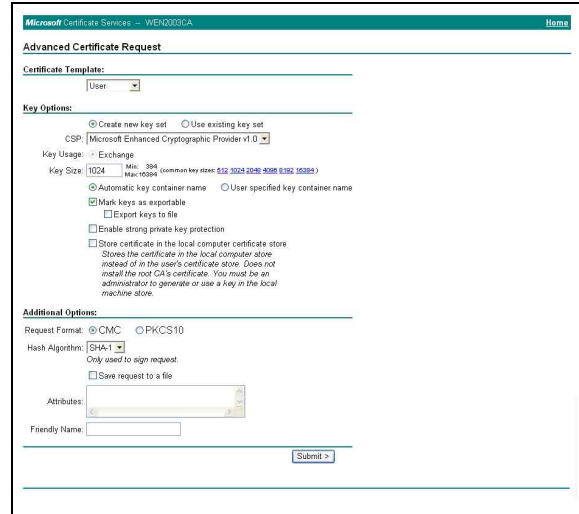

**Certificate Template:** User

**Key Options:** Create new key set

- CSP: Microsoft Enhanced Cryptographic Provider v1.0

- Key Size: 1024

- Check **Mark keys as exportable**.

**Additional Options:** Select **SHA-1** for **Hash Algorithm**.

- 6** Click **Submit**.

Message "The certificate you requested was issued to you." appears.

- 7** Click **Install this certificate**, to install the certificate in the certificate store on the client PC.

- 8** Click **Internet Options, Content and Certificates** of Internet Explorer in sequence. The new client certificate is displayed in the Personal tab.

- 9** Select the installed certificate and click **Export...** The "Certificate Export Wizard" opens.

- 10** Click **Next** and select as follows.

**Do you want to export the private key with the certificate?:** Select **Yes, export the private key**.

Select the format you want to use: Select **Personal Information Exchange – PKCS#12(PFX)**.

**Password:** Specify the private key password.

**File to export:** Specify the name of the file to be exported.

The certificate is now exported. Import the exported file to the camera as the camera's client certificate.

For details, see "To import the client certificate" in the Client certificate tab on page 50.

#### Note

The certificate saved in the procedure above has the same file name as the default file name for saving the CA certificate (certnew.cer).

Be careful not to overwrite the file on the client PC.

## Setting the User

### — User Menu

When you click **User** in the Administrator menu, the User menu appears.

Use this menu to set the user names and passwords of Administrator and up to 9 kinds of users (User 1 to User 9), and the access right of each user.

The screenshot shows a configuration window with a blue background. At the top, there are fields for 'Administrator' with 'admin' in the 'User name' field and masked passwords in the 'Password / Re-type password' fields. Below this is a table for 9 users. Each user row has columns for 'User name', 'Password / Re-type password', 'FTP' (checkbox), 'Audio' (checkbox), and 'Viewer mode' (dropdown menu). At the bottom, there is a 'Viewer authentication' section with radio buttons for 'On' and 'Off', and a 'Full' dropdown menu. 'OK' and 'Cancel' buttons are at the bottom right.

User name	Password / Re-type password	FTP	Audio	Viewer mode
User 1		<input type="checkbox"/>	<input type="checkbox"/>	Full
User 2		<input type="checkbox"/>	<input type="checkbox"/>	Full
User 3		<input type="checkbox"/>	<input type="checkbox"/>	Full
User 4		<input type="checkbox"/>	<input type="checkbox"/>	Full
User 5		<input type="checkbox"/>	<input type="checkbox"/>	Full
User 6		<input type="checkbox"/>	<input type="checkbox"/>	Full
User 7		<input type="checkbox"/>	<input type="checkbox"/>	Full
User 8		<input type="checkbox"/>	<input type="checkbox"/>	Full
User 9		<input type="checkbox"/>	<input type="checkbox"/>	Full

#### Administrator

Specify **User name**, **Password** and **Re-type password**.

#### User 1 to 9

Specify **User name**, **Password**, **Re-type password**, **FTP**, **Audio** and **Viewer mode** for each user ID.

#### User name

Type a user name between 5 and 16 characters.

#### Password

Type a password between 5 and 16 characters.

#### Re-type password

To confirm the password, retype the password that you typed in the **Password** box.

#### FTP

Set whether this user is allowed to log in to an FTP server or not. Check the box if the user is allowed to log in to an FTP server.

#### Audio

Select whether audio output to a speaker connected to the line output jack of the camera is allowed or not by using the SNC audio upload tool stored in the supplied CD-ROM. Check this box to allow audio output.

### Note

To output audio using the SNC audio upload tool, set **Audio upload** to **Enable** in the Common tab of the Camera menu (page 36).

### Viewer mode

When the user is authenticated for logging in to the main viewer, select the viewer mode to be displayed after authentication from the following items:

**Full:** The user can operate all functions.

**Light:** In addition to the **View** mode, the user can select the image size of the main viewer, control digital zoom, and capture a still image.

**View:** The user can only monitor the camera image.

**Pan/Tilt** (SNC-DM110 / DM160 / CM120 only): In addition to the **Light** mode, the user can operate pan/tilt/zoom.

**Preset position** (SNC-DM110 / DM160 / CM120 only): In addition to the **Light** mode, the user can perform the camera's preset position settings.

### Note

For the functions available for each viewer mode, see “Administrator and User” on page 16.

### Viewer authentication

Set whether the user is authenticated or not when the main viewer is displayed.

**On:** The main viewer is displayed in accordance with the viewer mode of the authenticated user.

**Off:** Select the viewer mode of the main viewer which is displayed without authentication from **Full**, **Pan/Tilt**, **Preset position**, **Light** or **View**.

### OK/Cancel

See “Buttons common to every menu” on page 28.

## Setting the Security — Security Menu

When you click **Security** in the Administrator menu, the Security menu appears.

Use this menu to limit the computers that can access the camera.

Network address/Subnet	IP Address	Subnet Mask	Policy
Network address/Subnet 1	0.0.0.0	8	Allow
Network address/Subnet 2	0.0.0.0	8	Allow
Network address/Subnet 3	0.0.0.0	8	Allow
Network address/Subnet 4	0.0.0.0	8	Allow
Network address/Subnet 5	0.0.0.0	8	Allow
Network address/Subnet 6	0.0.0.0	8	Allow
Network address/Subnet 7	0.0.0.0	8	Allow
Network address/Subnet 8	0.0.0.0	8	Allow
Network address/Subnet 9	0.0.0.0	8	Allow
Network address/Subnet 10	0.0.0.0	8	Allow

### Security function

To activate the security function, select **On**.

### Default policy

Select the basic policy of the limit from **Allow** and **Deny** for the computers specified in the Network address/Subnet 1 to Network address/Subnet 10 menus below.

### Network address/Subnet 1 to Network address/Subnet 10

Type the network addresses and subnet mask values that you want to allow or deny access to the camera.

You can specify up to 10 network addresses and subnet mask values. For a subnet mask, type 8 to 32.

Select **Allow** or **Deny** from the drop-down list on the right for each network address/subnet mask .

### Tip

The subnet mask value represents the bit number from the left of the network address.

For example, the subnet mask value for “255.255.255.0” is 24.

If you set **192.168.0.0/24** and **Allow**, you can allow access from computers having an IP address between “192.168.0.0” and “192.168.0.255”.

### Note

You can access the camera even from a computer having an IP address whose access right is set to **Deny**, if you

enter the user name and password set for the **Administrator** boxes in the User menu.

### OK/Cancel

See “Buttons common to every menu” on page 28.

## Saving the SolidPTZ Display Area and Action — Preset position Menu (SNC-DM110 / DM160 / CM120 only)

When you click **Preset position** in the Administrator menu, the Preset position menu appears. Use this menu to save pan, tilt and zoom positions and set tours (programmed action).

The Preset position menu consists of 2 tabs: **Position** and **Tour**.

### Notes

- When the SolidPTZ is disabled (page 42), you cannot control the Preset position menu.
- When the SolidPTZ is disabled (page 42), the preset **Position at alarm**, **PTZ on motion detection** and **Tour** are also disabled.

## Position Tab — Saving pan/tilt/zoom position

You can set up to 16 display areas (pan, tilt and zoom positions).

### Display sample: SNC-DM160

Home position setting

Preset No. Name

Position at alarm Sensor input (S1) none Motion detection (MD) none

No.	Name	Alarm		
No.1	<input type="text"/>	<input type="checkbox"/>	<input type="button" value="Preset call"/>	<input type="button" value="Clear"/>
No.2	<input type="text"/>	<input type="checkbox"/>	<input type="button" value="Preset call"/>	<input type="button" value="Clear"/>
No.3	<input type="text"/>	<input type="checkbox"/>	<input type="button" value="Preset call"/>	<input type="button" value="Clear"/>
No.4	<input type="text"/>	<input type="checkbox"/>	<input type="button" value="Preset call"/>	<input type="button" value="Clear"/>
No.5	<input type="text"/>	<input type="checkbox"/>	<input type="button" value="Preset call"/>	<input type="button" value="Clear"/>
No.6	<input type="text"/>	<input type="checkbox"/>	<input type="button" value="Preset call"/>	<input type="button" value="Clear"/>
No.7	<input type="text"/>	<input type="checkbox"/>	<input type="button" value="Preset call"/>	<input type="button" value="Clear"/>
No.8	<input type="text"/>	<input type="checkbox"/>	<input type="button" value="Preset call"/>	<input type="button" value="Clear"/>
No.9	<input type="text"/>	<input type="checkbox"/>	<input type="button" value="Preset call"/>	<input type="button" value="Clear"/>
No.10	<input type="text"/>	<input type="checkbox"/>	<input type="button" value="Preset call"/>	<input type="button" value="Clear"/>
No.11	<input type="text"/>	<input type="checkbox"/>	<input type="button" value="Preset call"/>	<input type="button" value="Clear"/>
No.12	<input type="text"/>	<input type="checkbox"/>	<input type="button" value="Preset call"/>	<input type="button" value="Clear"/>
No.13	<input type="text"/>	<input type="checkbox"/>	<input type="button" value="Preset call"/>	<input type="button" value="Clear"/>
No.14	<input type="text"/>	<input type="checkbox"/>	<input type="button" value="Preset call"/>	<input type="button" value="Clear"/>
No.15	<input type="text"/>	<input type="checkbox"/>	<input type="button" value="Preset call"/>	<input type="button" value="Clear"/>
No.16	<input type="text"/>	<input type="checkbox"/>	<input type="button" value="Preset call"/>	<input type="button" value="Clear"/>

### Home position setting

Set the current display area as the home position.



### Set

Click to save the current pan, tilt and zoom positions as the home position. To return to the home position, click  in the control panel (page 23).

### Reset

Click to reset the home position to the factory-set position.

#### Note

When you change the output image size in the Video codec tab (page 40) after setting the home position, you may not see the same display area that you wish to recall on the home position.

### Preset

Configure and save preset positions.

#### No.

Select a preset number from **1** to **16** from the drop-down list.

#### Name

Type the preset position name of the selected preset number using up to 32 characters.

#### Set

Click to save the current display area to the selected preset number.

To save a preset position, operate as follows:

- 1** Move the display area to the position to be saved while you are checking the image in the main viewer.
- 2** Select a preset number for saving, and type the preset position name.
- 3** Click the **Set** button.  
The position is saved.

#### Note

When you change the output image size in the Video codec tab (page 40) after setting the preset position, you may not see the same display area that you wish to recall on the preset position.

### Position at alarm

The preset position can be synchronized with the sensor input or with the motion detection function.

If an alarm is detected by the sensor input or the motion detection function, the display area automatically moves to the corresponding preset position.

If you do not want to synchronize with any preset position, select **none**.

### Sensor input (S1)

Select a preset position to synchronize with the alarm from the sensor input.

### Motion detection (MD)

Select a preset position to synchronize with the alarm from the motion detection.

Click **Detection**, and the Motion detection menu is displayed to allow you to set the motion detection function (page 75).

#### Note

In the case where the synchronized preset position is specified, the alarm event that happens when the display area is moving to the preset position will be invalid.

### Preset position table

Lists the preset positions and alarms assigned to each position currently saved in the camera.

You can move the display area to the preset position by clicking **Preset call**, or delete the preset position data by clicking **Clear**.

#### No.

Shows the preset number.

#### Name

Shows the name of the preset position assigned to each preset number.

#### Alarm

Shows the alarm(s) synchronized with each preset position. **S1** and **MD** represent Sensor input and Motion detection respectively.

#### Preset call

Click to move the display area to the preset position.

#### Clear

Click to delete the preset position data.

#### OK/Cancel

See “Buttons common to every menu” on page 28.

#### Note

The **OK/Cancel** can be effective in the operation of **Position at alarm** in this tab.

## Tour Tab — Setting a tour

The display area can be moved automatically with the Motion detection (PTZ on motion detection).

Up to 16 positions can be programmed, and the display area moves to the programmed positions sequentially (Tour).

One PTZ on motion detection and up to four tours (Tours A to D) can be set.

### Display sample: SNC-DM160

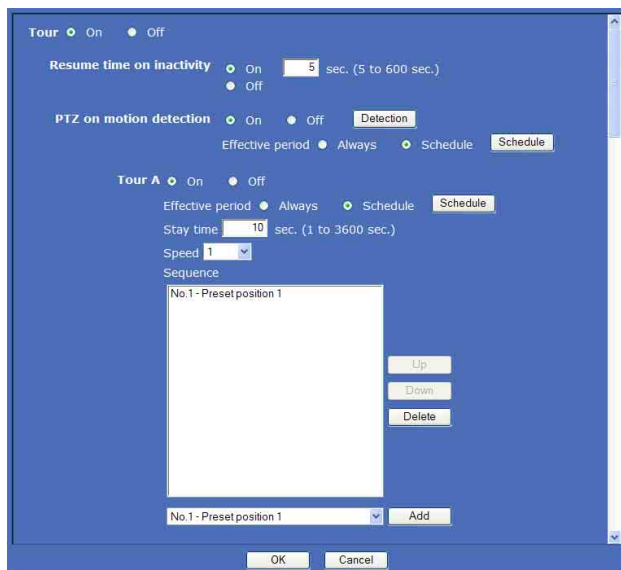

### Tour

Select **On** to enable the PTZ on motion detection and tour function.

### Resume time on inactivity

This item becomes active when **Tour** is set to **On**.

With this item, you can select whether to restart or stop the PTZ on motion detection or tour after it has stopped by manual pan, tilt or zoom operation or by moving the display area to the preset position triggered by an alarm.

**On:** Specify the wait time before the PTZ on motion detection or tour restarts, between 5 and 600 seconds. It restarts automatically after the specified time has elapsed.

**Off:** The PTZ on motion detection or tour do not restart.

### PTZ on motion detection

Configure the **PTZ on motion detection** that is performed in synchronization with the motion detection function.

This setting consists of two items: **On/Off** and **Effective period**.

**On:** The PTZ on motion detection operates.

**Off:** The PTZ on motion detection does not operate.

Click **Detection**, and the Motion detection menu is displayed to allow you to set the motion detection function (page 75).

### Effective period

Select the period during which the PTZ on motion detection is activated.

**Always:** The PTZ on motion detection can be activated any time.

**Schedule:** The PTZ on motion detection is activated according to the schedule you have set. Click **Schedule**, and the menu for the effective period is displayed. (“Setting the Schedule — Schedule Menu” on page 73)

### Notes

- If no moving objects exist, zoom changes to the WIDE end automatically and full image is displayed.
- You cannot set the PTZ on motion detection so that its effective period overlaps those of the tours.

### Tour A to Tour D

Configure Tour A to Tour D respectively.

Each tour setting consists of 5 items: **On/Off**, **Effective period**, **Stay time**, **Speed** and **Sequence**.

**On:** The tour operates.

**Off:** The tour does not operate.

### Effective period

Select the period during which the tour is activated.

**Always:** The tour can be activated any time.

**Schedule:** The tour is activated according to the schedule you have set.

Click **Schedule**, and the menu for the effective period is displayed. (“Setting the Schedule — Schedule Menu” on page 73.)

### Note

You cannot set tours so that the effective periods overlap with the PTZ on motion detection or other tours.

### Stay time

Type a period of time during which the display area is to stay at each preset position, between **1** and **3600** seconds.

### Speed

Select the speed of movement between 1 and 23, or Fastest from the drop-down list. The display area moves faster with a higher number setting.

Select **Jump** to move directly to the desired preset position.

### Sequence

Set the sequence of the tour.

The preset positions saved using the Position tab are displayed in the drop-down list at the bottom.

Select the preset position from the drop-down list, then click **Add**. The selected preset position is added in the **Sequence** list. Repeat this procedure to specify the preset positions in sequence.

If you specified an unnecessary preset position, click to select it in the list and click then **Delete**.

To change the order in the list, click to select the preset position and then click **Up** or **Down**.

#### Note

The tour cannot be set to **On** if no preset position is added in the **Sequence** list.

#### OK/Cancel

See “Buttons common to every menu” on page 28.

## Sending an Image via E-mail — e-Mail (SMTP) Menu

When you click **e-Mail (SMTP)** in the Administrator menu, the e-Mail (SMTP) menu appears.

Using e-Mail (SMTP) function, you can send an e-mail with attached image file that has been shot linked with an external sensor input or with the built-in motion detection function. The image file can also be sent periodically.

The e-Mail (SMTP) menu consists of three tabs: **Common**, **Alarm sending** and **Periodical sending**.

### Common Tab — Setting the e-Mail (SMTP) Function

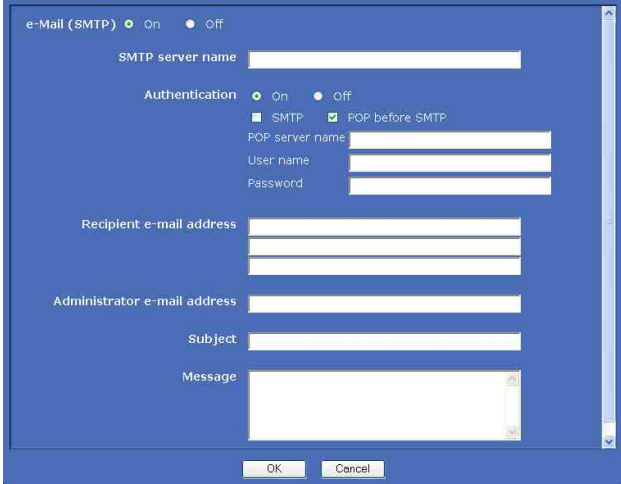

#### e-Mail (SMTP)

Select **On** when you use the e-Mail (SMTP) function.

#### Notes

- You cannot send an audio file by using the e-mail sending function.
- The frame rate and operability on the main viewer may be reduced while a file is being transmitted by the e-Mail (SMTP) function.

#### SMTP server name

Type the SMTP server name using up to 64 characters, or the IP address of the SMTP server.

#### Authentication

Select the authentication required when you send an e-mail.

**Off:** Select if no authentication is required when an e-mail is sent.

**On:** Select if authentication is required when an e-mail is sent. Select one of the authentication methods from the following and specify the **POP server name**, **User name** and **Password** as required.

**SMTP:** Select when SMTP authentication is required.

**POP before SMTP:** Select when POP before SMTP authentication is required.

**Note**

When you set **Authentication** to **On**, be sure to select either or both **SMTP** or/and **POP before SMTP**.

**POP server name**

It is necessary when **POP before SMTP** is selected for **Authentication**.

Type the POP (receiving mail) server name using up to 64 characters, or type the IP address of the POP server. This setting is necessary when the SMTP server that sends e-mails performs authentication using the POP user account.

**User name, Password**

Type the user name and password of the user who owns the mail account using up to 64 characters. This setting is necessary when the SMTP server that sends e-mails performs authentication.

**Recipient e-mail address**

Type the recipient e-mail address using up to 64 characters.  
You can specify up to three recipient e-mail addresses.

**Administrator e-mail address**

Type the Administrator e-mail address using up to 64 characters.  
This address is used for reply e-mails and sending system messages from the mail server.

**Subject**

Type the subject/title of the e-mail using up to 64 characters.  
When **Alarm sending** of the Alarm sending tab is set to **On**, an e-mail sent in response to the alarm detection will indicate the type of alarm in the subject. **SI** is added for sensor input detection and **MD** is added for motion detection.

**Message**

Type the text of the e-mail using up to 384 characters. (A line break is equivalent to 2 characters.)

**OK/Cancel**

See “Buttons common to every menu” on page 28.

**Alarm sending Tab — Setting the e-mail sending mode when detecting the alarm**

Set to send an e-mail linked with alarm detection by the external sensor input or by the built-in motion detection function.

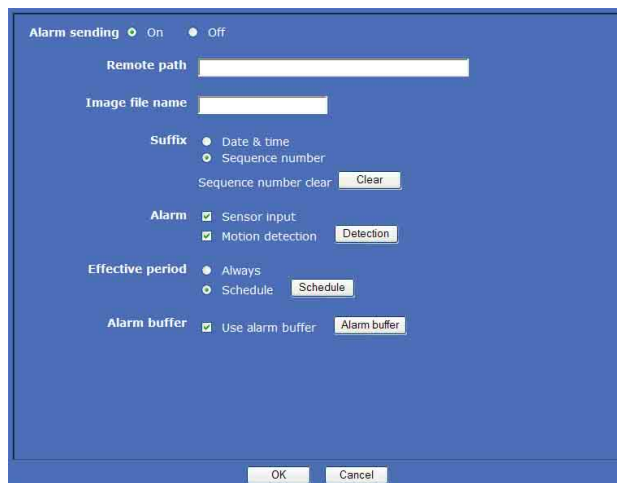

**Alarm sending**

Select **On** to set sending an e-mail linked with alarm detection.

**File attachment**

Set whether an image file (JPEG file) is to be attached to the e-mail or not.  
When **On** is selected, the image file made using the settings below is attached. When **Off** is selected, only the message is sent.

**Image file name**

Type the file name you want to assign to the image to be attached to an e-mail. You can use up to 10 alphanumeric characters, - (hyphen) and \_ (underscore) for naming.

**Suffix**

Select a suffix to be added to the file name.

**None:** No suffix is added. The image file name is assigned to the image to be sent via e-mail.

**Date & time:** The date & time suffix is added to the image file name.

The date/time suffix consists of lower two-digits of the year (2 digits), month (2 digits), date (2 digits), hour (2 digits), minute (2 digits), second (2 digits), and consecutive number (2 digits), thus adding 14-digit number to the image file name.

**Sequence number:** A consecutive number of 10 digits between 0000000001 and 4294967295 and two fixed digits 00 are added to the image file name.

### Sequence number clear

Click **Clear** to reset the **Sequence number** suffix to 1.

## Alarm

Select the alarm to be linked with e-mail notification.

**Sensor input:** The external sensor that is connected to sensor input of the camera I/O port.

**Motion detection:** The alarm detected by the motion detection function.

Click **Detection**, and the Motion detection menu is displayed to allow you to set the motion detection function (page 75).

### Note

In the case that the synchronized preset position is specified in **Position at alarm** in the Preset position menu, an alarm event that happens when the camera moves to the preset position will be invalid.

## Effective period

Set the period during which the alarm detection is effective.

**Always:** The alarm detection is always effective.

**Schedule:** You can specify the period during which the alarm detection is effective.

Click **Schedule** and the menu for the effective period is displayed. (“Setting the Schedule — Schedule Menu” on page 73)

## OK/Cancel

See “Buttons common to every menu” on page 28.

## Periodical sending Tab — Setting the periodical e-mail sending mode

You can set to send e-mails periodically.



## Periodical sending

Select **On** when you want to use periodical e-mail sending.

## Image file name

Type the file name of the image attached to the e-mail using up to 10 alphanumeric characters, - (hyphen) and \_ (under score).

The actual image file name will be the specified image file name with a suffix and the extension .jpg.

## Suffix

Select a suffix to be added to the file name used when the e-mail is sent.

**None:** The name of the sent file will be the image file name.

**Date & time:** The date & time suffix is added to the image file name.

The date & time suffix consists of lower two-digits of the year (2 digits), month (2 digits), date (2 digits), hour (2 digits), minute (2 digits) and second (2 digits), and consecutive number (2 digits), thus adding a 14-digit number to the image file name.

**Sequence number:** A consecutive number of 10 digits between 0000000001 and 4294967295 and two fixed digits 00 are added to the image file name.

## Sequence number clear

Click **Clear** to reset the **Sequence number** suffix to 1.

## Interval

Type the interval at which you want to send an e-mail periodically. You can set the hour (H) and minutes (M) between 30 minutes and 24 hours (one day).

## Effective period

Set the period during which periodical sending will be effective.

**Always:** Periodical sending is always effective.

**Schedule:** You can specify the period during which periodical sending is effective.

Click **Schedule** and the menu for the effective period is displayed. (“Setting the Schedule — Schedule Menu” on page 73)

## OK/Cancel

See “Buttons common to every menu” on page 28.

# Sending Images to FTP Server

## — FTP client Menu

When you click **FTP client** in the Administrator menu, the FTP client menu appears.

Use this menu to set up for capturing and sending still images to an FTP server. Using FTP client function, you can send an image and audio file that has been shot and recorded linked with the external sensor input or with the built-in motion detection function to an FTP server. The image file can also be sent periodically.

The FTP client menu consists of three tabs: **Common**, **Alarm sending** and **Periodical sending**.

## Common Tab — Setting the FTP client function

### FTP client function

To activate the FTP client function, select **On**.

#### Note

The frame rate and operability on the main viewer may be reduced while a file is being transmitted by the FTP client function.

### FTP server name

Type either the FTP server name to upload still images using up to 64 characters, or the IP address of the FTP server.

### User name

Type the user name for the FTP server using up to 64 characters.

## Password

Type the password for the FTP server using up to 64 characters.

## Re-type password

To confirm the password, type the same characters as you typed in the **Password** box.

## Passive mode

Set whether you use the passive mode of FTP server or not when connecting to the FTP server. Select **On** to connect to the FTP server using the passive mode.

## OK/Cancel

See “Buttons common to every menu” on page 28.

## Alarm sending Tab — Setting the FTP client action when detecting the alarm

Set to forward an image and audio file to the specified FTP server linked with alarm detection by the external sensor input or by the built-in motion detection function.



## Alarm sending

Select **On** to send the image and audio file to the FTP server linked with alarm detection.

## Remote path

Type the path to the destination using up to 64 characters.

## Image file name

Type the file name you want to assign to the images when sending to the FTP server. You can use up to 10 alphanumeric characters, - (hyphen) and \_ (underscore) for naming.

## Suffix

Select a suffix to be added to the file name.

**Date & time:** The date & time suffix is added to the image file name.

The date/time suffix consists of lower two-digits of the year (2 digits), month (2 digits), date (2 digits), hour (2 digits), minute (2 digits) and second (2 digits), and consecutive number (2 digits), thus adding a 14-digit number to the image file name.

**Sequence number:** A consecutive number of 10 digits between 0000000001 and 4294967295 and an consecutive 2 digits number are added to the image file name.

### Tip

A consecutive number added to **Date & time** and **Sequence number** is used to identify each of multiple files created with consecutive alarm events.

## Sequence number clear

Click **Clear** to reset the **Sequence number** suffix to 1.

## Alarm

Select the alarm to be linked with file forwarding to the FTP server.

**Sensor input:** The external sensor that is connected to sensor input of the camera I/O port.

**Motion detection:** The alarm detected by the motion detection function.

Click **Detection**, and the Motion detection menu is displayed to allow you to set the motion detection function (page 75).

### Note

In the case that the synchronized preset position is specified in **Position at alarm** in the Preset position menu, an alarm event that happens when the camera moves to the preset position will be invalid.

## Effective period

Set the period during which the alarm detection is effective.

**Always:** The alarm detection is always effective.

**Schedule:** You can specify the period during which the alarm detection is effective.

Click **Schedule** and the menu for the effective period is displayed. (“Setting the Schedule — Schedule Menu” on page 73)

## Alarm buffer

Select **Use alarm buffer** when you are going to forward the image/audio of before and after alarm detection (pre-alarm, post-alarm).

If you do not select the alarm buffer, only the image at the moment of the alarm detection is forwarded. Click **Alarm buffer** to display the Alarm buffer menu. For details, see “Setting the Alarm Buffer — Alarm buffer Menu” on page 74.

## OK/Cancel

See “Buttons common to every menu” on page 28.

## Periodical sending Tab — Setting the periodical FTP client activity

You can set to send image files (JPEG files) to an FTP server periodically.

### Display sample: SNC-DM160

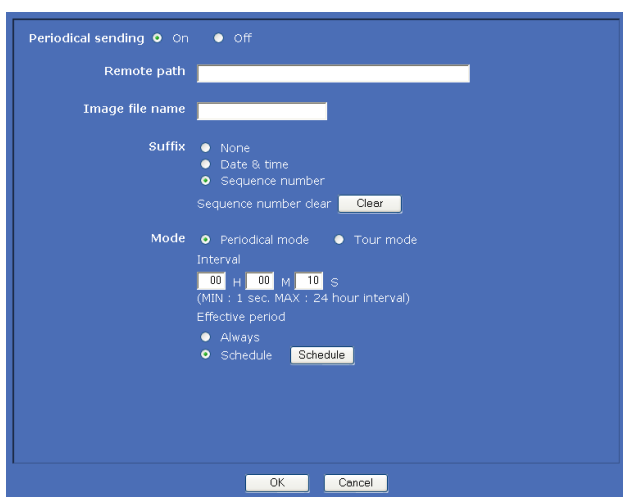

## Periodical sending

Select **On** when you want to use periodical sending.

## Remote path

Type the remote path using up to 64 characters.

## Image file name

Type the file name of the image sent to the FTP server using up to 10 alphanumeric characters, - (hyphen) and \_ (under score).

The actual image file name will be the specified image file name with a suffix and the extension .jpg.

### Note

You cannot send the audio file using the periodical sending of the FTP client function.

## Suffix

Select a suffix to be added to the file name sent to the FTP server.

**None:** The name of the sent file will be the image file name.

**Date & time:** The date & time suffix is added to the image file name.

The date & time suffix consists of lower two-digits of year (2 digits), month (2 digits), date (2 digits), hour (2 digits), minute (2 digits) and second (2 digits), and consecutive number (2 digits), thus adding a 14-digit number to the image file name.

**Sequence number:** A consecutive number of 10 digits between 0000000001 and 4294967295 and two fixed digits 00 are added to the image file name.

## Sequence number clear

Click **Clear** to reset the Sequence number suffix to 1.

## Mode (SNC-DM110 / DM160 / CM120 only)

Select the periodical sending mode.

**Periodical mode:** An image file is sent periodically according to the specified **Interval** and **Effective period**.

**Tour mode:** An image file is sent each time the camera is moved to a preset position during the tour.

### Note

You cannot send files Tour mode while PTZ on motion detection is performed.

## Interval

Type the interval at which you want to send images to the FTP server periodically. You can set the hour (H), minutes (M) and seconds (S) between 1 second and 24 hours (one day).

### Note

The actual interval may be longer than the set value, depending on the image size, image quality setting, bit rate and the network environments.

## Effective period

Set the period during which the periodical sending is effective.

**Always:** The periodical sending is always effective.

**Schedule:** You can specify the period during which the periodical sending is effective.

Click **Schedule** and the menu for the effective period is displayed. (“Setting the Schedule — Schedule Menu” on page 73)

## OK/Cancel

See “Buttons common to every menu” on page 28.



# Recording Images in Memory

## — Image memory Menu

When you click **Image memory** in the Administrator menu, the Image memory menu appears.

By using the image memory function, you can record the image and audio file, which has been shot being linked with the external sensor input or with the built-in motion detection function, in the built-in memory (about 8 MB). The image file can also be recorded periodically.

The recorded image and audio files can be found or downloaded to the computer using the FTP server function. (See “Downloading Images from the Camera — FTP server Menu” on page 68.)

The Image memory menu consists of three tabs: **Common**, **Alarm recording** and **Periodical recording**.

### Notes

- The image and audio files recorded in the built-in memory are deleted when the power of the camera is turned.
- The frame rate and operability on the main viewer may be reduced during image storage.

## Common Tab — Setting the image memory function

### Image memory

To use the image memory function, select **On**.

### Built-in memory

The current memory space of the built-in memory is displayed.

### Overwrite

Select **On** to overwrite the file or not when there is insufficient memory space to record the image in the built-in memory.

**On:** Overwrite is enabled and old files will be overwritten in the order of date.

**Off:** Overwrite is prohibited. No recording will be performed.

### Capacity warning

Select **On** to send a warning mail to the Administrator when the memory space of the built-in memory is low or the memory is full. Select **Off** if you do not want to send a warning mail.

### Note

When **Overwrite** is set to **On**, a warning mail is not sent to the Administrator.

### SMTP server name

Type the name of the SMTP server for sending an e-mail, using up to 64 characters. Otherwise type the IP address of the SMTP mail server.

### Authentication

Select the authentication required when you send an e-mail.

**On:** Select if authentication is required when an e-mail is sent.

Select one of the authentication methods from the following and specify the **POP server name**, **User name** and **Password** as required.

**SMTP:** Select when SMTP authentication is required.

**POP before SMTP:** Select when POP before SMTP authentication is required.

**Off:** Select if no authentication is required when an e-mail is sent.

### Note

When you set **Authentication** to **On**, be sure to select either or both **SMTP** or/and **POP before SMTP**.

### POP server name

This is necessary when **POP before SMTP** is selected for **Authentication**.

Type a POP (receiving mail) server name using up to 64 characters, or type the IP address of the POP server. This setting is necessary when the SMTP server that sends e-mails performs authentication using the POP user account.

### User name, Password

Type the user name and the password of the user who owns the e-mail account. This setting is necessary when the SMTP server that sends e-mails performs authentication.

### Administrator e-mail address

Type the e-mail address of the recipient of a warning mail (e-mail address of the camera Administrator), using up to 64 characters.

### OK/Cancel

See “Buttons common to every menu” on page 28.

## Alarm recording Tab — Setting the Image memory function when detecting the alarm

You can set to record the image and audio file to the memory linked with the external sensor input or with the built-in motion detection function.

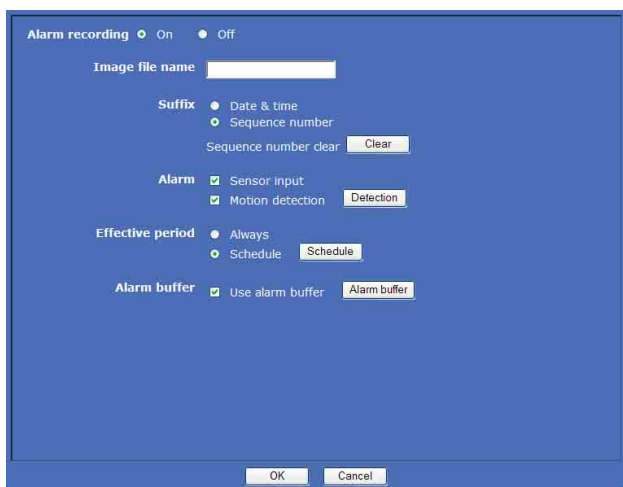

### Alarm recording

Select **On** to record the image and audio file in the built-in memory linked with alarm detection.

### Image file name

Type the file name you want to assign to the images to be recorded. You can use up to 10 alphanumeric characters, - (hyphen) and \_ (underscore) for naming.

### Suffix

Select a suffix to be added to the file name.

**Date & time:** The Date & time suffix is added to the image file name.

The Date & time suffix consists of lower two-digits of the year (2 digits), month (2 digits), date (2 digits), hour (2 digits), minute (2 digits), second (2 digits)

and consecutive number (2 digits), thus adding a 14-digit number to the image file name.

**Sequence number:** A consecutive number of 10 digits between 0000000001 and 4294967295 and an consecutive 2 digits number is added to the image file name.

### Tip

A consecutive number added to **Date & time** and **Sequence number** is used to identify each of the multiple files created with consecutive alarm events.

### Sequence number clear

Click **Clear** to reset the **Sequence number** suffix to 1.

### Alarm

Select the alarm to be linked with the recording of image and audio files.

**Sensor input:** The external sensor that is connected to sensor input of the camera I/O port.

**Motion detection:** The alarm by the motion detection function.

Click **Detection**, and the Motion detection menu is displayed to allow you to set the motion detection function (page 75).

### Note

In the case that the synchronized preset position is specified in **Position at alarm** in the Preset position menu, the alarm event that happens when the camera moves to the preset position will be invalid.

### Effective period

Set the period during which alarm detection is effective.

**Always:** The alarm detection is always effective.

**Schedule:** You can specify the period during which alarm detection is effective.

Click **Schedule** and the setting menu for the effective period is displayed. (“Setting the Schedule — Schedule Menu” on page 73)

### Alarm buffer

Select **Use alarm buffer** when you record the image/audio of before and after alarm detection (pre-alarm, post-alarm).

If you do not select the alarm buffer, only the image at the moment of the alarm detection is recorded.

Click **Alarm buffer** to display the Alarm buffer menu. For details, see “Setting the Alarm Buffer — Alarm buffer Menu” on page 74.

### OK/Cancel

See “Buttons common to every menu” on page 28.

## Periodical recording Tab — Setting the periodical recording mode

You can set to record the image file (JPEG file) in the built-in memory periodically.

### Display sample: SNC-DM160

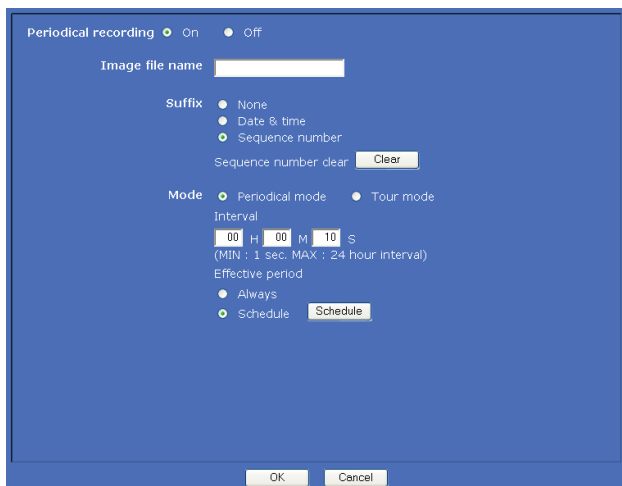

## Periodical recording

Select **On** when you want to use periodical recording.

## Image file name

Type the file name of the image to be recorded to the memory using up to 10 alphanumeric characters, - (hyphen) and \_ (under score). The actual image file name will be the specified image file name with the a suffix and the extension .jpg.

### Note

You cannot record the audio file using the periodical recording function.

## Suffix

Select a suffix to be added to the file name.

**None:** The recording file name will be the image file name.

**Date & time:** The date & time suffix is added to the image file name.

The date/time suffix consists of lower two-digits of the year (2 digits), month (2 digits), date (2 digits), hour (2 digits), minute (2 digits), second (2 digits), and consecutive number (2 digits), thus adding a 14-digit number to the image file name.

**Sequence number:** A consecutive number of 10 digits between 0000000001 and 4294967295 and two fixed digits 00 are added to the image file name.

## Sequence number clear

Click Clear to reset the Sequence number suffix to 1.

## Mode (SNC-DM110 / DM160 / CM120 only)

Select the periodical recording mode.

**Periodical mode:** An image file is recorded periodically according to the specified **Interval** and **Effective period**.

**Tour mode:** An image file is recorded when the camera is moved to each preset position during the tour.

### Note

You cannot record files in Tour mode while PTZ on motion detection is performed.

## Interval

Type the interval at which you want to record an image in the memory periodically. You can set the hour (H), minutes (M) and seconds (S) between 1 second and 24 hours (one day).

### Note

The actual interval may be longer than the set value depending on the image size, image quality, bit rate, or recording media.

## Effective period

Set the period during which the periodical recording is effective.

**Always:** The periodical recording is always effective.

**Schedule:** You can specify the period during which the periodical recording is effective.

Click **Schedule** and the menu for the effective period is displayed. (“Setting the Schedule — Schedule Menu” on page 73)

## OK/Cancel

See “Buttons common to every menu” on page 28.

## Folder structure of image memory

When the image memory function is used, the images are recorded with the following tree structure of folder.

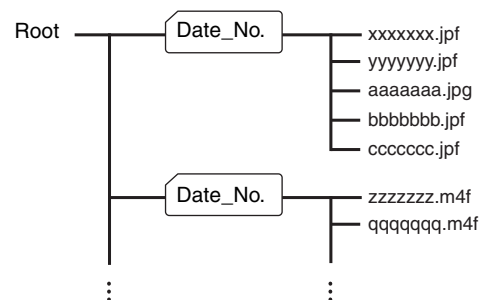

A  represents a folder created automatically.

The Date\_No. folder has a 11-digit name consisting of the last two digits of the year (2 digits), month (2 digits), day (2 digits), underscore and sequence number (4 digits).

In the built-in memory, one folder automatically created can store image files of about 1 MB. If the size of the image files exceeds that value, a new folder is created automatically to continue recording.

### About the extension of a file

A file to be recorded/sent using the image memory function or the FTP client function has one of the following three extensions depending on the video mode setting and the recording/sending settings of the camera.

- .m4f:** A file of this type is created when **Use alarm buffer** is selected in the Alarm recording or Alarm sending tab and **MPEG4** is selected on **Codec** in the Alarm buffer menu. The file may include audio data depending on audio input setting of the camera.
- .jpf:** A file of this type is created when **Use alarm buffer** is selected in the Alarm recording or Alarm sending tab and **JPEG** is selected on **Codec** in the Alarm buffer menu. The file may include audio data depending on audio input setting of the camera.
- .jpg:** A file of this type is created when **Use alarm buffer** is not selected in the Alarm recording or Alarm sending tab or when a periodical sending or periodical recording is performed.

The SNC video player (page 85) allows playing of “.m4f” and “.jpf” files.

## Downloading Images from the Camera — FTP server Menu

When you click **FTP server** in the Administrator menu, the FTP server menu appears. Use this menu to set up for the FTP server function that finds a specified image and audio file stored in the built-in memory (about 8 MB) or downloads a file from the camera.

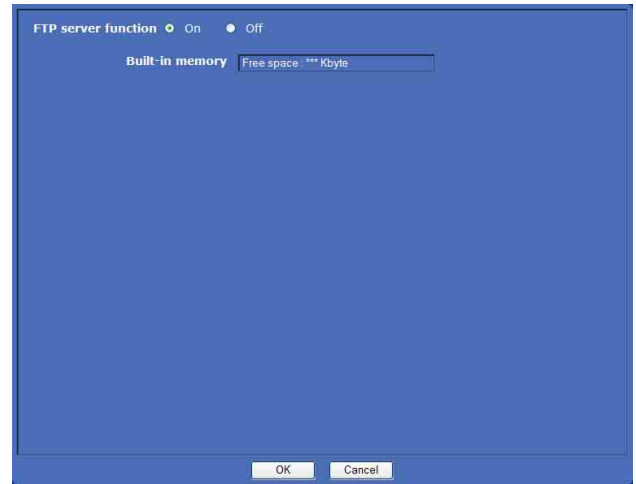

### FTP server function

To activate the FTP server function, select **On**.

### Built-in memory

The current memory space of the built-in memory is displayed.

#### Notes

The frame rate and operability on the main viewer may be reduced when you logged in to the FTP server of this unit using the FTP client software installed in the computer.

### OK/Cancel

See “Buttons common to every menu” on page 28.

# Setting the Alarm Output

## — Alarm output Menu

When you click **Alarm output** in the Administrator menu, the Alarm output menu appears.

You can perform setting in this menu to control the alarm output of the I/O port on the rear of the camera linked to the alarm detection, the timer and the Day/Night function.

The Alarm output menu consists of two tabs: **Alarm out 1** and **Alarm out 2**.

### Tip

For the connection of peripheral devices to the alarm output of the I/O port, see the supplied Installation Manual.

## Alarm out 1, 2 Tab

Display sample: SNC-DM160

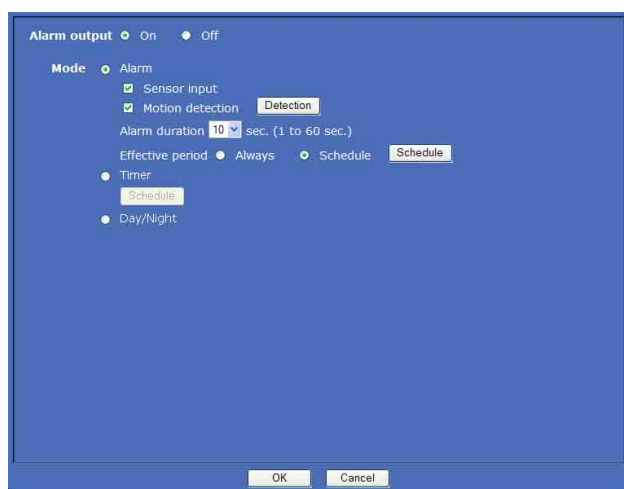

### Alarm output

To activate the alarm output function, select **On**.

### Mode

Select the mode of the alarm output function.

**Alarm:** Controls alarm output by synchronizing it with an external sensor input or the built-in motion detection function.

When **Alarm** is selected, the items **Sensor input**, **Motion detection**, **Alarm duration** and **Effective period** become active.

**Timer:** Controls alarm output using the timer.

Click **Schedule** and the menu for the effective period is displayed. (“Setting the Schedule — Schedule Menu” on page 73)

**Day/Night** (SNC-DM160 / DS60 / CM120 / CS20 only): Controls the alarm output linked to the day/night function.

### Sensor input

Select this option when you link the alarm output to an external sensor that is connected to sensor input of the camera I/O port.

### Motion detection

Select this option when you link the alarm output to the motion detection function.

Click **Detection**, and the Motion detection menu is displayed to allow you to set the motion detection function (page 75).

### Note

In the case that the synchronized preset position is specified in **Position at alarm** in the Preset position menu, the alarm event that happens when the display area to the preset position will be invalid.

### Alarm duration

Select the duration for which the alarm output is short-circuited between 1 and 60 sec.

### Effective period

This item becomes active when **Mode** is set to **Alarm**. Set the period during which the alarm detection is effective.

**Always:** The alarm detection is always effective.

**Schedule:** You can specify the period during which alarm detection is effective.

Click **Schedule** and the menu for the effective period is displayed. (“Setting the Schedule — Schedule Menu” on page 73)

### OK/Cancel

See “Buttons common to every menu” on page 28.

# Outputting Audio Linked to Alarm Detection

## — Voice alert Menu

Click **Voice alert** in the Administrator menu to display the Voice alert menu.

Use this menu to set the voice alert function to output audio from the line output jack of the camera when an alarm is detected by the sensor input or motion detection function.

You can output the audio from the speaker connected to the camera in synchronization with an alarm event triggered by the sensor input or the motion detection function.

The Voice alert menu consists of 3 tabs: **Voice alert 1**, **Voice alert 2** and **Voice alert 3**. You can configure an individual audio file on each tab.

### Note

Before using the voice alert function, you need to save the audio file to the camera using the SNC audio upload tool stored in the supplied CD-ROM.

For the use of the SNC audio upload tool, see page 80.

## Voice alert 1, 2, 3 Tab

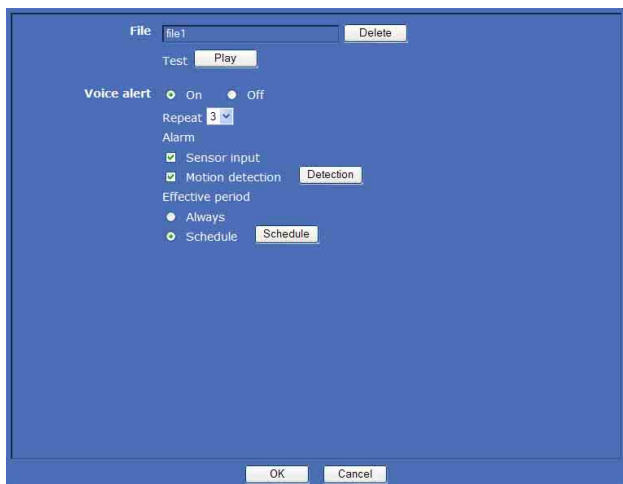

### File

Displays the name of the audio file saved in the camera. “Not uploaded” is displayed dimly if no audio file is saved.

To delete the audio file saved in the camera, click **Delete**.

### Note

Before deleting the audio file, set **Voice alert** to **Off**.

### Test

When the audio file is saved in the camera, you can check it by playing it back.

Click **Play** to play back the audio file once.

### Voice alert

To use the voice alert function linked with the sensor input or the motion detection function, select **On**.

### Repeat

Select playback repeat time from **1** to **3**.

### Alarm

Select the alarm to be linked with the voice alert function.

**Sensor input:** The external sensor that is connected to sensor input of camera I/O port.

**Motion detection:** The alarm detected by the motion detection function.

Click **Detection**, and the Motion detection menu is displayed to allow you to set the motion detection function (page 75).

### Notes

- If voice alert is activated linked with a different alarm event while another voice alert is going on, the first voice alert is canceled and the second one is output.
- If two or three audio files are set to be output simultaneously linked with the same alarm event, the priority is given in the order **Voice alert 1**, **2** and **3**.
- In the case where a preset position is specified in **Position at alarm** in the Preset position menu, the alarm event that happens when the display area moves to the preset position will be invalid.

### Effective period

Set the period during which the alarm detection is effective.

**Always:** The alarm detection is always effective.

**Schedule:** You can specify the period during which the alarm detection is effective.

Click **Schedule**, and the menu for the effective period is displayed. (“Setting the Schedule — Schedule Menu” on page 73)

### OK/Cancel

See “Buttons common to every menu” on page 28.

# Setting the Operations from the Viewer — Trigger Menu

Click **Trigger** in the Administrator menu to display the Trigger menu.

In this menu, you will select the activities that can be performed when  is clicked on the main viewer.

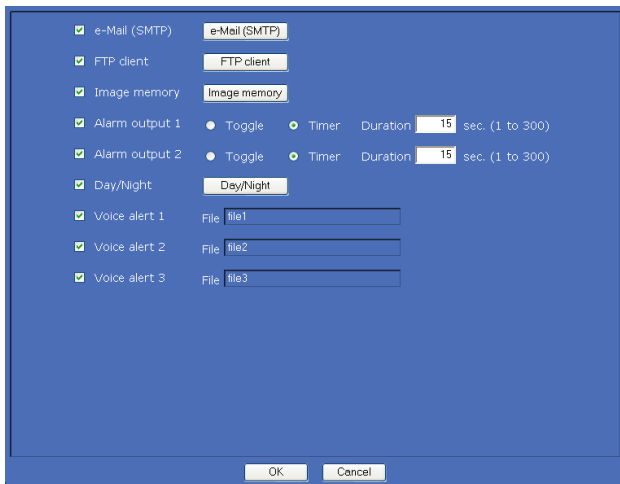

## e-Mail (SMTP)

Checking this box allows you to select **e-Mail** from the trigger drop-down list in the main viewer.

By selecting **e-Mail** and clicking , a still image of the moment you click is captured, and your e-mail with the image file attached is sent to the specified mail address.

When you click **e-Mail (SMTP)**, the **Trigger-e-Mail (SMTP)** menu is displayed. You can set the necessary options here. The setting options and setting procedures are the same as those of the e-Mail (SMTP) menu (page 59).

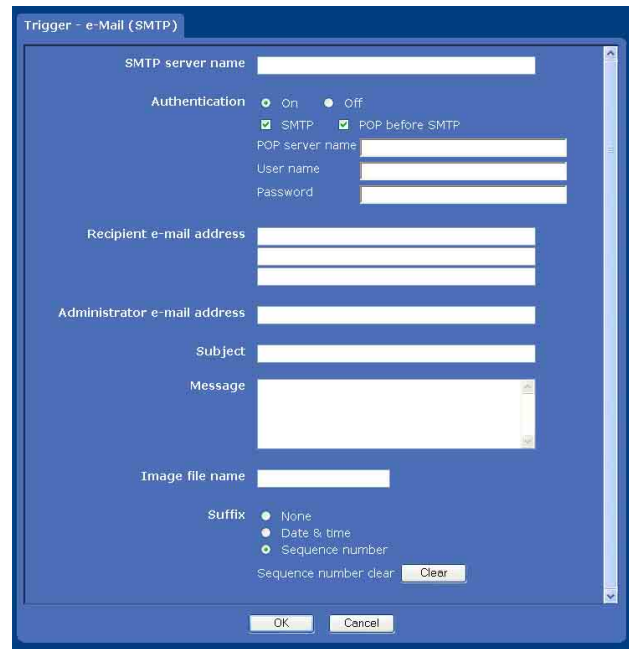

## FTP client

Checking this box allows you to select **FTP** from the trigger drop-down list in the main viewer.

By selecting **FTP** and clicking , a still image of the moment you click is captured, and the image file is sent to the FTP server.

When you click **FTP client**, the **Trigger-FTP client** menu is displayed. You can set the necessary options here. The setting options and setting procedures are the same as those of the FTP client menu (page 62).



## Image memory

Checking this box allows you to select **Image memory** from the trigger drop-down list in the main viewer.

By selecting **Image memory** and clicking , a still image of the moment you click is captured, and the image file is recorded in the built-in memory.

When you click **Image memory**, the **Trigger-Image memory** menu is displayed. You can set the necessary options here. The setting options and setting procedures are the same as those of the Image memory menu (page 65).

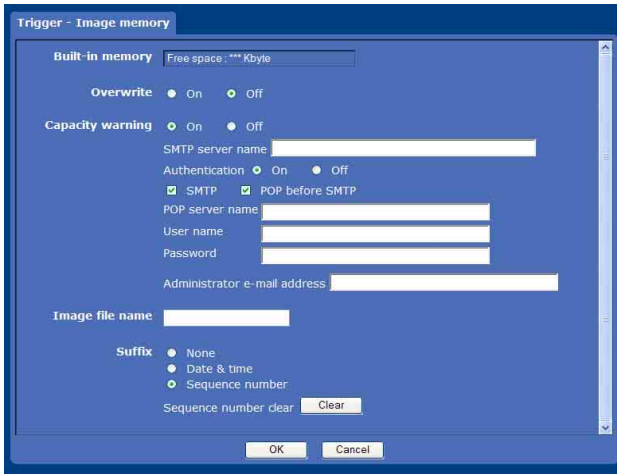

### Alarm output 1, 2

Checking this box allows you to select **Alarm output 1** or **Alarm output 2** from the trigger drop-down list in the main viewer. You can control the alarm output by selecting **Alarm output 1** or **Alarm output 2** and clicking .

Select the alarm output control mode from **Toggle** or **Timer**.

**Toggle:** Each time you click , On (short circuit) or Off (open) is switched.

**Timer:** When you click , the alarm output is switched to On (short circuit), and will automatically switched to Off (open) after the time specified in **Duration** has elapsed.

### Duration

When **Timer** is selected, specify the time for which the alarm output remains short circuited, from 1 to 300 seconds.

### Day/Night (SNC-DM160 / DS60 / CM120 / CS20 only)

Checking this box allows you to select **Day/Night** from the trigger drop-down list in the main viewer. You can control On (night mode) or Off (day mode) of the day/night function by selecting **Day/Night** and clicking .

When you click the **Day/Night** button, the **Trigger-Day/Night** menu is displayed. You can set the necessary options here. The setting options and setting procedures

are the same as those in the Sense up tab of the Camera menu (page 38).

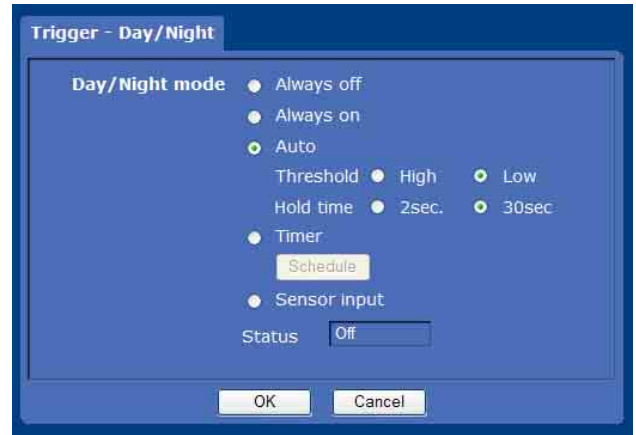

### Note

The day/night function is invalid when **Day/Night mode** is set to **Auto** in the **Trigger-Day/Night** menu, even if you click .

### Voice alert 1, 2, 3

Checking this box allows you to select **Voice alert 1**, **Voice alert 2** or **Voice alert 3** from the trigger drop-down list in the main viewer. You can output audio from the audio file saved in the camera by selecting **Voice alert 1**, **2** or **3** and clicking .

### File

Displays the name of the audio file saved in the camera. “Not uploaded” is displayed dimly if no audio file is saved.

### OK/Cancel

See “Buttons common to every menu” on page 28.



# Setting the Schedule

## — Schedule Menu

When you click **Schedule** in the Administrator menu, the Schedule menu appears.

The Schedule menu consists of seven tabs.

This is the same menu as the Schedule menu that is displayed when you click **Schedule** to set the **Effective period** in the following menus.

**Sense up** (SNC-DM110 / DM160 / DS60 / CM120 / CS20 only): **Schedule** in the Sense up tab of the Camera menu

**Preset position** (SNC-DM110 / DM160 / CM120 only): **Schedule** in the Tour tab of the Preset position menu

**e-Mail**: **Schedule** in the Alarm sending or Periodical sending tab of the e-Mail (SMTP) menu

**FTP**: **Schedule** in the Alarm sending or Periodical sending tab of the FTP client menu

**Image memory**: **Schedule** in the Alarm recording or Periodical recording tab of the Image memory menu

**Alarm out**: **Schedule** in the Alarm out 1 or Alarm out 2 tab of the Alarm output menu

**Voice alert**: **Schedule** in the Voice alert 1, 2 or 3 tab of the Voice alert menu

Example: When setting e-Mail (SMTP) (Periodical sending) in the Schedule menu

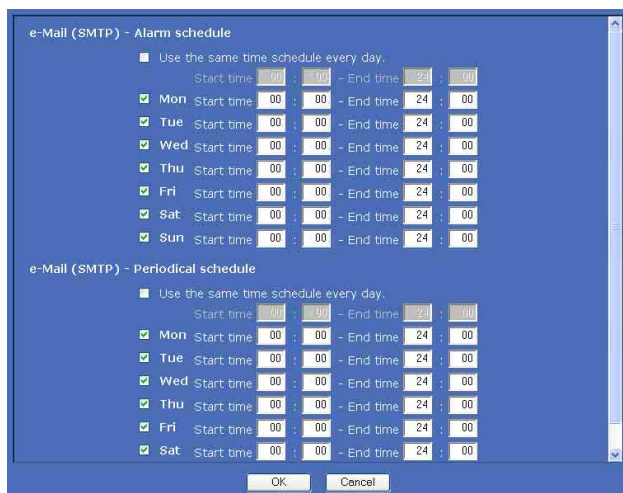

### Use the same time schedule every day

When this item is checked, the same **Start time** and **End time** are applied to all days. In that case, the **Start time** and **End time** of the day from **Mon** (Monday) to **Sun** (Sunday) cannot be input.

### Mon (Monday) to Sun (Sunday)

The time period on the right of the checked day is the effective period of the schedule.

### Start time, End time

Specify the start time and the end time.

### OK/Cancel

See “Buttons common to every menu” on page 28.

# Setting the Alarm Buffer

## — Alarm buffer Menu

When you click **Alarm buffer** in the Administrator menu, the Alarm buffer menu appears.

You can set the Pre-alarm image and audio (the image and audio before the alarm detection) and the Post - alarm image and audio. These can be set when **Alarm sending** of FTP client menu or **Alarm recording** of Image memory menu is set to **On**, besides when **Use alarm buffer** is selected.

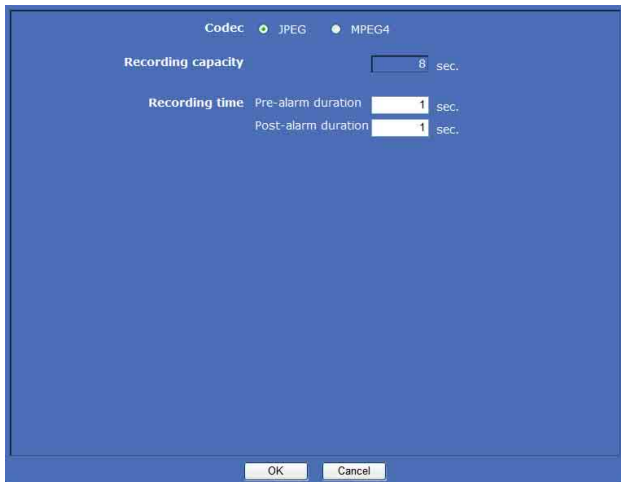

### OK/Cancel

See “Buttons common to every menu” on page 28.

### Codec

Select the video codec to be used for the alarm buffer.

#### Note

When you change the codec, the camera is rebooted.

### Recording capacity

Displays the maximum recording capacity of the alarm buffer in the present camera setting of the cordec, image size, bit rate and frame rate.

### Recording time

Set the recording time for the Pre-alarm image/audio and Post alarm image/audio.

**Pre-alarm duration:** Type the recording duration of the image/audio before alarm detection.

**Post-alarm duration:** Type the recording duration of the image/audio after alarm detection.

#### Note

The value of **Recording capacity** differs depending on the image size and image quality settings in the Camera menu.

# Setting the Motion Detection Function

## — Motion detection Menu

When you click **Motion detection** in the Administrator menu, the Motion detection menu appears.

Using this menu, you can set the conditions for activating the built-in motion detection function. Motion detection detects moving objects in the camera image and outputs an alarm.

**Notes**

- Before actual use, perform an operation test and confirm that the motion detection function works correctly.
- Motion detection is performed with the image before the privacy masking, image cropping and SolidPTZ are performed.
- When image cropping is On, Motion detection menu is not displayed. Disable these functions to perform the Motion detection menu.

### When the Motion detection menu is displayed for the first time

When you click **Motion detection**, “Security Warning” is displayed. When you click **Yes**, ActiveX control is installed and the Motion detection menu is displayed.



**Notes**

- If **Automatic configuration** is enabled in the Local Area Network (LAN) settings of Internet Explorer, the image may not be displayed. In that case, disable **Automatic configuration** and set the Proxy server manually. For the setting of the Proxy server, consult your network administrator.
- When you install ActiveX control, you should be logged in to the computer as Administrator.

- When you are using Windows XP Service Pack 2 or Windows Vista, the information bar or “Security Warning” may appear as you click **Motion detection**. For details, see “Installing ActiveX Control” in “When using Windows XP Service Pack 2” on page 8 or “Installing ActiveX Control” in “When using Windows Vista” on page 10.

## Setting Tab

Use this tab to select motion detection, and set the conditions for detection while observing a camera image.

This is the same menu as that displayed when you click **Detection** on Alarm sending of the e-Mail (SMTP) menu, or on Alarm recording of the Image memory menu.

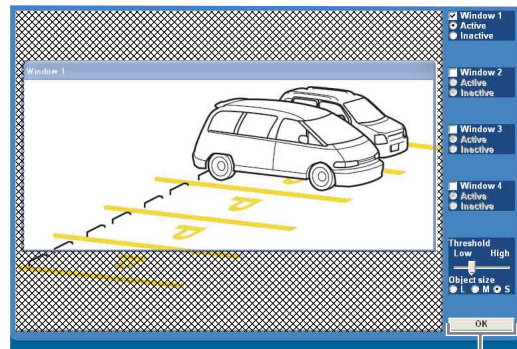

Motion detection setting section

## Setting items for motion detection

### Monitor display

Set the active/inactive window while monitoring a moving image.

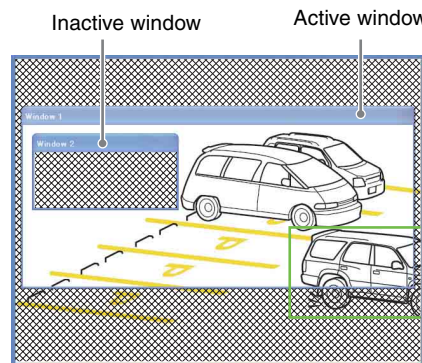

**Notes**

- The image is enlarged or reduced to 640 × 480 (VGA) and displayed on the monitor display if you set any image size in the **Video codec** tab of the camera menu.

- The colors and green frames shown in the monitor display are not displayed on the image files that are sent or recorded linked to the motion detection function.

### Window1 to Window4 check boxes



When you check a check box, the corresponding window (active or inactive window) appears on the monitor display. You can change the position and size of the window.

**Active:** To use the window as an active area in which motion detection is performed.

**Inactive:** To use the window as an inactive area in which any moving object is ignored. Select **Inactive** to set an inactive area inside an active window.

#### Note

You cannot set all four windows as **Inactive** windows. Be sure to set one or more windows as **Active** window(s).

### Threshold setting slider bar



Set the threshold level of motion detection that is common to all the windows.

The threshold level is used to judge whether or not there has been any motion in the camera image. When the motion of an object on the monitor screen has exceeded the threshold level, the camera judges that there has been a motion and a green frame is shown. An alarm is output when a green frame is added to the object displayed in one of the active windows.

### Object size



Select the minimum size of a detectable object from **L** (Large), **M** (Medium) and **S** (Small).

Each option represents the corresponding size below:

- L:** 64 × 64 dots
- M:** 32 × 32 dots
- S:** 16 × 16 dots

#### Tip

The monitor display is 640 × 480 dots. Size **L** is 1/10 the width of the monitor display.

### OK button



Click to send the set values to the camera and confirm the settings.

#### Note

Although the display on the monitor quickly responds to the setting being performed as you change the size of a window or a setting, you need to click the **OK** button to confirm the setting. The setting will be cancelled if you do not click the **OK** button.

### To set the motion detection function

Set the motion detection function as follows:

- 1 Check the **Window 1** check box. The **Window 1** frame appears on the monitor display.
- 2 Adjust the position and size of **Window 1**. Drag **Window 1** to move it and change its size.
- 3 Set the active or inactive windows. Select **Active** to set **Window 1** as an active area, or **Inactive** to set it as an inactive area.

#### Note

If an active window and inactive window overlap, the overlapped portion will be regarded as an inactive area.

When the two windows overlap, the inactive window is displayed over the active window on the monitor screen. If the active window is hidden by an inactive window and its position or size cannot be changed, temporarily change the active window to an inactive window and change the position and size. After changing, reset it as an active window.

- 4 Set the function for **Window 2** to **Window 4**. Repeat steps **1** to **3** for each window.
- 5 Select the object size for **Object size**. Select a larger size if a small noise may be detected as a motion by mistake.
- 6 Adjust the **Threshold** setting slide bar to set the threshold level at which the camera executes detection. Adjust the detection level while observing the monitor screen and actually shooting a moving object.
- 7 Click **OK**. The motion detection settings are confirmed.

**Note**

Be sure to click the **OK** button to confirm the settings. The setting will be cancelled if you do not click the **OK** button.

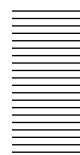

This section explains how to use the application software and commands, including the supplied CD-ROM.

## Using the Supplied IP Setup Program

Explains the functions except those of the Network tab in the IP Setup Program.

To install the IP Setup Program, to assign an IP address and to set the network, see “Assigning the IP Address to the Camera” on page 6 in “Preparation”.

### Notes

- The IP Setup Program may not operate correctly if you use a personal firewall or antivirus software in your computer. In that case, disable the software or assign an IP address to the camera using another method. For example, see “Assigning the IP Address to the Camera Using ARP Commands” on page 91.
- If you are using Windows XP Service Pack 2 or Windows Vista, disable the Windows Firewall function. Otherwise the IP Setup Program will not operate correctly. For the setting, see “Configuring Windows Firewall” in “When using Windows XP Service Pack 2” on page 8 or “Configuring Windows Firewall” in “When using Windows Vista” on page 10.

## Starting the IP Setup Program

Select **Program** from the Start menu of Windows, then select **Program, IP Setup Program** and **IP Setup Program** in sequence.

The IP Setup Program starts.

Network tab appears. The IP Setup Program detects cameras connected to the local network and lists them on the Network tab window.

When you are using Windows Vista, message “User Account Control – An unidentified program wants access to your computer” may appear. In this case, click **Allow**.

## Bandwidth control Tab

You can set the communication bandwidth for the JPEG image.

### Note

The bandwidth cannot be controlled for the **MPEG4** image.

- 1 Click the Bandwidth control tab to display the bandwidth setting window. The current bandwidth is displayed in **Current bandwidth**.

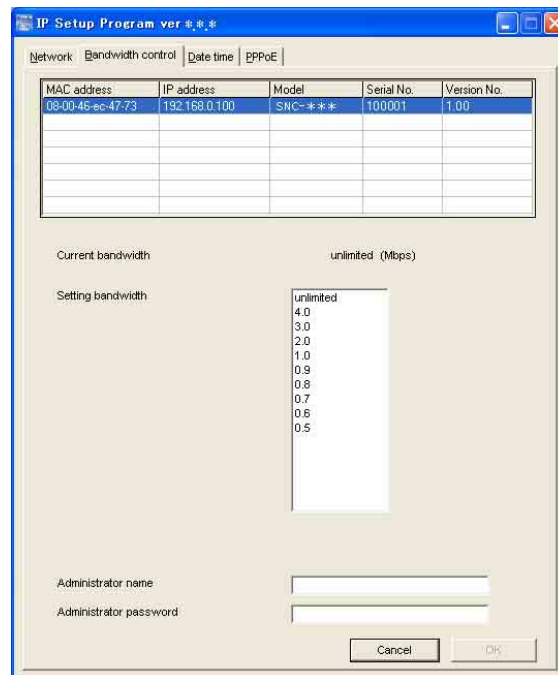

- 2 Click to select the camera to set the bandwidth from the list box.
- 3 Click to select the desired bandwidth from the **Setting bandwidth** list box.
- 4 Type the **Administrator name** and **Administrator password** in each box. The factory settings of both items are “admin.”
- 5 Click **OK**. If “Setting OK” is displayed, the bandwidth setting is completed.

## Date time Tab

You can set the date and time on the camera.

- 1 Click the Date time tab to display the date/time setting window.

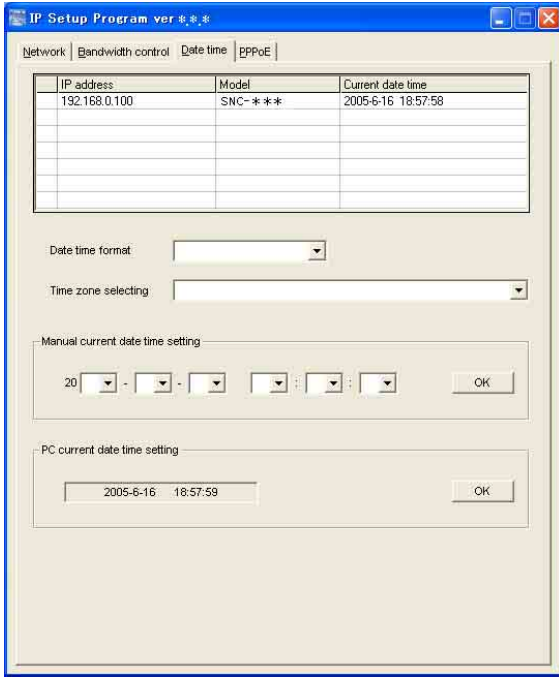

- 2 Click to select the camera that you want to set the date and time for.

You can select multiple cameras and set the date and time simultaneously.

- 3 Select the date/time format from the **Date time format** drop-down list.
- 4 Select the area where the camera is installed from the **Time zone selecting** drop-down list.
- 5 Set the date and time.

You can set the date and time in two ways.

### Manual current date time setting

Set the current date and time on the **Manual current date time setting** boxes, and click **OK**. The setting boxes are for the year (last two digits), month, date, hour, minutes and seconds from left to right.

### PC current date time setting

The date and time set on the computer is displayed in the **PC current date time setting** box. Click **OK** on the right to set the camera's date and time to coincide with the displayed computer's date and time.

## Note

Due to network properties, there may be a slight difference between the displayed computer's date and time and those set on the camera.

## Rebooting the Camera

Click **Reboot** on the Network tab to reboot the camera. It will take about two minutes to start again.

---

# Using the SNC audio upload tool — Transmitting Audio to Camera

The supplied SNC audio upload tool allows you to transmit sound from the computer to the camera. This section explains the setup and operations of the SNC audio upload tool.

The SNC audio upload tool supports the following audio data to be transmitted.

Audio CODEC	Transmission rate
G711 ( $\mu$ -LAW)	64 kbps
G.726	40 kbps
G.726	32 kbps
G.726	24 kbps
G.726	16 kbps

## Note

Only one user can transmit sound to the camera. Meanwhile, another user will not be able to transmit sound to the camera.

---

## Installing the SNC audio upload tool

- 1 Insert the CD-ROM in your CD-ROM drive. A cover page appears automatically in your Web browser. If it does not appear automatically in the Web browser, double-click on the index.htm file on the CD-ROM.

When you are using Windows Vista, pop-up “AutoPlay” may appear. For details, “Installing software” in “When using Windows Vista” on page 10.

- 2 Click the **Setup** icon of **SNC audio upload tool**. The “File Download” dialog opens.

When you are using Windows XP Service Pack 2 or Windows Vista, a message regarding the active contents may appear. For details, see “Installing software” in “When using Windows XP Service Pack 2” on page 8 or “Installing software” in “When using Windows Vista” on page 10.

- 3 Click **Open**.

## Note

If you click “Save this program to disk” on the “File Download” dialog, you cannot install the tool correctly. Delete the downloaded file, and click the **Setup** icon again.

- 4 Install the SNC audio upload tool following the wizard displayed. If the Software License Agreement is displayed, read it carefully and accept the agreement to continue with the installation.

---

## Connecting the Camera to the Computer

- 1 Connect a speaker to the line output jack on the camera.
- 2 Connect a microphone to the microphone input jack on the computer.

## Note

If the microphone input jack of the computer is not set correctly, no sound is transmitted from the computer and nothing is output from the speaker connected to the camera. Set the microphone input jack from the control panel of Windows.

## On Windows XP

- 1 Select **Sounds and Audio Device** from Control Panel.
- 2 Click **Volume** in the **Sound Recording** section on the Audio tab. The Recording Control window opens.
- 3 Check **Select** in the **Microphone** section.

## On Windows Vista

There are no settings regarding the microphone jack. If recording cannot be made, connect a microphone device to the computer and check that the recording device operates correctly, as follows.

- 1 Select **Sound** from Control Panel.
- 2 Open the Recording tab and check that Windows has recognized the hardware correctly.

---

## Using the SNC audio upload tool

When you start the SNC audio upload tool, the Setting tab is displayed.



## Setting tab

Use this menu to set the camera to transmit audio from a computer or upload an audio file.

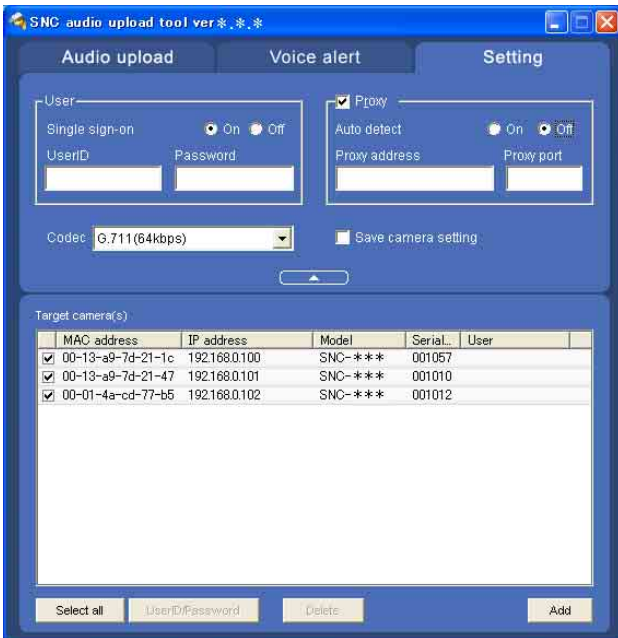

### User

Set the **User ID** and **Password** for the administrator. The factory setting of the User ID for the Administrator is “admin,” and the Password is “admin.”

**Single sign-on:** Select **On** to use the same user ID and same password for all the cameras. Select **Off** to set the user ID and password individually for each camera.

For the setting with **Off**, see “User ID/Password” on page 82.

**User ID:** This item can be set when **Single sign-on** is set to **On**. The user ID specified here is applicable to all cameras.

**Password:** This item can be set when **Single sign-on** is set to **On**. The administrator password specified here is applicable to all cameras.

### Proxy

Check this box when you use a proxy server for communications. When it is not checked, direct communications with the camera is performed.

**Auto detect:** Select **On** to obtain the proxy setting automatically from Internet Explorer.

**Proxy address:** Type the IP address or host name of the proxy server.

**Proxy port:** Type the port number used for communications with the proxy server.

### Note

The Proxy setting is applicable to all cameras. You cannot use individual proxy settings for each camera.

### Codec

Select the audio mode (Codec) from the drop-down list.

### Save camera setting

Check this box to store the current settings and camera list in the Setting tab. The same settings will be recalled when the camera is rebooted.



Click this button to hide the camera list. Click it again to display the camera list.

### Target camera(s) (Camera list)

When the SNC audio upload tool starts, it automatically detects Sony network cameras connected to the local network and displays them in the camera list. Up to 256 cameras can be displayed in the list.

Select the check box on the left of the row to enable audio transmission and audio file uploading for that camera. You can then enable these functions simultaneously for multiple cameras.

### Notes

- If you are using Windows XP Service Pack 2 or Windows Vista, disable the Windows Firewall function. Otherwise the camera list may not be displayed automatically. For details, see “Configuring Windows Firewall” in “When using Windows XP Service Pack 2” on page 8 or “Configuring Windows Firewall” in “When using Windows Vista” on page 10.
- The SNC audio upload tool cannot detect the cameras that are connected to the local network after the program has started.
- The SNC audio upload tool cannot detect the network cameras that are not equipped with the audio feature.

**Camera select checkbox:** The check box is located on the left end of the row. Select this check box to enable audio transmission and audio file uploading for that camera.

**MAC address:** Displays the MAC address of the network camera.

**IP address:** Displays the IP address of the network camera. “DHCP” is shown at the end of the IP address when the IP address is obtained with a DHCP server.

**Model:** Displays the model name of the network camera.

**Serial:** Displays the serial number of the network camera.

**User:** Displays the specified user ID and password. The password is shown with turned letters.

### Select all

Click to select all the cameras in the camera list. This is usable when you delete all the cameras from the list or specify the same user ID and password for all the cameras,

### User ID/Password

Use this item when you specify the user ID and password to communicate with the selected camera(s) only.

Select the camera(s) from the camera list and click this button, and the following dialog opens.

Type the user ID and password for the administrator and click **OK**.



### Note

If you select multiple cameras from the camera list, the same user ID and password are set for all the selected cameras. The factory settings of both items are “admin.”

### Add

Use this item when you add a new network camera to the camera list manually. Click this button, and the following dialog opens.

Type the IP address and port number for the camera to be added and click **OK**.

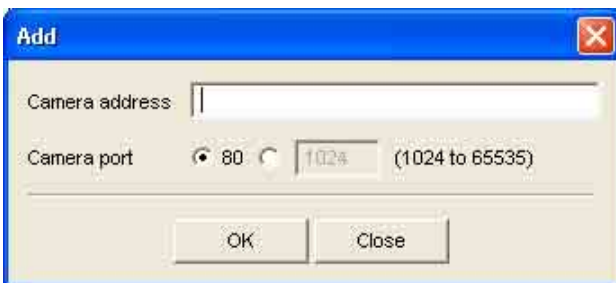

### Notes

- An error dialog appears if the specified IP address already exists in the camera list, is assigned for a device other than the network camera, or does not exist in the network.
- You cannot add new cameras if the maximum of 256 cameras has been displayed in the camera list.

### Delete

Click this button to delete the selected camera(s) from the camera list.

### Note on switching the tab

If an error occurs when you switch from the Setting tab to the Audio upload tab or the Voice alert tab, the camera is shown in red. In this case, check the camera settings and the user ID and password settings.

### Audio upload tab

Use this menu to transmit audio from the computer to the camera. You can transmit audio to multiple cameras displayed in the camera list simultaneously.

Before transmitting, set **Audio upload** to **Enable** on the Common tab of the Camera menu.

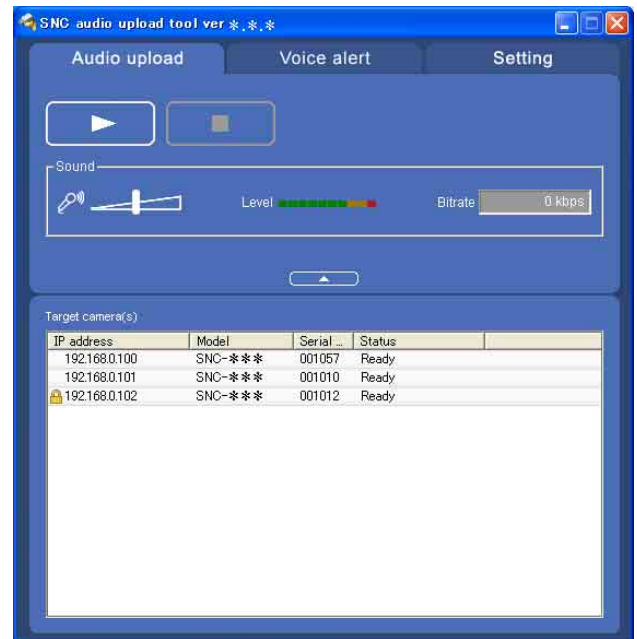

### ▶ (start) / ■ (stop)

Click ▶ (start) to start audio transmission. The transmission speed is displayed in the Bitrate box during transmission. You can adjust the microphone volume level and enable/disable the muting, if necessary. To stop the audio transmission, click ■ (stop).

## Notes

- Audio transmission stops if you switch the tab during the transmission.
- Audio may be interrupted when the IP address is changed if **Obtain an IP address automatically (DHCP)** is set on **IP address** in the Network menu.
- Audio may be interrupted if you transmit it to many cameras simultaneously.

## Sound adjustment and indicators

Adjust the microphone input volume by moving the  slider bar. You can adjust the volume even during transmission.

Click  to enable/disable sound muting. The microphone input volume is displayed at the Level. The transmission rate is displayed in the Bitrate box.



Click this button to hide the camera list. Click it again to display the camera list.

## Target camera(s) (Camera list)

Displays the cameras selected with the camera select checkbox of the camera list in the Setting tab.

The list shows the information and status of the selected cameras.

**IP address:** Displays the IP address of the network camera. “DHCP” is shown at the end of the IP address when the IP address is obtained with a DHCP server.

### Tip

During SSL communication,  appears on the left side of the IP address.

This camera does not support the SSL function.

**Model:** Displays the model name of the network camera.

**Serial:** Displays the serial number of the network camera.

**Status:** Displays the current status of the camera.

**Ready:** The camera is ready for connection.

**Connected:** The camera connection is successful.

**Fault:** The camera connection is unsuccessful.

**Sending:** Audio data being transmitted

## Voice alert tab

Use this menu to record the sound through the microphone connected to the computer and upload the recorded audio file to the camera. You can upload the audio file to multiple cameras selected from the camera list simultaneously.

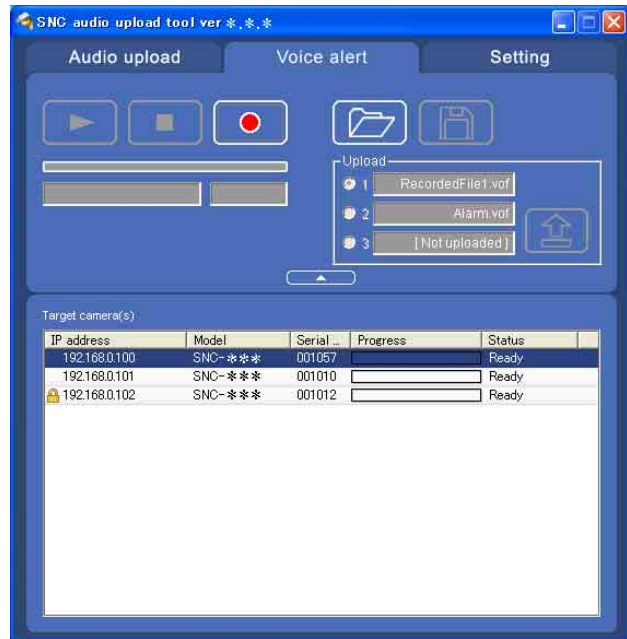

## (playback)

To start playback, open the recorded file or another audio file and click this icon.

You can check the recorded sound or the contents of the selected audio file. During playback, the progress bar shows playback progress.

## (stop)

Click to stop recording or playback.

When you click it during recording, recording stops, and you can review the recorded sound or upload the recording to the camera.

When you click it during playback, playback stops and the progress bar display returns to the start position.

## (recording)

Click to start recording of the sound input to the computer microphone. The maximum recording time is 30 seconds.

The codec specified in the Setting tab is used for the recording.

The recorded file is displayed as “RecordedFile.vof.”

## Notes

- Recording or playback stops if you switch the tab during recording or playback.
- The recorded file is not stored in the computer.

## Recording/playback progress bar

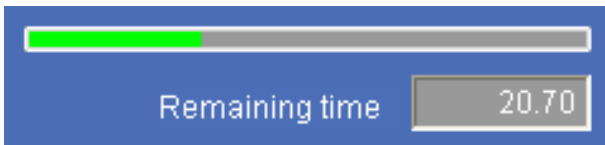

You can check recording or playback progress with this bar.

During recording, the right end of the bar represents 30 seconds and the remaining recording time is displayed below the bar.

During playback, the maximum time of the bar depends on the recorded time.

### (file open)

Click to select a previously saved audio file. You can play the selected audio file or upload it to the camera.

### (save)

Click to save the recorded audio file to the computer.

## Voice alert number select



Specify the voice alert number to which you want to upload the audio file. For example, select **1** when uploading to voice alert 1.

The name of the uploaded audio file is displayed to the right of the number.

“Not uploaded” is displayed if no audio file is uploaded to the camera.

The audio file name will be “RecordedFile” + “Voice alert number” + “.vof” if you upload an audio file recorded using  and not stored in the computer.

### Notes

- The voice alert number select is disabled if the camera specified in the Setting tab has old-version software.
- The audio file name for the camera selected in the camera list is displayed here. To check the uploaded file name, click on the camera in the camera list.
- The audio file is uploaded to the same voice alert number on all the cameras in the camera list. If the camera has old-version software, the audio file is automatically uploaded to voice alert number 1.

### (upload)

Click to upload the recorded or selected audio file to the camera specified in the Setting tab. Only one audio file can be uploaded to the camera at a time.

### Note

Uploading a new audio file overwrites the audio file previously uploaded to the camera.



Click this button to hide the camera list. Click it again to display the camera list.

## Target camera(s) (Camera list)

Displays the cameras selected with the camera select checkbox of the camera list in the Setting tab.

The list shows the information and status of the selected cameras.

**IP address:** Displays the IP address of the network camera. “DHCP” is shown at the end of the IP address when the IP address is obtained with a DHCP server.

### Tip

During SSL communication,  appears on the left side of the IP address.

This camera does not support SSL function.

**Model:** Displays the model name of the network camera.

**Serial:** Displays the serial number of the network camera.

**Progress:** Displays the progress of audio file transmission.

**Status:** Displays the current status of the camera.

**Ready:** The camera is ready for connection.

**Inquiry:** The camera information is being asked for.

**No func:** The camera does not support the Voice alert function.

**Uploading:** The audio file is being uploaded.

**Fault:** The audio file uploading is unsuccessful.



**No Privilege:** The camera is not authorized to upload audio files.

**Succeeded:** The audio file uploading is successful.



## Uploading the recorded audio file to the camera

### Tip



Before operating, create an audio file and set the camera for audio uploading. Set the camera using the Setting tab.

- 1 Click  (recording) in the Voice alert tab to start recording.
- 2 Click  (stop) to stop recording. Recording will stop automatically in 30 seconds.
- 3 Select the voice alert number.
- 4 Click  (upload) to transmit the audio file to the camera.

### Saving the recorded audio file to the computer

- 1 Click  (recording) in the Voice alert tab to start recording.
- 2 Click  (stop) to stop recording. Recording will stop automatically in 30 seconds.
- 3 Click  (save). The **Save as** dialog appears. Type the file name and save it.

### Uploading the saved audio file to the camera

- 1 Click  (file open) in the Voice alert tab and select the audio file to be uploaded.
- 2 Select the voice alert number.
- 3 Click  (upload) to transmit the audio file to the camera.

---

## Using the SNC video player — Playing Video/Audio File Recorded with Camera

The supplied SNC video player allows you to play video/audio data recorded with the camera on your computer.

This section explains the setup and operations of the SNC video player.

---

### Installing the SNC video player

- 1 Insert the CD-ROM in your CD-ROM drive. A cover page appears automatically in your Web browser. If it does not appear automatically in the Web browser, double-click on the index.htm file on the CD-ROM.

When you are using Windows Vista, pop-up “AutoPlay” may appear. For details, “Installing software” in “When using Windows Vista” on page 10.

- 2 Click the **Setup** icon of **SNC video player**. The “File Download” dialog opens.

When you are using Windows XP Service Pack 2 or Windows Vista, a message regarding the active contents may appear. For details, see “Installing software” in “When using Windows XP Service Pack 2” on page 8 or “Installing software” in “When using Windows Vista” on page 10.

- 3 Click **Open**.

#### Note

If you click “Save this program to disk” on the “File Download” dialog, you cannot install the player correctly.

Delete the downloaded file, and click the **Setup** icon again.

- 4 Install the SNC video player following the wizard displayed. If the Software License Agreement is displayed, read it carefully and accept the agreement to continue installation.

# Using the SNC video player

1 Start the SNC video player.



2 Click the  (browse) icon. The Select File dialog opens.

3 Select the file you want to play. Click  on the top of the screen, and file information dialog appears.

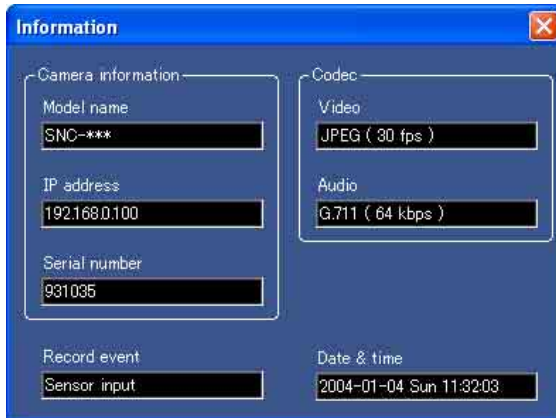

## File dialog

**Model name:** Model name of the camera with which the file is recorded.

**IP address:** IP address of the camera with which the file is recorded.

**Serial number:** Serial number of the camera with which the file is recorded.

**Video:** Video Codec

**Audio:** Audio Codec

**Record event:** Type of event used for the recording: **Sensor input** or **Motion detection**.

**Date&time:** Recording date and time

## Playing a video/audio file

Click  (start) to start playing from the beginning of the selected file.

To freeze the movie temporarily, click  (pause).

Click  again to restart playing from the frozen point.

To stop playing, click  (stop).

To restart playing from the beginning, click  (start) again.

Play stops when the file is played to the end.

## Playing from a specified point

Move the slide bar below the image display, and playback will start from the position of the slide bar.

## Adjusting the sound

Adjust the playing sound volume by moving the  slide bar. Move it to the left end for the minimum volume, and to the right end for the maximum volume.





Click  (speaker) to enable/disable the sound muting.

When sound muting is on, no sound is heard even if you move the slide bar.

## Saving an image

Click  (capture) icon during playing or pause and the captured image is displayed in a pop-up dialog. To save the image, click **Save** on the dialog. You can specify the destination to which the image is to be stored and select the JPEG or Bitmap format.

## Changing the view size

Click , , ,  to change the view size. The monitor is displayed by the view size as you selected.

When you click , the original size of image is displayed.

 **2** is available only for 640 × 480 (VGA) size or less.

The selected view size button flips.

# Using the SNC privacy masking tool — Masking a Camera Image

The supplied SNC privacy masking tool allows you to mask parts of the camera image to be transmitted.

## Installing the SNC privacy masking tool

- 1 Insert the CD-ROM in your CD-ROM drive. A cover page appears automatically in your Web browser. If it does not appear automatically in the Web browser, double-click on the index.htm file on the CD-ROM.

When you are using Windows Vista, pop-up “AutoPlay” may appear. For details, “Installing software” in “When using Windows Vista” on page 10.

- 2 Click the **Setup** icon of **SNC privacy masking tool**. The “File Download” dialog opens.

When you are using Windows XP Service Pack 2 or Windows Vista, a message regarding the active contents may appear. For details, see “Installing software” in “When using Windows XP Service Pack 2” on page 8 or “Installing software” in “When using Windows Vista” on page 10.

- 3 Click Open.

### Note

If you click “Save this program to disk” on the “File Download” dialog, you cannot install the program correctly. Delete the downloaded file, and click the **Setup** icon again.

- 4 Install the SNC privacy masking tool following the wizard displayed. If the Software License Agreement is displayed, read it carefully and accept the agreement to continue installation.

## Using the SNC privacy masking tool

The SNC privacy masking tool consists of the Main tab to set the privacy mask positions and the Setting tab to prepare for connection to the camera.

When you start the SNC privacy masking tool, the Setting tab is displayed.

### Setting tab

Before creating a privacy mask, set the following items in the Setting tab to allow connection to the camera.

The screenshot shows the 'Setting' tab of the SNC privacy masking tool. The fields are filled with the following values: Administrator name: admin; Administrator password: \*\*\*\*\*; Camera address: 192.168.0.100; Camera port No.: 80. The Proxy setting section is currently inactive as the 'Use proxy' checkbox is unchecked.

**Administrator name:** Type the ID of the administrator of the camera to be connected.

**Administrator password:** Type the password of the administrator of the camera to be connected.

### Tip

The factory settings of both items are “admin.”

**Camera address:** Type the IP address or host name of the camera to be connected.

**Camera port No.:** Type the port number of the camera to be connected.

When you use a proxy server for camera connection, check the Use proxy check box and set the following items.

**Proxy server address:** Type the IP address or host name of the proxy server.

Others

**Proxy server port No.:** Type the port number of the proxy server.

Preparations for connecting to the camera are now completed.

#### Note

Privacy masking cannot be set when the followings are set:

- **Video output mode** (page 33) is **NTSC+IP** or **PAL+IP**.
- **Iris open** (page 33) is **On**.
- **SolidPTZ** (page 23) is **On**.

## Main tab

Set the privacy mask.



### Viewer

A live image of the camera is displayed. You can specify the position of the privacy mask in this area.

### Numbers

Displays the numbers of the privacy masks that have been set on the viewer.

### Rectangles

Displays the frames of the privacy masks that have been set. This is useful when the masks overlap.

### Privacy mask setting section (No.1 to No.7)

Allows you to set, call or delete the privacy mask.

You can set up to seven privacy masks and the mask color.

**Set:** Register the area specified on the viewer as a privacy mask area.

Click **Set** and the portion of the viewer image is masked with the privacy mask. The color of the privacy mask is that selected with the **Color** drop-down list.

#### Note

Do not change the camera setting during starting the SNC privacy masking tool.

**Clear:** Click to delete the privacy mask.

### Color

Specify the color of privacy masks. The color is common to every privacy mask.

The selectable colors are as follows:

**Black, White, Gray, Red, Green, Blue, Cyan, Yellow, Magenta**

### All clear

Click to delete all the privacy masks simultaneously.

## Setting a privacy mask

To set a privacy mask in a favorite position, operate as follows:

- 1 Specify the privacy mask area by dragging the mouse in the Main tab viewer.
- 2 Select the color of the mask from the **Color** drop-down list.
- 3 Select the desired privacy mask number in the privacy mask setting section and click **Set** of the corresponding number.  
The mask is displayed on the viewer.

#### Note

The color is common to every privacy mask. The color last selected is applied.

#### Notes

- The masking area is quite different from the masking color, and the displayed image may be blurred.
- When you set the privacy masking function, the image frame rate may be reduced.



# Using the Custom Homepage Installer

The supplied Custom Homepage Installer allows you to store the homepage that you have created in the camera and watch it.

## Notes on creating the homepage

When you are creating the homepage, note the following points.

- The file name should be typed using up to 24 characters including the extension.
- The file size of the homepage should be 2.0 MB or less.
- To see the created homepage, set the **Homepage** in the System menu.

## Uploading the homepage to the camera using the Custom Homepage Installer

- 1 Insert the CD-ROM in your CD-ROM drive. A cover page appears automatically in your Web browser. If it does not appear automatically in the Web browser, double-click on the index.htm file on the CD-ROM.

When you are using Windows Vista, pop-up “AutoPlay” may appear. For details, “Installing software” in “When using Windows Vista” on page 10.

- 2 Click the **Start** icon of **Custom Homepage Installer**.

The “File Download” dialog opens.

When you are using Windows XP Service Pack 2 or Windows Vista, a message regarding the active contents may appear. For details, see “Installing software” in “When using Windows XP Service Pack 2” on page 8 or “Installing software” in “When using Windows Vista” on page 10.

- 3 Click **Open**. The installer starts and notes are displayed.

When you are using Windows Vista, message “User Account Control – An unidentified program wants access to your computer” may appear. In this case, click **Allow**.

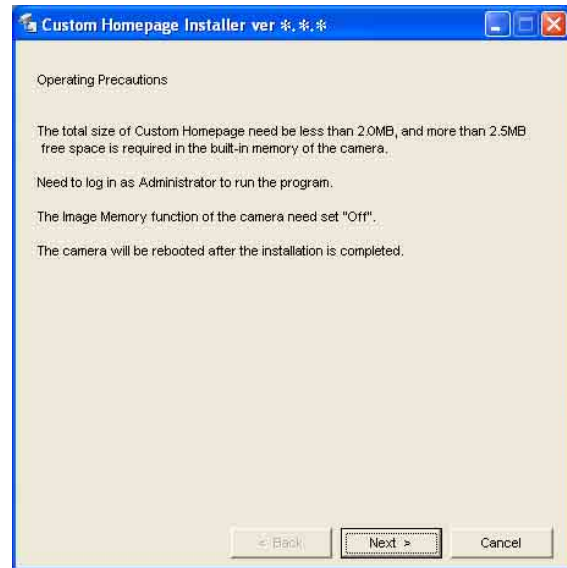

### Note

If you click “Save this program to disk” on the “File Download” dialog, the CustomHomepageInstaller.exe file will be saved on the computer. Double-click the saved file to start it.

- 4 Read the notes carefully, and click **Next**. The Software License Agreement is displayed.

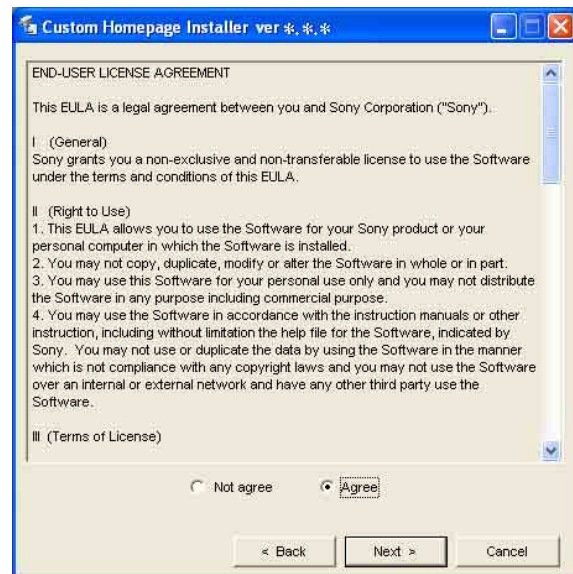

- 5 Read the agreement carefully, select **Agree** if you accept it, then click **Next**.

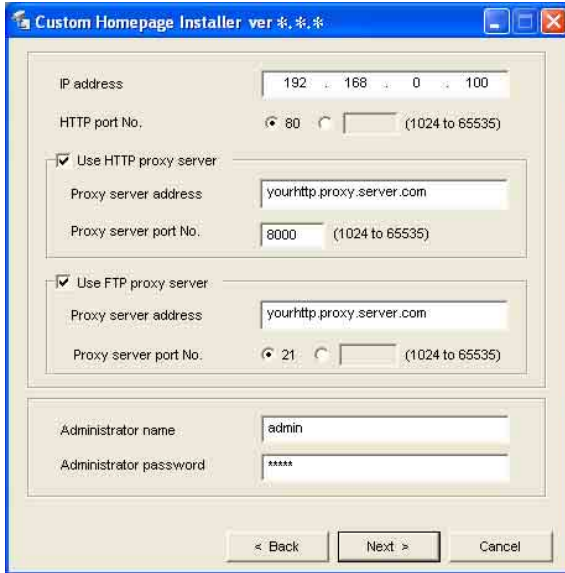

- 6 Type the IP address of the camera to be uploaded in the IP address box.

- 7 Specify the HTTP port No. of the camera. Initial HTTP port No. is set to 80.

- 8 When you use a proxy server, set the following: For the proxy server of your environments, consult your network administrator.

**When using an HTTP proxy server:**

Select **Use HTTP proxy server**, and type your settings in the Proxy server address and Proxy server port No. boxes.

**When using an FTP proxy server:**

Select **Use FTP proxy server**, and type your settings in the Proxy server address and Proxy server port No. boxes.

**Note**

If you cannot establish communications with the camera using the proxy server being used, connect the camera to the local network and run the installer without using the proxy server.

- 9 Type the Administrator name and Administrator password of the camera to be uploaded. The factory settings of both items are “admin.”

- 10 Confirm that all items are correct, then type the path of the folder you saved the homepage in the Source folder or click to specify the folder. Click **Next>** to continue.

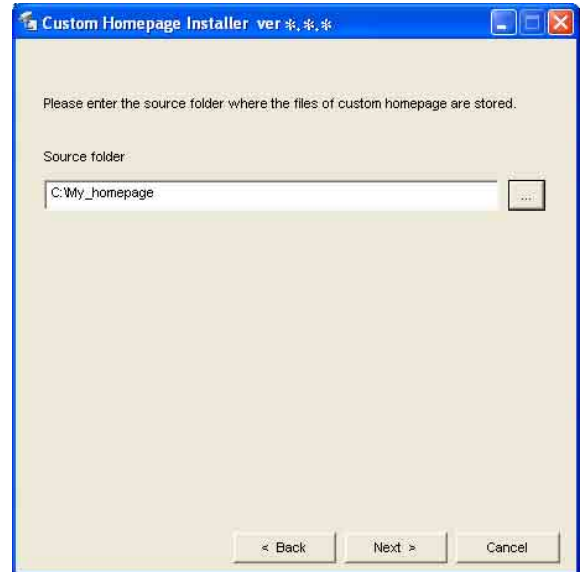

- 11 Type the path for the folder in which your homepage is stored in the Source folder box, then click **Next**.

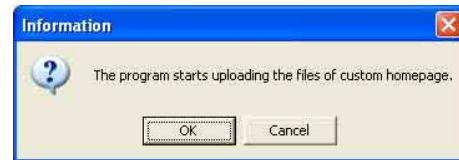

- 12 Click **OK**. Uploading of the homepage file starts.

**Note**

Do not turn off the camera until the camera is rebooted after uploading the homepage file.

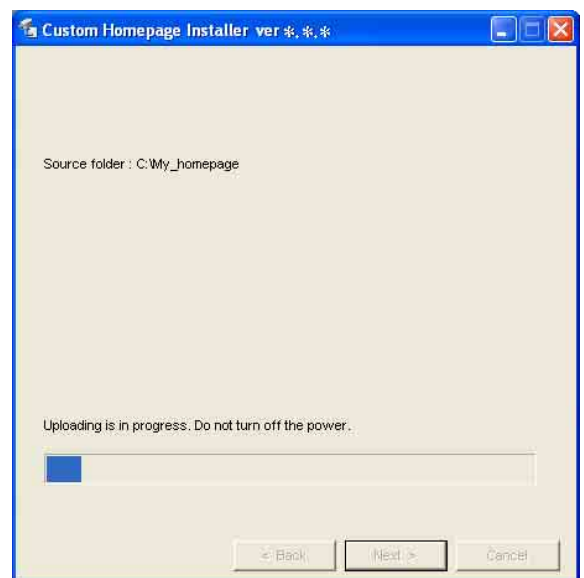

The following page will appear after a while.

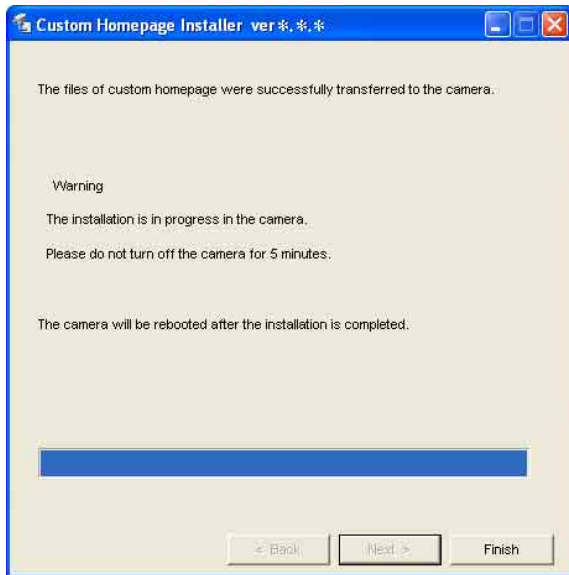

After displaying this page, the camera will be adjusted and rebooted automatically in five minutes.

- 13 Click **Finish** to exit the program.

## Assigning the IP Address to the Camera Using ARP Commands

This section explains how to assign an IP address to the camera using ARP (Address Resolution Protocol) commands without using the supplied IP Setup Program.

### Note

When you turn on the camera, execute the ARP and PING commands within 5 minutes. Also when you restart the camera, execute the operation within 5 minutes.

- 1 Open the command prompt on the computer.
- 2 Enter the IP address and the MAC address of the camera to assign a new IP address, using the following ARP commands.

```
arp -s <Camera's IP address> <Camera's MAC address>
ping -t <Camera's IP address>
```

Example:

```
arp -s 192.168.0.100 08-00-46-21-00-00
ping -t 192.168.0.100
```

- 3 When the following line is displayed on the command prompt, hold down **Ctrl** and press **C**. The display stops.

```
Reply from 192.168.0.100:bytes=32 time...
```

You will normally receive a reply after about 5 repetitions of “Request time out.”

- 4 Wait until the execution of PING finishes, then input the following code.

```
arp -d 192.168.0.100
```

### Note

If you do not receive a reply, check the following:

- Did you enter the ARP commands within 5 minutes after it was turned on?  
If not, turn off the camera and restart the operation.
- Is the NETWORK indicator on the camera flashing?  
If the indicator goes off, the network connection has a problem. Connect the network correctly.
- Did you enter the IP address previously used for another device?  
Assign a new IP address to the camera.
- Do the computer and the camera have the same network address?  
If not, set the same network address on the computer and the camera.

# Using the SNMP

This unit supports SNMP (Simple Network Management Protocol). You can read MIB-2 objects using software such as SNMP manager software. This unit also supports the coldStart trap which occurs when the power is turned on or the unit restarts, and the Authentication failure trap which informs of an illegal access using SNMP.

Using CGI commands, you can set community name and access limitation, host to send traps, and some MIB-2 objects. To allow these settings, you need authentication by the camera administrator.

## 1. Inquiry Commands

You can check the SNMP Agent settings using the following CGI commands.

```
<Method>
  GET, POST
<Command>

  http://ip_adr/snmpdconf/inquiry.cgi?inqjs=snmp
  (JavaScript parameter format)

  http://ip_adr/snmpdconf/inquiry.cgi?inq=snmp
  (standard format)
```

With the above inquiry, you can obtain the following setting information. The following explains the setting information using the inqjs=snmp (JavaScript parameter) format.

### With SNC-DM160

```
var sysDescr="SNC-DM160"           ...①
var sysObjectID="1.3.6.1.4.1.122.8501" ...②
var sysLocation=""                ...③
var sysContact=""                 ...④
var sysName=""                    ...⑤
var snmpEnableAuthenTraps="1"     ...⑥
var community="public,0.0.0.0,read,1" ...⑦
var community="private,192.168.0.101,read,2" ...⑧
var trap="public,192.168.0.101.1" ...⑨
```

- ① describes the case of “mib-2.system.sysDescr.0”. You cannot change this parameter.
- ② describes the case of “mib-2.system.sysObjectID.0”. You cannot change this parameter.
- ③ describes the case of “mib-2.system.sysLocation.0”. This field is used to describe information on the location of this camera. Nothing is set at the factory.

- ④ describes the case of “mib-2.system.sysContact.0”. This field is used to describe the information on administrator of this camera. Nothing is set at the factory.
- ⑤ describes the case of “mib-2.system.sysName.0”. This field is used to describe administration node of this camera. Nothing is set at the factory.
- ⑥ describes the case of “mib-2.snmpEnableAuthenTraps.0”. This example shows when “1” (enable) is set. With this setting, a trap occurs when there is an Authentication failure. When “2” (disable) is set, no Authentication failure trap occurs.
- ⑦ describes the community attributes. This example shows the identification number “ID=1”, the community name “public”, and enables “read” from any IP address (0.0.0.0).
- ⑧ describes the community attributes, similarly to ⑦. This example shows the identification number “ID=2”, the community name “private”, and enables “read” by the SNMP request packet from the host “192.168.0.101”.
- ⑨ describes the attributes to send a trap. This example shows the identification number “ID=1”, the community name “public”, and enables sending of traps to the host having the IP address “192.168.0.101”.

## 2. Setting Commands

The unit supports the following setting commands of SNMP.

```
<Method>
  GET, POST
<Command>

  http://ip_adr/snmpdconf/snmpdconf.cgi?
  <parameter>=<value>&<parameter>=...&...
```

First, perform the settings of the following parameters.

- 1) sysLocation=<string>  
Set the case of “mib-2.system.sysLocation.0” in the <string> position. The maximum length of <string> is 255 characters.
- 2) sysContact=<string>  
Set the case of “mib-2.system.sysContact.0” in the <string> position. The maximum length of <string> is 255 characters.

- 3) sysName=<string>  
Set the case of “mib-2.system.sysName.0” in the <string> position. The maximum length of <string> is 255 characters.
- 4) enaAuthTraps=<value>  
Set the case value of “mib-2.snmp.snmp EnableAuthenTraps.0” in the <string> position. Type “1” (enable) or “2” (disable) in the <value> position.
- 5) community=<ID>,r,<communityName>,<IpAddressString>  
Set the community attributes. <ID> describes the setting identification number (1 to 8) <communityName> describes the community name to be set, and <IpAddressString> describes the IP address of the host you allow access (0.0.0.0 for any host).

**Example:** To allow reading by any host in the “private” community and having the ID number “2”.  
community=2,r,private,0.0.0.0

- 6) trap=<ID>,<communityName>,<IpAddressString>  
Set the attributes send traps to. <ID> describes the setting identification number (1 to 8), <communityName> describes the community name to send traps to, and <IpAddressString> describes the IP address of the host to send traps to.

**Example:** To specify the destination of traps as the public community and the ID number “1”.  
trap=1,public,192.168.0.101

- 7) delcommunity=<ID>  
This parameter is used to delete the previous community setting. <ID> describes the community setting identification number (1 to 8).
- 8) deltrap=<ID>  
This parameter is used to delete the previous setting of the host to send traps to. <ID> describes the trap setting identification number (1 to 8).

When you have finished changing the SNMP setting information using the above parameters 1) to 8), check the changed settings using an inquiry commands. If the changed settings are OK, restart the SNMP using the following CGI command.

### SNMP restart command

<Method>

GET, POST

<Command>

```
http://ip_adr/snmpdconf/snmpdconf.cgi?
snmpd=restart
```

# Specifications

## Network

Protocol

TCP/IP, ARP, ICMP, HTTP,  
FTP(server/client), SMTP (client),  
DHCP (client), DNS (client), NTP  
(client), SNMP (MIB-2), RTP/  
RTCP

## Compression

Video compression format

JPEG/MPEG4

Audio compression format

G.711/G.726 (40, 32, 24, 16 kbps)

Image size

SNC-DM110 / DM160 / CM120

JPEG only:

1280 × 960 (Quad-VGA)

960 × 720

768 × 576

JPEG / MPEG4:

640 × 480 (VGA)

384 × 288

320 × 240 (QVGA)

SNC-DS10 / DS60 / CS20

JPEG only:

768 × 576

JPEG / MPEG4:

640 × 480 (VGA)

384 × 288

320 × 240 (QVGA)

Maximum frame rate

30 fps

Maximum user access

10 users

Network security

Password (basic authentication)

IP filtering

Homepage customization

Homepage starts up in the built-in flash  
memory.

Other functions

Motion detection

SolidPTZ (SNC-DM110 / DM160 /  
CM120 only)

Light funnel (SNC-DM110 / DM160 /  
CM120 only)

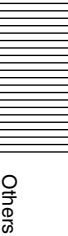

Others

---

# Glossary

## ActiveX control

A component program object that can be used with web pages or other application programs. The technology for creating ActiveX control is part of software developed by Microsoft.

## ARP commands

The commands for checking the entry of the IP address and MAC address in a host computer, or for updating them.

## Bandwidth control

To limit the amount of transmitted data.

## Bit rate

The rate at which data bits are transmitted.

## CA (Certificate Authority)

A private authority that issues and controls digital certificates to be used for authentication regarding network access.

## Capture

To display the audio and video digital data from the video equipment on a computer.

## Codec

Software/hardware for coding/decoding video and audio data.

## Contrast

The difference in tone between the lightest and darkest portions of the image.

## Default gateway

Device that can be used to access the other network.

## DHCP server

Abbreviation for Dynamic Host Configuration Protocol server. The IP address of a terminal without an individual IP address can be automatically distributed by the Dynamic Host Configuration Protocol (DHCP). The DHCP server assigns the IP addresses to the terminals.

## Digital certificate

An electronic certificate that a CA (Certificate Authority) attests that a public key to cancel a secret code is issued by an authentic publisher.

## Digital zoom

Zooming in/out function of an image without using an optical zooming function.

## DNS server

Abbreviation for Domain Name System server. As an IP address required for connecting to the device on an IP network is numerical and difficult to remember, the Domain Name System was established. A domain name is alphabetic and is easier to remember. When a client computer uses a domain name to connect to another computer, it asks a DNS server to translate the name into the corresponding IP address. Then the client computer can obtain the IP address of the computer to be connected.

## EAP method

Abbreviation for Extensible Authentication Protocol. This is a protocol extended from PPP (Point-to-Point Protocol) and having an authentication function.

## EAP-TLS authentication

TLS is an authentication protocol of the EAP methods using Transport Layer Security. By using digital certificates and other methods, EAP-TLS prevents data falsification, eavesdropping and spoofing.

## Frame rate

The number of frames of a moving image that can be transmitted per a second.

## FTP client

Software or function to be used for accessing the FTP server.

## FTP server

A server to be used to transfer files via a network.

## HTTP port

A port used to communicate between the web server and the web client such as a web browser.

## Hunting

Unstable brightness due to a periodical change in controlled variable during a motion control function. In the auto day/night function, for example, the amount of light to be taken into the camera changes. With day/night switching the camera goes and returns from day to night mode quickly.

## **IP address**

Abbreviation for Internet Protocol Address. An individual IP address is basically assigned to each piece of equipment connected to the Internet.

## **Java applet**

A program written in Java language that can be used in the Web browser.

## **Java Virtual Machine**

Software that transfers the Java applet's byte code to the native code of your system to execute it.

## **JPEG**

Abbreviation for Joint Photographic Expert Group. The still image compression technology or standards of the ISO (International Organization for Standardization) and ITU-T. Popularly used as image compression format on the Internet, etc.

## **MAC address**

A network address that uniquely identifies each LAN card.

## **MPEG4**

Abbreviation for Moving Picture Experts Group4. One of the MPEG standards for image compression format aiming to transmit images at a high compression rate.

## **Multicast**

The class D IP address assigned between 224.0.0.0 and 239.255.255.255. Using this IP address enables you to transmit the same data to multiple equipment.

## **Network address**

The portion that identifies the local network (subnet) in an IP address.

## **Network bandwidth**

Bit rate that can be used for networking.

## **NTP server**

Network time server that transmits and receives time information over the networks.

## **Passive mode**

The mode whereby a client FTP allows TCP connection for data transmission to the FTP server.

## **POP server**

A server for storing incoming e-mail until you have read it.

## **Primary DNS server**

One of the DNS servers that can first reply to a request by connected devices or other DNS servers.

## **Proxy server**

A server or software that acts as an intermediary between a local network and the Internet so that it can connect to the Internet in place of a computer on a local network.

## **RADIUS client**

RADIUS (Remote Authentication Dial-in User Service) is an authentication and accounting protocol managing network access, and a RADIUS client is a party that accesses the network.

In Internet connecting service, a Network Access Server (NAS) such as that for dial-up and broadband access server is a RADIUS client. In a wireless LAN system, a wireless LAN access point is a RADIUS client.

## **Saturation**

The degree to which the color is pure.

## **Secondary DNS Server**

Subsidiary DNS server used when a primary DNS server cannot be used.

## **Shared secret**

A character string to be used for mutual authentication between RADIUS server and RADIUS client.

## **Sharpness**

The degree to which the boundary of two portions is clearly distinguished.

## **SMTP server**

A server for sending or relaying e-mail messages between servers.

## **SNMP**

A protocol for monitoring and managing network devices.

## **SolidPTZ**

Function that diminishes or crops an image to adjust the image position and ratio.

## **SSL**

Abbreviation for Secure Sockets Layer. This is a protocol developed by Netscape Communications Corporation to be used for communications of encrypted data on the Internet.

## **Subnet mask**

32-bit stream used to distinguish the subnet address from the IP address.

## **TCP**

Abbreviation for Transmission Control Protocol. A standard protocol used for the Internet connection. Compared with the other protocol, UDP, TCP provides reliable communication but the communication speed is slower.

## **UDP**

Abbreviation for User Datagram Protocol. A standard protocol used for the Internet connection. Compared with the other protocol, TCP, UDP can transmit data faster, but reliable communication is not guaranteed.

## **Unicast**

Transmission of the data to the specified equipment on a network by specifying a single address.

## **802.1X**

A standard that performs user authentication and dynamic key generation and traffic on a LAN.

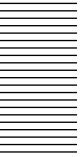



# Index

## Numerics

802.1X.....29, 49, 96

## A

Access log ..... 35  
Active ..... 76  
Active Directory..... 51  
ActiveX control..... 94  
ActiveX viewer ..... 18  
Adjust..... 32  
Administrator ..... 54  
administrator ..... 13  
Administrator e-mail address... 47, 60  
Administrator menu ..... 18, 28  
Alarm ..... 61, 63, 66, 70  
alarm ..... 60, 63, 66, 70  
Alarm buffer.....30, 63, 66  
alarm buffer..... 63, 66  
Alarm buffer Menu ..... 74  
Alarm duration ..... 69  
Alarm out ..... 69  
Alarm output ..... 29, 69  
alarm output ..... 26, 72  
Alarm output Menu..... 69  
Alarm recording ..... 66  
Alarm sending..... 60, 63  
Alarm sending Tab..... 60  
Analog video setting ..... 33  
ARP Commands ..... 91  
ARP commands ..... 91, 94  
Audio ..... 54  
Audio encode ..... 36  
Audio input ..... 35  
Audio input level..... 35  
Authentication.....47, 59, 65  
Authentication server ..... 49  
authentication server ..... 47  
Authenticator ..... 49  
Auto gain Max. value..... 37  
Automatically adjust clock for  
daylight saving time changes..... 32

## B

Backlight compensation..... 38  
Backup setting data ..... 34

Bandwidth control..... 78, 94  
Built-in memory ..... 65, 68

## C

CA (Certificate Authority)..... 49, 94  
CA certificate ..... 51  
Camera ..... 29  
camera ..... 35  
Camera control section ..... 19  
Camera Menu..... 35  
Cancel button ..... 29  
Capacity warning ..... 65  
Capture..... 94  
capture ..... 20  
Capture full image..... 34  
Capturing..... 22  
CGI commands ..... 92  
Client certificate ..... 50  
Codec ..... 74, 94  
Color ..... 35  
Common..... 35, 59  
Common Tab..... 65  
Compression ..... 93  
Contrast..... 38, 94  
control panel..... 23  
Control ..... 20  
Current date & time ..... 32  
Custom Homepage Installer..... 89  
Custom template ..... 36

## D

Date & time..... 32  
Date and time ..... 20  
Date and time format ..... 32  
Date time ..... 79  
Day/Night.....26, 38, 72  
Day/Night mode..... 38  
Default gateway ..... 94  
Default policy ..... 55  
delete ..... 50, 51  
Delete custom homepage ..... 34  
Delete image ..... 34  
Delete voice alert file ..... 35  
DHCP server ..... 46, 94  
Digital certificate..... 94  
Digital zoom..... 20, 94  
DNS server..... 46, 94  
Domain suffix..... 46  
Duration ..... 72

Dynamic IP address notification Tab  
..... 47

## E

EAP method ..... 50, 94  
EAP-TLS authentication ..... 94  
Effective period  
..... 61, 62, 63, 64, 66, 67, 69, 70  
e-mail ..... 26  
e-Mail (SMTP)..... 29, 59, 71  
e-Mail (SMTP) Menu..... 59  
e-Mail (SMTP) notification..... 47  
End time ..... 73  
Exclusive control mode..... 31  
Exposure..... 36  
Exposure compensation ..... 38

## F

Factory default ..... 34  
File ..... 70  
File attachment..... 60  
file name..... 67  
Fixed gain value ..... 37  
Frame rate ..... 19, 94  
FTP..... 54  
FTP client.....29, 64, 71, 94  
FTP client function..... 62  
FTP client Menu..... 62  
FTP server ..... 29, 94  
FTP server function..... 68  
FTP server Menu..... 68  
FTP server name ..... 62  
Full Image ..... 25

## G

Gamma setting ..... 38

## H

Home ..... 19  
Home position setting ..... 56  
Homepage ..... 30  
Host name ..... 46  
HTTP notification ..... 48  
HTTP port number ..... 46  
Hunting..... 94

## I

Image file name..... 60, 63, 64, 66, 67  
Image memory ..... 29, 65, 71



Others

Image memory Menu .....	65	Operation time.....	31	Secondary DNS Server.....	95
Image size.....	40	Overwrite.....	65	Security.....	29
Initialize.....	34	<b>P</b>		Security function .....	55
Inquiry Commands.....	92	Pan/Tilt control.....	24	Security Menu .....	55
Installation Tab.....	33	Passive mode .....	63	Sensor input.....	69
Internet Explorer .....	13	Password.....	47, 54, 60, 63	Sensor input mode.....	31
Interval .....	32, 62, 64, 67	PC clock .....	32	Sequence number clear. 61, 63, 64, 67	
IP address .....	46, 95	periodical recording.....	67	Serial number .....	30
IP Setup Program .....	6, 78	Periodical recording .....	67	Set.....	57
Iris open.....	33	Periodical sending .....	61, 64	Setting.....	19, 75
<b>J</b>		periodical sending .....	61	Shared secret.....	95
Java applet.....	95	Picture.....	36	Sharpness.....	38, 95
Java Virtual Machine.....	95	POP server.....	95	Shutter mode.....	37
JPEG cropping .....	43	POP server name .....	47, 60	SMTP server.....	95
JPEG setting / MPEG4 setting .....	44	Position.....	32	SMTP server name .....	47, 59, 65
<b>L</b>		Position at alarm.....	57	SNC audio upload tool .....	80
Light funnel mode.....	39	Preset .....	57	SNC video player .....	85
Logging in .....	17	Preset position .....	20, 29	SNMP .....	92, 93, 95
<b>M</b>		Preset position Menu.....	56	Software version.....	30
MAC address.....	46, 95	Preset position table .....	57	SolidPTZ .....	23, 44, 95
Maximum wait number .....	31	Primary DNS server .....	95	SSL .....	95
Message.....	47, 60	privacy mask.....	88	Start time .....	73
Method .....	48	Private key password.....	50	Streaming.....	44
Min. shutter speed .....	37	Proxy port number.....	48	Subject.....	47, 60
Mode .....	64, 67, 69	Proxy server.....	95	Subnet mask .....	96
monitor image section.....	20	Proxy server name.....	48	Suffix .....	60, 61, 63, 64, 66, 67
Monitor window .....	20	PTZ mode.....	31	Superimpose .....	32, 44
Monitoring.....	21	PTZ on motion detection.....	58	superimpose.....	32
Motion detection .....	30, 69, 75	<b>R</b>		supplicant.....	49
motion detection function .....	76	RADIUS client.....	95	System .....	29
Motion detection Menu .....	75	Reboot .....	34	System log .....	35
MPEG4.....	95	Rebooting .....	79	<b>T</b>	
Multicast.....	95	Recipient e-mail address .....	47, 60	TCP.....	17, 96
Multicast streaming.....	45	Recording capacity .....	74	Test .....	70
<b>N</b>		Remote path.....	63, 64	Threshold setting slider bar .....	76
Name .....	57	Repeat.....	70	Time zone .....	32
Network.....	29, 46, 93	Reset .....	50, 57	Title bar name.....	30
Network address.....	95	Restore setting .....	34	Tour.....	58
Network bandwidth.....	95	Resume time on inactivity.....	58	Trigger .....	20, 26, 29
NTP server.....	95	Re-type password .....	54, 63	Trigger Menu.....	71
NTP server name.....	32	<b>S</b>		TTL.....	45
<b>O</b>		Saturation .....	38, 95	<b>U</b>	
Object size.....	76	Saving.....	23	UDP.....	96
OK button.....	28	Schedule .....	29, 73	UDP (multicast).....	17
		schedule.....	29	UDP (unicast).....	17
		Schedule Menu.....	73	Unicast.....	96
				Unicast streaming .....	45

URL .....	48
User .....	29
User Menu.....	54
User name .....	47, 54, 60, 62

## V

Video codec.....	40
Video output mode.....	33
View size .....	20
Viewer authentication .....	55
Viewer mode .....	16, 55
Voice alert .....	29, 70, 72
Voice alert Menu .....	70
Voice alert tab .....	83
Volume .....	20

## W

Welcome text.....	30
White balance .....	36
Window .....	76
Windows Firewall .....	9
Windows Vista .....	10
Windows XP Service Pack 2.....	8

## Z

Zoom control.....	24
Zooming.....	22
Image file name.....	61

<http://www.sony.net/>

Sony Corporation