

PLATINUM WASH LED ZOOM

Elation Professional
6122 S Eastern Ave
Los Angeles, Ca 90040
www.elationlighting.com

Thank you for your patronage. We are confident that our excellent products and service can satisfy you.

For your own safety, please read this user manual carefully before installing the device.



CAUTION!

Keep this device away from rain and moisture !



CAUTION!

Unplug mains lead before opening the housing.

Every person involved with the installation, operation and maintenance of this device has to:

- be qualified
- follow carefully the instructions of this manual

INTRODUCTION:

Thank you for having chosen this professional led moving head.

You will see you have acquired a powerful and versatile device.

Unpack the device. Inside the box you should find:

1. One XLR connection cable
2. Two omega clamps
3. One safety rope
4. Manual

Please check carefully that there is no damage caused by transportation. Should there be any, consult your dealer and don't install this device.

Features:

- 30 x 10W high power LEDs
- Extremely Long Life:100,000 Hr and low power consumption
- 3 DMX channel mode: 12/14 /15channels
- Pan/tilt movement: 8 bit and 16 bit resolution
 - For smooth and precise resolution
 - Pan: 540°/630° optional, Tilt: 265°movement
 - High speed of pan/tilt movement, speed of pan/tilt movement is adjustable
 - Scan position memory, auto reposition after unexpected movement
- Strobe effect with 18 flashes per second and pulse effect
- General dimming and blackout for all four colors
- Excellent color mixing and rainbow effect
- Control board with full color LCD graphic display and touch-keyboard
- Rechargeable Back up Battery for Display
- Preset program: 7 built in programs can be called up via DMX controller
- Wireless receiver pre-installed
- RDMX: remote DMX addressing, lamp on / off, Sound control switch by controller
- ☒☒·Software-upload by optional accessory via DMX line

OVERVIEW

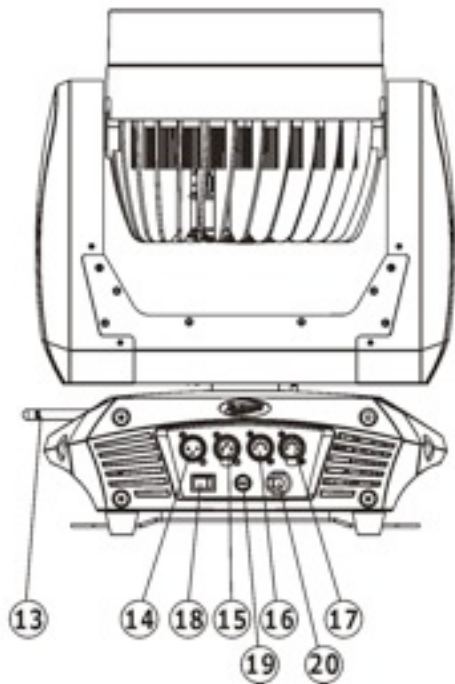
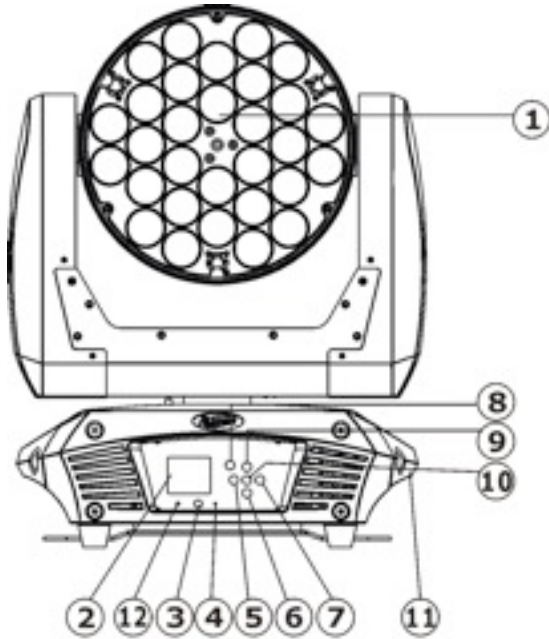

- 1: Lens
- 2: Display
- 3: DC Switch
- 4: Microphone
- 5: Left-button
- 6: Down-button
- 7: Right-button
- 8: Mode/Esc-button
- 9: Up-button
- 10: ENTER-button
- 11: Handle
- 12: Wireless indicator
- 13: Antenna – Wireless DMX
- 14: 3-Pin DMX in
- 15: 3-Pin DMX out
- 16: 5-Pin DMX in
- 17: 5-Pin DMX out
- 18: Power switch
- 19: Fuse
- 20: Power supply

SAFETY INSTRUCTIONS



CAUTION!

Be careful with your operations. With a dangerous voltage you can suffer a dangerous electric shock when touching wires!

This device has left the factory in perfect condition. In order to maintain this condition and to ensure a safe operation, it is absolutely necessary for the user to follow the safety instructions and warning notes written in this user manual.

Important:



Damages caused by the disregard of this user manual are not subject to warranty. The dealer will not accept liability for any resulting defects or problems.

If the device has been exposed to temperature changes due to environmental changes, do not switch it on immediately. The arising condensation could damage the device. Leave the device switched off until it has reached room temperature.

This device falls under protection-class I. Therefore it is essential that the device be earthed. The electric connection must carry out by qualified person.

The device shall only be used with rate voltage and frequency. Make sure that the available voltage is not higher than stated at the end of this manual.

Make sure the power cord is never crimped or damaged by sharp edges. If this would be the case, replacement of the cable must be done by an authorized dealer.

Always disconnect from the mains, when the device is not in use or before cleaning it. Only handle the power cord by the plug. Never pull out the plug by tugging the power cord.

During initial start-up some smoke or smell may arise. This is a normal process and does not necessarily mean that the device is defective, it should decrease gradually.

Please don't project the beam onto combustible substances.

Fixtures cannot be installed on combustible substances, keep more than 50cm distance with wall for smooth air flow, so there should be no shelter for fans and ventilation for heat radiation.

If this device will be operated in any way different to the one described in this manual, the product may suffer damages and the guarantee becomes void. Furthermore, any other operation may lead to short-circuit, burns, electric shock, lamp explosion, crash, etc.

If the external flexible cable or cord of this luminaire is damaged, it shall be exclusively replaced by the manufacturer or his service agent or a similar qualified person in order to avoid a hazard.

	<p>CAUTION! Never touch the device during operation! The housing may heat up</p>
	<p>CAUTION! Never look directly into the light source, as sensitive persons may suffer an epileptic shock.</p>

Please be aware that damages caused by manual modifications to the device are not subject to warranty. Keep away from children and non-professionals.

GENERAL GUIDELINES

This device is a lighting effect for professional use on stages, in discotheques, theatres, etc.

This fixture is only allowed to be operated with the max alternating current which stated in the technical specifications in the last page of this manual, the device was designed for indoor use only. Lighting effects are not designed for permanent operation. Consistent operational breaks may ensure that the device will function properly for a long time. Do not shake the device. Avoid brute force when installing or operating the device. The device shall only be used complete with its protective shield.

While choosing the installation-spot, please make sure that the device is not exposed to extreme heat, moisture or dust. The minimum distance between light-output from the projector and the illuminated surface must be more than 0.5 meter.

Always fix the fixture with an appropriate safety cable if you use the quick lock cam in hanging up the fixture, please make sure the 4 quick lock fasteners turned in the quick lock holes correctly.

If you use the quick lock cam in hanging up the fixture, please make sure the 4 quick lock fasteners turned in the quick lock holes correctly.

Operate the device only after having familiarized with its functions. Do not permit operation by persons not qualified for operating the device. Most damages are the result of unprofessional operation.

Please use the original packaging if the device is to be transported. For safety reasons, please be aware that all modifications on the device are forbidden.

If this device will be operated in any way different to the one described in this manual, the product may suffer damages and the guarantee becomes void. Furthermore, any other operation may lead to short-circuit, burns, electric shock, lamp explosion, crash, etc.

INSTALLATION INSTRUCTIONS

a) *Mounting the device*

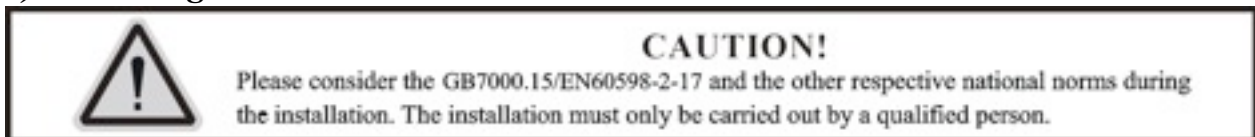

The applicable temperature for the lighting is between -25°C to 45°C. Do not use the lighting under or above the temperature.

The installation of the effect has to be built and constructed in a way that it can hold 10 times the weight for 1 hour without any harming deformation.

The installation must always be secured with a secondary safety attachment, e.g. an appropriate safety rope.

Never stand directly below the device when mounting, removing or servicing the fixture.

The operator has to make sure the safety relating and machine technical installations are approved by an expert before taking the device into operation for the first time.

These installations have to be approved by a skilled person once a year.

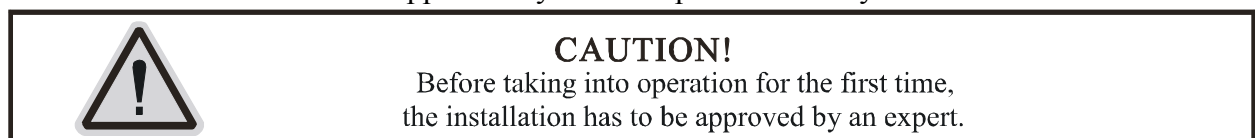

Cautions:

The effect should be installed outside areas where persons may reach it, walk by or be seated.



CAUTION!

When installing the device, make sure there is no highly inflammable material within a distance of min. 0,5m

Overhead mounting requires extensive experience, including amongst others calculating working load limits, installation material being used, and periodic safety inspection of all installation material and the device. If you lack these qualifications, do not attempt the installation yourself. Improper installation can result in bodily injury.



CAUTION!

The electric connection must only be carried out by a qualified electrician.

Before mounting make sure that the installation area can hold a minimum point load of 10 times the device's weight.

Connect the fixture to the mains with the power plug.

Installation method via clamp

Please refer to the picture below:

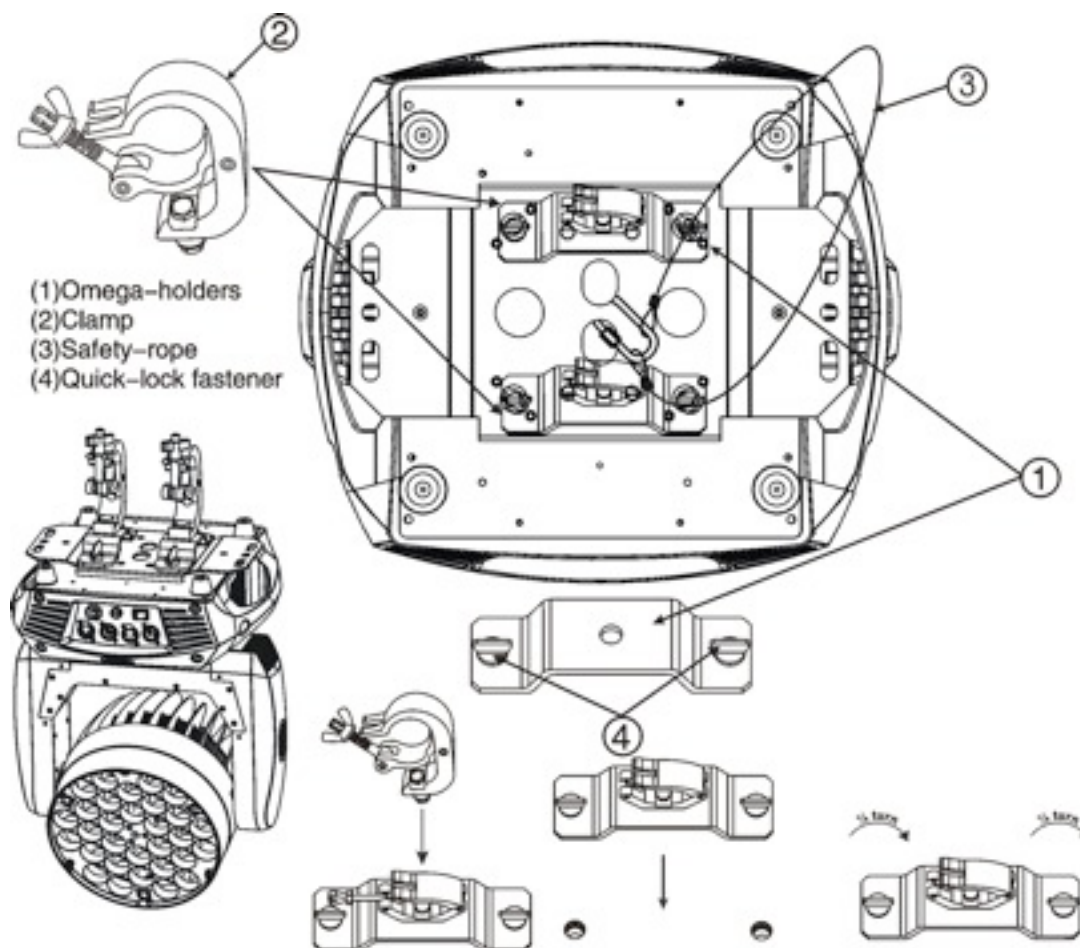

Screw one clamp each via a M12 screw and nut onto the Omega holders.

Insert the quick-lock fasteners of the first Omega holder into the respective holes on the bottom of the device. Tighten the quick-lock fasteners fully clockwise. Install the second Omega holder. Pull the safety-rope through the holes on the bottom of the base and over the trussing system or a safe fixation spot. Insert the end in the carabine and tighten the safety screw.

DMX-512 control connection

Connect the provided XLR cable to the female 3-pin XLR output of your controller and the other side to the male 3-pin XLR input of the moving head. You can chain multiple

Moving head together through serial linking. The cable needed should be two core, screened cable with XLR input and output connectors. Please refer to the diagram below.

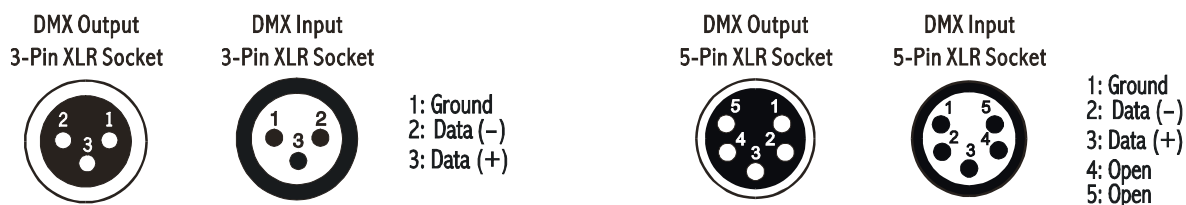

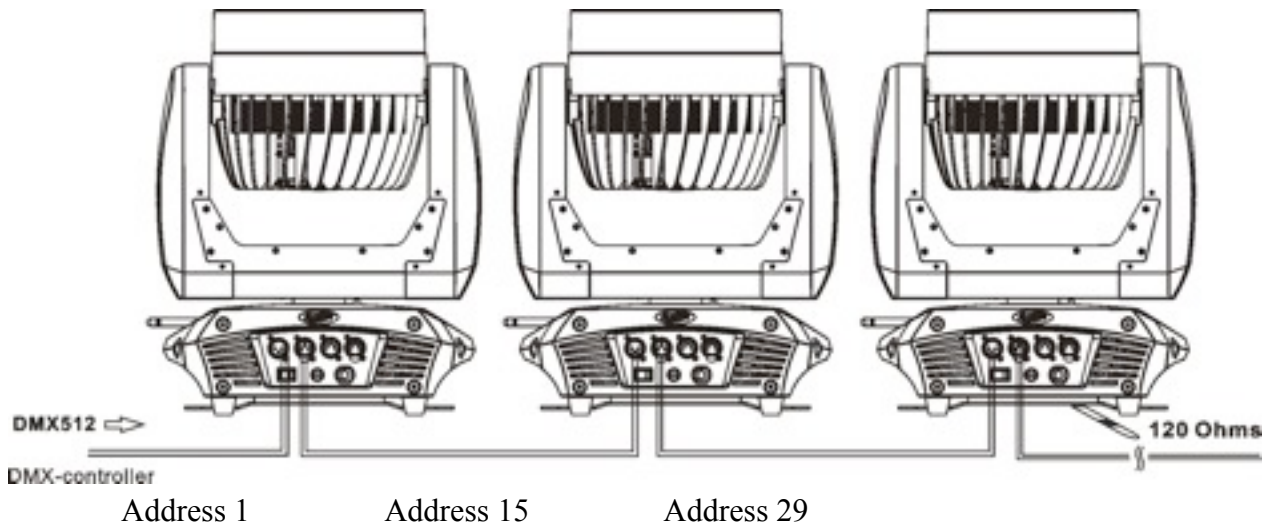

DMX-512 connection with DMX terminator

For installations where the DMX cable has to run a long distance or is in an electrically noisy environment, such as in a discotheque, it is recommended to use a DMX terminator. This helps in preventing corruption of the digital control signal by electrical noise. The DMX terminator is simply an XLR plug with a 120 Ω resistor connected between pins 2 and 3, which is then plugged into the output XLR socket of the last fixture in the chain. Please see illustrations below.

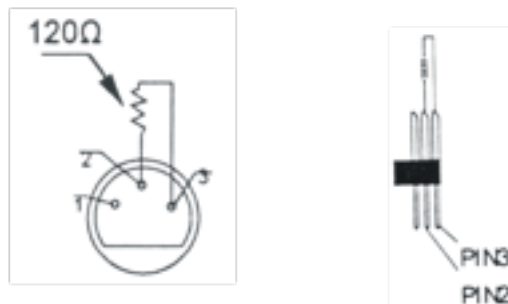

Projector DMX starting address selection

All fixtures should be given a DMX starting address when using a DMX signal, so that the correct fixture responds to the correct control signals. This digital starting address is the channel number from which the fixture starts to “listen” to the digital control information sent out from the DMX controller. The allocation of this starting address is achieved by setting the correct number on the display located on the base of the device.

You can set the same starting address for all fixtures or a group of fixtures, or make different address for each fixture individually.

If you set the same address, all the units will start to “listen” to the same control signal from the same channel number. In other words, changing the settings of one channel will affect all the fixtures simultaneously.

If you set a different address, each unit will start to “listen” to the channel number you have set, based on the quantity of control channels of the unit. That means changing the settings of one channel will affect only the selected fixture.

In the case of the Spot head, which is a 14 channel fixture, you should set the starting address of the first unit to 1, the second unit to 15(14 + 1), the third unit to 29 (14+ 15), and so on.

Operating instructions of the internal DMX wireless system

1. Equipments:

DMX 512 controller, wireless transmitter, and the fixtures with wireless receiver.

2. Message from the LED indicator:

- 1). Rapid flashing red/Green: logging in to a transmitter
- 2) Slow flashing Red/Green: Logged on a transmitter and the DMX line is idle (No DMX is connected to transmitter).
- 3) Solid Green: Logged on to a transmitter and receiving DMX data.
- 4) Solid Red: Not logged on to a transmitter (free)

3. WDMX in the menu of the fixture:

On a fixture installed with wireless system, in order to switch between wireless control system and traditional DMX control (with cable), a new menu WDMX is added to the display board.

ON: (Activate WDMX)

1).When the fixture is on power, and the WDMX is activated to ON status, but did not connect to the controller and did not log in to the transmitter, the fixture will search for the DMX signal source. If the fixture is connected to the DMX controller it can be controlled by DMX controller; if it is log in to the wireless transmitter, it can be controlled by the Transmitter

2).When the fixture is power off, and the WDMX is in ON status, if the fixture is connected to DMX controller. After the fixture is power on, it can be controlled only by the DMX controller which connected. The fixture can log in the wireless transmitter, and receive only radio signal from transmitter, but not DMX from the transmitter.

OFF: (De-activate WDMX)

In this status, wireless system is not activated, so the fixture can not log in the transmitter.

REST: (reset WDMX memory);

Can remove the fixture from the connection with the transmitter, the fixture become free and ready to log in any transmitter.

OUT: (Act & Data Out)

4. Setup the wireless system:

- 1) Connect the transmitter with the DMX controller
- 2) To make the fixture installed with wireless receiver log in to the transmitter
 - a) Initially, the indicator on the receiver fixture should be in Solid red
 - b) Press and hold the configuration button on transmitter for less than 3 seconds the red/green LEDs on the transmitter and the receiver fixture will flash rapidly for about 5~ 10 seconds while the system goes through its setup procedure.
 - c) Once the receiver fixture is logged in to the transmitter (T1), the fixture with wireless receiver will keep the memory, even if restart the power, this unit will log in the transmitter (T1) automatically.
- 3) Use the DMX 512 to control the fixture

5. Remove the receivers from transmitter (T1) and to log in to another transmitter (T2)

Case 1: Remove a receiver:

- a) On the control board of the fixture, enter menu to activated the function of REST;
- b) The LED for wireless on the fixture should turn to Solid red; the receiver can log out from the transmitter (T1);
- c) press the configuration button on transmitter(T2) for less than 3 second, then the fixture will start to connect with the transmitter(T2)

Case 2: Remove all receivers from a transmitter (T1) to log in to T2;

- a) Press and hold the configuration button on the T1 as least 5 seconds, can clear the connection with all the fixtures.
- b) All the red/green LEDs on the receiver fixtures will turn to Solid red to indicate that the receivers are unassigned and removed from the transmitter (T1);
- c) Press and hold the configuration button on the T2 less then less than 3 second , the fixtures will connect with the T2











PS: 1. Please log the receivers out from the transmitter after every job, so that the receivers are in free un assigned state and ready to be assigned to a transmitter.

2. Do not connect the fixture which is under the communication of wireless system to the DMX controller, otherwise it will cause interference from the DMX controller.

Control Board

The Control Board offers several features: you can simply set the starting address , run the pre-programmed program or make a reset.

The main menu is accessed by pressing the -button until the display starts flashing. Browse through the

menu by pressing the  -button ,  -button ,  -button or  -button. Press the Enter-button in order to select the desired menu. You can change the selection by pressing the the  -button ,  -button ,  -button or  -button. Confirm every selection by pressing the  -button. You can leave every mode by pressing the  -button. The functions provided are described in the following sections. it will exit from flash 10 seconds after the last keypress. Press this key under edit mode, . The functions provided are described in the following sections.

To access the display menu via the internal battery, press the DC switch button for 2seconds; To shut off the display immediately, choose the commend " Reset All" menu and press "Enter" button, otherwise, the display will automatically switch off about 1 minute from last button press.

Function Mode	Set Dmx Address Value Display Set To Slave Auto Program Music Control	A001~AXXX PAN..... Slave1,Slave2,Slave3 Master / Alone Master / Alone		DMX address setting DMX value display Slave setting Auto program Music control
Information	Time Information	Current Time	XXXX(Hours)	Power on running time
		Total Life Hours	XXXX(Hours)	Fixture running time
		Last Run Hours	XXXX(Hours)	Fixture Last times clear
Timer Password		Password=XXX	Timer Password 038	
Clear Last Run		ON/OFF	Clear Fixture Last time	
	Temperature Info	Head Temperature	XXX°C/°F	Temperature in the head
	Software Version	Ver1.0		Software version of each IC
Personality	Status Settings	Address via DMX	ON/OFF	Add. via DMX
		No DMX Status	Close/Hold/Auto/Music	Auto run if no DMX
		Pan Reverse	ON/OFF	Pan Reverse movement
		Tilt Reverse	ON/OFF	Tilt Reverse movement
		Pan Degree	630/540	Pan Degree Select
		Feedback	ON/OFF	Movement Feedback switch
		Movement Speed	Speed 1~ 4	Movement Mode Select
		Mic Sensitivity	0~99%	Sensitivity of Mic.
	Hibernation	OFF/1~99M 15M	Standby mode	
		Fans Control	Auto Fans Speed High Fans Speed Low Fans Speed	
	Display Setting	Shutoff Time Display Reverse Key Lock		02~60m 05m ON/OFF ON/OFF
	Temperature C/F	Celsius Fahrenheit		Temperature switch between °C/°F
	Initial Effect	PAN.....	PAN =XXX	Initial effect position
	Wireless DMX	De-Act WDMX Activate WDMX Act & Data Out Rest WDMX Mem		De-activate WDMX Activate WDMX Act & Data Out Reset Wireless DMX Mem
	Reset Default	ON/OFF		Restore factory sett.

Reset Function	Reset All Reset Pan&Tilt Reset Zoom			Reset all motors Reset Pan&Tilt Reset Zoom	
Effect Adjust	Test Channel	PAN		Test function	
	Manual Control	PAN :	PAN =XXX :	Fine adjustment of the lamp	
	Calibrate Values	--Password-- PAN :	Password=XXX PAN=XXX :	Calbrate and adjust the effects to standard/right position Password "050"	
User's Mode Set	User Mode	Standard Mode Basic Mode Extended Mode User Mode A User Mode B User Mode C		User's mode to change channel numbers	
	Edit User Mode	PAN :	PAN = CH01 :	Preset User modes	
Edit Program	Select Programs	Auto Pro Part 1 Auto Pro Part 2 Auto Pro Part 3	Program 1 ~ 10 Program 1 ~ 10 Program 1 ~ 10	Program 1 Program 2 Program 3	Select programs to be run
	Edit Program	Program 1 : Program 10	Program Test Step 01=SCxxx Step 64=SCxxx	("STEP XX")	Testing program Program in loop Save and exit
	Edit Scenes	Edit Scene 001 ~ Edit Scene 250	Pan,Tilt,..... --Secne Time-- Input By Outside	P a n = x x x TIME=xx.xs	Save and automatically return manual scenes edit
	Rec. Controller	XX~XX			Automat. scenes rec

Default settings shaded

一. FUNCTION MODE

Set DMX Address

With this function, you can adjust the desired DMX-address via the Control Board.

1. Access the main menu.
2. Tap the <Up/Down>button until "Set DMX Address" is displayed.
3. Press ENTER, the display will show "Set DMX Address".
4. Tap the <Up/Down>button, the display will show "A001~AXXX"
5. Press ENTER to confirm or press <MODE/ESC> to return to the main menu.

Value Display

With this function you can display the DMX 512 value of each channel. The display automatically shows the channel with a value changing.

1. Access the main menu.
2. Tap the <Up/Down>button until "Value Display" is displayed.
3. Press ENTER, the display will show "Value Display".
4. Tap the <Up/Down>button, choose each channel.
5. Press ENTER to confirm or press <MODE/ESC> to return to the main menu.

Set to slave

With this function, you can define the device as slave.

1. Access the main menu.
2. Tap the <Up/Down>button until “Set To Slave” is displayed.
3. Press ENTER, the display will show “Set To Slave”.
4. Tap the <Up/Down>button, the display will show “Slave1”, ”Slave2”, ”Slave3”.
5. Press ENTER to confirm or press <MODE/ESC> to return to the main menu.

Auto Program

With this function, you can run the internal program. You can select the desired program under “**Select program**”. You can set the number of steps under “**Edit program**”. You can edit the individual scenes under “**Edit scenes**”. With this function, you can run the individual scenes either automatically, i.e. with the adjusted Step-Time.

1. Access the main menu.
2. Tap the <Up/Down>button until “Auto Program” is displayed.
3. Press ENTER, the display will show “Auto Program”.
4. Tap the <Up/Down>button, the display will show “Master1”, ” Alone”.
5. Press ENTER to confirm or press <MODE/ESC> to return to the main menu.

Music control

With this function, you can run the internal program sound-controlled.

1. Access the main menu.
2. Tap the <Up/Down>button until “Music control” is displayed.
3. Press <ENTER>, the display will show “Music control”.
4. Tap the <Up/Down>button, the display will show “Master1”, ” Alone”.
5. Press <ENTER> to confirm or press <MODE/ESC> to return to the main menu.

二. Information

1) Time information

Current Time

With this function, you can display the temporary running time of the device from the last power on. The display shows “XXXX”, “XXXX” stands for the number of hours. The counter is resetted after turning the device off.

1. Tap <MODE/ESC>button, access the main menu, Tap the <Up/Down>button until “Information” is displayed. Press ENTER, the display will show “Information”. Tap the <Up/Down>button until the display will show “Timer Password”. Press ENTER, the display will show “Timer Password”.
2. Press <Up/Down>, the display will show “Current Time”.
3. Press <ENTER>, the display will show “Current Time”.
4. The display will show “XXXX” (Hours) ;
5. Press <ENTER> to confirm or press <MODE/ESC> to return to the main menu.

Total Life Hours

With this function, you can display the running time of the device. The display shows “XXXX”, “XXXX” stands for the number of hours.

1. Tap <MODE/ESC>button, access the main menu, Tap the <Up/Down>button until “Information” is displayed. Press ENTER, the display will show “Information”. Tap the <Up/Down>button until the display will show “Timer Password”. Press ENTER, the display will show “Timer Password”.
2. Press <Up/Down>, the display will show “Total Life Hours”.

3. Press <ENTER>, the display will show “Total Life Hours”.
4. The display will show “XXXX” (Hours) ;
5. Press <ENTER> to confirm or press <MODE/ESC> to return to the main menu.

Last Run Hours

With this function, you can display last the running time of the lamp. The display shows “XXXX”, “XXXX” stands for the number of hours

1. Tap <MODE/ESC>button, access the main menu, Tap the <Up/Down>button until “Information” is displayed. Press ENTER, the display will show “Information”. Tap the <Up/Down>button until the display will show “Timer Password”. Press ENTER, the display will show “Timer Password”.
2. Press <Up/Down>, the display will show “Last Run Hours”.
3. Press <ENTER>, the display will show “Last Run Hours”.
4. The display will show “XXXX” (Hours) ;
5. Press <ENTER> to confirm or press <MODE/ESC> to return to the main menu.

Timer Password

With this function, you can display the timer password.

1. Tap <MODE/ESC>button, access the main menu, Tap the <Up/Down>button until “Information” is displayed. Press ENTER, the display will show “Information”. Tap the <Up/Down>button until the display will show “Timer Password”. Press ENTER, the display will show “Timer Password”.
2. Press <Up/Down>, the display will show “Timer Password”.
3. Press <ENTER>, the display will show “Timer Password”. The time password is 038.
4. Press <ENTER> to confirm or press <MODE/ESC> to return to the main menu.

Clear Last Run

With this function, you can clear last run time of the fixture. The display shows “ON” or “OFF”, Press “Enter” to confirm.

1. Tap <MODE/ESC>button, access the main menu, Tap the <Up/Down>button until “Information” is displayed. Press ENTER, the display will show “Information”. Tap the <Up/Down>button until the display will show “Timer Password”. Press ENTER, the display will show “Timer Password”.
2. Press <Up/Down>, the display will show “Clear Last Run”.
3. At “L-Timer Password” menu input right password, Press <ENTER>, the display will show “Clear Last Run”.
4. The display show “OFF”, Press <Up/Down>, the display will show “ON”.
5. Press <ENTER> to confirm or press <MODE/ESC> to return to the main menu.

2) Temperature Info

Head Temperature

With this function you can display the temperature on the display board of the base (near CMY-filter) in Celsius.

1. Tap <MODE/ESC>button, access the main menu, Tap the <Up/Down>button until “Information” is displayed. Press ENTER, the display will show “Information”. Tap the <Up/Down>button until “Temperature Info” is displayed. Press ENTER, the display will show “Temperature Info”.
2. Press <Up/Down>, the display will show “Head Temperature”.
3. Press <ENTER>, the display will show “Head Temperature”.
4. The display show “XXX °C/ °F”.

5. Press <ENTER> to confirm or press <MODE/ESC> to return to the main menu.

3) Software version

With this function, you can display the software version of the device.

1. Tap <MODE/ESC>button, access the main menu, Tap the <Up/Down>button until “Information” is displayed. Press ENTER, the display will show “Information”.
2. Press <Up/Down>, the display will show “Software version”.
3. Press <ENTER>, the display will show “Software version”.
4. The display show “Ver 1.0.....”.
5. Press <ENTER> to confirm or press <MODE/ESC> to return to the main menu.

三. PERSONALITY

1) Status setting

Address via DMX

With this function, you can adjust the desired DMX-address via an external controller.

1. Tap <MODE/ESC>button, access the main menu, Tap the <Up/Down>button until “Personality” is displayed. Press ENTER, the display will show “Personality”. Tap the <Up/Down>button until the display will show “Status setting”. Press ENTER, the display will show “Status setting”.
2. Press <Up/Down>, the display will show “Address via DMX”.
3. Press <ENTER>, the display will show “Address via DMX”.
4. The display show “ON”, Press <Up/Down>, the display will show “OFF”.
5. Press <ENTER> to confirm or press <MODE/ESC> to return to the main menu.

No DMX Status

With this function, when the drive is not DMX signal, it runs automatism, close, hold and music, the default is hold.

1. Tap <MODE/ESC>button, access the main menu, Tap the <Up/Down>button until “Personality” is displayed. Press ENTER, the display will show “Personality”. Tap the <Up/Down>button until the display will show “Status setting”. Press ENTER, the display will show “Status setting”.
2. Press <Up/Down>, the display will show “No DMX Status”.
3. Press <ENTER>, the display will show “No DMX Status”.
4. The display show “Hold”, Press <Up/Down>, the display will show “Close”, “Auto”, “Music”.
5. Press <ENTER> to confirm or press <MODE/ESC> to return to the main menu.

Pan Reverse

With this function you can reverse the Pan-movement.

1. Tap <MODE/ESC>button, access the main menu, Tap the <Up/Down>button until “Personality” is displayed. Press ENTER, the display will show “Personality”. Tap the <Up/Down>button until the display will show “Status setting”. Press ENTER, the display will show “Status setting”.
2. Press <Up/Down>, the display will show “Pan Reverse”.
3. Press <ENTER>, the display will show “Pan Reverse”.
4. The display show “OFF”, Press <Up/Down>, the display will show “ON”.
5. Press <ENTER> to confirm or press <MODE/ESC> to return to the main menu.

Tilt Reverse

With this function you can reverse the Tilt-movement.

1. Tap <MODE/ESC>button, access the main menu, Tap the <Up/Down>button until “Personality” is displayed. Press ENTER, the display will show “Personality”. Tap the <Up/Down>button until the display will show “Status setting”. Press ENTER, the display will

- show "Status setting".
2. Press <Up/Down>, the display will show "Tilt Reverse".
3. Press <ENTER>, the display will show "Tilt Reverse".
4. The display show "OFF", Press <Up/Down>, the display will show "ON".
5. Press <ENTER> to confirm or press <MODE/ESC> to return to the main menu.

Pan Degree

With this function, you can select pan degree for 630 or 540.

1. Tap <MODE/ESC>button, access the main menu, Tap the <Up/Down>button until "Personality" is displayed. Press ENTER, the display will show "Personality". Tap the <Up/Down>button until the display will show "Status setting". Press ENTER, the display will show "Status setting".
2. Press <Up/Down>, the display will show "Pan Degree".
3. Press <ENTER>, the display will show "Pan Degree".
4. The display show "540", Press <Up/Down>, the display will show "630".
5. Press <ENTER> to confirm or press <MODE/ESC> to return to the main menu.

Feedback

With this function, you can feedback switch of pan movement or tilt movement.

1. Tap <MODE/ESC>button, access the main menu, Tap the <Up/Down>button until "Personality" is displayed. Press ENTER, the display will show "Personality". Tap the <Up/Down>button until the display will show "Status setting". Press ENTER, the display will show "Status setting".
2. Press <Up/Down>, the display will show "Feedback".
3. Press <ENTER>, the display will show "Feedback".
4. The display show "ON", Press <Up/Down>, the display will show "OFF".
5. Press <ENTER> to confirm or press <MODE/ESC> to return to the main menu.

Movement Speed

With this function, you can select scan mode from 1 to 4.

1. Tap <MODE/ESC>button, access the main menu, Tap the <Up/Down>button until "Personality" is displayed. Press ENTER, the display will show "Personality". Tap the <Up/Down>button until the display will show "Status setting". Press ENTER, the display will show "Status setting".
2. Press <Up/Down>, the display will show "Movement Speed".
3. Press <ENTER>, the display will show "Movement Speed".
4. The display show "Speed 1", Press <Up/Down>, the display will show "Speed 2", "Speed 3", "Speed 4".
5. Press <ENTER> to confirm or press <MODE/ESC> to return to the main menu.

Mic Sensitivity

With this function, the default is 70%, you can select the desired microphone sensitivity from 0 % to 99 %.

1. Tap <MODE/ESC>button, access the main menu, Tap the <Up/Down>button until "Personality" is displayed. Press ENTER, the display will show "Personality". Tap the <Up/Down>button until the display will show "Status setting". Press ENTER, the display will show "Status setting".
2. Press <Up/Down>, the display will show "Mic Sensitivity".
3. Press <ENTER>, the display will show "Mic Sensitivity".
4. The display show "70%", Press <Up/Down>, the display will show "0~99%".
5. Press <ENTER> to confirm or press <MODE/ESC> to return to the main menu.

Hibernation — Standby mode

The lamp and step motors will be power off if the fixture stay without DMX signal for 15 mins (Factory default). And the fixture will be reset before working once it receive DMX signal again.

1. Tap <MODE/ESC>button, access the main menu, Tap the <Up/Down>button until“Personality”is displayed. Press ENTER, the display will show “Personality”. Tap the <Up/Down>button until the display will show “Status setting”. Press ENTER, the display will show “Status setting”.
2. Press <Up/Down>, the display will show “Hibernation”.
3. Press< ENTER>, the display will show “Hibernation”.
4. The display show “15M”,Press <Up/Down>, the display will show “01M”, “02M” “99M” or“OFF”.
5. Press <ENTER> to confirm or press <MODE/ESC> to return to the main menu.

2) Fans Control

With this function, you can set the speed of the running fans. The selections have Auto、 high and low.

1. Tap <MODE/ESC>button, access the main menu, Tap the <Up/Down>button until“Personality”is displayed. Press ENTER, the display will show “Personality”.
2. Press <Up/Down>, the display will show “Fans Control”.
3. Press< ENTER>, the display will show “Fans Control”.
4. The display show “Auto Fans Speed”,Press <Up/Down>, the display will show “High Fans Speed”, “Low Fans Speed”.
5. Press <ENTER> to confirm or press <MODE/ESC> to return to the main menu.

3) Display settings

Shut off time

With this function you can shut off the color LCD display after 2 to 59 minutes. Turn the encoder in order to select the desired shut off time. The default is 5 minute.

Display Reverse

With this function you can the entire display to be flipped by 180° to allow for better view when the fixture is hung from truss or a ceiling. This function is disabled as default.

Key Lock

With this function you can activate the automatic keylock status. If this function is activated, the keys will be locked automatically after exiting the edit mode for 15 seconds. keeping press the [MENU] key for 3seconds if you do not need this function.

1. Tap <MODE/ESC>button, access the main menu, Tap the <Up/Down>button until“Personality”is displayed. Press ENTER, the display will show “Personality”.
2. Press <Up/Down>, the display will show “Display Setting”.
3. Press< ENTER>, the display will show “Display Setting”.
4. The display show “Shutoff Time”,Press <Up/Down>, the display will show “Display Reverse”, “Key Lock”.
5. Press <ENTER> to confirm or press <MODE/ESC> to return to the main menu.

4) Temperature C/F

With this function, Display the temperature for Celsius or Fahrenheit.

1. Tap <MODE/ESC>button, access the main menu, Tap the <Up/Down>button until“Personality”is displayed. Press ENTER, the display will show “Personality”.
2. Press <Up/Down>, the display will show “Temperature C/F”.
3. Press< ENTER>, the display will show “Temperature C/F”.
4. The display show “Celsius”,Press <Up/Down>, the display will show “Fahrenheit”.
5. Press <ENTER> to confirm or press <MODE/ESC> to return to the main menu.

5) Initial effect

With this function, Display initial effect position.

1. Tap <MODE/ESC>button, access the main menu, Tap the <Up/Down>button until“Personality”is displayed. Press ENTER, the display will show “Personality”.
2. Press <Up/Down>, the display will show “Initial effect”.
3. Press< ENTER>, the display will show “Initial effect”.
4. The display show “XXX”.
5. Press <ENTER> to confirm or press <MODE/ESC> to return to the main menu.

6) Wireless DMX

From factory, this projector is prepared for wireless data transmission (W-DMX). If you wish to activate WDMX control, you can select the function “Activate WDMX”. If you wish to de-activate W-DMX control, you can select the function “De-activate WDMX” by tapping the<Up/Down> button. If you wish to Reset Wireless DMX Mem , you can select the function “Rest WDMX Mem”,. With the function of “Act & Data Out”, you can start up the wireless and send out data.

7)Restore Default

With this function, you can select restore factory set for ON or OFF, the default is OFF.

1. Tap <MODE/ESC>button, access the main menu, Tap the <Up/Down>button until“Personality”is displayed. Press ENTER, the display will show “Personality”.
2. Press <Up/Down>, the display will show “Restore Default”.
3. Press< ENTER>, the display will show “Restore Default”.
4. The display show “OFF”,Press <Up/Down>, the display will show “ON”.
5. Press <ENTER> to confirm or press <MODE/ESC> to return to the main menu.

四. Reset-functions

With this function you can reset the device via the Control Board. You can select the different reset functions by turning the encoder.

1. Tap <MODE/ESC>button, access the main menu, Tap the <Up/Down>button until“Reset-functions”is displayed. Press ENTER, the display will show “Reset-functions”. The display show “Reset All”, Press <Up/Down>, the display will show “Reset All”, “Reset Pan/Tilt”, “Reset Zoom”.
2. Press <ENTER> to confirm or press <MODE/ESC> to return to the main menu.

五. Effect Adjust

1) Test channel

With this function you can test each channel on its (correct) function.

1. Tap <MODE/ESC>button, access the main menu, Tap the <Up/Down>button until“Effect Adjust”is displayed. Press ENTER, the display will show “Effect Adjust”.
2. Press <Up/Down>, the display will show “Test Channel”.
3. Press< ENTER>, the display will show “Test Channel”.
4. The display show “Pan Moving”frist channel, Press <Up/Down>, can choose other channel.
5. Press <ENTER> to confirm or press <MODE/ESC> to return to the main menu.

2) Manual control

With this function, you can adjust the lamp more easily. All effects will be canceled, the shutter opens and the dimmer intensity will be set to 100 %. With the individual functions, you can focus the light on a flat surface

(wall) and perform the fine lamp adjustment.

1. Tap <MODE/ESC>button, access the main menu, Tap the <Up/Down>button until“Effect Adjust”is displayed. Press ENTER, the display will show “Effect Adjust”.
2. Press <Up/Down>, the display will show “Manual control”.
3. Press< ENTER>, the display will show “Manual control”.
4. The display show “PAN=XXX”.
5. Press <ENTER> to confirm or press <MODE/ESC> to return to the main menu.

3) Calibrate values

With this function, you can calibrate and adjust the effect wheels to their correct positions. The password of calibrate values is 050.

1. Tap <MODE/ESC>button, access the main menu, Tap the <Up/Down>button until“Effect Adjust”is displayed. Press ENTER, the display will show “Effect Adjust”.
2. Press <Up/Down>, the display will show “Calibrate values”.
3. Press< ENTER>, the display will show “Calibrate values”.
4. The display show “Password=XXXX”.
5. Press <ENTER> to confirm or press <MODE/ESC> to return to the main menu.

六. Users mode set

In this menu, user can select different channels list by different sequence:

For example, after the user enter this manual, if select Auto Program = CH 22, means in this User’s mode, the “Dimmer” is in Channel 16.

User mode

With this function, you can create user defined channel orders.

Preset User mode

With this function, you can adjust the rest user defined channel order.

1. Tap <MODE/ESC>button, access the main menu, Tap the <Up/Down>button until“Users mode set”is displayed. Press ENTER, the display will show “Users mode set”.
2. The display show “User Mode”frist channel, Press <Up/Down> the display will show “Edit User Mode”.
3. Press <ENTER> to confirm or press <MODE/ESC> to return to the main menu.

七. Edit program

Select program

With this function, you can select the program for the Program Run.

Edit program

With this function, you can edit the internal programs.

Edit scenes

With this function, you can edit the scenes of the internal programs.

Auto scenes rec.

The moving head features an integrated DMX-recorder by which you can transmit the programmed scenes from your DMX-controller to the moving head. Adjust the desired scene numbers via the encoder (from – to). When you call up the scenes at your controller, they will automatically be transmitted to the moving head.

Excursion:

A Master unit can send up to 3 different data groups to the Slave units, i.e. a Master unit can start 3 different Slave units, which run 3 different programs. The Master unit sends the 3 program parts in a continuous loop.



The Slave unit receives data from the Master unit according to the group which the Slave unit was assigned to. If e.g. a Slave unit is set to “Slave 1” in the menu “Set to Slave”, the Master unit sends “Auto Program Part 1” to the Slave unit. If set to “Slave 2”, the Slave unit receives “Auto Program Part 2”.

To start a Auto Program please proceed as follows:

1. Slave-Setting

- Select “Function Mode” by turning the encoder.
- Press the Enter button to confirm.
- Select “Set to slave” by turning the encoder.
- Press the Enter button to confirm.
- Turn the encoder to select “Slave 1”, “Slave 2” or “Slave 3”.
- Press the Enter button to confirm.
- Press the MODE/ESC button in order to return to the main menu.

2. Automatic Program Run

- Select “Function Mode” by turning the encoder.
- Press the Enter button to confirm.
- Select “Auto Program” by turning the encoder.
- Press the Enter button to confirm.
- Turn the encoder to select “Master” or “Alone”. The selection "Alone" means Stand Alone-mode and "Master" that the device is defined as master.
- Press the Enter button to confirm.
- Press the MODE/ESC button in order to return to the main menu.

3. Program selection for Auto Pro Part

- Select “Edit program” by turning the encoder.
- Press the Enter button to confirm.
- Select “Select programs” by turning the encoder.
- Press the Enter button to confirm.
- Turn the encoder to select “Auto Pro Part 1”, “Auto Pro Part 2” or “Auto Pro Part 3”, and thus select which Slave program is to be sent. Selection “Part 1” means, that the Slave unit runs the same program as the master units.
- Press the Enter button to confirm.
- Press the MODE/ESC button in order to return to the main menu.

4. Program selection for Edit Program

- Select “Edit program” by turning the encoder.
- Press the Enter button to confirm.
- Select “Edit program” by turning the encoder.
- Press the Enter button to confirm.
- Turn the encoder to select the desired program. With this function you can edit specific scenes into a specific program.
- Press the Enter button to confirm.
- Press the MODE/ESC button in order to return to the main menu.

5. Automatic Scene Recording

- Select “Edit program” by turning the encoder.
- Press the Enter button to confirm.
- Select “Edit scenes” by turning the encoder.
- Turn the encoder to select the desired scene numbers. You can program a maximum number of 250 • Turn the encoder to select the desired scene numbers. You can program a maximum number of 250 scenes.
- Press the Enter button to confirm.
- Press the MODE/ESC button in order to return to the main menu.

Example:

Program 2 includes scenes: 10, 11, 12, 13

Program 4 includes scenes: 8, 9, 10

Program 6 includes scenes: 12, 13, 14, 15

Auto Pro Part 1 is Program 2;

Auto Pro Part 2 is Program 3;

Auto Pro Part 3 is Program 6

The 3 Slave groups run the Auto Program in certain time segments, as shown in the following picture:

Part 1:

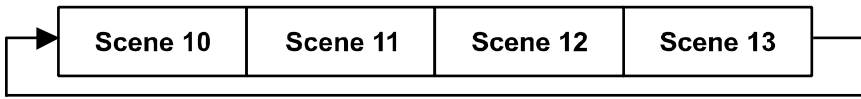

Part 2:

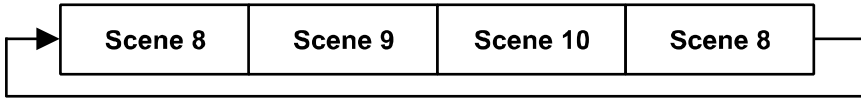

Part 3:

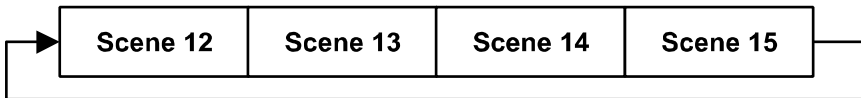

INSTRUCTIONS ON USE:

DMX channel's functions and their values (15 DMX channels):				
Mode/Channel			Value	Function
St	Ba	Ex		
1	1	1		<u>PAN Movement 8bit :</u>
			0-255	Pan Movement
2		2		<u>Pan Fine 16bit</u>
			0-255	Fine control of Pan movement
3	2	3		<u>TILT Movement 8bit :</u>
			0-255	Tilt Movement
4		4		<u>Tilt Fine 16bit</u>
			0-255	Fine control of Tilt movement
5	3	5		<u>Red LED :</u>
			0-255	Red (0-Black , 255-100% Red)
6	4	6		<u>Green LED :</u>
			0-255	Green (0-Black , 255-100% Green)
7	5	7		<u>Blue LED :</u>
			0-255	Blue (0-Black , 255-100% Blue)
8	6	8		<u>White LED :</u>
			0-255	Green (0-Black , 255-100% Green)
9	7	9		<u>Shutter, strobe:</u>
			0-31	Led trun off
			32-63	Led turn on
			64-95	Strobe effect slow to fast
			96-127	Led turn on
			128-159	Pulse-effect in sequences

			160-191	Led turn on
			192-223	Random strobe effect slow to fast
			224-255	Led turn on
10	8	10		<u>Dimmer intensity:</u>
			0-255	Intensity 0 to 100%
11	9	11		<u>Rainbow:</u>
			0-9	No function
			10-39	Rainbow colours
			40-71	Rainbow colours
			72-103	Rainbow colours
			104-135	Rainbow colours
			136-167	Rainbow colours
			168-199	Rainbow colours
			200-231	Rainbow colours
			232-255	Crossfading colours from slow to fast
12	10	12		<u>Zoom :</u>
			0-255	Zoom adjustment from 15 to 60
		13		<u>Zoom Fine :</u>
			0-255	Fine control for Zoom adjustment
13	11	14		<u>Speed Pan/Tilt movement:</u>
			0-225	Max to min speed
			226-235	Blackout by movement
			236-255	No function
14	12	15		<u>Lamp on/off, reset, internal programs:</u>
			0-79	Normal
			80-84	All motor reset
			85-87	Scan motor reset
			88-90	No function
			91-93	No function
			94-96	No function
			97-99	Others motor reset
			100-119	Internal program 1 (secne1~8 of EEPROM)
			120-139	Internal program 2 (secne9~16 of EEPROM)
			140-159	Internal program 3 (secne17~24 of EEPROM)
			160-179	Internal program 4 (secne25~32 of EEPROM)
			180-199	Internal program 5 (secne33~40 of EEPROM)
			200-219	Internal program 6 (secne41~48 of EEPROM)
			220-239	Internal program 7 (secne49~56 of EEPROM)
			240-255	Music Control (secne of Program 1)

ERROR MESSAGE

When you turn on the fixture, it will make a reset at first. The display may show "Err channel is XX" while there are problems with one or more channels. "XX" stands for channel 1, 2, 3, 4, 5, 6 who has the testing sensor for positioning. For example, when the display shows "Err channel is Color wheel", it means there is

some error in channel 1. If there are some errors on channel 1, channel 3, channel 12 at the same time, you may see the error message “Err channel is Pan movement”, “Err channel is Tilt movement”, “Err channel is Zoom” flash repeated for 2 times, and then the fixture will generate a second reset. If the fixture remain error message after performing reset more than 2 times, only the channels which have errors can not work properly, others can work as usual. Please contact with dealer or manufacturer for service, self repair is not allowed.

PAN- movement Er

(PAN-yoke movement error) This message will appear after the reset of the fixture if the yoke’s magnetic-indexing circuit malfunction (sensor failed or magnet missing) or the stepping-motor is defective (or its driving IC on the main PCB). The PAN- movement is not located in the default position after the reset.

TILT- movement Er

(TILT-head movement error) This message will appear after the reset of the fixture if the head’s magnetic-indexing circuit malfunctions (sensor failed or magnet missing) or the stepping-motor is defective (or its driving IC on the main PCB). The TILT- movement is not located in the default position after the reset.

Zoom Er

(Zoom error) This message will appear after the reset of the fixture if the head’s magnetic-indexing circuit malfunctions (sensor failed or magnet missing) or the stepping-motor is defective (or its driving IC on the main PCB). The TILT- movement is not located in the default position after the reset.

CLEANING AND MAINTENANCE

The following points have to be considered during the inspection:

- 1) All screws for installing the devices or parts of the device have to be tightly connected and must not be corroded.
 - 2) There must not be any deformations on the housing, color lenses, fixations and installation spots (ceiling, suspension, trussing).
 - 3) Mechanically moved parts must not show any traces of wearing and must not rotate with unbalances.
 - 4) The electric power supply cables must not show any damage, material fatigue or sediments.
- Further instructions depending on the installation spot and usage have to be adhered by a skilled installer and any safety problems have to be removed.



CAUTION!

Disconnect from mains before starting maintenance operation.

We recommend a frequent cleaning of the device. Please use a moist, lint- free cloth. Never use alcohol or solvents.

There are no serviceable parts inside the device. Please refer to the instructions under “Installation instructions”.

Should you need any spare parts, please order genuine parts from your local dealer.

TECHNICAL SPECIFICATIONS

Power supply: AC 100V-240V~, 50Hz/60Hz

Power consumption: 360W

Packing dimensions: 47x45x59cm

Net weight: 15.5KGS

Gross weight: 19KGS

Remark: errors and omissions for every information given in this manual except. All information is subject to change without prior notice.