

ALLEN & HEATH



USER GUIDE

Publication AP7506

Limited One Year Warranty

This product is warranted to be free from defects in materials or workmanship for period of one year from the date of purchase by the original owner.

To ensure a high level of performance and reliability for which this equipment has been designed and manufactured, read this User Guide before operating. In the event of a failure, notify and return the defective unit to ALLEN & HEATH Limited or its authorised agent as soon as possible for repair under warranty subject to the following conditions

Conditions Of Warranty

The equipment has been installed and operated in accordance with the instructions in this User Guide.

The equipment has not been subject to misuse either intended or accidental, neglect, or alteration other than as described in the User Guide or Service Manual, or approved by ALLEN & HEATH.

Any necessary adjustment, alteration or repair has been carried out by ALLEN & HEATH or its authorised agent.

This warranty does not cover fader wear and tear.

The defective unit is to be returned carriage prepaid to ALLEN & HEATH or its authorised agent with proof of purchase.

Units returned should be packed to avoid transit damage.

In certain territories the terms may vary. Check with your ALLEN & HEATH agent for any additional warranty which may apply.

This product complies with the European Electro magnetic Compatibility directives 89/336/EEC & 92/31/EEC and the European Low Voltage Directives 73/23/EEC & 93/68/EEC.

This product has been tested to EN55103 Parts 1 & 2 1996 for use in Environments E1, E2, E3, and E4 to demonstrate compliance with the protection requirements in the European EMC directive 89/336/EEC. During some tests the specified performance figures of the product were affected. This is considered permissible and the product has been passed as acceptable for its intended use. Allen & Heath has a strict policy of ensuring all products are tested to the latest safety and EMC standards. Customers requiring more information about EMC and safety issues can contact Allen & Heath.

Allen & Heath XB-14 User Guide AP7506 Issue 3

Copyright © 2007 Allen & Heath Limited. All rights reserved

Allen & Heath Limited

Kernick Industrial Estate, Penryn, Cornwall, TR10 9LU, UK

<http://www.allen-heath.com>

PACKED ITEMS

Check that you have received the following:

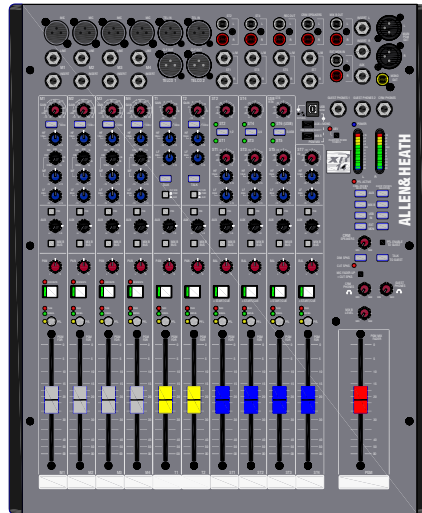

XB-14 MIXER

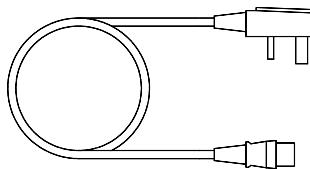

Mains Lead (or leads)

Check that the correct mains plug is fitted.



This User Guide

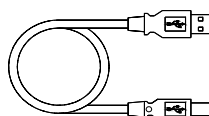

Type A-B USB Lead

To connect the XB-14 to your computer.

SAFETY INSTRUCTIONS

WARNINGS - Read the following before proceeding :



ATTENTION: RISQUE DE CHOC ELECTRIQUE – NE PAS OUVRIR

Read instructions: Retain these safety and operating instructions for future reference. Adhere to all warnings printed here and on the console. Follow the operating instructions printed in this User Guide.

Do not remove cover: Operate the console with its covers correctly fitted.

Power sources: Connect the console to a mains power unit only of the type described in this User Guide and marked on the rear panel. Use the power cord with sealed mains plug appropriate for your local mains supply as provided with the console. If the provided plug does not fit into your outlet consult your service agent for assistance.

Power cord routing: Route the power cord so that it is not likely to be walked on, stretched or pinched by items placed upon or against it.

Grounding: Do not defeat the grounding and polarisation means of the power cord plug. Do not remove or tamper with the ground connection in the power cord.



WARNING: This equipment must be earthed.

Water and moisture: To reduce the risk of fire or electric shock do not expose the console to rain or moisture or use it in damp or wet conditions. Do not place containers of liquids on it which might spill into any openings.

Ventilation: Do not obstruct the ventilation slots or position the console where the air flow required for ventilation is impeded. If the console is to be operated in a rack unit or flightcase ensure that it is constructed to allow adequate ventilation.

Heat and vibration: Do not locate the console in a place subject to excessive heat or direct sunlight as this could be a fire hazard. Locate the console away from any equipment which produces heat or causes excessive vibration.

Servicing: Switch off the equipment and unplug the power cord immediately if it is exposed to moisture, spilled liquid, objects fallen into the openings, the power cord or plug become damaged, during lightning storms, or if smoke, odour or noise is noticed. Refer servicing to qualified technical personnel only.

Installation: Install the console in accordance with the instructions printed in this User Guide. Do not connect the output of power amplifiers directly to the console. Use audio connectors and plugs only for their intended purpose.

SAFETY INSTRUCTIONS

Important Mains plug wiring instructions

The console is supplied with a moulded mains plug fitted to the AC mains power lead. Follow the instructions below if the mains plug has to be replaced. The wires in the mains lead are coloured in accordance with the following code:



TERMINAL		WIRE COLOUR	
		European	USA/Canada
L	LIVE	BROWN	BLACK
N	NEUTRAL	BLUE	WHITE
E	EARTH GND	GREEN & YELLOW	GREEN

The wire which is coloured Green and Yellow must be connected to the terminal in the plug which is marked with the letter E or with the Earth symbol. This appliance must be earthed.

The wire which is coloured Blue must be connected to the terminal in the plug which is marked with the letter N.

The wire which is coloured Brown must be connected to the terminal in the plug which is marked with the letter L.

Ensure that these colour codes are followed carefully in the event of the plug being changed.

General Precautions:

Damage : To prevent damage to the controls and cosmetics avoid placing heavy objects on the control surface, scratching the surface with sharp objects, or rough handling and vibration.

Environment : Protect from excessive dirt, dust, heat and vibration when operating and storing. Avoid tobacco ash, smoke, drinks spillage, and exposure to rain and moisture. If the console becomes wet, switch off and remove mains power immediately. Allow to dry out thoroughly before using again.

Cleaning : Avoid the use of chemicals, abrasives or solvents. The control panel is best cleaned with a soft brush and dry lint-free cloth. The faders, switches and potentiometers are lubricated for life. The use of electrical lubricants on these parts is not recommended. The fader and potentiometer knobs may be removed for cleaning with a warm soapy solution. Rinse and allow to dry fully before refitting them.

Transporting : The console may be transported as a free-standing unit or mounted in a rack or flightcase. Protect the controls from damage during transit. Use adequate packing if you need to ship the unit.

Hearing : To avoid damage to your hearing do not operate any sound system at excessively high volume. This applies particularly to close-to-ear monitoring such as headphones and in-ear systems. Continued exposure to high volume sound can cause frequency selective or wide range hearing loss.



CONTENTS

Thank you for purchasing your Allen & Heath XB-14 mixer. To ensure that you get the maximum benefit from the unit please spare a few minutes familiarizing yourself with the controls and setup procedures outlined in this user guide. For further information please refer to the additional information available on our web site, or contact our technical support team.

<http://www.allen-heath.com>

<http://www.allen-heath.com/xb>

Warranty	3
Packed Items.....	4
Safety Instructions	5
Contents.....	7
Panel Drawings.....	8
Introduction to XB-14.....	9
Specifications	10
Dimensions	12
Block Diagram.....	13
Mono Input Channel.....	14
TELCO Channels 1&2.....	17
Stereo Input Channel ST1 & ST2....	20
Stereo Input Channels ST3 & ST4..	22
Master Section	23
Remote Interface connectors.....	26
On Switch Options	27
Remote Interface wiring	28
USB Connecting to a Computer	29
Application Diagram—Self Op.....	30
Application Diagram—Studio.....	31
Tips— off-air recording.....	32
Tips— Recording Playback.....	33
Fixing into a Rack or furniture	34
General wiring notes	35
Product Support.....	36

PANEL DRAWINGS

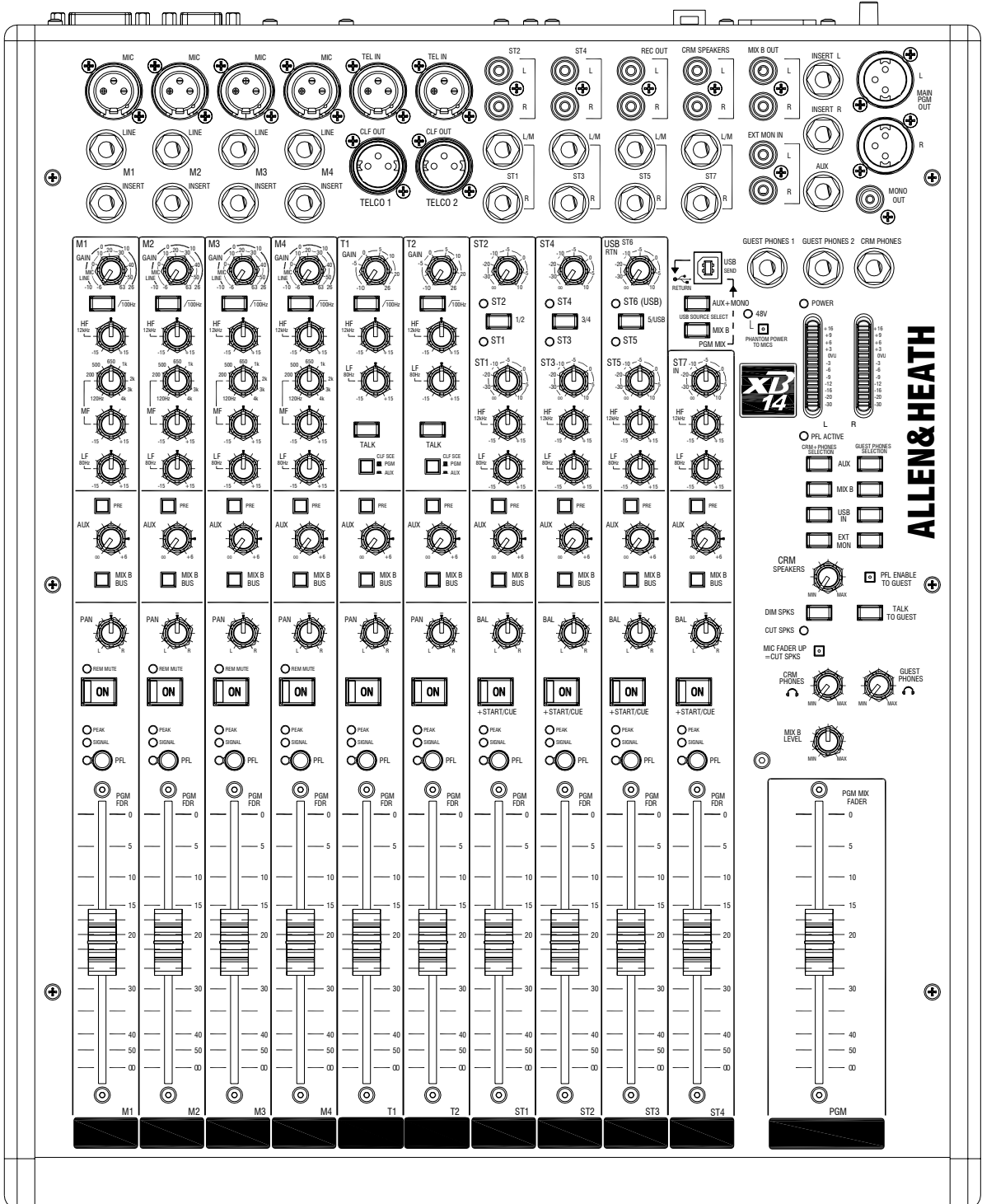
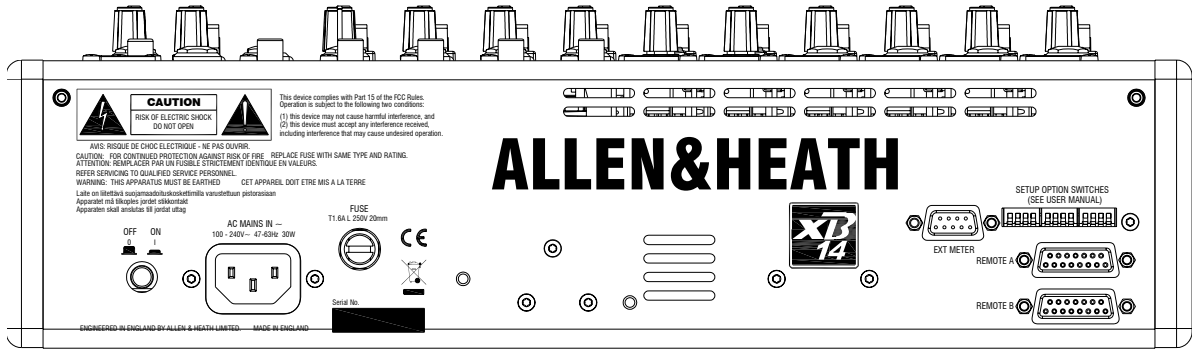

INTRODUCTION TO THE XB-14

The following is a technical overview of XB-14, if you want to, please skip to the next section.

The Allen & Heath XB-14 mixer has been carefully and lovingly designed in the beautiful county of Cornwall in the UK and is manufactured alongside a wide range of professional audio mixing consoles. Many of the components used in the XB-14 are exactly the same as in the larger Allen & Heath products and the construction methods are also very similar — utilising individual vertically mounted channel circuit boards with each rotary control fixed with a metal nut to the front panel. This provides a very robust product that will resist damage and give years of reliable use. It also makes servicing much easier should it be required, with the ability to remove one particular channel from the mixer at a time, or easily change a fader.

The audio circuitry is based on years of continual development and refinement, the performance of all the elements within the mixer scrutinised and perfected to ensure the very best sound quality possible.

Multi-application:

The XB-14 is great for a range of applications from small radio or internet broadcast studios, or for larger studios with multiple rooms, for hospital radio, university radio and community radio broadcast applications. The XB-14 has a wealth of features specifically designed for broadcasters, things like telephone communication modules for telephone callers, mic fader start sensing for external connection and internal automatic muting of the speaker outputs, stereo channel start/cue outputs for CD deck transport control, separate headphones mix & outputs for guests, an audition bus.... The list goes on!

Mic/Line Pre-amps:

The XB-14 pre-amps use a two stage design, with carefully controlled amounts of gain in each stage. When amplifying the signal from the XLR input, the gain range is huge (69dB of range to be exact) and is very evenly distributed around the gain control, meaning better control of signal level. Most of the gain comes from the first stage, so unwanted noise is kept to a minimum. There is no “pad” switch, or pad circuit — line level signals are simply plugged into the second stage of the pre-amp by using the line input jack socket. This has the great advantage of lower noise when using the line input. (It is common to attenuate line level signals, then amplify them back up again which can give more noise or hiss).

EQ:

The XB-14 is equipped with a 3-band equaliser circuit on each mono input and a 2-band EQ on the Telco & stereo channels. The frequency and response of each has been carefully chosen to give the maximum performance when using the EQ on a variety of sources.

AUX bus:

XB-14 has a single Auxiliary bus that can be used for external processing, effects, recording or auditioning.

MIX B:

A separate stereo mix bus is provided for recording an independent mix to the main program mix, or creating a clean feed source with selected channels.

Remote Control:

The mono mic/line channels have fader start logic switching enabling them to control external equipment or automatically mute the speaker outputs to prevent acoustic feedback in localised or self-operated applications. The stereo channels have start & cue logic outputs available to hook up to external equipment like CD players. There are also options to mute the mono inputs remotely using an external “cough” switch or similar.

USB:

Getting audio to and from a computer easily is now a common requirement for sound and music production and broadcast applications. The way we have implemented this on XB-14 is super-flexible and super-easy! No longer do you need to fiddle around the back of your computer to get to the soundcard inputs, only to find that the levels are all wrong and noisy. Just plug in a USB lead to your XB-14, select the USB routing on the mixer and the device on your computer and that's it! Quality audio to and from your PC or MAC.

Self operation or Producer operated:

Whether you need a mixer for a self operated broadcast situation, or whether you have a separate studio and engineer, the XB-14 has the features to fit. Separate monitor mixes can be created for operator and guests or presenter so the engineer can check levels and cue sources while the presenter or guest can listen to a different source. The engineer/producer can communicate to the guest or presenter using the Talk feature, as well as off-air communication to telephone callers.

There is also the facility for remote control of channel mutes from the studio using the remote interface connectors, ideal for studio situated mute switches.

SPECIFICATIONS (to be completed)

Operating Levels	
Input	
Mono channel Mic input (XLR)	+6 to -63dBu for nominal (+17dBu in max)
Mono channel Line input (TRS Jack socket)	+10 to -26dBu (+30dBu maximum)
Insert point (TRS Jack socket)	0dBu nominal +21dBu maximum
Stereo input (TRS Jack sockets)	0dBu nominal (control = Off to +10dB)
Stereo input (RCA phono sockets)	0dBu nominal (control = Off to +10dB)
Telco channel input (XLR)	+10 to -26dBu (+30dBu maximum)
External monitor inputs (RCA phono sockets)	0dBu Nominal
Output	
PGM L & R outputs (XLR)	+4dBu nominal. +25dBu maximum.
PGM Mono output (RCA phono)	0dBu nominal. +21dBu maximum.
PGM L & R inserts (TRS jack sockets)	-2dBu nominal. +21dBu maximum
Aux output (Jack socket)	0dBu nominal. +21dBu maximum.
Mix B outputs (RCA phono sockets)	0dBu nominal. +21dBu maximum.
Rec outputs (RCA phono sockets)	0dBu nominal. +21dBu maximum.
Telco output (XLR)	0dBu nominal. +21dBu maximum.
CRM Speaker outputs (RCA phono sockets)	0dBu nominal. +21dBu maximum.

THD+n	
Mic in to PGM L/R Out, 0dB gain 1kHz +10dBu out	0.003%
Mic in to PGM Out, 30dB gain 1kHz	0.007%
Line in to PGM L/R out 0dB gain 0dBu 1kHz	0.004%
Stereo in to PGM out 0dB gain +10dBu 1kHz	0.003%

USB Audio CODEC (Coder/Decoder)	
USB Audio In/Out	USB 1.1 compliant 16bit.
Sample Rate	32, 44.1, or 48kHz

Noise	
Mic Pre EIN @ max gain 150R input Z 22-22kHz	-127dBu
PGM out, PGM fader = 0, 22-22kHz	-92dBu
Aux out, Mono out, Mix B out = 0, 22-22kHz	-90dBu

SPECIFICATIONS (continued)

Headroom	
Analogue Headroom from nominal (0Vu) Outputs	21 dB
Analogue Headroom from nominal (0Vu) Mix point	24dB
USB in & out headroom from nominal (0Vu)	14dB

Crosstalk & Attenuation (dB 22-22kHz)	
Mono fader attenuation (dB relative to +10dBu) 1kHz/10kHz	-100/-90
Mono ON switch attenuation (dB relative to +10dBu) 1kHz/10kHz	-100/-90
TELCO fader attenuation (dB relative to +10dBu) 1kHz/10kHz	-99/-92
TELCO ON switch attenuation (dB relative to +10dBu) 1kHz/10kHz	-100/-100
Stereo fader attenuation (dB relative to +10dBu) 1kHz/10kHz	-99/-86
Stereo ON switch attenuation (dB relative to +10dBu) 1kHz/10kHz	-100/-93
PGM fader attenuation (dB relative to +10dBu) 1kHz/10kHz	-102/-99
TELCO clean-feed isolation from I/P (dB relative to +10dBu) 1kHz/10kHz	-57/-40
Stereo separation, L in to PGM R out. dB 1kHz/10kHz	-77/-56

Frequency Response	
Mic in to PGM L/R Out, 30dB gain	+0.5/-1dB 20Hz to 20kHz.
Line in to PGM L/R out 0dB gain	+0.5/-1dB 10Hz to 30kHz
Stereo in to PGM L/R out	+0.5/-1dB 10Hz to 30kHz

Dimensions

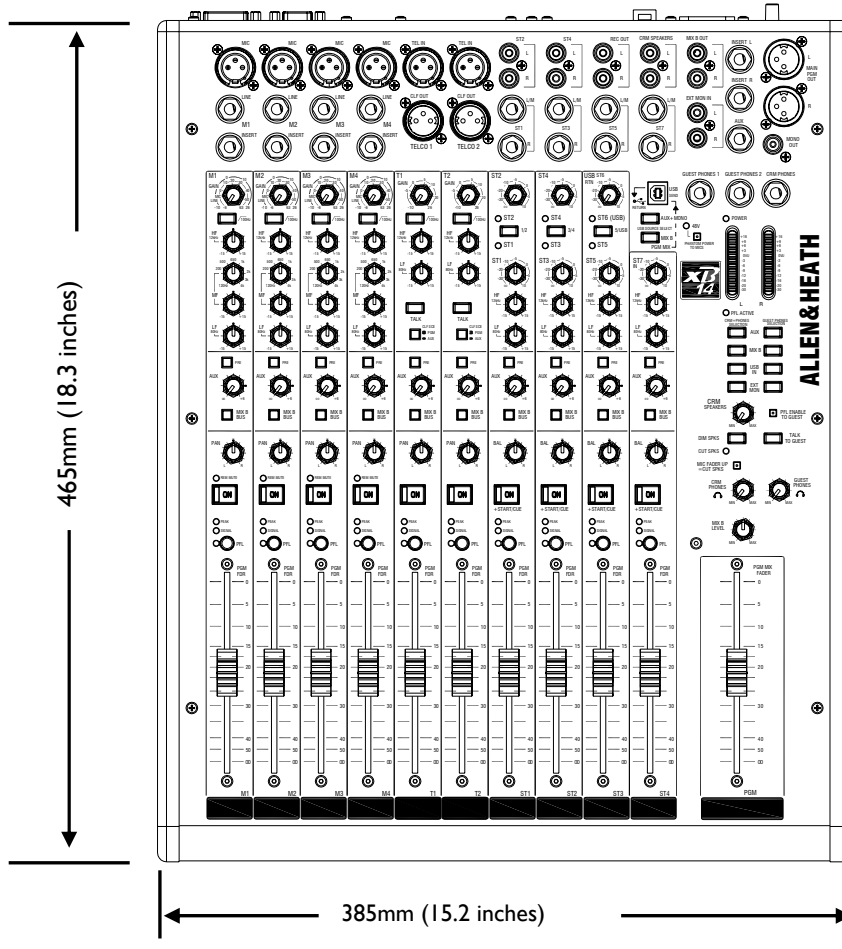

The plastic side trims are 12.5mm each so width with trims removed = 360mm.

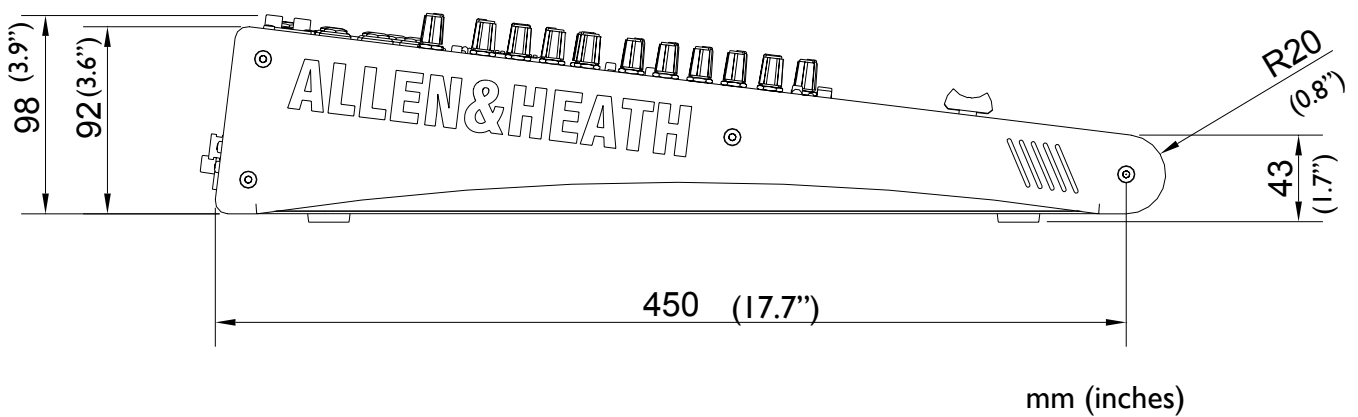

Weight	
	XB-14
Unpacked	7.5kg (16.5lb)
Packed	11.5kg (25.3lb)

A rack mounting kit is available for XB-14. The part number is: ZED1402-RK19

BLOCK DIAGRAM

XB-14 BLOCK DIAGRAM

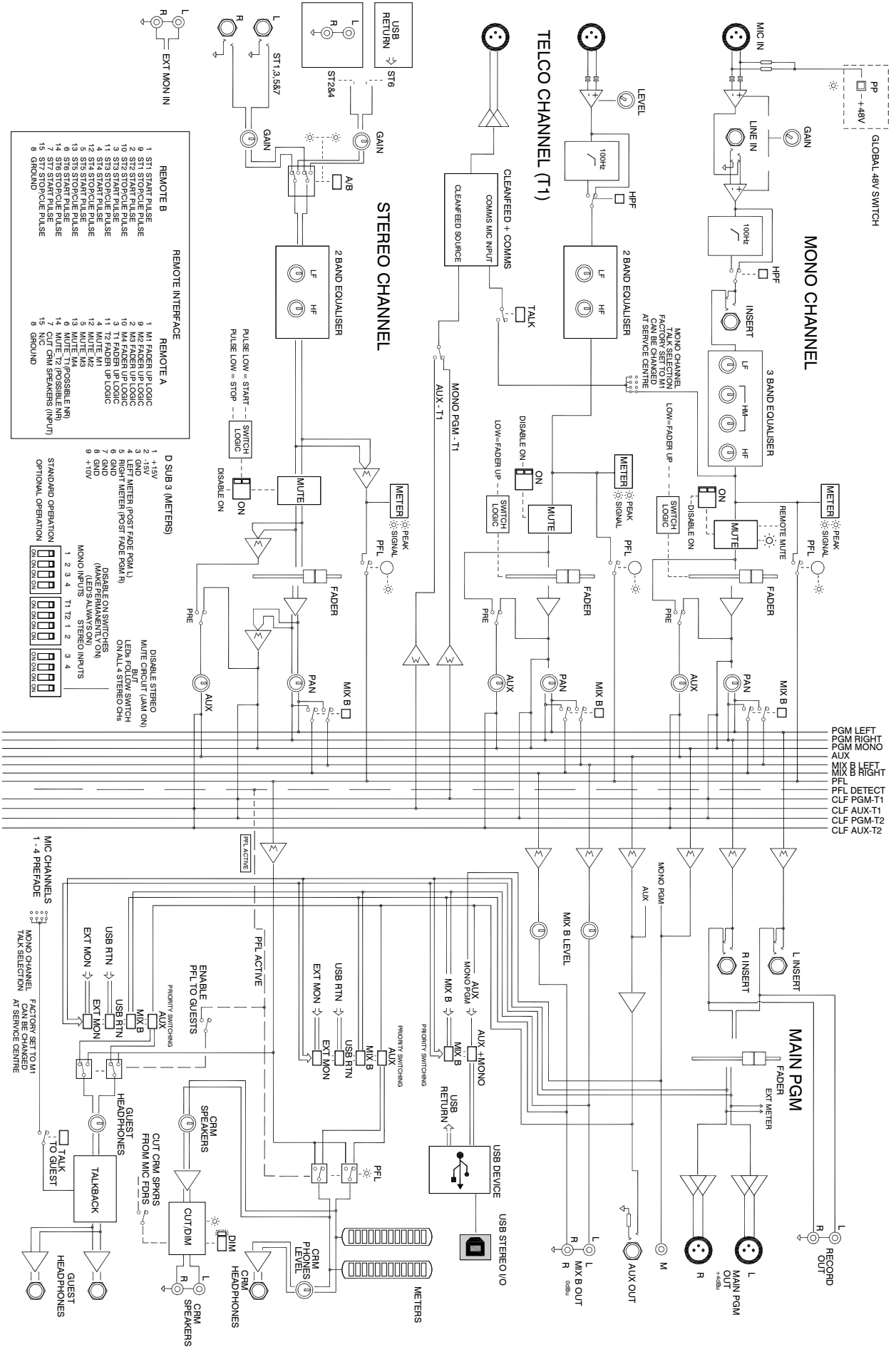

PGM LEFT
PGM RIGHT
PGM MONO
AUX
MIX B LEFT
MIX B RIGHT
PFL
PFL DETECT
CLF PGM-T1
CLF AUX-T1
CLF PGM-T2
CLF AUX-T2

- REMOTE B**
- ST1 START PULSE
 - ST1 STOP/SCUE PULSE
 - ST2 START PULSE
 - ST2 STOP/SCUE PULSE
 - ST3 START PULSE
 - ST3 STOP/SCUE PULSE
 - ST4 START PULSE
 - ST4 STOP/SCUE PULSE
 - ST5 START PULSE
 - ST5 STOP/SCUE PULSE
 - ST6 START PULSE
 - ST6 STOP/SCUE PULSE
 - ST7 START PULSE
 - ST7 STOP/SCUE PULSE
 - NC
 - GROUND
- REMOTE A**
- M1 FADER UP LOGIC
 - M2 FADER UP LOGIC
 - M3 FADER UP LOGIC
 - M4 FADER UP LOGIC
 - T1 FADER UP LOGIC
 - T2 FADER UP LOGIC
 - T3 FADER UP LOGIC
 - MUTE M1
 - MUTE M2
 - MUTE M3
 - MUTE M4
 - MUTE T1 (POSSIBLE M/N)
 - MUTE T2 (POSSIBLE M/N)
 - CUT CRM SPEAKERS (INPUT)
 - NC
 - GROUND
- D SUB 3 (METERS)**
- +15V
 - GROUND
 - GROUND
 - LEFT METER (POST FADE PGM L)
 - RIGHT METER (POST FADE PGM R)
 - T1 FADER UP LOGIC
 - GROUND
 - GROUND
 - +10V
- OPTIONAL OPERATION**
- | | | | | | | | | | |
|----|----|----|----|----|----|----|----|----|----|
| ON | ON | ON | ON | ON | ON | ON | ON | ON | ON |
| 1 | 2 | 3 | 4 | 1 | 2 | 3 | 4 | 1 | 2 |
| ON | ON | ON | ON | ON | ON | ON | ON | ON | ON |
| 1 | 2 | 3 | 4 | 1 | 2 | 3 | 4 | 1 | 2 |
| ON | ON | ON | ON | ON | ON | ON | ON | ON | ON |
- STANDARD OPERATION**
- | | | | | | | | | | |
|----|----|----|----|----|----|----|----|----|----|
| ON | ON | ON | ON | ON | ON | ON | ON | ON | ON |
| 1 | 2 | 3 | 4 | 1 | 2 | 3 | 4 | 1 | 2 |
| ON | ON | ON | ON | ON | ON | ON | ON | ON | ON |
| 1 | 2 | 3 | 4 | 1 | 2 | 3 | 4 | 1 | 2 |
| ON | ON | ON | ON | ON | ON | ON | ON | ON | ON |

MONO INPUT CHANNEL

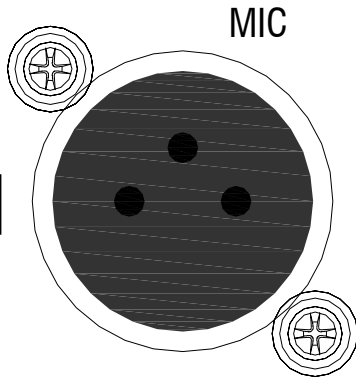

1

Mic Input Socket

Standard 3-Pin XLR socket wired as Pin 1=Chassis, Pin 2=hot (+), Pin 3=Cold (-).

1

2

Line Input Jack Socket

Standard 1/4" (6.25mm) Jack socket for balanced or unbalanced line level signals. Wired Tip=Hot (+), Ring=cold (-), Sleeve=Chassis.

The Line input overrides the Mic input, so if you want to hear something plugged in to the xlr socket, make sure nothing is plugged into the Line input.

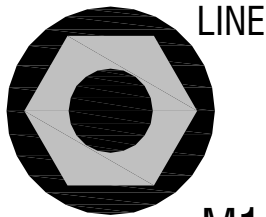

2

3

Insert Jack Socket

Standard 1/4" (6.25mm) Jack socket for unbalanced insert send and return signals. Wired Tip=send, Ring=return, Sleeve=Chassis. Nominal level is 0dBu. The insert point is after the 100Hz filter and before the EQ.

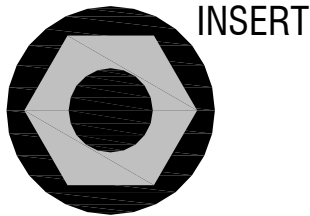

3

4

Gain Control

This adjusts the gain of the input amplifier to match the signal level of the input. The gain is varied from -6dB (attenuation) to +63dB for signals plugged in to the xlr socket (Mic Input) and -10dB to +26dB for signals plugged into the Line input jack.

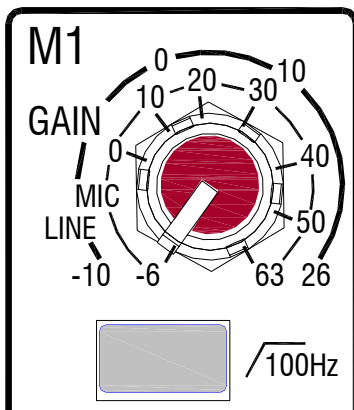

4

5

5

100Hz High Pass Filter

The Hi-pass filter is used for reducing pop noise and rumble from microphone signals. It is a 2-pole (12dB per octave) filter with a corner frequency set at 100Hz.

The filter affects signals from both Mic XLR and Line jack socket.

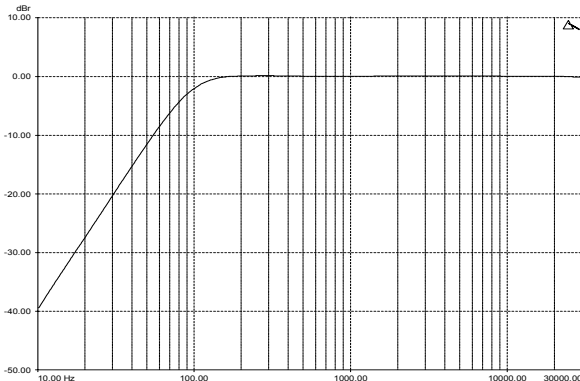

MONO INPUT CHANNEL

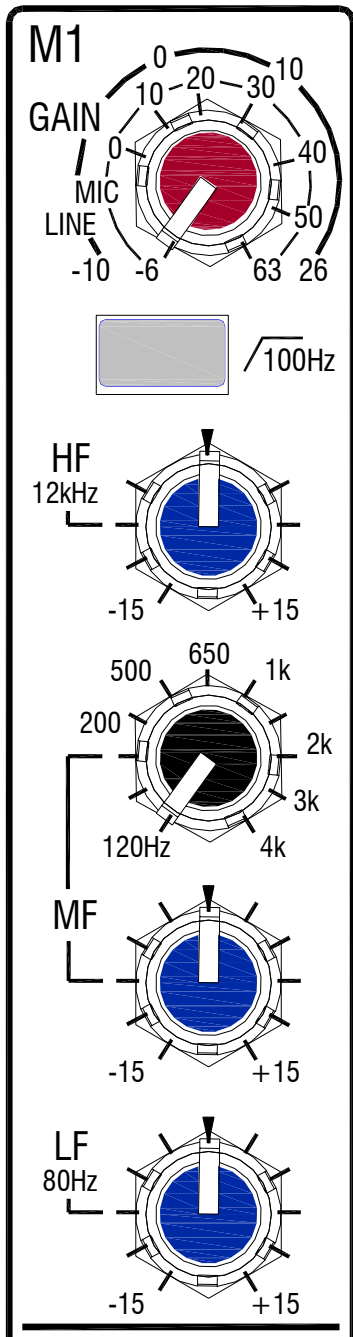

6

6

HF EQ

The HF (High Frequency) equaliser affects the frequency response of the higher audible frequencies. The corner frequency of 12kHz is around 3dB from the maximum cut or boost of the circuit. It has plenty of gain and actually gives slightly more than the +/-15dB legend suggests.

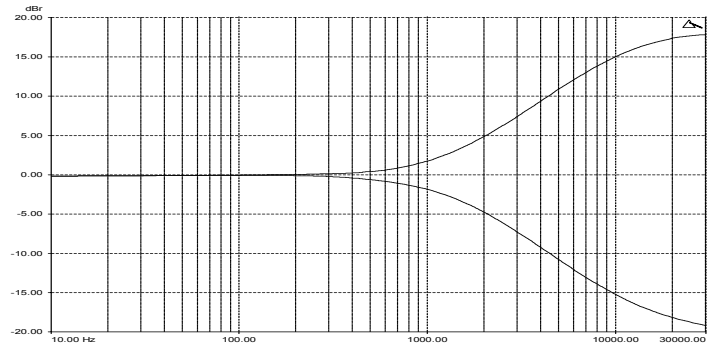

7

7

MF EQ

The MF (Mid Frequency) equaliser affects the middle of the audible frequency range. The frequency graduations on the sweep control are the centre frequencies of the EQ. The range has been carefully chosen to cover “boomy” frequencies around 120Hz to 250Hz which may need cutting back, or a lift at 2 to 3kHz may be required for microphone intelligibility.

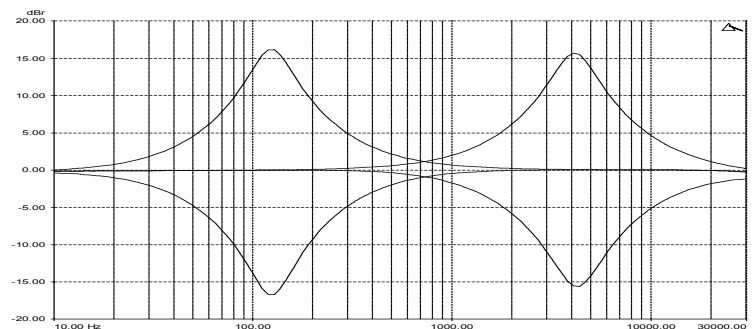

8

8

LF EQ

The LF (Low Frequency) equaliser affects the response at the low end of the audio range. The graph shows the response of the LF EQ at maximum cut and boost. The corner frequency is 80Hz.

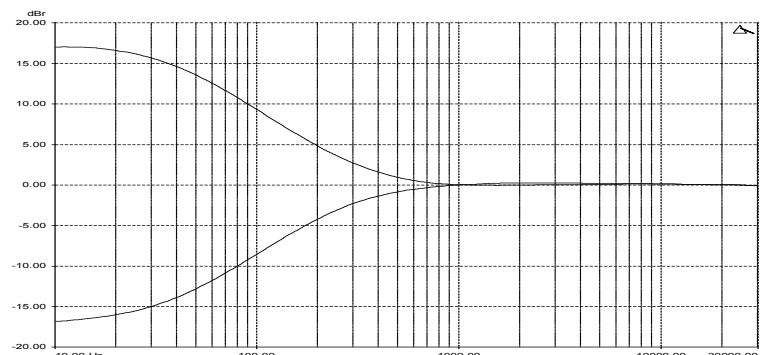

MONO INPUT CHANNEL

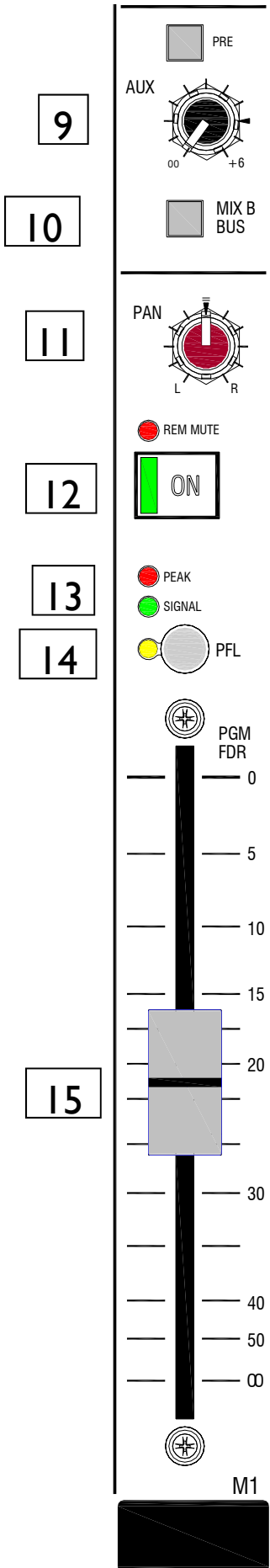

9

Aux

This control sends a signal to an auxiliary bus. The signal is sourced pre-fade or post-fade depending on the PRE switch position. The pre-fade source selection will be affected by the channel ON/OFF switch if active. The send control varies the signal level to the bus from off (fully attenuated) to +6dB, with unity gain at the arrow.

10

MIX B

The MIX B switch routes the channel signal to a stereo bus which is independent of the main PGM (program) bus. The signal is post-fade and follows the PAN control. The MIX B bus can be used for creating mixes for re-cording or clean-feed sources for external equipment.

11

PAN

The pan control adjusts how the signal from the mono input channel is shared between the left and right sides of the PGM bus and the MIX B bus. Set to the mid position, equal amounts of signal are fed to left and right, with pan set to L, none is sent to the Right bus.

12

ON Switch

This mechanically latching switch operates the channel mute circuitry, turning the signal to the PGM, MIX B and Aux buses on or off. The switch is illuminated green when pressed.

There is an option to disable the switch (make permanently ON) using the option switches on the rear-panel. If this is activated, then the switch will be illuminated green regardless of whether it is pressed or not.

There is also a remote mute option wired to a D type connector on the rear panel. When this is wired and operated the REM MUTE red LED illuminates and the mute circuit is activated regardless of whether the ON switch is pressed.

13

SIGNAL & PEAK LEDs

The Signal LED illuminates when the pre-fader signal level is above -15dB. The Peak LED illuminates and stays on for around 0.5 seconds when a peak level is detected (pre-fader signal) within 5dB of clipping.

14

PFL Switch

The PFL (Pre-Fade Listen) switch sends the channel signal to the PFL bus and subsequently to the headphones/CRM speakers and the main L R meters. Used for checking the audio signal before raising the fader or un-muting the channel or raising the fader.

15

Fader

The 100mm fader controls the level of the channel signal to the left & right PGM bus, MIX B bus and post fade Aux.

The Mono channel faders have Fader Start switching logic available to either interface to external equipment or activate the muting circuit for the control room speaker outputs.

TELCO CHANNELS 1&2

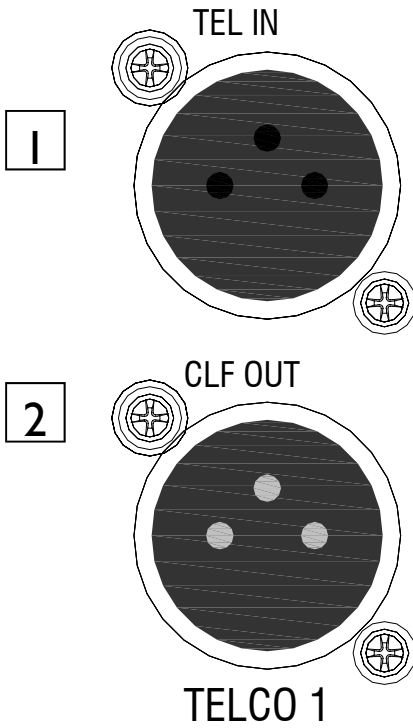

1 TEL IN
The Telephone Communication channel input XLR socket. Wired as Pin 1=Chassis, Pin 2=hot (+), Pin 3=Cold (-).

2 CLF OUT
Standard XLR output connector for the Clean-Feed output from the Telephone Communication channel. Wired Pin 1=Chassis, Pin 2=hot (+), Pin 3=Cold (impedance balanced ground).

3 TELCO Input Gain
The Telephone Communication channel input gain control. Varies the gain applied to the TELCO input channel from -10dB to +26dB.

4 100Hz High Pass filter
Similar to the mono input channel, a 12dB per octave 2-pole high pass filter used to filter out any low frequency rumble or pops on the TELCO channel input.

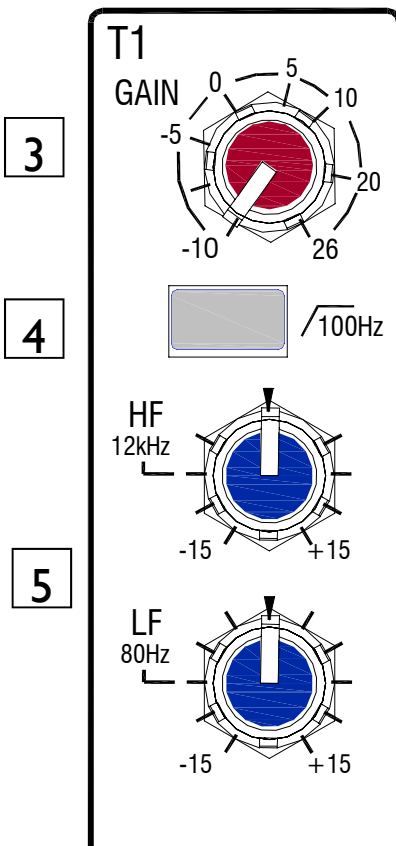

5 TELCO Channel EQ
The TELCO Channel EQ is 2 band with corner frequencies of 12kHz for the HF and 80Hz for the LF.

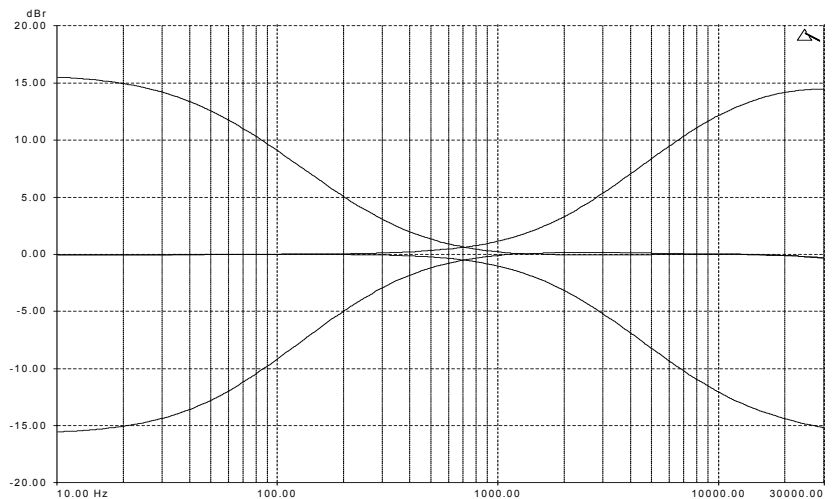

TELCO CHANNELS 1&2

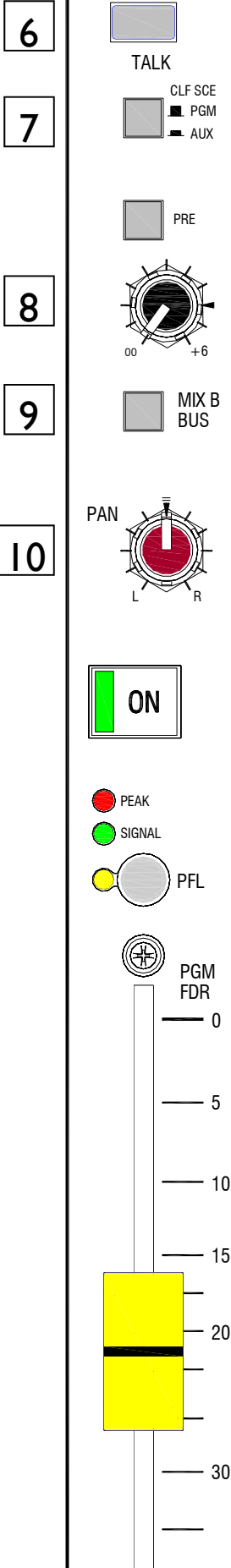

6 TALK
 The TALK switch enables the presenter or operator to communicate with the telephone caller with the presenters channel fader down so the presenters voice does not go to the program mix.
 The source for the TALK signal is one of the mono channels, pre-selected by links set within the XB-14, the factory default is mono channel 1. The signal source is pre-fade and pre-mute on the selected mono channel.

7 CLF SCE
 The Clean-Feed Source switch selects the signal source for the TELCO output. In the un-pressed position the signal will be the entire program (PGM) mix (pre main PGM fader) but without the signal from the input on that TELCO channel, so the caller does not hear any distracting echo of their voice.
 If the switch is pressed, the TELCO output signal is sourced from the AUX bus, but minus the AUX signal sent from that TELCO channel.

This is a really useful feature that can enable the operator to send a mix of signals from different channels to the telephone caller using the AUX bus, the sources may be on or off air because the sources for the AUX bus can be pre or post fader.
 In addition, the AUX bus can be used for off-air audition or recording of an interview with a telephone caller (or callers), using pre-fade signals to the AUX bus for later playback or editing for the broadcast. By pressing the CLF SCE switch the caller will hear the audition mix, or the off-air record mix without their own voice.

8 AUX
 This control sends a signal to an auxiliary bus. The signal is sourced pre-fade or post-fade depending on the PRE switch position. The pre-fade source selection will be affected by the channel ON/OFF switch if active. The send control varies the signal level to the bus from off (fully attenuated) to +6dB, with unity gain at the arrow.

9 MIX B
 The MIX B switch routes the channel signal to a stereo bus which is independent of the main PGM (program) bus. The signal is post-fade and follows the PAN control. The MIX B bus can be used for creating mixes for recording or clean-feed sources for external equipment.

10 PAN
 The pan control adjusts how the signal from the TELCO input channel is shared between the left and right sides of the PGM bus and the MIX B bus. Set to the mid position, equal amounts of signal are fed to left and right, with pan set to L, none is sent to the Right bus.

TELCO CHANNELS 1&2

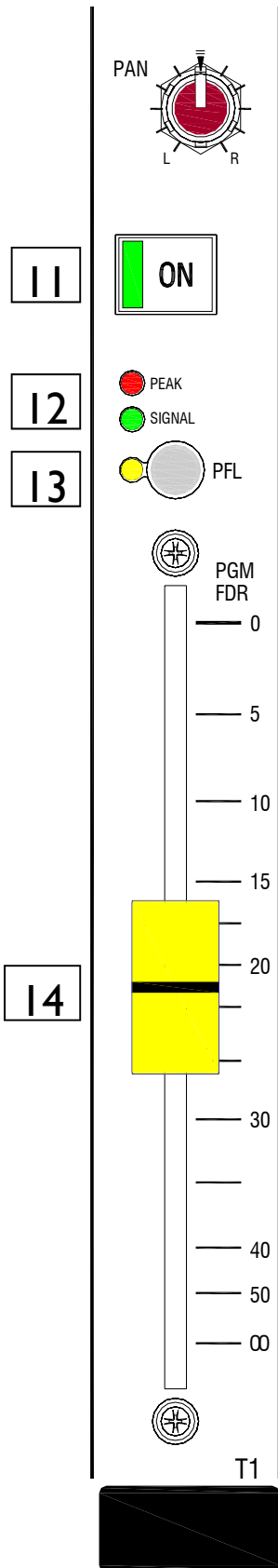

11

ON Switch

This mechanically latching switch operates the TELCO channel mute circuitry, turning the signal to the PGM, MIX B and Aux buses on or off. The switch is illuminated green when pressed.

There is an option to disable the switch (make permanently ON) using the option switches on the rear-panel. If this is activated, then the switch will be illuminated green regardless of whether it is pressed or not.

12

SIGNAL & PEAK LEDs

The Signal LED illuminates when the pre-fader signal level is above -15dB .

The Peak LED illuminates and stays on for around 0.5 seconds when a peak level is detected (pre-fader signal) within 5dB of clipping.

13

PFL Switch

The PFL (Pre-Fade Listen) switch sends the channel signal to the PFL bus and subsequently to the headphones/CRM speakers and the main L R meters. Used for checking the audio signal before raising the fader or switching on the channel or raising the fader.

14

Fader

The 100mm fader controls the level of the TELCO channel signal to the left & right PGM bus, MIX B bus and post fade Aux.

The TELCO channel faders have fader start switching logic signals available on the rear-panel remote interface connectors for control of external equipment.

STEREO INPUT CHANNELS ST1 & ST2

FOR CLARITY ONLY ST1 CHANNEL IS DESCRIBED HERE

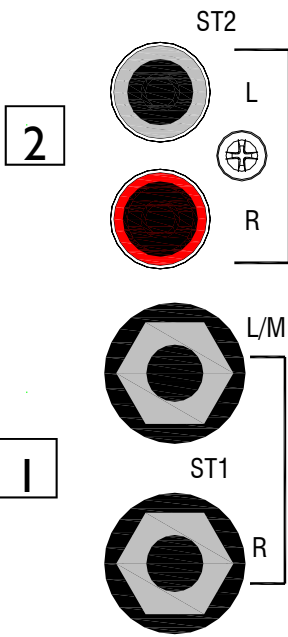

1 ST1 Inputs
Standard 1/4" jack sockets for input signals to ST1 L & R inputs. Wired Tip=Hot(+), Ring=cold (-), Sleeve=Chassis. Fully balanced. Nominal input level = 0dBu.

2 ST2 Inputs
Standard RCA phono sockets for ST2 L & R inputs. Unbalanced. Nominal input level = 0dBu.

3 Stereo source selector switch
Selects either ST1 or ST2 stereo inputs to the stereo channel ST1. Allows the user to select between multiple stereo sources connected to the XB-14. A green LED will illuminate to show which input is selected.

4 Stereo input level controls
For adjustment of the stereo input levels from fully attenuated to +10dB of gain.

5 Stereo channel EQ
The stereo channel EQ is 2 band with corner frequencies of 12kHz for the HF and 80Hz for the LF.

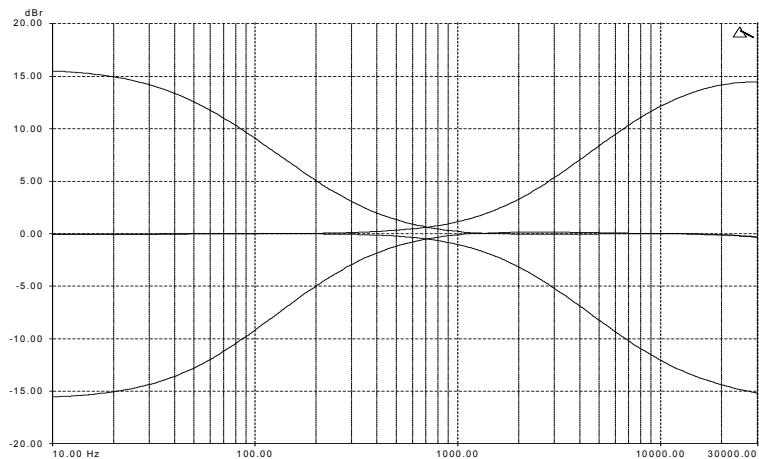
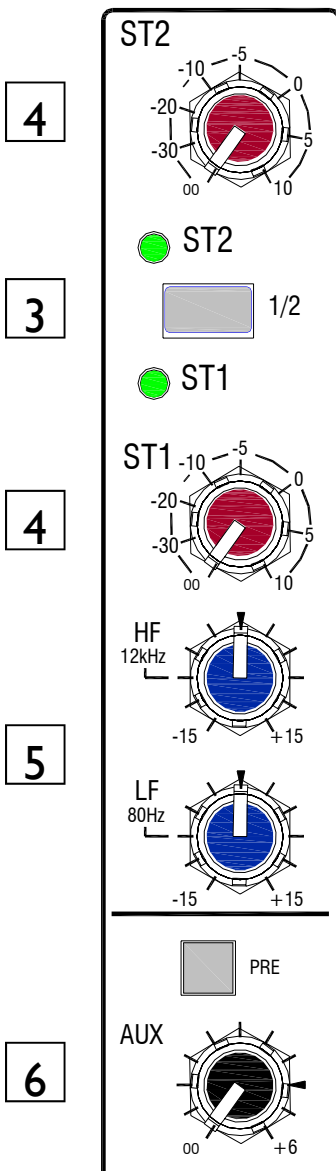

6 AUX
This control sends a signal to an auxiliary bus. The signal is sourced pre-fade or post-fade depending on the PRE switch position and is a combined sum of the left and right stereo signals. The pre-fade source selection will be affected by the channel ON/OFF switch if active. The send control varies the signal level to the bus from off (fully attenuated) to +6dB, with unity gain at the arrow.

STEREO INPUT CHANNELS ST1 & ST2

FOR CLARITY ONLY ST1 CHANNEL IS DESCRIBED HERE

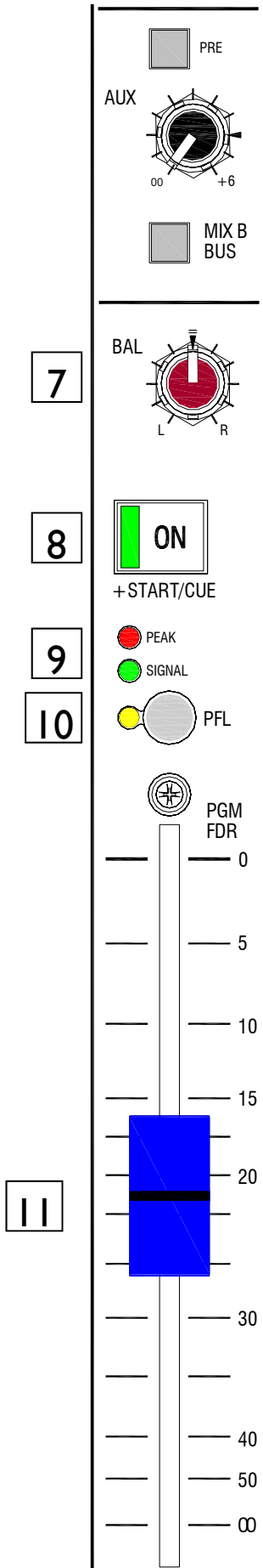

7

BAL

The balance control adjusts the relative levels of the left & right signals in the stereo input channel as they are sent to the PGM bus and the MIX B bus. Set to the mid position, the signals are balanced equally. With the balance control set fully anticlockwise the right channel will be fully attenuated and the left channel will increase by approximately 3.5dB.

8

ON (+START/CUE) switch

The stereo channel ON switch operates the stereo channel mute circuitry, turning the signals to the PGM, MIX B and Aux buses on or off. The switch is illuminated green when pressed. The ON switch also activates the START/CUE logic signals (for the corresponding selected input) wired to the remote interface connector on the rear panel.

There is an option to disable the mute circuit on all the stereo channels (make the channels permanently ON) using the option switches on the rear panel. This can be done for all 4 stereo channels together, retaining the illumination switching (if the ON switch is being used for Start/Cue). It can also be done on an individual channel basis by using the STEREO INPUTS 1,2,3&4 slide switches in which case the illumination of the switch will be jammed permanently ON.

STEREO ON Switch Optional Modes

Standard Operation

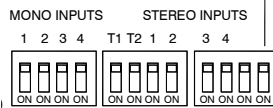

ON Switch Not Pressed



ON Switch Pressed



Mute Disabled (Always ON) LEDs FOLLOW SWITCH (All stereos)

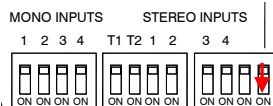

Mute Disabled (Always ON All Stereos) LEDs always illuminated (On ST1 only)

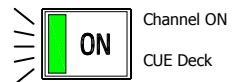
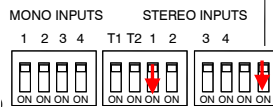

9

SIGNAL & PEAK LEDs

The Signal LED illuminates when the pre-fader L or R signal level is above -15dB.

The Peak LED illuminates and stays on for around 0.5 seconds when a peak level is detected (pre-fader signal) within 5dB of clipping.

10

PFL Switch

Sends the summed L & R stereo channel signals to the PFL bus.

11

Fader

The 100mm fader controls the level of the stereo channel L & R signals to the PGM bus, MIX B bus and post fade Aux.

There is no fader start logic feature on the stereo channel faders.

STEREO INPUT CHANNELS ST3 & 4

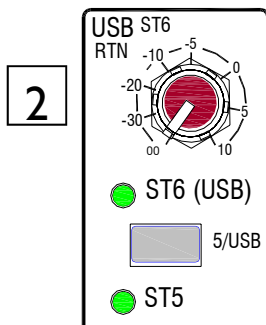
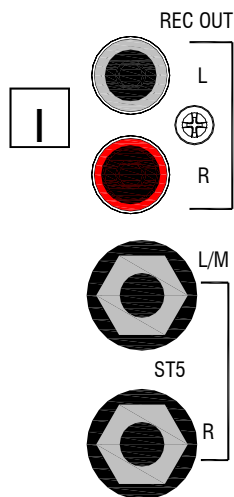

**SIMILAR TO THE ST1 & 2 CHANNELS—
THE DIFFERENCES ARE DETAILED HERE.**

1 REC OUT
Standard RCA phono sockets for the record output which is sourced from pre the main PGM fader, and just after the main L & R inserts. Nominal level = 0dBu, unbalanced.

2 USB RTN (ST6) level
The source for the ST6 input is from the USB audio device, in other words from an external computer. The level control varies the gain applied to the USB audio device input signal from off (fully attenuated) to +10dB.

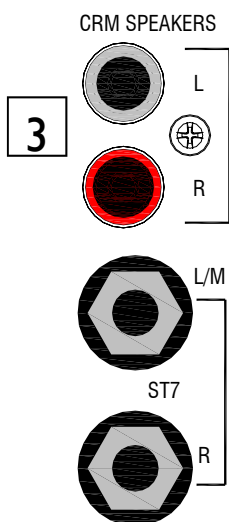

3 CRM SPEAKERS outputs
Standard RCA phono sockets for connecting to either powered speakers or a stereo amplifier for the control room speakers. . Nominal level = 0dBu, unbalanced.

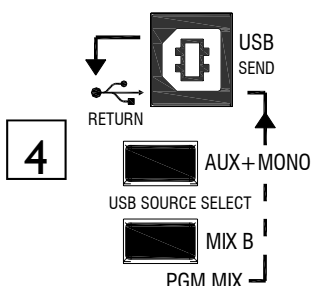

4 USB audio send & return
The USB connection uses a USB1.1 compliant stereo USB audio CODEC which is also fully compliant with USB 2. The connector is a standard USB “B Type” connector. When connected to a computer (Windows or Mac) you will be able to transfer stereo audio to and from the XB-14. The signal source for the send is selected using the switches below the USB connector. If both switches are un-pressed, the post-fader main program mix will be sent to the USB output, if the MIX B button is pressed the post-level MIX B signal is sent and if AUX+MONO is pressed then the Aux signal is sent on the USB left channel and the Mono program mix is sent on the right channel. The USB audio input can be selected to feed the stereo channel 4 (ST4) by selecting the stereo input 6 (ST6) to that channel.

MASTER SECTION

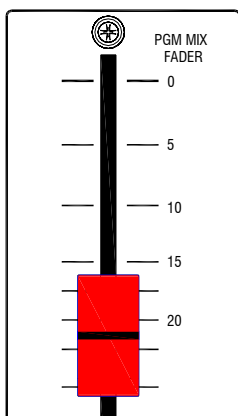
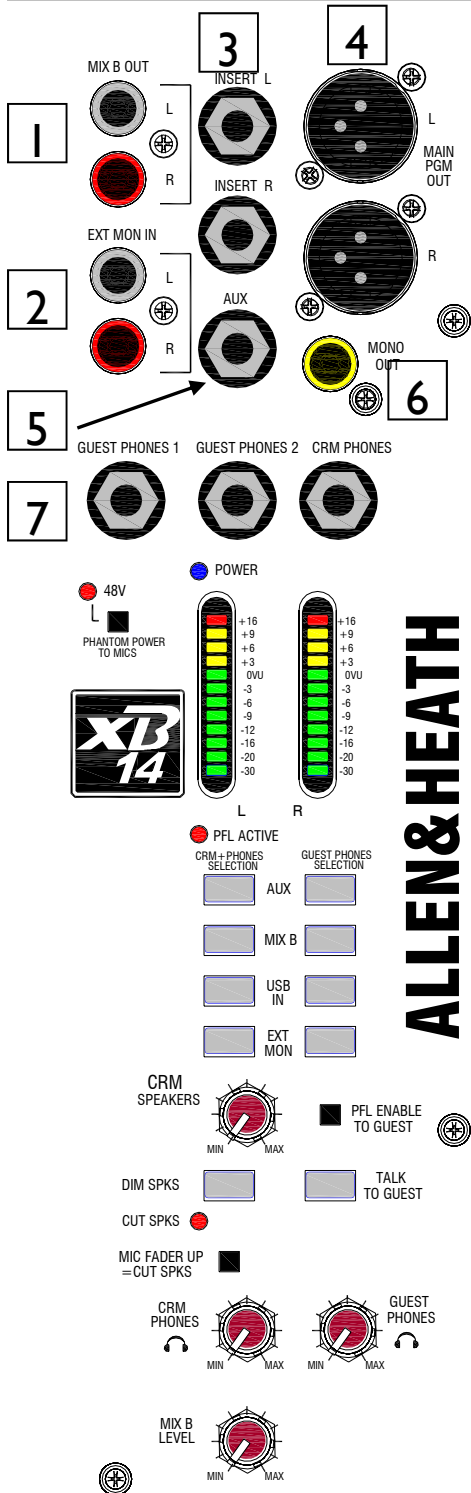

- 1 MIX B OUT**
Standard RCA phono sockets for the MIX B bus output. The output level can be controlled by the MIX B Level control.
Nominal level = 0dBu, unbalanced.
- 2 External Monitor Input**
Standard RCA phono sockets for a stereo signal which can be routed to either the engineers' CRM monitor headphones & speakers, or the guest headphones. It can be used for monitoring the program transmission or switching any external stereo source to the engineers or guests monitors.
Nominal level = 0dBu, unbalanced.
- 3 Main PGM Inserts**
Standard 1/4" (6.25mm) Jack socket for unbalanced insert send and return signals.
Wired Tip=send, Ring=return, Sleeve=Chassis. Nominal level is 0dBu. The insert point is pre the main PGM fader.
- 4 Main PGM Outputs**
Standard XLR output connector for the main program mix left & right outputs.
Wired Pin 1=Chassis, Pin 2=hot (+), Pin 3=Cold (-).
Electronically balanced, nominal level = +4dBu (=0VU).
- 5 AUX Output**
Standard 1/4" (6.25mm) Jack socket for aux output.
Wired Tip=Hot (+), Ring=cold (-), Sleeve=Chassis. Impedance balanced. Nominal level = 0dBu.
- 6 Mono Output**
Standard RCA phono socket for the Mono PGM bus output. The mono program bus is Nominal level = 0dBu, unbalanced. The PGM mono output is a mono version of the main PGM stereo out but is independent of the main fader.
- 7 Headphone Output Sockets**
Standard 1/4" (6.25mm) Jack sockets for the engineer/self operator and two guests.
Wired Tip=Left (+), Ring=Right (-), Sleeve=Ground.



Warning ! To avoid damage to your hearing do not operate the headphones or sound system at excessively high volume. Continued exposure to high volume sound can cause frequency selective or wide range hearing loss.

MASTER SECTION

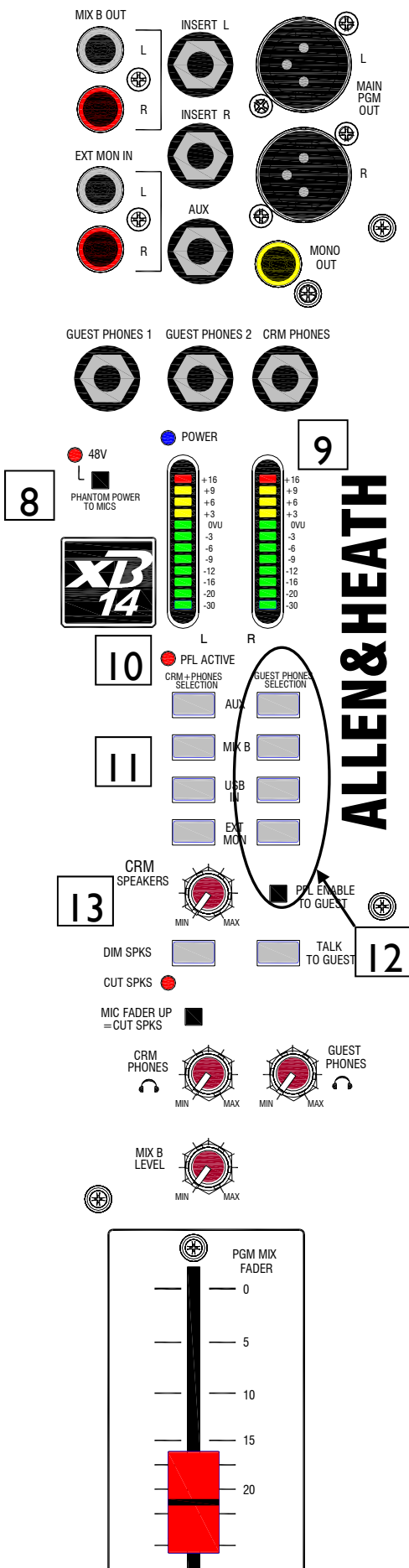

8 48v Phantom Power switch
 Press this in to switch 48v Phantom Power to the 4 Mic input xlr connectors, if any of the microphones attached require power. Dynamic microphones won't mind being connected to a phantom powered input, but care is needed to ensure that 48v is not switched on if an xlr is used to input a signal from an electronic circuit (ie. Another mixer or keyboard).
When switching 48v on or off, or plugging in connectors to channels with 48v present, it is important (and normal procedure) to mute the channels. This will avoid loud clicks and bangs potentially getting through to the amps & speakers with the possible effect of damaging the speakers, or the audience's hearing!

9 Main Left & Right meters
 12 segment LED meters, peak type response, the "0" position reflects nominal level at the outputs (+4dBu from the main PGM outputs). The meters display the signals from the CRM + Phones selector switches below, or the PFL (pre-fade listen) signal from any selected channels, which overrides.

10 PFL Active LED
 Illuminates red when any one or more PFL (pre-fade listen) switch is pressed. Indicates that the meters are displaying the PFL signal rather than the signal from the selected source.

11 CRM + PHONES Source Selector switches
 These 4 switches select the signal source for the control room speakers, headphones monitor and the meters. They work on a priority basis. If they are all up then the post-fade main PGM signals will feed the monitor circuit, if any of the switches are pressed then the PGM signal will be replaced. If more than one switch is pressed the switch nearest the meters will take priority.
 The PFL signal will override the selection to the meters and CRM if activated.

12 GUEST PHONES Source Selector switches
 Similar to the CRM + PHONES selection switches, these select the source for the guest headphones output. The choices are the same as for the CRM outputs, but a different source can be selected for the guests to that selected for the operator.
 The PFL signal will not be fed to the guest phones outputs unless the PFL ENABLE TO GUEST switch is pressed. This is an under-panel switch so it cannot be operated accidentally.

13 CRM Speakers level
 Adjusts the level of the signal to the control room speaker outputs from off (fully attenuated) to unity gain.

MASTER SECTION

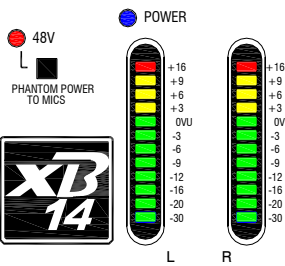
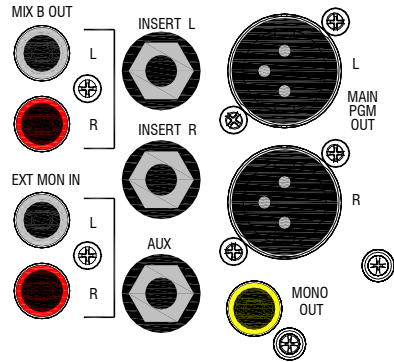

ALLEN & HEATH

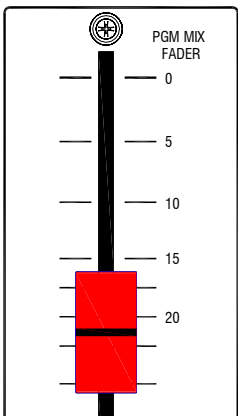
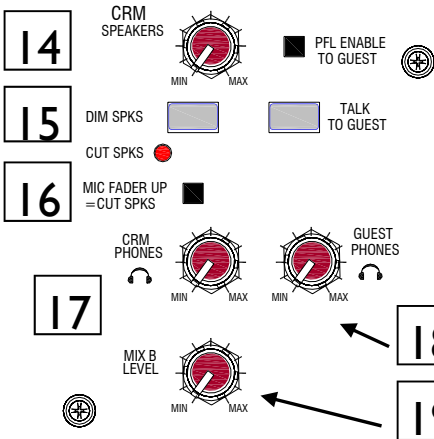
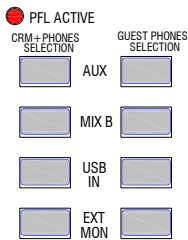

14 CRM Speakers level
 Adjusts the level of the signal to the control room speaker outputs from off (fully attenuated) to unity gain.

15 DIM & Cut CRM Speakers
 The Dim switch reduces the level of the control room speakers by 20dB.
 The Cut CRM Speakers LED illuminates red when the control room speakers mute circuit is activated, either by external switching using the remote interface or by raising any one of the mono channel faders (if the MIC FADER UP switch has been pressed).

16 MIC FADER UP = CUT Speakers
 An under-panel switch to enable the fader start logic switching to cut the control room speaker outputs. This is useful when the CRM speakers are in close proximity to the microphones plugged into the mono channels and acoustic feedback may occur from the speakers to the microphones.
 Press the switch to enable the automatic muting.

17 Control Room Phones level
 Adjusts the level of the operators' control room headphones from off (fully attenuated) to maximum. The headphone amplifier has a gain of 12dB.

18 Guest Phones level
 Adjusts the level of the guests' headphones from off (fully attenuated) to maximum.
 Each headphone output socket has a dedicated amplifier with a gain of 12dB.

19 MIX B level
 This is the master level control for the MIX B stereo bus output. The range of adjustment is from off (fully attenuated) to unity gain.

20 Program Mix Fader
 The main program mix level control. Affects the stereo PGM output, but not the mono PGM output.
 0dB, or unity gain is at the top of the fader.

REMOTE INTERFACE CONNECTORS

15 Way D socket connector REMOTE A	
PIN	FUNCTION
1	M1 FADER UP LOGIC (OPEN COLLECTOR OUTPUT)
2	M3 FADER UP LOGIC (OPEN COLLECTOR OUTPUT)
3	T1 FADER UP LOGIC (OPEN COLLECTOR OUTPUT)
4	M1 EXTERNAL MUTE (INPUT, ACTIVE LOW)
5	M3 EXTERNAL MUTE (INPUT, ACTIVE LOW)
6	T1 EXTERNAL MUTE (INPUT, ACTIVE LOW)
7	CUT CRM SPEAKERS (INPUT, ACTIVE LOW)
8	GROUND
9	M2 FADER UP LOGIC (OPEN COLLECTOR OUTPUT)
10	M4 FADER UP LOGIC (OPEN COLLECTOR OUTPUT)
11	T2 FADER UP LOGIC (OPEN COLLECTOR OUTPUT)
12	M2 EXTERNAL MUTE (INPUT, ACTIVE LOW)
13	M4 EXTERNAL MUTE (INPUT, ACTIVE LOW)
14	T2 EXTERNAL MUTE (INPUT, ACTIVE LOW)
15	N/C

15 Way D plug connector REMOTE B	
PIN	FUNCTION
1	ST1 START PULSE (OPEN COLLECTOR OUTPUT)
2	ST2 START PULSE (OPEN COLLECTOR OUTPUT)
3	ST3 START PULSE (OPEN COLLECTOR OUTPUT)
4	ST4 START PULSE (OPEN COLLECTOR OUTPUT)
5	ST5 START PULSE (OPEN COLLECTOR OUTPUT)
6	ST6 START PULSE (OPEN COLLECTOR OUTPUT)
7	ST7 START PULSE (OPEN COLLECTOR OUTPUT)
8	GROUND
9	ST1 STOP/CUE PULSE (OPEN COLLECTOR OUTPUT)
10	ST2 STOP/CUE PULSE (OPEN COLLECTOR OUTPUT)
11	ST3 STOP/CUE PULSE (OPEN COLLECTOR OUTPUT)
12	ST4 STOP/CUE PULSE (OPEN COLLECTOR OUTPUT)
13	ST5 STOP/CUE PULSE (OPEN COLLECTOR OUTPUT)
14	ST6 STOP/CUE PULSE (OPEN COLLECTOR OUTPUT)
15	ST7 STOP/CUE PULSE (OPEN COLLECTOR OUTPUT)

Start/Cue logic

The Start/Cue logic from the Stereo channel ON switches is designed to interface to a common standard employed by Denon and Pioneer equipment. The logic signals are usually wired to a 2 pole 3.5mm jack plug where a low pulse on the tip starts the deck and a low pulse on the sleeve stops or cues the deck. There needs to be some form of ground connection between the equipment for this to work—normally effected by the audio connector leads. Notice that there are Start/Cue outputs for 7 machines even though there are only 4 Stereo channel ON switches. That's because there are dual inputs on 3 of the stereo channels making a total of 7 sources and the XB-14 only sends a Start/Cue signal to the deck selected as a source to the channel whose switch is pressed. It's clever like that!

REMOTE INTERFACE CONNECTORS

9 Way D socket connector EXTERNAL METER	
PIN	FUNCTION
1	+15V POWER
2	-15V POWER
3	GROUND
4	LEFT METER
5	RIGHT METER
6	GROUND
7	GROUND
8	GROUND
9	+10V POWER

External Meter socket

This can be used to feed the main Program PGM L & R signals to external metering equipment. These are line level analogue signals, the level at 0VU will be 0dBu.

+/- 15V power is also available to power meter circuits, current draw should be kept under 100mA or so.

ON SWITCH OPTIONS

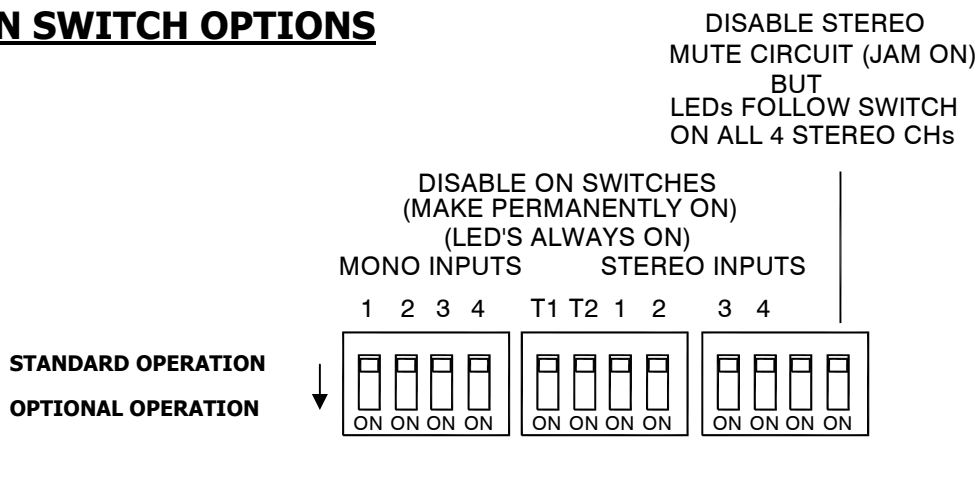

Configuration Switches

The tiny slide switches accessible on the rear panel are for configuring the XB-14's channel ON switches. In the up position, the channel ON switch will act as a normal ON/OFF switch affecting the channel signal accordingly. If the slide switch is moved down to the "ON" position, then the corresponding channel's ON switch will be disabled (made so that it is jammed ON). The green LEDs in the switch will then permanently illuminate. UNLESS...

Unless you are using the Stereo channel ON switches for transport Start/Cue and would like the channel mute circuit disabled but the switch illumination still to follow the switch position. In this case use the last switch in the row to disable the mute circuit on all 4 stereo channels, but make the illumination follow the switch position.

If you want, you can disable the Stereo channel mute circuit on an individual channel basis using the Stereo Inputs 1,2,3 & 4 slide switches individually. This will make the channel permanently on and the switch illumination also permanently on.

This may seem like a fussy complication, but could be useful if you want to revert to basic operation, where only the faders control the signal going out on air, disabling the ON switches so the operator cannot turn off the channel accidentally, but still want the switch illumination on certain stereo channels to follow the Start/Cue on the CD player or deck.

ALSO SEE P21 FOR A DIAGRAM TO EXPLAIN THESE SETTINGS.

REMOTE INTERFACE CONNECTORS

REMOTE A Connector wiring

The REMOTE A connector is used for the “Fader Up” logic signals from the Mono and Telco channel faders. It is also used for remote muting of channels and control room speakers. An example of how these remote signals can be used is below:

REMOTE A Connector Example: Remote mute wiring and Fader Up interface

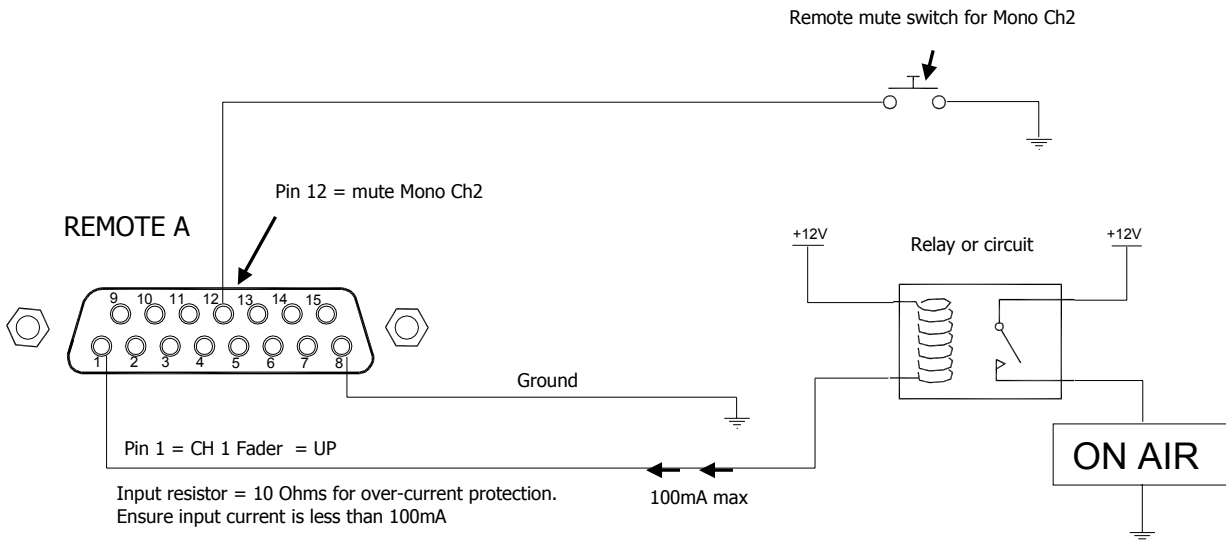

REMOTE B Connector Example: CD Deck start/cue from stereo channel ON switch

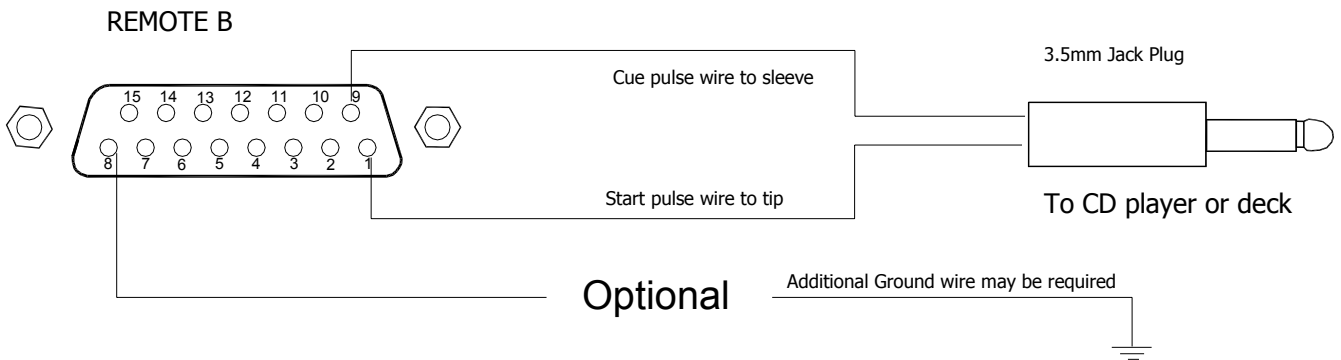

USB CONNECTION

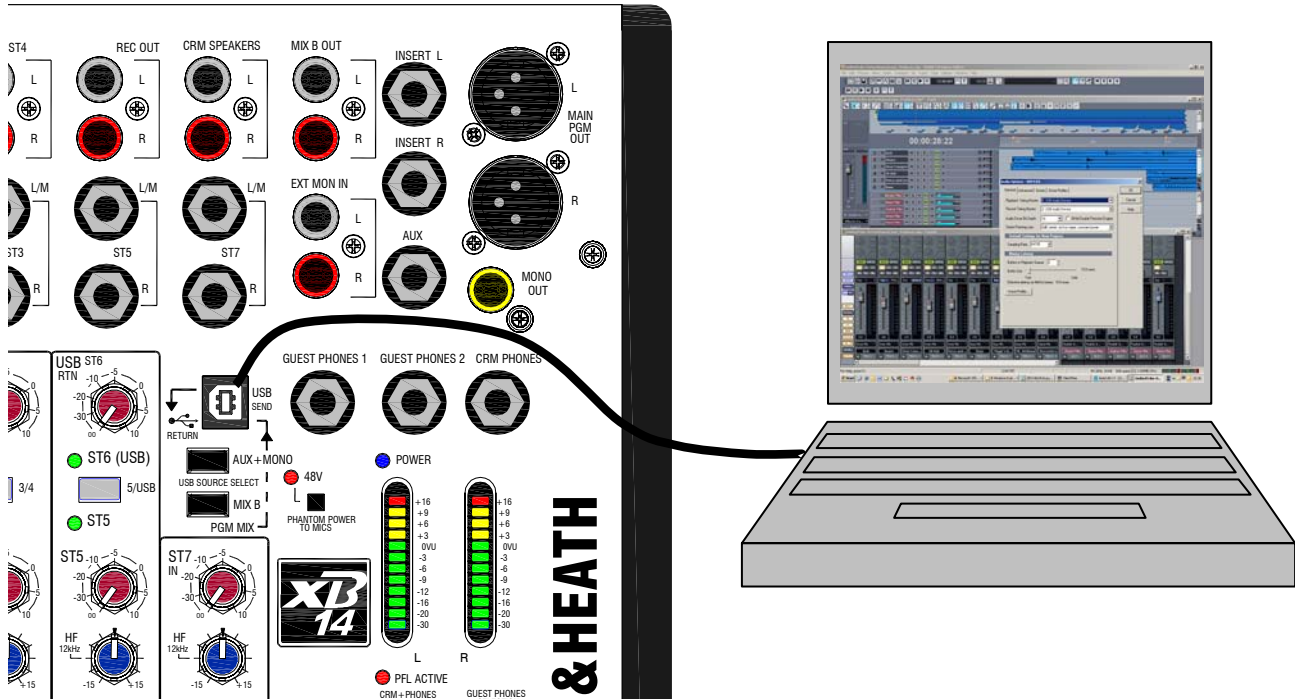

USB Audio Interface

The XB-14 is equipped with a stereo bi-directional USB I.1 compliant audio CODEC. It is fully compliant with USB 2 ports and uses standard Windows and MAC Core Audio Drivers. In other words, plug it in and your computer will find it and be able to transfer audio to and from the XB-14 USB device.

You will need some form of audio software running on your computer to be able to record and play back what you record, but on a basic level, you can use your computers media player to play straight to the XB-14 device.

Just a couple of points to look out for:

1. When you plug in your XB-14 USB interface to your Windows computer, check the device volume in:

Control Panel\Sounds & Audio Devices\Volume

If the volume is not fully up like this.....



Then drag it fully up like this.....



Then click **Apply**

2. By default Windows will use its WDM driver for the data stream from the USB audio device. There are other drivers available from third party companies like ASIO4ALL (www.asio4all.com) who supply ASIO drivers for WDM audio which is free to end users.

APPLICATION DIAGRAM: SELF OPERATION

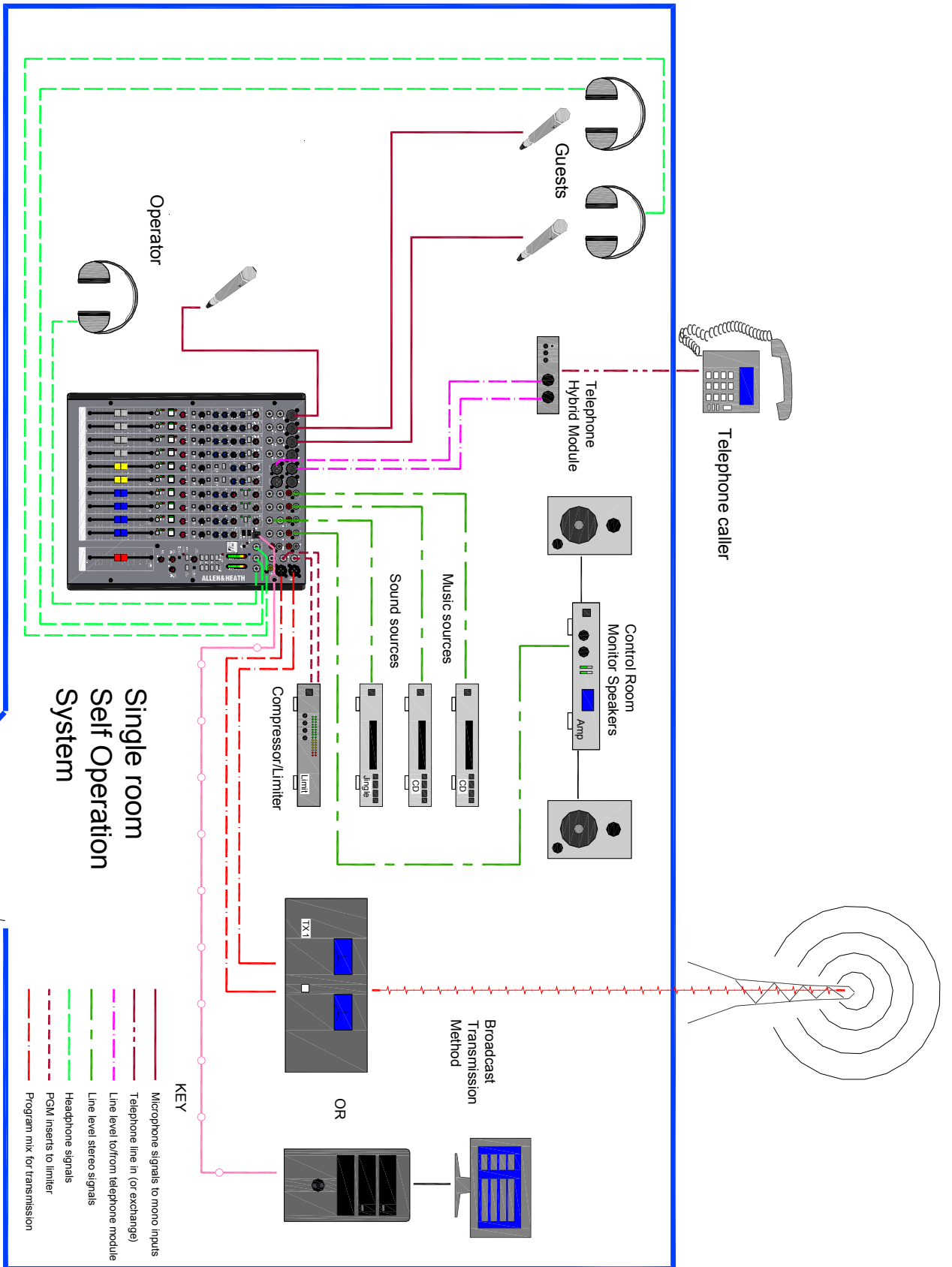

APPLICATION DIAGRAM: STUDIO+CONTROL ROOM

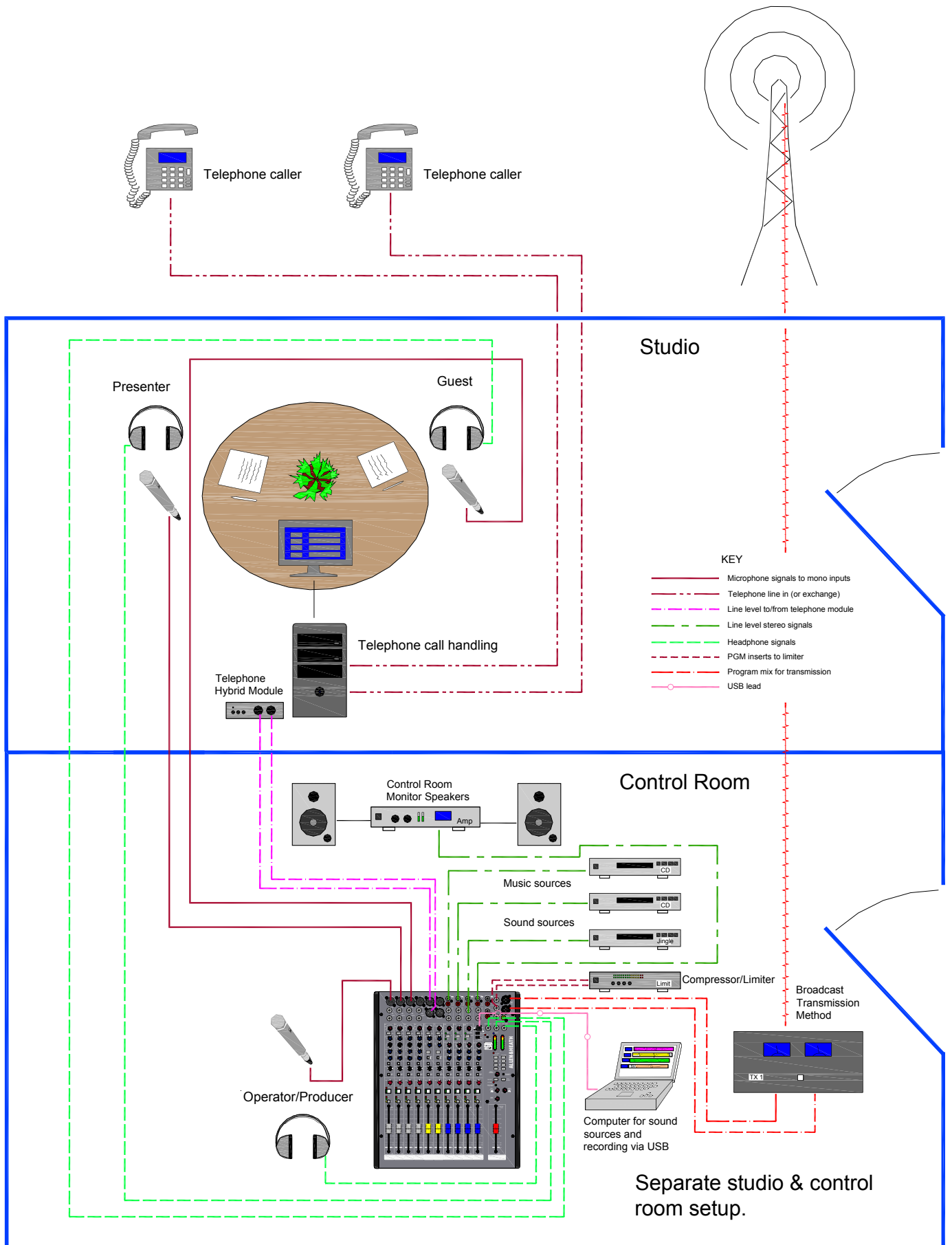

APPLICATION TIPS: OFF-AIR CALL RECORDING

This diagram shows the basic mixer setup using the Aux bus to record an interview with a telephone caller off-air, whilst playing music through stereo channel ST1. The interview could be recorded from the Aux out or via the USB port as shown here.

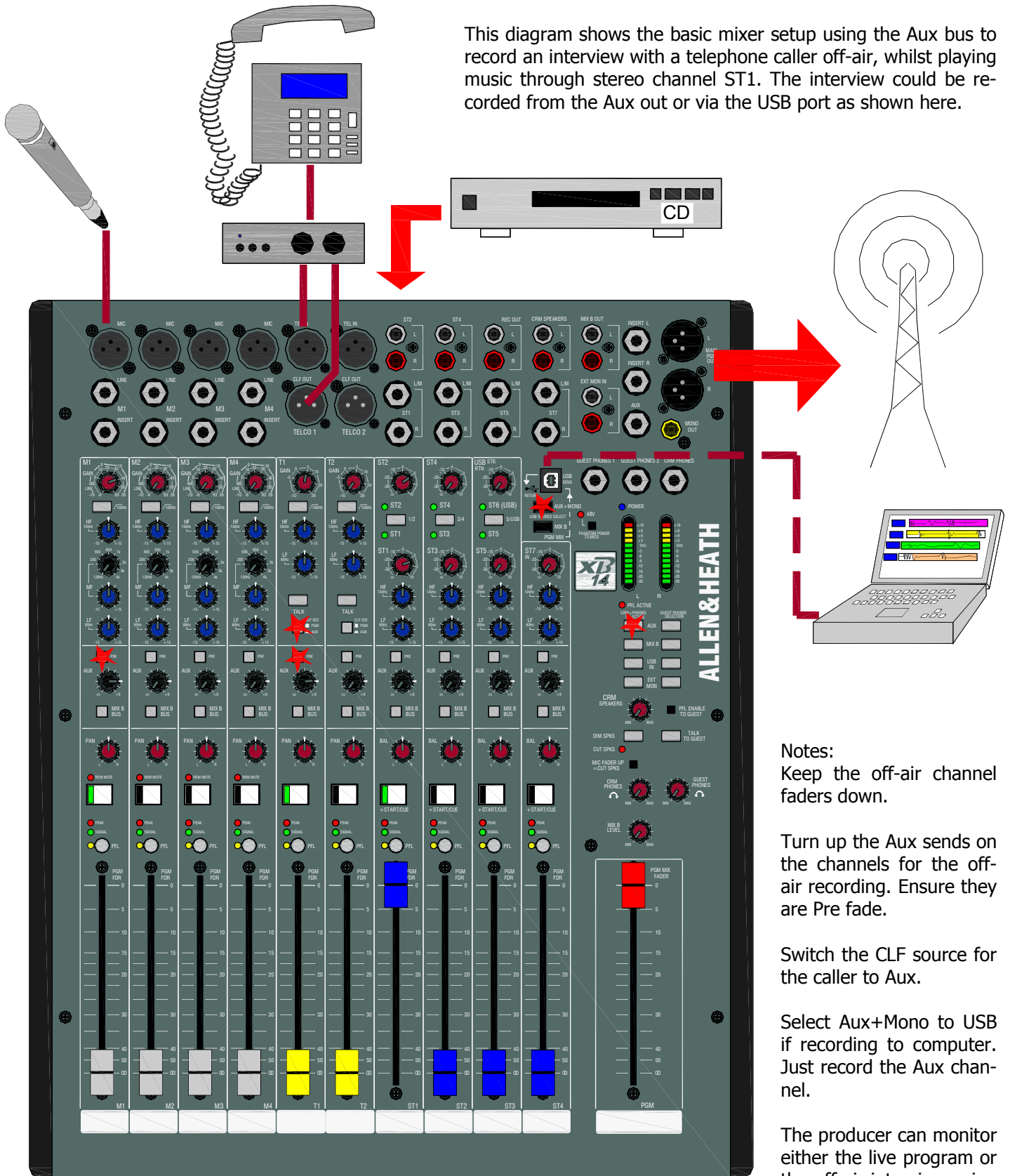

Notes:
Keep the off-air channel faders down.

Turn up the Aux sends on the channels for the off-air recording. Ensure they are Pre fade.

Switch the CLF source for the caller to Aux.

Select Aux+Mono to USB if recording to computer. Just record the Aux channel.

The producer can monitor either the live program or the off-air interview using the CRM selection switches.

APPLICATION TIPS: PLAYBACK OF RECORDED CALL

Following the previous page...

This diagram shows the recorded interview with the telephone caller being played out on-air from the computer via USB.

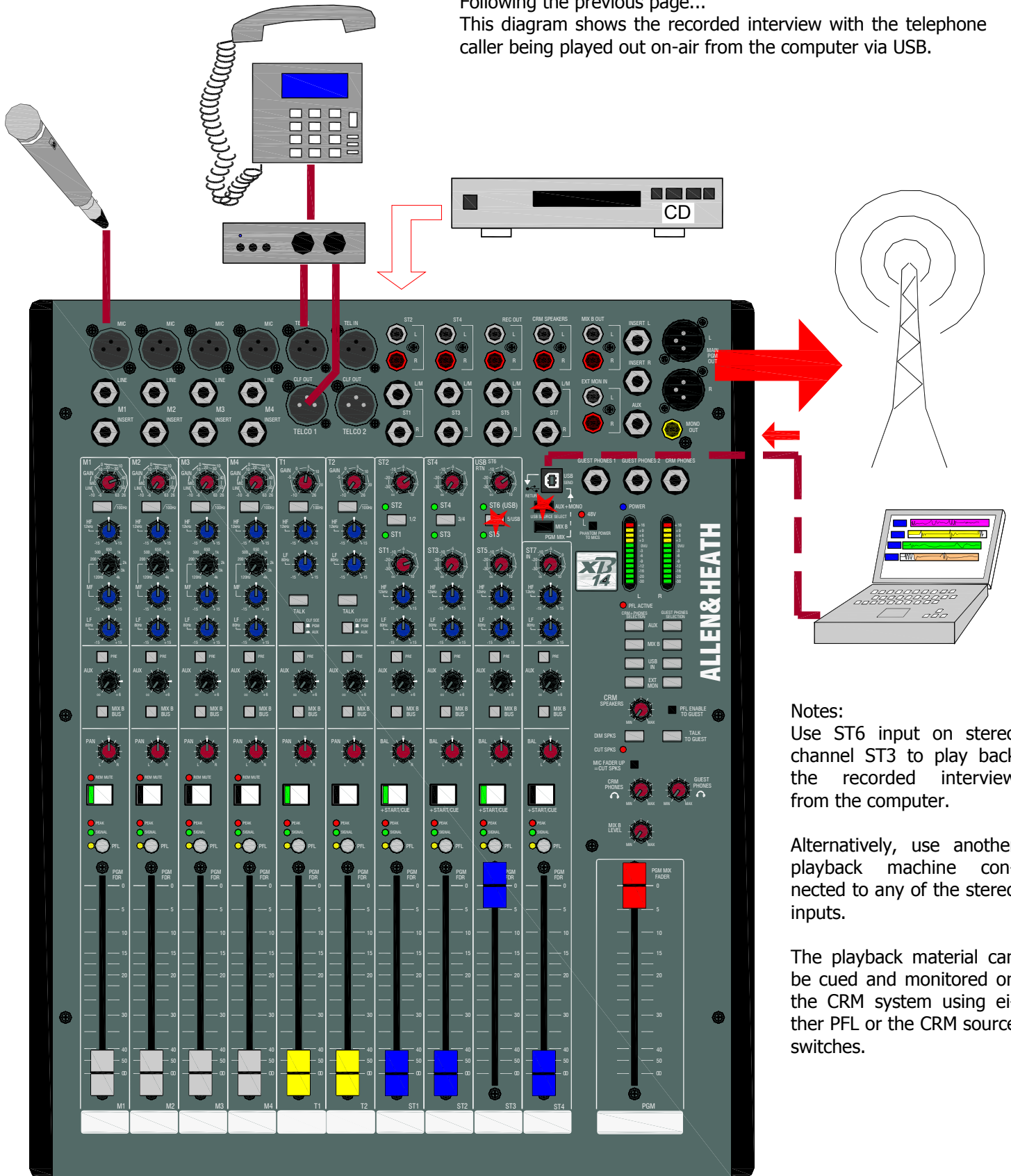

Notes:
Use ST6 input on stereo channel ST3 to play back the recorded interview from the computer.

Alternatively, use another playback machine connected to any of the stereo inputs.

The playback material can be cued and monitored on the CRM system using either PFL or the CRM source switches.

FIXING TO A RACK OR FURNITURE

The XB-14 can be fitted to a 19" rack or incorporated into studio furniture using the optional 19" rack fixing kit.

The following pictures give you an idea of how the rack fixing kit is fitted to the XB-14. Should you decide to purchase the kit, please follow the fitting instructions provided with the kit.

The rack mounting kit part number is: ZED1402-RK19

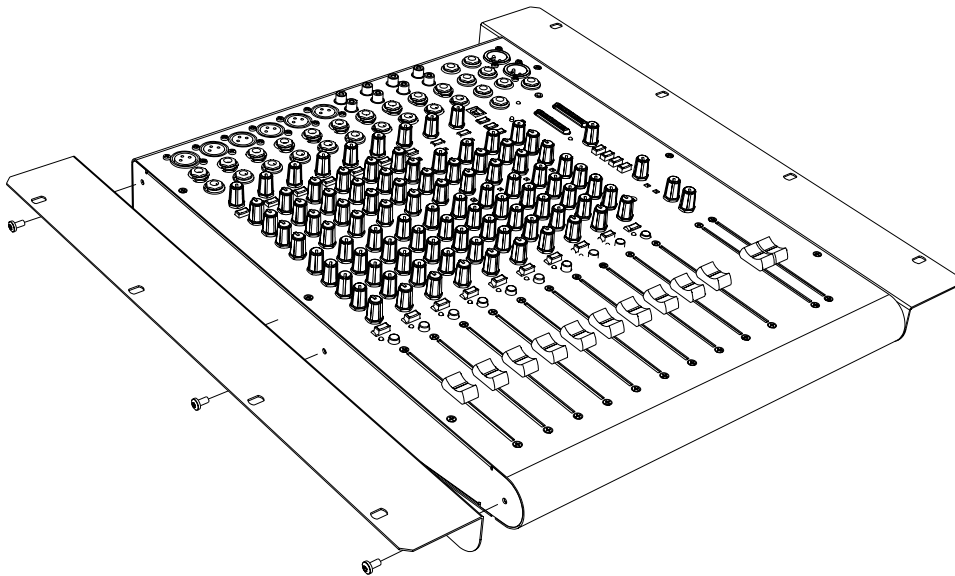
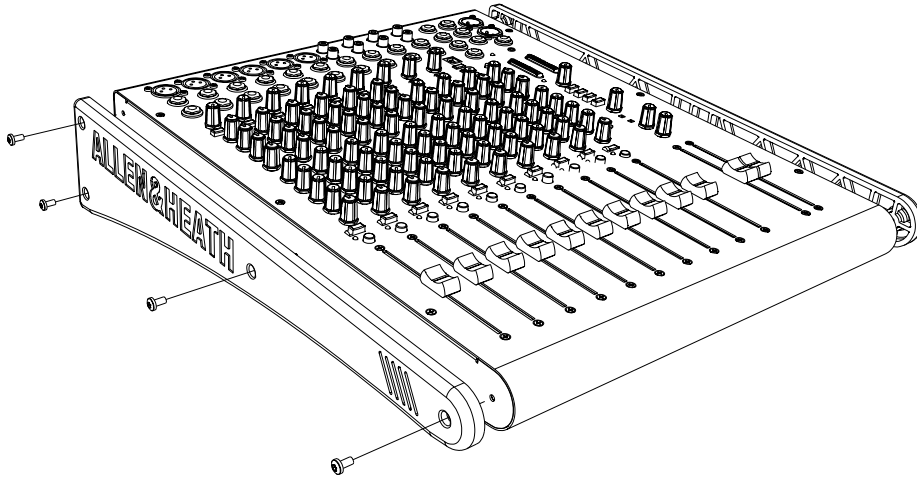

WIRING NOTES

Insert cable wiring

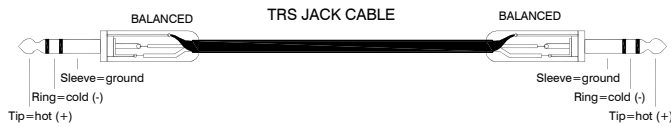
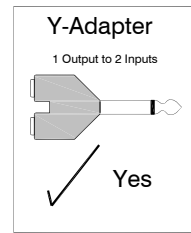
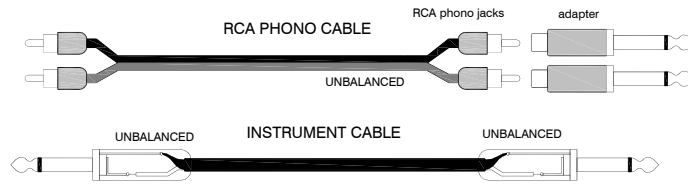
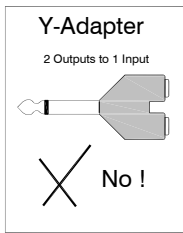
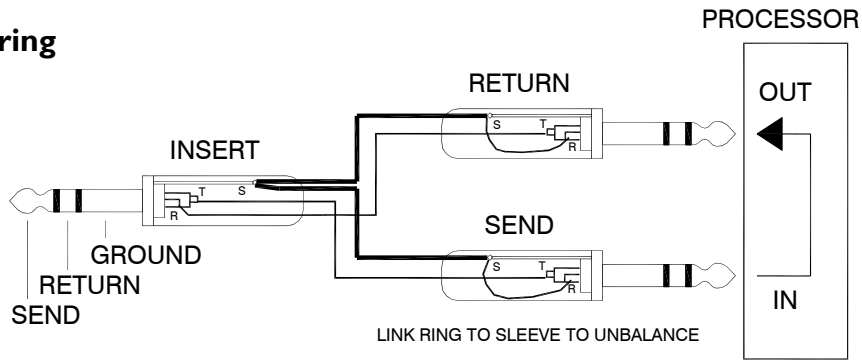

TO INPUT

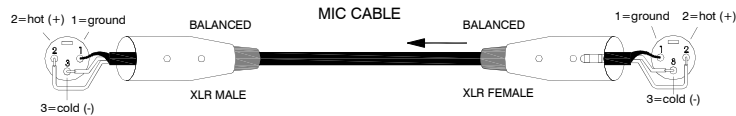

FROM OUTPUT

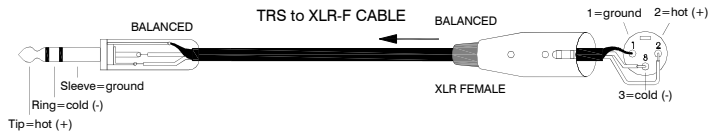

General Wiring Information

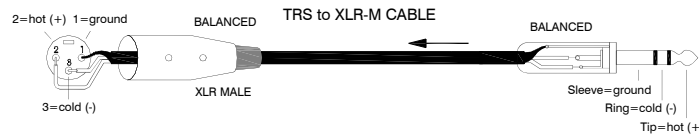

PRODUCT SUPPORT

Investigate **ALLEN & HEATH's** other ranges at www.allen-heath.com

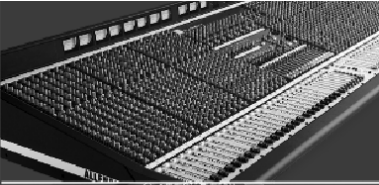

Large Live Sound mixers — iLive digital, ML and GL Series

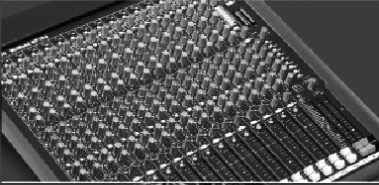

Small Format Live Sound mixers — ZED, MixWizards , PA Series, XB



DJ products — Xone Series



Sound Management Series — iDR Series

Registering your product

Thank you for buying the Allen & Heath XB-14 mixer. We hope that you are happy with it and that you or your end users enjoy many years of faithful service with it.

Please go to www.allen-heath.com/register.asp and register your product's serial number and your details. By registering with us and becoming an official Registered User, you will ensure that any warranty claim you might make is actioned quickly and with the minimum delay.

Alternatively, you may either copy or cut off this section of the page, fill in the details, and return it by mail to:

Allen & Heath Ltd, Kernick Industrial Estate, Penryn, Cornwall TR10 9LU, UK



ALLEN&HEATH PRODUCT REGISTRATION

Thankyou for buying an Allen & Heath product. We hope that you're happy with it and that you enjoy many years of faithful service with it.

SERIAL
NUMBER

Please return this section of the card by mail and retain the other part for your records. You can also register online at www.allen-heath.com. Thanks for your help.

Your Name:

Company Name:

Address 1:

Address 2:

Town/City:

County/State:

Country:

Postcode/Zip:

Telephone:

Email:

Why did you choose this console?

Which other products did you consider before choosing A&H?

Is there any thing you would like to improve on this mixer?

What audio magazines do you read?

If you were going to design a mixer for your work, what are the 6 most important features it should have (in order of importance)

1

2

3

4

5

6

We may use the information you provide to inform you of future product developments. We will not give or sell this data to third parties. Please indicate with an 'X' if you do not wish to receive any further communications from us.

NOTES

NOTES

