

Canon

PUB. DIE-0383-000

HD Camcorder

Instruction Manual

VIXIA
HFR20

VIXIA
HFR21

VIXIA
HFR200



NTSC



HDMI **AVCHD**

Important Usage Instructions

WARNING!

TO REDUCE THE RISK OF FIRE OR ELECTRIC SHOCK, DO NOT EXPOSE THIS PRODUCT TO RAIN OR MOISTURE.

WARNING!

TO REDUCE THE RISK OF ELECTRIC SHOCK AND TO REDUCE ANNOYING INTERFERENCE, USE THE RECOMMENDED ACCESSORIES ONLY.

COPYRIGHT WARNING:

Unauthorized recording of copyrighted materials may infringe on the rights of copyright owners and be contrary to copyright laws.

HD Camcorder, VIXIA HF R21 A / VIXIA HF R20 A / VIXIA HF R200 A systems

This device complies with Part 15 of the FCC Rules. Operation is subject to the following two conditions: (1) This device may not cause harmful interference, and (2) this device must accept any interference received, including interference that may cause undesired operation.

Note: This equipment has been tested and found to comply with the limits for class B digital device, pursuant to Part 15 of the FCC Rules. These limits are designed to provide reasonable protection against harmful interference in a residential installation. This equipment generates, uses and can radiate radio frequency energy and, if not installed and use in accordance with the instructions, may cause harmful interference to radio communications. However, there is no guarantee that interference will not occur in a particular installation. If this equipment does cause harmful interference to radio or television reception, which can be determined by turning the equipment off and on, the user is encouraged to try to correct the interference by one or more of the following measures:

- Reorient or relocate the receiving antenna.
- Increase the separation between the equipment and receiver.
- Connect the equipment into an outlet on a circuit different from that to which the receiver is connected.
- Consult the dealer or an experienced radio/TV technician for help.

Use of shielded cable is required to comply with class B limits in Subpart B of Part 15 of FCC Rules. Do not make any changes or modifications to the equipment unless otherwise specified in the manual. If such changes or modifications should be made, you could be required to stop operation of the equipment.

Canon U.S.A., Inc.
One Canon Plaza, Lake Success, NY 11042, U.S.A.
Tel No. (516)328-5600

WARNING:

To reduce the risk of electric shock, do not expose this product to dripping or splashing.

The Mains plug is used as the disconnect device. The Mains plug shall remain readily operable to disconnect the plug in case of an accident.

CAUTION:

- Danger of explosion if the wrong type of batteries are attached. Use only the same type of batteries.
- Do not expose batteries or product to excessive heat such as the inside of a car under direct sunlight, fire, etc.

Important Warning



CAUTION:

TO REDUCE THE RISK OF ELECTRIC SHOCK, DO NOT REMOVE COVER (OR BACK). NO USER-SERVICEABLE PARTS INSIDE. REFER SERVICING TO QUALIFIED SERVICE PERSONNEL.



The lightning flash with arrowhead symbol, within an equilateral triangle, is intended to alert the user to the presence of uninsulated "dangerous voltage" within the product's enclosure, that may be of sufficient magnitude to constitute a risk of electric shock to persons.



The exclamation point, within an equilateral triangle, is intended to alert the user to the presence of important operating and maintenance (servicing) instructions in the literature accompanying the product.

IMPORTANT SAFETY INSTRUCTIONS

In these safety instructions the word “product” refers to the Canon HD Camcorder VIXIA HF R21 A / VIXIA HF R20 A / VIXIA HF R200 A and all its accessories.

- 1 Read these instructions.
- 2 Keep these instructions.
- 3 Heed all warnings.
- 4 Follow all instructions.
- 5 Do not use this apparatus near water.
- 6 Clean only with dry cloth.
- 7 Do not install near any heat sources such as radiators, heat registers, stoves, or other apparatus (including amplifiers) that produce heat.
- 8 Protect the power cord from being walked on or pinched particularly at plugs, convenience receptacles, and the point where they exit from the apparatus.
- 9 Only use attachments/accessories specified by the manufacturer.
- 10 Unplug this apparatus during lightning storms or when unused for long periods of time.
- 11 Refer all servicing to qualified service personnel. Servicing is required when the apparatus has been damaged in any way, such as power-supply cord or plug is damaged, liquid has been spilled or objects have fallen into the apparatus, the apparatus has been exposed to rain or moisture, does not operate normally, or has been dropped.

CA-110 identification plate is located on the bottom.

While using the compact power adapter, do not wrap it or cover it with a piece of cloth, and do not place it in confined narrow spaces.

This Class B digital apparatus complies with Canadian ICES-003.

Trademark Acknowledgements

- SD, SDHC and SDXC Logos are trademarks of SD-3C, LLC.
- Microsoft and Windows are trademarks or registered trademarks of Microsoft Corporation in the United States and/or other countries.
- Macintosh and Mac OS are trademarks of Apple Inc., registered in the U.S. and other countries.
- “x.v.Color” and the “x.v.Color” logo are trademarks.
- HDMI, the HDMI logo and High-Definition Multimedia Interface are trademarks or registered trademarks of HDMI Licensing LLC in the United States and other countries.
- “AVCHD” and the “AVCHD” logo are trademarks of Panasonic Corporation and Sony Corporation.
- Manufactured under license from Dolby Laboratories.
“Dolby” and the double-D symbol are trademarks of Dolby Laboratories.
- YouTube is a trademark of Google Inc.
- Other names and products not mentioned above may be trademarks or registered trademarks of their respective companies.
- This device incorporates exFAT technology licensed from Microsoft.
- ANY USE OF THIS PRODUCT OTHER THAN CONSUMER PERSONAL USE IN ANY MANNER THAT COMPLIES WITH THE MPEG-2 STANDARD FOR ENCODING VIDEO INFORMATION FOR PACKAGED MEDIA IS EXPRESSLY PROHIBITED WITHOUT A LICENSE UNDER APPLICABLE PATENTS IN THE MPEG-2 PATENT PORTFOLIO, WHICH LICENSE IS AVAILABLE FROM MPEG LA, L.L.C., 250 STEELE STREET, SUITE 300, DENVER, COLORADO 80206.
- This product is licensed under AT&T patents for the MPEG-4 standard and may be used for encoding MPEG-4 compliant video and/or decoding MPEG-4 compliant video that was encoded only (1) for a personal and non-commercial purpose or (2) by a video provider licensed under the AT&T patents to provide MPEG-4 compliant video. No license is granted or implied for any other use for MPEG-4 standard.



Exciting Features and New Functions



High-Definition Video



Your camcorder's full high-definition image sensor (Full HD CMOS) captures video at a resolution of 1,920 x 1,080 pixels². Videos are then recorded in the memory in high definition, using AVCHD specifications³.

With your new HD camcorder, capturing the special moments in your life with amazing image quality and in lifelike vibrant colors is easy and fun!



HFR21/HFR20 Dual Flash Memory

You can record in the built-in memory or on commercially available memory cards (📖 36).

Decoration (📖 97)



You can add flare to your movies by adding text, stamps or even freehand illustrations.

¹ "Full HD 1080" refers to Canon camcorders compliant with high-definition video composed of 1,080 vertical pixels (scanning lines).

² Video is recorded at this resolution only when the recording mode is set to MXP or FXP mode. In other recording modes, the picture is recorded at 1,440 x 1,080 pixels.

³ AVCHD is a standard for recording high-definition video. With AVCHD specifications, the video signal is recorded using MPEG-4 AVC/H.264 compression and the audio signal is recorded in Dolby Digital.

Smart AUTO (43)

Smart AUTO automatically selects the best scene mode for the scene you want to shoot. You get spectacular recordings every time without worrying about settings.



Just point the camcorder and it will automatically select the best settings for your subject

Video Snapshot (68)

Shoot or capture short scenes and arrange them into a video clip set to your favorite background music.



Face Detection (66)

The camcorder automatically detects people's faces and adjusts the focus and other settings accordingly for beautiful results.

Image Stabilization



Dynamic IS (64) compensates for camcorder shake when you shoot video while walking.

Enjoying your Recordings on Other Devices

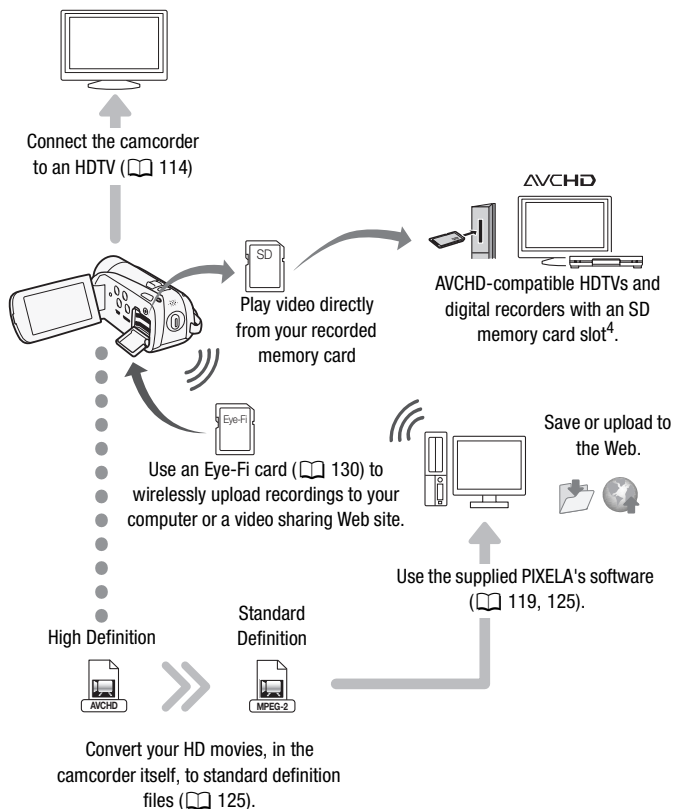

⁴ Refer to the instruction manual of the device compatible with the type of card memory used. Depending on the device used, correct playback may not be possible even if the device is AVCHD-compatible. In such case, play back the recordings on the memory card using the camcorder.

Table of contents

■ Introduction

- 6 Exciting Features and New Functions
- 14 About this Manual
- 16 Getting to Know the Camcorder**
- 16 Supplied Accessories and CD-ROMs
- 18 Names of Parts

■ Preparations

21 Getting Started

- 21 Charging the Battery Pack
- 24 Preparing the Accessories
- 27 Adjusting the Position and Brightness of the LCD Screen

29 Basic Operation of the Camcorder

- 29 Using the Touch Screen
- 30 Operating Modes
- 32 Using the Menus

34 First Time Settings

- 34 Setting the Date and Time
- 35 Changing the Language
- 35 Changing the Time Zone

36 Using a Memory Card

- 36 Memory Cards Compatible for Use with the Camcorder
- 38 Inserting and Removing a Memory Card
- 39 Selecting the Memory for the Recordings
- 40 Relay Recording of Movies
- 41 Initializing the Memory

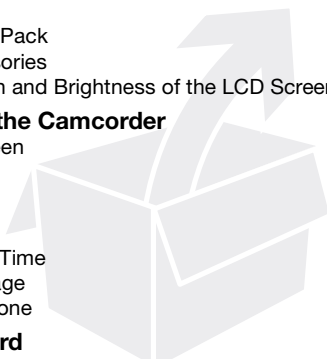

■ Smart AUTO Mode

43 Basic Recording

- 43 Shooting Video and Taking Photos in Smart AUTO Mode
- 47 Zooming
- 49 Quick Start Function

■ Video

50 Basic Playback

- 50 Playing Back the Video
- 54 3D Flip View
- 54 The Index Selection Screen: Selecting the Content to Play Back
- 56 Date Index Screen and Gallery Screen
- 56 Deleting Scenes

58 Advanced Functions

- 58 Shooting Video in Flexible Recording Mode
- 59 Selecting the Video Quality (Recording Mode)
- 60 Selecting the Frame Rate
- 61 Special Scene Recording Programs and Programmed AE
- 63 Cinema Mode: Giving a Cinematic Look to your Recordings
- 64 Image Stabilization
- 65 Pre-Recording
- 66 Face Detection
- 67 Touch & Track
- 68 Video Snapshot
- 69 Digital Effects
- 70 Manual Exposure Adjustment
- 71 Manual Focus Adjustment
- 72 Tele-macro
- 73 White Balance
- 74 Self Timer
- 75 Audio Recording Level
- 77 Using Headphones
- 80 Selecting the Playback Starting Point
- 82 Playing Back Scenes or Slideshow Set to Background Music

- 87 Onscreen Displays and Data Code
- 87 Rating Scenes
- 90 Gallery and Scene Operations**
- 90 Managing Stories
- 94 Capturing Video Snapshot Scenes and Photos from a Movie
- 96 Dividing Scenes
- 97 Decorating Scenes

■ Photos

103 Basic Playback

- 103 Viewing Photos
- 105 Deleting Photos

107 Additional Functions

- 107 Taking Photos in Flexible Recording Mode
- 108 Selecting Photo Size
- 109 Slideshow

■ External Connections

111 Terminals on the Camcorder

- 112 Connection Diagrams

114 Playback on a TV Screen

116 Saving and Sharing Your Recordings

- 116 Copying Recordings to a Memory Card
- 119 Saving Recordings on a Computer
- 122 Saving Movies onto Standard-Definition Discs (DVD)
- 123 Copying Recordings to an External Video Recorder
- 125 Uploading Movies to Video Sharing Web Sites

■ Additional Information

132 Appendix: Menu Options Lists

- 132 FUNC. Panel
- 136 Setup Menus

147 Appendix: Onscreen Icons and Displays

152 Trouble?

- 152 Troubleshooting
- 159 List of Messages

166 Do's and Don'ts

- 166 Handling Precautions
- 170 Maintenance/Others
- 171 Using the Camcorder Abroad

172 General Information







- 172 Accessories
- 173 Optional Accessories
- 176 Product Codes
- 177 Specifications
- 182 Index





About this Manual

Thank you for purchasing the Canon VIXIA HF R21 / VIXIA HF R20 / VIXIA HF R200. Please read this manual carefully before you use the camcorder and retain it for future reference. Should your camcorder fail to operate correctly, refer to *Troubleshooting* (📖 152).

Conventions Used in this Manual

-  **IMPORTANT:** Precautions related to the camcorder's operation.
-  **NOTES:** Additional topics that complement the basic operating procedures.
-  **POINTS TO CHECK:** Restrictions or requirements regarding the function described.
-  Reference page number within this manual.
- **HFR21/HFR20:** Text that applies only to the model(s) shown in the icon.
- When you see the  icon, you will need to refer also to the 'Photo Application' Instruction Manual, included as a PDF file in the supplied Camcorder Supplemental Disc, to complete the operation.
- The following terms are used in this manual:
 - When not specified as “memory card” or “built-in memory”, the term “memory” by itself refers to both.
 - “Screen” refers to the LCD screen.
 - “Scene” refers to one movie unit from the point you press the  button to start recording until you press again to pause the recording.
- The photos included in this manual are simulated pictures taken with a still camera. Unless indicated otherwise, illustrations and menu icons refer to the **HFR21**.

 indicates that a function is available in the operating mode indicated and  indicates that the function is not available. For a detailed explanation refer to *Operating Modes* (📖 30).

Brackets [] are used to refer to control buttons and menu options you will touch on the screen and to other onscreen messages and displays.

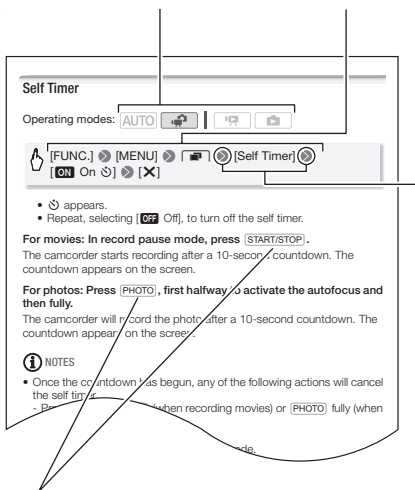

The names of physical buttons and switches on the camcorder are indicated within a “button” frame. For example .

The  arrow is used to abbreviate menu selections. For a detailed explanation on how to use the menus, refer to *Using the Menus* (📖 32). For a concise summary of all available menu options and settings, refer to the appendix *Menu Options Lists* (📖 132).

Supplied Accessories and CD-ROMs

The following accessories are supplied with the camcorder:

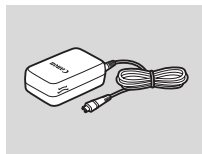

▶ CA-110 Compact Power Adapter*

BP-110 Battery Pack ◀

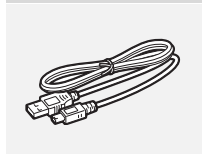
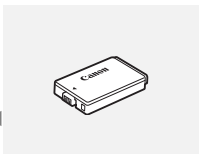

▶ IFC-300PCU/S USB Cable

STV-250N Stereo Video Cable
Yellow • Red • White plugs ◀

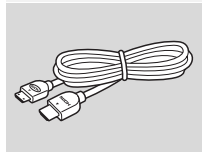
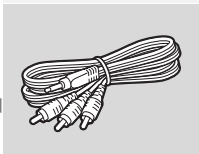

▶ HTC-100/S HDMI Cable

Quick Guide ◀

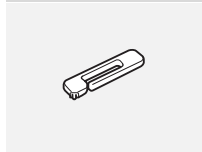
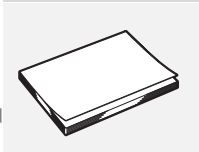

▶ Stylus Pen

* CA-110E including power cord, in Asia.

The following CD-ROMs and software are supplied with the camcorder:

- **PIXELA's Transfer Utility** CD-ROM¹ and Installation Guide for PIXELA's software
 - PIXELA's Transfer Utility - Software for saving and transferring movies and music files you can use as background music.
- **PIXELA's VideoBrowser** CD-ROM¹
 - PIXELA's VideoBrowser - Software for managing, editing, and playing back movies.
-  **Instruction Manual/Photo Applications Ver.35¹/Music Data/Image Mix Data** CD-ROM (referred to in this manual as "Camcorder Supplemental Disc")
 - Instruction Manual - The full-version instruction manual of the camcorder (this PDF file).
 - Photo Application - Software for saving, managing, and printing photos.
 - Music data - Music files that can be used as background music during playback. These music files are for exclusive use with the supplied PIXELA's software. The disc cannot be played back on CD players.
 - Image mix data - Image files that can be used to mix with live video for the image mix function.

¹ The CD-ROM includes the instruction manual of the software (on PDF file).

Names of Parts

Left side view

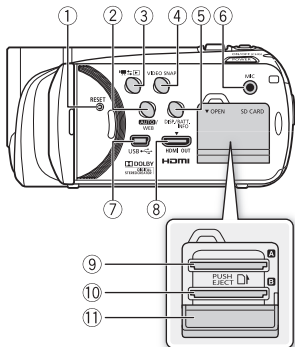

- ① RESET button (156)
- ② **AUTO** button (30)/**HFR21**/**HFR20** WEB button (125)
- ③ (camera/play) button (31)
- ④ VIDEO SNAP (video snapshot) button (68)
- ⑤ DISP. (onscreen display) button (87)/
BATT. INFO button (151)
- ⑥ MIC terminal (79)
- ⑦ USB terminal (111, 114)
- ⑧ HDMI OUT terminal (111, 112)
- ⑨ Memory card slot **A** (38)
- ⑩ Memory card slot **B** (38)
- ⑪ Double memory card slot cover
- ⑫ Terminal cover
- ⑬ DC IN terminal (21)
- ⑭ COMPONENT OUT terminal (111, 113)
- ⑮ AV OUT terminal (111, 113)/
 (headphones) terminal (77)
- ⑯ Strap mount (25)
- ⑰ Grip belt (24)

Right side view

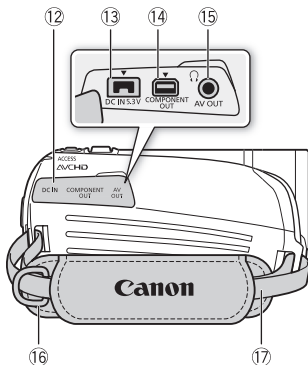

Front view

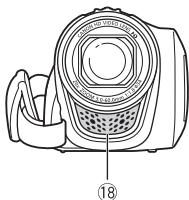

- ⑱ Stereo microphone (📖 75)
- ⑲ Zoom lever (📖 47)
- ⑳ PHOTO button (📖 43, 107)
- ㉑ ACCESS indicator (📖 43, 58, 107)
- ㉒ POWER button
- ㉓ ON/OFF (CHG) (charge) indicator:
Green – ON
Orange – Standby (📖 49)
Red – Charging (📖 21)
- ㉔ LCD touch screen (📖 27, 29)

Top view

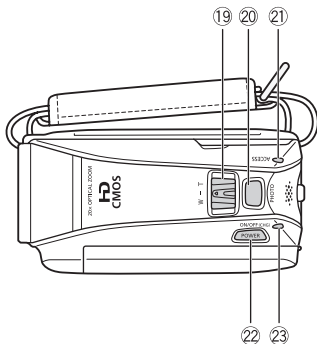

LCD panel

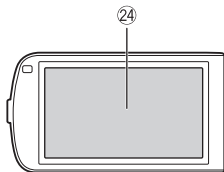

Back view

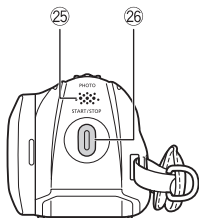

- 25 Speaker (52)
- 26 START/STOP button (43, 58)
- 27 Tripod socket (167)
- 28 **Serial number**
The serial number label is located on the battery compartment cover.

Bottom view

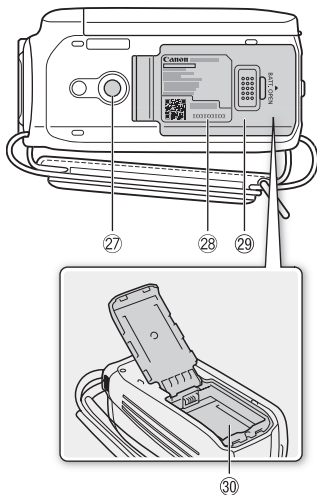

- 29 Battery compartment cover (21)
- 30 Battery compartment (21)



Preparations

This chapter describes basic operations, such as using the touch panel, navigating the menus, and first time settings to help you learn more about your camcorder.

Getting Started

Charging the Battery Pack

The camcorder can be powered with a battery pack or directly using the compact power adapter. The first time you use a battery pack or if you have not used the battery pack for an extended period of time, fully charge it and then use the camcorder until the battery pack is completely exhausted. Doing so will ensure that the remaining recording time will be displayed accurately.

For approximate charging times and recording/playback times with a fully charged battery pack, refer to the tables on page 173.

1 Plug the compact power adapter into a power outlet.

For Asia only: Connect the power cord to the compact power adapter.

2 Connect the compact power adapter to the camcorder's DC IN terminal.

When connecting the compact power adapter's cable to the camcorder, make sure to align the triangle marks on the cable's connector and on the camcorder's terminal (▶◀).

ON/OFF (CHG)
(charge) indicator

DC IN terminal

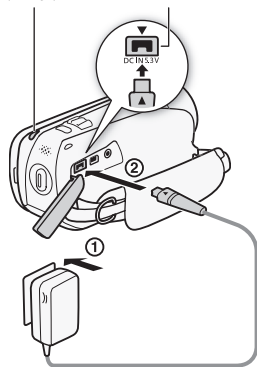

For Asia only:

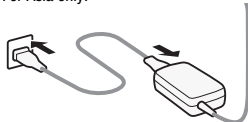

- 3 Slide the battery compartment cover away from the lens and open it.
- 4 Insert the battery pack all the way into the compartment and press gently until it clicks.
- 5 Close the cover and slide it toward the lens until you hear a click.
- 6 **Charging will start when the camcorder is turned off.**
 - If the camcorder was on, the green ON/OFF (CHG) indicator will go out when you turn off the camcorder. After a moment, the ON/OFF (CHG) indicator will start flashing in red (battery pack charging). The red ON/OFF (CHG) indicator will go out when the battery pack is fully charged.
 - If the indicator flashes quickly, refer to *Troubleshooting* (📖 152).

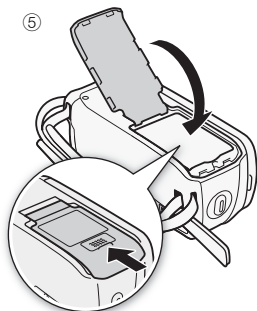
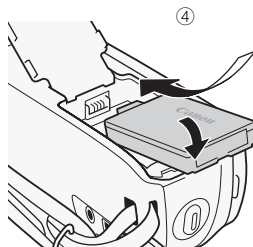
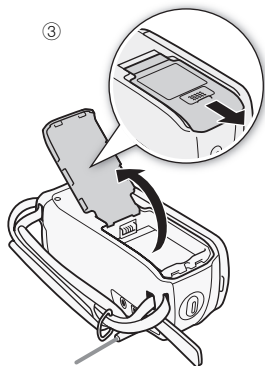

To remove the battery pack

- 1 Slide the battery compartment cover away from the lens and open it.
- 2 Raise the edge of the battery pack in the direction of the arrow and pull out the battery pack.
- 3 Close the cover and slide it toward the lens until you hear a click.

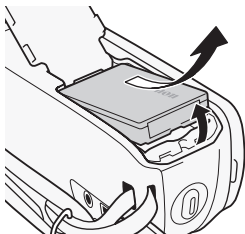

! IMPORTANT

- Turn off the camcorder before connecting or disconnecting the compact power adapter. After pressing **POWER** to turn off the camcorder, important data is updated in the memory. Be sure to wait until the green ON/OFF (CHG) indicator goes out.
- Do not connect to the camcorder's DC IN terminal or to the compact power adapter any electrical equipment that is not expressly recommended for use with this camcorder.
- To prevent equipment breakdowns and excessive heating, do not connect the supplied compact power adapter to voltage converters for overseas travels or special power sources such as those on aircraft and ships, DC-AC inverters, etc.

i NOTES

- The battery pack will be charged only when the camcorder is off.
- We recommend charging the battery pack in temperatures between 10 °C and 30 °C (50 °F and 86 °F). Outside the temperature range of approximately 0 °C to 40 °C (32 °F to 104 °F), charging will not start. Also, when the battery itself is outside the temperature range of approximately 0 °C to 40 °C (32 °F to 104 °F), charging will not start.
- During charging, if you disconnect the compact power adapter from the DC IN terminal or unplug it from the power outlet, make sure the ON/OFF (CHG) indicator has gone out before connecting or plugging the compact power adapter again.

- If remaining battery time is an issue, you can power the camcorder using the compact power adapter so the battery pack will not be consumed.
- Charged battery packs continue to discharge naturally. Therefore, charge them on the day of use, or the day before, to ensure a full charge.
- We recommend that you prepare battery packs to last 2 to 3 times longer than you think you might need.
- **USA and Canada only:** The Lithium ion/polymer battery that powers the product is recyclable. Please call 1-800-8-BATTERY for information on how to recycle this battery.



Preparing the Accessories

Grip Belt

Fasten the grip belt.

Adjust the grip belt so that you can reach the zoom lever with your index finger, and the **START/STOP** button with your thumb.

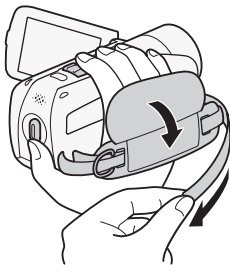

To remove the grip belt

- 1 Lift the padded handgrip's flap and detach the strap from the Velcro pad.
- 2 Pull the strap to remove it first from the front bracket on the camcorder, then to unthread it from the handgrip and finally to remove it from the rear bracket on the camcorder.

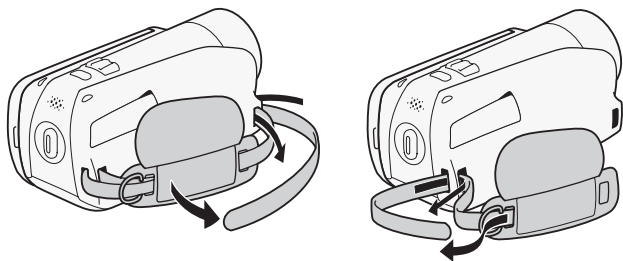

Stylus Pen

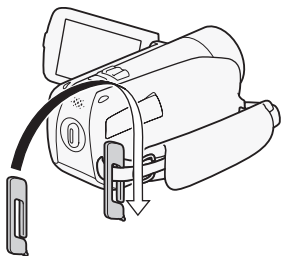

Straps

To attach an optional wrist strap

Pass the attaching end of the wrist strap through the rear bracket on the camcorder, thread the wrist strap through the loop and fasten.

You can also attach the wrist strap to the strap mount on the grip belt to use both for extra convenience and protection.

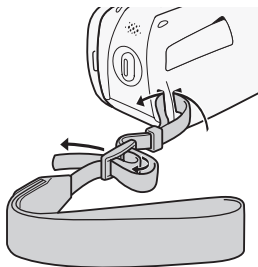

To attach an optional shoulder strap

Pass the ends of the shoulder strap through the strap mount on the grip belt and adjust the length of the strap.

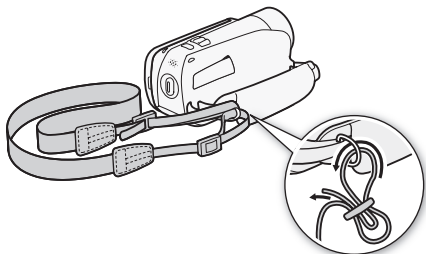

Adjusting the Position and Brightness of the LCD Screen

Rotating the LCD Panel

Open the LCD panel 90 degrees.

- You can rotate the panel 90 degrees downward.
- You can rotate the panel 180 degrees toward the lens. Rotating the LCD panel 180 degrees can be useful when you wish to include yourself in the picture when recording with the self timer.

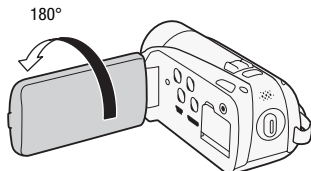
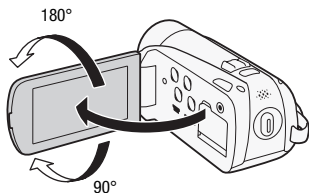

Subject can monitor the LCD screen

i NOTES



- **About the LCD screen:** The screen is produced using extremely high-precision manufacturing techniques, with more than 99.99% of the pixels operating to specification. Less than 0.01% of the pixels may occasionally misfire or appear as black, red, blue or green dots. This has no effect on the recorded image and does not constitute a malfunction.

LCD Backlight

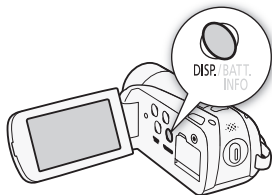



When recording in bright places it may be difficult to use the LCD screen. Turn on the LCD backlight to make it brighter.



With the camcorder on, hold  pressed down for more than 2 seconds.

- Repeat this action to switch the LCD backlight between off (normal) and on (bright).
- If   [LCD Screen Dimmer] is set to [**ON** On], pressing  for more than 2 seconds will turn off the screen dimmer and return the LCD screen to its previous brightness setting.

NOTES

- The LCD backlight does not affect the brightness of the recordings.
- Using the bright setting will shorten the effective usage time of the battery pack.
- You can further adjust the brightness of the LCD screen with the   [LCD Brightness] setting, or dim it with the   [LCD Screen Dimmer] setting to use in places where the light from the LCD screen can be a nuisance.

Basic Operation of the Camcorder

Using the Touch Screen

The control buttons and menu items that appear on the touch screen change dynamically depending on the operating mode and the task you are performing. You can easily operate the touch screen using your finger or the supplied stylus pen. With the intuitive touch screen interface you have all the controls at your fingertips.

Touch

Press firmly on an element displayed on the touch screen.

Used to start playing back a scene in an index screen, to select a setting from the menus, to select the subject whom the camcorder will recognize as the main subject of the scene, etc.

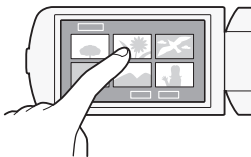

Drag

While applying pressure, swipe your finger up and down or left and right across the screen.

Used to scroll menus, to browse through index screen pages or to adjust slider controls like the volume.

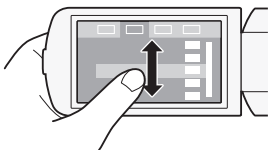

! IMPORTANT

- **The camcorder uses a pressure-sensitive touch screen. Press firmly when using touch operations.**
- If you press the touch screen hard, the area pressed may appear white or black. This is a characteristic of the touch screen and will not cause a malfunction. Also, this will not affect your recordings.



- In the following cases, you may not be able to perform touch operations correctly.
 - Operating the touch screen with wet or gloved hands or using your fingernails or other hard-tipped objects other than the stylus pen, such as ballpoint pens.
 - Applying excessive force or forcefully scratching the touch screen.
 - Attaching commercially available screen protectors or adhesive film onto the touch screen's surface.

Operating Modes

Recording

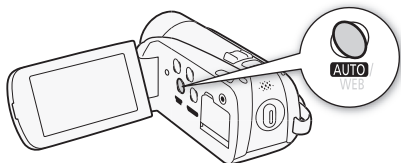

The camcorder offers two basic modes for recording video and photos: Smart AUTO (AUTO) mode for beginners or if you just prefer not to bother with detailed camcorder settings, and flexible recording () mode, which lets you change the camcorder's settings to your preference. Press the AUTO button to switch the camcorder to AUTO mode and press the button again to switch back to mode. In either mode, you can record movies by pressing START/STOP or take photos by pressing PHOTO.









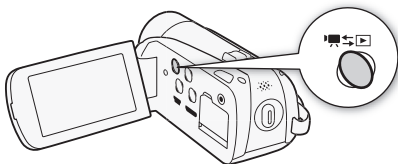

Operating mode	Onscreen icon	Operation
AUTO	 *	Easy recording of movies and photos (43).
		Recording of movies (58) and photos (107) while enjoying full access to the menus and advanced functions.

* The mode icon displayed will change according to the optimal mode selected by the Smart AUTO function.

Playback

Press the  (camera/play) button to switch the camcorder between camera (recording) mode and playback mode. You can press  when the camcorder is off to turn it on directly in playback mode.



Operating mode	Onscreen icon	Operation	
		Press 	Playing back movies (📖 50).
		Press  , touch  and then 	Viewing photos (📖 103).

NOTES

- When switching to a playback mode, the memory selected for playback will be the same currently used for recording.

Using the Menu

Many of the camcorder's functions can be adjusted from the FUNC. panel and the setup menus. In **AUTO** mode, however, most menu cannot be accessed and, except in a few cases, most menu settings will return to their default values.

For details about the available menu options and settings, refer to the appendix *Menu Options Lists* (📖 132).



The FUNC. Panel and Edit Panel

In **AUTO** and  mode, the FUNC. panel shows a convenient overview of frequently used shooting functions. Touch [FUNC.] to access the FUNC. panel and then touch the function you want to set or adjust. You may need to drag your finger up and down the screen to find the control button of the desired function.

FUNC. panel in  mode

Touch the control button of the desired function



In  and  mode, touch [Edit] to display a similar panel containing the various operations that are available and then touch the control button of the desired operation.

Edit panel in  mode

Touch the control button of the desired operation

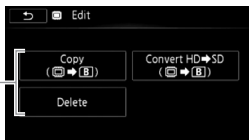

The Setup Menu

- 1  mode only: Touch [FUNC.]
- 2 Touch [MENU] to open the setup menus.
- 3 Touch the tab of the desired menu.
- 4 Drag your finger up and down to bring the setting you want to change into the orange selection bar.

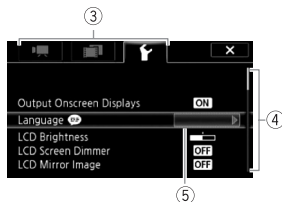

- Menu items not available appear grayed out.
 - When the desired menu item appears, you can touch it to bring it down to the orange bar.
- 5 When the desired menu item is inside the selection bar, touch the orange frame on the right.
 - 6 Touch the desired option and touch [X].
You can touch [X] to close the menu at any time.

First Time Settings

Setting the Date and Time

You will need to set the date and time of the camcorder before you can start using it. The [Date/Time] screen will appear automatically when the camcorder's clock is not set.

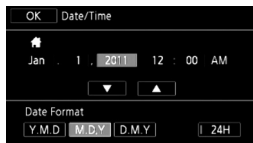

When the [Date/Time] screen appears, the year will be selected.



- 1 Touch a field you want to change (year, month, day, hours or minutes).
- 2 Touch [▲] or [▼] to change the field as necessary.
- 3 Set the correct date and time by changing all the fields in the same way.
- 4 Touch [Y.M.D], [M.D.Y] or [D.M.Y] to select the date format you prefer.
- 5 Touch [24H] to use 24-hour clock or leave this control unchecked to use 12-hour clock (AM/PM).
- 6 Touch [OK] to start the clock and close the setup screen.

NOTES

- When you do not use the camcorder for about 3 months, the built-in rechargeable lithium battery may discharge completely and the date and time setting may be lost. In such case, recharge the built-in lithium battery (📖 169) and set the time zone, date and time again.
- To change the date and time later on (not during the initial setup), open the [Date/Time] screen from the setup menus:

 [FUNC.]* ➤ [MENU] ➤  ➤ [Date/Time]

* Only when performing the procedure in  mode.

Changing the Language

The default language of the camcorder is English. You can set it to one of 27 languages.

Operating modes:   |  

 [FUNC.]*  [MENU]    [Language ] 
Desired language  [OK]  [X]

* Only when performing the procedure in a recording mode.

NOTES

- Some control buttons, such as [ZOOM], [FUNC.] or [MENU], will appear in English regardless of the language selected.

Changing the Time Zone







Change the time zone to match your location. The default setting is New York.

Operating modes:   |  

- 1 Open the [Time Zone/DST] screen.

 [FUNC.]*  [MENU]    [Time Zone/DST]

* Only when performing the procedure in  mode.



- 2 Touch [] to set the home time zone, or [] to set the time zone of your destination when you are traveling.
- 3 Touch [] or [] to set the desired time zone. If necessary, touch [] to adjust for daylight saving time.
- 4 Touch [] to close the menu.

Using a Memory Card

Memory Cards Compatible for Use with the Camcorder

You can use commercially available Secure Digital (SD) cards with this camcorder. However, depending on the memory card, you may not be able to record movies. Refer to the table below.

As of October 2010, the movie recording function has been tested using SD/SDHC/SDXC memory cards made by Panasonic, Toshiba and SanDisk.

Memory card	Capacity	SD Speed Class	Recording movies
 SD memory cards	64 MB or less	—	—
	128 MB or more	—	●*
CLASS② CLASS④ CLASS⑥ CLASS⑩		●	
 SDHC memory cards	Over 2 GB	CLASS② CLASS④ CLASS⑥ CLASS⑩	●
 SDXC memory cards	Over 32 GB	CLASS④ CLASS⑥ CLASS⑩	●

* Depending on the memory card used, it may not be possible to record movies.

NOTES

- **About the SD Speed Class:** The SD Speed Class is a standard that indicates the minimum guaranteed data transfer speed of SD/SDHC/SDXC memory cards. When you buy a new memory card, look for the Speed Class logo on the package.

We recommend using memory cards rated Speed Class 4, 6 or 10.

SDXC Memory Cards

Use SDXC memory cards only with SDXC-compatible devices, such as SDXC-compatible digital recorders, computers and card readers. The table below summarizes compatibility by computer operating system, as of October 2010. For the latest information, however, contact the computer, operating system or memory card manufacturer.

Compatible operating systems for SDXC memory cards

Operating system	Compatibility
Windows 7	Compatible
Windows Vista	Compatible (requires Service Pack 1 or later)
Windows XP	Compatible (requires Service Pack 3 and KB955704 update)
Mac OS X	Not compatible

IMPORTANT

- If you use an SDXC memory card with a computer OS that is not SDXC-compatible, you may be prompted to format the memory card. In such case, **cancel the operation to prevent data loss**.
- After repeatedly recording, deleting and editing scenes (fragmented memory), it will take longer to write data on the memory and recording may stop. Save your recordings and initialize the memory.

Eye-Fi Cards

This product is not guaranteed to support Eye-Fi card functions (including wireless transfer). In case of an issue with an Eye-Fi card, please check with the card manufacturer.

Also note that an approval is required to use Eye-Fi cards in many countries or regions. Without approval, use of the card is not permitted. If it is unclear whether the card has been approved for use in the area, please check with the card manufacturer.

IMPORTANT

- Do not insert an Eye-Fi card into card slot **A**. Doing so may cause a malfunction with the card's wireless communication functionality.

Inserting and Removing a Memory Card

Make sure to initialize (📖 41) all memory cards before using them with this camcorder.

1 Turn off the camcorder.

Make sure the ON/OFF (CHG) indicator is off.

2 Open the double memory card slot cover.

3 Insert the memory card into one of the memory card slots.

- You can also use two memory cards, one in each memory card slot.
- Insert the memory card straight, with the label facing up, all the way into the memory card slot until it clicks.
- To use the wireless communication features of an Eye-Fi card, insert it into memory card slot **B**. Be sure you understand the information provided in *Eye-Fi Cards* (📖 37) before using an Eye-Fi card.

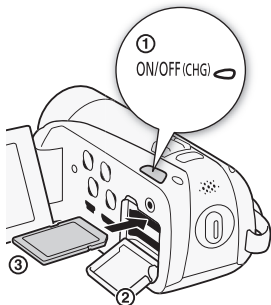

4 Close the double memory card slot cover.

Do not force the cover closed if the memory card is not correctly inserted.

To remove the memory card

Push the memory card once to release it. When the memory card springs out, pull it all the way out.

! IMPORTANT

- Memory cards have front and back sides that are not interchangeable. Inserting a memory card facing the wrong direction can cause a malfunction of the camcorder. Be sure to insert the memory card as described in step 3.

Selecting the Memory for the Recordings

You can select to record your movies and photos in the built-in memory (**HFR21/HFR20**) or on a memory card. The default memory for recording both is the built-in memory (**HFR21/HFR20**) or memory card **A** (**HFR200**).

Operating modes: **AUTO**  |  





POINTS TO CHECK

- Be sure you understand the information provided in *Eye-Fi Cards* (book 37) before using an Eye-Fi card.

HFR21/HFR20



[FUNC.] ➤ [MENU] ➤  ➤
[Rec Media for Movies] or [Rec Media for Photos] ➤
 (built-in memory), [A] (memory card **A**) or [B]
(memory card **B**)* ➤ [X]

HFR200



[FUNC.] ➤ [MENU] ➤  ➤
[Rec Media for Movies] or [Rec Media for Photos] ➤
[A] (memory card **A**) or [B] (memory card **B**)* ➤ [X]

* When selecting the memory, you can check the approximate available recording time, based on currently used settings.





NOTES

- **HFR21/HFR20** Select to record movies in the built-in memory or memory card **A** if you later want to convert the movies to standard definition in order to upload them to the Web.

Relay Recording of Movies

You can activate the relay recording so if the memory you are using becomes full while recording movies, the recording will continue automatically on a memory card.



When recording on memory card **A**, you can use memory card **B** for relay recording (**A** → **B**). **HFR21/HFR20** only: When recording in the built-in memory, you can choose to use only memory card **A** for relay recording ( → **A**), or use both memory cards ( → **A** → **B**).

Operating modes:   |  

1 Insert a memory card that contains no video recordings into the card slot of the memory card you want to use for relay recording.

- When relay recording from the built-in memory (**HFR21/HFR20** only): memory card slot **A** or both memory card slots.
- When relay recording from memory card **A**: memory card slot **B** only.

2 Activate the relay recording.

 [FUNC.] ➤ [MENU] ➤  ➤ [Rec Media for Movies] ➤  (**HFR21/HFR20** only) or [**A**] ➤ [Relay Recording] ➤ Desired option* ➤ [**X**]

* The approximate available recording time will now reflect the combined space in the memories used for relay recording.

NOTES

- **HFR21/HFR20** You cannot use relay recording from the built-in memory to memory card **B**. When using a single memory card, be sure to insert it into memory card slot **A**.
- There will be a momentary stop in the scene at the point where the recording switched to a different memory.
- Any of the following actions will deactivate the relay recording function:
 - Turning off the camcorder.
 - Opening the double memory card slot cover.
 - Changing the camcorder's operating mode.
 - Changing the memory used for recording movies.

Initializing the Memory

Initialize memory cards when you use them with this camcorder for the first time. You can also initialize a memory card or the built-in memory (HFR21/HFR20 only) to permanently delete all the recordings it contains. HFR21/HFR20 At the time of purchase, the built-in memory comes pre-initialized and contains music files for use as background music during playback. It also contains images used for the image mix function.









Operating modes:  |  |  | 

1 Power the camcorder using the compact power adapter.







Do not disconnect the power source or turn off the camcorder until the initialization is completed.

2 Initialize the memory.

HFR21/HFR20

 [FUNC.]¹ ➤ [MENU] ➤  ➤ [Initialize / ] ➤
[ Built-in Mem.], [ Mem. Card A] or [ Mem. Card B]
➤ [Initialize] ➤ [Complete Initialization]² ➤ [Yes]³ ➤ [OK]
➤ []

HFR200

 [FUNC.]¹ ➤ [MENU] ➤  ➤ [Initialize ] ➤
[ Mem. Card A] or [ Mem. Card B] ➤ [Initialize] ➤
[Complete Initialization]² ➤ [Yes]³ ➤ [OK] ➤ []

¹ Only when performing the procedure in  mode.

² Touch this option if you want to physically erase all the data rather than just clear the file allocation table of the memory.

³ If you selected the [Complete Initialization] option, you can touch [Cancel] to cancel the initialization while it is in progress. All recordings will be erased and the memory can be used without any problem.

IMPORTANT

- Initializing the memory will permanently erase all recordings. Lost original recordings cannot be recovered. Make sure you save important recordings in advance using an external device (📖 116).
- Initializing a memory card will permanently erase any music and image files you may have transferred to the card. (HFR21/HFR20 The music and image files that come pre-installed in the built-in memory will be restored after it is initialized.)
 - Windows users: Use the supplied software PIXELA's **Transfer Utility** or **VideoBrowser** to transfer music files from the supplied Camcorder Supplemental Disc to a memory card after it is initialized. For details, refer to the Software Guide (PDF file) of the supplied software.
 - Mac OS users: Use Finder to transfer music files from the [MUSIC] folder on the supplied Camcorder Supplemental Disc to a memory card after it is initialized. Refer to *About the music files* (📖 181) for the folder structure of the memory card.
- At the time of purchase, Eye-Fi cards contain the necessary network configuration software. Be sure to install the software and complete the required configuration setup before you initialize the Eye-Fi card prior to using it with this camcorder. Initializing the card will erase the software contained in the card.



Smart AUTO Mode

This chapter covers how to easily record video and photos in Smart AUTO mode, and how to use basic shooting functions like zoom and Quick Start. To enjoy full access to menus and more advanced functions, refer to the relevant chapters for video (📖 58) and photos (📖 107).

Basic Recording

Before you begin recording, make a test recording first to check that the camcorder is operating correctly.

Shooting Video and Taking Photos in Smart AUTO Mode

With Smart AUTO mode, you can take great-looking videos and photos by letting the camcorder automatically adjust settings based on the recording situation.

Operating modes: **AUTO**  |  

1 Turn on the camcorder.

- By default, movies and photos are recorded in the built-in memory (**HFR21/HFR20** only) or on memory card **A** (**HFR200**). You can select the memory that will be used to record movies and photos (📖 39).
- Please read the **IMPORTANT** section (📖 46) before using an Eye-Fi card.

2 Press **AUTO**.

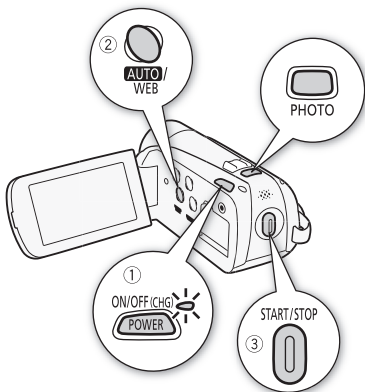

To record video

3 Press **START/STOP** to begin recording.

Press **START/STOP** again to pause the recording.

To take photos

3 Press **PHOTO** halfway.

If the subject is not in focus,  will flash in yellow. Adjust the camcorder's position and press **PHOTO** halfway again. Once the focus is automatically adjusted,  will turn green and one or more AF frames will appear.







4 Press **PHOTO** fully.

The ACCESS indicator will flash as the photo is being recorded.

When you have finished recording































- 1 Make sure that the ACCESS indicator is off.
- 2 Turn off the camcorder.
- 3 Close the LCD panel.

About the Smart AUTO mode

- Only the following functions are available in this mode.
 - Zoom ( 47).
 - Quick Start ( 49).
 - Video snapshot ( 68).
 - Image stabilization modes ( 64).
 - Face detection ( 66) to get beautiful shots of people every time, tracking the subject even if the person moves.
 - Touch & Track ( 67) to track other moving subjects, keeping them in focus and using the best settings to record them.
 - Decorating scenes ( 97).







- When shooting in **AUTO** mode, the camcorder will automatically detect certain characteristics of the subject, background, lighting conditions, etc. It will then adjust various settings (focus, exposure, color, image stabilization, image quality, among others), selecting the best settings for the scene you want to shoot. The Smart AUTO mode icon will change to one of the following icons.

Smart AUTO icons

Background → (color of the icon)	Bright (gray)	Blue skies (light blue)	Vivid colors (green/red)	Sunsets (orange)
Subject ↓				
People (stationary)	 	 	 	—
People (moving)	 	 	 	—
Subjects other than people, such as landscapes	 	 	 	
Close objects	   	   	   	—



The icon in parentheses appears under backlight conditions.

* When "T" appears in the icon, this indicates that tele-macro ( 72) has been activated.











Background → (color of the icon)	Dark (dark blue)		
Subject ↓		Spotlight	Night scene
People (stationary)		—	—
People (moving)		—	—
Subjects other than people, such as landscapes			
Close objects	 	—	—

* When "T" appears in the icon, this indicates that tele-macro ( 72) has been activated.

IMPORTANT

- Observe the following precautions while the ACCESS indicator is on or flashing. Failing to do so may result in permanent data loss or damage to the memory.
 - Do not open the double memory card slot cover.
 - Do not disconnect the power source or turn off the camcorder.
 - Do not change the camcorder's operating mode.
- Be sure to save your recordings regularly ( 116), especially after making important recordings. Canon shall not be liable for any loss or corruption of data.
- When recording photos on an Eye-Fi card in memory card slot **B**, photos will be uploaded automatically when the camcorder is in playback mode if you are within the range of a configured network. Always verify that Eye-Fi cards have been approved in the country/region of use. See also *Using an Eye-Fi card* ( 131).



NOTES

- **About the Power Save mode:** If   [Power Saving Mode]  [Auto Power Off] is set to **[ON On]**, the camcorder will shut off automatically to save power when it is powered by a battery pack and is left without any operation for 5 minutes. Press **[POWER]** to turn on the camcorder.
- When recording in bright places, it may be difficult to use the LCD screen. In such cases, you can turn on the LCD backlight ( 27) or adjust the brightness of the LCD screen with the   [LCD Brightness] setting.
- Under certain conditions, the Smart AUTO icon that appears on the screen may not match the actual scene. Especially when shooting against orange or blue backgrounds, the Sunset or one of the Blue Skies icons may appear and the colors may not look natural. In such case, we recommend recording using the **[P Programmed AE]** recording program ( 61).
- In **[AUTO]** mode, the setup menus cannot be accessed and there is limited access to the FUNC. panel. However, the following settings can be changed in advance, before pressing **[AUTO]**.
 - FUNC. panel: [Decoration], [ZOOM], [Image Stabilizer].
 -  menu: [Auto Slow Shutter]
 -  menu: [Video Snapshot Length], [Rate Scenes (Recording)], [Rec Media for Movies], [Recording Mode], [Rec Media for Photos], [Photo Aspect Ratio]
 -  menu: All settings.

Zooming

Operating modes: **AUTO**  |  

The camcorder offers three types of zoom - optical, advanced and digital. For optical zoom, the camcorder uses the optical magnification ratio of the lens. For advanced zoom, the camcorder processes the image beyond the range of the optical zoom to obtain a larger zoom without any deterioration in image quality. For digital zoom, the image is processed digitally so image quality will deteriorate the more you zoom in.

In  mode, select the type using the   [Zoom Type] setting. In **AUTO** mode, [Zoom Type] will be set to [Advanced]. A summary of the zoom types is given in the table below.

[Optical] ¹	[Advanced]	[Digital]
20x	28x ²	400x

¹ When taking photos, only optical zoom is available.

² 24x when [Image Stabilizer] (FUNC. panel) is set to  Dynamic].

There are two ways you can zoom in and out: using the zoom lever on the camcorder or using the zoom controls on the touch screen.

Using the Zoom Lever

Move the zoom lever toward **W** (wide angle) to zoom out. Move it toward **T** (telephoto) to zoom in.

By default, the zoom lever operates at a variable speed – press gently for a slow zoom; press harder for faster zooms.

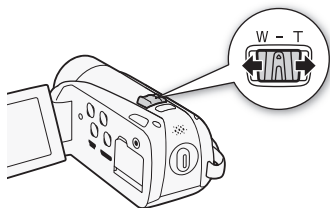

1 Display the zoom controls on the touch screen.

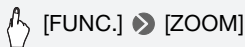

- The zoom controls appear on the left side of the screen.





2 Touch the zoom controls to operate the zoom.

Touch anywhere within the **W** area to zoom out or anywhere within the **T** area to zoom in. Touch closer to the center for a slow zoom; touch closer to the **W/T** icons for faster zooms.



3 Touch [X] to hide the zoom controls.

NOTES

- Keep at least 1 m (3.3 ft.) away from the subject. At full wide angle, you can focus on a subject as close as 1 cm (0.39 in.).
- When using tele-macro ( 72) and the camcorder is at full telephoto, you can focus on a subject as close as 40 cm (1.3 ft.).
- When recording at maximum advanced zoom, the video quality is equivalent to high definition.
- In  mode, you can also set  [Zoom Speed] to one of three constant speeds (3 is the fastest, 1 the slowest).
- When [Zoom Speed] is set to **[VAR Variable]**, the zoom speed will be faster in record pause mode than when actually recording, except when pre-recording ( 65) is activated.

Quick Start Function

When you close the LCD panel with the camcorder on, the camcorder enters the standby mode. In standby mode the camcorder consumes only about 1/3 the power used when recording, saving energy when you are using a battery pack. Additionally, when you open the LCD panel, the camcorder is ready to start recording in approximately 1 second*, allowing you to record the subject right away.

* The actual time required varies depending on the shooting conditions.

Operating modes:   |  

1 With the camcorder on and in a recording mode, close the LCD panel.

A beep will sound and the green ON/OFF (CHG) indicator will change to orange to indicate the camcorder entered standby mode.





2 When you wish to resume recording, open the LCD panel.

The ON/OFF (CHG) indicator turns back green and the camcorder is ready to record.

IMPORTANT

- Do not disconnect the power source during standby mode (while the ON/OFF (CHG) indicator is lit in orange).

NOTES

- The camcorder will not enter standby mode if the LCD panel is closed while the ACCESS indicator is on or flashing, or while a menu is being displayed. The camcorder may also not enter standby mode if the LCD panel is closed when the battery charge is too low. Check that the ON/OFF (CHG) indicator changes to orange.
- **About standby mode and auto power off:**
 - The camcorder will power off automatically if left in standby mode for 10 minutes. Press  to turn on the camcorder.
 - You can select the length of time until shut-off or turn off the Quick Start function altogether with the   [Power Saving Mode]  [Quick Start (Standby)] setting.
 - The usual 5-minute auto power off setting of [Power Saving Mode] is not applicable while the camcorder is in standby mode.



Video

This chapter covers functions related to movies, including playback, advanced shooting, advanced functions and scene operations. For details about basic video shooting, refer to *Smart AUTO Mode* (📖 43).

Basic Playback

Playing Back the Video

To play back scenes based on their rating, see *Playing Back Scenes by Rating* (📖 89).

Operating modes: **AUTO**  |  

1 Press .

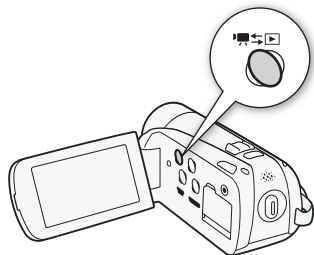

2 Open the date index screen, if it is not displayed.

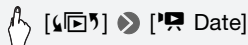

3 Look for the scene you want to play back.

Move the zoom lever toward **W** to show 15 scenes per page; move it toward **T** to show 6 scenes per page.



- 1 Memory being read.
- 2 Recording date.
- 3 Drag your finger left for the next index page*.
- 4 Drag your finger right for the previous index page*.
- 5 Select a different index screen to read different content or from a different memory (📖 54).
- 6 3D Flip View (📖 54)
- 7 [Edit] panel
- 8 Timeline (📖 80)
- 9 Divider indicating a change of recording date.

* While browsing through index pages, a scroll bar will appear at the bottom of the screen for a few seconds. When you have a large number of scenes it may be more convenient to drag your finger along the scroll bar.

4 Touch the desired scene to play it back.

- Playback will start from the scene selected and continue until the end of the last scene in the index screen.
- Touch the screen during playback to display the playback controls for a few seconds.

During playback:

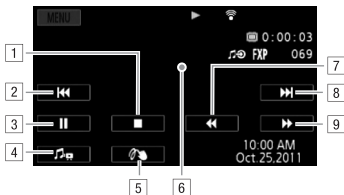

- 1 Stop the playback.
- 2 Jump to the beginning of the scene. Double-tap to jump to the previous scene.
- 3 Pause the playback.
- 4 Touch to show volume and audio balance controls. Drag your finger left and right along the bar to adjust. For [Music Balance], adjust toward [🔊] to increase the level of the original audio; adjust toward [🎵] to increase the level of background music. Set the level in the middle for an equal mix of both.
- 5 Decorate scenes (📖 97).
- 6 Touch anywhere else to hide the playback controls.
- 7 Fast playback backward*.
- 8 Jump to the next scene.
- 9 Fast playback forward*.

* Touch several times to increase the playback speed to approximately 5x → 15x → 60x the normal speed. During fast playback, touch anywhere on the screen to return to normal playback.

During playback pause:

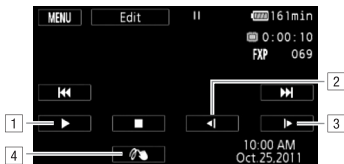

- 1 Resume playback.
- 2 Slow playback backward*.
- 3 Slow playback forward*.
- 4 Decorate scenes (📖 97).

* Touch repeatedly to increase the playback speed 1/8 → 1/4 the normal speed. During slow playback, touch anywhere on the screen to return to playback pause.

! IMPORTANT

- Observe the following precautions while the ACCESS indicator is on or flashing. Failing to do so may result in permanent data loss.
 - Do not open the double memory card slot cover.
 - Do not disconnect the power source or turn off the camcorder.
 - Do not change the camcorder's operating mode.
- You may not be able to play back with this camcorder movies recorded on a memory card using another device.

i NOTES

- Depending on the recording conditions, you may notice brief stops in video or sound playback between scenes.
- During fast/slow playback, you may notice some anomalies (blocky video artifacts, banding, etc.) in the playback picture.
- The speed indicated on the screen is approximate.

3D Flip View

3D Flip View is a fun way to display your video recordings (original scenes) in a 3D layout, organized by recording date.

In the date index screen, touch .

To return to the date index screen, touch .

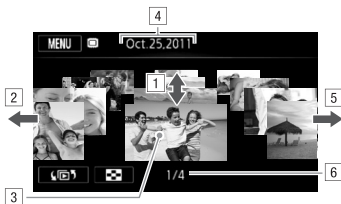

- 1 Drag your finger up and down to browse through the scenes recorded in the displayed date.
- 2 Drag your finger left to go to the next date with recordings.
- 3 Touch the scene in the front to play it back.
- 4 Currently selected recording date.
- 5 Drag your finger right to go to the previous date with recordings.
- 6 Current scene / Total number of scenes recorded on the selected date.

The Index Selection Screen: Selecting the Content to Play Back

From the index selection screen you can select the content you want to play back (original scenes or photos on the memory card, for example). You can also select the memory from which you want to play back your recordings.

Operating modes:   |  





In any index screen, touch .

During single photo view, touch the screen once to display the controls then touch  to open the [Photos] index screen.



- 1 Touch the tab of the desired memory: built-in memory (HFR21/HFR20 only), memory card **A** or memory card **B**.
- 2 Touch a control button to select the content you want to play back.

Options

-  **Date** Scenes in the date index screen are organized by recording date.
-  **Gallery** Scenes in the gallery screen are organized by various groups, or “stories” (📖 90). Touch  Gallery] and then the desired story.
-  **Photos** Display the photo index screen.
-  **SD Movies** HFR21/HFR20 only. When a memory card is selected, displays scenes that were converted to standard definition to upload them to the Web (📖 125).

NOTES

- Fast/slow playback modes are not available for scenes converted to standard definition. Scenes in the  SD Movies] index screen can be played back only at normal speed.

Date Index Screen and Gallery Screen

From the index selection screen, you can choose two methods to display scenes. Touch [📅 Date] to display the date index screen, which groups scenes by recording date. Touch [📁 Gallery] to display the gallery screen, which organizes scenes by various groups, or “stories”.

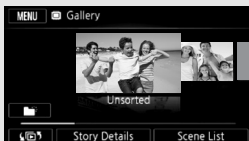

Gallery screen with [Unsorted] selected

The gallery screen, by default, contains two groups that are divided as follows.

[Unsorted]: For your regular scenes.

[Video Snapshot]: For video snapshot scenes.

Drag your finger left and right to show the next or previous story. To view your regular scenes, select [Unsorted]. To view your video snapshot scenes, select [Video Snapshot]. You can even create new stories that contain movies of your choosing and you can arrange their order to your liking (📖 90).

Deleting Scenes

You can delete those scenes that you are not interested in keeping. Deleting scenes allows you also to free up space on the memory. See also *Deleting Scenes and Stories from the Gallery* (📖 90).

Operating modes: **AUTO** [🔄] | [📺] [📷]

- 1 In the date index screen, open the screen that contains the scenes you want to delete.**

To delete all the scenes recorded on a specific date, select the index page that contains scenes from that date.

- 2 Touch [Edit] ➤ [Delete].**

3 Touch the desired option.

If you selected [Select], touch the scenes to delete and then touch [OK]. A checkmark ✓ will appear on selected scenes. Touch a selected scene again to remove the checkmark. You can also touch [Remove All] to remove all checkmarks.

4 Touch [Yes] ➤ [OK].

Touch [Stop] to interrupt the operation while it is in progress. Some scenes may be deleted nevertheless.

Options

[Date] Deletes all scenes recorded on the date displayed on the control button.

[Select] Deletes all scenes that you select.

[All Scenes] Deletes all scenes.

To delete scenes during playback

1 Touch the screen to display the playback controls.

2 Delete the scene.



! IMPORTANT



- Be careful when deleting original recordings. Once deleted, original scenes cannot be recovered.
- Save copies of important scenes before deleting them (📖 116).
- Observe the following precautions while the ACCESS indicator is on or flashing (while scenes are being deleted).
 - Do not open the double memory card slot cover.
 - Do not disconnect the power source or turn off the camcorder.
 - Do not change the camcorder's operating mode.

i NOTES

- Deleting a scene from the gallery screen or date index screen will delete that scene permanently from the camcorder.
- To delete all movies and make all recordable space available again you may prefer to initialize the memory (📖 41).

Advanced Functions

Shooting Video in Flexible Recording Mode

When the camcorder is in  (flexible recording) mode, you can enjoy full access to the menus and manually adjust the exposure, focus, white balance and many more of the camcorder's settings to your preference. The camcorder can even help you with the settings, for example, when you use Special Scene recording programs ( 61).

Operating modes:   |  

1 Turn on the camcorder.

By default, movies are recorded in the built-in memory (**HFR21/HFR20** only) or on memory card **A** (**HFR200**). You can select the memory that will be used to record movies ( 39).



2 Press to begin recording.

Press  again to pause the recording.

Reviewing Your Recording

You can play back the last scene recorded to check it. The camcorder will play back the last 4 seconds of the scene but without sound.



 **[FUNC.]**  **[ Review Recording]**

IMPORTANT

- Observe the following precautions while the ACCESS indicator is on or flashing. Failing to do so may result in permanent data loss or damage to the memory.
 - Do not open the double memory card slot cover.
 - Do not disconnect the power source or turn off the camcorder.
 - Do not change the camcorder's operating mode.

- Be sure to save your recordings regularly (📖 116), especially after making important recordings. Canon shall not be liable for any loss or corruption of data.



NOTES

- The zoom, Quick Start function, power saving modes, etc. operate the same way in  mode as in  mode. For details, refer to *Smart AUTO Mode* (📖 43).

Selecting the Video Quality (Recording Mode)

The camcorder offers 5 recording modes. Changing the recording mode will change the recording time available on the memory. Select MXP or FXP mode for better movie quality; select LP mode for longer recording times. The following table gives approximate recording times.

Operating modes:  |  |  | 

 [FUNC.] ➤ [MENU] ➤  ➤ [Recording Mode] ➤
Desired recording mode ➤ 

NOTES

- Scenes recorded in MXP mode cannot be saved onto AVCHD discs. Save such scenes onto Blu-ray discs or use the supplied PIXELA's **VideoBrowser** to back up such scenes. If you use PIXELA's **VideoBrowser**, however, scenes will be converted to FXP mode quality.
- The camcorder uses a variable bit rate (VBR) to encode video so the actual recording times will vary depending on the content of the scenes.
- The camcorder retains the last setting used even if you set the camcorder to  mode.

Approximate recording times

◆ Default value

Recording mode → Memory ↓	MXP ¹	FXP ¹	XP+	SP [◆]	LP
4 GB Memory card	20 min.	30 min.	40 min.	1 hr. 10 min.	1 hr. 30 min.
8 GB Memory card/ HFR20 Built-in memory ²	40 min.	1 hr.	1 hr. 25 min.	2 hr. 20 min.	3 hr.
16 GB Memory card	1 hr. 25 min.	2 hr. 5 min.	2 hr. 50 min.	4 hr. 45 min.	6 hr. 5 min.
32 GB Memory card/ HFR21 Built-in memory ²	2 hr. 55 min.	4 hr. 10 min.	5 hr. 45 min.	9 hr. 35 min.	12 hr. 15 min. ³

¹ Recorded in 1,920 x 1,080 resolution. Movies recorded using other recording modes are recorded in 1,440 x 1,080 resolution.

² HFR21/HFR20 At the time of purchase, the built-in memory contains about 70 MB of music files and 5 MB of image files.

³ A single scene can be recorded continuously for 12 hours; at that point, the camcorder will stop for about 3 seconds before resuming recording.

Selecting the Frame Rate

Select the frame rate before you make a recording to match your creative intent. Changing the frame rate will change the “feel” of your recordings, for example, by giving them a more cinematic look.

Operating modes: **AUTO**  |  

 [FUNC.]  [MENU]    [Frame Rate] 
Desired frame rate  [X]

Options (♦ Default value)

[60i 60i (Standard)]♦ 60 fields per second, interlaced. This is the default setting and is suitable for most situations.

[PF30 PF30] 30 frames per second, progressive. Use this frame rate to easily edit your recordings, for example, to post them on the Web. Using this frame rate, video is recorded as 60i.

[PF24 PF24] 24 frames per second, progressive. Using this frame rate will give your recordings a cinematic look. When combined with the [Cine Mode] recording program (63), the cinematic look will be enhanced. Using this frame rate, video is recorded as 60i.

NOTES

- When the frame rate is set to **[PF30 PF30]** or **[PF24 PF24]**, you cannot take photos.

Special Scene Recording Programs and Programmed AE

Recording in a very bright ski resort or capturing the full colors of a sunset or a fireworks display becomes as easy as selecting a Special Scene recording program.

On the other hand, you can select the Programmed AE (AE: auto exposure) recording program. With this recording program, the camcorder automatically adjusts the shutter speed and aperture while you are able to adjust the other settings.

Operating modes: **AUTO**  |  

 [FUNC.] ➤ [Rec. Programs] ➤ [Portrait]* ➤
Desired recording program ➤ [X]

* To set the Programmed AE recording program, select **[P Programmed AE]** instead and then touch **[X]**. The rest of the procedure is not necessary.

Options (♦ Default value)

[Portrait]♦ The camcorder uses a large aperture, to achieve a sharp focus on the subject while blurring the background.



[Sports] To record sports scenes such as tennis or golf.



[Night Scene] To record nightscapes with lower noise.

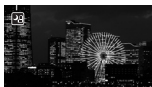

[Snow] To record in bright ski resorts without the subject being underexposed.



[Beach] To record on a sunny beach without the subject being underexposed.



[Sunset] To record sunsets in vibrant colors.



[Low Light] To record in low-light situations.











[Spotlight] To record spotlit scenes.



[ **Fireworks**] To record fireworks.



NOTES

- [ Portrait]/[ Sports]/[ Snow]/[ Beach]: The picture may not appear smooth during playback.
- [ Portrait]: The blur effect of the background increases the more you zoom in (**T**).
- [ Snow]/[ Beach]: The subject may become overexposed on cloudy days or in shaded places. Check the image on the screen.
- [ Low Light]:
 - Moving subjects may leave a trailing afterimage.
 - Picture quality may not be as good as in other modes.
 - White points may appear on the screen.
 - Autofocus may not work as well as in other modes. In such case, adjust the focus manually.
- [ Fireworks]:
 - To avoid camcorder blur (blur due to the camcorder moving) we recommend using a tripod.
 - When taking photos, slower shutter speeds are used so blur is more likely to occur. Stabilize the camcorder, for example, by mounting it on a tripod.

Cinema Mode: Giving a Cinematic Look to your Recordings

Give your recordings a cinematic look by using the [ Cine Mode] recording program. Combine this recording program with the 24 fps progressive frame rate [**PF24** PF24] to get the enhanced effect of the 24p Cinema Mode.



Operating modes: **AUTO** [] | [] []







[FUNC.] ➤ [Rec. Programs] ➤ [ Cine Mode] ➤ []

Image Stabilization

The image stabilizer reduces camcorder blur (blur due to the camcorder moving) so you can get nice, stable shots. Select the image stabilization mode according to the shooting conditions. In **AUTO** mode, this function is set to [ Standard] and cannot be changed.



Operating modes: **AUTO**  |  

* Available for movies only.

 [FUNC.] ➤ [Image Stabilizer] ➤ Desired IS mode ➤ [



Options Default value)

 **Dynamic** Compensates for a higher degree of camcorder shake, such as when shooting while walking, and is more effective as the zoom approaches full wide angle.

 **Standard** Compensates for a lower degree of camcorder shake, such as when shooting while remaining stationary, and is suitable for shooting natural-looking scenes. Use this setting when recording movies with the optional Wide-converter or Tele-converter.

 **Off** Use this setting when the camcorder is mounted on a tripod.

NOTES





- If the degree of camcorder shake is too high, the image stabilizer may not be able to fully compensate. The image stabilizer may not be able to successfully eliminate all blur if the camcorder or subject is moving too much.
- The image stabilizer may not work well on subjects with low contrast, with a recurring repetitive pattern or without vertical lines.
- When [Image Stabilizer] is set to [ Dynamic], if the background's movement does not appear natural, select [ Standard] or [ Off].

Pre-Recording

The camcorder will start recording 3 seconds before you press **[START/STOP]**, ensuring you do not miss important shooting opportunities. This is especially useful when it is difficult to predict when to start recording.

Operating modes: **AUTO**  |  

1 Activate the pre-recording function.

 **[FUNC.]**  **[ Pre REC]**  **[ON On]**  **[X]**

-  appears.
- Repeat, selecting **[OFF Off]**, to turn off pre-recording.

2 Press **[START/STOP]**.

The scene recorded in the memory will start 3 seconds before **[START/STOP]** was pressed.

NOTES



- While pre-recording is activated, the camcorder will not emit any notification sounds.
- The camcorder will not record the full 3 seconds prior to pressing **[START/STOP]** if the button was pressed within 3 seconds of having turned on pre-recording or having finished the previous recording.
- Any of the following actions will deactivate the pre-recording function.
 - Leaving the camcorder without any operation for 5 minutes.
 - Pressing **[VIDEO SNAP]**.
 - Changing the camcorder's operating mode.
 - Setting the camcorder to standby mode.
 - Opening the setup menus or using the following functions in the **FUNC.** panel: **[Rec. Programs]**, **[Decoration]**, **[White Balance]**, **[Image Stabilizer]**, **[Digital Effects]** or **[Review Recording]**.

Face Detection









The camcorder automatically detects people's faces and uses this information to select the optimal settings for beautiful videos and photos.

Operating modes: **AUTO**  |  

POINTS TO CHECK

- Select a recording program other than [ Night Scene], [ Low Light] or [ Fireworks].

By default, face detection is activated. If the function was turned off, perform the following procedure to turn it on.

 [FUNC.]  [MENU]   
[Face Detection & Tracking]  [**ON** On ]  [**X**]

To select the main subject

If there is more than one person in the picture, the camcorder will automatically select one person it determines is the main subject. The main subject is indicated by a white face detection frame and the camcorder will optimize the settings for that person. Other faces will have gray frames. Touching a subject will activate Touch & Track ( 67).



Main subject

NOTES

- The camcorder may mistakenly detect the faces of non-human subjects. In such case, turn face detection off.
- In certain cases, faces may not be detected correctly. Typical examples include:
 - Faces extremely small, large, dark or bright in relation to the overall picture.
 - Faces turned to the side, at a diagonal or partially hidden.

- Face detection cannot be used when the shutter speed used is slower than 1/30 (1/24 if the frame rate is set to [PF24 PF24]) or when the digital zoom is activated at more than 80x zoom.
- When face detection is activated, the slowest shutter speed used by the camcorder is 1/30 (1/24 if the frame rate is set to [PF24 PF24]).

Touch & Track

When recording people, face detection (📖 66) will track the main subject and adjust the optimal settings. But also when recording other moving subjects such as your pet, a moving vehicle or people not facing the camera directly, you can use Touch & Track to keep your subject in focus and achieve the best results.

Operating modes: **AUTO**  |  

- 1 **Make sure face detection is activated (📖 66).**
- 2 **Point the camcorder at a moving subject and touch the subject on the touch screen.**
 - A white double frame will appear around the subject and track it as it moves.
 - Touch [Cancel 

NOTES

- If there is more than one subject on the screen that have similar characteristics, such as color, the camcorder might track a subject different from the intended one. In such case, touch the desired main subject again.
- In certain cases, Touch & Track may not be able to track the subject. Typical examples include:
 - Subjects extremely small or large in relation to the overall picture.
 - Subjects too similar to the background.
 - Subjects lacking sufficient contrast.
 - Fast moving subjects.
 - When shooting indoors with insufficient lighting.

Video Snapshot

Record a series of short scenes or capture short scenes from a movie you have previously recorded. Play your video snapshot scenes set to your favorite music (📖 82) to create your own fun music video. You will be surprised how by changing the background music, you can give your scenes an entirely new feel.



Recording Video Snapshot Scenes

Operating modes: **AUTO**  |  

1 Press **VIDEO SNAP**.

- A blue border appears on the screen.
- Press **VIDEO SNAP** again to return to normal video recording mode.

2 Press **START/STOP**.

- By default, the camcorder records for about 4 seconds (the blue frame serves as a visual progress bar) and then automatically returns to record pause mode. You can change the length of video snapshot scenes to 2 or 8 seconds with the   [Video Snapshot Length] setting.
- When the camcorder stops recording, the screen will momentarily turn black as if a camera shutter had released.

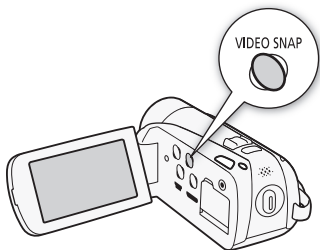



NOTES

- Changing the camcorder's operating mode will deactivate the video snapshot mode.

Digital Effects



Operating modes:   |  

 [FUNC.] ➤  Digital Effects ➤ Desired fader/effect* ➤
[X]

* You can preview the digital effect on the screen.

- The icon of the selected digital effect appears in green. Effects are applied immediately.

To fade in/out





Press  in record pause mode (●||) to start recording with a fade in. Press  while recording (●) to fade out and pause the recording.

Options (Default value)

 **Off*** Select this setting when you do not intend to use the digital effects.

 **Black & White*** Records movies and photos in black and white.

 **Sepia*** Records movies and photos in sepia tones for an “old” look.

 **Fade Trigger/Once**,  **Fade Trigger/Always**,  **Wipe/Once**,  **Wipe/Always** Select one of the faders to begin or end a scene with a fade from or to a black screen. You can choose to activate the fader only once, or every time you press  to begin or end a scene.

* Only these digital effects are available when taking photos.

NOTES

- By default, the camcorder fades from or to a black screen but you can change it to a white screen using the  ➤ [Fader Setting] setting.
- When you apply a fader, not only the picture but also the sound will fade in or out. When you apply an effect, the sound will be recorded normally.

- Faders cannot be used when recording video snapshot scenes or when pre-recording is activated.

Manual Exposure Adjustment

At times, backlit subjects may appear too dark (underexposed) or subjects under very strong lights may appear too bright or glaring (overexposed). To correct this, you can adjust the exposure manually or use the Touch AE function to automatically set the optimal exposure for the subject you select. This is convenient when the brightness of the subject you want to shoot is noticeably brighter/darker than the general brightness of the image.

Operating modes:   |  

POINTS TO CHECK

- Select a recording program other than [ Fireworks].

1 Open the exposure adjustment screen.



2 Touch a subject that appears inside the frame.

- The Touch AE mark () will flash and the exposure will be adjusted automatically so the area you touched will be correctly exposed. You have the option to further adjust the exposure manually as necessary.
- The manual adjustment dial appears and the adjustment value is set at ± 0 .
- Touch [**M**] to return the camcorder to automatic exposure.



3 Touch [] and [] to further adjust the exposure.

- The adjustment range may vary depending on the initial brightness of the image, and some values may be grayed out.
- Alternatively, you can drag your finger left and right along the dial.

4 Touch [**X**] to lock the exposure at the selected value.

During exposure lock,  and the selected exposure adjustment value will appear on the screen.

NOTES

- If the recording program is changed during exposure lock, the camcorder will return to automatic exposure.
- When shooting subjects with a strong light source behind them, the camcorder automatically corrects for the backlight. You can turn off the automatic backlight correction with the   [Auto Backlight Correction] setting.

Manual Focus Adjustment

Autofocus may not work well on the following subjects. In such case, focus manually.

- Reflective surfaces
- Subjects with low contrast or without vertical lines
- Fast moving subjects
- Through wet windows
- Night scenes



Operating modes:   |  

* Available for movies only.

POINTS TO CHECK

- Adjust the zoom before you start the procedure.

1 Open the manual focus screen.

 [FUNC.]  [ Focus]

2 Touch a subject that appears inside the frame.

- The Touch AF mark () will flash and the focusing distance will be adjusted automatically. You have the option to further adjust the focus manually as necessary.
- You can touch [MF] instead to adjust the focus manually without activating the Touch AF function.
- The manual focus controls and the current focusing distance appear (for reference only).
- Touch [MF] again to return the camcorder to autofocus.

3 Touch and hold [] or [] to adjust the focus.

- The center of the screen will be magnified to help you focus more easily. You can also turn off this function with the [] [Focus Assistance] setting.
- The focusing distance displayed will change as you adjust the focus. You can change the units used for the distance display with the [] [Distance Units] setting.
- If you wish to focus on faraway subjects such as mountains or fireworks, touch and hold [] until the focusing distance changes to ∞ .

4 Touch [] to lock the focus at the selected distance.

During manual focus, [MF] will appear on the screen.

NOTES

- While the optional Wide-converter or Tele-converter is attached, the focusing distance displayed will be incorrect.

Tele-macro

You can take close-up shots of nearby subjects by using tele-macro. You can create shots in which a small subject is in focus but the background is blurred, thereby emphasizing the subject.

Operating modes: |

POINTS TO CHECK

- Select a recording program other than [Fireworks].

[FUNC.] [ZOOM] []* []

* Touch again to deactivate tele-macro.

- The camcorder will zoom to full telephoto automatically.

NOTES

- Any of the following actions will deactivate tele-macro.
 - Turning off the camcorder.
 - Changing the camcorder's operating mode.
 - Zooming out toward wide angle.
 - Setting the recording program to [ Fireworks].
- Tele-macro cannot be activated or deactivated while recording.
- You can focus on a subject as close as 40 cm (1.3 ft.) at full telephoto.

White Balance

The white balance function helps you to accurately reproduce colors under different lighting conditions so that white objects will always look truly white in your recordings.

Operating modes:   |  

POINTS TO CHECK

- Select a recording program other than the Special Scene recording programs.

 [FUNC.] ➤ [WB White Balance] ➤ Desired option* ➤ [X]





* When you select [ Custom WB], set the custom white balance with the following procedure before touching [X].

To set the custom white balance



Point the camcorder at a white object, so it fills the whole screen, and touch [Set WB].

When the adjustment is completed,  stops flashing and disappears. The camcorder will retain the custom white balance even if you turn it off.

Options (Default value)







- [AWB Automatic]**  The camcorder automatically sets the white balance for natural looking colors.
- [ Daylight]** To record outdoors.
- [ Tungsten]** To record under tungsten and tungsten-type (3-wavelength) fluorescent lighting.
- [ Custom WB]** Use the custom white balance setting to make white subjects appear white under colored lighting.

NOTES

- **When you select the custom white balance:**
 - Set   [Zoom Type] to a setting other than [Digital].
 - Reset the white balance when you change locations or the lighting or other conditions change.
 - Depending on the light source,  may keep flashing. The result will still be better than with [AWB Automatic].
- Custom white balance may provide better results in the following cases:
 - Changing lighting conditions
 - Close-ups
 - Subjects in a single color (sky, sea or forest)
 - Under mercury lamps and certain types of fluorescent lights

Self Timer

Operating modes:   |  

 [FUNC.]  [MENU]    [Self Timer] 
[ON] On   [X]

-  appears.
- Repeat, selecting [OFF] Off, to turn off the self timer.

For movies: In record pause mode, press .

The camcorder starts recording after a 10-second countdown. The countdown appears on the screen.

For photos: Press **[PHOTO]**, first halfway to activate the autofocus and then fully.

The camcorder will record the photo after a 10-second countdown. The countdown appears on the screen.

NOTES





- Once the countdown has begun, any of the following actions will cancel the self timer.
 - Pressing **[START/STOP]** (when recording movies) or **[PHOTO]** fully (when recording photos).
 - Turning off the camcorder.
 - Changing the camcorder's operating mode.
 - Setting the camcorder to standby mode.

Audio Recording Level

You can adjust the audio recording level of the built-in or an external microphone. You can display the audio level indicator while recording.

Operating modes: **[AUTO]**  |  

1 Open the manual audio recording level adjustment screen.

 **[FUNC.]**  **[ Mic. Level]**  **[M Manual]**

- The audio level indicator and current audio recording level will appear on the screen.
- Touch **[A Automatic]** to return the camcorder to automatic audio recording levels.

Manual audio level adjustment

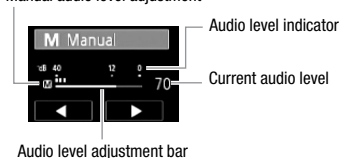



2 Touch and hold [◀] or [▶] to adjust the audio recording level as necessary.

- As a guideline, adjust the audio recording level so that the audio level meter will go to the right of the -12 dB mark only occasionally.
- If the  [Audio Mix] setting is [ON] On, an audio level indicator for the built-in microphone (INT) and external audio source (EXT) will be displayed.

3 Touch [X] to lock the audio recording level at the current level.

To display the audio level indicator

Usually, the audio level indicator will be displayed only after activating the manual adjustment of the audio recording level. You can choose to display it also when the audio level is adjusted automatically.

 [FUNC.] ➤  [Mic. Level] ➤ [A Automatic] ➤
[Audio Level Indicator] ➤ [X]

NOTES

- When the audio level meter reaches the red point (0 dB), the sound may be distorted.
- If the audio level is too high and the sound gets distorted, activate the microphone attenuator with the  [Microphone Attenuator] setting.
- We recommend using headphones to check the sound level while adjusting the audio recording level or when the microphone attenuator is activated.

Using Headphones

Use headphones for playback or to check the audio level while recording. The headphones are connected to the AV OUT/🎧 terminal, which is used for both the headphones and the audio/video output. Before connecting the headphones, follow the procedure below to change the function of the terminal from AV output to 🎧 (headphones) output.

Operating modes: **AUTO***  |  

* Headphones can be used also in **AUTO** mode but the function of the terminal cannot be changed. Change the setting in advance in  mode.

 [FUNC.]* ➤ [MENU] ➤  ➤ [AV/Headphones] ➤
[🎧 Headphones] ➤

To close the menu: ➤ [X]

To continue adjusting the volume:



➤  ➤ [Volume] ➤ Drag your finger left and right along the volume bar to adjust the volume ➤ [X]

* Only when performing the procedure in  mode.

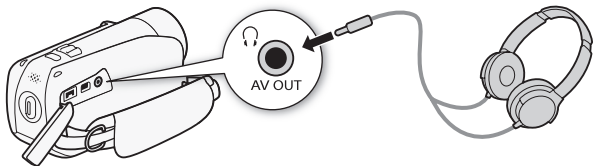
- 🎧 appears.



To adjust the volume during playback

In  mode, and in  mode during slideshow playback, you can adjust the headphone's volume the same way you adjust the speaker's volume (📖 52).

! IMPORTANT

- When using headphones, make sure to lower the volume to an appropriate level.
- Do not connect the headphones to the AV OUT/🎧 terminal if the 🎧 icon does not appear on the screen. The noise output in such case may be harmful to your hearing.

i NOTES

- Use commercially available headphones with a \varnothing 3.5 mm minijack.
- Even if [AV/Headphones] was set to [🎧 Headphones] in a playback mode, the function of the AV OUT/🎧 terminal will return automatically to AV output when you turn off the camcorder.

Using an External Microphone

When recording in very quiet surroundings, the built-in microphone may pick up the sound of the camcorder's internal machinery. In such case, we recommend using an external microphone, such as the optional WM-V1 Wireless Microphone.

Operating modes: **AUTO**  |  

Using the WM-V1 Wireless Microphone

With the WM-V1 Wireless Microphone, you can record audio in a variety of situations. After you affix the microphone unit to the subject, sound is transmitted to the receiver unit connected to the camcorder's MIC terminal. This will allow you to record sound that is difficult to pick up by the camcorder's built-in microphone alone. You can also combine the sound from the wireless microphone and built-in microphone as you record.

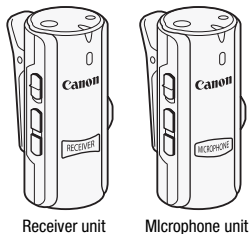

For details on operating the WM-V1 Wireless Microphone, refer to the wireless microphone's instruction manual.

Connect the external microphone to the MIC terminal.

Use commercially available condenser microphones with their own power supply. You can connect almost any stereo microphone with a \varnothing 3.5 mm plug but audio recording levels may vary.

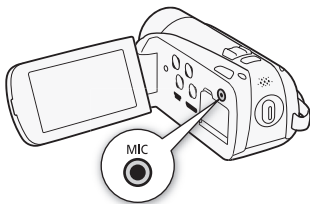

Selecting the Type of Audio Input

Perform the following after connecting the external microphone or audio device to the MIC terminal.

 [FUNC.] ➤ [MENU] ➤  ➤ [MIC Terminal Input] ➤
Desired option ➤ [X]

Options (♦ Default value)

[LINE External Audio] For audio input from an external audio source.







[MIC Microphone]♦ For a microphone connected to the camcorder.

Mixing Audio While Recording

You can combine the sound recorded from the external audio source (EXT) with the sound recorded from the built-in microphone (INT). You can adjust the balance so that the sound recorded from one microphone is a higher level than the sound recorded from the other microphone. Perform the following after connecting the external microphone or audio device to the MIC terminal.

 [FUNC.] ➤ [MENU] ➤  ➤ [Audio Mix] ➤
[ON On] ➤ [EXT] and [INT] to adjust the balance ➤ [X]

NOTES

- When an external microphone is connected to the camcorder,   [Wind Screen] will automatically be set to **[OFF]** Off .
- If the audio level is too high and the sound gets distorted, turn on the microphone attenuator with the   [Microphone Attenuator] setting or adjust the audio recording level manually ( 75).

Selecting the Playback Starting Point

If you have a very long scene, you may want to start playing back the scene from a certain point. You can use the movie timeline to break the scene to segments at fixed time intervals ranging from 6 seconds to 6 minutes.

Operating modes:   |  

- 1 Open the date index screen.
- 2 Open the scene's [Timeline] screen.

   Desired scene

- The [Timeline] screen appears. The large thumbnail will show the first frame of the scene. Below it, the timeline ruler shows frames taken from the scene at fixed intervals.
- 3 Touch the desired frame in the timeline ruler to start playing back the scene from that point.



- 1 Touch twice to return to the index screen.
- 2 Previous/next scene.
- 3 Drag your finger left along the ruler to display the next 5 frames.
- 4 Current scene / Total number of scenes.
- 5 Scene's recording mode and length.
- 6 Recording date and time.
- 7 Drag your finger right along the ruler to display the previous 5 frames.
- 8 Currently selected interval between frames.

To change the interval between frames



[6 sec] ► Desired interval ► [↶]

Playing Back Scenes or Slideshow Set to Background Music

You can play back scenes in the date index screen, stories in the gallery and photo slideshows set to background music. You can use one of the supplied music tracks or connect an external audio player to use your favorite songs as background music. You can also mix the original sound with the background music and even adjust the balance of their audio levels.

Operating modes:   |  

Using One of the Supplied Music Tracks as Background Music

The supplied Camcorder Supplemental Disc contains 3 music tracks you can use as background music. **HFR21/HFR20**: The music files come pre-installed in the built-in memory.











POINTS TO CHECK

- To play back scenes, stories or a slideshow of photos recorded on one of the memory cards, you will need to transfer the music tracks to the corresponding memory card in advance. For details, refer to the Software Guide (PDF file) of the supplied software.

- 1 Open the date index screen, gallery screen, or photo index screen.
- 2 Open the music track selection screen.



[MENU] ➤  /  ➤ [Select Music] ➤ [ON On] ➤ [▲] or [▼] to select the desired music track ➤  or  to adjust the audio balance ➤ [X]

- For scenes, you can adjust the audio during playback using the following procedure. Touch the screen to display the playback controls and then touch . Then, touch  or  to adjust the balance. When finished, touch .

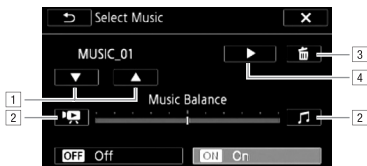

- 1 Select the desired music track.
- 2 Adjust toward [🔊] to increase the level of the original audio; adjust toward [🎵] to increase the level of background music. Set the level in the middle for an equal mix of both.
- 3 Delete the music track selected.
- 4 Listen to the music track selected. Touch again (■) to stop the playback.

To play back scenes from the date index screen

- 3 Touch a scene.

To play back from a particular scene in a story

- 3 Select the story that contains the scenes to play back.
Drag your finger right/left to bring the desired story to the front.
- 4 Play back the scenes.



[Scene List] ➤ Orange frame that appears to the right of the desired scene ➤ Thumbnail of the scene

To play back scenes by rating in a story

- 3 Select the story that contains the scenes to play back.
Drag your finger right/left to bring the desired story to the front.

4 Play back the scenes with a particular rating.



[Story Details] ➤ [Play by Rating] ➤ Desired rating marker corresponding to the rating of the scenes to play back ➤ [↶] ➤ Thumbnail of the scene

To play back a slideshow from the photo index screen

- 3 Touch a photo to go to single photo view and continue with the slideshow procedure (📖 109).

To delete a music track

In the music track selection screen, touch [▲] or [▼] to select the track you want to delete.



[🗑️] ➤ [Yes]

Using an External Audio Player for Background Music

Use your favorite songs as background music by connecting an external player.



POINTS TO CHECK

- You will need a commercially available audio cable with at least one mini-stereo plug (to connect to the MIC terminal on the camcorder); the other end will depend on external player used).

- 1 Open the date index screen, gallery screen, or photo index screen.
- 2 Activate the external audio input.



[MENU] ➤ [📷] / [📺] ➤ [External Audio Input] ➤ [ON] On [🎵]

- 3 Connect the external player to the camcorder's MIC terminal.

4 Adjust the audio input as necessary.

- Start the music playback on the external player and adjust its volume according to the onscreen indications. When the audio input is in the correct range, stop the music playback and touch [X] on the camcorder.
- Touch [External Player Link] to link the video playback to the start/end of the music from the external player.



Playback with the video/slideshow linked to the external audio

5 Start the music playback on the external player.

- Playback will start from the first scene or photo in the index screen.
- When the external audio input stops, the video playback will pause. When the external audio input is restored, video playback will resume automatically.
- When you play back the slideshow linked to the external audio, the photos will be displayed continuously until the music stops. When the external audio input stops, the slideshow will stop as well.

Playback with the video not linked to the external audio

5 Back in the index screen or gallery screen, touch a scene or story to start the video playback.

In  mode, touch a photo to go to single photo view and continue with the slideshow procedure ( 109).

6 Start the music playback on the external player.

IMPORTANT

- If you use copyrighted songs and music tracks in your video creations, remember that music under copyright may not be used without permission from the copyright holder, except for cases permitted under applicable laws, such as for personal use. Make sure to follow applicable laws when using music files.

NOTES

- Initializing a memory card will permanently erase any music files you may have transferred to the card. (HFR21/HFR20 The music files that come pre-installed in the built-in memory will be restored after it is initialized.)
 - Windows users: Use the supplied software PIXELA's **Transfer Utility** or **VideoBrowser** to transfer music files from the supplied Camcorder Supplemental Disc to a memory card after it is initialized. For details, refer to the Software Guide (PDF file) of the supplied software.
 - Mac OS users: Use Finder to transfer music files from the [MUSIC] folder on the supplied Camcorder Supplemental Disc to a memory card after it is initialized. Refer to *About the music files* (📖 181) for the folder structure of the memory card.
- Transfer music files to the memory card that contains the recordings you want to play back with background music.
- **About video playback linked to the external player:**
 - In some cases, the video playback may not be correctly linked to the external player. For example, if the volume of external player is too low or if the audio signal contains a lot of noise, etc.
 - When you connect the MIC terminal to the audio outputs on the external player and cannot adjust the strength of the signal, the camcorder will automatically decrease the volume of the external player when the audio signal is too loud.

Onscreen Displays and Data Code

You can turn most onscreen displays on or off.

Operating modes: **AUTO**  |  

Repeatedly press **[DISP.]** to turn the onscreen displays on/off in the following sequence:

 mode:

- All displays on
- Most displays off*

 and  modes**:

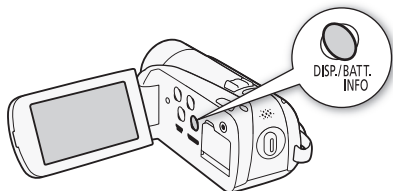

- Only data code on
- All displays on



* Pressing **[DISP.]** will turn off most of the icons and displays that appear automatically but will not remove onscreen displays that were turned on manually (for example, onscreen markers or the audio level meter).

**Touch the screen to display the playback controls.

About the Data Code

With every scene or photo recorded, the camcorder keeps a data code (date/time of recording, information about the camera setup, etc.). You can select the information to be displayed with the /  [Data Code] setting.





Rating Scenes

You can assign a rating to the scenes you record. Later, you can choose just the scenes of a particular rating to play back or edit.

Rating Scenes Right After Recording

You can rate your scenes immediately after recording them. Doing so will allow you to assign a rating while the scene is still fresh in your memory.

Operating modes:   |  

 [FUNC.] ➤ [MENU] ➤ [] ➤
[Rate Scenes (Recording)] ➤ [ On] ➤ [

- Select [ Off] to deactivate rating scenes after recording.

After you finish recording a scene, you can select one of the following rating marks for the scene.

[★★★★], [★★★], [★★•], [★••]: Rates the scene with three, two or one star, respectively.

[•••]: Leaves the scene unrated. If [Rate Scenes (Recording)] is set to [ Off], all recorded scenes will be unrated.

[— — —]: Rates the scene with a [— — —] rating.

Rating Scenes in the Gallery

Operating modes:   |  

- 1 From the gallery screen, select the story that contains the scenes to rate.**

Drag your finger right/left to bring the desired story to the front.

- 2 Touch [Scene List].**

- 3 When the desired scene appears in the orange bar, touch the frame on the right side.**

- You can drag your finger up and down to browse through the scene list.
- The [Edit Scene] screen will appear.

- 4 Select the desired rating for the scene.**

The selected rating mark will be highlighted.

- 5 Touch [.**

- The [Scene List] screen appears and the scene will have the selected rating.
- To return to the gallery screen, touch [] again.

Rating Scenes During Playback

- 1 Play back from the gallery the story that contains the scenes you want to rate.
- 2 During playback of a scene you want to rate, pause the playback and rate the scene.

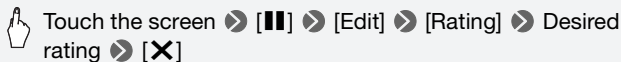

- 3 Touch [▶] to resume the playback and rate other scenes in the same way or touch [■] to return to the gallery.

Playing Back Scenes by Rating

You can play back scenes that have a particular rating.

Operating modes:  |  

- 1 From the gallery screen, select the story that contains the scenes to play back.

Drag your finger right/left to bring the desired story to the front.

- 2 Select a rating.

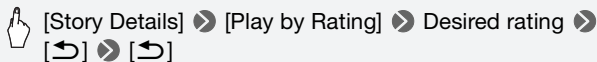

- 3 Touch the story's thumbnail.

If the story does not contain scenes of the selected rating, a message will be displayed. Touch [OK] to return to the gallery screen.

Gallery and Scene Operations

Managing Stories

The gallery initially contains two groups, [Unsorted] for your regular scenes and [Video Snapshot] for your video snapshot scenes. In addition, you can create new groups, or “stories”, which contain scenes of your choosing, arranged in an order to your liking. For example, you can create a story that is a collection of scenes from a particular event or trip.

Creating a New Story

Operating modes:   |  

1 Open the gallery screen.



2 Create a new story.



- Touch [No] to exit without creating a new story.

NOTES

- Including [Unsorted] and [Video Snapshot], a memory can contain a maximum of 100 stories.
- [Unsorted] and [Video Snapshot] cannot be deleted.

Deleting Scenes and Stories from the Gallery

You can delete scenes in the gallery that you no longer need. When you delete scenes, you can choose to delete individual scenes or an entire story (including all the scenes that comprise it).

To delete individual scenes

- 1 From the gallery screen, select the story that contains the scene to delete.
- 2 Delete the scene.

 [Scene List] ➤ Orange frame that appears to the right of the desired scene ➤ [🗑️] ➤ [Yes] ➤ [OK] ➤ [↩️]

- The scene is deleted and the gallery screen appears.

To delete scenes by rating

You can delete all the scenes in a story with a particular rating.

- 1 From the gallery screen, select the story that contains the scenes to delete.
Drag your finger right/left to bring the desired story to the front.
- 2 Open the [Delete] screen.

 [Story Details] ➤ [Edit Story] ➤ [Delete]

- 3 Select a rating mark that corresponds to the rating of the scenes to delete.
 - The selected rating mark will be highlighted and the number of applicable scenes will appear. If a story does not contain scenes of a particular rating, the corresponding rating mark will be grayed out.
 - You can select multiple rating marks.
- 4 Delete the scenes.

 [Set] ➤ [Yes]* ➤ [OK] ➤ [↩️]

* Touch [Stop] to interrupt the operation while it is in progress. Some scenes may be deleted nevertheless.

- The scenes are deleted and the gallery screen appears.

To delete a story

You can delete new stories that you have created.

1 From the gallery screen, select the story to delete.

Drag your finger right/left to bring the desired story to the front.

2 Delete the story.



[Story Details] ➤ [Edit Story] ➤ [Delete Story] ➤ [Yes]*
➤ [OK]

* Touch [Stop] to interrupt the operation while it is in progress. Some scenes may be deleted nevertheless.

- The story is deleted and the gallery screen appears.



IMPORTANT

- Deleting a scene from the gallery screen or date index screen will delete that scene permanently from the camcorder.

Moving or Copying Scenes in the Gallery

Move scenes in the gallery (individually or by rating) to play them back in the order of your choice. You can also copy scenes to another story. Note that you cannot move or copy scenes to [Unsorted] or [Video Snapshot].

To move individual scenes

1 From the gallery screen, select the story that contains the scenes to move.

Drag your finger right/left to bring the desired story to the front.

2 Touch [Scene List].

3 When the desired scene appears in the orange bar, touch the frame on the right side.

- You can drag your finger up and down to browse through the scene list.
- The [Edit Scene] screen will appear.

4 Touch [Move] or [Copy].

Thumbnails of each story (except for [Unsorted] and [Video Snapshot]) will appear.

5 Touch the thumbnail of the story where you want to move or copy the scenes.

If you are moving or copying scenes to an empty story, skip to step 7.

6 Drag your finger up and down to select the desired position and then touch [Set].

The orange bar (destination icon) indicates where in the story the scene will be moved or copied to.

7 Touch [Yes].

When copying scenes, you can touch [Stop] to interrupt the operation while it is in progress. After scenes are copied, touch [OK] when the confirmation screen appears.

8 Touch [↩].

To move scenes by rating

You can move scenes of a particular rating from one story to another.

1 From the gallery screen, select the story that contains the scenes to move.

Drag your finger right/left to bring the desired story to the front.

2 Open the [Move Story] screen.



[Story Details] > [Edit Story] > [Move Story]

3 Select a rating mark that corresponds to the rating of the scenes to move.

- The selected rating mark will be highlighted and the number of applicable scenes will appear. If a story does not contain scenes of a particular rating, the corresponding rating mark will be grayed out.
- You can select multiple rating marks.

4 Move the scenes.



[Set] ➤ Thumbnail of the story where you want to move scenes ➤ [Yes] ➤ [↩]

- The scenes are moved and the gallery screen of the source story appears.

IMPORTANT

- You cannot move or copy scenes to [Unsorted] or [Video Snapshot].

Capturing Video Snapshot Scenes and Photos from a Movie

You can capture video snapshot scenes or photos from a previously recorded scene. For example, you may want to take photos from video recorded at a party or create a small video clip using video snapshot scenes from the highlights of an event.

Operating modes:   |  

Capturing a Video Snapshot Scene

- 1 Open the index screen that contains the scene from which you want to capture the video snapshot scene.
- 2 Play back the desired scene.
- 3 Press **[START/STOP]** to capture the video snapshot scene.

The camcorder captures the video snapshot scene for about 4 seconds (the blue frame serves as a visual progress bar), and then enters playback pause mode. You can change the length of video snapshot scene you capture with the  ➤ [Video Snapshot Length] setting.

- 4 Touch the screen and then touch **[■]** to return to the index screen.

NOTES

- A video snapshot scene can be captured only during playback; it cannot be captured during playback pause mode.



- The captured video snapshot scene is saved to the same memory that contains the source scene.
- In the gallery screen, a captured video snapshot scene is saved in [Video Snapshot] as the last scene.
- Video snapshot scenes cannot be captured from any of the following types of scenes.
 - Scenes shorter than 1 second
 - Scenes that were edited using the supplied software PIXELA's **VideoBrowser** and were then written back to the camcorder.
- When the source scene is itself a video snapshot scene, you may not be able to capture a video snapshot scene depending on the length of the source scene and the length currently selected for video snapshot scenes.
- When you start capturing a video snapshot scene less than 1 second from the end of the scene, the video snapshot scene will be captured starting from the beginning of the following scene.
- During the playback of video snapshot scenes captured from a previously recorded movie, you may notice some anomalies in the picture/sound at the point where the playback switches to a new scene.

Capturing Photos

You can capture a photo from a movie during playback. The size of the captured photos will be 1920x1080.

Please read the IMPORTANT section before using an Eye-Fi card.

Operating modes:   |  

- 1 Play back the scene from which you want to capture the photo.
- 2 Pause the playback at the point you want to capture.
- 3 Press  fully.
- 4 Touch  to return to the index screen.

IMPORTANT

- When capturing photos on an Eye-Fi card in memory card slot **B**, photos will be uploaded automatically when the camcorder is in playback mode if you are within the range of a configured network. Always verify that Eye-Fi cards have been approved in the country/region of use. See also *Using an Eye-Fi card* ( 131).

NOTES

- The data code of the photos will reflect the date and time of recording of the original scene.
- Photos captured from a scene with a lot of fast movement may be blurred.
- Photos will be recorded on the memory selected for recording photos.

Dividing Scenes

You can divide scenes in order to leave out the best parts and later cut out the rest.

Operating modes:   |  





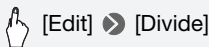

- 1 Select the scene you want to divide and touch it to start playing it back.**

You can also divide a scene in a story.

- 2 Pause the playback at the point where you want to divide the scene.**
- 3 Open the scene division screen.**



- 4 Bring the scene to a precise point, if necessary.**

- During playback pause: Touch  to play back the scene. Touch  or  to jump a frame backward/forward.
- During playback: Touch  to pause the playback. Touch  or  for fast playback backward/forward.

- 5 Divide the scene.**

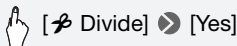

- The video from the division point to the end of the scene will appear as a new scene in the index screen.

NOTES

- When advancing/reversing frames while dividing the scenes, the interval between frames is about 0.5 seconds.
- If the scene cannot be divided at the point where you paused the playback, advance/reverse a frame and then divide the scene.
- During the playback of a scene that was divided, you may notice some anomalies in the picture/sound at the point where the scene was cut.
- The following scenes cannot be divided:
 - Video snapshot scenes and other scenes that are too short (less than 3 seconds).
 - Scenes that were edited using the supplied software PIXELA's **VideoBrowser** and were then written back to the camcorder.
- Scenes cannot be divided within 1 second from the beginning or the end of the scene.

Decorating Scenes

Add a new level of enjoyment to scenes by decorating them. You can add animated graphics, stamps, even your own drawings with the supplied stylus pen, and more!

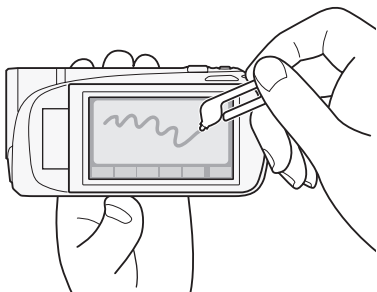

Operating modes: **AUTO**  |  

Decorating while Recording

- 1 Open the decoration screen.



- You can open the decoration screen when the LCD panel is stowed with the LCD screen facing away from the camcorder. In such case, make sure  ➤ [Autostart Decoration] is set to [ON On].

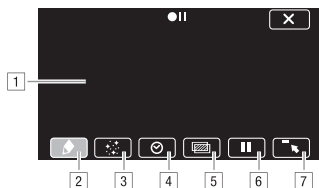

- 1** Canvas: This is the area on which you will draw and see your decorations in action. Items **2** to **7** collectively make up the toolbar and are used to decorate the canvas.
- 2** [Pens and Stamps]: Allows you to select the type of pen or stamp and its color. After you add decorations, you can save the canvas. However, only one canvas can be saved per memory.
- 3** [Animated Stamps]: You can select animated stamps to include in your decoration. You can place them anywhere on the canvas.
- 4** [Date and Time]: Adds the date and/or time to the canvas. You can then move it anywhere you like.
- 5** Image mix: Choose one of 27 different frames to add to the canvas and mix with live video. This can be used in combination with the pens, stamps and animated stamps.
- 6** Freeze screen: Freezes the screen when decorating. You can record the screen while it is frozen.
- 7** Minimize toolbar: Minimizes the toolbar to the top of the screen. To restore the toolbar, touch .

2 Use a tool from the toolbar.

See below for an explanation of each tool.

3 Press **START/STOP** to record.

The onscreen decorations will be included in the recording.

To use ([Pens and Stamps])

1 Touch .

The [Pens and Stamps] screen will appear.

2 Select the desired pen or stamp from [Tools].

You can also clear the canvas, save a canvas or load a canvas. See the following procedures.

3 Select white or black from [Colors].

Alternatively, you can touch  and select a color from the displayed colors.

4 Touch .

The canvas appears on the screen.

5 Draw on the canvas.

To clear the [Pens and Stamps] decorations

1 While the canvas is displayed, touch .

2 Touch [Clear] [Yes].

The [Pens and Stamps] decorations are cleared.



To save the [Pens and Stamps] decorations

1 While the canvas is displayed, touch .

2 Touch [Save] [Yes].

- The current [Pens and Stamps] decorations are saved.
- Only one canvas can be saved to the memory. The canvas is saved to the built-in memory (**HFR21**/**HFR20**) or memory card **A** (**HFR200**).

To load a [Pens and Stamps] decoration





- 1 While the canvas is displayed, touch [].
- 2 Touch [Load]  [Yes].

The [Pens and Stamps] decorations saved to the memory are loaded and appear on the canvas.



To use ([Animated Stamps])

- 1 Touch [].
The [Animated Stamps] screen will appear.
- 2 Select the desired stamp number.
- 3 Touch a spot on the canvas to place the selected stamp.

To use ([Date and Time])

- 1 Touch [].
- 2 Touch [Date] or [Time] and then touch [].
 - The selected option will appear on the screen. Touch both control buttons to display both the date and time.
 - You can also touch one of the three control buttons on the bottom to change how the date/time is displayed. [] places the date/time in a dark frame, [] displays the date/time in white, [] displays the date/time in black.
- 3 Touch the date or time and drag your finger to the desired location.

To use (image mix)

- 1 Touch [].
You can touch one of the memory icons at the bottom of the screen to read image mix frames saved on a different memory (**HFR21/HFR20**: only when recording on or playing back scenes from a memory card).
- 2 Touch [ON].
The [Select Image] screen will appear.
- 3 Touch [+] or [-] to select a different image.
- 4 Touch [].
The selected image will appear on the canvas.

Mixing Your Own Images with Live Video

You can use images you make on your computer for the image mix (Chroma Key) function. Make sure that the image you want to use has a blue or green area, which will be replaced by the live video using Chroma Key mixing. Refer to *About the image files for the image mix function* (📖 181) for details about the types of image files that can be used and where to transfer them.

Blue/Green area that will be replaced by the live video

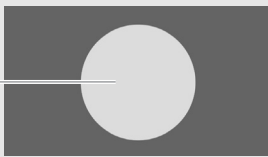

Example of an image used for Chroma Key

- 1 Turn on the image mix function.



[FUNC.] ➤ [👉 Decoration] ➤ [🖼️] ➤ [ON]

- 2 Touch [+] or [-] to select the image you created.
- 3 Touch [▶] to open the [Chroma Key] screen.
- 4 Touch [Green] or [Blue] depending on the characteristics of the image you want to use and touch [◀] or [▶] or drag you finger along the bottom bar to adjust the chroma key setting as necessary.
- 5 Touch [▶] at the top of the screen to open the [Transparency] screen.
- 6 Touch [◀] or [▶] or drag you finger along the bottom bar to adjust the overall transparency of the image as necessary.
- 7 Touch [↷] to mix your image with live video.

To use (freeze screen)

1 Touch .

The control button will change to  and the picture will be frozen.

2 Decorate the screen using the other tools in the palette.

3 Touch .

The screen will return to normal.

NOTES

- If the memory that contains the canvas is initialized, the canvas will be deleted.
- When the [Animated Stamps] tool is used, the date/time will not be displayed or recorded.

Decorating during Playback

You can decorate scenes being played back in the same way that you decorate scenes being recorded. Note that decorations added to a scene during playback will not be recorded with the scene. However, when you convert scenes to standard definition ( 125), the decorations will be superimposed on the SD movies*.

* / only.

1 Play back the scene to decorate.

2 Touch the screen to display the playback controls.

3 Touch .

- The canvas and toolbar will appear. Decorate the canvas as described in the previous section.
- The image mix function is not available when decorating scenes during playback or scenes being converted to standard definition.



Photos

Refer to this chapter for details on taking and viewing photos. For details about basic photo shooting, refer to *Smart AUTO Mode* (📖 43).

Basic Playback

Viewing Photos

Operating modes:   |  

1 Press .

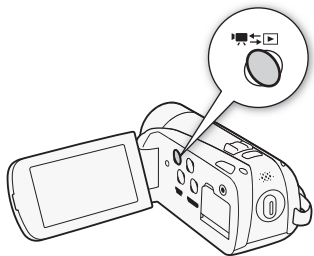

2 Open the [Photos] index screen.

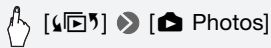

3 Look for the photo you want to play back.

Move the zoom lever toward **W** to show 15 photos per page; move it toward **T** to show 6 photos per page.

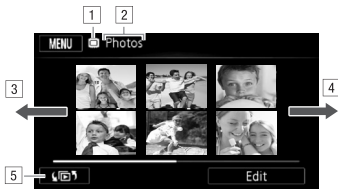

- 1 Memory being read.
- 2 Index screen currently displayed.
- 3 Drag your finger left for the next index page.
- 4 Drag your finger right for the previous index page.
- 5 Select a different index screen to read different content or from a different memory (📖 54).

4 Touch the photo you wish to view.

- The photo is displayed in single photo view.
- Drag your finger left/right to browse through the photos one by one.

To return to the index screen from single photo view

- 1 Touch the screen to display the playback controls.
- 2 Touch [🎞️].

Photo Jump Function

When you have recorded a large number of photos, you can jump easily through the photos using the scroll bar.

- 1 Touch the screen to display the playback controls.
- 2 Jump through the photos using the scroll bar.

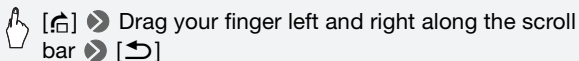

IMPORTANT

- Observe the following precautions while the ACCESS indicator is on or flashing. Failing to do so may result in permanent data loss.
 - Do not open the double memory card slot cover.
 - Do not disconnect the power source or turn off the camcorder.
 - Do not change the camcorder's operating mode.
- The following image files may not be displayed correctly.
 - Images not recorded with this camcorder.
 - Images edited on or uploaded from a computer.
 - Images whose file names have been changed.

Deleting Photos

You can delete those photos that you are not interested in keeping.

Operating modes:   |  

Deleting a Single Photo

- 1 In single photo view, select the photo you want to delete.
- 2 Touch the screen to display the playback controls.
- 3 Delete the photo.

 [Edit] ➤ [Delete] ➤  Proceed] ➤ [Yes]

- 4 Drag your finger left/right to select another photo to delete or touch **[X]**.

Deleting Photos from the Index Screen

From the index screen, you can delete selected photos or all photos.

1 Open the [Photos] index screen.



2 Select the photos to delete.



If you selected [Select], touch the photos to delete and then touch [OK]. A checkmark ✓ will appear on selected photos. Touch a selected photo again to remove the checkmark. You can also touch [Remove All] to remove all checkmarks.

3 Touch [Yes] ➤ [OK].

Touch [Stop] to interrupt the operation while it is in progress.

Options

[Select] Deletes all photos that you select.

[All Photos] Deletes all photos.

! IMPORTANT



- Be careful when deleting photos. Deleted photos cannot be recovered.
- Photos protected with another device cannot be deleted.

Additional Functions

Taking Photos in Flexible Recording Mode

Operating modes: **AUTO**  |  

1 Turn on the camcorder.

- **HFR21/HFR20** By default, photos are recorded in the built-in memory. You can set the memory card as the recording media for photos ( 39).
- Please read the **IMPORTANT** section ( 108) before using an Eye-Fi card.

2 Press **PHOTO** halfway.

Once the focus is automatically adjusted,  will turn green and one or more AF frames will appear.

3 Press **PHOTO** fully.

The ACCESS indicator will flash as the photo is being recorded.

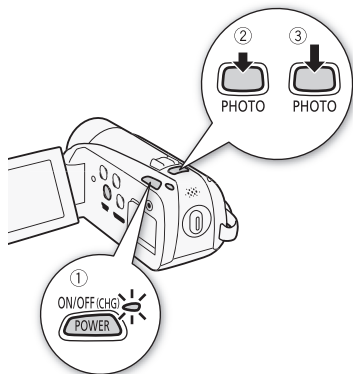

When you have finished recording

- 1 Make sure that the ACCESS indicator is off.
- 2 Turn off the camcorder.
- 3 Close the LCD panel.

IMPORTANT

- Observe the following precautions while the ACCESS indicator is on or flashing. Failing to do so may result in permanent data loss.
 - Do not open the double memory card slot cover.
 - Do not disconnect the power source or turn off the camcorder.
 - Do not change the camcorder's operating mode.
- After recording photos on an Eye-Fi card in memory card slot **B**, photos will be uploaded automatically when the camcorder is in playback mode if you are within the range of a configured network. Always verify that Eye-Fi cards have been approved in the country/region of use. See also *Using an Eye-Fi card* (📖 131).

NOTES

- You cannot take photos when  [Frame Rate] is set to [PF30 PF30] or [PF24 PF24]. Also, you cannot take photos when digital zoom is activated (light blue area on the zoom bar).

Selecting Photo Size

You can select the size of photos by choosing the aspect ratio. You can select [**4:3** 2016x1512] or [**16:9** 1920x1080]. If you select [**16:9** 1920x1080], the photo will be recorded in a wide aspect ratio.

Operating modes:   |  

 [FUNC.]  [MENU]    [Photo Aspect Ratio] 
Desired photo size (aspect ratio)  [**X**]

Options

Large capacity memory cards, like those usually used for video recording, can contain a very large number of photos. As a reference, the number of photos that can be recorded on a 1 GB memory card is 455 for [**4:3** 2016x1512] and 670 for [**16:9** 1920x1080].

NOTES

- The actual number of photos that can be recorded will vary depending on the subject and shooting conditions.
- The camcorder retains the last setting used even if you set the camcorder to **AUTO** mode.
- When printing photos, use the following guidelines as a reference for selecting the print size.
 - [**4:3** 2016x1512]: To print photos up to A4 size (21 x 29.7 cm, 8.3 x 11.7 in.).
 - [**16:9** 1920x1080]: To print photos with a 16:9 aspect ratio. (Wide-sized photo paper is required).

Slideshow

You can play a slideshow of all the photos and even set it to music.

Operating modes: **AUTO**  |  

- 1 Open the [Photos] index screen.
- 2 Select the background music to use when playing back the photo slideshow ( 82).





Slideshow set to a music track

- 3 Touch the screen to display the playback controls, then touch **[▶]** to play back the slideshow set to the selected music track.
Touch **[■]** to stop the slideshow. Hide the playback controls if necessary.

Slideshow not linked to the external audio









- 3 Touch the screen to display the playback controls, then touch **[▶]** to start the slideshow.
- 4 Start the music playback on the external player.
 - Drag your finger left and right along the volume bar to adjust the volume.
 - Touch **[■]** to stop the slideshow. Hide the playback controls if necessary.

To change the slideshow's transition effects

 [MENU] ➤  ➤ [Slideshow Transition] ➤
[OFF Off],  Dissolve] or [ Slide Image] ➤ [X]

You can also use the following functions...

The following functions and features of the camcorder can be used either for shooting video or for taking photos. The way to set and use them was already explained in detail, so we refer you to the relevant page in the “Video” section.

- Zoom ( 47)
- Quick Start ( 49)
- Recording programs ( 61, 63)
- Face detection ( 66)
- Digital effects ( 69)
- Manual exposure adjustment ( 70)
- White balance ( 73)
- Self timer ( 74)



External Connections

This chapter explains how to connect your camcorder to an external device such as a TV, VCR, or computer.

Terminals on the Camcorder

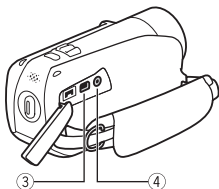
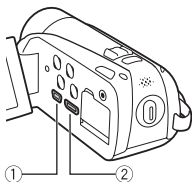

USB

① USB Terminal

Access: Open the LCD panel.



HDMI OUT

② HDMI OUT Terminal*

Access: Open the LCD panel.

The HDMI OUT terminal offers a high-quality digital connection that combines audio and video in a single convenient cable.



COMPONENT
OUT

③ COMPONENT OUT Terminal*

Access: Open the side terminal cover.

The component video terminal is for video only. When you use connection ② do not forget the audio connections using the AV OUT/🔊 terminal.



AV OUT

④ AV OUT/🔊 Terminal

Access: Open the side terminal cover.

Sound from the built-in speaker will be muted while the STV-250N Stereo Video Cable is connected to the camcorder. Adjust the volume on the connected TV.

* When connecting a cable to the camcorder, make sure to align the cable so the triangle mark on the connector is facing up.

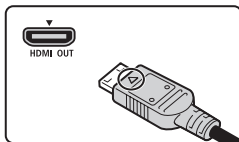
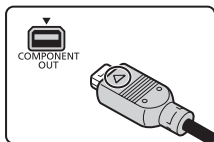

Connection Diagrams

In the following connection diagrams, the left side shows the terminals on the camcorder and the right side shows (for reference only) an example of terminals on a connected device.

Connection 1

HDMI

Type: Digital • Quality: High definition • Output only

Connect to a high-definition TV (HDTV) with an HDMI input terminal.



About the HDMI™ connection

The HDMI (High-Definition Multimedia Interface) connection (1) is a convenient all-digital connection using a single cable for both video and audio. When you connect the camcorder to an HDTV equipped with an HDMI terminal, you can enjoy video and audio playback at the highest quality.

- The HDMI OUT terminal on the camcorder is for output only. Do not connect it to an HDMI output terminal on an external device, as this may damage the camcorder.
- While the camcorder is connected to an HDTV using connection 1, there will be no video output from other terminals.
- Correct operation cannot be guaranteed when connecting the camcorder to DVI monitors.
- Depending on the HDTV, correct playback of personal video content may not be possible using connection 1. Try one of the other connections.
- Refer to *Appendix: Menu Options Lists* (132) for details on the functions that are compatible with HDMI: [x.v.Color], [Control for HDMI], [HDMI 1080p Output] and [HDMI status].

Type: Analog • Quality: High Definition • Output only

Connect to a high-definition TV (HDTV) with component video input terminals. Change

the camcorder settings to [AV/Headphones] to [AV AV]

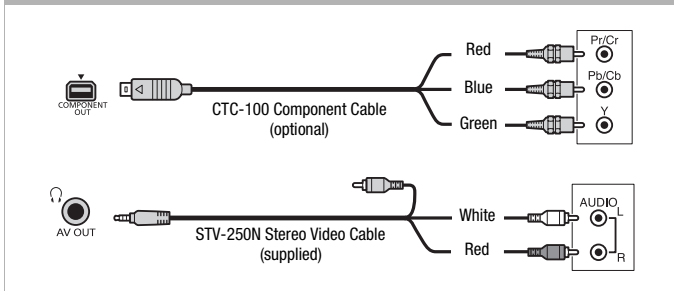

Type: Analog • Quality: Standard definition • Output only

Connect to a standard TV or a VCR with audio/video input terminals. Change the following settings on the camcorder:

- Press [TV Type] according to the TV set (widescreen or 4:3), if the TV cannot automatically detect and change the aspect ratio
- Change the camcorder settings to [AV/Headphones] to [AV AV]

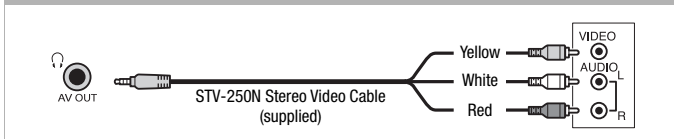

Type: Digital data connection

Connect to a computer to save your recordings.

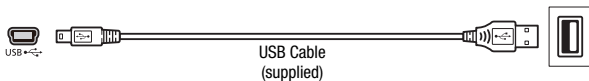
**i** NOTES

- Power the camcorder using the compact power adapter and only then connect it to the computer using the supplied USB cable in the following cases.
 - To write back scenes recorded with this camcorder that were previously saved on a computer.
 - To transfer music files from the supplied Camcorder Supplemental Disc in order to use them as background music.

Playback on a TV Screen

Connect the camcorder to a TV to enjoy your recordings with family and friends. Playback on an HDTV using one of the high-definition connections will ensure the best playback quality.

Operating modes: **AUTO**  |  

1 Turn off the camcorder and the TV.**2 Connect the camcorder to the TV.**

Refer to *Connection Diagrams* (📖 112) and select the most appropriate connection for your TV.

3 Turn on the connected TV.

On the TV, select as the video input the same terminal to which you connected the camcorder. Refer to the instruction manual of the connected TV.

4 Turn on the camcorder and set it to  or  mode.

Play back the movies or photos.

NOTES

- To correctly play back movies recorded with x.v.Color (📖 140) on an HDTV compatible with this standard, additional settings may be required on the connected HDTV. Refer to the TV's instruction manual.
- We recommend powering the camcorder using the compact power adapter.
- Connection : When you play back your 16:9 movies on standard TV sets with a 4:3 aspect ratio, the TV set will switch automatically to wide-screen mode if it is compatible with the Video ID-1 system. Otherwise, change the aspect ratio of the TV manually.

Saving and Sharing Your Recordings

Copying Recordings to a Memory Card

You can copy your recordings to a memory card but only to memory card **B**. For **HFR21/HFR20**, the recordings to be copied must be in the built-in memory or on memory card **A**. For **HFR200**, the recordings must be on memory card **A**.

From the date index screen, you can choose to copy all the scenes recorded on a particular date, individual scenes or all the scenes. From the gallery, you can choose to copy all the scenes in a story.

Please read the IMPORTANT section (📖 118) before using an Eye-Fi card.



POINTS TO CHECK



- Make sure the memory card to which you want to copy recordings is inserted into memory card slot **B**.

Copying Scenes from the Date Index Screen

When viewing the gallery on memory card **B**, copied scenes will be in [Unsorted] regardless of which story the original scenes are in.

Operating modes: **AUTO**  |  

1 Open the index page in the date index screen that contains the scenes you want to copy.

- After pressing [], select the  tab to copy scenes from the built-in memory (**HFR21/HFR20** only) or the **A** tab to copy scenes from memory card **A**.
- To copy all the scenes recorded on a specific date, select the index page that contains scenes from that date.

2 Touch the scenes to copy.



[Edit] ➤ [Copy ( ➤ **B**)] (**HFR21/HFR20** only) or [Copy (**A** ➤ **B**)] ➤ Desired option

If you selected [Select], touch the scenes to copy and then touch [OK]. A checkmark ✓ will appear on selected scenes. Touch a selected scene again to remove the checkmark. You can also touch [Remove All] to remove all checkmarks.

3 Touch [Yes] ➤ [OK].

Touch [Stop] to interrupt the operation while it is in progress.

Copying Scenes by Rating from the Gallery

1 From the gallery, select the story that contains the scenes to copy.

Drag your finger right/left to bring the desired story to the front.

2 Copy the scenes.

 [Story Details] ➤ [Play by Rating] ➤ Desired rating marker corresponding to the rating of the scenes to copy ➤ [↩] ➤ [Edit Story] ➤ [Copy (📷 ➤ B)] (HFR21/HFR20 only) or [Copy (A ➤ B)] ➤ [Yes]* ➤ [OK] ➤ [↩]

* Touch [Stop] to interrupt the operation while it is in progress.

Copying a Single Photo

Operating modes:   |  

1 In single photo view, select the photo you want to copy.

Check that you are viewing photos recorded in the built-in memory (HFR21/HFR20 only) or on memory card **A**.

2 Touch the screen to display the playback controls.

3 Copy the photo.

 [Edit] ➤ [Copy (📷 ➤ B)] (HFR21/HFR20 only) or [Copy (A ➤ B)] ➤ [📷 Proceed] ➤ [Yes]



4 Drag your finger left/right to select another photo to copy or touch [X].

Copying Photos from the Index Screen





From the index screen, you can copy selected photos or all photos.

Operating modes:   |  

1 Open the photo index screen.

After pressing [], select the  tab to copy photos from the built-in memory (**HFR21/HFR20** only) or the  tab to copy photos from memory card **A**.

2 Select the photos to copy.

 [Edit] ➤ [Copy ( ➤ )] (**HFR21/HFR20** only) or [Copy ( ➤ )] ➤ Desired option

If you selected [Select], touch the photos to copy and then touch [OK]. A checkmark ✓ will appear on selected photos. Touch a selected photo again to remove the checkmark. You can also touch [Remove All] to remove all checkmarks.

3 Touch [Yes] ➤ [OK].

Touch [Stop] to interrupt the operation while it is in progress.

Options

[Select] Copies all photos that you select.

[All Photos] Copies all photos.

! IMPORTANT

- Observe the following precautions while the ACCESS indicator is on or flashing. Failing to do so may result in permanent data loss.
 - Do not open the double memory card slot cover.
 - Do not disconnect the power source or turn off the camcorder.
 - Do not change the camcorder's operating mode.
- When copying photos onto an Eye-Fi card in memory card slot **B**, photos will be uploaded automatically when the camcorder is in playback mode if you are within the range of a configured network. Always verify that Eye-Fi cards have been approved in the country/region of use. See also *Using an Eye-Fi card* ( 131).

NOTES

- In the following cases, you will not be able to copy recordings to the memory card:
 - If the double memory card slot cover is open.
 - If the LOCK switch on memory card **B** is set to prevent writing.
 - If there is no memory card in memory card slot **B**.
- Scenes that were edited using the supplied PIXELA's **VideoBrowser** and were then written back to the camcorder cannot be copied to the memory card.
- If there is not enough space on memory card **B**, scenes cannot be copied. Photos will be copied until space on the memory card runs out.

Saving Recordings on a Computer

Movies recorded with this camcorder are saved in the built-in memory (**HFR21/HFR20** only) or on the memory cards. Because space is limited, make sure to save your recordings on a computer on a regular basis. Carefully read the information in *SDXC Memory Cards* ( 37) before performing the procedure using recordings made on an SDXC memory card.

Saving Movies

With the supplied PIXELA's **Transfer Utility** or **VideoBrowser** you can save scenes to a computer running Windows operating system*. If necessary, video files previously saved on a computer can be restored back to the camcorder. **VideoBrowser** also offers many options for organizing your video library, editing video and more.

* See the Software Guide (PDF file) of the supplied software for system requirements and other information.

Installation

Install the supplied software before you connect the camcorder to the computer for the first time. See the Installation Guide for PIXELA's software.

Using the software

Refer to the Software Guide (PDF file) of the supplied software.

Connecting the Camcorder to a Computer

1 Power the camcorder using the compact power adapter.

If the camcorder is connected to the computer while it is powered only by the battery pack, previously saved video files cannot be transferred back to the camcorder and music files cannot be transferred from the supplied Camcorder Supplemental Disc to a memory card in the camcorder.

2 Open the date index screen or gallery screen.



3 Connect the camcorder to the computer using the supplied USB cable.

Connection . Refer to *Connection Diagrams* ( 112).

4 Camcorder: Select the memory that contains the scenes you want to save.

Camcorder: When the connection is successfully established, [USB Connection] appears on the screen.

5 Computer: Depending on the software you chose to install, Transfer Utility or VideoBrowser will start up automatically.

- **Transfer Utility:** Click [Video file import] to start transferring files. For details about using the software, click [Help] to open the Software Guide (PDF file).
- **VideoBrowser:** Click  in the menu panel to start transferring files. For details about using the software, click  to open the Software Guide (PDF file).

Saving Photos

With the supplied software **Photo Application** you can save photos to your computer, and easily organize and edit them.

Installation

Install the software before you connect the camcorder to the computer for the first time. See also the relevant sections in the 'Photo Application' Instruction Manual ( PDF file) in the [MANUALS_ENGLISH] folder on the supplied Camcorder Supplemental Disc.

- 1 Install the supplied Photo Application software following the instructions in the software's instruction manual.

PHOTO > Refer to *Installing Photo Application*.

- 2 Start the software and follow the onscreen instructions.

PHOTO > Refer to *Starting CameraWindow*.

Using the software

- 1 Power the camcorder using the compact power adapter.
- 2 Set the camcorder to  mode, in single photo view.
- 3 Connect the camcorder to the computer using the supplied USB cable.

Connection  4. Refer to *Connection Diagrams* ( 112).

- 4 Save the photos onto the computer.

PHOTO > Refer to *Downloading Still Images to the Computer*.





IMPORTANT

- **When the camcorder is connected to a computer:**
 - Do not open the double memory card slot cover and do not remove the memory cards.
 - Do not access, change or delete any of the camcorder's folders or files directly from the computer as this may result in permanent data loss. Always save your movies on the computer, and restore files to the camcorder, using only the supplied PIXELA's software.
- Observe the following precautions while the ACCESS indicator is on or flashing. Failing to do so may result in permanent data loss.
 - Do not open the double memory card slot cover.
 - Do not disconnect the USB cable.
 - Do not turn off the camcorder or the computer.
 - Do not change the camcorder's operating mode.
- When restoring to the camcorder video files that were previously saved to the computer, do not disconnect the USB cable or turn off the camcorder or computer. Doing so may result in scenes that cannot be played back on the camcorder.
- Operation may not work correctly depending on the software and the specifications/settings of your computer.

- If you wish to use the image files on your computer, make copies of them first. Use the copied files, retaining the originals.

NOTES

- Refer also to the computer's instruction manual.
- **Users of Windows 7, Windows Vista, Windows XP and Mac OS X:** Your camcorder is equipped with the standard Picture Transfer Protocol (PTP) allowing you to transfer photos (JPEG only) simply by connecting the camcorder to a computer using the supplied USB cable, without having to install the supplied software **Photo Application**.
- If you connect the camcorder to the computer while it is set to  mode, the process of creating scene thumbnails will start automatically. If your intention was to save photos to the computer, you can touch [Skip] to stop the process and use the computer's Safely Remove Hardware function (Windows) or Eject function (Mac OS) to end the connection to the camcorder. Disconnect the USB cable, set the camcorder to  mode and restore the connection.
- You can select multiple stories when saving movies. When the story is saved to the computer, all of the scenes in a single story will be joined into one movie.

Saving Movies onto Standard-Definition Discs (DVD)

You can use the supplied PIXELA's **VideoBrowser** to save your movies onto standard DVDs (DVD-Video standard). These are ideal for sharing your videos with family and friends since, unlike AVCHD or Blu-ray discs, standard DVDs can be played back on most DVD players and computers' DVD drives. Your computer must be equipped with a DVD burner to create a standard DVD. Install the supplied software before performing this procedure.

If you are using a commercially available DVD recorder or similar device to create standard-definition discs, you will need to copy your recordings to the device ( 123).

Installation

See the Installation Guide for PIXELA's software.

Using the software

See 'PIXELA's VideoBrowser Software Guide' (PDF file).

Operating modes:   |  

Copying Recordings to an External Video Recorder



Operating modes:   |  

In High Definition

Connect the camcorder to Blu-ray Disc recorders and other AVCHD-compatible digital video recorders using the supplied USB cable to make perfect copies of your movies in high definition. If the external digital video recorder has an SD memory card slot*, you can use the memory card to copy your movies without connecting the camcorder.

* Make sure the external device is compatible with the type of memory card used.

Connecting

- 1 Power the camcorder using the compact power adapter.
- 2 Open the date index screen or gallery screen.
- 3 Connect the camcorder to the digital video recorder using the supplied USB cable.
Connection  4. Refer to *Connection Diagrams* ( 112).
- 4 **Camcorder:** Select the memory that contains the scenes you want to copy.
 - Select an option other than [All (for PC only)].
 - Camcorder: When the connection is successfully established, [USB Connection] appears on the screen.

Recording

Details will vary depending on the device used so be sure to refer to the instruction manual of the digital video recorder.



In Standard Definition

You can copy your movies by connecting the camcorder to a VCR or a digital video recorder with analog audio/video inputs. Video output will be in standard definition, although the original scenes are in high definition.

Connecting

Connect the camcorder to the VCR using Connection 3. Refer to *Connection Diagrams* (112).

Recording

- 1 External device: Load a blank media and set the device to record pause mode.**
- 2 Turn on the camcorder and set it to  mode.**
 - We recommend powering the camcorder using the compact power adapter.
 - Verify that   [AV/Headphones] is set to [**AV** AV].
- 3 Camcorder: Locate the scene you wish to copy and pause the playback shortly just before the desired scene.**
- 4 Camcorder: Resume playback.**

By default, onscreen displays will be embedded in the output video signal. You can change the displays by repeatedly pressing .
- 5 External recorder: Start recording when the scene you wish to copy appears; stop recording when it ends.**
- 6 Camcorder: Stop playback.**

Uploading Movies to Video Sharing Web Sites

You can convert your high-definition video recordings into standard definition in order to upload them to your favorite video sharing Web site.

HFR21/HFR20 You can complete the conversion to standard definition in the camcorder and then use the supplied PIXELA's software to upload your videos to the Web. You can even decorate scenes before or during conversion. If you are using an Eye-Fi card, after converting your video recordings into standard definition scenes you can upload your movies wirelessly, directly from the camcorder. Refer to Eye-Fi's home-page for the latest information on compatible Web sites.

Installation

See the Installation Guide for PIXELA's software.



Using the software

Refer to the Software Guide (PDF file) of the supplied software.

Operating modes:   |  

HFR21/HFR20 Converting Scenes into Standard Definition from the Date Index Screen

You can convert scenes on a specific date, scenes you select, or all scenes. You can check converted scenes using the [**SD** SD Movies] index screen ( 54).

- 1 Power the camcorder using the compact power adapter.
- 2 Make sure there is a memory card in slot **B** with sufficient available space.
- 3 Open the date index screen.
 - After pressing [], select the  tab to convert scenes from the built-in memory or the  tab to convert scenes from memory card **A**.

- To convert all the scenes recorded on a specific date, select the index page that contains scenes from that date.
- From this index page, you can proceed to step 4 or press **WEB** and skip to step 6.



4 Touch **[Edit]** and then **[Convert HD→SD]**.

5 Touch the desired option.

- If you selected **[Select]**, touch the scenes to convert and then touch **[OK]**. A checkmark ✓ will appear on selected scenes. Touch a selected scene again to remove the checkmark. You can also touch **[Remove All]** to remove all checkmarks.
- If a copyright notice appears, read it carefully and touch **[OK]** if you agree.

6 Touch **[Next]** ➤ **[START]**.

- Before touching **[Next]**, you can touch **[👉]** to change the conversion settings as described below.
- Before touching **[START]**, you can add decorations or adjust the audio balance. Touch **[👉🎨]** to decorate the scene (📖 97) or **[👉🎵]** to adjust the audio balance (📖 52).
- Touch **[STOP]** to interrupt the operation while it is in progress.

7 When the conversion is completed, a confirmation screen will appear.

Connect the camcorder to the computer at this point (📖 129) to continue uploading the converted videos to the Web or touch **[End Without Connecting]** to connect to the computer later.

Options

- [Date]** Converts all scenes recorded on the date displayed on the control button.
- [Select]** Converts all scenes that you select.
- [All Scenes]** Converts all scenes.

To select the bit rate

Using a higher bit rate will result in better video quality for the converted scenes, while a lower bit rate will result in smaller file sizes and faster uploads.



To automatically divide the scene

If you are converting a long scene, you can have the camcorder divide it into 10-minute scenes, which can make uploading easier.



HFR21/HFR20 Converting Scenes into Standard Definition from the Gallery Screen

You can convert scenes based on their rating to standard definition. You can check converted scenes using the [^{SD} SD Movies] index screen (📖 54).

- 1 Power the camcorder using the compact power adapter.
- 2 Make sure there is a memory card in slot **B** with sufficient available space.
- 3 From the gallery screen, select the story that contains the scenes to convert.
Drag your finger right/left to bring the desired story to the front.
- 4 Touch [Story Details].
- 5 Touch [Play by Rating].
- 6 Select the rating mark that corresponds to the rating of the scenes to convert.
Select [All] to convert all the scenes in the story.
- 7 Touch [Next].

8 Convert the scenes.



[Edit] ➤ [Convert HD ➔ SD (📺 ➔ B)] or [Convert HD ➔ SD (A ➔ B)]

- Alternatively, you can press **WEB**.
- If a copyright notice appears, read it carefully and touch [OK] if you agree.

9 Follow the procedure starting from step 6 from *Converting Scenes into Standard Definition from the Date Index Screen* (📖 126).

i NOTES



• **When converting scenes in a story:**

- All the scenes are merged into one converted scene.
- If the converted scene is too large, it will be split into smaller 10-minute long scenes.
- The scenes cannot be converted when their total playback time exceeds 2 hours and 30 minutes.
- If you select a music track before conversion (📖 138), the background music will be included in the converted scene. You can even adjust the balance between the audio levels of the original sound and the background music.
- The time required to convert scenes is approximately equal to the total playback time of the converted scenes. In most cases this is still faster than converting the scenes in the computer so we recommend you convert scenes in the camcorder.
- If you selected [End Without Connecting] in step 7 from *Converting Scenes into Standard Definition from the Date Index Screen* (📖 126), make sure you switch to a date index screen before connecting the camcorder to a computer. See 'PIXELA's VideoBrowser Software Guide' (PDF file) for details.

- 1 **Power the camcorder using the compact power adapter.**
- 2 **Make sure there is a memory card in slot **B** with sufficient available space.**
- 3 **Play back the scene or story that you want to partially convert.**
Check that you have selected a scene recorded in the built-in memory or on memory card **A**.
- 4 **Pause the playback where you want the converted SD movie to begin.**
- 5 **Press **WEB** and continue the conversion to standard definition from step 6 in *Converting Scenes into Standard Definition from the Date Index Screen* (📖 126).**
The video from the playback pause until the end of the scene/story (or up to a maximum of 10 minutes, in case of longer scenes/stories) will be converted to standard definition.

Connecting to the Computer and Uploading your Videos

If you are connecting the camcorder to the computer immediately after the conversion described in the previous section, start this procedure from step 3 below. Otherwise, start this procedure from the beginning.

- 1 **Power the camcorder using the compact power adapter.**
- 2 **Connect the camcorder to the computer using the supplied USB cable.**
 - Connection **4**. Refer to *Connection Diagrams* (📖 112).
 - **HFR200** Use PIXELA's software to convert your scenes before uploading them.
- 3 **Computer: Depending on the software you chose to install, Transfer Utility or VideoBrowser will start up automatically.**
 - **Transfer Utility:** Click [Web Upload] to upload your SD movies to the Web. For details about using the software, click [Help] to open the Software Guide (PDF file).
 - **VideoBrowser:** Click  in the menu panel to start transferring files. For details about using the software, click  to open the Software Guide (PDF file).

! IMPORTANT

- While the camcorder is connected to the computer, do not open the double memory card slot cover and do not remove the memory cards.
- Observe the following precautions while the ACCESS indicator is on or flashing. Failing to do so may result in permanent data loss.
 - Do not open the double memory card slot cover.
 - Do not disconnect the USB cable.
 - Do not disconnect the compact power adapter or turn off the camcorder or the computer.

HFR21/HFR20 Uploading your Videos Wirelessly

If you are using an Eye-Fi card, you can automatically upload the movies from the [**SD** SD Movies] index screen to your favorite video sharing Web site. You will need to have installed the software supplied with your Eye-Fi card and completed all the required configuration setup in advance. Refer to the instruction manual of the Eye-Fi card.

Please read the IMPORTANT section (📖 131) before using an Eye-Fi card.



- 1 Insert your Eye-Fi card into memory card slot **B** and make sure there is sufficient available space on the memory card.**
- 2 Convert the desired movies (📖 125).**
 - When the conversion is completed, touch [End Without Connecting].
 - If you are within the range of a configured network, Web upload will start automatically.
 - The status of the wireless communication is shown by the Eye-Fi icon as follows:
 - 📶 (grayed out) Communication not established
 - 📶 (white, flashing) Connecting; 📶 (white, continuously on) Wireless upload on standby
 - 📶 (animated) Wireless upload in progress
 - 📶 [Eye-Fi Communication] is set to [**OFF** Off]
 - 📶 Wireless upload stopped by the camcorder (📖 157)
 - 📶 Error reading from the Eye-Fi card (📖 156)

IMPORTANT

Using an Eye-Fi Card

- This product is not guaranteed to support Eye-Fi card functions (including wireless transfer). In case of an issue with an Eye-Fi card, please check with the card manufacturer. Also note that an approval is required to use Eye-Fi cards in many countries or regions. Without approval, use of the card is not permitted. If it is unclear whether the card has been approved for use in the area, please check with the card manufacturer.
- Do not use Eye-Fi cards on airplanes and in other places where wireless communication is forbidden. Remove the Eye-Fi card from the camcorder beforehand.

NOTES

- Depending on the amount of data to be uploaded and the network's wireless connection conditions, it can take some time to upload video files. If the wireless connection is too weak, the wireless upload may fail and the video files will be registered as incomplete uploads.
- **About power saving:**
 - Wireless communication drains the power of the battery pack faster than usual. We recommend powering the camcorder using the compact power adapter.
 - While files are being uploaded wirelessly, the camcorder's automatic power off function will be disabled.
- The Eye-Fi card cannot wirelessly communicate with the network in the following cases. Furthermore, wireless communication will end automatically in the following cases:
 - When the camcorder is set to **AUTO** or  mode.
 - When the optional WM-V1 Wireless Microphone is attached.
- If the LOCK switch on the Eye-Fi card is set to prevent writing, you will not be able to turn the wireless communication on/off and the status icon will change to . To use wireless communication make sure the switch on the Eye-Fi card is not in the LOCK position.
- While using an Eye-Fi Card, the ACCESS indicator may flash from time to time.
- Wirelessly uploading files is not possible when the Eye-Fi card is in memory card slot **A** (the Eye-Fi icon will not appear on the screen). Be sure to insert the Eye-Fi card into memory card slot **B**.



Additional Information

This chapter contains troubleshooting advice, screen messages, handling and maintenance tips, and other information.













Appendix: Menu Options Lists

Menu items not available appear grayed out. For details about how to select an item, refer to *Using the Menus* (book 32). For details about each function, see the reference page. Menu options without a reference page are explained after the tables. Underlined menu options indicate default values.

FUNC. Panel



FUNC. Panel - Recording Modes

Control Button	Setting options/Function	AUTO		
[MENU]	Open the menus	–	●	33
[Rec. Programs]	<u>[P Programmed AE]</u>	–	●	61
	[Cine Mode]	–	●	63
	[Portrait], [Sports], [Night Scene], [Snow], [Beach], [Sunset], [Low Light], [Spotlight], [Fireworks]	–	●	61
[Decoration]*	[Pens and Stamps], [Animated Stamps], [Date and Time], [image mix], [freeze screen], [minimize toolbar]	●	●	97
[WB White Balance]	[AWB Automatic], [Daylight], [Tungsten], [Custom WB]	–	●	73
[Focus]	MF (manual focus): toggle on or <u>off</u> , Touch AF frame	–	●	71

Control Button	Setting options/Function	AUTO		
[ Exposure]*	[M] (manual exposure): Toggle on or <u>off</u> , Touch AE frame	–	●	70
[ZOOM]	Zoom controls, [START]/[STOP] control, Tele-macro: Toggle on or <u>off</u>	●	●	47, 72
[ Mic. Level]*	[A Automatic], [M Manual] [Audio Level Indicator]: Toggle on or <u>off</u>	–	●	75
[Image Stabilizer]*	[ Dynamic], [ Standard], [ Off]	–	●	64
[ Digital Effects]	For movies: [ Off], [E1 Black & White], [E2 Sepia], [F1 Fade Trigger/Once], [F1 ↻ Fade Trigger/Always], [F2 Wipe/Once], [F2 ↻ Wipe/Always]	–	●	69
	For photos: [ Off], [E1 Black & White], [E2 Sepia]	–	●	
[ Pre REC]*	[ON On], [OFF Off]	–	●	65
[ Review Recording]*	Play back the last 4 seconds of the last movie recorded.	–	●	58











* Not available for photos.

Edit Panel - Mode

Control Button	Date Index Screen	[SD Movies] Index Screen	Playback Pause	
HFR21/HFR20 [Copy ( → B)]* [Copy (A → B)]*	<date>, [Select], [All Scenes]	–	–	116
HFR21/HFR20 [Convert HD → SD ( → B)]* [Convert HD → SD (A → B)]*	<date>, [Select], [All Scenes]	–	–	125
[Delete]	<date>, [Select], [All Scenes]	[This Scene], [All Scenes]	[This Scene]	56
[Divide]	–	–	●	96

* Not available for recordings on memory card B ( tab).





In the gallery:

Control Button	[Edit Story] in [Story Details] Screen	[Edit Scene] in [Scene List] Screen	Playback Pause	
HFR21/HFR20 [Copy ( + )] ¹ [Copy ( + )] ¹	<by scene rating>	–	–	116
HFR21/HFR20 [Convert HD → SD ( + )] ¹ [Convert HD → SD ( + )] ¹	<by scene rating>	–	–	125
[Delete] or []	<by scene rating>	[This Scene]	[This Scene]	56
[Delete Story] ²	●	–	–	56
[Move Story]	<by scene rating>	–	–	93
[Copy]	–	●	–	92
[Move]	–	●	–	92
[Divide]	–	–	●	96
[Rating]	–	[★★★★], [★★★•], [★★••], [★•••], [••••] (unrated), [----]		87

¹ Not available for recordings on memory card B ( tab).







² Not available for [Unsorted] or [Video Snapshot].

Edit Panel - Mode

Control Button	Photo Index Screen	Single Photo View	
HFR21/HFR20 [Copy ( + )] [Copy ( + )]	[Select], [All Photos]	●	117
[Delete]	[Select], [All Photos]	●	105

Setup Menus

Camera Setup

Menu item	Setting options	
[Zoom Type]	[Optical], [Advanced], [Digital]*	47
[Zoom Speed]	[VAR Variable], [>>> Speed 3], [>> Speed 2], [> Speed 1]	47
[Focus Assistance]*	[ON On], [OFF Off]	–
[Face Detection & Tracking]	[ON On ], [OFF Off]	66
[Auto Backlight Correction]*	[ON On], [OFF Off]	71
[Auto Slow Shutter]*	[ON On], [OFF Off]	–
[Flicker Reduction]*	[OFF Off], [50Hz 50 Hz], [60Hz 60 Hz]	–
[Fader Setting]*	[BLACK] Black Screen, [WHITE] White Screen]	–
[Onscreen Markers]	[OFF Off], [ Level (White)], [ Level (Gray)], [ Grid (White)], [ Grid (Gray)]	–
[Wind Screen]*	[A Automatic], [OFF Off 	–
[Microphone Attenuator]*	[A Automatic], [ON On ATT]	–
[MIC Terminal Input]*	[LINE External Audio], [MIC Microphone]	79
[Audio Mix]*	[OFF Off], [ON On] When [ON On] - audio balance bar	75

* Not available for photos.

[Focus Assistance]: When focus assistance is activated, the image at the center of the screen is magnified to help you focus manually ( 71).

- Using focus assistance will not affect the recordings. It will be cancelled automatically after 4 seconds or when you start recording.

[Auto Slow Shutter]: The camcorder automatically uses slow shutter speeds to obtain brighter recordings in places with insufficient lighting.

- Minimum shutter speed used: 1/30; 1/12 when the frame rate is set to **[PF24 PF24]**; 1/15 when it is set to **[PF30 PF30]**.
- The auto slow shutter can only be activated when the recording program is set to **[P Programmed AE]**, but the setting will not change even if you set the camcorder to **[AUTO]** mode.
- If a trailing afterimage appears, set the slow shutter to **[OFF Off]**.
- If  (camcorder shake warning) appears, we recommend stabilizing the camcorder, for example, by mounting it on a tripod.

[Flicker Reduction]: If the screen starts to flicker when recording movies under fluorescent lights, change the setting to reduce the effect.

- Flicker reduction can be activated only when the recording program is set to **[P Programmed AE]**.

[Fader Setting]: You can select whether the fader fades in and out in black or white.

[Onscreen Markers]: You can display a grid or a horizontal line at the center of the screen. Use the markers as a reference to make sure your subject is framed correctly (vertically and/or horizontally).

- Using the onscreen markers will not affect the recordings.











[Wind Screen]: The camcorder automatically reduces the background sound of wind when recording outdoors.

- Some low-frequency sounds will be suppressed along with the sound of wind. When recording in surroundings unaffected by wind or if you want to record low-frequency sounds, we recommend setting the wind screen to **[OFF Off **].

[Microphone Attenuator]: Helps prevent audio distortions.

[A Automatic]: The camcorder will automatically activate the microphone attenuator as necessary for optimal audio recording levels so high audio levels will not be distorted.

[ON On ATT]: The microphone attenuator will be activated at all times to reproduce more faithfully the sound dynamics. **ATT** will appear on the screen.

Menu item	Setting options			
[Select Music]	[OFF Off], [ON On] When [ON On] - list of music tracks and [Music Balance] bar	●	●	82
[External Audio Input]	[OFF Off], [ON On ] When [ON On] - [External Player Link]: Toggle on (●) or off (○)	●	●	84
[Data Code]	[OFF Off], [ Date], [ Time], [ Date and Time], [ Camera Data]	●	●	–
[Slideshow Transition]	[OFF Off], [ Dissolve], [ Slide Image]	–	●	109
[TV Type]*	[4:3 Normal TV], [16:9 Wide TV]	●	●	–

* Option not available when the camcorder is connected to an HDTV using the supplied HDMI cable.

[Data Code]: Displays the date and/or time when the scene was recorded.

[ Camera Data]: Displays the aperture (f-stop) and shutter speed used when recording the scene.









[TV Type]: When you connect the camcorder to a TV using the supplied STV-250N Stereo Video Cable, select the setting according to the type of TV in order to display the picture in full and in the correct aspect ratio.







[4:3 Normal TV]: TV sets with 4:3 aspect ratio.

[16:9 Wide TV]: TV sets with 16:9 aspect ratio.



- When the TV type is set to [**4:3** Normal TV], during the playback of video originally recorded with an aspect ratio of 16:9, the picture will not be displayed fullscreen.

Recording & Connections Setup

Menu item	Setting options				
[Self Timer]	[ON On ], [OFF Off]	●	–	–	74
[Video Snapshot Length]*	[2sec 2 sec], [4sec 4 sec], [8sec 8 sec]	●	●	–	68, 94
[Rate Scenes (Recording)]*	[ON On], [OFF Off]	●	–	–	87
[Rec Media for Movies]*	HFR21/HFR20  (built-in memory), [A] (memory card A), [B] (memory card B) [Relay Recording]: [OFF] (off),  → [A], [ → [A] → [B]], [[A] → [B]] HFR200 [A] (memory card A), [B] (memory card B) [Relay Recording]: [OFF] (off), [A] → [B]	●	–	–	39
[Recording Mode]*	[MPX High Quality 24 Mbps], [FXP High Quality 17 Mbps], [XP+ High Quality 12 Mbps], [SP Standard Play 7 Mbps], [LP Long Play 5 Mbps]	●	–	–	59
[Frame Rate]*	[60i 60i (Standard)], [PF30 PF30], [PF24 PF24]	●	–	–	–
[Rec Media for Photos]	HFR21/HFR20  (built-in memory), [A] (memory card A), [B] (memory card B) HFR200 [A] (memory card A), [B] (memory card B)	●	●	–	39

Menu item	Setting options				
[Photo Aspect Ratio]	[4:3 2016x1512], [16:9 1920x1080]	●	–	–	108
[Memory Info]	HFR21/HFR20  (built-in memory), [A] (memory card A), [B] (memory card B) HFR200 [A] (memory card A), [B] (memory card B)	●	●	●	–
[x.v.Color]*	[ON On color], [OFF Off]	●	–	–	–
[Photo Numbering]	 Reset], [ Continuous]	●	●	●	–

* Not available for photos.

[Memory Info]: Displays a screen where you can verify how much of the built-in memory (**HFR21/HFR20** only) or the memory card is currently in use ( total recording time and  total number of photos) and how much space remains available for recording.

- Estimated figures about available movie recording time and available number of photos are approximate and based on the recording mode and photo size settings currently in use.
- In the information screen of a memory card you can also check its Speed Class.
- **HFR21/HFR20** The [Total space] shown for the built-in memory indicates actually usable space. It may be slightly smaller than the nominal built-in memory capacity listed in the Specifications.

[x.v.Color]: Uses a color space with an extended gamut to achieve deeper colors, closer to real life.

- Use this function to record video only when you intend to play back your recordings on an HDTV compatible with x.v.Color, connected to the camcorder using the supplied HDMI cable. If recordings made with x.v.Color are played back on a non-compatible TV, colors may not be reproduced correctly.



[Photo Numbering]: Select the photo numbering method to be used on a new memory card. Photos are automatically assigned consecutive numbers from 0101 to 9900, and stored in folders containing up to 100 photos. Folders are numbered from 101 to 998.

















[ Reset]: Photo numbers will restart from 101-0101 every time you insert a new memory card.









[ Continuous]: Photo numbers will continue from the number following that of the last photo recorded with the camcorder.

- If the memory card you insert already contains a photo with a larger number, a new photo will be assigned a number one higher than that of the last photo on the memory card.
- We recommend using the [ Continuous] setting.
- The photo number indicates the name and location of the file on the memory card. For example, the file name of a photo numbered 101-0107 is “IMG_0107.JPG”, stored under the folder “DCIM\101CANON”.

System Setup

In this table,  and  refer to movies and photos in  mode, respectively.

Menu item	Setting options				
[Output Onscreen Displays]	[ON On], [OFF Off]	●	●	●	–
[Language 	[Česky], [Dansk], [Deutsch], [Ελληνικά], [English], [Español], [Français], [Italiano], [Magyar], [Melayu], [Nederlands], [Norsk], [Polski], [Português], [Română], [Suomi], [Svenska], [Türkçe], [Русский], [Українська], [العربية], [فارسی], [ภาษาไทย], [简体中文], [繁體中文], [한국어], [日本語]	●	●	●	35
[LCD Brightness]	*  *	●	●	●	–
[LCD Screen Dimmer]	[ON On], [OFF Off]	●	●	●	–
[LCD Mirror Image]	[ON On], [OFF Off]	●	–	–	–
[AV/Headphones] ¹	[AV AV], [ Headphones]	●	●	●	77
[Volume] ¹	Speaker:    , 	–	●	●	52, 77
	Headphone:    , 	●	●	●	
[Notification Sounds]	[ High Volume], [ Low Volume], [OFF Off]	●	●	●	–
[Autostart Decoration] ¹	[ON On], [OFF Off]	●	–	–	97
[Power Saving Mode]	[Auto Power Off]: [OFF Off], [ON On] [Quick Start (Standby)]: [OFF Off], [10min 10 min], [20min 20 min], [30min 30 min]	●	●	●	–

Menu item	Setting options				
HFR21/HFR20 [Initialize]	[ Built-in Mem.], [A Mem. Card A], [B Mem. Card B] [Complete Initialization]: Toggle on or <u>off</u>	●	●	●	41
HFR200 [Initialize]	[A Mem. Card A], [B Mem. Card B] [Complete Initialization]: Toggle on or <u>off</u>				
[Time Zone/DST]	[] (home time zone) or [] (travel time zone): <u>[New York]</u> , list of world time zones [] (DST adjustment)	●	●	●	35
[Date/Time]	[Date/Time]: – [Date Format]: [Y.M.D], [<u>M.D.Y</u>], [D.M.Y] (Y- year, M- month, D- day) [24H]: Toggle on (24-hour clock) or <u>off</u> (12-hour clock)	●	●	●	34
[Battery Info]	–	●	●	●	–
[Control for HDMI] ²	[ON On], [OFF Off]	●	●	●	–
[HDMI 1080p Output] ²	[ON On], [OFF Off]	●	●	●	–
[HDMI Status]	–	●	●	●	–
[Distance Units]	[m meters], [ft feet]	●	–	–	–
[Demo Mode]	[ON On], [OFF Off]	●	–	–	–
[Firmware]	–	–	–	●	–
[Eye-Fi Communication] ³	[A Automatic], [OFF Off]	●	●	●	130

¹ Not available for photos.

² Option not available when the camcorder is connected to an HDTV using the supplied HDMI cable.

³ Option available only after having inserted an Eye-Fi card in memory card slot **B**.

[Output Onscreen Displays]: When set to **[ON On]**, the camcorder's onscreen displays will appear also on the screen of a TV or monitor connected to the camcorder.

[LCD Brightness]: Adjusts the brightness of the LCD screen.

- Changing the brightness of the LCD screen does not affect the brightness of your recordings or the brightness of the playback image on a TV.

[LCD Screen Dimmer]: When set to **[ON On]**, the LCD screen is dimmed. Doing so is ideal when using the camcorder in locations where the LCD's illumination could become a nuisance to others. Hold **[DISP]** pressed down for about 2 seconds to restore the LCD screen to its previous brightness setting.

- Dimming the LCD screen does not affect the brightness of your recordings or the brightness of the playback image on a TV.
- When the screen dimmer is set to **[OFF Off]**, the LCD screen will return to the brightness level that was in use before the screen was dimmed.

[LCD Mirror Image]: When set to **[ON On]**, the image on the screen is inverted horizontally when the LCD panel is rotated toward the lens.

- While this option is set to **[ON On]** and the LCD panel is rotated toward the lens, you cannot decorate the screen with **[Decorate Decoration]**.

[Notification Sounds]: A beep will accompany some operations like turning on the camcorder, the self-timer countdown, etc.

[Autostart Decoration]: When set to **[ON On]**, activates decoration mode when you rotate and stow the LCD panel.



[Power Saving Mode]: Controls the camcorder's automatic power off settings.

[Auto Power Off]: In order to save power when the camcorder is powered by a battery pack, it will automatically shut off if left without any operation for 5 minutes.



- Approximately 30 seconds before the camcorder shuts off, **[Auto Power Off]** will appear.
- In standby mode, the camcorder will shut off after the time selected for the **[Quick Start (Standby)]** setting.

[Quick Start (Standby)]: Select whether to activate the Quick Start function (49) when you close the LCD panel in a recording mode and the length of time after which the camcorder will end the standby mode and shut off automatically.

- You can set Quick Start to [**OFF** Off], for example, if the camcorder is set on a fixed position and you want to keep recording video with the LCD panel closed in order to conserve the battery's power.

[Battery Info]: Displays a screen where you can verify the battery charge (as a percentage) and the remaining recording time ( mode) or playback time (,  mode).

[Control for HDMI]: Activates the HDMI-CEC (Consumer Electronics Control) function. When you connect the camcorder to an HDTV compatible with HDMI-CEC using the supplied HDMI cable, you can control the camcorder's playback using the remote control of the TV.

- If set to [**ON** On], when the camcorder is connected to a compatible HDTV using the supplied HDMI cable, the video input on the TV will automatically be set to the camcorder's video input. Then, you can use the up/down/left/right buttons and the OK or SET button on the TV's remote control to play back your recordings.
- Depending on the TV set, additional settings may be required on the TV itself to activate the HDMI-CEC function. Refer to the TV's instruction manual.
- Correct operation of the HDMI-CEC function cannot be guaranteed even when connecting the camcorder to compatible TV sets. If you cannot use the remote control of the TV, set [Control for HDMI] to [**OFF** Off] and operate the camcorder directly.
- The remote control of the TV can only be used to play back movies or photos ( or  mode only). If the camcorder is connected to the TV while it is set to recording mode, depending on the TV used, turning off the TV will automatically turn off the camcorder even if it is recording at the time.
- We recommend not connecting more than 3 HDMI-CEC compatible devices at a time.

[HDMI 1080p Output]: When the camcorder is connected using an HDMI connection to a television that supports 1080p output, the camcorder will convert 1080i video and output it as 1080p.

[HDMI Status]: Displays a screen where you can verify the standard of the output signal from the HDMI OUT terminal.

[Distance Units]: Selects the units to use for the focusing distance display during manual focus.

[Demo Mode]: The demonstration mode displays the camcorder's main features. It starts automatically when the camcorder is powered with the compact power adapter if you leave it turned on without a memory card for more than 5 minutes.

- To cancel the demo mode once it has started, press any button or turn off the camcorder.

[Firmware]: You can verify the current version of the camcorder's firmware. This menu option is usually unavailable.

Appendix: Onscreen Icons and Displays

AUTO Recording Movies (in Smart AUTO mode)

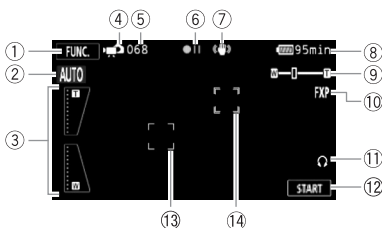

- | | |
|---|--|
| ① Control button: Open the FUNC. panel (📖 32) | ⑧ Remaining battery time (📖 151) |
| ② Smart AUTO mode (📖 43) | ⑨ Zoom (📖 47) |
| ③ Onscreen zoom controls (📖 48) | ⑩ Recording mode (📖 59) |
| ④ Operating mode (📖 30) | ⑪ Headphone output (📖 77) |
| ⑤ In record pause mode:
Total number of scenes | ⑫ Control button: Start/Stop video recording |
| ⑥ Memory operation (📖 151) | ⑬ Face detection frame (📖 66) |
| ⑦ Image stabilizer (📖 64) | ⑭ Touch & Track frame (📖 67) |

Recording Movies (in Flexible Recording mode)

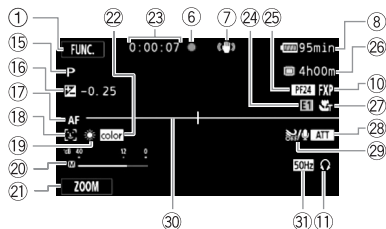

Top row of icons during record pause mode



- ⑮ Recording program (📖 61, 63)
- ⑯ Manual exposure (📖 70)
- ⑰ **AF** Autofocus, MF Manual focus (📖 71)
- ⑱ Face detection (📖 66)
- ⑲ White balance (📖 73)
- ⑳ Audio level indicator (📖 75)
- ㉑ Control button: Last function used ([ZOOM] in this case)
- ㉒ x.v.Color (📖 140)
- ㉓ While recording/during playback: Scene counter (hours : minutes : seconds)
- ㉔ Digital effect (📖 69)
- ㉕ PF24 progressive frame rate (📖 60)
- ㉖ Remaining recording time
 A, **B** On memory card **A** or **B**
 In the built-in memory*
* , Relay recording (📖 40)
 * **HFR21/HFR20** only.
- ㉗ Tele-macro (📖 72)
- ㉘ Microphone attenuator (📖 137)
- ㉙ Wind screen off (📖 137)
- ㉚ Level marker (📖 137)
- ㉛ Flicker reduction (📖 137)
- ㉜ Pre-recording (📖 65)

Recording Photos (in Flexible Recording mode)

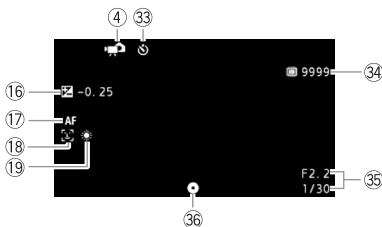

33 Self timer ( 74)

34 Number of available photos

 ,  On memory card  or 

   In the built-in memory

35 Displays the aperture (f-stop) and shutter speed used.

36 Focus and exposure lock ( 43, 107)

Playing Movies (during playback)

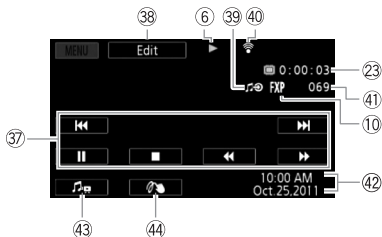

37 Playback control buttons ( 50)

38 Control button: Open the Edit panel ( 135)

39 External audio input ( 84)

40 Eye-Fi wireless communication ( 130)

41 Scene number

42 Data code ( 87, 138)

43 Volume and music balance ( 50)

44 Decoration ( 97)

Viewing Photos

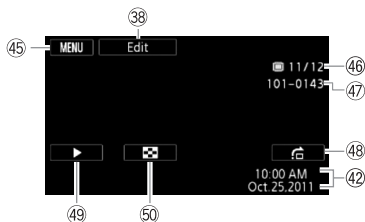

45 Control button: Open the setup menus (📖 136)

46 Current photo / Total number of photos

47 Photo number (📖 141)

48 Photo jump (📖 104)

49 Slideshow (📖 109)



50 Switch to [Photos] index screen (📖 103)

⑥ Memory operation

- Record, ●|| Record pause, ► Playback, || Playback pause, ►► Fast playback, ◀◀ Fast reverse playback, ► Slow playback, ◀ Slow reverse playback, ||► Frame advance*, ◀|| Frame reverse*.

* Available only when dividing scenes.

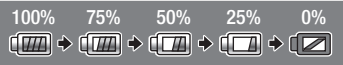

⑦ Remaining battery time

- The icon shows a rough estimate of the remaining charge as a percentage of the full charge of the battery pack. The remaining recording/playback time of the battery pack is displayed, in minutes, next to the icon.

- When  is displayed in red, replace the battery pack with a fully charged one.
- When you attach an empty battery pack, the power may turn off without displaying .
- Depending on the conditions under which the camcorder and the battery pack are used, the actual battery charge may not be indicated accurately.
- When the camcorder is off, press **[BATT.INFO]** to display the charge status of a battery pack. The Intelligent System will display the charge status (as a percentage) and the remaining recording time (in minutes) for 5 seconds. If the battery pack is exhausted, the battery information may not be displayed.

②⑥ Remaining recording time

When there is no more free space on the memory, [ End] (built-in memory, **HFR21**/**HFR20** only) or [**A** End] (memory card **A**) or [**B** End] (memory card **B**) will be displayed in red and the recording will stop.

③④ Number of available photos

 /  in red: There is no memory card in the corresponding memory card slot.
A / **B** in green: 6 or more photos ➔ in yellow: 1 to 5 photos ➔ in red: No more photos can be recorded.

- When viewing the photos, the display will always be in green.
- Depending on the recording conditions, the number of available photos displayed may not decrease even after a recording has been made, or may decrease by 2 photos at once.

Troubleshooting

If you have a problem with your camcorder, refer to this section. Sometimes what you think is a malfunction of the camcorder may have the simplest of solutions - please read the "CHECK THIS FIRST" box before going on to the more detailed problems and solutions. Consult your dealer or a Canon Service Center if the problem persists.

CHECK THIS FIRST

Power supply

- Is the battery charged? Is the compact power adapter correctly connected to the camcorder? (📖 21)

Recording

- Did you turn the camcorder on and correctly set it to a recording mode? (📖 43, 58, 107) If you are recording on a memory card, is one correctly inserted into the camcorder? (📖 38)

Playback

- Did you turn the camcorder on and correctly set it to playback mode? (📖 50, 103) If you are playing back recordings from a memory card, is one correctly inserted into the camcorder? (📖 38) Does it contain any recordings?

Power source

The camcorder will not turn on or it turns off by itself.

- The battery pack is exhausted. Replace or charge the battery pack.
- Remove the battery pack and reattach it correctly.

Cannot charge the battery pack.

- Make sure the camcorder is off so charging can start.
- The temperature of the battery pack is outside the charging range. If the battery pack's temperature is below approximately 0 °C (32 °F), warm it before charging it; if it is above approximately 40 °C (104 °F), let the battery pack cool down before charging it.
- Charge the battery pack in temperatures between 0 °C and 40 °C (32 °F and 104 °F).
- The battery pack is faulty. Replace the battery pack.
- The camcorder cannot communicate with the battery pack attached. Such battery packs cannot be charged using this camcorder.
- This can occur when attaching and attempting to charge a battery pack that is not recommended by Canon.
- When using a battery pack recommended by Canon, there may be a problem with the battery pack or camcorder. Consult a Canon Service Center.

A noise can be heard from the compact power adapter.

- A faint sound can be heard while the compact power adapter is connected to a power outlet. This is not a malfunction.

The battery pack is exhausted extremely quickly even at normal temperatures.

- The battery may have reached the end of its battery life. Buy a new battery pack.

Recording

Pressing START/STOP will not start recording.

- You cannot record while the camcorder is writing previous recordings onto the memory (while the ACCESS indicator is on or flashing). Wait until the camcorder has finished.
- The memory is full or it already contains the maximum number of scenes (3,999 scenes). Delete some recordings (📖 56, 105) or initialize the memory (📖 41) to free some space.

The point where START/STOP was pressed does not match the beginning/end of the recording.

- There is a slight interval between pressing START/STOP and the actual start/end of recording. This is not a malfunction.

The camcorder will not focus.

- Autofocus does not work on the subject. Focus manually (📖 71).
- The lens is dirty. Clean the lens with a soft lens-cleaning cloth (📖 170). Never use tissue paper to clean the lens.

When a subject flits across in front of the lens, the image appears slightly bent.

- This is a phenomenon typical of CMOS image sensors. When a subject crosses very quickly in front of the camcorder, the image may seem slightly warped. This is not a malfunction.

Changing the operating mode between recording (●)/record pause (●||)/playback (▶) takes longer than usual.

- When the memory contains a large number of scenes, some operations may take longer than usual. Save your recordings (📖 119) and initialize the memory (📖 41).

Movies or photos cannot be recorded properly.

- This may occur as movies and photos are recorded/deleted over time. Save your recordings (📖 119) and initialize the memory (📖 41).

After using the camcorder for a long time, it becomes hot.

- The camcorder may become hot after using it continuously for long periods of time; this is not a malfunction. If the camcorder becomes unusually hot or it becomes hot after using it only for a short while, it may indicate a problem with the camcorder. Consult a Canon Service Center.

Playback

Cannot create a story.

- A memory can contain a maximum of 98 stories (not including [Unsorted] and [Video Snapshot]). Delete some stories (📖 90) or select a different memory that contains less than 98 stories.

Cannot add scenes to a story.

- In most cases, a story can contain a maximum of 999 scenes. If a story includes scenes recorded in MXP or FXP mode, the maximum number of scenes may be less than 999 (the maximum number of scenes).
- You may not be able to add scenes recorded or edited using another device.
- The memory is full. Delete some recordings (📖 56, 105) or initialize the memory (📖 41) to free some space.
- You may not be able to add scenes to a story even if the number of scenes is less than 999.

Cannot move scenes in the gallery.

- The memory is full. Delete some recordings (📖 56, 105) to free some space.

Cannot delete a scene.

- You may not be able to delete scenes recorded or edited using another device.

Deleting scenes takes longer than usual.

- When the memory contains a large number of scenes, some operations may take longer than usual. Save your recordings (📖 119) and initialize the memory (📖 41).

Cannot capture a video snapshot scene from a movie.

- You cannot capture video snapshot scenes from scenes recorded or edited using another device.
- The memory is full. Delete some recordings (📖 56, 105) to free some space.

When playing back scenes/slideshow with background music, the music track is not played back correctly.

- This can occur when you transfer the music files to a memory after repeatedly recording and deleting scenes (fragmented memory). Save your recordings (📖 119) and initialize the memory (📖 41). Then, transfer the music files first and only then write the video files back to the memory.
- Music tracks will not play back correctly if the connection was interrupted while transferring the music files. Delete the music tracks and transfer the music files again.
- The transfer rate of the memory card used is too slow. Use a recommended memory card (📖 36).

When playing scenes/a slideshow linked to external audio, the video playback is not correctly linked to the external player.

- The volume of external player may be too low. Try increasing the volume of the external player.

Cannot divide scenes

- You cannot divide scenes recorded or edited using another device.
- The memory is full. Delete some recordings ( 56, 105) to free some space.

Cannot copy scenes/photos

- You may not be able to copy scenes/photos recorded or edited using another device.

Cannot mark individual scenes/photos in the index screen with a checkmark ✓

- You cannot select more than 100 scenes/photos individually. Reduce the number of selected scenes/photos or use the [All Scenes] or [All Photos] option.

Indicators and Onscreen Displays

lights up in red.

- Battery pack is exhausted. Replace or charge the battery pack.

appears on the screen.

- The camcorder cannot communicate with the battery pack attached so the remaining battery time cannot be displayed.

/ lights up in red.

- A memory card error occurred. Turn off the camcorder. Remove and reinsert the memory card. Initialize the memory card if the display does not change back to normal.
- The memory card is full. Replace the memory card or delete some recordings ( 56, 105) to free some space on the memory card.

Even after stopping recording, the ACCESS indicator does not go off.

- The scene is being recorded in the memory. This is not a malfunction.

The red ON/OFF (CHG) indicator flashes rapidly () one flash at 0.5-second intervals).

- Charging has stopped because the compact power adapter or the battery pack is faulty. Consult a Canon Service Center.

The red ON/OFF (CHG) indicator flashes very slowly () one flash at 2-second intervals).

- The temperature of the battery pack is outside the charging range. If the battery pack's temperature is below approximately 0 °C (32 °F), warm it before charging it; if it is above approximately 40 °C (104 °F), let the battery pack cool down before charging it.
- Charge the battery pack in temperatures between 0 °C and 40 °C (32 °F and 104 °F).
- The battery pack is damaged. Use a different battery pack.

appears on the screen

- The LOCK switch on the Eye-Fi card is set to prevent accidental erasure. Change the position of the LOCK switch.
- An error occurred when trying to access control data on the Eye-Fi card. Turn the camcorder off then on again. If the icon appears often, there might be a problem with the Eye-Fi card. Contact the card manufacturer's customer care.

Picture and Sound

The screen appears too dark.

- The LCD screen was dimmed. Hold  pressed down for 2 seconds to restore the LCD screen to its previous brightness setting.

Screen displays turn on and off repeatedly.

- The battery pack is exhausted. Replace or charge the battery pack.
- Remove the battery pack and reattach it correctly.

Abnormal characters appear on the screen and the camcorder does not operate properly.

- Disconnect the power source and reconnect it after a short time. If the problem still persists, disconnect the power source and press the RESET button to reset all the camcorder's settings to default values.



Video noise appears on screen.

- Keep a distance between the camcorder and devices that emit strong electromagnetic fields (plasma TVs, cellular phones, etc.).

Horizontal bands appear on the screen.

- This is a phenomenon typical of CMOS image sensors when recording under some types of fluorescent, mercury or sodium lamps. This is not a malfunction. To reduce the symptoms, change the  [Flicker Reduction] setting.

Sound is distorted or is recorded at lower levels.

- When recording near loud sounds (such as fireworks, shows or concerts), sound may become distorted or it may not be recorded at the actual levels. Activate the microphone attenuator ( 137) or adjust the audio recording level manually ( 75).

The picture is displayed correctly but there is no sound from the built-in speaker.



- Speaker volume is turned off. Adjust the volume.
- If the STV-250N Stereo Video Cable is connected to the camcorder, disconnect it.
- The AV terminal is set to headphone output. Set  [AV/Headphones] to [AV].

Memory Card and Accessories



Cannot insert the memory card.

- The memory card was not facing the correct direction. Turn the memory card over and insert it.

Cannot record on the memory card.

- The memory card is full. Delete some recordings (📖 56, 105) to free some space or replace the memory card.
- Initialize the memory card (📖 41) when you use it with the camcorder for the first time.
- The LOCK switch on the memory card is set to prevent accidental erasure. Change the position of the LOCK switch.
- A compatible memory card must be used to be able to record movies on a memory card (📖 36).
- The folder and file numbers have reached their maximum value. Set   [Photo Numbering] to [Reset] and insert a new memory card.

Cannot upload files wirelessly using an Eye-Fi card.

- Files cannot be uploaded wirelessly while the camcorder is in **AUTO** or  mode. Change to a playback mode.
- You may have inserted the Eye-Fi card into memory card slot **A**. Insert it into memory card slot **B**.
-   [Eye-Fi Communication] is set to [Off] (📶 appears onscreen). Set it to [Automatic].
- Opening the LCD panel may help when the wireless connection is not strong enough.
- If certain conditions occur while uploading files, such as the wireless connection getting too weak, the camcorder may stop the wireless upload (📶 appears onscreen). Move to a location with a stronger wireless signal.
- Files cannot be uploaded wirelessly while using the optional WM-V1 Wireless Microphone (📶 appears onscreen). Turn off the microphone or disconnect the microphone from the AV OUT/🔌 terminal.
- Contact the card manufacturer's customer care.

The wireless communication status icon does not appear

- You may have inserted the Eye-Fi card into memory card slot **A**. Insert it into memory card slot **B**.

There are brief stops in the sounds recorded by the optional WM-V1 Wireless Microphone.

- This may occur during recording if the LOCK switch on the Eye-Fi card is set to prevent writing, causing wireless communication to occur. Change the position of the LOCK switch.

Connections with External Devices

Video noise appears on the TV screen.

- When using the camcorder in a room where a TV is located, keep a distance between the compact power adapter and the power or antenna cables of the TV.

Playback looks fine on the camcorder but there is no image on the TV screen.

- The video input on the TV is not set to the video terminal to which you connected the camcorder. Select the correct video input.
- There will be no video output from the AV OUT terminal while the optional CTC-100 Component Cable is connected to the camcorder's COMPONENT OUT terminal. Disconnect the CTC-100 Component Cable in advance to use the AV OUT terminal.

There is no sound from the TV.

- When connecting the camcorder to an HDTV using the optional CTC-100 Component Cable, make sure to connect also the audio connections using the white and red plugs of the supplied STV-250N Stereo Video Cable.

The camcorder is connected using the supplied HTC-100/S HDMI Cable, but there is no picture or sound from the HDTV.

- Disconnect the HTC-100/S HDMI Cable and then restore the connection or turn the camcorder off and then on again.

The camcorder is connected using the supplied HTC-100/S HDMI Cable, but HDMI-CEC does not work (cannot play back using the TV's remote control).

- Disconnect the HTC-100/S HDMI cable and turn off the camcorder and the TV. After a short while turn them on again and restore the connection.
-  [Control for HDMI] is set to [Off]. Set it to [On].
- HDMI-CEC is not activated on the connected TV. Activate this function on the TV.
- Even with TV sets compatible with HDMI-CEC the range of functions available differs depending on the type of TV. Refer to the instruction manual of the connected TV.

The computer does not recognize the camcorder even though the camcorder is connected correctly.

- Disconnect the USB cable and turn off the camcorder. After a short while, turn it on again and restore the connection.
- Connect the camcorder to a different USB port on the computer.
- The camcorder will not be correctly recognized if you connected the USB cable to the computer while the camcorder was deleting all the photos. Disconnect the USB cable and restore the connection once the operation is completed.

Cannot save photos on my computer

- When the memory contains too many photos (Windows – 2,500 photos or more, Macintosh – 1,000 photos or more), you may not be able to transfer photos to a computer. Try using a card reader to transfer the photos on the memory card. **HFR21/HFR20** only: To transfer the photos in the built-in memory, copy them to the memory card in advance ( 116).

List of Messages (in alphabetical order)

Accessing the memory card. Do not remove the memory card.

- You opened the double memory card slot cover while the camcorder was accessing the memory card or the camcorder started accessing the memory card as you opened the double memory card slot cover. Do not remove the memory card until this message disappears.

Back up recordings regularly

- This message may appear when you turn on the camcorder. In the event of a malfunction, recordings may be lost so back up your recordings regularly (📖 119).

Buffer overflow. Recording was stopped.

- The data transfer rate was too high for the memory card in use and the recording was stopped. Replace the memory card with one rated Speed Class 4, 6 or 10.

HFR21/HFR20 Built-in memory error

- The built-in memory could not be read. Contact a Canon Service Center.

HFR21/HFR20 Built-in memory is full

- The built-in memory is full ([📷] End) appears on the screen). Delete some recordings (📖 56, 105) to free some space. Save your recordings (📖 119) and initialize the built-in memory (📖 41).

HFR21/HFR20 Built-in memory writing error Attempt recovering the data?

- This message will appear the next time you turn on the camcorder if power supply was accidentally interrupted while the camcorder was writing to the built-in memory. Select [Recover] to try to recover the recordings.

HFR21/HFR20 Cannot access the built-in memory

- There is a problem with the built-in memory. Contact a Canon Service Center.

Cannot communicate with the battery pack. Continue using this battery pack?

- You attached a battery pack that is not recommended by Canon for use with this camcorder.
- If you are using a battery pack recommended by Canon for use with this camcorder, there may be a problem with the camcorder or battery pack. Consult a Canon Service Center.

HFR21/HFR20 Cannot convert

- Cannot access the memory card. Check the memory card and make sure it is inserted correctly.
- You inserted a MultiMedia Card (MMC) into the camcorder. Use a recommended memory card (📖 36).
- The selected scene is too short. Select a scene that is at least 0.5 seconds long.
- There was an error creating the file name. Set [📷] [▶] [Photo Numbering] to [Reset] and initialize the memory card or delete all the photos (📖 105) and all the scenes in the [📷 SD Movies] index screen (📖 56).

Cannot copy

- The total size of the scenes you selected to copy exceeds the available space in the memory. Delete some recordings on the memory card (📖 56, 105) or reduce the number of scenes to copy.
- The memory already contains the maximum number of scenes (3,999 scenes). Delete some scenes (📖 56) to free some space.

Cannot divide the scene. Initialize only using the camcorder.

- The scene could not be divided because the camcorder's internal scene management data log is full. Save your recordings (📖 116) and initialize the memory (📖 41). Write back the backup files and try dividing the scene again.

Cannot edit

- Could not move the scene to another story. Delete some scenes from the story (📖 90).

Cannot enter standby mode now

- The camcorder cannot enter standby mode if the remaining battery charge is too low. Charge or replace the battery pack (📖 21).

Cannot load canvas

- The canvas data in the memory is corrupted.
- Cannot load canvas data saved with another device. Use canvas data saved with this camcorder.

Cannot play back

- **HFR21/HFR20** You may not be able to play back scenes recorded or edited using another device and were then written back to the built-in memory.
- If a memory card was recorded on with another device and then the LOCK switch was set to prevent writing, gallery information cannot be accessed correctly so playback is not possible from the gallery screen. Play back scenes from the date index screen or change the position of the LOCK switch on the memory card.
- There is a problem with the memory. If this message appears often without apparent reason, contact a Canon Service Center.

HFR21/HFR20 Cannot play back Cannot access the built-in memory

- There is a problem with the built-in memory. Save your recordings (📖 119) and initialize the built-in memory using the [Complete Initialization] option (📖 41). If the problem persists, contact a Canon Service Center.

Cannot play back Check the memory card

- There is a problem with the memory card. Save your recordings (📖 119) and initialize the memory card using the [Complete Initialization] option (📖 41). If the problem persists, use a different memory card.

HFR21/HFR20 Cannot play the movies in the built-in memory Initialize only using the camcorder

- The camcorder's built-in memory was initialized using a computer. Initialize the built-in memory with this camcorder (📖 41).

Cannot play the movies on this memory card

- Movies cannot be played back from a 64 MB or smaller memory card. Use a recommended memory card (📖 36).

Cannot play the movies on this memory card Initialize only using the camcorder

- The memory card in the camcorder was initialized using a computer. Initialize the memory card with this camcorder (📖 41).

Cannot record

- You cannot capture video snapshot scenes from scenes recorded or edited using another device.
- There is a problem with the memory. If this message appears often without apparent reason, contact a Canon Service Center.

HFR21/HFR20 Cannot record Cannot access the built-in memory

- There is a problem with the built-in memory. Save your recordings (📖 119) and initialize the built-in memory using the [Complete Initialization] option (📖 41). If the problem persists, contact a Canon Service Center.

Cannot record Check the memory card

- There is a problem with the memory card. Save your recordings (📖 119) and initialize the memory card using the [Complete Initialization] option (📖 41). If the problem persists, use a different memory card.

HFR21/HFR20 Cannot record movies in the built-in memory Initialize only using the camcorder

- The camcorder's built-in memory was initialized using a computer. Initialize the built-in memory with this camcorder (📖 41).

Cannot record movies on this memory card

- Movies cannot be recorded on a 64 MB or smaller memory card. Use a recommended memory card (📖 36).

Cannot record movies on this memory card Initialize only using the camcorder

- The memory card in the camcorder was initialized using a computer. Initialize the memory card with this camcorder (📖 41).

Cannot save the canvas

- Cannot save the canvas to the memory. Save your recordings (📖 119) and initialize the memory (📖 41).

Change the battery pack



- Battery pack is exhausted. Replace or charge the battery pack.

Check the memory card

- Cannot access the memory card. Check the memory card and make sure it is inserted correctly.
- A memory card error occurred. The camcorder cannot record or display the image. Try removing and reinserting the memory card, or use a different memory card.

- You inserted a MultiMedia Card (MMC) into the camcorder. Use a recommended memory card (📖 36).
- If after the message disappears, **A** / **B** appears in red, perform the following: Turn off the camcorder and remove and reinsert the memory card. If **A** / **B** turns back to green you can resume recording/playback. If the problem persists, save your recordings (📖 119) and initialize the memory card (📖 41).

File name error

- The folder and file numbers have reached their maximum value. Set   [Photo Numbering] to [Reset] and delete all the photos on the memory card (📖 105) or initialize it (📖 41).

Initialize only using the camcorder

- There is a problem with the file system that prevents accessing the selected memory. Initialize the memory with this camcorder (📖 41).

LCD Screen has been dimmed

- Hold **[DISP]** pressed for 2 seconds to restore the LCD screen to its previous brightness setting.

May not be possible to record movies on this memory card

- You may not be able to record movies on a memory card without a Speed Class rating. Replace the memory card with one rated Speed Class 4, 6 or 10.

Mem. Card Number of scenes already at maximum

- The memory card already contains the maximum number of scenes (3,999 scenes); no further scenes can be copied onto the memory card. Delete some scenes (📖 56) to free some space.

Mem. Card Unable to recognize the data

- The memory card contains scenes recorded in a different television system (PAL or SECAM). Play back the recordings in the memory card with the device originally used to record them.

Memory card A writing error Attempt recovering the data?

- This message will appear the next time you turn on the camcorder if power supply was accidentally interrupted while the camcorder was writing on the memory card. Select **[Recover]** to try to recover the recordings. If you removed the memory card and used it with another device after this happened, we recommend you select **[No]**.

Memory card B writing error Attempt recovering the data?

- This message will appear the next time you turn on the camcorder if power supply was accidentally interrupted while the camcorder was writing on the memory card. Select **[Recover]** to try to recover the recordings. If you removed the memory card and used it with another device after this happened, we recommend you select **[No]**.

Memory card cover is open

- After inserting a memory card, close the double memory card slot cover (📖 38).

Memory card is full

- The memory card is full. Delete some recordings (📖 56, 105) to free some space or replace the memory card.

Memory card is write-protected

- The LOCK switch on the memory card is set to prevent accidental erasure. Change the position of the LOCK switch.

Need to recover files from the memory card. Change the position of the LOCK switch on the memory card.

- This message will appear the next time you turn on the camcorder if power supply was accidentally interrupted while the camcorder was writing on the memory card and later the position of the card's LOCK switch was changed to prevent erasure. Change the position of the LOCK switch.

No memory card

- Insert a compatible memory card into the camcorder (📖 38).
- The memory card may not be inserted correctly. Insert the memory card all the way into the memory card slot until it clicks.

No photos

- There are no photos to play back. Have fun taking some photos (📖 43, 58).

No scenes

- There are no scenes in the memory selected. Have fun shooting some video (📖 43).

Not enough available space

- Delete some recordings on the memory card (📖 56, 105) or select the [3 Mbps] bit rate for the conversion to SD.

Number of scenes already at maximum

- The maximum number of scenes (3,999 scenes) has been reached. Delete some scenes (📖 56) to free some space.
- A story can contain a maximum of 999 scenes.

Number of stories already at maximum

- A memory can contain a maximum of 98 stories (not including [Unsorted] and [Video Snapshot]). Delete some stories (📖 90) or select a different memory that contains less than 98 stories.

Scene recorded using another device. Cannot divide the scene.

- Scenes recorded using another device cannot be divided with this camcorder.

Select the desired scene number

- A number of scenes have the same recording date but different file control information. This can occur for example when you edit photos and write the files back to the camcorder. Select a number to display the corresponding group of scenes.

HFR21/HFR20 Some scenes could not be converted

- Among the scenes selected for conversion to SD there are scenes recorded with another device. When converting scenes to SD, leave out scenes recorded using another device.
- Scenes recorded with another device cannot be converted. Those scenes were not converted but the other scenes selected for conversion were converted.

Some scenes could not be deleted

- Movies that were protected/edited with other devices cannot be deleted with this camcorder.

Some scenes were recorded using another device and cannot be copied.

- Scenes that were not recorded with this camcorder cannot be copied.

Task in progress. Do not disconnect the power source.

- The camcorder is updating the memory. Wait until the operation ends and do not disconnect the compact power adapter or remove the battery pack.

There are no scenes with the selected rating

- The story does not contain any scenes with the selected ratings. Select scenes and rate them (□ 87) or select a different rating for the operation.

This memory card contains scenes. Delete all scenes to use relay recording.

- Save your movies (□ 119) if necessary, and delete all the movies from the memory card (□ 56).

This photo cannot be displayed

- You may not be able to display photos taken with other devices or image files created or edited on a computer.

This scene was recorded using another device and cannot be copied.

- Scenes that were not recorded with this camcorder cannot be copied.

To record video on this memory card, it is recommended to use only the XP+/SP/LP recording modes

- Movies may not be recorded correctly on this memory card if the recording mode is set to MXP or FXP mode (□ 59).

To use the wireless function, insert the Eye-Fi card into slot B.

- You may have inserted the Eye-Fi card into memory card slot **A**. Insert it into memory card slot **B**.

To use this function, switch out of **AUTO** mode

- You pressed a button that cannot be used in **AUTO** mode. Press **AUTO** to set the camcorder to flexible recording mode.

Too many photos. Disconnect the USB cable.

- Disconnect the USB cable. Try using a memory card reader or decrease the number of photos on the memory card to fewer than 2,500 photos (Windows computers), or 1,000 photos (Macintosh computers).

- If a dialog box appeared on the computer screen, close it. Disconnect the USB cable, and restore the connection after a short while.



Total play time is too long

- The story cannot be converted when its total playback time exceeds 2 hours and 30 minutes. Reduce the number of scenes to convert.

Unable to recognize the data

- You transferred data to the camcorder recorded in a different television system (PAL or SECAM). Play back the recordings with the device originally used to record them.

Unable to recover data

- Could not recover a corrupted file. Save your recordings ( 119) and initialize the memory using the [Complete Initialization] option ( 41).

Unsupported gallery data detected. Cannot record or edit. Delete gallery data?

- The gallery data on the selected memory is not supported by this camcorder. Playback is possible but you recording and editing is not. Touch [Yes] to erase the gallery data and enable recording. If the gallery data is erased, the camcorder that recorded the movies will not be able to play them back.

USB Connection Do not disconnect the power source. Cannot write data with this connection. To write data to the camcorder, connect the compact power adapter then reconnect the camcorder and computer. Do not disconnect the USB cable unless you first use the computer to safely end the connection.

- The camcorder cannot be operated while it is not being powered by the compact power adapter and is connected to a computer with the supplied USB cable. In addition, scenes cannot be written back and music files cannot be transferred to the camcorder. To avoid corrupting the data in the camcorder's memory, use the computer's Safely Remove Hardware function to end the connection and disconnect the USB cable before using the camcorder.
- To be able to write back scenes and to transfer music files to the camcorder, use the computer's Safely Remove Hardware function to end the connection, disconnect the USB cable, power the camcorder using the compact power adapter and only then connect it to the computer again.

USB Connection Do not disconnect the power source. Do not disconnect the USB cable unless you first use the computer to safely end the connection.

- When the camcorder is in  mode and is connected to the computer with the supplied USB cable, the camcorder cannot be operated. Disconnecting the USB cable or power source while this message appears may result in permanent loss of the recordings in the camcorder. Use the computer's Safely Remove Hardware function to end the connection and disconnect the USB cable before using the camcorder.
- To be able to write back scenes and to transfer music files to the camcorder, power the camcorder using the compact power adapter and only then connect it to the computer using the supplied USB cable.

Handling Precautions

Camcorder

Be sure to observe the following precautions to ensure maximum performance.

- **Save your recordings periodically.** Make sure to transfer your recordings to an external device such as a computer or digital video recorder (📖 116) and save them on a regular basis. This will protect your important recordings in case of damage and create more free space on the memory. Canon shall not be liable for any data loss.
- Do not carry the camcorder by the LCD panel. Be careful when closing the LCD panel. When using a wrist strap, do not allow the camcorder to swing and hit an object.
- **Handle the touch screen with care.** Do not apply excessive force and do not use ballpoint pens or other hard-tipped objects other than the stylus pen to operate the touch screen. This may damage the touch screen's surface or the pressure-sensitive layer beneath it.
- Do not attach protective film on the touch screen. The touch screen's operation is based on detecting applied pressure, so you may not be able to correctly operate the touch screen with an additional protective layer.
- Do not leave the camcorder in places subject to high temperatures (like the inside of a car parked under direct sunlight), or high humidity.
- Do not use the camcorder near strong electromagnetic fields such as above TVs, near plasma TVs or mobile phones.
- When using the camcorder, do not place it in narrow, confined places.
- Do not point the lens at strong light sources. Do not leave the camcorder pointed at a bright subject.
- Do not use or store the camcorder in dusty or sandy places. The camcorder is not waterproof – avoid also water, mud or salt. If any of the above should get into the camcorder it may damage the camcorder and/or the lens.
- Make sure you can unplug the compact power adapter from the power outlet quickly should the need arise.
- Be careful of heat generated by lighting equipment.
- Do not disassemble the camcorder. If the camcorder does not function properly, consult qualified service personnel.

- Do not insert the supplied stylus pen into the mouth. If swallowed, seek medical assistance immediately.
- Handle the supplied stylus pen with extreme care and keep it out of the reach of children. If mishandled, the stylus pen can present a risk of severe eye injury and even blindness.
- Handle the camcorder with care. Do not subject the camcorder to shocks or vibration as this may cause damage.
- When mounting the camcorder on a tripod, make sure that the tripod's fastening screw is shorter than 5.5 mm (0.2 in.). Using other tripods may damage the camcorder.

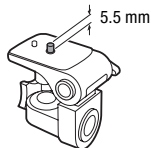

- **When recording movies, try to get a calm, stable picture.** Excessive camcorder movement while shooting and extensive use of fast zooms and panning can result in jittery scenes. In extreme cases, the playback of such scenes may result in visually induced motion sickness. If you experience such a reaction, stop the playback immediately and take a rest break as necessary.

Long-term storage

If you do not intend to use the camcorder for a long time, store it in a place free of dust, in low humidity, and at temperatures not higher than 30 °C (86 °F).

Battery Pack

DANGER!

Treat the battery pack with care.

- Keep it away from fire (or it might explode).
 - Do not expose the battery pack to temperature higher than 60 °C (140 °F). Do not leave it near a heater or inside a car in hot weather.
 - Do not try to disassemble or modify it.
 - Do not drop it or subject it to shocks.
 - Do not get it wet.
- Dirty terminals may cause a poor contact between the battery pack and the camcorder. Wipe the terminals with a soft cloth.



Long-term storage

- Store battery packs in a dry place at temperatures no higher than 30 °C (86 °F).
- To extend the battery life of the battery pack, discharge it completely before storing it.
- Charge and discharge all your battery packs fully at least once a year.

Remaining battery time

If the remaining battery time displayed is not correct, charge the battery pack fully. Still, the correct time may not be displayed if the battery pack is used continuously in high temperatures, charged in low temperatures or left unused for long periods of time. Also, the correct remaining time may not be displayed, depending on the battery life. Use the time shown on the screen as an approximation.

Regarding the use of non-Canon battery packs

- For your safety, battery packs that are not genuine Canon battery packs will not be charged even if you attach them to this camcorder or to the optional CG-110 Battery Charger.
- We recommend using genuine Canon battery packs bearing the Intelligent System mark.  **Intelligent Li-ion Battery**
- If you attach to the camcorder battery packs that are not genuine Canon battery packs,  will appear and the remaining battery time will not be displayed.

Memory Card

- We recommend backing up the recordings on the memory card onto your computer. Data may be corrupted or lost due to memory card defects or exposure to static electricity. Canon shall not be liable for lost or corrupted data.
- Do not touch or expose the terminals to dust or dirt.
- Do not use memory cards in places subject to strong magnetic fields.
- Do not leave memory cards in places subject to high humidity and high temperature.
- Do not disassemble, bend, drop, or subject memory cards to shocks and do not expose them to water.

- Check the direction before inserting the memory card. Forcing a memory card into the slot if it is not correctly oriented may damage the memory card or the camcorder.
- Do not attach any labels or stickers on the memory card.
- Secure Digital (SD) memory cards have a physical switch to prevent writing on the card so as to avoid the accidental erasure of the card's content. To write-protect the memory card set the switch to the LOCK position.

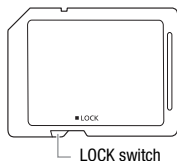

Built-in Rechargeable Lithium Battery

The camcorder has a built-in rechargeable lithium battery to keep the date/time and other settings. The built-in lithium battery is recharged while you use the camcorder; however, it will discharge completely if you do not use the camcorder for about 3 months.

To recharge the built-in lithium battery: Connect the compact power adapter to the camcorder and leave it connected for 24 hours with the camcorder off.

Disposal

When you delete movies or initialize the memory, only the file allocation table is altered and stored data is not physically erased. Take the necessary precautions when you dispose of the camcorder or memory card, for example by physically damaging it to prevent the leakage of private data.

If giving the camcorder or memory card to another person, initialize the built-in memory (**HFR21/HFR20** only) or memory card using the [Complete Initialization] option (📖 41). Fill it up with unimportant recordings, and then initialize it again using the same option. This makes recovering the original recordings very difficult.

Maintenance/Others

Cleaning

Camcorder Body

- Use a soft, dry cloth to clean the camcorder body. Never use chemically treated cloths or volatile solvents such as paint thinner.

Lens

- If the lens surface is dirty, autofocus may not work properly.
- Remove any dust or dirt particles using a non-aerosol type blower brush.
- Use a clean, soft lens-cleaning cloth to gently wipe the lens. Never use tissue paper.

LCD Touch Screen

- Clean the LCD touch screen using a clean, soft lens-cleaning cloth.
- Condensation may form on the surface of the screen when the temperature changes suddenly. Wipe it with a soft dry cloth.

Condensation

Moving the camcorder rapidly between hot and cold temperatures may cause condensation (water droplets) to form on its internal surfaces. Stop using the camcorder if condensation is detected. Continued use may damage the camcorder.

Condensation may form in the following cases:

- When the camcorder is moved quickly from cold to warm places
- When the camcorder is left in a humid room
- When a cold room is heated rapidly

To avoid condensation

- Do not expose the camcorder to sudden or extreme changes in temperature.
- Remove the memory card and battery pack. Then, place the camcorder in an airtight plastic bag and let it adjust gradually to temperature changes before removing it from the bag.

When condensation is detected

The camcorder automatically shuts off. The precise time required for water droplets to evaporate will vary depending on the location and weather conditions. As a general rule, wait for 2 hours before resuming use of the camcorder.

Using the Camcorder Abroad

Power Sources

You can use the compact power adapter to operate the camcorder and to charge battery packs in any country with power supply between 100 and 240 V AC, 50/60 Hz. Consult a Canon Service Center for information on plug adapters for overseas use.

Playback on a TV Screen

You can only play back your recordings on TVs compatible with the NTSC system. NTSC is used in the following regions/countries:

Americas: All of North America and Central America; most Caribbean islands (except in French territories like Guadeloupe and Martinique); most of South America (except in Argentina, Brazil and Uruguay). **Asia:** Only in Japan, the Philippines, South Korea, Taiwan and Myanmar. **Oceania:** US territories (Guam, American Samoa, etc.) and some Pacific islands like Micronesia, Samoa and Tonga.

Accessories (Availability differs from area to area)

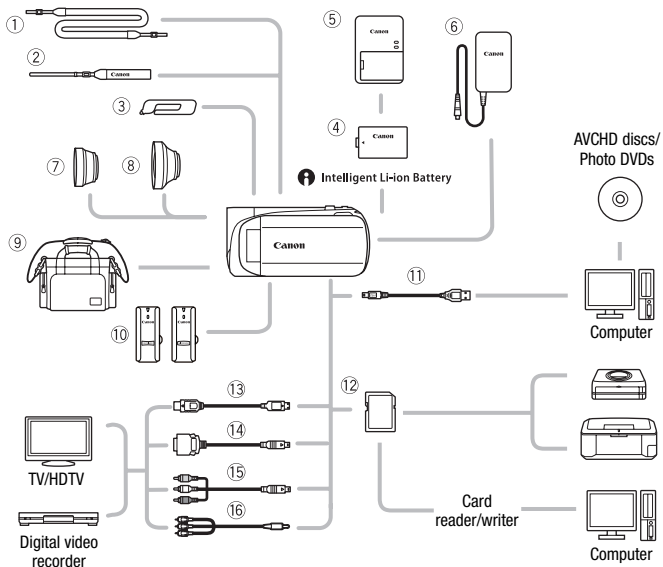

Optional accessories not listed below are described in more detail in the following pages.

- ① SS-600/SS-650 Shoulder Strap
- ② WS-20 Wrist Strap
- ③ Stylus Pen
- ④ Intelligent Li-ion Battery
- ⑤ Battery cover
- ⑥ CA-110 Compact Power Adapter
- ⑦ Lens cap
- ⑧ External speaker
- ⑨ Carrying case
- ⑩ Battery door covers
- ⑪ IFC-300PCU/S USB Cable*
- ⑫ Memory card
- ⑬ HTC-100 HDMI Cable
- ⑭ DTC-100 D Terminal Cable
- ⑮ CTC-100 Component Cable
- ⑯ STV-250N Stereo Video Cable

* Supplied with the camcorder; not available as an optional accessory.

Optional Accessories

Call or visit your local retailer/dealer for genuine Canon video accessories. You can also obtain genuine accessories for your Canon camcorder by calling: 1-800-828-4040, Canon U.S.A. Information Center.

Use of genuine Canon accessories is recommended.

This product is designed to achieve excellent performance when used with genuine Canon accessories. Canon shall not be liable for any damage to this product and/or accidents such as fire, etc., caused by the malfunction of non-genuine Canon accessories (e.g., a leakage and/or explosion of a battery pack). Please note that this warranty does not apply to repairs arising out of the malfunction of non-genuine Canon accessories, although you may request such repairs on a chargeable basis.

④ Battery Packs

When you need extra battery packs, select the BP-110.

When you use battery packs bearing the Intelligent System mark, the camcorder will communicate with the battery and display the remaining usage time (accurate to 1 minute). You can only use and charge these battery packs with camcorders and chargers compatible with Intelligent System.



⑤ CG-110 Battery Charger

Use the battery charger to charge the battery packs. It plugs directly into a power outlet without a cable.

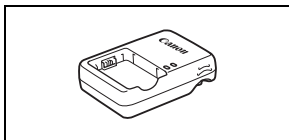

Charging, Recording and Playback Times

The charging times given in the following table are approximate and vary according to charging conditions and initial charge of the battery pack.

Charging conditions	Charging time
Using the camcorder	150 min.
Using the CG-110 Battery Charger	115 min.

Recording and playback times given in the following tables are approximate and vary according to recording mode and charging, recording or playback conditions. The effective usage time of the battery pack may decrease when recording in cold surroundings, when using the brighter screen settings, etc.

HFR21/HFR20 Using the built-in memory

Usage time	Recording mode				
	MXP	FXP	XP+	SP	LP
Recording (maximum)	80 min.	80 min.	85 min.	85 min.	85 min.
Recording (typical)*	50 min.	50 min.	50 min.	50 min.	50 min.
Playback	130 min.	135 min.	135 min.	135 min.	140 min.

Using a memory card

Usage time	Recording mode				
	MXP	FXP	XP+	SP	LP
Recording (maximum)	80 min.	80 min.	80 min.	80 min.	85 min.
Recording (typical)*	45 min.	45 min.	45 min.	45 min.	50 min.
Playback	130 min.	130 min.	130 min.	130 min.	130 min.

* Approximate times for recording with repeated operations such as start/stop, zooming, and power on/off.

⑦ TL-H34 II Tele-converter

This Tele-converter lens increases the focal length of the camcorder lens by a factor of 1.5.

- The image stabilizer is not as effective when the Tele-converter is attached.
- The minimum focusing distance at full telephoto with the TL-H34 II is 0.9 m (3 ft.).

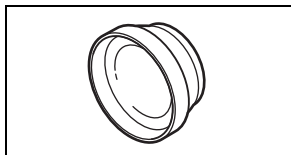

⑧ **WD-H34 II Wide-converter**

This Wide-converter lens decreases focal length by a factor of 0.7, giving you a wide perspective for indoor shots or panoramic views.

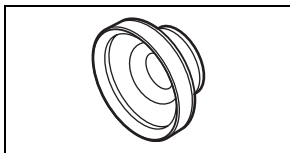

⑨ **SC-2000 Soft Carrying Case**

A handy camcorder bag with padded compartments and plenty of space for accessories.

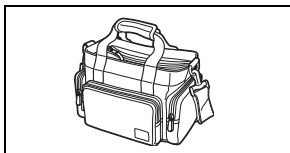

⑩ **WM-V1 Wireless Microphone**

Reliably record rich sound even when shooting subjects at a distance. The microphone is conveniently equipped with a clothing clip and the receiver can be attached to the camcorder's grip belt.

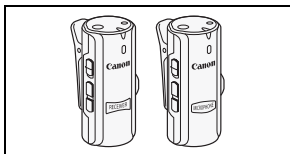

This mark identifies genuine Canon video accessories. When you use Canon video equipment, we recommend Canon-brand accessories or products bearing the same mark.



Product Codes

Provided Accessories

CA-110 Compact Power Adapter	5072B002AA
BP-110 Battery Pack	5071B002AA
STV-250N Stereo Video Cable	3067A002AA (D82-0590-002)

Optional Accessories

CG-110 Battery Charger	5073B002AA
TL-H34 II Tele-converter	5069B001AA
WD-H34 II Wide-converter	5070B001AA
WM-V1 Wireless Microphone	5068B002AA
HTC-100 HDMI Cable	2384B001AA
CTC-100 Component Cable	1719B001AA
IFC-300PCU USB Cable	6906A001AA
SS-650 Shoulder Strap	3123A001AA
SS-600 Shoulder Strap	3122A001AA
WS-20 Wrist Strap	3118A002AA
SC-2000 Soft Carrying Case	9389A001AA

Specifications

VIXIA HF R21 / VIXIA HF R20 / VIXIA HF R200

◆ — Values given are approximate figures.

System

• Recording System

Movies: AVCHD Video compression: MPEG-4 AVC/H.264;
Audio compression: Dolby Digital 2ch

Photos: DCF (Design rule for Camera File system), compatible with Exif* Ver. 2.2
Image compression: JPEG

* This camcorder supports Exif 2.2 (also called "Exif Print"). Exif Print is a standard for enhancing the communication between camcorders and printers. By connecting to an Exif Print-compliant printer, the camcorder's image data at the time of shooting is used and optimized, yielding extremely high quality prints.

• Television System

1080/60i*

* Recordings made with the [PF24], [PF30] frame rate are converted and recorded on the memory as 60i.

• Recording Media

- **HFR21/HFR20** Built-in memory: **HFR21** 32 GB, **HFR20** 8 GB
- SD, SDHC (SD High Capacity) or SDXC (SD eXtended Capacity) memory card (not included)

• Maximum Recording Time◆

HFR21 32 GB built-in memory:

MXP mode: 2 hr. 55 min. **FXP** mode: 4 hr. 10 min. **XP+** mode: 5 hr. 45 min.
SP mode: 9 hr. 35 min. **LP** mode: 12 hr. 15 min.

HFR20 8 GB built-in memory:

MXP mode: 40 min. **FXP** mode: 1 hr. **XP+** mode: 1 hr. 25 min.
SP mode: 2 hr. 20 min. **LP** mode: 3 hr.

Commercially available 16 GB memory card:

MXP mode: 1 hr. 25 min. **FXP** mode: 2 hr. 5 min. **XP+** mode: 2 hr. 50 min.
SP mode: 4 hr. 45 min. **LP** mode: 6 hr. 5 min.

• Image Sensor

1/4.85-inch CMOS, 3,280,000 pixels◆

Effective pixels*: Movies*

1,470,000 pixels (optical zoom, entire zoom range, [Dynamic] IS mode)

2,070,000 pixels (optical zoom, entire zoom range, [Standard] IS mode)

1,040,000 (T) / 1,470,000 (W) (advanced zoom, [Dynamic] IS mode)

1,040,000 (T) / 2,070,000 (W) (advanced zoom, [Standard] IS mode)

16:9 photos: 2,070,000 pixels

4:3 photos: 2,410,000 pixels

* When two values are given, the first indicates the value at full telephoto (T) and the second the value at full wide-angle (W).

- **LCD Touch Screen:** 3.0 in., wide, TFT color, 230,000 dots[♦], touch operation
- **Microphone:** Stereo electret condenser microphone
- **Lens**
 f=3.0 – 60 mm, F/1.8 – 3.6, 20x optical zoom
 35 mm equivalent[♦]: Movies:
 49 – 980 mm (optical zoom, [Dynamic] IS mode)
 41.2 – 824 mm (optical zoom, [Standard] IS mode)
 49 – 1176 mm (advanced zoom, [Dynamic] IS mode)
 41.2 – 1154 mm (advanced zoom, [Standard] IS mode)
 16:9 photos: 41.2 – 824 mm
 4:3 photos: 40.6 – 812 mm
- **Lens Configuration:** 10 elements in 8 groups (1 aspheric element)
- **AF System**
 Autofocus (TTL) or Manual focus
- **Filter Diameter:** 34 mm
- **Minimum Focusing Distance**
 1 m* (3.3 ft.); 1 cm (0.39 in.) at full wide angle
 * 40 cm (1.3 ft.) at full-telephoto when tele-macro is on
- **White Balance**
 Auto white balance, Custom white balance or Preset white balance settings:
 Daylight, Tungsten
- **Minimum Illumination**
 0.4 lx ([Low Light] recording program, Shutter speed at 1/2)
 5 lx ([Programmed AE] recording program, Shutter speed at 1/30, Auto slow shutter [On])
- **Recommended Illumination:** More than 100 lx
- **Image Stabilization:** Electronic ([Dynamic] setting available when recording movies)
- **Size of Video Recordings**
MPX, FXP mode: 1920 x 1080 pixels; **XP+, SP, LP** mode: 1440 x 1080 pixels
- **Size of Photos**
 mode: **4:3** 2016x1512, **16:9** 1920x1080
 Capturing photos from video: **16:9** 1920x1080

Terminals

- **AV OUT/**  **Terminal**
Ø 3.5 mm minijack; output only (dual purpose terminal also for headphones stereo output)
Video: 1 V_{p-p} / 75 Ω unbalanced
Audio: -10 dBV (47 kΩ load) / 3 kΩ or less
- **USB Terminal:** mini-B, USB 2.0 (Hi-Speed USB)
- **COMPONENT OUT Terminal (proprietary mini-D terminal)**
Luminance (Y): 1 V_{p-p} / 75 Ω; Chrominance (P_B/P_R (C_B/C_R)): ±350 mV / 75 Ω
1080i (D3) compatible; output only
- **HDMI OUT Terminal**
HDMI mini connector; output only; compatible with HDMI-CEC and x.v.Color
- **MIC Terminal**
Ø 3.5 mm stereo minijack
-57 dBV (with 600 Ω microphone) / 5 kΩ or more

Power/Others

- **Power supply (rated)**
3.7 V DC (battery pack), 5.3 V DC (compact power adapter)
- **Power consumption** ♦
2.5 W (SP mode, AF on, LCD normal brightness)
- **Operating temperature** ♦: 0 – 40 °C (32 – 104 °F)
- **Dimensions** ♦ [W x H x D] (excluding the grip belt)
60 x 61 x 121 mm (2.4 x 2.4 x 4.8 in.)
- **Weight** ♦ (camcorder body only)
270 g (9.5 oz.)

CA-110 Compact Power Adapter

- **Power supply:** 100 – 240 V AC, 50/60 Hz
- **Rated output / consumption:** 5.3 V DC, 1.5 A / 17 VA (100 V) – 23 VA (240 V)
- **Operating temperature** ♦: 0 – 40 °C (32 – 104 °F)
- **Dimensions** ♦: 49 x 27 x 79 mm (1.9 x 1.1 x 3.1 in.)
- **Weight** ♦: 110 g (3.9 oz.)

BP-110 Battery Pack

- **Battery type**
Rechargeable lithium ion battery, compatible with Intelligent System
- **Rated voltage:** 3.7 V DC
- **Operating temperature** ♦: 0 – 40 °C (32 – 104 °F)
- **Battery capacity:** 1,120 mAh (typical)
3.9 Wh / 1,050 mAh (minimum)
- **Dimensions** ♦: 33 x 10 x 51 mm (1.3 x 0.39 x 2.0 in.)
- **Weight** ♦: 28 g (0.99 oz.)

Weight and dimensions are approximate. Errors and omissions excepted.
The information in this manual is verified as of January 2011. Subject to change without notice.

About the music files

The specifications of the music files compatible with the camcorder are as follows.

Audio encoding: Linear PCM

Audio sampling: 48 kHz, 16 bits, 2 channels

Minimum length: 1 second

File type: WAV

About the image files for the image mix function

The specification of the image files for the image mix function compatible with the camcorder are as follows.

Size: 1920x1080

File type: Baseline JPEG

Color sampling: 4:2:2, 4:2:0

The music data (WAV) and image files (JPG) are saved in the memory under the following folder structure.

HFR21/HFR20 In the built-in memory:

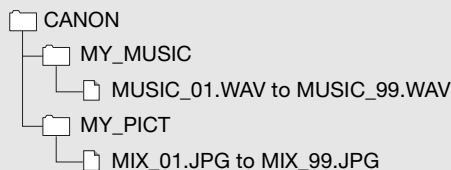

On the memory card:

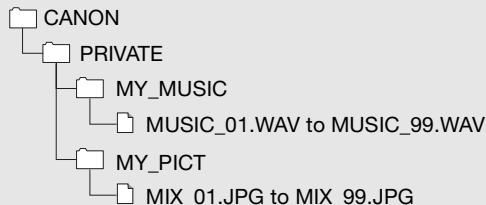

Index

3D Flip View 54

A

Abroad, using the camcorder 171

Aspect ratio of a connected TV
(TV type) 138

Audio balance 79, 82

Audio recording level 75

Auto slow shutter 137

Automatic backlight correction 71

AV OUT/ \square terminal 77, 111, 113

AVCHD specifications 6

B

Background music 82

Battery pack

 Battery information 145, 151

 Charging 21

 Remaining charge indicator . 151

Beach (recording program) 62

Built-in backup battery 169

C

Camcorder Supplemental Disc 17

Capturing photos/video snapshot
 scenes from a movie 94

Cine Mode (recording program) . . . 63

COMPONENT
 OUT terminal 111, 113

Condensation 170

Connections to external devices . 112

Converting scenes to standard
 definition* 125

Copying

 Movies 116

 Photos 117

D

Data code 87, 138

Date and time 34

Decorating scenes 97

Deleting

 Movies 56, 90

 Photos 105

Digital effects 69

Dividing scenes 96

Drag (touch operation) 29

E

Edit panel 32, 134

Error messages 159

External microphone 79

Eye-Fi card 130

F

Face detection 66

Fireworks (recording program) 63

Flexible recording 30

Flicker reduction 136

Focus assistance 136

Frame rate 60

FUNC. panel 32, 132

G

Gallery 90

H

HD to SD conversion* 125

HDMI 1080p output 143

HDMI OUT terminal 111, 112

HDMI-CEC 145

Headphones 77

I

Image mix 101

Image stabilizer 64

Index screen selection 54

Initialization
 (built-in memory*/memory card) . 41

* HFR21/HFR20 only.

L		Recording time	60
Language	35	Relay recording	40
LCD screen dimmer	144	Reviewing recordings	58
LCD touch screen	27, 29	S	
Low light (recording program)	62	Saving recordings	116
M		Creating discs	122
Maintenance	170	Transferring to a computer	119
Manual exposure	70	Using external	
Manual focus	71	video recorders	123
Markers	137	Selecting the memory	
Memory card	36, 168	for playback	54
MIC terminal	79	for recording	39
Microphone attenuator	137	Self timer	74
Mixing audio	79, 82	Setup menus	33, 136
N		Slideshow	109
Night scene (recording program)	62	Smart AUTO mode	44
Notification sounds	144	Snow (recording program)	62
O		Sports (recording program)	62
Onscreen display selection	87	Spotlight (recording program)	62
Onscreen icons	147	Standard definition movies	125
P		Story	90
Photo size	108	Stylus pen	25
Playback		Sunset (recording program)	62
Movies	50	T	
Photos	103	Tele-macro	72
Portrait (recording program)	62	Telephoto	47
Power saving	46	Time zone/DST	35
Pre-recording	65	Timeline	80
Q		Touch & Track	67
Quick Start	49	Touch (touch operation)	29
R		Touch AE	70
Rating scenes	87, 139	Touch AF	71
Recording		Touch screen operations	29
Movies	43, 58	Tripod	167
Photos	43, 107	Troubleshooting	152
Recording mode	59	U	
Recording programs	61, 63	Uploading movies to video sharing	
		Web sites	125
		USB terminal	111, 114

* **HFR21/HFR20** only.

V

Video snapshot68

Volume52, 77

W

White balance73

Wide angle47

Wind screen137

Z

Zoom47

CANON CONSUMER DIGITAL VIDEO EQUIPMENT LIMITED WARRANTY FOR THE UNITED STATES

The limited warranty set forth below is given by Canon U.S.A., Inc. ("Canon USA") with respect to Canon Consumer Digital Video Equipment (the "Equipment") purchased in the United States. This limited warranty is only effective upon presentation of your Bill of Sale or other proof of purchase.

The Equipment is warranted under normal, non-commercial, personal use, against defective materials or workmanship as follows:

Parts: Defective parts will be exchanged for new parts or comparable rebuilt parts for a period of ONE YEAR from the date of original purchase, except for a defective Video Head, which will be exchanged for a period of three months from the date of purchase.

Labor: For a period of ONE YEAR from the date of original purchase, labor will be provided free of charge by our factory service centers or designated service facilities located in the United States.

When returning Equipment under this warranty, you must pre-pay the shipping charges, and you must enclose the Bill of Sale or other proof of purchase with a complete explanation of the problem. During the ONE-YEAR warranty period, repairs will be made and the Equipment will be return-shipped to you free of charge. For repairs after the warranty period is over, you will be given an estimate of the cost of repair and an opportunity to approve or disapprove of the repair expense before it is incurred. If you approve, repairs will be made and the Equipment will be return-shipped to you. (shipping charges apply). If you disapprove, we will return-ship the equipment at no charge to you.

Non-Canon brand peripheral equipment and software which may be distributed with, or factory loaded on, the Equipment, are sold "AS IS" without warranty of any kind by Canon USA, including any implied warranty regarding merchantability or fitness for a particular purpose. The sole warranty with respect to such non-Canon brand items is given by the manufacturer or producer thereof. If the Equipment contains a hard disk drive, Canon USA recommends that data stored on that drive be duplicated or backed up to prevent its loss in the event of failure or other malfunction of such drive.

Canon USA shall have no responsibility under this limited warranty for use of the Equipment in conjunction with incompatible peripheral equipment and incompatible software.

In order to obtain warranty service, contact the authorized Canon retail dealer from whom you purchased the Equipment or call the CANON INFORMATION CENTER AT 1-800-OK-CANON). You will be directed to the nearest service facility for your Equipment.

This Limited Warranty covers all defects encountered in normal use of the Equipment and does not apply in the following cases:

- A) Loss or damage to the Equipment due to abuse, mishandling, accident, improper maintenance, or failure to follow operating instructions;
- B) If the Equipment is defective as a result of leaking batteries, sand, dirt or water damage;
- C) If defects or damages are caused by the use of unauthorized parts or by service other than by Canon USA's factory service centers or authorized service facilities;
- D) If the Equipment is used for commercial or industrial use.

This Limited Warranty does not cover cabinet (exterior finish), video cassette tape, head cleanings, nor does it apply to Equipment purchased outside the United States. This warranty does not cover units sold to rental firms, military operations, hotels, schools, hospitals or for other commercial, industrial, or institutional applications.

These uses are covered only by such specific warranty as Canon may issue with such sales.

This Limited Warranty does not apply to accessories or consumables for the Equipment, which are sold "AS IS", without warranty of any kind by Canon USA.

Please retain this warranty card and your Bill of Sale as a permanent record of your purchase. This card is most important in order to be sure you are contacted right away should there be a safety inspection, modification or product recall under applicable laws or regulations.

NO IMPLIED WARRANTY, INCLUDING MERCHANTABILITY AND FITNESS FOR A PARTICULAR PURPOSE APPLIES TO THIS EQUIPMENT AFTER THE APPLICABLE PERIOD OF EXPRESS WARRANTY OR GUARANTY, EXCEPT AS MENTIONED ABOVE, GIVEN BY ANY PERSON, FIRM OR CORPORATION WITH RESPECT TO THIS EQUIPMENT SHALL BIND THE UNDERSIGNED (SOME STATES DO NOT ALLOW LIMITATIONS ON HOW LONG AN IMPLIED WARRANTY LASTS, SO THE ABOVE LIMITATION OR EXCLUSION MAY NOT APPLY TO YOU). CANON USA SHALL NOT BE LIABLE FOR LOSS OF REVENUES OR PROFITS, EXPENSE FOR SUBSTITUTE EQUIPMENT OR SERVICE, STORAGE CHARGES,

LOSS OR CORRUPTION OF DATA, INCLUDING WITHOUT LIMITATION, LOSS OR CORRUPTION OF DATA STORED ON THE EQUIPMENT'S HARD DRIVE, OR ANY OTHER SPECIAL, INCIDENTAL OR CONSEQUENTIAL DAMAGES CAUSED BY THE USE, MISUSE OR INABILITY TO USE THE EQUIPMENT, REGARDLESS OF THE LEGAL THEORY ON WHICH THE CLAIM IS BASED, AND EVEN IF CANON USA HAS BEEN ADVISED OF THE POSSIBILITY OF SUCH DAMAGES. NOR SHALL RECOVERY OF ANY KIND AGAINST CANON USA BE GREATER THAN THE PURCHASE PRICE OF THE EQUIPMENT SOLD BY CANON USA AND CAUSING THE ALLEGED DAMAGE. WITHOUT LIMITING THE FOREGOING, YOU ASSUME ALL RISK AND LIABILITY FOR LOSS, DAMAGE OR INJURY TO YOU AND YOUR PROPERTY AND TO OTHERS AND THEIR PROPERTY ARISING OUT OF USE, MISUSE OR INABILITY TO USE THE EQUIPMENT NOT CAUSED DIRECTLY BY THE NEGLIGENCE OF CANON USA. (SOME STATES DO NOT ALLOW THE EXCLUSION OR LIMITATION OF INCIDENTAL OR CONSEQUENTIAL DAMAGES, SO THE ABOVE LIMITATION MAY NOT APPLY TO YOU). THIS WARRANTY SHALL NOT EXTEND TO ANYONE OTHER THAN THE ORIGINAL PURCHASER OF THIS EQUIPMENT OR THE PERSON FOR WHOM IT WAS PURCHASED AS A GIFT.

This warranty gives you specific legal rights, and you may also have other rights which vary from state to state. CANON U.S.A., INC.

CANON CONSUMER DIGITAL VIDEO EQUIPMENT LIMITED WARRANTY

The limited warranty set forth below is given by Canon Canada Inc. ("Canon Canada") with respect to Canon Consumer Digital Video Equipment (the "Equipment") purchased in Canada. This limited warranty is only effective upon presentation of a bill of sale or other proof of purchase for this Equipment to a Canon Service Facility when repairs are required. The Equipment is warranted under normal, non-commercial, personal use, against defective materials or workmanship as follows:

Parts: Defective parts will be exchanged for new parts or, at Canon Canada's option, comparable rebuilt parts for a period of one year from the date of original purchase, except Video Heads which will be exchanged for a period of 3 months from the date of purchase.

Labour: For a period of one year from the date of original purchase, labour will be provided free of charge by our Canon Service Facilities in Canada.

This limited warranty covers all defects except where:

(a) The loss or damage to the product results from:

- i) accident, natural disaster, mishandling, abuse, neglect, unauthorized product modification or failure to follow instructions contained in the instruction manual;
- ii) the use of accessories, attachments, products, supplies, parts or devices with the Equipment that do not conform to Canon specifications or that cause abnormally frequent service problems;
- iii) repairs or services performed by any party other than a Canon Service Facility;
- iv) defective batteries or any exposure to water, sand or dirt;
- v) shipping (claim must be presented to the shipper);

(b) Any serial number on the video equipment is altered or removed.

(c) The Equipment is used for commercial, professional or industrial purposes.

This limited warranty does not cover the cabinet (exterior finish) of the Equipment, media, nor does it apply to Equipment purchased outside Canada.

If the Equipment contains a hard disk drive, Canon Canada recommends that data stored on that drive be duplicated or backed up to prevent its loss in the event of a failure or other malfunction of such drive.

TO OBTAIN WARRANTY SERVICE

Ship your Equipment in its original carton, box or equivalent, properly packed, fully insured with shipping charges prepaid, together with a copy of your bill of sale or other proof of purchase and a description of the problem to any of the Canon Service Facilities in Canada.

LIMITATIONS

Except as otherwise required by applicable legislation, this warranty is in lieu of all other warranties, conditions, guarantees or representations, express or implied, statutory or otherwise, relative to the Equipment, including implied warranties or conditions of merchantability or fitness for a particular purpose.

Canon Canada assumes no liability for special, consequential or incidental damages, loss or corruption of data including, without limitation, data stored on the hard disk drive of the Equipment or loss that may arise, whether on account of negligence or otherwise, from the use, misuse or inability to use the Equipment (including loss of profit, revenue, media or enjoyment) or from failure to conform to any express or implied warranties, conditions, guarantees or representations. Any recovery under this limited warranty shall not exceed the purchase price of the equipment. Canon Canada does not assume or authorize any other person to assume for Canon Canada any other liability with respect to this equipment.

This warranty does not extend to any person other than the original purchaser of the Equipment or the person for whom it was purchased as a gift and states your exclusive remedy.

NOTICE TO CONSUMER

If you plan to take important videos or if the product has not been used for some time, please check all functions with the instruction book before using it.

Canon

USA	CANON U.S.A., INC. NEW JERSEY OFFICE 100 Jamesburg Road, Jamesburg, NJ 08831 USA CANON U.S.A., INC. CHICAGO OFFICE 100 Park Blvd., Itasca, IL 60143 USA CANON U.S.A., INC. LOS ANGELES OFFICE 15955 Alton Parkway, Irvine, CA 92618 USA CANON U.S.A., INC. HONOLULU OFFICE 210 Ward Avenue, Suite 200, Honolulu, HI 96814 USA
	❖ If you have any questions, call the Canon U.S.A. Information Center toll-free at 1-800-828-4040 (USA only).

CANADA	CANON CANADA INC. 6390 Dixie Road, Mississauga, ON L5T 1P7
	❖ If you have any questions, call the Canon Canada Information Center toll free (in Canada only) at 1-800-OK-CANON (1-800-652-2666).
	❖ Si vous avez des questions, veuillez téléphoner 1-800-OK-CANON (1-800-652-2666, sans frais au Canada seulement).

MÉXICO	CANON MEXICANA, S DE RL DE CV Blvd. Manuel Ávila Camacho No. 138, Piso 17 Col. Lomas de Chapultepec, C.P. 11000 México, D.F., México CANON U.S.A., INC. NEW JERSEY OFFICE 100 Jamesburg Road, Jamesburg, NJ 08831 USA
---------------	---

CENTRO Y SURAMÉRICA	CANON LATIN AMERICA, INC. 703 Waterford Way, Suite 400, Miami, FL 33126 USA
----------------------------	---

ASIA	CANON HONGKONG COMPANY LTD. 19/F, The Metropolis Tower, 10 Metropolis Drive, Hungghom, Kowloon, Hong Kong Tel: +852 3191 2333, Fax: +852 2428 3963
-------------	--

For support concerning the supplied PIXELA's software, please call PIXELA customer support (details in the Installation Guide for PIXELA's software).