

32" CLASS (31.5" DIAGONAL)  
26" CLASS (26.0" DIAGONAL)  
22" CLASS (21.6" DIAGONAL)

32LD350C  
26LD350C  
22LD350C

LCD TV

## LCD Commercial Widescreen

## Integrated HDTV



PUBLIC DISPLAY SETTINGS - CLONING CAPABLE

 EcoSmart™  
Energy Saving Levels

 ENERGY STAR® 4.1 AND RoHS COMPLIANT

DYNAMIC CONTRAST RATIO  
15,000:1 (26"/32")  
8,000:1 (22")

NATIVE DISPLAY RESOLUTION  
1366 X 768

BUILT-IN ATSC/NTSC/QAM CLEAR TUNER

INVISIBLE SPEAKER SYSTEM  
Hidden speaker grilles

LG'S EXCLUSIVE XD ENGINE®

USB 2.0 MEDIA HOST FOR PHOTOS AND MUSIC

USB CLONING

CLEAR VOICE II

REAL CINEMA™

2 HDMI™ INPUTS WITH HDCP  
V.1.3 with deep color (26"/32")

AUTO SENSING REMOTE JACK PACK (RJP) COMPATIBLE\*

2-YEAR LIMITED WARRANTY  
(parts/labor)

\*NOTE: Contact your LG Sales representative on the RJP's that are compatible with the LD350C series.

[www.LGolutions.com](http://www.LGolutions.com)

 **LG**  
Life's Good



green LIFE'S GOOD...

# WHEN IT'S GREEN.

LG is committed to improving product development, manufacturing and usage to meet the demand for environmentally friendlier products. Our LD350C televisions have technologies to reduce power consumption and in return increase **cost savings** per room. We've also placed limits in the amounts of harmful materials used in these televisions.

- **EcoSmart**  
Energy Saving Levels - Manually select your choice for the brightness level for the television.
- **RoHS Compliant**  
Meets directive on restriction of hazardous substances.
- **Energy Star 4.1 Qualified** - Meets current reduction requirements of energy consumption.

# FEATURES



LG's newest core technology, Picture Wizard, enables easy self-calibration by providing on-screen reference points for key picture quality elements such as black level, color, tint, sharpness and backlight levels. By using this easy-to-use calibration process, the picture setting can be set to better fit the type of room application.

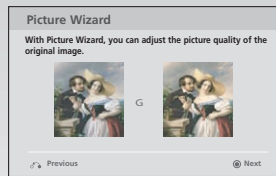

Dramatization

## ENERGY SAVING LEVELS

Manually select your choice for the brightness level for the television. By selecting Minimum, Medium, or Maximum, the power consumption will be reduced and an increase in energy savings can be achieved. (Note: Selecting minimum level may slightly increase power consumption on some models)

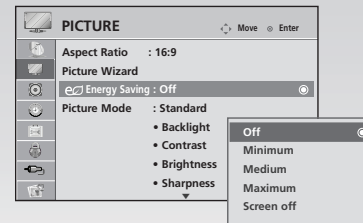

## BALANCED SOUND TO EMPHASIZE DIALOGUE

Clear Voice technology automatically enhances dialogue when background sounds such as those in an action sequence swell. Enhancements made to the Clear Voice technology now allow users to customize their personal preferences based on their home environment through a 12-step adjustment process. This calibration process is based on distinct voice zoom levels so as to minimize interference with surrounding sounds.



Six distinct processes contribute to picture improvement. LG's XD Engine® takes the low resolution of analog signals to near HD levels by improving brightness, contrast, detail and enhancing color as well as reducing signal noise.



Dramatization



Dramatization

**USB 2.0 MEDIA HOST**  
26" CLASS  
32" CLASS

USB 2.0 will support JPG and MP3 files from a USB storage device.

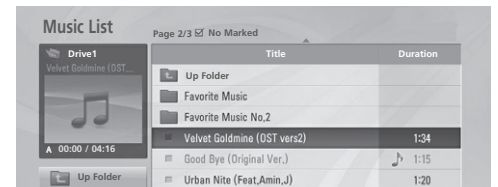
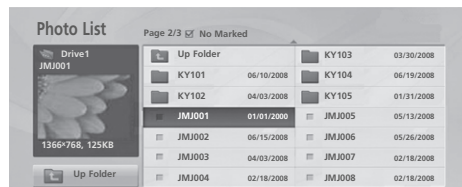
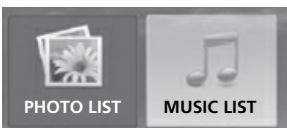

## PUBLIC DISPLAY SETTINGS

When used in public areas, these HDTVs can be easily programmed by the installer to have the TV turn on at a specified channel/volume level, set the minimum/ maximum volume, lock out the control panel/remote, set the aspect ratio, and return to a factory reset. By using Power Management, these displays can be programmed to turn off if there has been no activity (remote or control panel buttons) for a preset time (1-7) hours.

Public Display Setting	
Public Display Mode	No
Start Channel	No
Ch. Type	TV
Major	2
Minor	0
Minimum Volume	0
Maximum Volume	100
Start Volume Level	No
Power Management Setting	20
Key Management	No
Factory Reset	1
Aspect Ratio	0

## USB CLONING

26" CLASS/ 32" CLASS

USB cloning will allow for easy transfer of Public Display Settings from the "Master TV" to an unlimited number of same type televisions.

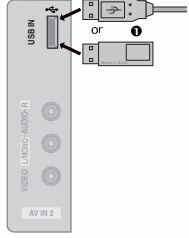

# DIMENSIONS

## invisible SPEAKER

SOUND IS HEARD, NOT SEEN  
Enjoy a combination of smart technology and stylish design with the invisible speaker system custom tuned by audio expert Mr. Mark Levinson. This unique system provides a clean, polished look and an enhanced auditory experience by increasing the sweet spot and providing a wider sound field.



32LD350C  
26LD350C

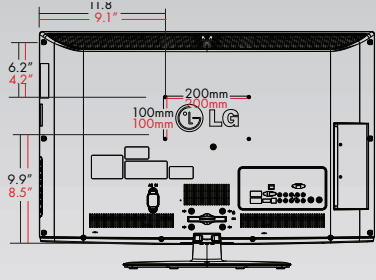
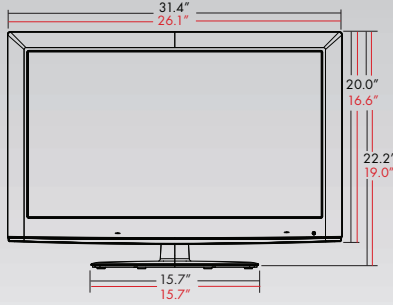

22LD350C

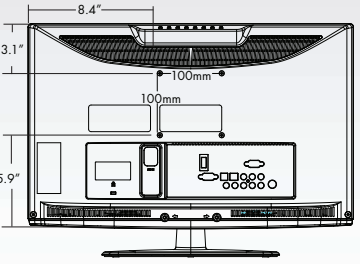
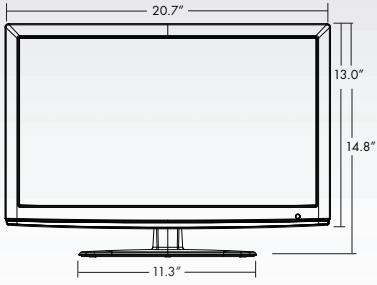

32LD350C  
26LD350C

REAR

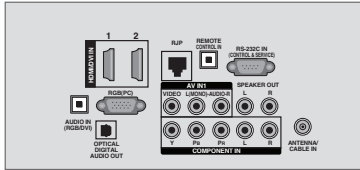

SIDE



22LD350C

REAR

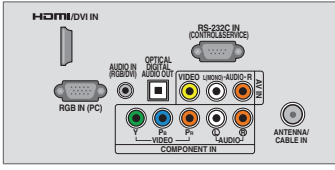

SIDE



## MOUNTING HOLES ON STAND ATTACHING THE TV TO A DESK

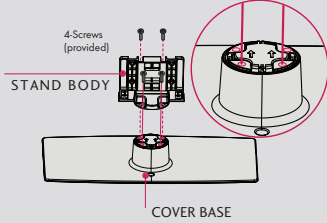

32LD350C  
26LD350C  
22LD350C

32" CLASS (31.5" DIAGONAL)  
26" CLASS (26.0" DIAGONAL)  
22" CLASS (21.6" DIAGONAL)

# SPECIFICATIONS

## LCD SPECIFICATION

Screen Size (Class)	32" class (31.5" diagonal) 26" class (26.0" diagonal) 22" class (21.6" diagonal)
Native Display Resolution	1366 x 768
Dynamic Contrast Ratio	15,000:1 (26", 32"), 8,000:1 (22")
Contrast Ratio	1,200:1
Viewing Angle	178°/178°
Color Reproduction	8 Bit
Response Time	5ms
True Viewing Angle	Yes
Life Span (Typical)	60,000 hrs

## BROADCASTING SYSTEM

Analog	Yes
ATSC/NTSC/Clear QAM	Yes

## VIDEO

XD Engine	Yes
Aspect Ratio	16:9
Aspect Ratio Correction	6 Mode
Just Scan (1:1 Pixel Matching)	
HDMI	1080p/1080i/720p
Component	1080p/1080i/720p
RF/DTV	1080i/720p

Enhanced Noise Reduction (Video Noise Filter)	Yes, 3D NR/MPEG NR
Digital Comb Filter	Yes (3D)
Color Temperature Control	3 Modes (Norm, Warm, Cool)
Black Stretcher	Yes
24p Real Cinema	Yes
Cinema 3:2/2:2 Mode	Yes
Picture Reset	Yes
AV Mode II (Picture & Sound)	3 Modes (Cinema, Sport, Game)
EZ Picture/PSM	Yes (8 modes)
ISFccc Ready	Yes
DTV Signal Strength Indicator	Yes
Video Reset/Initializing	Yes

## AUDIO

Mono/Stereo/Dual (MTS/SAP)	Yes
Audio Output Power (Watts - THD 10%)	14W/7W x 2 (22", 26") 10W x 2W (32")
Invisible Speaker System Details	1 Way 2 Speaker
Dolby Digital 5.1 Decoder	Yes
Surround System Type	SRS TruSurround XT, SRS WOW
Bass/Treble/Balance Controls	Yes
Clear Voice II	Yes
Auto Volume Leveler	Yes
EZ Sound Mode/SSM	5 Modes

## SPECIAL FEATURES

Public Display Settings	Yes, V2.5
Energy Saving Modes	Yes (Minimum, Medium, Maximum)
Brightness Optimization	Yes (Available in Standard, Natural, Sport, Game modes)
Auto-Sensing RJP compatible	Yes (with select RJP versions)
Picture Wizard	Yes
Backlight Control	Yes
USB Cloning	Yes
Mechanical Power Off	Yes
1080p Source Input	
HDMI	60p/30p/24p
Component	60p/30p/24p
RGB	WXGA
A/V Input Navigation	Yes
Input Labeling/Sub-title	Yes
Quick View (Previous Channel)	Yes
Quick Setup Guide	Yes
e-Manual	Yes
Parental Control w/V-Chip	Yes
Key Lock/Child Lock	Yes
Customizable Closed Caption/Sub-title	Yes
LG SIMPLINK™ (HDMI CEC)	Yes

## CONVENIENCE FEATURES

Language	English/Spanish/French/Korean
Alvin UI	Yes
Auto Tuning/Programming	Yes
Channel Add/Delete	Yes
Favorite Channel Programming	Yes
Auto/Manual Clock	Yes
On/Off Timer	Yes
Sleep Timer	Yes
Auto Off/Auto Sleep (When no video is present)	Yes

## AUDIO/VIDEO INPUTS/OUTPUTS

RF In (Antenna/Cable)	1
L/R Audio/Composite Video In	1 (rear), 1 (side except 22")
HD Component Video In (Y, Pb, Pr) + L/R Audio	1
Variable Audio (External Speaker) Out	1 (L/R 2W each)
Digital Audio Out (Optical)	1
HDMI/HDCP Input (V1.3 with Deep Color)	2 (26", 32") 1 (22")
RGB In (D-Sub 15pin) - PC	1 (1360 x 768)
PC Audio Input	1
RS-232c In (Control/Service)	1
USB 2.0 Input	1 (Side) Media Host (JPEG, MP3), Cloning, and Service (26", 32") Service only (22")

Remote Control Port In	1
RJ45 (for RJP interface - non PIP)	Yes (26", 32" only)

## CABINET/ACCESSORIES

Cabinet Color	Glossy Black
Swivel Stand (degrees)	+20°/20°
Fire Retardant Cabinet Material	Yes
Kensington Security System Slot	Yes
VESA® Mount Compliant (WxH)	200mm x 100mm, M4 screw (26", 32") 100mm x 100mm, M4 screw (22")

Remote Control	Yes
----------------	-----

## POWER

Voltage, Hz	100V - 240V, 50/60 Hz
Stand-by Mode (typ.)	0.21W
Power Consumption (typ.)	78W (32"), 60W (26"), 44W (22")
Dynamic Power Savings	Yes
Static Power Savings	Yes

## REQUIRED APPROVALS

ENERGY STAR® 4.1 Qualified	Yes
RoHS Compliant	Yes
UL, cUL, NOM	Yes

## DIMENSIONS & WEIGHT

TV without stand (WxHxD)	20.7" x 13.0" x 2.5" (22") 26.1" x 16.6" x 3.1" (26") 31.4" x 20.0" x 2.9" (32")
TV with stand (WxHxD)	20.7" x 14.8" x 6.4" (22") 26.1" x 19.0" x 8.1" (26") 31.4" x 22.2" x 8.1" (32")
Shipping Dimensions (WxHxD)	25.9" x 16.2" x 5.4" (22") 30.3" x 20.7" x 7.5" (26") 37.9" x 23.6" x 7.5" (32")

TV without stand weight	8.8 lbs (22") 13.6 lbs (26") 18.0 lbs (32")
-------------------------	---

TV with stand weight	9.4 lbs (22") 16.0 lbs (26") 20.2 lbs (32")
----------------------	---

Shipping Weight	12.3 lbs (22") 20.0 lbs (26") 25.3 lbs (32")
-----------------	--

## SERVICE/LIMITED WARRANTY

UPC CODE	2 Years (Parts/Labor)
32LD350C	7 1919290046 2
26LD350C	7 1919290047 9
22LD350C	7 1919290048 6

www.LG.com

LG Electronics U.S.A., Inc.  
Business Solutions Division  
2000 Millbrook Drive  
Lincolnshire, IL 60069

Customer Service: 888.865.3026  
www.LG.com/support

Contact your LG Regional Sales Representative  
Vertical Markets: 800.897.8788  
Channel: 800.897.8871  
Hospitality: 800.228.1236  
E-mail: info@LG.com

SPEC\_LD350C\_121023\_PR



All screen images are simulated. Dimensions and weights are approximate. Design, features and specifications subject to change without notice.

© Copyright 2010 LG Electronics USA, Inc. All Rights Reserved. "LG Life's Good" is a registered trademark of LG Corp. XD Engine is a registered trademark of LG Electronics, Inc. HealthView and EcoSmart are trademarks of LG Corp. Dolby and the double-D symbol are registered trademarks of Dolby Laboratories. SRS and the SRS symbol, TruSurround XT and WOW are trademarks or registered trademarks of SRS Labs, Inc. VESA is a trademark of Video Electronics Standards Association. All other product and brand names are trademarks or registered trademarks of their respective companies.

Printed in the USA, December 2010



**LG**  
Life's Good