

Canon

PUB. DIE-0380-000

Digital Camcorder
Instruction Manual

FS40
FS400



NTSC

Important Usage Instructions

WARNING!

TO REDUCE THE RISK OF FIRE OR ELECTRIC SHOCK, DO NOT EXPOSE THIS PRODUCT TO RAIN OR MOISTURE.

WARNING!

TO REDUCE THE RISK OF ELECTRIC SHOCK AND TO REDUCE ANNOYING INTERFERENCE, USE THE RECOMMENDED ACCESSORIES ONLY.

COPYRIGHT WARNING:

Unauthorized recording of copyrighted materials may infringe on the rights of copyright owners and be contrary to copyright laws.

Digital Video Camcorder FS40 A / FS400 A systems

This device complies with Part 15 of the FCC Rules. Operation is subject to the following two conditions: (1) This device may not cause harmful interference, and (2) this device must accept any interference received, including interference that may cause undesired operation.

Note: This equipment has been tested and found to comply with the limits for class B digital device, pursuant to Part 15 of the FCC Rules. These limits are designed to provide reasonable protection against harmful interference in a residential installation. This equipment generates, uses and can radiate radio frequency energy and, if not installed and use in accordance with the instructions, may cause harmful interference to radio communications. However, there is no guarantee that interference will not occur in a particular installation. If this equipment does cause harmful interference to radio or television reception, which can be determined by turning the equipment off and on, the user is encouraged to try to correct the interference by one or more of the following measures:

- Reorient or relocate the receiving antenna.
- Increase the separation between the equipment and receiver.
- Connect the equipment into an outlet on a circuit different from that to which the receiver is connected.
- Consult the dealer or an experienced radio/TV technician for help.

Use of shielded cable is required to comply with class B limits in Subpart B of Part 15 of FCC Rules. Do not make any changes or modifications to the equipment unless otherwise specified in the manual. If such changes or modifications should be made, you could be required to stop operation of the equipment.

Canon U.S.A., Inc.
One Canon Plaza, Lake Success, NY 11042, U.S.A.
Tel No. (516)328-5600

CAUTION:

TO PREVENT ELECTRIC SHOCK, MATCH WIDE BLADE OF PLUG TO WIDE SLOT, FULLY INSERT.

WARNING:

To reduce the risk of electric shock, do not expose this product to dripping or splashing.

The Mains plug is used as the disconnect device. The Mains plug shall remain readily operable to disconnect the plug in case of an accident.

CAUTION:

- Danger of explosion if the wrong type of batteries are attached. Use only the same type of batteries.
- Do not expose batteries or product to excessive heat such as the inside of a car under direct sunlight, fire, etc.

Important Warning**CAUTION:**

TO REDUCE THE RISK OF ELECTRIC SHOCK, DO NOT REMOVE COVER (OR BACK). NO USER-SERVICEABLE PARTS INSIDE. REFER SERVICING TO QUALIFIED SERVICE PERSONNEL.



The lightning flash with arrowhead symbol, within an equilateral triangle, is intended to alert the user to the presence of uninsulated "dangerous voltage" within the product's enclosure, that may be of sufficient magnitude to constitute a risk of electric shock to persons.



The exclamation point, within an equilateral triangle, is intended to alert the user to the presence of important operating and maintenance (servicing) instructions in the literature accompanying the product.

IMPORTANT SAFETY INSTRUCTIONS

In these safety instructions the word “product” refers to the Canon Digital Video Camcorder FS40 A / FS400 A and all its accessories.

- 1 Read these instructions.
- 2 Keep these instructions.
- 3 Heed all warnings.
- 4 Follow all instructions.
- 5 Do not use this apparatus near water.
- 6 Clean only with dry cloth.
- 7 Do not install near any heat sources such as radiators, heat registers, stoves, or other apparatus (including amplifiers) that produce heat.
- 8 Do not defeat the safety purpose of the polarized or grounding-type plug. A polarized plug has two blades with one wider than the other. A grounding type plug has two blades and a third grounding prong. The wide blade or the third prong are provided for your safety. If the provided plug does not fit into your outlet, consult an electrician for replacement of the obsolete outlet.
- 9 Protect the power cord from being walked on or pinched particularly at plugs, convenience receptacles, and the point where they exit from the apparatus.
- 10 Only use attachments/accessories specified by the manufacturer.
- 11 Unplug this apparatus during lightning storms or when unused for long periods of time.
- 12 Refer all servicing to qualified service personnel. Servicing is required when the apparatus has been damaged in any way, such as power-supply cord or plug is damaged, liquid has been spilled or objects have fallen into the apparatus, the apparatus has been exposed to rain or moisture, does not operate normally, or has been dropped.
- 13 Read Instructions — All the safety and operating instructions should be read before the product is operated.
- 14 Retain Instructions — The safety and operating instructions should be retained for future reference.
- 15 Heed Warnings — All warnings on the product and in the operating instructions should be adhered to.
- 16 Follow Instructions — All operating and maintenance instructions should be followed.
- 17 Cleaning — Unplug this product from the wall outlet before cleaning. Do not use liquid or aerosol cleaners. The product should be cleaned only as recommended in this manual.
- 18 Accessories — Do not use accessories not recommended in this manual as they may be hazardous.
- 19 Avoid magnetic or electric fields — Do not use the camera close to TV transmitters, portable communication devices or other sources of electric or magnetic radiation. They may cause picture interference, or permanently damage the camera.
- 20 Water and Moisture — Hazard of electric shock — Do not use this product near water or in rainy/moist situations.

- 21 **Placing or Moving** — Do not place on an unstable cart, stand, tripod, bracket or table. The product may fall, causing serious injury to a child or adult, and serious damage to the product. A product and cart combination should be moved with care. Quick stops, excessive force, and uneven surfaces may cause the product and cart combination to overturn.



- 22 **Power Sources** — The CA-570 Compact Power Adapter should be operated only from the type of power source indicated on the marking label. If you are not sure of the type of power supply to your home, consult your product dealer or local power company. Regarding other power sources such as battery power, refer to instructions in this manual.
- 23 **Polarization** — The CA-570 Compact Power Adapter is equipped with a polarized 2-prong plug (a plug having one blade wider than the other). The 2-prong polarized plug will fit into the power outlet only one way. This is a safety feature. If you are unable to insert the plug fully into the outlet, try reversing the plug. If the plug still fails to fit, contact your electrician to replace your obsolete outlet. Do not defeat the safety purpose of the polarized plug.
- 24 **Power Cord Protection** — Power cords should be routed so that they are not likely to be walked on or pinched by items placed upon or against them. Pay particular attention to plugs and the point from which the cords exit the product.

- 25 **Outdoor Antenna Grounding** — If an outside antenna is connected to the product, be sure the antenna is grounded so as to provide some protection against voltage surges and built-up static charges. Section 810 of the National Electrical Code, ANSI / NFPA No. 70—1984, provides information with respect to proper grounding of the mast and supporting structure, grounding of the lead-in wire to an antenna discharge unit, size of grounding conductors, location of antenna discharge unit, connection to grounding electrodes, and requirements for the grounding electrode. See figure 1.

Fig. 1 EXAMPLE OF ANTENNA GROUNDING AS PER NATIONAL ELECTRICAL CODE

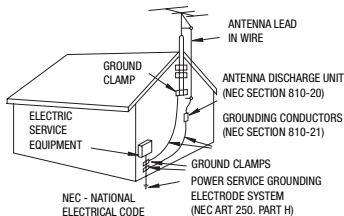

- 26 **Lightning** — For added protection of this product during a lightning storm, or when it is left unattended and unused for long periods of time, disconnect it from the wall outlet and disconnect the antenna. This will prevent damage to the product due to lightning and power-line surges.
- 27 **Overloading** — Do not overload wall outlets and extension cords as this can result in a risk of fire or electric shock.
- 28 **Objects and Liquid Entry** — Never push objects of any kind into this product through openings as they may touch dangerous voltage points or short out parts that could result in a fire or electric shock. Be careful not to spill liquid of any kind onto the product.
- 29 **Servicing** — Do not attempt to service this product yourself as opening or removing covers may expose you to dangerous voltage or other hazards. Refer all servicing to qualified service personnel.

- 30 **Damage Requiring Service** — Disconnect this product from the wall outlet and all power sources including battery, and refer servicing to qualified service personnel under the following conditions:
- When the power-supply cord or plug is damaged.
 - If any liquid has been spilled onto, or objects have fallen into, the product.
 - If the product has been exposed to rain or water.
 - If the product does not operate normally even if you follow the operating instructions. Adjust only those controls that are covered by the operation instructions. Improper adjustment of other controls may result in damage and will often require extensive work by a qualified technician to restore the product to its normal operation.
 - If the product has been dropped or the cabinet has been damaged.
 - When the product exhibits a distinct change in performance. This indicates a need for service.
- 31 **Replacement Parts** — When replacement parts are required, be sure the service technician has used replacement parts that are specified by Canon or that have the same characteristics as the original part. Unauthorized substitutions may result in fire, electric shock or other hazards.
- 32 **Safety Check** — Upon completion of any service or repairs to this product, ask the service technician to perform safety checks to determine that the product is in safe operating order.
- 33 **Heat** — The product should be situated away from heat sources such as radiators, heat registers, stoves, or other products (including amplifiers) that produce heat.

When replacement of the power supply is required, please return it to the responsible nearest Canon Service Center and please replace it with the same type number CA-570.

CA-570 identification plate is located on the bottom.

The Adapter can be used with a power supply between 100 and 240 V AC. For areas where 120 V AC power is not used, you will need a special plug adapter. Contact your nearest Canon Service Center for further information.

This Class B digital apparatus complies with Canadian ICES-003.

Trademark Acknowledgements

- SD, SDHC and SDXC Logos are trademarks of SD-3C, LLC.
- Microsoft and Windows are trademarks or registered trademarks of Microsoft Corporation in the United States and/or other countries.
- Macintosh and Mac OS are trademarks of Apple Inc., registered in the U.S. and other countries.
- Manufactured under license from Dolby Laboratories.
"Dolby" and the double-D symbol are trademarks of Dolby Laboratories.
- Other names and products not mentioned above may be trademarks or registered trademarks of their respective companies.
- This device incorporates exFAT technology licensed from Microsoft.
- ANY USE OF THIS PRODUCT OTHER THAN CONSUMER PERSONAL USE IN ANY MANNER THAT COMPLIES WITH THE MPEG-2 STANDARD FOR ENCODING VIDEO INFORMATION FOR PACKAGED MEDIA IS EXPRESSLY PROHIBITED WITHOUT A LICENSE UNDER APPLICABLE PATENTS IN THE MPEG-2 PATENT PORTFOLIO, WHICH LICENSE IS AVAILABLE FROM MPEG LA, L.L.C., 250 STEELE STREET, SUITE 300, DENVER, COLORADO 80206.



Exciting Features

Whether you are using a camcorder for the first time or are very experienced, this camcorder offers many easy-to-use functions. The following are just but a few examples of the many functions that can enrich your shooting experience.



FS40
Dual Flash Memory

You can record in the built-in memory or on commercially available memory cards (📖 35).



Pre-recording
(📖 54)

When pre-recording is activated, the camcorder starts recording video continuously into a temporary 3-second memory. When you press the **Start/Stop** button, the scene recorded will have started 3 seconds before you started shooting.



Video Snapshot
(📖 55)

Shoot or capture short scenes and arrange them into a video clip set to your favorite background music.



Image Stabilization
(📖 54)

Dynamic IS compensates for camcorder shake when you shoot video while walking. This gives you more freedom and mobility when recording movies.

Table of contents

■ Introduction

- 8 Exciting Features
- 12 About this Manual
- 14 Getting to Know the Camcorder**
- 14 Supplied Accessories and CD-ROMs
- 16 Names of Parts

■ Preparations

- 19 Getting Started**
- 19 Charging the Battery Pack
- 22 Preparing the Accessories
- 23 Adjusting the Position and Brightness of the LCD Screen
- 25 Basic Operation of the Camcorder**
- 25 Operating Modes
- 27 Joystick and Joystick Guide
- 27 Using the Menus
- 30 First Time Settings**
- 30 Setting the Date and Time
- 31 Changing the Language
- 31 Changing the Time Zone
- 32 Using a Memory Card**
- 32 Memory Cards Compatible for Use with the Camcorder
- 34 Inserting and Removing a Memory Card
- 35 **FS40** Selecting the Memory for the Recordings
- 35 Initializing the Memory

■ Video

38 Basic Recording

- 38 Shooting Video
- 39 Selecting the Video Quality (Recording Mode)
- 40 Zooming: Optical, Advanced and Digital Zoom
- 41 Quick Start Function

43 Basic Playback

- 43 Playing Back Video
- 45 Selecting what Recordings to Play Back
- 46 Searching for Scenes
- 48 Pre-selecting Recordings from the Index Screen
- 49 Deleting Scenes

51 Advanced Functions

- 51 Automatic Exposure and Special Scene Recording Programs
- 53 Automatic Backlight Correction
- 54 Advanced Image Stabilization
- 54 Pre-Recording
- 55 Video Snapshot
- 56 Digital Effects
- 57 Manual Exposure Adjustment
- 58 Manual Focus Adjustment
- 59 White Balance
- 60 Image Effects
- 61 Mini Video Light
- 61 Self Timer
- 62 Selecting the Playback Starting Point
- 63 Playing Back Recordings Set to Background Music
- 66 On-Screen Displays and Data Code

67 Playlist and Scene Operations

- 67 Editing the Playlist: Adding, Deleting and Moving Scenes
- 69 Dividing Scenes
- 70 **FS40** Copying Scenes to a Memory Card

■ Photos

- 73 Taking Photos
- 74 Viewing Photos
- 76 Slideshow
- 76 Deleting Photos
- 78 **FS40** Copying Photos to a Memory Card

■ External Connections

- 80 Terminals on the Camcorder**
 - 80 Connection Diagrams
- 82 Playback on a TV Screen**
- 83 Saving and Sharing Your Recordings**
 - 83 Saving Recordings on a Computer
 - 85 Copying Movies to an External Video Recorder
 - 86 Preparing Movies for the Web





■ Additional Information

- 90 Appendix: Menu Options Lists**
 - 90 FUNC. Menu
 - 92 Setup Menus
 - 98 Onscreen Icons and Displays
- 102 Trouble?**
 - 102 Troubleshooting
 - 107 List of Messages
- 114 Do's and Don'ts**
 - 114 Handling Precautions
 - 118 Maintenance/Others
 - 119 Using the Camcorder Abroad
- 120 General Information**
 - 120 Accessories
 - 121 Optional Accessories
 - 123 Product Codes
 - 124 Specifications
 - 128 Index

About this Manual

Thank you for purchasing the Canon FS40 / FS400. Please read this manual carefully before you use the camcorder and retain it for future reference. Should your camcorder fail to operate correctly, refer to *Troubleshooting* (📖 102).

Conventions Used in this Manual

-  **IMPORTANT:** Precautions related to the camcorder's operation.
-  **NOTES:** Additional topics that complement the basic operating procedures.
-  **POINTS TO CHECK:** Restrictions or requirements regarding the function described.
-  Reference page number within this manual.
- **FS40:** Text that applies only to the model shown in the icon.
- The following terms are used in this manual:
When not specified as “memory card” or “built-in memory”, the term “memory” by itself refers to both.
“Scene” refers to one movie unit from the point you press the  button to start recording until you press again to pause the recording.
- The photos included in this manual are simulated pictures taken with a still camera. Unless indicated otherwise, illustrations and menu icons refer to the **FS40**.

Selecting the Video Quality (Recording Mode)

The camcorder offers 3 recording modes. Changing the recording mode will change the recording time available on the memory. Select XP mode for better movie quality; select LP mode for longer recording times. The following table gives approximate recording times.

Operating modes:



[FUNC.] → [SP Standard Play 6 Mbps] → Desired recording mode → [FUNC.]

NOTES



- The camcorder uses a variable bit rate (VBR) to encode video so the actual recording times will vary depending on the content of the scenes.
- The camcorder retains the last setting used even if you set the camcorder to **AUTO** mode.

Brackets [] are used to refer to menu options as they are displayed on screen.

The names of most buttons and switches are indicated within a "button" frame.

For example .

The  arrow is used to abbreviate menu selections. For a detailed explanation on how to use the menus, refer to *Using the Menus* (□ 27). For a concise summary of all available menu options and settings, refer to the appendix *Menu Options Lists* (□ 90).

 indicates that a function is available in the operating mode indicated and  indicates that the function is not available. For a detailed explanation refer to *Operating Modes* (□ 25).

Supplied Accessories and CD-ROMs

The following accessories are supplied with the camcorder:

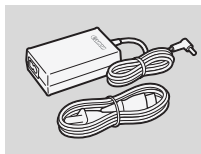

▶ CA-570 Compact Power Adapter
(incl. power cord)



◀ BP-808 Battery Pack



▶ IFC-300PCU/S USB Cable

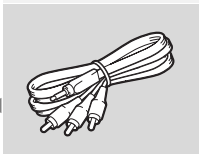

◀ STV-250N Stereo Video Cable
Yellow • Red • White plugs

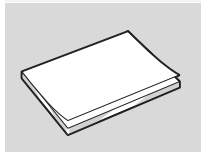

▶ Quick Guide

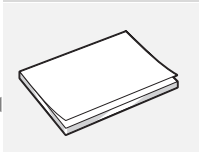

◀ Installation Guide for PIXELA's
Software

The following CD-ROMs and software are supplied with the camcorder:

- **PIXELA's Transfer Utility** CD-ROM*
 - Use **Transfer Utility** for saving and transferring movies and music files you can use as background music.
 - **PIXELA's VideoBrowser** CD-ROM*
 - In addition to all the functionality of **Transfer Utility**, you can use **VideoBrowser** for managing, editing, and playing back movies.
 -  **Instruction Manual/Music Data** CD-ROM (referred to in this manual as "Camcorder Supplemental Disc")
 - Instruction Manual - The full-version instruction manual of the camcorder (this PDF file).
 - Music data - Music files that can be used as background music during playback. These music files are for exclusive use with the supplied **PIXELA's** software. The disc cannot be played back on CD players.
- * The CD-ROM includes the instruction manual of the software (on PDF file).

Names of Parts

Left side view

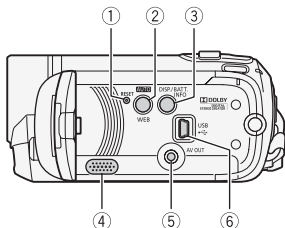

- ① RESET button (106)
- ② **AUTO** button (25)/
WEB button (86)
- ③ DISP. (on-screen display) button
(62, 66)/BATT. INFO button
(101)
- ④ Speaker (43)
- ⑤ AV OUT terminal (80, 81)
- ⑥ USB terminal (80, 81)
- ⑦ DC IN terminal (19)
- ⑧ ACCESS indicator (38, 73)
- ⑨ Strap mount (22)
- ⑩ Grip belt (22)
- ⑪ Stereo microphone
- ⑫ Mini video light (61)

Right side view

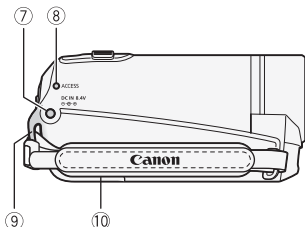

Front view

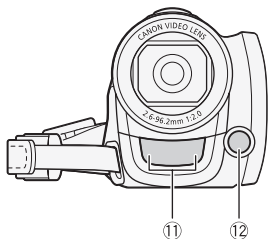

Top view

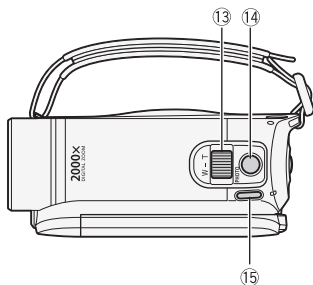

- ⑬ Zoom lever (40)
- ⑭ PHOTO button (73)
- ⑮ POWER button
- ⑯ Joystick (27)
- ⑰ LCD screen (23)
- ⑱ FUNC. button (28, 90)
- ⑲ ►/|| (play/pause) button (43)/
START/STOP button (38)
- ⑳ ■ (stop) button (43)/
PLAYLIST button (46)
- ㉑ VIDEO SNAP (video snapshot) button
(55)
- ㉒ ◀▶ (camera/play) button (26)
- ㉓ ON/OFF (CHG) (charge) indicator:
Green – On
Orange – Standby (41)
Red – Charging (19)
- ㉔ Start/Stop button (38)

LCD panel

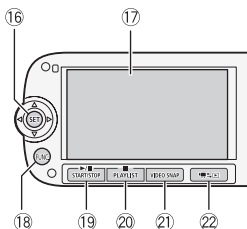

Back view

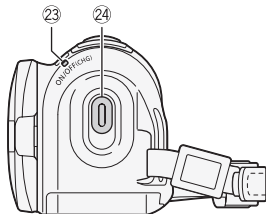

Bottom view

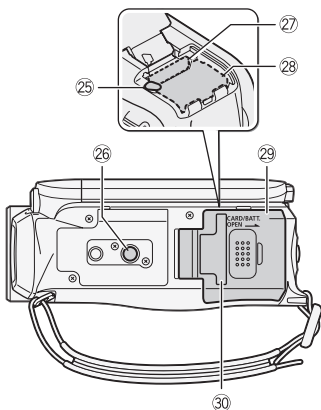

- ②5 Battery release latch
- ②6 Tripod socket (114)
- ②7 Memory card slot (34)
- ②8 Battery compartment (19)
- ②9 Battery compartment cover/Memory card slot cover
- ③0 Serial number
The serial number label is located on the battery compartment cover.

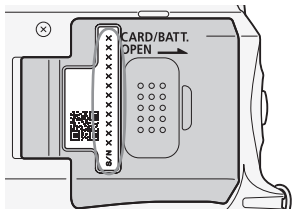



Preparations

This chapter describes basic operations, such as navigating the menus, and first time settings to help you learn more about your camcorder.

Getting Started

Charging the Battery Pack

The camcorder can be powered with a battery pack or directly using the compact power adapter. The first time you use a battery pack, fully charge it and then use the camcorder until the battery pack is completely exhausted. Doing so will ensure that the remaining recording time will be displayed accurately.

For approximate charging times and recording/playback times with a fully charged battery pack, refer to *Charging, Recording and Playback Times* (□ 122).

- 1 Slide the battery compartment cover away from the lens and open it.
- 2 Insert the battery pack all the way into the compartment and press gently until it clicks.

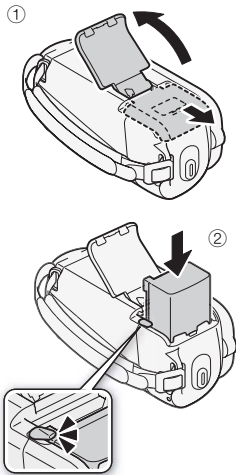

- 3 Close the cover and slide it toward the lens until you hear a click.
 - 4 Connect the power cord to the compact power adapter.
 - 5 Plug the compact power adapter into a power outlet.
 - 6 Connect the compact power adapter to the camcorder's DC IN terminal.
- 7 **Charging will start when the camcorder is turned off.**

- If the camcorder was on, the green ON/OFF (CHG) indicator will go out when you turn off the camcorder. After a moment, the ON/OFF (CHG) indicator will start flashing in red (battery pack charging). The red ON/OFF (CHG) indicator will go out when the battery pack is fully charged.
- If the indicator flashes quickly, refer to *Troubleshooting* (□ 102).

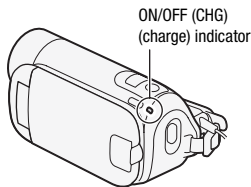
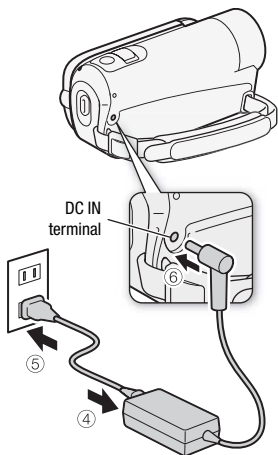
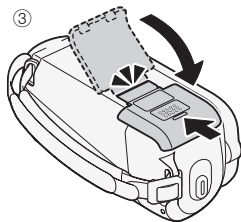

To remove the battery pack

- 1 Slide the battery compartment cover away from the lens and open it.
- 2 Press the battery release latch and pull out the battery pack.
- 3 Close the cover and slide it toward the lens until you hear a click.

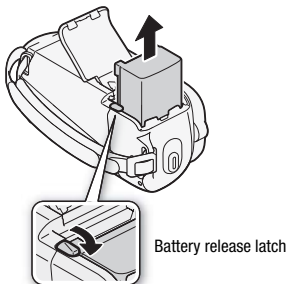

! IMPORTANT

- Turn off the camcorder before connecting or disconnecting the compact power adapter. After pressing **[POWER]** to turn off the camcorder, important data is updated in the memory. Be sure to wait until the green ON/OFF (CHG) indicator goes out.
- We recommend charging the battery pack in temperatures between 10 °C and 30 °C (50 °F and 86 °F). Outside the temperature range of 0 °C to 40 °C (32 °F to 104 °F), charging will not start.
- Do not connect to the camcorder's DC IN terminal or to the compact power adapter any electrical equipment that is not expressly recommended for use with this camcorder.
- To prevent equipment breakdowns and excessive heating, do not connect the supplied compact power adapter to voltage converters for overseas travels or special power sources such as those on aircraft and ships, DC-AC inverters, etc.

i NOTES

- The battery pack will be charged only when the camcorder is off.
- If remaining battery time is an issue, you can power the camcorder using the compact power adapter so the battery pack will not be consumed.
- Charged battery packs continue to discharge naturally. Therefore, charge them on the day of use, or the day before, to ensure a full charge.

- We recommend that you prepare battery packs to last 2 to 3 times longer than you think you might need.
- **USA and Canada only:** The Lithium ion/polymer battery that powers the product is recyclable. Please call 1-800-8-BATTERY for information on how to recycle this battery.



Preparing the Accessories

Fasten the grip belt.

Adjust the grip belt so that you can reach the zoom lever with your index finger, and the **Start/Stop** button with your thumb.

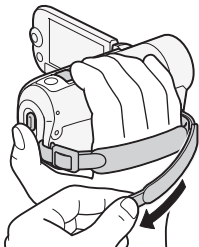

To remove the grip belt

- 1 Lift the padded handgrip's flap and detach the strap from the Velcro pad. Pull the strap to remove it from the camcorder's front bracket.
- 2 Pull the other end of the strap through the buckle and remove it from the camcorder's rear bracket.

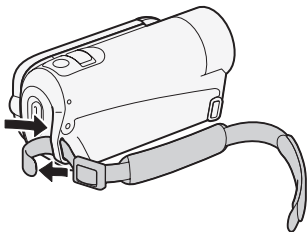
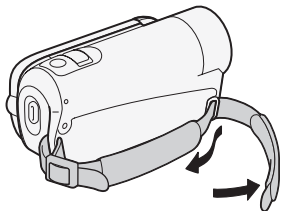

To attach an optional wrist strap

Pass the attaching end of the wrist strap through the rear bracket on the camcorder, thread the wrist strap through the loop and fasten.

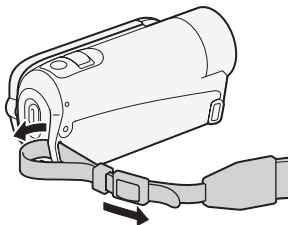

Adjusting the Position and Brightness of the LCD Screen

Rotating the LCD Panel

Open the LCD panel 90 degrees.

- You can rotate the panel 90 degrees downward.
- You can rotate the panel 180 degrees toward the lens. Rotating the LCD panel 180 degrees can be useful when you wish to include yourself in the picture when recording with the self timer.

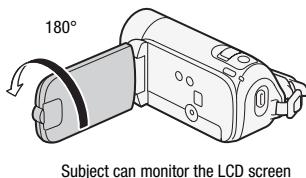
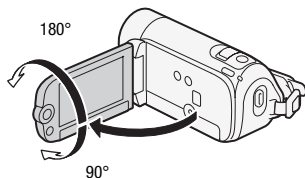

NOTES

- **About the LCD screen:** The screen is produced using extremely high-precision manufacturing techniques, with more than 99.99% of the pixels operating to specification. Less than 0.01% of the pixels may occasionally misfire or appear as black, red, blue or green dots. This has no effect on the recorded image and does not constitute a malfunction.

LCD Backlight

When recording in bright places it may be difficult to use the LCD screen. Turn on the LCD backlight to make it brighter.

With the camcorder on, hold  pressed down for more than 2 seconds.

Repeat this action to switch the LCD backlight between off (normal) and on (bright).

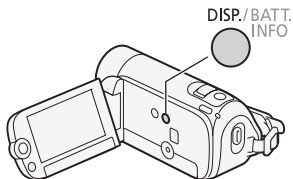



NOTES

- The LCD backlight does not affect the brightness of the recordings.
- Using the bright setting will shorten the effective usage time of the battery pack.
- You can further adjust the brightness of the LCD screen with the  [LCD Brightness] setting.



Basic Operation of the Camcorder

Operating Modes

Recording

The camcorder offers two basic modes for recording video and photos: **AUTO** mode, for beginners or if you just prefer not to bother with detailed camcorder settings, and flexible recording () mode, which lets you change the camcorder's settings to your preference. Press the **AUTO** button to switch the camcorder to **AUTO** mode and press the button again to switch back to  mode. In either mode, you can record movies by pressing **Start/Stop** or take photos by pressing **PHOTO**.







Operating mode	Onscreen icon	Operation
AUTO	 AUTO	Easy recording of movies and photos.
		Recording of movies and photos while enjoying full access to the menus and advanced functions.

About **AUTO** mode



- Only the following buttons/functions are available in this mode.
 - **Start/Stop** for recording movies
 - **PHOTO** for recording photos
 - Zoom (□ 40)
 - Quick Start (□ 41)
 - **VIDEO SNAP** for recording video snapshot scenes (□ 55)



NOTES

- In **AUTO** mode, menus cannot be accessed but the following settings can be changed in advance.
 - FUNC. menu: Recording mode of movies.



-  menu: [Rec Media for Movies]*, [Rec Media for Photos]*, [Widescreen], [Video Snapshot Length].
-  menu: [Image Stabilizer]**, [Auto Slow Shutter].
- ,  and  menus: All settings.

* **FS40** only.





** The [ Standard] setting will be used in **AUTO** mode if set to [**OFF** Off] in  mode.

- Even in  mode, the camcorder can help you with the settings. For example, you can use the Special Scene recording programs ( 51) to set at once all the optimal settings to match special recording conditions.



Playback

Press the  (camera/play) button to switch the camcorder between camera (recording) mode and playback mode. You can press  when the camcorder is off to turn it on directly in playback mode.



Operating mode	Onscreen icon	Operation
		Playing back movies.
		Viewing photos.

NOTES

- When switching to playback mode, the [Movies] index screen will be selected ( mode). Use the tabs on the top of the screen to switch to  mode to view photos ( 45).
- **FS40** When switching to playback mode, the memory selected for playback will be the same currently used for recording movies.

Joystick and Joystick Guide

Use the joystick to operate the camcorder's menus.

Push the joystick up, down, left or right (▲▼, ◀▶) to select an item or change settings.

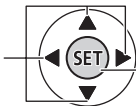

Press the joystick itself (SET) to save the settings or confirm an action. On menu screens, this is indicated by the icon **SET**.

The functions that appear in the joystick guide depend on the operating mode. By default, the joystick guide is minimized. Push the joystick (▲) to display it.

- or mode: Select (▲▼) a function and press (SET) to change the setting. With some functions, you will need to make further adjustments (◀▶).
- mode: First, select (▲▼) a "row" of functions; then, press (SET) to operate the function in the middle or push the joystick (◀ or ▶) to operate the function on the left or right, respectively.

The joystick guide will minimize after 2 seconds. When the joystick guide is minimized, you can still adjust or turn on/off the selected function; you can also maximize (▲) the joystick guide to select another function, or hide (▼) it altogether.

Using the Menus

Many of the camcorder's functions can be adjusted from the menus that open after pressing **FUNC.** In **AUTO** mode, however, menus cannot be accessed and, except in a few cases, most menu settings will return to their default values.

For details about the available menu options and settings, refer to the appendix *Menu Options Lists* (□ 90).

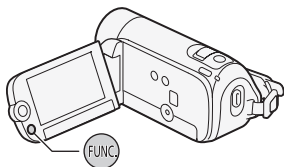

Selecting an Option from the FUNC. Menu

The following is an example of selecting a FUNC. menu option in  mode. In playback modes, the operation varies depending on the function selected so refer to the relevant chapter as necessary.

1 Press **[FUNC.]**.

2 Select (**▲▼**) the icon of the function you want to change from the left side column.

Menu items not available will appear grayed out.

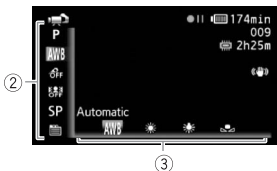

3 Select (**◀▶**) the desired setting from the available options at the bottom bar.

- The selected option will be highlighted in orange.
- With some settings you will need to make further selections and/or press **[SET]**. Follow the additional operation guides that will appear on the screen (such as the **[SET]** icon, small arrows, etc.).

4 Press **[FUNC.]** to save the settings and close the menu.

You can press **[FUNC.]** to close the menu at any time.

Selecting an Option from the Setup Menus

1 Press **[FUNC.]**.

2 Select (**▲▼**) **[Menu]** and press **[SET]** to open the setup menus.

You can also hold **[FUNC.]** pressed down for more than 1 second to open directly the setup menus screen.



3 Select (**◀▶**) the tab of the desired menu.

4 Select (**▲▼**) the setting you want to change and press **[SET]**.

- The orange selection bar indicates the menu setting currently selected. Menu items not available appear grayed out.
- Move (**▲▼**) the orange selection bar to the tabs at the top of the screen to select a different menu (step 3).

5 Select (**▲▼**, **◀▶**) the desired option and press **[SET]** to save the setting.

6 Press **FUNC.**.

You can press **FUNC.** to close the menu at any time.

First Time Settings

Setting the Date and Time

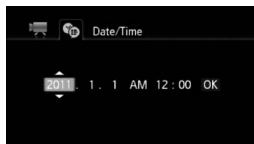

You will need to set the date and time of the camcorder before you can start using it. The [Date/Time] screen will appear automatically when the camcorder's clock is not set.

When the [Date/Time] screen appears, the year will be selected.



- 1 Change (▲▼) the year and move (▶) to the month.
- 2 Change the rest of the fields (month, day, hour and minutes) in the same way.
- 3 Select (▶) [OK] and press (SET) to start the clock and close the setup screen.

NOTES

- When you do not use the camcorder for about 3 months, the built-in rechargeable lithium battery may discharge completely and the date and time setting may be lost. In such case, recharge the built-in lithium battery (□ 117) and set the time zone, date and time again.
- The date appears in a year-month-day format only in the first setup screen. In subsequent screen displays the date and time will appear as month-day-year (for example, [Jan. 1, 2011 12:00 AM]). You can change the date format and the clock format (12/24 hours) with the   [Date Format] setting.
- You can also change the date and time later on (not during the initial setup). Open the [Date/Time] screen from the setup menus:



[FUNC.]   [Menu]    [Date/Time]

Changing the Language

The default language of the camcorder is English. You can set it to one of 26 other languages.

Cesky	Melayu	Русский
Dansk	Nederlands	Українська
Deutsch	Norsk	العربية
Ελληνικά	Polski	فارسی
English	Português	ภาษาไทย
Español	Română	简体中文
Français	Suomi	繁體中文
Italiano	Svenska	한국어
Magyar	Türkçe	日本語

Operating modes: **AUTO**  |  

FUNC. > [Menu] >  > [Language ] >
Desired language > **FUNC.**

NOTES

- The displays **SET** and **FUNC.** that appear in some menu screens refer to the name of buttons on the camcorder and will not change, regardless of the language selected.

Changing the Time Zone

Change the time zone to match your location. The default setting is New York.

Operating modes: **AUTO**  |  

To set the home time zone

FUNC. > [Menu] >  > [Time Zone/DST] > * >
Your local time zone** > **FUNC.**

* When you travel, select (▼) the  icon and select the time zone that matches the local time at your destination.



**To adjust for daylight saving time, select the area name marked with a .

Using a Memory Card

Memory Cards Compatible for Use with the Camcorder

You can use commercially available Secure Digital (SD) cards with this camcorder. However, depending on the memory card, you may not be able to record movies. Refer to the table below.

As of May 2010, the movie recording function has been tested using SD/SDHC memory cards made by Panasonic, Toshiba and SanDisk, and SDXC memory cards made by Panasonic and Toshiba.

Memory card	Capacity	SD Speed Class	Recording movies
 SD memory cards	64 MB or less	—	—
	128 MB or more	—	●*
CLASS②, CLASS④, CLASS⑥, CLASS⑩		●	
 SDHC memory cards	Over 2 GB	CLASS②, CLASS④, CLASS⑥, CLASS⑩	●
 SDXC memory cards	Over 32 GB	CLASS④, CLASS⑥, CLASS⑩	●

* Depending on the memory card used, it may not be possible to record movies.

NOTES

- **About the SD Speed Class:** The SD Speed Class is a standard that indicates the minimum guaranteed data transfer speed of SD/SDHC/SDXC memory cards. When you buy a new memory card, look for the Speed Class logo on the package.

SDXC Memory Cards

As of May 2010, SDXC memory cards have been tested to work under Windows 7. For details on whether your computer's operating system is SDXC-compatible, check with your computer's manufacturer.

IMPORTANT

- If you use an SDXC memory card with a computer OS that is not SDXC-compatible, you may be prompted to format the memory card. In such case, **cancel the operation to prevent data loss.**
- To use an SDXC memory card with external devices, such as card readers or digital recorders, make sure the external device is SDXC-compatible.
- After repeatedly recording, deleting and editing scenes (fragmented memory), it will take longer to write data on the memory and recording may stop. Save your recordings and initialize the memory.

Eye-Fi cards

This product is not guaranteed to support Eye-Fi card functions (including wireless transfer). In case of an issue with an Eye-Fi card, please check with the card manufacturer.

Also note that an approval is required to use Eye-Fi cards in many countries or regions. Without approval, use of the card is not permitted. If it is unclear whether the card has been approved for use in the area, please check with the card manufacturer.

Inserting and Removing a Memory Card

Make sure to initialize (☞ 35) all memory cards before using them with this camcorder.

1 Turn off the camcorder.

Make sure the ON/OFF (CHG) indicator is off.

2 Slide the memory card slot cover away from the lens and open it.

3 Insert the memory card straight, with the label facing away from the lens, all the way into the memory card slot until it clicks.

4 Close the cover and slide it toward the lens until you hear a click.

Do not force the cover closed if the memory card is not correctly inserted.

To remove the memory card

Push the memory card once to release it. When the memory card springs out, pull it all the way out.

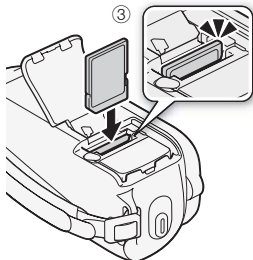
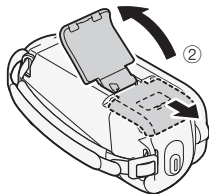

! IMPORTANT

- Memory cards have front and back sides that are not interchangeable. Inserting a memory card facing the wrong direction can cause a malfunction of the camcorder. Be sure to insert the memory card as described in step 3.









FS40 Selecting the Memory for the Recordings

You can select to record your movies and photos in the built-in memory or on a memory card. The built-in memory is the default memory for recording both.

Operating modes:   |  

POINTS TO CHECK

- Be sure you understand the information provided in *Eye-Fi cards* (□ 33) before using an Eye-Fi card.

   Menu    [Rec Media for Movies] or [Rec Media for Photos]  [Built-in Mem.] (built-in memory) or [Mem. Card] (memory card)*  

* When selecting the memory, you can check the total, used and approximate available recording time/number of photos. (Recording time is estimated based on the recording mode currently in use.)

Initializing the Memory

Initialize memory cards when you use them with this camcorder for the first time. You can also initialize a memory card or the built-in memory (**FS40** only) to permanently delete all the recordings it contains.

FS40 At the time of purchase, the built-in memory comes pre-initialized and contains music files for use as background music during playback.

Operating modes:   |  

1 Power the camcorder using the compact power adapter.

Do not disconnect the power source or turn off the camcorder until the initialization is completed.

2 Initialize the memory.

FUNC. ➤ [Menu] ➤ [Initialize] ➤ [Built-in Mem.] or [Mem. Card] ➤ Initialization method ➤ [Yes]* ➤ [OK] ➤ FUNC.

FUNC. ➤ [Menu] ➤ [Initialize] ➤ Initialization method ➤ [Yes]* ➤ [OK] ➤ FUNC.

* If you selected the [Complete Initialization] option, you can press **SET** to cancel the initialization while it is in progress. All recordings will be erased and the memory can be used without any problem.

Options

[Quick Initialization] Clears the file allocation table but does not physically erase the stored data.

[Complete Initialization] Erases all data completely.

! IMPORTANT

- Initializing the memory will permanently erase all recordings. Lost original recordings cannot be recovered. Make sure you save important recordings in advance using an external device (□ 83).
- Initializing a memory card will permanently erase any music files you may have transferred to the card. (**FS40**) The music files that come pre-installed in the built-in memory will be restored after it is initialized.) To transfer music files from the supplied Camcorder Supplemental Disc to the memory card:
 - Windows users: Use the supplied PIXELA's software. For details, refer to the Software Guide (PDF file) of the supplied PIXELA's software.
 - Mac OS users: Use Finder to transfer the music files from the [MUSIC] folder on the supplied Camcorder Supplemental Disc to the memory card. Refer to *About the music files* (□ 127) for the folder structure of the memory card.

- At the time of purchase, Eye-Fi cards contain the necessary network configuration software. Be sure to install the software and complete the required configuration setup before you initialize the Eye-Fi card prior to using it with this camcorder.



Video

This chapter covers functions related to shooting movies, including recording, playback, advanced functions and playlist and scene operations.

Basic Recording

Shooting Video

Operating modes:   |  

1 Turn on the camcorder.

FS40 By default, movies are recorded in the built-in memory. You can select the memory that will be used to record movies ( 35).

2 Press to begin recording.

Press  again to pause the recording.

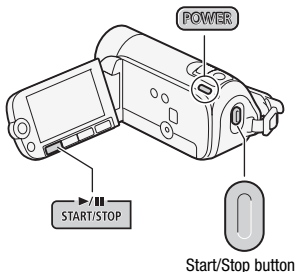

When you have finished recording



- 1 Make sure that the ACCESS indicator is off.
- 2 Turn off the camcorder.
- 3 Close the LCD panel.

IMPORTANT

- Observe the following precautions while the ACCESS indicator is on or flashing. Failing to do so may result in permanent data loss or damage to the memory.
 - Do not open the memory card slot cover.
 - Do not disconnect the power source or turn off the camcorder.
 - Do not change the camcorder's operating mode.

- Be sure to save your recordings regularly (□ 83), especially after making important recordings. Canon shall not be liable for any loss or corruption of data.



NOTES

- **About the Power Save mode:** If  [Power Saving Mode] is set to [ON On], the camcorder will shut off automatically to save power when it is powered by a battery pack and is left without any operation for 5 minutes. Press **POWER** to turn on the camcorder.
- When recording in bright places, it may be difficult to use the LCD screen. In such cases, you can turn on the LCD backlight (□ 24) or adjust the brightness of the LCD screen with the  [LCD Brightness] setting.

Selecting the Video Quality (Recording Mode)

The camcorder offers 3 recording modes. Changing the recording mode will change the recording time available on the memory. Select XP mode for better movie quality; select LP mode for longer recording times. The following table gives approximate recording times.

Operating modes: **AUTO**  |  

FUNC.  **[SP Standard Play 6 Mbps]**  Desired recording mode  **FUNC.**

NOTES

- The camcorder uses a variable bit rate (VBR) to encode video so the actual recording times will vary depending on the content of the scenes.
- The camcorder retains the last setting used even if you set the camcorder to **AUTO** mode.

Approximate recording times





◆ Default value

Recording mode →	XP	SP◆	LP
Memory ↓			
4 GB memory card	55 min.	1 hr. 20 min.	2 hr. 35 min.
FS40 Built-in memory/ 8 GB memory card	1 hr. 50 min.	2 hr. 45 min.	5 hr. 10 min.
16 GB memory card	3 hr. 40 min.	5 hr. 30 min.	10 hr. 25 min.
32 GB memory card	7 hr. 25 min.	11 hr.	20 hr. 50 min.

- When a recording exceeds 2 GB or 12 continuous hours, it will be divided and saved as scenes smaller than 2 GB.
- **FS40** At the time of purchase, the built-in memory contains about 70 MB of music files.

Zooming: Optical, Advanced and Digital Zoom

The camcorder offers the following three types of zoom:

Zoom Type	Description and use
Optical 37x	The optical magnification ratio of the lens. Used for recording movies only when  > [Image Stabilizer] is set to [ Dynamic] or when  > [Widescreen] is set to [OFF Off] and for recording photos.
Advanced 41x	The camcorder processes the image beyond the range of the optical zoom to obtain a larger zoom without any deterioration in image quality. Used for recording movies in all cases but the two exceptions above.
Digital 2000x*	You can activate it with the  > [Digital Zoom] setting. When set to [ON On] and only while recording movies, the camcorder will switch to digital zoom (light blue area on the zoom indicator) when you zoom in beyond the optical zoom range (white area on the zoom indicator). With the digital zoom, the image is processed digitally so image quality will deteriorate the more you zoom in.

* 1800x when  > [Image Stabilizer] is set to [ Dynamic].



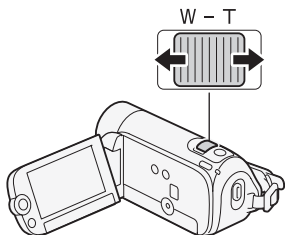

Operating modes:   |  

Move the zoom lever toward **W** (wide angle) to zoom out. Move it toward **T** (telephoto) to zoom in.

By default, the zoom lever operates at a variable speed – press gently for a slow zoom; press harder for faster zooms.



i NOTES

- Keep at least 1 m (3.3 ft.) away from the subject. At full wide angle, you can focus on a subject as close as 1 cm (0.39 in.).
- While the advanced zoom is activated, the field of view will be wider at full wide-angle.
- You can set   [Zoom Speed] to one of three constant speeds (3 is the fastest, 1 the slowest).
- When [Zoom Speed] is set to  Variable], the zoom speed will be faster in record pause mode than when actually recording, except when pre-recording ( 54) is activated.



Quick Start Function

When you close the LCD panel with the camcorder on, the camcorder enters the standby mode. In standby mode the camcorder consumes only about half the power used when recording, saving energy when you are using a battery pack. Additionally, when you open the LCD panel, the camcorder is ready to start recording in approximately 1 second*, allowing you to record the subject right away.

* The actual time required varies depending on the shooting conditions.

Operating modes:   |  

1 With the camcorder on and in a recording mode, close the LCD panel.

A beep will sound and the green ON/OFF (CHG) indicator will change to orange to indicate the camcorder entered standby mode.





2 When you wish to resume recording, open the LCD panel.

The ON/OFF (CHG) indicator turns back green and the camcorder is ready to record.

IMPORTANT

- Do not disconnect the power source during standby mode (while the ON/OFF (CHG) indicator is lit in orange).

NOTES



- The camcorder will not enter standby mode if the LCD panel is closed while the ACCESS indicator is on or flashing, while a menu is being displayed, or while the PHOTO button is pressed down halfway. The camcorder may also not enter standby mode if the LCD panel is closed while the memory card slot cover is open or when the battery charge is too low. Check that the ON/OFF (CHG) indicator changes to orange.
- The camcorder will shut off if left in standby mode for 10 minutes, regardless of the   [Power Saving Mode] setting. Press **POWER** to turn on the camcorder.
- You can select the length of time until shut-off or turn off the Quick Start function altogether with the   [Quick Start] setting.



Basic Playback

Playing Back Video

Operating modes:   |  

1 Press  to open the [Movies] index screen.

2 Move (, ) the selection frame to the scene you want to play back.

When you have recorded a large number of scenes, you can display () a sidebar below the scene thumbnails and browse () through index pages; then, return () to select the desired scene.

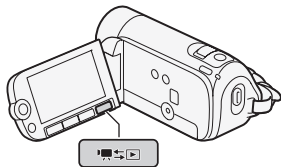



3 Press  to begin the playback.

Playback will start from the scene selected and continue until the end of the last scene recorded.



To pause/stop the playback

1 During playback, open () the joystick guide.



2 Select ()  to pause the playback or  to stop the playback.





3 You can also use the  and  buttons on the LCD panel.



To adjust the volume

1 During playback, open () the joystick guide.



2 Select () the top row ().

3 Adjust () the volume.

To turn off the volume, keep the joystick pressed () toward ) until the volume bars disappear.

IMPORTANT

- Observe the following precautions while the ACCESS indicator is on or flashing. Failing to do so may result in permanent data loss.
 - Do not open the memory card slot cover.
 - Do not disconnect the power source or turn off the camcorder.
 - Do not change the camcorder's operating mode.
- You may not be able to play back with this camcorder movies recorded on a memory card using another device.

NOTES

- Depending on the recording conditions, you may notice brief stops in video or sound playback between scenes.

Special playback modes

To enter the special playback modes, use the joystick guide. There is no sound during the special playback modes.

Fast playback

Perform the following operation during normal playback. Repeat to increase the playback speed to approximately 5x → 15x → 60x the normal speed.



Open (▲) the joystick guide ➤ Select (▲▼) the bottom row ➤ Push the joystick (◀▶) toward ◀◀ or ▶▶.

Slow playback

Perform the following operation during playback pause. Repeat to increase the playback speed 1/8 → 1/4 the normal speed.



Open (▲) the joystick guide ➤ Select (▲▼) the bottom row ➤ Push the joystick (◀▶) toward ◀◀* or ▶▶.

* Slow reverse playback will look the same as continuous frame reverse.

Skipping scenes

Open (▲) the joystick guide ➤ Select (▲▼) the middle row ➤ Push the joystick (◀▶)



toward **⏮*** to skip to the beginning of the current scene or **⏭** to skip to the next scene.

* Push twice to skip to the beginning of the previous scene.

Ending special playback modes

During any special playback mode, press **Ⓢ**. The camcorder will return to its initial mode (playback or playback pause).

i NOTES

- During some special playback modes, you may notice some anomalies (blocky video artifacts, banding, etc.) in the playback picture.
- The speed indicated on the screen is approximate.





Selecting what Recordings to Play Back

From the index screen, you can use the tabs on the top of the screen to select whether to play back your original movies or photos. Additionally, you can switch to index screens that contain only certain types of scenes, such as the [Playlist] or [Video Snapshot] index screen, or switch memories to play back recordings from the built-in memory or memory card (**FS40** only).

Operating modes: **AUTO**  |  

FS40



-  Movies
-  Photos
-  Recordings in the built-in memory
-  Recordings on the memory card

FS400

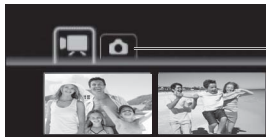

-  Movies
-  Photos

- 1 In the index screen, move (▲▼) the orange selection frame to the tabs on the top of the screen.
- 2 Select (◀▶) the tab corresponding to the recordings you want to play back.
- 3 Return (▲▼) to the index screen to select a scene or photo.

To open the [Video Snapshot] index screen

You can open an index screen that contains only your video snapshot scenes (📖 55). In the original [Movies] index screen, press **VIDEO SNAP**.



To open the [Playlist] index screen

Open the [Playlist] index screen to play back the scenes you added to the playlist (📖 67). In the original [Movies] index screen, press **PLAYLIST**.

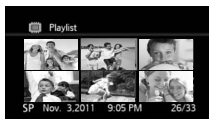

i NOTES

- You can press both **PLAYLIST** and **VIDEO SNAP** to open the [Playlist: Video Snapshot] index screen that contains only those video snapshot scenes that were also added to the playlist.

Searching for Scenes

From the [Movies] index screen, you can search for recordings you made on a particular date (for example, to find all the movies you shot during a special event).

Operating modes: **AUTO**  |  

Selecting from the Calendar Screen

1 Open the [Movies] or [Video Snapshot] index screen.

FS40 You can select the original movies in the built-in memory or on the memory card.

2 Open the calendar screen.

[FUNC.] ➤ [Scene Search] ➤ [Calendar Screen]

- The calendar screen appears.
- Dates that contain scenes (that is, movies were recorded on that date) appear in white. Dates without recordings appear in black.

3 Move (▲▼, ◀▶) the cursor to the desired date.

- When you move the cursor to a date displayed in white, a thumbnail showing a still image from the first scene recorded on that date will be displayed next to the calendar. Below it will appear the number of scenes recorded (📺) and the total recording time for the same day.
- You can select (▲▼) the year or month field and change (◀▶) the year or month to move faster between calendar months.

4 Press (SET) to return to the index screen.

The orange selection frame will appear on the first scene recorded on the selected date.

i NOTES

- You can change on what day to start the week for the calendar display with the (📅) ➤ [Calendar Start Day] setting.
- You can press [FUNC.] to return to the index screen at any time.

Selecting from the List of Recordings

1 Open the [Movies] or [Video Snapshot] index screen.

FS40 You can select the original movies in the built-in memory or on the memory card.

2 Open the list of recordings.

[FUNC.] ➤ [Scene Search] ➤ [Date Selection]

- The list of recordings displays all dates in which recordings were made. An orange selection frame appears on the day.
- The thumbnail shows a still image from the first scene recorded on that day. Below it will appear the number of scenes recorded (📺) and the total recording time for the same day.

3 Select (◀▶) the date, month or year and move (▲▼) between recording dates.

4 After selecting the desired date, press (SET).

The index screen will appear with the selection frame on the first scene recorded on the selected date.

NOTES

- You can press (FUNC.) to return to the index screen at any time.

Pre-selecting Recordings from the Index Screen

You can select in advance a number of original movies or photos from the index screen in order to perform certain actions on them collectively, all at once. This way you can easily delete recordings, copy recordings to the memory card (FS40 only), or add a number of scenes to the playlist.

Operating modes: (AUTO)  |  

1 Open the [Movies], [Video Snapshot] or [Photos] index screen.

FS40 You can select the original movies or photos in the built-in memory or on the memory card.

2 Open the selection screen.

(FUNC.) ➤ [✓ Select] ➤ [Individual Scenes] or
[Individual Photos]

- The selection screen appears.

3 Move (▲▼, ▶◀) between the scenes or photos in the index screen and press (SET) to select an individual scene/photo.

- A checkmark ✓ will appear on the selected scenes/photos. Press (SET) again to remove the checkmark.
- Repeat this step to add all the scenes/photos you want to include in your selection (up to 100).

Total number of scenes selected



Selected scenes

4 Press **[FUNC.]** twice to close the menu.

To cancel all the selections

[FUNC.] ➤ **[Select]** ➤ **[Remove All Selections]** ➤ **[Yes]** ➤ **[OK]** ➤ **[FUNC.]**

i NOTES

- The pre-selection of scenes/photos will be canceled if you turn off the camcorder or change the operating mode.
- Scenes in the playlist cannot be included in the pre-selection.

Deleting Scenes

You can delete those scenes that you are not interested in keeping. Deleting scenes allows you also to free up space on the memory. See also *Deleting Scenes from the Playlist* (📖 68).

Operating modes: **AUTO**  |  

1 Open the **[Movies]** or **[Video Snapshot]** index screen.

- **FS40** You can select the original movies in the built-in memory or on the memory card.
- To select in advance multiple scenes to delete, refer to *Pre-selecting Recordings from the Index Screen* (📖 48).

2 Select (**▲▼**, **◀▶**) the scene you want to delete, or a scene recorded on the date you want to delete.

This step is not necessary to delete all scenes or previously selected scenes.

3 Delete the scenes.

[FUNC.] ➤ [🗑️ Delete] ➤ Desired option ➤ [Yes]* ➤ [OK] ➤
[FUNC.]

* If you selected any option other than [This Scene], you can press **SET** to interrupt the operation while it is in progress. Some scenes will be deleted nevertheless.

Options

[All Scenes] Deletes all the scenes.

[All Scenes (this date)] Deletes all the scenes recorded on the same day as the selected scene.

[This Scene] Deletes only the scene marked with the orange selection frame.

[Selected Scenes] Deletes all the scenes selected in advance (marked with a ✓ checkmark). Refer to *Pre-selecting Recordings from the Index Screen* (□ 48).

! IMPORTANT

- Be careful when deleting original recordings. Once deleted, original scenes cannot be recovered.
- Save copies of important scenes before deleting them (□ 83).
- Observe the following precautions while the ACCESS indicator is on or flashing (while scenes are being deleted).
 - Do not open the memory card slot cover.
 - Do not disconnect the power source or turn off the camcorder.
 - Do not change the camcorder's operating mode.

i NOTES

- Deleting an original scene from the [Movies] or [Video Snapshot] index screen also deletes that scene from the playlist.
- To delete all movies and make all recordable space available again you may prefer to initialize the memory (□ 35).

Advanced Functions



Automatic Exposure and Special Scene Recording Programs

The recording program determines how much control you have over the camcorder's recording-related settings. Select the [**P** Programmed AE] recording program to give you full control over functions like the white balance or image effects. Alternatively, give the camcorder more control by selecting a Special Scene recording program.

Operating modes:   |  





Using [**P** Programmed AE]

When you use the [**P** Programmed AE] recording program, the camcorder automatically adjusts the aperture and shutter speed to obtain the optimal exposure for the subject.



 ➤ [**P** Programmed AE] ➤ 

Special Scene Recording Programs

Select a Special Scene recording program to easily make recordings in a variety of situations by letting the camcorder take control of various settings.

 ➤ [**P** Programmed AE] ➤ [ Portrait] ➤ Press  to display the Special Scene (SCN) recording programs ➤ Desired recording program ➤ 

Options (Default value)

 **Portrait**  The camcorder uses a large aperture, to achieve a sharp focus on the subject while blurring the background.



[🎾 **Sports**] To record sports scenes such as tennis or golf.



[❄️ **Snow**] To record in bright ski resorts without the subject being underexposed.



[🏖️ **Beach**] To record on a sunny beach without the subject being underexposed.



[🌅 **Sunset**] To record sunsets in vibrant colors.



[🌃 **Night Scene**] To record nightscapes with lower noise.



[📷 **Low Light**] To record in low-light situations.











[📏 **Spotlight**] To record spotlit scenes.



[🎆 **Fireworks**] To record fireworks.





NOTES

- [ Portrait]/[ Sports]/[ Snow]/[ Beach]: The picture may not appear smooth during playback.
- [ Portrait]: The blur effect of the background increases the more you zoom in (**T**).
- [ Snow]/[ Beach]: The subject may become overexposed on cloudy days or in shaded places. Check the image on the screen.
- [ Low Light]:
 - Moving subjects may leave a trailing afterimage.
 - Picture quality may not be as good as in other modes.
 - White points may appear on the screen.
 - Autofocus may not work as well as in other modes. In such case, adjust the focus manually.
- [ Fireworks]:
 - To avoid camcorder blur (blur due to the camcorder moving) we recommend using a tripod.
 - When you take photos, slower shutter speeds are used so blur is more likely to occur. Stabilize the camcorder, for example, by mounting it on a tripod.

Automatic Backlight Correction

When shooting subjects with a strong light source behind them, you can have the camcorder automatically correct for backlight.

Operating modes:   |  

- 1 Open (**▲**) the joystick guide.
- 2 Select (**▲▼**) [ BLC] and press **(SET)**.
 -  appears.
 - Press **(SET)** again to turn off the backlight correction.

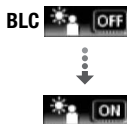



Advanced Image Stabilization

The image stabilizer reduces camcorder blur (blur due to the camcorder moving) so you can get nice, stable shots. Select the image stabilization mode according to the shooting conditions.



Operating modes:   |  

 >  Menu >  > [Image Stabilizer] >
Desired IS mode > 

Options [♦] Default value

-  **Dynamic** Compensates for a higher degree of camcorder shake, such as when shooting while walking, and is more effective as the zoom approaches full wide angle.
-  **Standard**[♦] Compensates for a lower degree of camcorder shake, such as when shooting while remaining stationary, and is suitable for shooting natural-looking scenes. With this setting, the field of view will be wider at full wide-angle.
-  **Off** Use this setting when the camcorder is mounted on a tripod.

NOTES

- The image stabilizer may not be able to successfully eliminate all blur if the camcorder or the subject is moving too much.
- The image stabilizer may not work well on subjects with low contrast, with a recurring, repetitive pattern or without vertical lines.
- When [Image Stabilizer] is set to  Dynamic, if the background's movement does not appear natural, select  Standard or  Off.

Pre-Recording

The camcorder will start recording 3 seconds before you press , ensuring you do not miss important shooting opportunities. This is especially useful when it is difficult to predict when to start recording.

Operating modes: **AUTO**  |  

- 1 Open (**▲**) the joystick guide.
- 2 Select (**▲▼**) [**Pre REC**] and press **SET**.

- **Pre REC** appears.
- Press **SET** again to turn pre-recording off.



- 3 Press **Start/Stop**.

The scene recorded in the memory will start 3 seconds before **Start/Stop** was pressed.

i NOTES

- While pre-recording is activated, the camcorder will not emit any notification sounds.
- The camcorder will not record the full 3 seconds prior to pressing **Start/Stop** if the button was pressed within 3 seconds of having turned on pre-recording or having finished the previous recording.
- Any of the following actions will deactivate the pre-recording function.
 - Leaving the camcorder without any operation for 5 minutes.
 - Pressing **FUNC.**, , **AUTO** or **VIDEO SNAP**.
 - Closing the LCD panel to set the camcorder to standby mode.



Video Snapshot

Record a series of short scenes. Play your video snapshot scenes set to your favorite music ( 63) to create your own fun music video. You will be surprised how by changing the background music, you can give your scenes an entirely new feel.

Operating modes: **AUTO**  |  

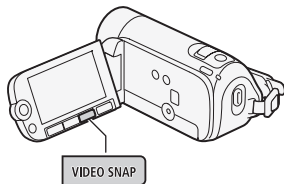
- 1 Press **VIDEO SNAP**.
 - A blue border appears on the screen.
 - Press **VIDEO SNAP** again to return to normal video recording mode.
- 2 Press **Start/Stop**.









- The camcorder records for about 4 seconds (the blue frame serves as a visual progress bar) and then automatically returns to record pause mode.
- You can change the length of video snapshot scenes to 2 or 8 seconds with the   [Video Snapshot Length] setting.
- When the camcorder stops recording, the screen will momentarily turn black as if a camera shutter had released.
- In index screens, video snapshot scenes are indicated with the  mark.

NOTES

- Video snapshot is deactivated if the camcorder is switched to playback mode.

Digital Effects

Operating modes:   |  



   Digital Effect Off  Desired fader/effect* 



* You can preview the digital effect on the screen.

- The icon of the selected digital effect appears.

Options Default value)

 **Digital Effect Off**[♦] Select this setting when you do not intend to use the digital effects.

 **Fade Trigger**,  **Wipe** Select one of the faders to begin or end a scene with a fade from or to a black screen.

 **Black & White**^{*} Records movies and photos in black and white.

 **Sepia**^{*} Records movies and photos in sepia tones for an “old” look.

* Only these digital effects are available for photos.

Applying the Selected Digital Effect

- 1 Open (▲) the joystick guide.
- 2 Select (▲▼) [Digital Effects] and press (SET).
 - The icon of the selected digital effect turns green.
 - Press (SET) again to deactivate the digital effect (its icon will turn white again).

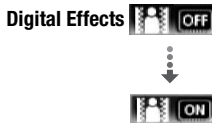

To fade in/out

Activate the selected fader in record pause mode (●||), then press [Start/Stop] to start recording with a fade in. Activate the selected fader while recording (●), then press [Start/Stop] to fade out and pause the recording.

To activate an effect

For movies: Activate the selected effect while recording or in record pause mode.

For photos: Activate the selected effect and then press [PHOTO] to record the photo.

NOTES

- When you apply a fader, not only the picture but also the sound will fade in or out. When you apply an effect, the sound will be recorded normally.
- Faders cannot be used when recording video snapshot scenes or when pre-recording is activated.

Manual Exposure Adjustment



At times, backlit subjects may appear too dark (underexposed) or subjects under very strong lights may appear too bright or glaring (overexposed). To correct this, you can manually adjust the exposure.

Operating modes: [AUTO]  |  

POINTS TO CHECK

- Select a recording program other than [ Fireworks].



1 Open () the joystick guide.

2 Select () [ Exposure] and press

.

- The current exposure is locked.
- The exposure adjustment indicator  and the neutral value “±0” appear on the screen.
- The adjustment range and the length of the exposure adjustment indicator will vary depending on the initial brightness of the picture.
- If you operate the zoom, the brightness of the image may change.



3 Adjust the () the brightness of the image as required, then hide () the joystick guide.

- The exposure adjustment indicator will change to white and the selected exposure will be locked.
- During exposure lock, press  twice to return the camcorder to automatic exposure.

NOTES

- If the recording program is changed during exposure lock, the camcorder will return to automatic exposure.

Manual Focus Adjustment

Autofocus may not work well on the following subjects. In such case, focus manually.

- Reflective surfaces
- Subjects with low contrast or without vertical lines
- Fast moving subjects
- Through wet windows
- Night scenes

Operating modes:   |  

POINTS TO CHECK

- Adjust the zoom before you start the procedure.

1 **Open (▲) the joystick guide.**

2 **Select (▲▼) [Focus] and press (SET).**

The current focus is locked and [MF] appears.



3 **Adjust (◀▶) the focus as required.**

- If you wish to focus on faraway subjects such as mountains or fireworks, push the joystick (▶) toward ▲ and hold it pressed down until [MF] changes to ∞.



4 **Push the joystick (▼) to hide the joystick guide.**

- The selected focus will be locked.
- During focus lock, press (SET) twice to return the camcorder to autofocus.

White Balance



The white balance function helps you to accurately reproduce colors under different lighting conditions so that white objects will always look truly white in your recordings.

Operating modes:   |  

POINTS TO CHECK

- Set the recording program to [P Programmed AE].

 ➤ [AWB Automatic] ➤ Desired option* ➤ 

* When you select [ Custom WB], do not press  and continue instead with the following procedure.

To set the custom white balance

- 1 Point the camcorder at a white object so it fills the whole screen and press (SET).

When the adjustment is completed,  stops flashing and stays on. The camcorder retains the custom setting even if you turn off the camcorder.

2 Press **[FUNC.]** to save the setting and close the menu.

Options (Default value)

[AWB Automatic] The camcorder automatically sets the white balance for natural looking colors.

[ Daylight] To record outdoors on a bright day.

[ Tungsten] To record under tungsten and tungsten-type (3-wavelength) fluorescent lighting.

[ Custom WB] Use the custom white balance setting to make white subjects appear white under colored lighting.

NOTES



- **When you select the custom white balance:**
 - Set   [Digital Zoom] to [**OFF** Off].
 - Reset the white balance when you change locations or the lighting or other conditions change.
 - Depending on the light source,  may keep flashing. The result will still be better than with [AWB Automatic].
- Custom white balance may provide better results in the following cases:
 - Changing lighting conditions
 - Close-ups
 - Subjects in a single color (sky, sea or forest)
 - Under mercury lamps and certain types of fluorescent lights

Image Effects

You can use the image effects to change the color saturation and contrast to record movies and photos with special color effects.

Operating modes: **[AUTO]**  |  

POINTS TO CHECK

- Set the recording program to [**P** Programmed AE].

[FUNC.] > [OFF Image Effect Off] > Desired option > [FUNC.]

Options ^(♦ Default value)

- [OFF Image Effect Off] ♦ Records with no image enhancing effects.
- [Vivid] Emphasizes the contrast and color saturation.
- [Neutral] Tones down the contrast and color saturation.
- [SD Soft Skin Detail] Softens the details in the skin tone area for a more complimentary appearance. To obtain the best effect, use this setting when recording a person in close-up. Note that areas similar to the skin color may lack in detail.

Mini Video Light

You can turn on the mini video light to shoot video or take photos in dark places.

Operating modes: [AUTO]  |  

- 1 Open (▲) the joystick guide.
- 2 Select (▲▼) [Video Light] and press (SET).
 -  appears on the screen.
 - Press (SET) again to turn the mini video light off.

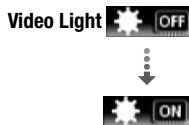

Self Timer

Operating modes: [AUTO]  |  

[FUNC.] > [Menu] >  > [Self Timer] > [On] > [FUNC.]

 appears.

For movies: Press **[Start/Stop]**.

The camcorder starts recording after a 10-second countdown. The countdown appears on the screen.

For photos: Press **[PHOTO]**, first halfway to activate the autofocus and then fully.

The camcorder will record the photo after a 10-second countdown. The countdown appears on the screen.

i NOTES

- Once the countdown has begun, any of the following actions will cancel the self timer.
 - Pressing **[Start/Stop]** (when recording movies) or **[PHOTO]** fully (when recording photos).
 - Turning off the camcorder.
 - Changing the camcorder's operating mode.
 - Closing the LCD panel to set the camcorder to standby mode.

Selecting the Playback Starting Point

If you have a very long scene, you may want to start playing back the scene from a certain point. You can use the movie timeline to break the scene to segments at fixed time intervals ranging from 6 seconds to 6 minutes.

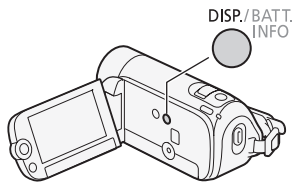

Operating modes: **[AUTO]** **[Movie]** | **[Still]** **[Photo]**

1 Open the **[Movies]** or **[Playlist]** index screen.

FS40 You can select the original movies or playlist in the built-in memory or on the memory card.

2 Select (**▲▼**, **◀▶**) the scene you want to view and press **[DISP.]**.

- The **[Timeline]** screen appears. The large thumbnail will show the first frame of the scene. Below it, the timeline ruler shows frames taken from the scene at fixed intervals.

- Press **[DISP.]** again to return to the index screen.

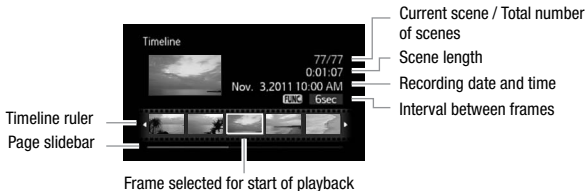

3 Select (**◀▶**) the playback starting point from the timeline ruler.

4 Press **(SET)** to begin the playback.

To select another scene

Move (**▲▼**) the orange selection frame to the large thumbnail and select (**◀▶**) another scene.

To move between timeline ruler pages

Move (**▲▼**) the orange selection frame to the slidebar below the ruler and display (**◀▶**) the previous/next 5 frames in the scene.

To change the interval between frames

[FUNC.] **▶** Desired interval **▶** **[FUNC.]**

Playing Back Recordings Set to Background Music

You can play back video snapshot scenes, scenes in the playlist and photo slideshows set to background music (instead of the original sound) using one of the supplied tracks.

Operating modes: **AUTO**   

Using a Supplied Music Track as Background Music

The supplied Camcorder Supplemental Disc contains three music tracks you can use as background music. **FS40** The music files come pre-installed in the built-in memory.

POINTS TO CHECK

To play back scenes or a slideshow of photos recorded on the memory card, you will need to transfer the music tracks to the memory card in advance.

Windows users: Use the supplied PIXELA's software. For details, refer to the Software Guide (PDF file) of the supplied PIXELA's software. Mac OS users: Use Finder to transfer music files from the [MUSIC] folder on the supplied Camcorder Supplemental Disc. Refer to *About the music files* (□ 127) for the folder structure on the memory card.

1 Open the [Playlist], [Video Snapshot], [Playlist: Video Snapshot] or [Photos] index screen.

FS40 You can select the recordings in the built-in memory or on the memory card.

2 Open the list of background music tracks.



FUNC.  [♪ Select Music]

3 Select (▲▼) a music track and press **FUNC.** twice.

- Before pressing **FUNC.**, you can press **SET** to listen to the track you selected. Press **SET** again to stop the playback.
- Select [Off] to play back scenes with their original sound or to play back slideshows without any music.

4 Back in the index screen, select (▲▼, ◀▶) the recording from which to start playback.

5 Press **SET** to begin the playback set to the background music selected.

In  mode, press  to begin the slideshow playback.

To delete a music track

After step 2 in the previous procedure, select (▲▼) the track you want to delete.

- 1 Select (▶) the  icon and press **SET**.
- 2 Select (▶) [Yes] and press **SET**.
- 3 Press **FUNC.** twice.

IMPORTANT

- If you use copyrighted songs and music tracks in your video creations, remember that music under copyright may not be used without permission from the copyright holder, except for cases permitted under applicable laws, such as for personal use. Make sure to follow applicable laws when using music files.

NOTES

- You can also add to the playlist just the video snapshot scenes you want to watch and arrange their playback order.
- Initializing a memory card will permanently erase any music files you may have transferred to the card. (**FS40** The music files that come pre-installed in the built-in memory will be restored after it is initialized.) To transfer music files from the supplied Camcorder Supplemental Disc to the memory card:
 - Windows users: Use the supplied **PIXELA's** software. For details, refer to the Software Guide (PDF file) of the supplied PIXELA's software.
 - Mac OS users: Use Finder to transfer the music files from the [MUSIC] folder on the supplied Camcorder Supplemental Disc to the memory card. Refer to *About the music files* (□□ 127) for the folder structure of the memory card.
- Transfer music files from the supplied Camcorder Supplemental Disc to the memory card that contains the recordings you want to play back with background music.
- The background music may not be played back correctly when playing back a slideshow from a memory card with slow transfer rates.

On-Screen Displays and Data Code

You can turn most on-screen displays on or off.

Operating modes: **AUTO**  |  

Repeatedly press **DISP.** to turn the on-screen displays on/off in the following sequence:

 ,  mode:

- All displays on
- Most displays off*



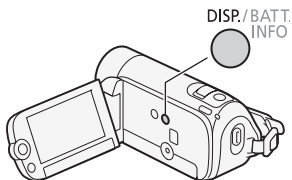

 mode:

- All displays on
- Data code only
- All displays off

* Pressing **DISP.** will turn off most of the icons and displays that appears automatically but will not remove onscreen displays that were turned on manually (for example, onscreen markers or the joystick guide).



About the Data Code

With every scene or photo recorded, the camcorder keeps a data code (date/time of recording, information about the camera setup, etc.). In  mode, the recording date and time are displayed on the bottom bar; in  mode, you can select the information to be displayed with the   [Data Code] setting.

Playlist and Scene Operations

Editing the Playlist: Adding, Deleting and Moving Scenes

Create a playlist to play back only the scenes you prefer and in the order of your choice. You can play back the scenes in the playlist using your favorite song as background music (📖 63).

Operating modes:   |  

Adding Scenes to the Playlist

1 Open the [Movies] or [Video Snapshot] index screen.

FS40 You can select the original movies in the built-in memory or on the memory card.

2 Select (▲▼, ◀▶) the scene you want to add to the playlist, or a scene recorded on the date you want to add to the playlist.

3 Add the scenes to the playlist.

 ➤  [Add to Playlist] ➤ Desired option ➤ [Yes]

- When the operation is completed [Scene(s) added to the playlist] will be displayed.
- **FS40** Scenes are added to the playlist on the same memory they are recorded on.
- To check the playlist, press .

Options

[All Scenes (this date)] Adds to the playlist all the scenes that were recorded on the same day as the selected scene.

[This Scene] Adds to the playlist only the scene marked with the orange selection frame.

[Selected Scenes] Adds to the playlist all the scenes selected in advance (marked with a ✓ checkmark). Refer to *Pre-selecting Recordings from the Index Screen* (📖 48).

NOTES

- Deleting or moving scenes in the playlist will not affect the original recordings.
- FS40** You can copy scenes from the built-in memory to the memory card (📖 70) to include in the memory card's playlist also scenes that were originally recorded in the built-in memory.

Deleting Scenes from the Playlist

Deleting scenes from the playlist will not affect your original recordings.

1 Open the [Playlist] or [Playlist: Video Snapshot] index screen.

FS40 Before opening the playlist, you can select the original movies in the built-in memory or on the memory card to open the playlist of the respective memory.

2 Select (▲▼, ◀▶) the scene you want to delete.

This step is not necessary to delete all scenes.

3 Delete the scene.

[FUNC.] ➤ [🗑️ Delete] ➤ Desired option ➤ [Yes]* ➤ [OK] ➤
[FUNC.]

* If you selected [All Scenes], you can press (SET) to interrupt the operation while it is in progress. Some scenes will be deleted nevertheless.

Options

[All Scenes] Deletes all the scenes from the playlist.

[This Scene] Deletes from the playlist only the scene marked with the orange selection frame.

Moving Scenes in the Playlist

Move the scenes in the playlist to play them back in the order of your choice.

1 Open the [Playlist] or [Playlist: Video Snapshot] index screen.

FS40 Before opening the playlist, you can select the original movies in the built-in memory or on the memory card to open the playlist of the respective memory.

- 2 Select (▲▼, ◀▶) the scene you want to move.
- 3 Press [FUNC.], select [] Move and press (SET).
- 4 Move (▲▼, ◀▶) the orange marker to the desired position of the scene and press (SET).
The original position of the scene and the current position of the marker are displayed at the bottom of the screen.
- 5 Select (▶) [Yes] and press (SET) to move the scene.

Dividing Scenes

You can divide scenes (original scenes only) in order to leave out the best parts and later cut out the rest.

Operating modes: [AUTO]  |  

- 1 Open the [Movies] index screen.

FS40 You can select the original movies in the built-in memory or on the memory card (□ 45).

- 2 Select (▲▼, ◀▶) the scene you want to divide.
- 3 Press [FUNC.], select [] Divide and press (SET).
 - The scene selected will start playing back. Pause the playback at the point where you want to divide the scene.
 - You can use the following icons to bring the scene to a precise point.
 - ◀▶/▶▶: Search (fast playback) backward/forward.
 - ⏮/⏭: Skip to the beginning/end of the current scene.
 - ⏸: Pause playback. ▶: Resume playback.
 - : Stop playback (cancel).
 - ◀||/||▶: Frame backward/forward (during playback pause).
 - You can also press [FUNC.] to stop the playback and cancel the division of the scene.
- 4 Select (◀▶) the  icon and press (SET) to divide the scene.
- 5 Select (▶) [Yes] and press (SET).
 - A progress bar will be displayed on the screen.
 - You can press (SET) to cancel the operation while it is in progress.
- 6 When the confirmation screen appears, press (SET).

The video from the division point to the end of the scene will appear as a new scene in the index screen.

NOTES

- When advancing/reversing frames while dividing the scenes, the interval will be 0.5 second.
- If the scene cannot be divided at the point where you paused the playback, advance/reverse a frame and then divide the scene.
- During the playback of a scene that was divided, you may notice some anomalies in the picture/sound at the point where the scene was cut.
- The following scenes cannot be divided:
 - Scenes included in the scene pre-selection (marked with a ✓ checkmark). Remove the selection mark in advance.
 - Video snapshot scenes and other scenes that are too short (less than 3 seconds).
 - Scenes that were edited using the supplied PIXELA's software and were then written back to the memory.
- Scenes cannot be divided within 2 seconds from the beginning or the end of the scene.



FS40 Copying Scenes to a Memory Card

You can copy original movies or the entire playlist only from the built-in memory to the corresponding location on the memory card. See *Copying Photos to a Memory Card* (📖 78) for details on copying photos to the memory card.

Operating modes:   |  

Copying Original Movies

1 Open the [Movies] or [Video Snapshot] index screen for original scenes recorded in the built-in memory.

Select the  tab under the  icon.

2 Select (▲▼, ◀▶) the scene you want to copy to the memory card, or a scene recorded on the date you want to copy.

This step is not necessary to copy all scenes or previously selected scenes.

3 Copy the scenes.

[FUNC.] > [] Copy () > Desired option > [Yes]* > [OK] > [FUNC.]

* Press **SET** to interrupt the operation while it is in progress.

Options

[All Scenes] Copies all the scenes to the memory card.

[All Scenes (this date)] Copies to the memory card all the scenes that were recorded on the same day as the selected scene.

[This Scene] Copies to the memory card only the scene marked with the orange selection frame.

[Selected Scenes] Copies to the memory card all the scenes selected in advance (marked with a ✓ checkmark). Refer to *Pre-selecting Recordings from the Index Screen* (48).

Copying the Entire Playlist

1 Open the built-in memory's [Playlist] or [Playlist: Video Snapshot] index screen.

Select the **▶** tab under the **▶** icon and then open the desired playlist.

2 Copy the playlist.

[FUNC.] > [] Copy () > [Yes]* > [OK] > [FUNC.]

* Press **SET** to interrupt the operation while it is in progress.

! IMPORTANT

- Observe the following precautions while the ACCESS indicator is on or flashing. Failing to do so may result in permanent data loss.
 - Do not open the memory card slot cover.
 - Do not disconnect the power source or turn off the camcorder.
 - Do not change the camcorder's operating mode.

NOTES

- In the following cases, you will not be able to copy recordings to the memory card:
 - If the memory card slot is open.
 - If the LOCK switch on the memory card is set to prevent writing.
 - If there is no memory card in the memory card slot.



Photos

Refer to this chapter for details on taking photos and playing them back.

Taking Photos

Operating modes: **AUTO**  |  



POINTS TO CHECK

- Please read the IMPORTANT section before using an Eye-Fi card.

1 Turn on the camcorder.

FS40 By default, photos are recorded in the built-in memory. You can select the memory that will be used to record photos (□ 35).

2 Press **PHOTO** halfway.

Once the focus is automatically adjusted, the onscreen icon  will turn green and one or more AF frames will appear.

3 Press **PHOTO** fully.

The ACCESS indicator will flash as the photo is being recorded.

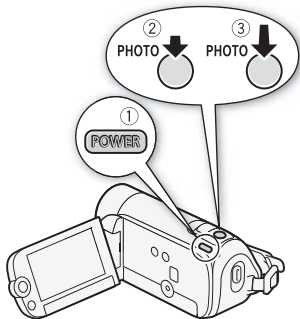

IMPORTANT

- Observe the following precautions while the ACCESS indicator is on or flashing. Failing to do so may result in permanent data loss.
 - Do not open the memory card slot cover.
 - Do not disconnect the power source or turn off the camcorder.
 - Do not change the camcorder's operating mode.

- Photos recorded on an Eye-Fi card will be uploaded automatically after setting the camcorder to playback mode if you are within the range of a configured network. Always verify that Eye-Fi cards have been approved in the country/region of use. See also Using an Eye-Fi card (□ 88).

i NOTES

- Photos are recorded as JPG files. The photo size (1024x768) and quality cannot be changed. As a general guideline, you can use photos recorded with this camcorder to print photos up to L size (10 x 14.8 cm, 4 x 6 in.).

At the above photo size and quality, a 1 GB memory card can hold approximately 1,885 photos. However, the actual number of photos that can be recorded will vary depending on the subject and shooting conditions.

Viewing Photos

Operating modes: **AUTO**  |  

1 Press .

2 Open the [Photos] index screen.

F540 You can select the photos in the built-in memory or on the memory card.

3 Select (**▲▼**, **◀▶**) a photo.

- Move the orange selection frame to the photo you want to view.
- When you have recorded a large number of photos, you can display (**▲▼**) a sidebar below the photo thumbnails and browse (**◀▶**) through whole index pages.

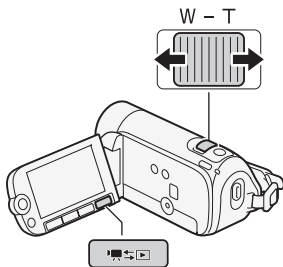

4 Press **SET** or move the zoom lever toward **T**.

The selected photo is displayed in single photo view.

To return to the index screen from single photo view



- 1 Open (▲) the joystick guide.
- 2 Select (▲▼) the  icon and press (SET).
You can also move the zoom lever toward **W** to return to the index screen.





Photo Jump Function

When you have recorded a large number of photos, you can jump 10 or 100 photos at a time.

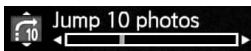
- 1 In single photo view, open (▲) the joystick guide.
- 2 Select (▲▼) the  icon and press (SET).



- 3 Select (▲▼) [ Jump 10 photos] or [ Jump 100 photos].
- 4 Jump (◀▶) the number of photos selected and press (SET).









! IMPORTANT

- Observe the following precautions while the ACCESS indicator is on or flashing. Failing to do so may result in permanent data loss.
 - Do not open the memory card slot cover.
 - Do not disconnect the power source or turn off the camcorder.
 - Do not change the camcorder's operating mode.
- The following image files may not be displayed correctly.
 - Images not recorded with this camcorder.
 - Images edited on or uploaded from a computer.
 - Images whose file names have been changed.

Slideshow

You can play a slideshow of all the photos and even set it to music.

Operating modes:   |  











- 1 Open the [Photos] index screen.
- 2 Select the background music to use when playing back the photo slideshow ( 63, steps 1-3).
- 3 Back in the index screen, select (, , , ) the first photo of the slideshow.
- 4 Press  to begin the slideshow playback set to the selected music track.
 - You can adjust () the volume during the slideshow playback. Hide () the joystick guide if necessary.
 - Press  to stop the slideshow.

Deleting Photos

You can delete those photos that you are not interested in keeping.

Operating modes:   |  

Deleting a Single Photo

- 1 In single photo view, select (, ) the photo you want to delete.
- 2 Open () the joystick guide.
- 3 Select (, ) the  icon and press .
- 4 Select (, ) [Yes] and press .



Using the FUNC. Menu

- 1 In single photo view, open the photo selection screen.

  [ Delete]

[ Delete] appears on the screen.

- 2 Select (◀▶) the photo you want to delete and press (SET).
- 3 Select (◀▶) [Yes] and press (SET) to delete the photo.
- 4 Repeat steps 2-3 to delete additional photos or press (FUNC.) twice to close the menu.

Deleting Photos from the Index Screen

1 Open the [Photos] index screen.

FS40 You can select the photos in the built-in memory or on the memory card.

2 Select (▲▼, ◀▶) the photo you want to delete.

This step is not necessary to delete all photos or previously selected photos.

3 Delete the photos.

(FUNC.) ➤ [🗑️ Delete] ➤ Desired option ➤ [Yes]* ➤ [OK] ➤
(FUNC.)

* If you selected an option other than [This Photo], you can press (SET) to interrupt the operation while it is in progress. Some photos will be deleted nevertheless.

Options

[All Photos] Deletes all the photos.

[This Photo] Deletes only the photo marked with the orange selection frame.

[Selected Photos] Deletes all the photos selected in advance (marked with a ✓ checkmark). Refer to *Pre-selecting Recordings from the Index Screen* (□ 48).

! IMPORTANT

- Be careful when deleting photos. Deleted photos cannot be recovered.
- Photos that were protected with other devices cannot be deleted with this camcorder.

FS40 Copying Photos to a Memory Card

You can copy photos only from the built-in memory to the memory card.

POINTS TO CHECK

- Please read the IMPORTANT section (📖 79) before using an Eye-Fi card.

Operating modes:   |  

Copying a Single Photo

1 Select to view the photos recorded in the built-in memory.

In the index screen, select the  tab under the  icon and move the zoom lever toward **T** to return to single photo view.

2 Open the photo selection screen.

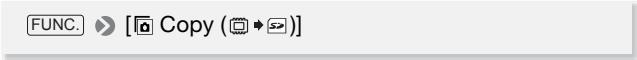

[FUNC.] > [📷 Copy (📷 → 📁)]

[📷 Copy (📷 → 📁)] appears on the screen.



3 Select (◀▶) the photo you want to copy and press .

4 Select (◀▶) [Yes] and press to copy the photo.

5 Repeat steps 3-4 to copy additional photos or press twice to close the menu.

Copying Photos from the Index Screen

1 Open the [Photos] index screen of the photos recorded in the built-in memory.

Select the  tab under the  icon.

2 Select (▲▼, ◀▶) the photo you want to copy.

This step is not necessary to copy all photos or previously selected photos.

3 Copy the photos.

[FUNC.] ➤ [📷 Copy (📷 ➔ 📷)] ➤ Desired option ➤ [Yes]* ➤
[OK] ➤ [FUNC.]

* If you selected an option other than [This Photo], you can press **SET** to interrupt the operation while it is in progress.

Options

[All Photos] Copies all the photos.

[This Photo] Copies only the photo marked with the orange selection frame.

[Selected Photos] Copies all the photos selected in advance (marked with a ✓ checkmark). Refer to *Pre-selecting Recordings from the Index Screen* (📖 48).

! IMPORTANT

- Observe the following precautions while the ACCESS indicator is on or flashing. Failing to do so may result in permanent data loss.
 - Do not open the memory card slot cover.
 - Do not disconnect the power source or turn off the camcorder.
 - Do not change the camcorder's operating mode.
- When copying photos onto an Eye-Fi card, photos will be uploaded automatically if you are within the range of a configured network. Always verify that Eye-Fi cards have been approved in the country/region of use. See also *Using an Eye-Fi card* (📖 88).

i NOTES

- In the following cases, you will not be able to copy recordings to the memory card:
 - If the memory card slot is open.
 - If the LOCK switch on the memory card is set to prevent writing.
 - If there is no memory card in the memory card slot.
- If there is not enough space on the memory card, as many photos as possible will be copied before stopping the operation.



External Connections

This chapter explains how to connect your camcorder to an external device such as a TV, VCR, or computer.

Terminals on the Camcorder

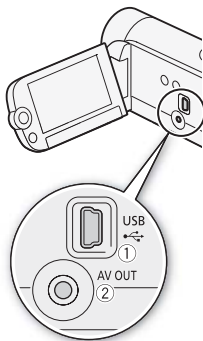

① **USB Terminal**

Access: Open the LCD panel.

② **AV OUT Terminal**

Access: Open the LCD panel.



Sound from the built-in speaker will be muted while the STV-250N Stereo Video Cable is connected to the camcorder. Adjust the volume on the connected TV.

Connection Diagrams

In the following connection diagrams, the left side shows the terminals on the camcorder and the right side shows (for reference only) an example of terminals on a connected device.

Type: Analog • Quality: Standard definition • Output only

Connect to a standard TV or a VCR with audio/video input terminals. Change the following settings on the camcorder:

-   [TV Type] according to the TV set (widescreen or 4:3), if the TV cannot automatically detect and change the aspect ratio

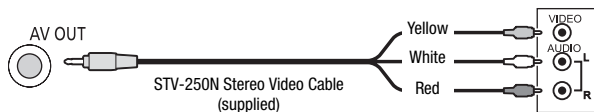
**Type: Digital data connection**

Connect to a computer to save your recordings.

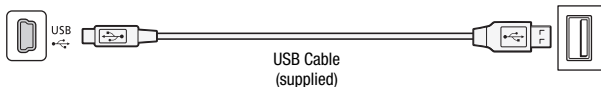
**i NOTES**

- Power the camcorder using the compact power adapter and only then connect it to the computer using the supplied USB cable if you want to transfer music files directly to a memory card in the camcorder in order to use them as background music.

Playback on a TV Screen

Connect the camcorder to a TV to enjoy your recordings with family and friends. Playback on an HDTV using one of the high-definition connections will ensure the best playback quality.

Operating modes:   |  



1 Turn off the camcorder and the TV.

2 Connect the camcorder to the TV.

Connection  (81).

3 Turn on the connected TV.

On the TV, select as the video input the same terminal to which you connected the camcorder. Refer to the instruction manual of the connected TV.

4 Turn on the camcorder and set it to  or  mode.

Play back the movies or photos.

NOTES

- We recommend powering the camcorder using the compact power adapter.
- When you play back your 16:9 movies on standard TV sets with a 4:3 aspect ratio, the TV set will switch automatically to widescreen mode if it is compatible with the Video ID-1 system. Otherwise, change the aspect ratio of the TV manually.

Saving and Sharing Your Recordings

Saving Recordings on a Computer

Movies and photos recorded with this camcorder are saved in the built-in memory (**FS40** only) or on the memory card. Because space is limited, make sure to save your recordings on a computer on a regular basis.

Installing the Supplied Software



With the supplied software **Transfer Utility** you can save scenes to your computer. Additionally, the supplied software **VideoBrowser** offers many options for organizing your video library, editing video and more.

Installation

Refer to the Installation Guide (supplied leaflet) and follow the instructions in the Software Guide (PDF file) to install the supplied PIXELA's software.



Connecting the Camcorder to a Computer

Operating modes:   |  

- 1 Turn on the camcorder and set it to  or  mode.**
 - We recommend powering the camcorder using the compact power adapter.
 - If the camcorder is connected to the computer while it is powered only by the battery pack, previously saved video files cannot be restored back to the camcorder and music files cannot be transferred from the supplied Camcorder Supplemental Disc to a memory card in the camcorder.
 - **FS40** Select in advance the memory that contains the recordings you wish to transfer.
- 2 Connect the camcorder to the computer using the supplied USB cable.**

Connection  (81).

mode: Transferring movies

- 3 **Camcorder:** When the connection is successfully established, [PC Connection] appears on the screen.
- 4 **Computer:** Depending on the software you chose to install, **Transfer Utility SD** or **VideoBrowser SD** will start up automatically.
 - **Transfer Utility SD:** Click [Video file import] to start transferring files. For details about using the software, click [Help] to open the Software Guide (PDF file).
 - **VideoBrowser SD:** Click  in the menu panel to start transferring files. For details about using the software, click  to open the Software Guide (PDF file).

mode: Transferring photos

- 3 **Camcorder:** When the connection is successfully established, [PC Connection] appears on the screen.
- 4 **Computer:** The camcorder will appear as a new device (or drive), for example, [Canon FS40]*. Use the program of your choice or the standard application built into your computer's operating system to transfer or copy your photos to the computer.
 - Windows 7/Vista: Your photos can be found under [Canon FS40]* > [Removable Storage] > [DCIM] > [xxxCANON], where "xxx" is a folder number between 101 and 998.
 - Windows XP: Your photos can be found under [Canon FS40]*.
 - Mac OS X: iPhoto will start up automatically and [Canon FS40]* will appear as a new device.

* The actual name of the device will show your camcorder's model.

IMPORTANT

- When the camcorder is connected to a computer:
 - Do not open the memory card slot cover and do not remove the memory card.
 - Do not change or delete any of the camcorder's folders or files directly from the computer as this may result in permanent data loss. Always use only the supplied PIXELA's software to save your movies on the computer.

- Operation may not work correctly depending on the software and the specifications/settings of your computer.
- If you wish to use the image files on your computer, make copies of them first. Use the copied files, retaining the originals.
- Observe the following precautions while the ACCESS indicator is on or flashing. Failing to do so may result in permanent data loss.
 - Do not open the memory card slot cover.
 - Do not disconnect the USB cable.
 - Do not turn off the camcorder or the computer.
 - Do not change the camcorder's operating mode.
- When restoring to the camcorder video files that were previously saved to the computer, do not disconnect the USB cable or turn off the camcorder or computer. Doing so may result in scenes that cannot be played back on the camcorder.

NOTES

- Refer also to the computer's instruction manual.
- Depending on the number of photos on the memory card (Windows: 2,500 photos or more; Macintosh: 1,000 photos or more), you may not be able to transfer photos to a computer. Try using a card reader.
- Always use the computer's Safely Remove Hardware function (Windows) or Eject function (Mac OS) to end the connection with the camcorder before disconnecting the USB cable and operating the camcorder.

Copying Movies to an External Video Recorder

You can copy your movies by connecting the camcorder to a VCR or a digital video recorder with analog audio/video inputs.





Operating modes:   |  

Connecting

Connect the camcorder to the VCR using Connection 1  (p. 81).

Recording

- 1 **External device: Load a blank cassette or disc and set the device to record pause mode.**

- 2 Turn on the camcorder and set it to  mode.
- 3 **Camcorder:** Locate the scene you wish to copy and pause the playback just before the desired scene.
- 4 **Camcorder:** Resume playback.
 - Push the joystick () to hide the joystick guide.
 - By default, on-screen displays will be embedded in the output video signal. You can change the displays by repeatedly pressing  ( 66).
- 5 **External device:** Start recording when the scene you wish to copy appears; stop recording when it ends.
- 6 **Camcorder:** Stop playback.

NOTES

- We recommend powering the camcorder using the compact power adapter.

Preparing Movies for the Web



You can convert your movies into MPEG files that you can easily upload to your favorite video sharing Web sites. Create the MPEG files in the camcorder and then connect the camcorder to a computer and use the supplied **PIXELA's** software to upload your videos to the Web.

Installing the Supplied Software

Refer to the Installation Guide (supplied leaflet) and follow the instructions in the Software Guide (PDF file) to install the supplied **PIXELA's** software.

Operating modes:   |  

Converting Scenes into MPEG Files

- 1 Power the camcorder using the compact power adapter.
- 2 Make sure there is enough available space in the memory that contains the scenes you want to convert.
- 3 Select (, ) the scene you want to convert.

4 Play back the scene and pause the playback where you want the conversion to begin.

5 Press **WEB**.

6 Select **(▶)** **[Yes]** and press **(SET)**.

- Press **(SET)** twice to interrupt the operation while it is in progress.
- The video from the point where you pressed **WEB** until the end of the scene (or up to 10 minutes in case of longer scenes) will be copied as a Web-friendly MPEG file.

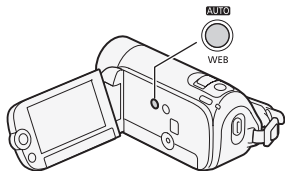

7 When the conversion is completed, a confirmation screen will appear.

Press **(SET)** and repeat steps 3 to 6 to convert additional scenes or continue with the procedure without pressing **(SET)** to upload your videos to the Web.

8 Connect the camcorder to the computer using the supplied USB cable.



- Connection **[2]** (📖 81).
- On the computer: Depending on the software you chose to install, **Transfer Utility SD** or **VideoBrowser SD** will start up automatically.

9 Computer: Click **[Web upload]** (**Transfer Utility SD**) or **(VideoBrowser SD)** and continue the operation following the software's indications.

For details about using the software, click **[Help]** (**Transfer Utility SD**) or  (**VideoBrowser SD**) to open the Software Guide (PDF file).

IMPORTANT

- While the camcorder is connected to the computer, do not open the memory card slot cover and do not remove the memory card.
- Observe the following precautions while the ACCESS indicator is on or flashing. Failing to do so may result in permanent data loss.
 - Do not open the memory card slot cover.
 - Do not disconnect the USB cable.
 - Do not disconnect the power source or turn off the camcorder or the computer.











- After you connect the camcorder to the computer, the supplied **PIXELA's** software will copy the MPEG video files to the computer and upload them to the Web, leaving behind a copy of the video files in the memory card. Use the   [Delete All Web Movies 

Uploading your Videos Wirelessly

If you used an Eye-Fi card to record your movies, after converting your movies to MPEG files, the video files will be uploaded wirelessly to the Web, directly from the camcorder. You will need to have installed the software supplied with your Eye-Fi card and completed all the required configuration setup in advance. For details about the configuration and the latest information on compatible Web sites, refer to Eye-Fi's homepage and the instruction manual of the Eye-Fi card. Please read the IMPORTANT section before using an Eye-Fi card.

1 Insert your Eye-Fi card in the camcorder and make sure there is sufficient available space on the card.

2 Convert the desired movie ( 86).

- When the conversion is completed, press .
- If you are within the range of a configured network, the wireless transfer will start automatically after the conversion is completed.
- The status of the wireless communication is shown by the Eye-Fi icon as follows:
 -  (grayed out) Communication not established
 -  (white, flashing) Connecting;  (white, continuously on) Wireless upload on standby
 -  (animated) Wireless upload in progress
 -  [Eye-Fi Communication] is set to [ Off]
 -  Wireless upload stopped by the camcorder ( 106)
 -  Error reading from the Eye-Fi card ( 105)

IMPORTANT



Using an Eye-Fi card:

- This product is not guaranteed to support Eye-Fi card functions (including wireless transfer). In case of an issue with an Eye-Fi card, please check with the card manufacturer. Also note that an approval is

required to use Eye-Fi cards in many countries or regions. Without approval, use of the card is not permitted. If it is unclear whether the card has been approved for use in the area, please check with the card manufacturer.

- Do not use Eye-Fi cards on airplanes and in other places where wireless communication is forbidden. Remove the Eye-Fi card from the camcorder beforehand.

NOTES

- Depending on the amount of data to be transferred or wireless signal conditions, uploading may take a long time. In addition, if wireless signal conditions worsen, uploading may be interrupted.
- Wireless transfer will decrease the effective usage time of the battery pack. You can power the camcorder using the compact power adapter so the battery pack will not be consumed.
- While files are being uploaded, the camcorder's automatic power off function will be disabled.
- The ACCESS indicator may flash periodically while the Eye-Fi card is in use.
- Wireless transfer is available only in playback mode. Any wireless transfer in progress will be stopped if you set the camcorder to recording mode.
- You can turn off the wireless communication with the   [Eye-Fi Communication]* setting.
- If the LOCK switch on the Eye-Fi card is set to prevent writing, you cannot change the [Eye-Fi Communication] setting. In such case, the  icon will appear on the screen. Change the position of the LOCK switch to change the setting.

* This menu option will appear only when using an Eye-Fi card.



Additional Information



















This chapter contains troubleshooting advice, screen messages, handling and maintenance tips, and other information.

Appendix: Menu Options Lists

Menu items not available appear grayed out. For details about how to select an item, refer to *Using the Menus* (📖 27). For details about each function, see the reference page. Menu options without a reference page are explained after the tables. Menu options in boldface indicate default values.



FUNC. Menu







Mode

Menu item	Setting options	
Recording programs	[P Programmed AE] [ Portrait], [ Sports], [ Snow], [ Beach], [ Sunset], [ Night Scene], [ Low Light], [ Spotlight], [ Fireworks]	51
White balance	[AWB Automatic], [ Daylight], [ Tungsten], [ Custom WB]	59
Image effects	[ Image Effect Off], [ Vivid], [ Neutral], [ Soft Skin Detail]	60
Digital effects	[ Digital Effect Off], [FT Fade Trigger]*, [E2 Wipe]*, [E1 Black & White], [E2 Sepia]	56
Recording mode*	[XP High Quality 9 Mbps], [SP Standard Play 6 Mbps], [LP Long Play 3 Mbps]	39

* For movies only.

Mode



-  : [Movies] index screen (original scenes)
-  : [Playlist] and [Playlist: Video Snapshot] index screens
-  : [Video Snapshot] index screen

Menu item	Setting options				
[Select Music]	[Off], list of music tracks	–	●	●	63
[Select]	[Individual Scenes], [Remove All Selections]	●	–	●	48
FS40 [Copy  → ] ¹	[All Scenes], [All Scenes (this date)], [This Scene], [Selected Scenes]	●	–	●	70
	[Playlist]	–	●	–	
[Add to Playlist]	[All Scenes (this date)], [This Scene], [Selected Scenes]	●	–	●	67
[Divide]	–	● ²	–	–	69
[Move]	–	–	●	–	68
[Delete]	[All Scenes], [All Scenes (this date)], [This Scene], [Selected Scenes]	●	–	●	49
	[All Scenes], [This Scene]	–	●	–	68
[Scene Search]	[Calendar Screen], [Date Selection]	●	–	●	46
[Menu]	Open the setup menus.	●	●	●	28

¹ Only for scenes recorded in the built-in memory.

² Not available for video snapshot scenes.







Mode

Menu item	[Photos] index screen	Single photo view	
[Select Music]	[Off], list of music tracks	–	63
[Select]	[Individual Photos], [Remove All Selections]	–	48
FS40 [Copy  → ] ¹	[All Photos], [This Photo], [Selected Photos]	[No], [Yes]	78
[Delete]	[All Photos], [This Photo], [Selected Photos]	[No], [Yes]	76
[Menu]	Open the setup menus.	–	28



¹ Only for photos recorded in the built-in memory.

Setup Menus

Camera Setup 1 (Mode)

Menu item	Setting options	
FS40 [Rec Media for Movies]	[Built-in Mem.], [Mem. Card]	35
FS40 [Rec Media for Photos]	[Built-in Mem.], [Mem. Card]	
[Widescreen]	[ON On], [OFF Off]	–
[Video Snapshot Length]	[2sec 2 sec], [4sec 4 sec], [8sec 8 sec]	–
[Self Timer]	[ON On ], [OFF Off]	61
[Onscreen Markers]	[OFF Off], [ Level (White)], [ Level (Gray)], [ Grid (White)], [ Grid (Gray)]	–

[Widescreen]: The camcorder uses the full width of the image sensor providing high-resolution 16:9 recordings.



















- Since the screen on the camcorder has an aspect ratio of 16:9, recordings with a 4:3 aspect ratio will appear in the center of the screen with black sidebars.
- Playing back a widescreen recording: TV sets compatible with the Video ID-1 system will automatically switch to wide (16:9) mode. Otherwise, change the aspect ratio of the TV manually. To play back on a TV with normal aspect ratio (4:3) change the   [TV Type] setting accordingly.
- The camcorder retains the last setting used even if you set the camcorder to **AUTO** mode.

[Video Snapshot Length]: Selects the length of video snapshot scenes.

[Onscreen Markers]: You can display a grid or a horizontal line at the center of the screen. Use the markers as a reference to make sure your subject is framed correctly (vertically and/or horizontally).

- Using the onscreen markers will not affect the recordings.



Camera Setup 2 (Mode)

Menu item	Setting options	
[Digital Zoom]	[ On], [ Off]	40
[Zoom Speed]	[ Variable], [ Speed 3], [ Speed 2], [ Speed 1]	40
[Image Stabilizer]	[ Dynamic], [ Standard], [ Off]	54
[Flicker Reduction]	[ Off], [ 50 Hz], [ 60 Hz]	–
[Auto Slow Shutter]	[ On], [ Off]	–
[Wind Screen]	[ Automatic], [ Off 	–



[Flicker Reduction]: If the screen starts to flicker when recording movies under fluorescent lights, change the setting to reduce the effect.

- Flicker reduction can be activated only when the recording program is set to [**P** Programmed AE].





[Auto Slow Shutter]: The camcorder automatically uses slow shutter speeds to obtain brighter recordings in places with insufficient lighting.

- Minimum shutter speed used: 1/30.
- The auto slow shutter can only be activated when the recording program is set to [**P** Programmed AE], but the setting will not change even if you set the camcorder to **AUTO** mode.
- If a trailing afterimage appears, set the slow shutter to [ Off].
- If  (camcorder shake warning) appears, we recommend stabilizing the camcorder, for example, by mounting it on a tripod.

[Wind Screen]: The camcorder automatically reduces the background sound of wind when recording outdoors.

- Some low-frequency sounds will be suppressed along with the sound of wind. When recording in surroundings unaffected by wind or if you want to record low-frequency sounds, we recommend setting the wind screen to [ Off .







Playback Setup (Mode)

Menu item	Setting options	
[Data Code]	[ Date], [ Time], [ Date and Time], [ Camera Data]	–

[Data Code]: Displays the date and/or time when the scene was recorded.

[ Camera Data]: Displays the aperture (f-stop) and shutter speed used when recording the scene.

System Setup 1

Menu item	Setting options				
[Output Onscreen Displays]	[ON On], [OFF Off]	●	–	–	–
[LCD Brightness]		●	●	●	–
[TV Type]	[4:3 Normal TV], [16:9 Wide TV]	–	●	●	–
[Speaker Volume]		–	●	●	–
[Demo Mode]	[ON On], [OFF Off]	●	–	–	–

[Output Onscreen Displays]: When set to [**ON** On], the camcorder's on-screen displays will appear also on the screen of a TV or monitor connected to the camcorder.

[LCD Brightness]: Adjusts the brightness of the LCD screen.



- Changing the brightness of the LCD screen does not affect the brightness of your recordings or the brightness of the playback image on a TV.

[TV Type]: When you connect the camcorder to a TV using the supplied STV-250N Stereo Video Cable, select the setting according to the type of TV in order to display the picture in full and in the correct aspect ratio.

[4:3** Normal TV]:** TV sets with 4:3 aspect ratio.

[16:9** Wide TV]:** TV sets with 16:9 aspect ratio.













- When the TV type is set to [**4:3** Normal TV], during the playback of video originally recorded with an aspect ratio of 16:9, the picture will not be displayed fullscreen.

[Speaker Volume]: Adjust ( ) the volume of the playback. You can also adjust the volume using the joystick guide ( 43).

[Demo Mode]: The demonstration mode displays the camcorder's main features. It starts automatically when the camcorder is powered with the compact power adapter if you leave it turned on without a memory card for more than 5 minutes.

- To cancel the demo mode once it has started, press any button or turn off the camcorder.

System Setup 2

Menu item	Setting options				
[Notification Sounds]	[ High Volume], [ > Low Volume], [OFF Off]	●	●	●	–
[Power Saving Mode]	[ON On], [OFF Off]	●	●	●	–
[Quick Start]	[OFF Off], [10min 10 min], [20min 20 min], [30min 30 min]	●	–	–	–
FS40 [Initialize  / ] FS400 [Initialize ]	FS40 [Built-in Mem.], [Mem. Card] [Quick Initialization], [Complete Initialization]	●	● ¹	●	35
[Delete All Web Movies 	[No], [Yes]	–	●	–	86
[Photo Numbering]	[ Reset], [ Continuous]	●	●	●	–
[Firmware]	–	–	–	●	–
[Eye-Fi Communication] ²	[A Automatic], [OFF Off]	●	●	●	88

¹ Option available only from the [Movies] or [Video Snapshot] index screen.

² Option available only after having inserted an Eye-Fi card in the memory card slot.

[Notification Sounds]: A beep will accompany some operations like turning on the camcorder, the self-timer countdown, etc.

[Power Saving Mode]: In order to save power when the camcorder is powered by a battery pack, it will automatically shut off if left without any operation for 5 minutes.

- Approximately 30 seconds before the camcorder shuts off, [Auto Power Off] will appear.
- In standby mode, the camcorder will shut off after the time selected for the [Quick Start] setting.

[Quick Start]: Select whether to activate the Quick Start function ( 41) when you close the LCD panel in a recording mode and the length of time after which the camcorder will end the standby mode and shut off automatically.

[Photo Numbering]: Select the photo numbering method to be used on a new memory card. Photos are automatically assigned consecutive num-

bers from 0101 to 9900, and stored in folders containing up to 100 photos. Folders are numbered from 101 to 998.







[ Reset]: Photo numbers will restart from 101-0101 every time you insert a new memory card.





[ Continuous]: Photo numbers will continue from the number following that of the last photo recorded with the camcorder.

- If the memory card you insert already contains a photo with a larger number, a new photo will be assigned a number one higher than that of the last photo on the memory card.
- We recommend using the [ Continuous] setting.
- The photo number indicates the name and location of the file on the memory card. For example, the file name of a photo numbered 101-0107 is “IMG_0107.JPG”, stored under the folder “DCIM\101\CANON”.

[Firmware]: You can verify the current version of the camcorder’s firmware. This menu option is usually unavailable.

Language and Date/Time Setup





Menu item	Setting options				
[Language 	[Česky], [Dansk], [Deutsch], [Ελληνικά], [English] , [Español], [Français], [Italiano], [Magyar], [Melayu], [Nederlands], [Norsk], [Polski], [Português], [Română], [Suomi], [Svenska], [Türkçe], [Русский], [Українська], [العربية], [فارسی], [ភាសាខ្មែរ], [简体中文], [繁體中文], [한국어], [日本語]	●	●	●	31
[Time Zone/DST]	[] (home time zone) or [] (travel time zone): [New York] , list of world time zones	●	●	●	31
[Date/Time]	–	●	●	●	30
[Date Format]	[Y.M.D AM/PM] (2011.1.1 AM 12:00), [Y.M.D 24H] (2011.1.1 0:00), [M.D,Y AM/PM] (Jan. 1, 2010 12:00 AM) , [M.D,Y 24H] (Jan. 1, 2011 0:00), [D.M.Y AM/PM] (1.Jan.2011 12:00 AM), [D.M.Y 24H] (1.Jan.2011 0:00)	●	●	●	–

Menu item	Setting options				
[Calendar Start Day]	[Saturday], [Sunday], [Monday]	–	●	–	–

[Date Format]: Select the date format to be used for most on-screen displays.



[Calendar Start Day]: Select the day on which the week starts for the calendar screen ( 46).

Information Screens

Menu item	Setting options				
FS40 [Memory Info]	–	●	●	●	–
[Memory Card Info]	–	●	●	●	–
[Battery Info]	–	●	●	●	–

[Memory Info]/[Memory Card Info]: Displays a screen where you can verify how much of the built-in memory (**FS40** only) or the memory card is currently in use ( total recording time and  total number of photos) and how much space remains available for recording.







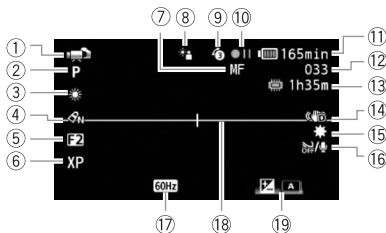

- Estimated figures about available movie recording time and available number of photos are approximate and based on the recording mode currently in use.
- **FS40** The total space for the built-in memory may be less than the capacity listed in *Specifications* ( 124).
- In the [Memory Card Info] screen you can verify also the Speed Class of the memory card.

[Battery Info]: Displays a screen where you can verify the battery charge (as a percentage) and the remaining recording time ( mode) or playback time (,  mode).

Appendix: Onscreen Icons and Displays







Recording Movies

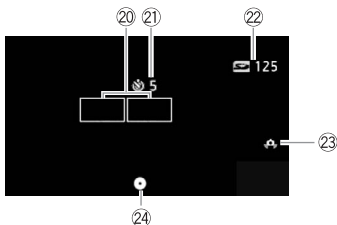

- ① Operating mode (25),
Zoom    (40),
Manual exposure    (57)
- ② Recording program (51)
- ③ White balance (59)
- ④ Image effect (60)
- ⑤ Digital effect (56)
- ⑥ Recording mode (39)
- ⑦ Manual focus (58)
- ⑧ Automatic backlight correction
(53)
- ⑨ Pre-recording (54)
- ⑩ Memory operation (101)
- ⑪ Remaining battery time (101)
- ⑫ While recording/during playback:
Scene counter (hours : minutes :
seconds)
In record pause mode:
Total number of scenes
- ⑬ Remaining recording time
 On the memory card
 In the built-in memory
(**FS40** only)
- ⑭ Image stabilizer (54)
- ⑮ Mini video light (61)
- ⑯ Wind screen off (93)
- ⑰ Flicker reduction (93)
- ⑱ Level marker (92)
- ⑲ Joystick guide (27)

Recording Photos



- ②0 AF frame ( 73)
- ②1 Self timer ( 61)
- ②2 Number of available photos
 -  On the memory card
 -  In the built-in memory(**FS40** only)
- ②3 Camcorder shake warning ( 93)
- ②4 Focus and exposure lock ( 73)

Playing Movies (During Playback)



- ⑲ Data code ( 66)
- ⑲ Scene number
- ⑳ Eye-Fi wireless communication ( 88)

Viewing Photos

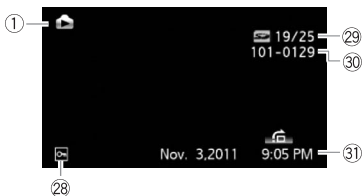

⑳ Protected photo mark (photos on the memory card that were protected using another device)

㉑ Current photo / Total number of photos

㉓ Photo number (📖 95)

㉔ Date and time of recording

⑩ Memory operation

- Record, ● || Record pause, ▶ Playback, || Playback pause, ▶▶ Fast playback, ◀◀ Fast reverse playback, ▶ Slow playback, ◀ Slow reverse playback

⑪ Remaining battery time

- The icon shows a rough estimate of the remaining charge as a percentage of the full charge of the battery pack.

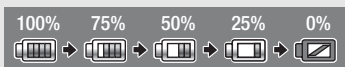

- When is displayed in red, replace the battery pack with a fully charged one.
- When you attach an empty battery pack, the power may turn off without displaying .
- Depending on the conditions under which the camcorder and the battery pack are used, the actual battery charge may not be indicated accurately.
- When the camcorder is off, press **[BATT. INFO]** to display the charge status of a battery pack. The Intelligent System will display the charge status (as a percentage) and the remaining recording time (in minutes) for 5 seconds. If the battery pack is exhausted, the battery information may not be displayed.

⑬ Remaining recording time

When there is no more free space on the memory, [End] (built-in memory, **FS40** only) or [End] (memory card) will be displayed and the recording will stop.

⑫ Number of available photos

in red: There is no memory card in the camcorder.

in green: 6 or more photos ➔ in yellow: 1 to 5 photos ➔ in red: No more photos can be recorded.

- When viewing the photos, the display will always be in green.
- Depending on the recording conditions, the number of available photos displayed may not decrease even after a recording has been made, or may decrease by 2 photos at once.

Troubleshooting

If you have a problem with your camcorder, refer to this section. Sometimes what you think is a malfunction of the camcorder may have the simplest of solutions - please read the "CHECK THIS FIRST" box before going on to the more detailed problems and solutions. Consult your dealer or a Canon Service Center if the problem persists.

CHECK THIS FIRST

Power supply

- Is the battery charged? Is the compact power adapter correctly connected to the camcorder? (□ 19)

Recording

- Did you turn the camcorder on and correctly set it to recording mode? (□ 25) If you are recording on a memory card, is one correctly inserted into the camcorder? (□ 34)

Playback

- Did you turn the camcorder on and correctly set it to playback mode? (□ 43, 74) If you are playing back recordings from a memory card, is one correctly inserted into the camcorder? (□ 34) Does it contain any recordings?

Power source

The camcorder will not turn on or it turns off by itself.

- The battery pack is exhausted. Replace or charge the battery pack.
- Remove the battery pack and reattach it correctly.

Cannot charge the battery pack.

- Make sure the camcorder is off so charging can start.
- The temperature of the battery pack is outside the charging range. If the battery pack's temperature is below 0 °C (32 °F), warm it before charging it; if it is above 40 °C (104 °F), let the battery pack cool down before charging it.
- Charge the battery pack in temperatures between 0 °C and 40 °C (32 °F and 104 °F).
- The battery pack is faulty. Replace the battery pack.
- The camcorder cannot communicate with the battery pack attached. Such battery packs cannot be charged using this camcorder.

A noise can be heard from the compact power adapter.

- A faint sound can be heard while the compact power adapter is connected to a power outlet. This is not a malfunction.

The battery pack is exhausted extremely quickly even at normal temperatures.

- The battery may have reached the end of its battery life. Buy a new battery pack.

Recording

Pressing **Start/Stop** will not start recording.

- You cannot record while the camcorder is writing previous recordings onto the memory (while the ACCESS indicator is on or flashing). Wait until the camcorder has finished.
- The memory is full or it already contains the maximum number of scenes (3,999 scenes). Delete some recordings (□ 49, 76) or initialize the memory (□ 35) to free some space.

The point where **Start/Stop** was pressed does not match the beginning/end of the recording.

- There is a slight interval between pressing **Start/Stop** and the actual start/end of recording. This is not a malfunction.
- When the pre-recording function is used, the beginning of the scene will differ from when **Start/Stop** was pressed.

The camcorder will not focus.

- Autofocus does not work on the subject. Focus manually (□ 58).
- The lens is dirty. Clean the lens with a soft lens-cleaning cloth (□ 118). Never use tissue paper to clean the lens.

Changing between recording (●)/record pause (●|||)/playback (▶) takes longer than usual.

- When the memory contains a large number of scenes, some operations may take longer than usual. Save your recordings (□ 83) and initialize the memory (□ 35).

Movies or photos cannot be recorded properly.

- This may occur as movies and photos are recorded/deleted over time. Save your recordings (□ 83) and initialize the memory (□ 35).

After using the camcorder for a long time, it becomes hot.

- The camcorder may become hot after using it continuously for long periods of time; this is not a malfunction. If the camcorder becomes unusually hot or it becomes hot after using it only for a short while, it may indicate a problem with the camcorder. Consult a Canon Service Center.

Playback

Cannot add scenes to the playlist.

- The playlist can contain a maximum of 99 scenes.
- You may not be able to add scenes to the playlist if they were recorded or edited using another device.

- The memory is full. Delete some recordings ( 49, 76) or initialize the memory ( 35) to free some space.



Cannot move scenes in the playlist.

- The memory is full. Delete some recordings ( 49, 76) or initialize the memory ( 35) to free some space.

Cannot delete a scene.

- You may not be able to delete scenes recorded or edited using another device.



Deleting scenes takes longer than usual.

- When the memory contains a large number of scenes, some operations may take longer than usual. Save your recordings ( 83) and initialize the memory ( 35).



Cannot delete a photo.

- Photos that were protected with other devices cannot be deleted with this camcorder.

When playing back scenes/slideshow with background music, the music track is not played back correctly.

- This can occur when you transfer the music files to a memory card after repeatedly recording and deleting scenes (fragmented memory). Save your recordings ( 83) and initialize the memory card ( 35). Then, transfer the music files first and only then write the video files back to the memory card.
- Music tracks will not play back correctly if the connection was interrupted while transferring the music files. Delete the music tracks and transfer the music files again.
- The transfer rate of the memory card used is too slow. Use a recommended memory card ( 32).

Cannot divide scenes

- You cannot divide scenes recorded or edited using another device.
- The memory is full. Delete some recordings ( 49, 76) or initialize the memory ( 35) to free some space.

FS40 Cannot copy scenes/photos

- You may not be able to copy scenes/photos recorded or edited using another device.

Cannot mark individual scenes/photos in the index screen with a checkmark ✓.

- You cannot select more than 100 scenes/photos individually. Reduce the number of selected scenes/photos.

Indicators and Onscreen Displays

lights up in red.

- Battery pack is exhausted. Replace or charge the battery pack.

 appears on the screen.

- The camcorder cannot communicate with the battery pack attached so the remaining battery time cannot be displayed.

 lights up in red.

- A memory card error occurred. Turn off the camcorder. Remove and reinsert the memory card. Initialize the memory card if the display does not change back to normal.
- The memory card is full. Replace the memory card or delete some recordings ( 49, 76) to free some space on the memory card.

Even after stopping recording, the ACCESS indicator does not go off.

- The scene is being recorded in the memory. This is not a malfunction.

The red ON/OFF (CHG) indicator flashes rapidly ( one flash at 0.5-second intervals).

- Charging has stopped because the compact power adapter or the battery pack is faulty. Consult a Canon Service Center.

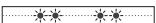
The red ON/OFF (CHG) indicator flashes ( two flashes at 1-second intervals)

- The remaining charge of the battery pack is at least 50% of a full charge. This is not a malfunction.

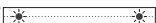
The red ON/OFF (CHG) indicator flashes very slowly ( one flash at 2-second intervals).

- The temperature of the battery pack is outside the charging range. If the battery pack's temperature is below 0 °C (32 °F), warm it before charging it; if it is above 40 °C (104 °F), let the battery pack cool down before charging it.
- Charge the battery pack in temperatures between 0 °C and 40 °C (32 °F and 104 °F).
- The battery pack is damaged. Use a different battery pack.

 appears on the screen.

- The LOCK switch on the Eye-Fi card is set to prevent accidental erasure. Change the position of the LOCK switch.
- An error occurred when trying to access control data on the Eye-Fi card. Turn the camcorder off then on again. If the icon appears often, there might be a problem with the Eye-Fi card. Contact the card manufacturer's customer care.

Picture and Sound

Screen displays turn on and off repeatedly.

- The battery pack is exhausted. Replace or charge the battery pack.
- Remove the battery pack and reattach it correctly.

Abnormal characters appear on the screen and the camcorder does not operate properly.

- Disconnect the power source and reconnect it after a short time. If the problem still persists, remove the battery pack and disconnect all other power sources from the camcorder. Then, press the RESET button with a pointed object to reset all the camcorder's settings to default values.

Video noise appears on screen.

- Keep a distance between the camcorder and devices that emit strong electromagnetic fields (plasma TVs, cellular phones, etc.).

Sound is distorted or is recorded at lower levels.

- When recording near loud sounds (such as fireworks, shows or concerts), sound may become distorted or it may not be recorded at the actual levels.

The picture is displayed correctly but there is no sound from the built-in speaker.

- Speaker volume is turned off. Adjust the volume.
- If the STV-250N Stereo Video Cable is connected to the camcorder, disconnect it.

Memory Card and Accessories

Cannot insert the memory card.

- The memory card was not facing the correct direction. Turn the memory card over and insert it.

Cannot record on the memory card.

- The memory card is full. Delete some recordings (📖 49, 76) to free some space or replace the memory card.
- Initialize the memory card (📖 35) when you use it with the camcorder for the first time.
- The LOCK switch on the memory card is set to prevent accidental erasure. Change the position of the LOCK switch.
- A compatible memory card must be used to be able to record movies on a memory card (📖 32).
- The folder and file numbers have reached their maximum value. Set [📁] ➡ [Photo Numbering] to [Reset] and insert a new memory card.

Cannot upload files using an Eye-Fi card.

- Files cannot be uploaded when [📶] ➡ [Eye-Fi Communication] is set to [Off] (when 📴 appears on the screen). Change this setting to [Automatic].
- Opening the LCD panel may improve wireless signal conditions.
- During wireless transfer, transfer may stop when the wireless signal conditions worsen (📶 appears on the screen). Perform wireless transfer in a place with good signal conditions.
- Contact the card manufacturer's customer care.

Connections with External Devices

Video noise appears on the TV screen.

- When using the camcorder in a room where a TV is located, keep a distance between the compact power adapter and the power or antenna cables of the TV.

Playback looks fine on the camcorder but there is no image on the TV screen.

- The video input on the TV is not set to the video terminal to which you connected the camcorder. Select the correct video input.

The computer does not recognize the camcorder even though the camcorder is connected correctly.

- Disconnect the USB cable and turn off the camcorder. After a short while, turn it on again and restore the connection.
- Connect the camcorder to a different USB port on the computer.
- The camcorder will not be recognized while all photos are being deleted.

Cannot save photos on my computer's hard disk.

- When the memory contains 2,500 photos (Windows)/1,000 photos (Mac OS) or more, you may not be able to transfer photos to a computer. Try using a card reader to transfer the photos on the memory card. **FS40** To transfer the photos in the built-in memory, copy them to the memory card in advance (📖 78).

List of Messages (in alphabetical order)

Accessing the memory card. Do not remove the memory card.

- You opened the memory card slot cover while the camcorder was accessing the memory card or the camcorder started accessing the memory card as you opened the memory card slot cover. Do not remove the memory card until this message disappears.

Back up recordings regularly

- This message may appear when you turn on the camcorder. In the event of a malfunction, recordings may be lost so back up your recordings regularly.

Buffer overflow. Recording was stopped.

- The data transfer rate was too high for the memory card in use and the recording was stopped. Replace the memory card with one rated Speed Class 2, 4, 6 or 10.
- After repeatedly recording, deleting and editing scenes (fragmented memory), it will take longer to write data on the memory and recording may stop. Save your recordings (📖 83) and initialize the memory (📖 35).

FS40 Built-in memory error

- The built-in memory could not be read. Contact a Canon Service Center.

FS40 Built-in memory is full

- The built-in memory is full ([End] appears on the screen). Delete some recordings ([49, 76]) to free some space or save your recordings ([83]) and initialize the built-in memory ([35]).

Built-in memory writing error Attempt recovering the data?

- This message will appear the next time you turn on the camcorder if power supply was accidentally interrupted while the camcorder was writing in the built-in memory. Select [Recover] to try to recover the recordings.

FS40 Cannot access the built-in memory

- There is a problem with the built-in memory. Contact a Canon Service Center.

Cannot communicate with the battery pack. Continue using this battery pack?

- You attached a battery pack that is not recommended by Canon for use with this camcorder.
- If you are using a battery pack recommended by Canon for use with this camcorder, there may be a problem with the camcorder or battery pack. Consult a Canon Service Center.

FS40 Cannot copy

- The total size of the scenes you selected to copy exceeds the available space on the memory card. Delete some recordings on the memory card ([49, 76]) or reduce the number of scenes to copy.
- The memory card already contains the maximum number of scenes (3,999 scenes). Delete some scenes ([49]) to free some space.

Cannot divide the scene. Initialize only using the camcorder.

- The scene could not be divided because the camcorder's internal scene management data log is full. Save your recordings ([83]) and initialize the memory ([35]). Then, write the video files back to the memory and try dividing the scene again.

Cannot edit

- Could not move a scene in the playlist. Delete some scenes from the playlist ([68]).

Cannot enter standby mode now

- The camcorder cannot enter standby mode if the remaining battery charge is too low. Charge or replace the battery pack ([19]).

Cannot play back

- There is a problem with the memory. If this message appears often without apparent reason, contact a Canon Service Center.

FS40 Cannot play back Cannot access the built-in memory

- There is a problem with the built-in memory. Save your recordings ([83]) and initialize the built-in memory using the [Complete Initialization] option ([35]). If the problem persists, contact a Canon Service Center.

Cannot play back Check the memory card

- There is a problem with the memory card. Save your recordings (☞ 83) and initialize the memory card using the [Complete Initialization] option (☞ 35). If the problem persists, use a different memory card.

FS40 Cannot play the movies in the built-in memory Initialize only using the camcorder

- The camcorder's built-in memory was initialized using a computer. Initialize the built-in memory with this camcorder (☞ 35).

Cannot play the movies on this memory card

- Movies cannot be played back from a 64 MB or smaller memory card. Use a recommended memory card (☞ 32).

Cannot play the movies on this memory card Initialize only using the camcorder

- The memory card in the camcorder was initialized using a computer. Initialize the memory card with this camcorder (☞ 35).

Cannot record

- There is a problem with the memory. If this message appears often without apparent reason, contact a Canon Service Center.

FS40 Cannot record Cannot access the built-in memory

- There is a problem with the built-in memory. Save your recordings (☞ 83) and initialize the built-in memory using the [Complete Initialization] option (☞ 35). If the problem persists, contact a Canon Service Center.

Cannot record Check the memory card

- There is a problem with the memory card. Save your recordings (☞ 83) and initialize the memory card using the [Complete Initialization] option (☞ 35). If the problem persists, use a different memory card.

FS40 Cannot record movies in the built-in memory Initialize only using the camcorder

- The camcorder's built-in memory was initialized using a computer. Initialize the built-in memory with this camcorder (☞ 35).

Cannot record movies on this memory card

- Movies cannot be recorded on a 64 MB or smaller memory card. Use a recommended memory card (☞ 32).

Cannot record movies on this memory card Initialize only using the camcorder



- The memory card in the camcorder was initialized using a computer. Initialize the memory card with this camcorder (☞ 35).

Change the battery pack

- Battery pack is exhausted. Replace or charge the battery pack.

Check the memory card

- Cannot access the memory card. Check the memory card and make sure it is inserted correctly.

- A memory card error occurred. The camcorder cannot record or display the image. Try removing and reinserting the memory card, or use a different memory card.
- You inserted a MultiMedia Card (MMC) into the camcorder. Use a recommended memory card (□ 32).
- If after the message disappears,  appears in red, perform the following: Turn off the camcorder and remove and reinsert the memory card. If  turns back to green you can resume recording/playback. If the problem persists, save your recordings (□ 83) and initialize the memory card (□ 35).

Could not add the scene(s) to the playlist

- One or more scenes could not be added to the playlist. The playlist can contain a maximum of 99 scenes. Delete some scenes from the playlist (□ 68).



Do not disconnect the USB cable or the power source until you safely end the connection from the computer. Cannot write data with this connection. To write data to the camcorder, connect the compact power adapter then reconnect the camcorder and computer.

- The camcorder cannot be operated while it is not being powered by the compact power adapter and is connected to a computer with the supplied USB cable. In addition, scenes cannot be written back and music files cannot be transferred to the camcorder. To avoid corrupting the data in the camcorder's memory, use the computer's Safely Remove Hardware function to end the connection and disconnect the USB cable before using the camcorder.
- To be able to write back scenes and to transfer music files to the camcorder, use the computer's Safely Remove Hardware function to end the connection, disconnect the USB cable, power the camcorder using the compact power adapter and only then connect it to the computer again.

Do not disconnect the USB cable or the power source until you safely end the connection from the computer. Connect the compact power adapter

- When the camcorder is in  mode and is connected to the computer with the supplied USB cable, the camcorder cannot be operated. Disconnecting the USB cable or power source while this message appears may result in permanent loss of the recordings in the camcorder. Use the computer's Safely Remove Hardware function to end the connection and disconnect the USB cable before using the camcorder.
- To be able to write back scenes and to transfer music files to the camcorder, power the camcorder using the compact power adapter and only then connect it to the computer using the supplied USB cable.

File name error

- The folder and file numbers have reached their maximum value. Set   [Photo Numbering] to [Reset] and delete all the photos on the memory card (□ 76) or initialize it (□ 35).

Initialize only using the camcorder

- There is a problem with the file system that prevents accessing the selected memory. Initialize the memory with this camcorder (□ 35).

May not be possible to record movies on this memory card

- You inserted a memory card without a Speed Class rating. Replace the memory card with one rated Speed Class 2, 4, 6 or 10.

FS40 Mem. Card Number of scenes already at maximum

- The memory card already contains the maximum number of scenes (3,999 scenes); no further scenes can be copied onto the memory card. Delete some scenes (☐ 49) to free some space.

Mem. Card Unable to recognize the data

- The memory card contains scenes recorded using a video configuration that is not supported (PAL or SECAM). Play back the recordings in the memory card with the device originally used to record them.

Memory card cover is open

- After inserting a memory card, close the memory card slot cover (☐ 34).

Memory card is full

- The memory card is full. Delete some recordings (☐ 49, 76) to free some space or replace the memory card.

Memory card is write-protected

- The LOCK switch on the memory card is set to prevent accidental erasure. Change the position of the LOCK switch.

Memory card writing error Attempt recovering the data?

- This message will appear the next time you turn on the camcorder if power supply was accidentally interrupted while the camcorder was writing on the memory card. Select [Recover] to try to recover the recordings. If you removed the memory card and used it with another device after this happened, we recommend you select [Give Up].

Need to recover files from the memory card. Change the position of the LOCK switch on the memory card.

- This message will appear the next time you turn on the camcorder if power supply was accidentally interrupted while the camcorder was writing on the memory card and later the position of the card's LOCK switch was changed to prevent erasure. Change the position of the LOCK switch.

No memory card

- Insert a compatible memory card into the camcorder (☐ 32).

No photos

- There are no photos to play back. Have fun taking some photos (☐ 73).

No scenes

- There are no scenes in the index screen selected. Have fun shooting some movies (☐ 38).

Not enough available space

- The scene could not be divided because there was not enough available space in the memory. Delete some scenes (☞ 49).

Number of scenes already at maximum

- The maximum number of scenes (3,999 scenes) has been reached. Delete some scenes (☞ 49) to free some space.

Playlist is full. Cannot divide the scene.

- Scenes cannot be divided when the playlist already contains 99 scenes. Delete some scenes from the playlist (☞ 68).

Scene recorded using another device. Cannot divide the scene.

- Scenes recorded using another device cannot be divided with this camcorder.

Some photos could not be deleted

- Photos that were protected with other devices cannot be deleted with this camcorder.

Some scenes could not be added to the playlist

- Scenes that were not recorded with this camcorder cannot be added to the playlist.
- The playlist can contain a maximum of 99 scenes. Delete some scenes from the playlist (☞ 68).

Some scenes could not be deleted

- Movies that were protected/edited with other devices cannot be deleted with this camcorder.

Some scenes were recorded using another device and cannot be copied.

- Scenes that were not recorded with this camcorder cannot be copied to the memory card.

Some Web movies could not be deleted

- One or more MPEG files may have been accessed and protected using the computer. Such files cannot be deleted using the camcorder.

Task in progress. Do not disconnect the power source.

- The camcorder is updating the memory. Wait until the operation ends and do not disconnect the compact power adapter or remove the battery pack.

This photo could not be deleted

- Photos that were protected with other devices cannot be deleted with this camcorder.

This photo cannot be displayed

- You may not be able to display photos taken with other devices or image files created or edited on a computer.

This scene was recorded using another device and cannot be added to the playlist.

- Scenes that were not recorded with this camcorder cannot be added to the playlist.

This scene was recorded using another device and cannot be copied.

- Scenes that were not recorded with this camcorder cannot be copied to the memory card.

To use this function, switch out of  mode

- You pressed a button that cannot be used in  mode. Press  to set the camcorder to flexible recording mode.



Too many photos. Disconnect the USB cable.

- Disconnect the USB cable. Try using a memory card reader or decrease the number of photos on the memory card to fewer than 2,500 photos (Windows) or 1,000 photos (Mac OS). Disconnect the USB cable, and restore the connection after a short while.
- If a dialog box appeared on the computer screen, close it. Disconnect the USB cable, and restore the connection after a short while.

Unable to recognize the data

- You transferred data to the camcorder recorded using a video configuration that is not supported (PAL or SECAM).

Unable to recover data

- Could not recover a corrupted file. Save your recordings ( 83) and initialize the memory using the [Complete Initialization] option ( 35).

Handling Precautions

Camcorder

Be sure to observe the following precautions to ensure maximum performance.

- **Save your recordings periodically.** Make sure to transfer your recordings to an external device such as a computer or digital video recorder (□ 83) and save them on a regular basis. This will protect your important recordings in case of damage and create more free space on the memory. Canon shall not be liable for any data loss.
- Do not carry the camcorder by the LCD panel. Be careful when closing the LCD panel. When using a wrist strap, do not allow the camcorder to swing and hit an object.
- Do not leave the camcorder in places subject to high temperatures (like the inside of a car parked under direct sunlight), or high humidity.
- Do not use the camcorder near strong electromagnetic fields such as above TVs, near plasma TVs or mobile phones.
- Do not point the lens at strong light sources. Do not leave the camcorder pointed at a bright subject.
- Do not use or store the camcorder in dusty or sandy places. The camcorder is not waterproof – avoid also water, mud or salt. If any of the above should get into the camcorder it may damage the camcorder and/or the lens.
- Be careful of heat generated by lighting equipment.
- Do not disassemble the camcorder. If the camcorder does not function properly, consult qualified service personnel.
- Handle the camcorder with care. Do not subject the camcorder to shocks or vibration as this may cause damage.
- Be sure to keep the battery compartment cover closed even when the camcorder is powered using the compact power adapter alone, without a battery pack.
- When mounting the camcorder on a tripod, make sure that the tripod's fastening screw is shorter than 5.5 mm (0.2 in.). Using other tripods may damage the camcorder.

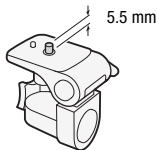

- **When recording movies, try to get a calm, stable picture.** Excessive camcorder movement while shooting and extensive use of fast zooms and panning can result in jittery scenes. In extreme cases, the playback of such scenes may result in visually induced motion sickness. If you experience such a reaction, immediately stop the playback and take a rest break as necessary.

Long-term storage

If you do not intend to use the camcorder for a long time, store it in a place free of dust, in low humidity, and at temperatures not higher than 30 °C (86 °F).

Battery Pack

DANGER!

Treat the battery pack with care.

- Keep it away from fire (or it might explode).
 - Do not expose the battery pack to temperature higher than 60 °C (140 °F). Do not leave it near a heater or inside a car in hot weather.
 - Do not try to disassemble or modify it.
 - Do not drop it or subject it to shocks.
 - Do not get it wet.
- Dirty terminals may cause a poor contact between the battery pack and the camcorder. Wipe the terminals with a soft cloth.

Long-term storage

- Store battery packs in a dry place at temperatures no higher than 30 °C (86 °F).
- To extend the battery life of the battery pack, discharge it completely before storing it.
- Charge and discharge all your battery packs fully at least once a year.

Remaining battery time

If the remaining battery time displayed is not correct, charge the battery pack fully. Still, the correct time may not be displayed if a fully charged battery pack is used continuously in high temperatures or it is left unused for long periods of time. Also, the correct remaining time may not be dis-

played, depending on the battery life. Use the time shown on the screen as an approximation.

Regarding the use of non-Canon battery packs

- For your safety, battery packs that are not genuine Canon battery packs will not be charged even if you attach them to this camcorder or to the optional CG-800 Battery Charger.
- We recommend using genuine Canon battery packs bearing the Intelligent System mark.
- If you attach to the camcorder battery packs that are not genuine Canon battery packs,  will appear and the remaining battery time will not be displayed.

 Intelligent Li-ion Battery

Memory Card

- We recommend backing up the recordings on the memory card onto your computer. Data may be corrupted or lost due to memory card defects or exposure to static electricity. Canon shall not be liable for lost or corrupted data.
- Do not touch or expose the terminals to dust or dirt.
- Do not use memory cards in places subject to strong magnetic fields.
- Do not leave memory cards in places subject to high humidity and high temperature.
- Do not disassemble, bend, drop, or subject memory cards to shocks and do not expose them to water.
- Check the direction before inserting the memory card. Forcing a memory card into the slot if it is not correctly oriented may damage the memory card or the camcorder.
- Do not attach any labels or stickers on the memory card.
- Secure Digital (SD) memory cards have a physical switch to prevent writing on the card so as to avoid the accidental erasure of the card's content. To write-protect the memory card set the switch to the LOCK position.

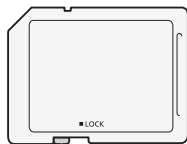

LOCK switch

Built-in Rechargeable Lithium Battery

The camcorder has a built-in rechargeable lithium battery to keep the date/time and other settings. The built-in lithium battery is recharged while you use the camcorder; however, it will discharge completely if you do not use the camcorder for about 3 months.

To recharge the built-in lithium battery: Connect the compact power adapter to the camcorder and leave it connected for 24 hours with the camcorder off.

Disposal

When you delete movies or initialize the memory, only the file allocation table is altered and stored data is not physically erased. Take the necessary precautions when you dispose of the camcorder or memory card, for example by physically damaging it to prevent the leakage of private data.

If giving the camcorder or memory card to another person, initialize the built-in memory (**FS40** only) or memory card using the [Complete Initialization] option (📖 35). Fill it up with unimportant recordings, and then initialize it again using the same option. This makes recovering the original recordings very difficult.

Maintenance/Others

Cleaning

Camcorder Body

- Use a soft, dry cloth to clean the camcorder body. Never use chemically treated cloths or volatile solvents such as paint thinner.

Lens

- If the lens surface is dirty, autofocus may not work properly.
- Remove any dust or dirt particles using a non-aerosol type blower brush.
- Use a clean, soft lens-cleaning cloth to gently wipe the lens. Never use tissue paper.

LCD Screen

- Clean the LCD screen using a clean, soft lens-cleaning cloth.
- Condensation may form on the surface of the screen when the temperature changes suddenly. Wipe it with a soft dry cloth.

Condensation

Moving the camcorder rapidly between hot and cold temperatures may cause condensation (water droplets) to form on its internal surfaces. Stop using the camcorder if condensation is detected. Continued use may damage the camcorder.

Condensation may form in the following cases:

- When the camcorder is moved quickly from cold to warm places
- When the camcorder is left in a humid room
- When a cold room is heated rapidly

To avoid condensation

- Do not expose the camcorder to sudden or extreme changes in temperature.
- Remove the memory card and battery pack. Then, place the camcorder in an airtight plastic bag and let it adjust gradually to temperature changes before removing it from the bag.

When condensation is detected

The camcorder automatically shuts off.

The precise time required for water droplets to evaporate will vary depending on the location and weather conditions. As a general rule, wait for 2 hours before resuming use of the camcorder.

Using the Camcorder Abroad

Power Sources

You can use the compact power adapter to operate the camcorder and to charge battery packs in any country with power supply between 100 and 240 V AC, 50/60 Hz. Consult a Canon Service Center for information on plug adapters for overseas use.

Playback on a TV Screen

You can only play back your recordings on TVs compatible with the NTSC system. NTSC is used in the following regions/countries:

Americas: All of North America and Central America; most Caribbean islands (except in French territories like Guadeloupe and Martinique); most of South America (except in Argentina, Brazil and Uruguay). **Asia:** Only in Japan, the Philippines, South Korea, Taiwan and Myanmar. **Oceania:** US territories (Guam, American Samoa, etc.) and some Pacific islands like Micronesia, Samoa and Tonga.

Accessories (Availability differs from area to area)

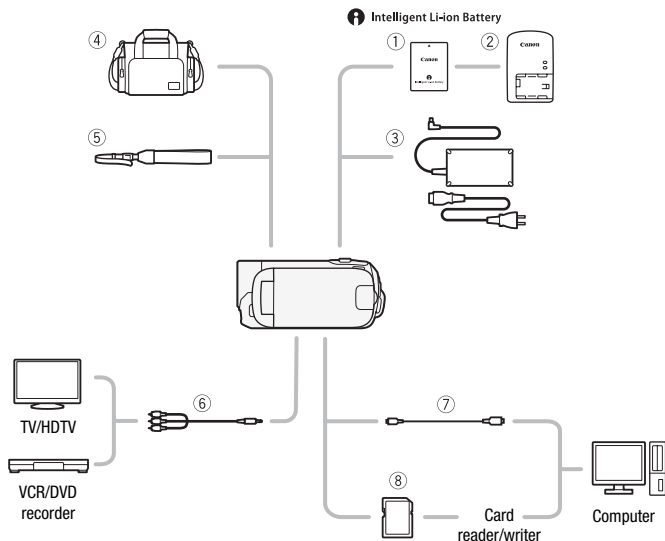

Optional accessories not listed below are described in more detail in the following pages.

③ CA-570 Compact Power Adapter

⑦ IFC-300PCU/S USB Cable

⑤ WS-20 Wrist Strap

⑧ Memory card

⑥ STV-250N Stereo Video Cable

Optional Accessories

Call or visit your local retailer/dealer for genuine Canon video accessories. You can also obtain genuine accessories for your Canon camcorder by calling: 1-800-828-4040, Canon U.S.A. Information Center.

Use of genuine Canon accessories is recommended.

This product is designed to achieve excellent performance when used with genuine Canon accessories. Canon shall not be liable for any damage to this product and/or accidents such as fire, etc., caused by the malfunction of non-genuine Canon accessories (e.g., a leakage and/or explosion of a battery pack). Please note that this warranty does not apply to repairs arising out of the malfunction of non-genuine Canon accessories, although you may request such repairs on a chargeable basis.

① Battery Pack

When you need extra battery packs, make sure you select the BP-808.

Intelligent Li-ion Battery

When you use battery packs bearing the Intelligent System mark, the camcorder will communicate with the battery and display the remaining usage time (accurate to 1 minute). You can only use and charge these battery packs with camcorders and chargers compatible with Intelligent System.



② CG-800 Battery Charger

Use the battery charger to charge the battery packs. It plugs directly into a power outlet without a cable.

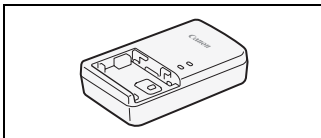

Charging, Recording and Playback Times

The charging times given in the following table are approximate and vary according to charging conditions and initial charge of the battery pack.

Charging conditions	Charging time
Using the camcorder	140 min.*
Using the CG-800 Battery Charger	105 min.

* When the camcorder charges an exhausted battery pack for the first 20 minutes, it can be used for 3 times longer than it was charged. In other words, you can record with the camcorder for 60 minutes after a 20-minute charge.

Recording and playback times given in the following tables are approximate and vary according to recording mode and charging, recording or playback conditions. The effective usage time of the battery pack may decrease when recording in cold surroundings, when using the brighter screen settings, etc.

Recording mode →	XP	SP	LP
Usage time ↓			
Maximum recording time	220 min.	225 min.	225 min.
Typical recording time*	110 min.	115 min.	115 min.
Playback time	320 min.	320 min.	325 min.

* Approximate times for recording with repeated operations such as start/stop, zooming, and power on/off.

④ SC-2000 Soft Carrying Case

A handy camcorder bag with padded compartments and plenty of space for accessories.



This mark identifies genuine Canon video accessories. When you use Canon video equipment, we recommend Canon-brand accessories or products bearing the same mark.



Product Codes

Provided Accessories

CA-570 Compact Power Adapter	8468A002AA
BP-808 Battery Pack	2740B002AA
STV-250N Stereo Video Cable	3067A002AA (D82-0590-002)

Optional Accessories

CG-800 Battery Charger	2590B002AA
WS-20 Wrist Strap	3118A002AA
SC-2000 Soft Carrying Case	9389A001AA
IFC-300PCU USB Cable	6906A001AA

Specifications

FS40 / FS400

♦ — Values given are approximate figures.

System

• Recording System

Movies: SD-Video Video compression: MPEG-2;
Audio compression: Dolby Digital 2ch

Photos: DCF (Design rule for Camera File system)
Image compression: JPEG (Super Fine)
Size of Photos: 1024x768 pixels

• Video Signal Configuration

EIA standard (525 lines, 60 fields) NTSC color signal

• Recording Media

- **FS40** Built-in memory: 8 GB
- SD, SDHC (SD High Capacity) or SDXC (SD eXtended Capacity) memory card (not included)

• Maximum Recording Time♦

FS40 8 GB built-in memory:

XP mode: 1 hr. 50 min. **SP** mode: 2 hr. 45 min. **LP** mode: 5 hr. 10 min.

Commercially available 16 GB memory card:

XP mode: 3 hr. 40 min. **SP** mode: 5 hr. 30 min. **LP** mode: 10 hr. 25 min.

• Image Sensor

1/6-inch CCD, 680,000 pixels♦

Effective pixels♦:

Movies: 16:9, advanced zoom¹: 450,000 (**W**)/360,000 (**T**)² pixels
16:9, optical/digital zoom³: 360,000 pixels
4:3 movies⁴: 340,000 pixels

Photos: 450,000 pixels

(1) [Image Stabilizer] set to [Off] or [Standard]. (2) **W** - at full wide angle, **T** - at full telephoto.

(3) [Image Stabilizer] set to [Dynamic]. (4) [Widescreen] set to [Off].

• LCD Screen: 2.7 in., wide, TFT color, approx. 112,000 dots

• Microphone: Stereo electret condenser microphone

• Lens

f=2.6-96.2 mm, F/2.0-5.2, 37x optical zoom

35 mm equivalent♦:

Movies: 16:9, advanced zoom¹: 41.3 – 1695 mm
16:9, optical/digital zoom²: 45.8 – 1695 mm
4:3 movies³: 49.8 – 1843 mm

Photos: 43.6 – 1613 mm

(1) [Image Stabilizer] set to [Off] or [Standard]. (2) [Image Stabilizer] set to [Dynamic].

(3) [Widescreen] set to [Off].

- **Lens Configuration:** 10 elements in 8 groups (1 double-sided, aspheric element)
- **AF System**
TTL autofocus or Manual focus (for movies only)
- **Minimum Focusing Distance**
1 m (3.3 ft.); 1 cm (0.39 in.) at full wide angle
- **White Balance**
Auto white balance, Custom white balance or Preset white balance settings:
Daylight, Tungsten
- **Minimum Illumination**
1.3 lx ([Low Light] recording program)
5.0 lx ([Programmed AE] recording program, Auto slow shutter [On])
- **Recommended Illumination:** More than 100 lx
- **Image Stabilization:** Electronic ([Dynamic] setting available when recording movies)

Terminals

- **AV OUT Terminal**
Ø 3.5 mm minijack; output only
Video: 1 V_{p-p} / 75 Ω unbalanced
Audio: -10 dBV (47 kΩ load) / 3 kΩ or less
- **USB Terminal:** mini-B, USB 2.0 (Hi-Speed USB)

Power/Others

- **Power supply (rated)**
7.4 V DC (battery pack), 8.4 V DC (compact power adapter)
- **Power consumption**♦
1.6 W (SP mode, AF on, LCD normal brightness)
Maximum rated power consumption: 8.7 W
- **Operating temperature:** 0 – 40 °C (32 – 104 °F)
- **Dimensions**♦ [W x H x D] (excluding the grip belt): 53 x 59 x 122 mm (2.1 x 2.3 x 4.8 in.)
- **Weight**♦ (camcorder body only): 220 g (7.8 oz.)

CA-570 Compact Power Adapter

- **Power supply:** 100 – 240 V AC, 50/60 Hz
- **Rated output / consumption:** 8.4 V DC, 1.5 A / 29 VA (100 V) – 39 VA (240 V)
- **Operating temperature:** 0 – 40 °C (32 – 104 °F)
- **Dimensions**♦: 52 x 29 x 90 mm (2.1 x 1.1 x 3.5 in.)
- **Weight**♦: 135 g (4.8 oz.)

BP-808 Battery Pack

- **Battery type**
Rechargeable lithium ion battery, compatible with Intelligent System
- **Rated voltage:** 7.4 V DC
- **Operating temperature:** 0 – 40 °C (32 – 104 °F)
- **Battery capacity:** 890 mAh (typical); 6.3 Wh / 850 mAh (minimum)
- **Dimensions** ♦: 30.7 x 23.3 x 40.2 mm (1.2 x 0.92 x 1.6 in.)
- **Weight** ♦: 46 g (1.6 oz)

Weight and dimensions are approximate. Errors and omissions excepted.
The information in this manual is verified as of December 2010. Subject to change without notice.

About the music files

The specifications of the music files compatible with the cam-corder are as follows.

Audio encoding: Linear PCM

Audio sampling: 48 kHz, 16 bits, 2 channels

Minimum length: 1 second

File extension: WAV

The music data is saved in the memory under the following folder structure.

FS40 In the built-in memory:

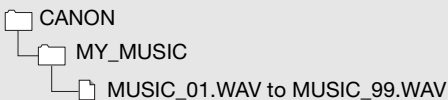

On the memory card:

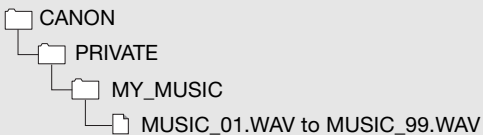

Index

- A**
- Abroad, using the camcorder . . . 119
 - Aspect ratio of a connected TV (TV type) 94
 - AUTO mode 25
 - Auto slow shutter 93
 - Automatic backlight correction . . . 53
 - AV OUT terminal 80, 81
- B**
- Background music 63
 - Battery pack
 - Battery information 97, 101
 - Charging 19
 - Remaining charge indicator . 101
 - Beach (recording program) 52
 - Built-in backup battery 117
- C**
- Calendar 46
 - Camcorder supplemental disc . . . 15
 - Condensation 118
 - Connections to external devices 80
 - Copying*
 - Movies 70
 - Photos 78
- D**
- Data code 66, 94
 - Date and time 30
 - Date format 97
 - Daylight saving time 31
 - Time zone 31
 - Deleting
 - Movies 49, 68
 - Photos 76
 - Digital effects 56
 - Dividing scenes 69
- E**
- Error messages 107
 - Eye-Fi card 88
- F**
- Fireworks (recording program) . . . 52
 - Flicker reduction 93
 - FUNC. menu 28, 90
- I**
- Image effects 60
 - Image stabilizer 54
 - Index screen 45
 - Initializing the memory 35
- J**
- Joystick 27
 - Joystick guide 27
- L**
- Language 31
 - LCD screen 23
 - Low light (recording program) . . . 52
- M**
- Maintenance 118
 - Manual exposure 57
 - Manual focus 58
 - Markers 92
 - Memory card 32, 116
 - Mini video light 61
- N**
- Night scene (recording program) . . 52
 - Notification sounds 95
- O**
- Onscreen display selection 66
 - Onscreen icons 98

* FS40 only.

P			
P (recording program)	51	Self timer	61
Photo numbers	95	Serial number	18
Playback		Setup menus	28, 92
Movies	43	Slideshow	76
Photos	74	Snow (recording program)	52
Playing	43	Special Scene (recording programs)	51
Portrait (recording program)	51	Sports (recording program)	52
Power saving	39	Spotlight (recording program)	52
Pre-recording	54	Sunset (recording program)	52
Pre-selecting recordings	48		
		T	
Q		Telephoto	40
Quick Start	41	Timeline	62
		Tripod	114
R		Troubleshooting	102
Recording			
Movies	38	U	
Photos	73	Uploading movies to video sharing Web sites	86
Recording mode	39	USB terminal	80, 81
Recording programs	51		
Recording time	40	V	
Resetting all camcorder settings	106	Video snapshot	55
		Volume	43, 94
S			
Saving recordings		W	
Transferring to a computer	83	White balance	59
Using external video recorders	85	Wide angle	40
Searching scenes by date	46	Wind screen	93
Selecting the memory*			
for playback	45	Z	
for recording	35	Zoom	40

* FS40 only.

CANON CONSUMER DIGITAL VIDEO EQUIPMENT LIMITED WARRANTY FOR THE UNITED STATES

The limited warranty set forth below is given by Canon U.S.A., Inc. ("Canon USA") with respect to Canon Consumer Digital Video Equipment (the "Equipment") purchased in the United States. This limited warranty is only effective upon presentation of your Bill of Sale or other proof of purchase.

The Equipment is warranted under normal, non-commercial, personal use, against defective materials or workmanship as follows:

Parts: Defective parts will be exchanged for new parts or comparable rebuilt parts for a period of ONE YEAR from the date of original purchase, except for a defective Video Head, which will be exchanged for a period of three months from the date of purchase.

Labor: For a period of ONE YEAR from the date of original purchase, labor will be provided free of charge by our factory service centers or designated service facilities located in the United States.

When returning Equipment under this warranty, you must pre-pay the shipping charges, and you must enclose the Bill of Sale or other proof of purchase with a complete explanation of the problem. During the ONE-YEAR warranty period, repairs will be made and the Equipment will be return-shipped to you free of charge. For repairs after the warranty period is over, you will be given an estimate of the cost of repair and an opportunity to approve or disapprove of the repair expense before it is incurred. If you approve, repairs will be made and the Equipment will be return-shipped to you. (shipping charges apply). If you disapprove, we will return-ship the equipment at no charge to you.

Non-Canon brand peripheral equipment and software which may be distributed with, or factory loaded on, the Equipment, are sold "AS IS" without warranty of any kind by Canon USA, including any implied warranty regarding merchantability or fitness for a particular purpose. The sole warranty with respect to such non-Canon brand items is given by the manufacturer or producer thereof. If the Equipment contains a hard disk drive, Canon USA recommends that data stored on that drive be duplicated or backed up to prevent its loss in the event of failure or other malfunction of such drive.

Canon USA shall have no responsibility under this limited warranty for use of the Equipment in conjunction with incompatible peripheral equipment and incompatible software.

In order to obtain warranty service, contact the authorized Canon retail dealer from whom you purchased the Equipment or call the CANON INFORMATION CENTER AT 1-800-OK-CANON. You will be directed to the nearest service facility for your Equipment.

This Limited Warranty covers all defects encountered in normal use of the Equipment and does not apply in the following cases:

- A) Loss or damage to the Equipment due to abuse, mishandling, accident, improper maintenance, or failure to follow operating instructions;
- B) If the Equipment is defective as a result of leaking batteries, sand, dirt or water damage;
- C) If defects or damages are caused by the use of unauthorized parts or by service other than by Canon USA's factory service centers or authorized service facilities;
- D) If the Equipment is used for commercial or industrial use.

This Limited Warranty does not cover cabinet (exterior finish), video cassette tape, head cleanings, nor does it apply to Equipment purchased outside the United States. This warranty does not cover units sold to rental firms, military operations, hotels, schools, hospitals or for other commercial, industrial, or institutional applications.

These uses are covered only by such specific warranty as Canon may issue with such sales.

This Limited Warranty does not apply to accessories or consumables for the Equipment, which are sold "AS IS", without warranty of any kind by Canon USA.

Please retain this warranty card and your Bill of Sale as a permanent record of your purchase. This card is most important in order to be sure you are contacted right away should there be a safety inspection, modification or product recall under applicable laws or regulations.

NO IMPLIED WARRANTY, INCLUDING MERCHANTABILITY AND FITNESS FOR A PARTICULAR PURPOSE APPLIES TO THIS EQUIPMENT AFTER THE APPLICABLE PERIOD OF EXPRESS WARRANTY OR GUARANTY, EXCEPT AS MENTIONED ABOVE, GIVEN BY ANY PERSON, FIRM OR CORPORATION WITH RESPECT TO THIS EQUIPMENT SHALL BIND THE UNDERSIGNED (SOME STATES DO NOT ALLOW LIMITATIONS ON HOW LONG AN IMPLIED WARRANTY LASTS, SO THE ABOVE LIMITATION OR EXCLUSION MAY NOT APPLY TO YOU). CANON USA SHALL NOT BE LIABLE FOR LOSS OF REVENUES OR PROFITS, EXPENSE FOR SUBSTITUTE EQUIPMENT OR SERVICE, STORAGE CHARGES,

LOSS OR CORRUPTION OF DATA, INCLUDING WITHOUT LIMITATION, LOSS OR CORRUPTION OF DATA STORED ON THE EQUIPMENT'S HARD DRIVE, OR ANY OTHER SPECIAL, INCIDENTAL OR CONSEQUENTIAL DAMAGES CAUSED BY THE USE, MISUSE OR INABILITY TO USE THE EQUIPMENT, REGARDLESS OF THE LEGAL THEORY ON WHICH THE CLAIM IS BASED, AND EVEN IF CANON USA HAS BEEN ADVISED OF THE POSSIBILITY OF SUCH DAMAGES. NOR SHALL RECOVERY OF ANY KIND AGAINST CANON USA BE GREATER THAN THE PURCHASE PRICE OF THE EQUIPMENT SOLD BY CANON USA AND CAUSING THE ALLEGED DAMAGE. WITHOUT LIMITING THE FOREGOING, YOU ASSUME ALL RISK AND LIABILITY FOR LOSS, DAMAGE OR INJURY TO YOU AND YOUR PROPERTY AND TO OTHERS AND THEIR PROPERTY ARISING OUT OF USE, MISUSE OR INABILITY TO USE THE EQUIPMENT NOT CAUSED DIRECTLY BY THE NEGLIGENCE OF CANON USA. (SOME STATES DO NOT ALLOW THE EXCLUSION OR LIMITATION OF INCIDENTAL OR CONSEQUENTIAL DAMAGES, SO THE ABOVE LIMITATION MAY NOT APPLY TO YOU).THIS WARRANTY SHALL NOT EXTEND TO ANYONE OTHER THAN THE ORIGINAL PURCHASER OF THIS EQUIPMENT OR THE PERSON FOR WHOM IT WAS PURCHASED AS A GIFT.

This warranty gives you specific legal rights, and you may also have other rights which vary from state to state. CANON U.S.A., INC.

CANON CONSUMER DIGITAL VIDEO EQUIPMENT LIMITED WARRANTY

The limited warranty set forth below is given by Canon Canada Inc. ("Canon Canada") with respect to Canon Consumer Digital Video Equipment (the "Equipment") purchased in Canada. This limited warranty is only effective upon presentation of a bill of sale or other proof of purchase for this Equipment to a Canon Service Facility when repairs are required.

The Equipment is warranted under normal, non-commercial, personal use, against defective materials or workmanship as follows:

Parts: Defective parts will be exchanged for new parts or, at Canon Canada's option, comparable rebuilt parts for a period of one year from the date of original purchase, except Video Heads which will be exchanged for a period of 3 months from the date of purchase.

Labour: For a period of one year from the date of original purchase, labour will be provided free of charge by our Canon Service Facilities in Canada.

This limited warranty covers all defects except where:

(a) The loss or damage to the product results from:

- i) accident, natural disaster, mishandling, abuse, neglect, unauthorized product modification or failure to follow instructions contained in the instruction manual;
- ii) the use of accessories, attachments, products, supplies, parts or devices with the Equipment that do not conform to Canon specifications or that cause abnormally frequent service problems;
- iii) repairs or services performed by any party other than a Canon Service Facility;
- iv) defective batteries or any exposure to water, sand or dirt;
- v) shipping (claim must be presented to the shipper);

(b) Any serial number on the video equipment is altered or removed.

(c) The Equipment is used for commercial, professional or industrial purposes.

This limited warranty does not cover the cabinet (exterior finish) of the Equipment, media, nor does it apply to Equipment purchased outside Canada.

If the Equipment contains a hard disk drive, Canon Canada recommends that data stored on that drive be duplicated or backed up to prevent its loss in the event of a failure or other malfunction of such drive.

TO OBTAIN WARRANTY SERVICE

Ship your Equipment in its original carton, box or equivalent, properly packed, fully insured with shipping charges prepaid, together with a copy of your bill of sale or other proof of purchase and a description of the problem to any of the Canon Service Facilities in Canada.

LIMITATIONS

Except as otherwise required by applicable legislation, this warranty is in lieu of all other warranties, conditions, guarantees or representations, express or implied, statutory or otherwise, relative to the Equipment, including implied warranties or conditions of merchantability or fitness for a particular purpose.

Canon Canada assumes no liability for special, consequential or incidental damages, loss or corruption of data including, without limitation, data stored on the hard disk drive of the Equipment or loss that may arise, whether on account of negligence or otherwise, from the use, misuse or inability to use the Equipment (including loss of profit, revenue, media or enjoyment) or from failure to conform to any express or implied warranties, conditions, guarantees or representations. Any recovery under this limited warranty shall not exceed the purchase price of the equipment. Canon Canada does not assume or authorize any other person to assume for Canon Canada any other liability with respect to this equipment.

This warranty does not extend to any person other than the original purchaser of the Equipment or the person for whom it was purchased as a gift and states your exclusive remedy.

NOTICE TO CONSUMER

If you plan to take important videos or if the product has not been used for some time, please check all functions with the instruction book before using it.

Canon

USA	<p>CANON U.S.A., INC. NEW JERSEY OFFICE 100 Jamesburg Road, Jamesburg, NJ 08831 USA</p> <p>CANON U.S.A., INC. CHICAGO OFFICE 100 Park Blvd., Itasca, IL 60143 USA</p> <p>CANON U.S.A., INC. LOS ANGELES OFFICE 15955 Alton Parkway, Irvine, CA 92618 USA</p> <p>CANON U.S.A., INC. HONOLULU OFFICE 210 Ward Avenue, Suite 200, Honolulu, HI 96814 USA</p> <ul style="list-style-type: none">❖ If you have any questions, call the Canon U.S.A. Information Center toll-free at 1-800-828-4040 (USA only).
CANADA	<p>CANON CANADA INC. 6390 Dixie Road, Mississauga, ON L5T 1P7</p> <ul style="list-style-type: none">❖ If you have any questions, call the Canon Canada Information Center toll free (in Canada only) at 1-800-OK-CANON (1-800-652-2666).❖ Si vous avez des questions, veuillez téléphoner 1-800-OK-CANON (1-800-652-2666, sans frais au Canada seulement).
MÉXICO	<p>CANON MEXICANA, S DE RL DE CV Blvd. Manuel Ávila Camacho No. 138, Piso 17 Col. Lomas de Chapultepec, C.P. 11000 México, D.F., México</p> <p>CANON U.S.A., INC. NEW JERSEY OFFICE 100 Jamesburg Road, Jamesburg, NJ 08831 USA</p>
CENTRO Y SURAMÉRICA	<p>CANON LATIN AMERICA, INC. 703 Waterford Way, Suite 400, Miami, FL 33126 USA</p>
ASIA	<p>CANON HONGKONG COMPANY LTD. 19/F, The Metropolis Tower, 10 Metropolis Drive, Hungghom, Kowloon, Hong Kong Tel: +852 3191 2333, Fax: +852 2428 3963</p>

For support concerning the supplied PIXELA's software, please call PIXELA customer support (see the back cover of the Installation Guide for PIXELA's software).