

Canon

PUB. DIE-0387-000

HD Camcorder

Instruction Manual



VIXIA
HF M40

VIXIA
HF M41

VIXIA
HF M400



NTSC

HDMI **AVCHD**

Important Usage Instructions

WARNING!

TO REDUCE THE RISK OF FIRE OR ELECTRIC SHOCK, DO NOT EXPOSE THIS PRODUCT TO RAIN OR MOISTURE.

WARNING!

TO REDUCE THE RISK OF ELECTRIC SHOCK AND TO REDUCE ANNOYING INTERFERENCE, USE THE RECOMMENDED ACCESSORIES ONLY.

COPYRIGHT WARNING:

Unauthorized recording of copyrighted materials may infringe on the rights of copyright owners and be contrary to copyright laws.

HD Camcorder, VIXIA HF M40 A / VIXIA HF M41 A / VIXIA HF M400 A systems

This device complies with Part 15 of the FCC Rules. Operation is subject to the following two conditions: (1) This device may not cause harmful interference, and (2) this device must accept any interference received, including interference that may cause undesired operation.

Note: This equipment has been tested and found to comply with the limits for class B digital device, pursuant to Part 15 of the FCC Rules. These limits are designed to provide reasonable protection against harmful interference in a residential installation. This equipment generates, uses and can radiate radio frequency energy and, if not installed and use in accordance with the instructions, may cause harmful interference to radio communications. However, there is no guarantee that interference will not occur in a particular installation. If this equipment does cause harmful interference to radio or television reception, which can be determined by turning the equipment off and on, the user is encouraged to try to correct the interference by one or more of the following measures:

- Reorient or relocate the receiving antenna.
- Increase the separation between the equipment and receiver.
- Connect the equipment into an outlet on a circuit different from that to which the receiver is connected.
- Consult the dealer or an experienced radio/TV technician for help.

Use of shielded cable is required to comply with class B limits in Subpart B of Part 15 of FCC Rules. Do not make any changes or modifications to the equipment unless otherwise specified in the manual. If such changes or modifications should be made, you could be required to stop operation of the equipment.

Canon U.S.A., Inc.
One Canon Plaza, Lake Success, NY 11042, U.S.A.
Tel No. (516)328-5600

CAUTION:

TO PREVENT ELECTRIC SHOCK, MATCH WIDE BLADE OF PLUG TO WIDE SLOT, FULLY INSERT.

WARNING:

To reduce the risk of electric shock, do not expose this product to dripping or splashing.

The Mains plug is used as the disconnect device. The Mains plug shall remain readily operable to disconnect the plug in case of an accident.

CAUTION:

- Danger of explosion if the wrong type of batteries are attached. Use only the same type of batteries.
- Do not expose batteries or product to excessive heat such as the inside of a car under direct sunlight, fire, etc.

Important Warning



CAUTION:

TO REDUCE THE RISK OF ELECTRIC SHOCK, DO NOT REMOVE COVER (OR BACK). NO USER-SERVICEABLE PARTS INSIDE. REFER SERVICING TO QUALIFIED SERVICE PERSONNEL.



The lightning flash with arrowhead symbol, within an equilateral triangle, is intended to alert the user to the presence of uninsulated "dangerous voltage" within the product's enclosure, that may be of sufficient magnitude to constitute a risk of electric shock to persons.



The exclamation point, within an equilateral triangle, is intended to alert the user to the presence of important operating and maintenance (servicing) instructions in the literature accompanying the product.

IMPORTANT SAFETY INSTRUCTIONS

In these safety instructions the word “product” refers to the Canon HD Camcorder VIXIA HF M40 A / VIXIA HF M41 A / VIXIA HF M400 A and all its accessories.

- 1 Read these instructions.
- 2 Keep these instructions.
- 3 Heed all warnings.
- 4 Follow all instructions.
- 5 Do not use this apparatus near water.
- 6 Clean only with dry cloth.
- 7 Do not install near any heat sources such as radiators, heat registers, stoves, or other apparatus (including amplifiers) that produce heat.
- 8 Do not defeat the safety purpose of the polarized or grounding-type plug. A polarized plug has two blades with one wider than the other. A grounding type plug has two blades and a third grounding prong. The wide blade or the third prong are provided for your safety. If the provided plug does not fit into your outlet, consult an electrician for replacement of the obsolete outlet.
- 9 Protect the power cord from being walked on or pinched particularly at plugs, convenience receptacles, and the point where they exit from the apparatus.
- 10 Only use attachments/accessories specified by the manufacturer.
- 11 Unplug this apparatus during lightning storms or when unused for long periods of time.
- 12 Refer all servicing to qualified service personnel. Servicing is required when the apparatus has been damaged in any way, such as power-supply cord or plug is damaged, liquid has been spilled or objects have fallen into the apparatus, the apparatus has been exposed to rain or moisture, does not operate normally, or has been dropped.
- 13 Read Instructions — All the safety and operating instructions should be read before the product is operated.
- 14 Retain Instructions — The safety and operating instructions should be retained for future reference.
- 15 Heed Warnings — All warnings on the product and in the operating instructions should be adhered to.
- 16 Follow Instructions — All operating and maintenance instructions should be followed.
- 17 Cleaning — Unplug this product from the wall outlet before cleaning. Do not use liquid or aerosol cleaners. The product should be cleaned only as recommended in this manual.
- 18 Accessories — Do not use accessories not recommended in this manual as they may be hazardous.
- 19 Avoid magnetic or electric fields — Do not use the camera close to TV transmitters, portable communication devices or other sources of electric or magnetic radiation. They may cause picture interference, or permanently damage the camera.
- 20 Water and Moisture — Hazard of electric shock — Do not use this product near water or in rainy/moist situations.

- 21 **Placing or Moving** — Do not place on an unstable cart, stand, tripod, bracket or table. The product may fall, causing serious injury to a child or adult, and serious damage to the product. A product and cart combination should be moved with care. Quick stops, excessive force, and uneven surfaces may cause the product and cart combination to overturn.



- 22 **Power Sources** — The CA-570 Compact Power Adapter should be operated only from the type of power source indicated on the marking label. If you are not sure of the type of power supply to your home, consult your product dealer or local power company. Regarding other power sources such as battery power, refer to instructions in this manual.
- 23 **Polarization** — The CA-570 Compact Power Adapter is equipped with a polarized 2-prong plug (a plug having one blade wider than the other). The 2-prong polarized plug will fit into the power outlet only one way. This is a safety feature. If you are unable to insert the plug fully into the outlet, try reversing the plug. If the plug still fails to fit, contact your electrician to replace your obsolete outlet. Do not defeat the safety purpose of the polarized plug.
- 24 **Power Cord Protection** — Power cords should be routed so that they are not likely to be walked on or pinched by items placed upon or against them. Pay particular attention to plugs and the point from which the cords exit the product.

- 25 **Outdoor Antenna Grounding** — If an outside antenna is connected to the product, be sure the antenna is grounded so as to provide some protection against voltage surges and built-up static charges. Section 810 of the National Electrical Code, ANSI / NFPA No. 70—1984, provides information with respect to proper grounding of the mast and supporting structure, grounding of the lead-in wire to an antenna discharge unit, size of grounding conductors, location of antenna discharge unit, connection to grounding electrodes, and requirements for the grounding electrode. See figure 1.

Fig. 1 EXAMPLE OF ANTENNA GROUNDING AS PER NATIONAL ELECTRICAL CODE

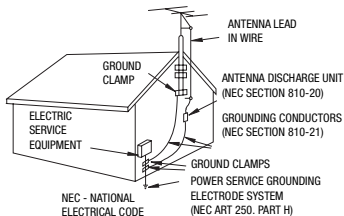

- 26 **Lightning** — For added protection of this product during a lightning storm, or when it is left unattended and unused for long periods of time, disconnect it from the wall outlet and disconnect the antenna. This will prevent damage to the product due to lightning and power-line surges.
- 27 **Overloading** — Do not overload wall outlets and extension cords as this can result in a risk of fire or electric shock.
- 28 **Objects and Liquid Entry** — Never push objects of any kind into this product through openings as they may touch dangerous voltage points or short out parts that could result in a fire or electric shock. Be careful not to spill liquid of any kind onto the product.
- 29 **Servicing** — Do not attempt to service this product yourself as opening or removing covers may expose you to dangerous voltage or other hazards. Refer all servicing to qualified service personnel.

- 30 **Damage Requiring Service** — Disconnect this product from the wall outlet and all power sources including battery, and refer servicing to qualified service personnel under the following conditions:
- When the power-supply cord or plug is damaged.
 - If any liquid has been spilled onto, or objects have fallen into, the product.
 - If the product has been exposed to rain or water.
 - If the product does not operate normally even if you follow the operating instructions. Adjust only those controls that are covered by the operation instructions. Improper adjustment of other controls may result in damage and will often require extensive work by a qualified technician to restore the product to its normal operation.
 - If the product has been dropped or the cabinet has been damaged.
 - When the product exhibits a distinct change in performance. This indicates a need for service.
- 31 **Replacement Parts** — When replacement parts are required, be sure the service technician has used replacement parts that are specified by Canon or that have the same characteristics as the original part. Unauthorized substitutions may result in fire, electric shock or other hazards.
- 32 **Safety Check** — Upon completion of any service or repairs to this product, ask the service technician to perform safety checks to determine that the product is in safe operating order.
- 33 **Heat** — The product should be situated away from heat sources such as radiators, heat registers, stoves, or other products (including amplifiers) that produce heat.

When replacement of the power supply is required, please return it to the responsible nearest Canon Service Center and please replace it with the same type number CA-570.

CA-570 identification plate is located on the bottom.

The Adapter can be used with a power supply between 100 and 240 V AC. For areas where 120 V AC power is not used, you will need a special plug adapter. Contact your nearest Canon Service Center for further information.

This Class B digital apparatus complies with Canadian ICES-003.

Trademark Acknowledgements

- SD, SDHC and SDXC Logos are trademarks of SD-3C, LLC.
- Microsoft and Windows are trademarks or registered trademarks of Microsoft Corporation in the United States and/or other countries.
- Macintosh and Mac OS are trademarks of Apple Inc., registered in the U.S. and other countries.
- “x.v.Color” and the “x.v.Color” logo are trademarks.
- HDMI, the HDMI logo and High-Definition Multimedia Interface are trademarks or registered trademarks of HDMI Licensing LLC in the United States and other countries.
- “AVCHD” and the “AVCHD” logo are trademarks of Panasonic Corporation and Sony Corporation.
- Manufactured under license from Dolby Laboratories.
“Dolby” and the double-D symbol are trademarks of Dolby Laboratories.
- YouTube is a trademark of Google Inc.
- Other names and products not mentioned above may be trademarks or registered trademarks of their respective companies.
- This device incorporates exFAT technology licensed from Microsoft.
- ANY USE OF THIS PRODUCT OTHER THAN CONSUMER PERSONAL USE IN ANY MANNER THAT COMPLIES WITH THE MPEG-2 STANDARD FOR ENCODING VIDEO INFORMATION FOR PACKAGED MEDIA IS EXPRESSLY PROHIBITED WITHOUT A LICENSE UNDER APPLICABLE PATENTS IN THE MPEG-2 PATENT PORTFOLIO, WHICH LICENSE IS AVAILABLE FROM MPEG LA, L.L.C., 250 STEELE STREET, SUITE 300, DENVER, COLORADO 80206.
- This product is licensed under AT&T patents for the MPEG-4 standard and may be used for encoding MPEG-4 compliant video and/or decoding MPEG-4 compliant video that was encoded only (1) for a personal and non-commercial purpose or (2) by a video provider licensed under the AT&T patents to provide MPEG-4 compliant video. No license is granted or implied for any other use for MPEG-4 standard.



Exciting Features and New Functions



Your camcorder's Full HD CMOS sensor captures video at a resolution of 1,920 x 1,080 pixels². Videos are then recorded in the memory, using AVCHD specifications³.

With your new HD camcorder, capturing the special moments in your life with amazing image quality and in lifelike vibrant colors is easy and fun!

Story Creator (📖 65)

Transform your movies into compelling video stories just by recording video following simple pre-scripted suggestions, optimized for various scenarios.



Decoration (📖 69)

Add flare to your movies by adding text, stamps or freehand drawings directly in the camcorder.

Cinema-Look Filters (📖 67)

Use professional cinema-look filters to create unique movies with distinctive looks.

¹ "Full HD 1080" refers to Canon camcorders compliant with high-definition video composed of 1,080 vertical pixels (scanning lines).

² Video is recorded at this resolution only when the recording mode is set to MXP or FXP mode. In other recording modes, the picture is recorded at 1,440 x 1,080 pixels.

³ AVCHD is a standard for recording high-definition video. With AVCHD specifications, the video signal is recorded using MPEG-4 AVC/H.264 compression and the audio signal is recorded in Dolby Digital.



Smart AUTO (📖 48)

Smart AUTO automatically selects the best scene mode for the scene you want to shoot. You get spectacular recordings every time without worrying about settings.

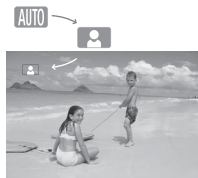

Video Snapshot

(📖 68)

Shoot or capture short scenes and arrange them into a video clip set to your favorite background music.

Relay Recording

(📖 43)



The memory almost full? Use the double memory card slot to keep on recording video without interruption.



Face Detection

(📖 93)

The camcorder automatically detects people's faces and adjusts the focus and other settings accordingly for beautiful results.

Image Stabilization



Dynamic IS (📖 90) compensates for camcorder shake when you shoot video while walking. Powered IS (📖 91) will produce stable shots when you zoom in on distant subjects (full telephoto).

Enjoying your Recordings on Other Devices

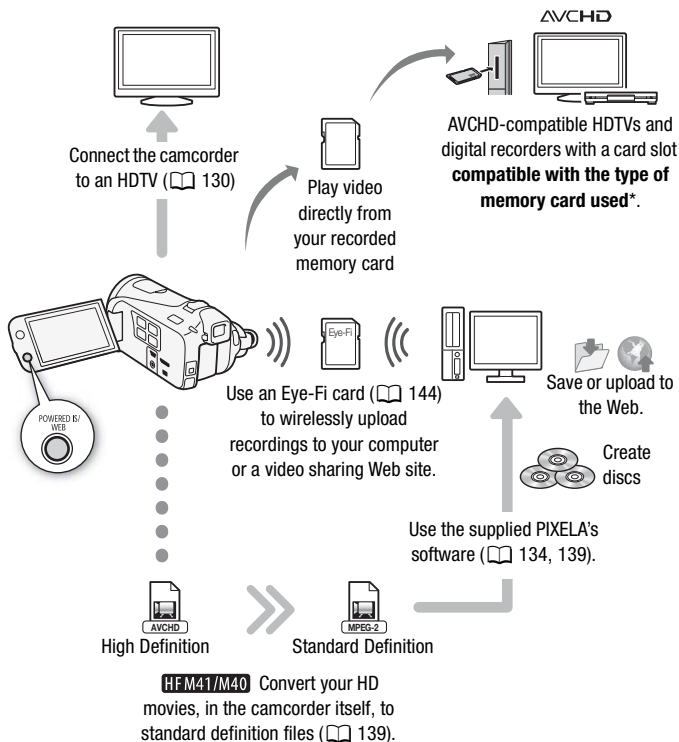

* Refer to the instruction manual of the device. Depending on the device used, correct playback may not be possible even if the device is AVCHD-compatible. In such case, play back the recordings on the memory card using the camcorder.

Table of contents

■ Introduction

- 8 Exciting Features and New Functions
- 16 About this Manual
- 18 Getting to Know the Camcorder**
- 18 Supplied Accessories and CD-ROMs
- 20 Names of Parts

■ Preparations

24 Getting Started

- 24 Charging the Battery Pack
- 26 Preparing the Accessories
- 29 Adjusting the Position and Brightness of the LCD Screen
- 31 **HFM41** Using the Viewfinder

32 Basic Operation of the Camcorder

- 32 Using the Touch Screen
- 33 Operating Modes
- 34 Using the Menus

36 First Time Settings

- 36 Setting the Date and Time
- 37 Changing the Language
- 37 Changing the Time Zone

39 Using a Memory Card

- 39 Memory Cards Compatible for Use with the Camcorder
- 41 Inserting and Removing a Memory Card
- 42 Selecting the Memory for the Recordings
- 43 Relay Recording
- 44 Initializing the Memory

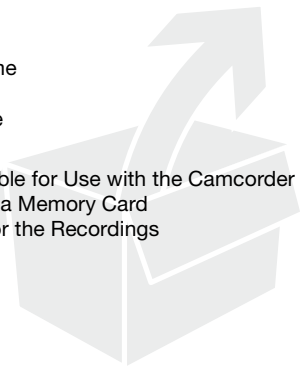

■ **AUTO Mode**

46 Basic Recording

- 46 Shooting Video and Taking Photos in AUTO Mode
- 48 About the Smart AUTO function
- 51 Zooming
- 53 Quick Start Function

■ **Video**

55 Basic Playback

- 55 Playing Back Video
- 59 3D Flip View
- 59 The Index Selection Screen: Selecting the Content to Play Back
- 61 Deleting Scenes and Stories

65 Video Stories and Cinema Style

- 65 Using Story Creator to Create Compelling Stories
- 67 CINEMA Mode and Cinema-Look Filters
- 68 Video Snapshot
- 69 Decoration: Adding a Personal Touch
- 74 Playing Back Stories from the Gallery
- 76 Rating Scenes
- 77 Playback with Background Music
- 81 Copying and Moving Scenes Within/Between Stories
- 82 Selecting a Story's Thumbnail Image
- 82 Changing a Story's Title

84 Advanced Functions

- 84 Recording in **M** (Manual) Mode
- 85 Selecting the Video Quality (Recording Mode)
- 87 Selecting the Frame Rate
- 87 Special Scene Recording Programs
- 90 Advanced Image Stabilization
- 92 Pre-Recording
- 93 Face Detection
- 94 Touch & Track
- 95 Faders
- 96 Manually Setting the Shutter Speed or Aperture
- 98 Manual Exposure Adjustment

99	Automatic Gain Control (AGC) Limit
99	Manual Focus Adjustment
101	Tele Macro
102	White Balance
103	Image Effects
104	Self Timer
105	Audio Recording Level
106	Built-In Microphone Directionality
107	Audio Equalizer
108	Audio Mix
109	Using Headphones
110	Using the Mini Advanced Shoe
111	Using an External Microphone
113	Using an External Video Light
114	Using a Zoom Remote Controller
115	Selecting the Playback Starting Point
116	Onscreen Displays and Data Code
117	Capturing Photos and Video Snapshot Scenes from a Movie
119	Dividing Scenes

■ Photos

121	Viewing Photos
123	Deleting Photos
124	Slideshow

■ External Connections

126 Terminals on the Camcorder

127	Connection Diagrams
-----	---------------------

130 Playback on a TV Screen

131 Saving and Sharing Your Recordings

131	Copying Recordings to a Memory Card
134	Saving Recordings on a Computer
138	Copying Recordings to an External Video Recorder
139	HFM41/M40 Uploading Movies to Video Sharing Web Sites

■ Additional Information

146 Appendix: Menu Options Lists

146 FUNC. Panel

149 Setup Menus

161 Appendix: Onscreen Icons and Displays

165 Trouble?

165 Troubleshooting

172 List of Messages

179 Do's and Don'ts

179 Handling Precautions

184 Maintenance/Others

185 Using the Camcorder Abroad

186 General Information

186 Accessories

187 Optional Accessories

193 Product Codes









194 Specifications

198 Index

About this Manual

Thank you for purchasing the Canon VIXIA HF M41 / VIXIA HF M40 / VIXIA HF M400. Please read this manual carefully before you use the camcorder and retain it for future reference. Should your camcorder fail to operate correctly, refer to *Troubleshooting* (📖 165).

Conventions Used in this Manual

-  **IMPORTANT:** Precautions related to the camcorder's operation.
-  **NOTES:** Additional topics that complement the basic operating procedures.
-  **POINTS TO CHECK:** Restrictions or requirements regarding the function described.
- : Reference page number within this manual.
-  **PHOTO** > References to sections of the 'Photo Application' Instruction Manual, included as a PDF file in the supplied Camcorder Supplemental Disc.
- : Text that applies only to the models shown in the icon.
- The following terms are used in this manual:
 - When not specified as “memory card” or “built-in memory”, the term “memory” by itself refers to both.
 - “Scene” refers to one movie unit from the point you press the  button to start recording until you press again to pause the recording.
- The photos included in this manual are simulated pictures taken with a still camera. Unless indicated otherwise, illustrations and menu icons refer to the .

AUTO indicates that a function is available in the operating mode indicated and **AUTO** indicates that the function is not available. For a detailed explanation refer to *Operating Modes* (□ 33).

Brackets [] are used to refer to control buttons and menu options you will touch on the screen and to other onscreen messages and displays.

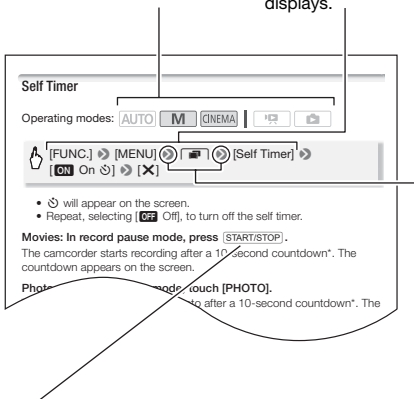

The names of physical buttons and switches on the camcorder are indicated within a “button” frame. For example **DISP.**.

The **▶** arrow is used to abbreviate menu selections. For a detailed explanation on how to use the menus, refer to *Using the Menus* (□ 34). For a concise summary of all available menu options and settings, refer to the appendix *Menu Options Lists* (□ 146).

Supplied Accessories and CD-ROMs

The following accessories are supplied with the camcorder:

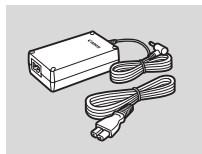

▶ CA-570 Compact Power Adapter
(incl. power cord)

BP-808 Battery Pack ◀



▶ WL-D89 Wireless Controller
(incl. CR2025 lithium button battery)

Stylus Pen ◀

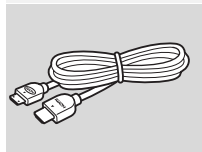

▶ HTC-100/S HDMI Cable

STV-250N Stereo Video Cable ◀

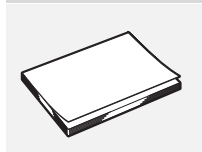
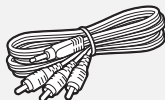

▶ Quick Guide

IFC-300PCU/S USB Cable ◀

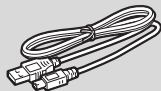

▶ Installation Guide for PIXELA's
Software

The following CD-ROMs and software are supplied with the camcorder:

- **PIXELA's Transfer Utility** CD-ROM*
 - Use **Transfer Utility** for saving and transferring movies and music files you can use as background music.
 - **PIXELA's VideoBrowser** CD-ROM*
 - In addition to all the functionality of **Transfer Utility**, you can use **VideoBrowser** for managing, editing, and playing back movies.
 -  **Instruction Manual/Photo Applications Ver.35*/Music Data/Image Mix Data** CD-ROM (referred in the manual as "Camcorder Supplemental Disc"). Contains the following components.
 - Instruction Manual - The full-version instruction manual of the camcorder (this PDF file).
 - Photo Application - Software for saving, managing, and printing photos.
 - Music data - Music files that can be used as background music during playback. These music files are for exclusive use with the supplied PIXELA's software. The disc cannot be played back on CD players.
 - Image mix data - Image files that can be used with the image mix function (image mix frames).
- * The CD-ROM includes the instruction manual of the software (on PDF file).

Names of Parts

Left side view

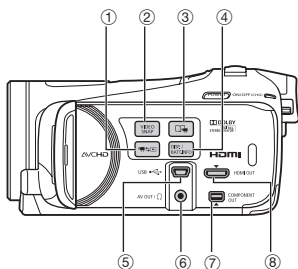

- ① (camera/play) button (33)
- ② VIDEO SNAP (video snapshot) button (68)
- ③ (Story Creator button) (65)
- ④ DISP. (onscreen display) button (30, 116)/
BATT. INFO button (164)
- ⑤ USB terminal (126, 129, 138)
- ⑥ AV OUT terminal (126, 128)/
⌚ (headphones) terminal (109)
- ⑦ COMPONENT OUT terminal (126, 128)

Right side view

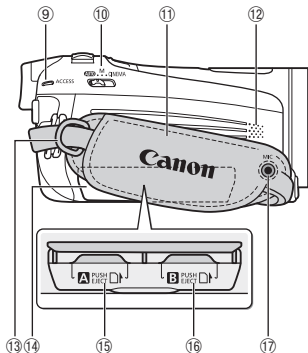

- ⑧ HDMI OUT terminal (126, 127)
- ⑨ ACCESS indicator (46)
- ⑩ Mode switch (33)
- ⑪ Grip belt (27)
- ⑫ Speaker (57)
- ⑬ Strap mount (27)
- ⑭ Double memory card slot cover
- ⑮ Memory card slot **A** (41)
- ⑯ Memory card slot **B** (41)
- ⑰ MIC terminal (112, 112)
- ⑱ Stereo microphone (105, 106)

Front view

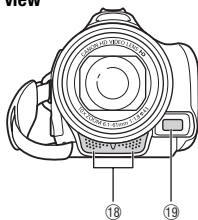

- ⑱ Instant AF sensor (151)

Top view

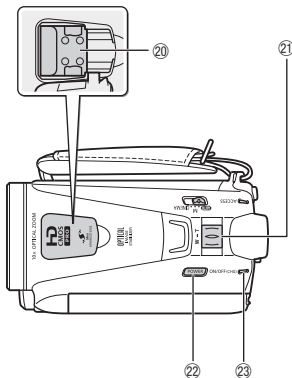

- ②0 Mini advanced shoe (📖 110)
- ②1 Zoom lever (📖 51)
- ②2 POWER button
- ②3 ON/OFF (CHG) (charge) indicator:
Green – ON
Orange – Standby (📖 53)
Red – Charging (📖 24)
- ②4 Remote sensor (📖 26)
- ②5 LCD touch screen (📖 29, 32)
- ②6 POWERED IS button (📖 91)/
HFM41/M40 WEB button (📖 139)

LCD panel

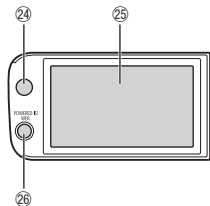

Back view

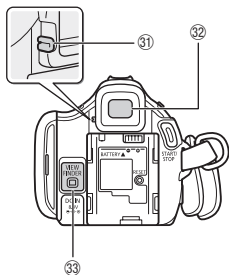
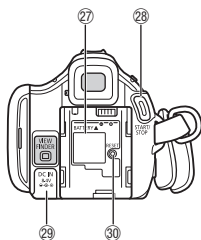

- ②7 Battery attachment unit (24)
- ②8 START/STOP button (46)
- ②9 DC IN terminal (24)
- ③0 RESET button (169)
- ③1 Dioptic adjustment lever* (31)
- ③2 Viewfinder* (31)
- ③3 VIEWFINDER button* (31)
- ③4 BATTERY RELEASE switch (25)
- ③5 Tripod socket (180)
- ③6 **Serial number**

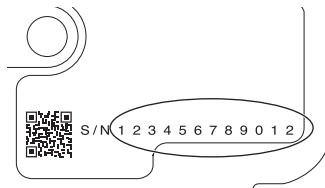





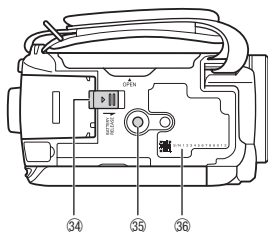

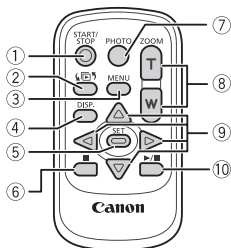

* **HFM41** only.

Bottom view





- ① START/STOP button (📖 46)
- ②  (index selection) button (📖 59)
Press and hold for more than 2 seconds to switch between shooting and playback mode.
- ③ MENU button (📖 35, 149)
- ④ DISP. (onscreen display) button (📖 116)
- ⑤ SET button
- ⑥  (stop) button (📖 55)
- ⑦ PHOTO button (📖 46)
- ⑧ Zoom buttons (📖 51)
- ⑨ Navigation buttons ( /  /  / )
- ⑩  /  (play/pause) button (📖 55)



Preparations

This chapter describes basic operations, such as using the touch panel, navigating the menus, and first time settings to help you learn more about your camcorder.

Getting Started

Charging the Battery Pack

The camcorder can be powered with a battery pack or directly using the compact power adapter. The first time you use a battery pack, fully charge it and then use the camcorder until the battery pack is completely exhausted. Doing so will ensure that the remaining recording time will be displayed accurately.

For approximate charging times and recording/playback times with a fully charged battery pack, refer to *Charging, Recording and Playback Times* (📖 188).

- 1 Connect the power cord to the compact power adapter.
- 2 Plug the power cord into a power outlet.
- 3 Connect the compact power adapter to the camcorder's DC IN terminal.
- 4 Attach the battery pack to the camcorder.

Press the battery pack softly into the battery attachment unit and slide it up until it clicks in place.

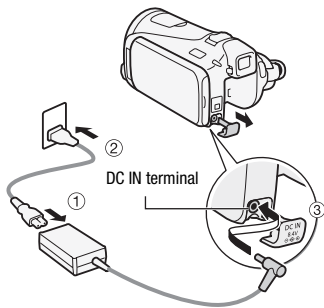

5 Charging will start when the camcorder is turned off.

- If the camcorder was on, the green ON/OFF (CHG) indicator will go out when you turn off the camcorder. After a moment, the ON/OFF (CHG) indicator will start flashing in red (battery pack charging). The red ON/OFF (CHG) indicator will go out when the battery pack is fully charged.
- If the indicator flashes quickly, refer to *Troubleshooting* (168).

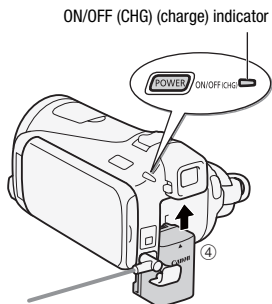

To remove the battery pack

- 1 Slide **BATTERY RELEASE** in the direction of the arrow and hold it pressed down.
- 2 Slide the battery pack and then pull it out.

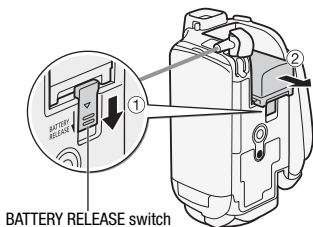

! IMPORTANT

- Turn off the camcorder before connecting or disconnecting the compact power adapter. After pressing **POWER** to turn off the camcorder, important data is updated in the memory. Be sure to wait until the green ON/OFF (CHG) indicator goes out.
- Do not connect to the camcorder's DC IN terminal or to the compact power adapter any electrical equipment that is not expressly recommended for use with this camcorder.
- To prevent equipment breakdowns and excessive heating, do not connect the supplied compact power adapter to voltage converters for overseas travels or special power sources such as those on aircraft and ships, DC-AC inverters, etc.

i NOTES

- We recommend charging the battery pack in temperatures between 10 °C and 30 °C (50 °F and 86 °F). If either the ambient temperature or the battery pack's temperature is outside the range of approx. 0 °C to 40 °C (32 °F to 104 °F), charging will not start.
- The battery pack will be charged only when the camcorder is off.
- If the power supply was disconnected while charging a battery pack, make sure the ON/OFF (CHG) indicator has gone out before restoring the power supply.
- If remaining battery time is an issue, you can power the camcorder using the compact power adapter so the battery pack will not be consumed.
- Charged battery packs continue to discharge naturally. Therefore, charge them on the day of use, or the day before, to ensure a full charge.
- We recommend that you prepare battery packs to last 2 to 3 times longer than you think you might need.
- **USA and Canada only:** The Lithium ion/polymer battery that powers the product is recyclable. Please call 1-800-8-BATTERY for information on how to recycle this battery.



Preparing the Accessories

Wireless Controller

First, insert the supplied CR2025 lithium button battery into the wireless controller.

- 1 Press the tab in the direction of the arrow and pull out the battery holder.
- 2 Place the lithium button battery with the + side facing up.
- 3 Insert the battery holder.

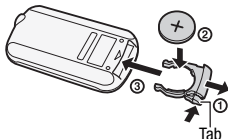

To use the wireless controller

Point the wireless controller at the camcorder's remote sensor when you press the buttons.

You can rotate the LCD panel 180 degrees to use the wireless controller from the front of the camcorder.

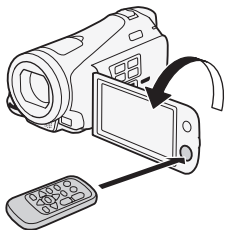
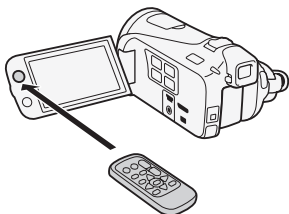

i NOTES

- The wireless controller may not work properly when the remote sensor is situated under strong light sources or direct sunlight.

Grip Belt and Straps

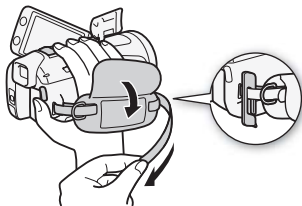

Fasten the grip belt.

Adjust the grip belt so that you can reach the zoom lever with your index finger, and the **START/STOP** button with your thumb.

You can attach the supplied stylus pen to the grip belt.

To remove the grip belt

- 1 Lift the padded handgrip's flap and detach the strap from the Velcro pad.
- 2 Pull the strap to remove it first from the front bracket on the camcorder, then to unthread it from the handgrip and finally to remove it from the rear bracket on the camcorder.

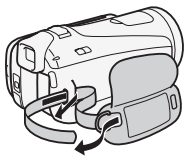
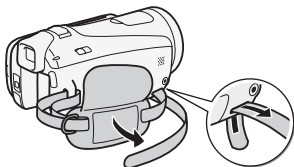

To attach an optional wrist strap

Attach the wrist strap to the rear bracket on the camcorder, adjust the length and fasten.

You can also attach the wrist strap to the strap mount on the grip belt to use both for extra convenience and protection.

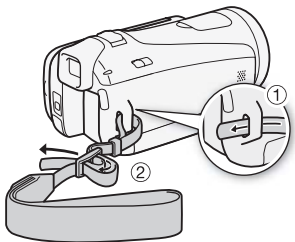

To attach an optional shoulder strap

Pass the ends of the shoulder strap through the strap mount on the grip belt and adjust the length of the strap.

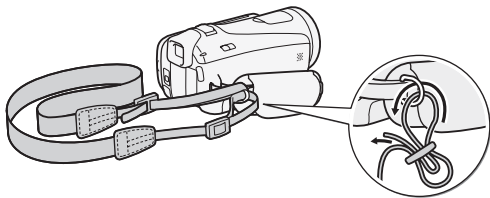

Adjusting the Position and Brightness of the LCD Screen

Rotating the LCD Panel

Open the LCD panel 90 degrees.

- You can rotate the panel 90 degrees downward.
- You can rotate the panel 180 degrees toward the lens. Rotating the LCD panel 180 degrees can be useful in the following cases:
 - **HFM41** To allow the subject to monitor the LCD screen while you use the viewfinder.
 - To include yourself in the picture when recording with the self timer.
 - To allow the camcorder to be operated with the wireless controller from the front.

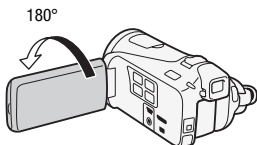
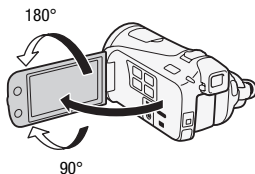

Subject can monitor the LCD screen
(**HFM41**) You can use the viewfinder
at the same time)

i NOTES

- **About the LCD and viewfinder* screens:** The screens are produced using extremely high-precision manufacturing techniques, with more than 99.99% of the pixels operating to specification. Less than 0.01% of the pixels may occasionally misfire or appear as black, red, blue or green dots. This has no effect on the recorded image and does not constitute a malfunction.

* **HFM41** only.

LCD Backlight

When recording in bright places it may be difficult to use the LCD screen. Turn on the LCD backlight to make it brighter.

With the camcorder on, hold **[DISP.] pressed down for more than 2 seconds.**

Repeat this action to switch the LCD backlight between off (normal) and on (bright).

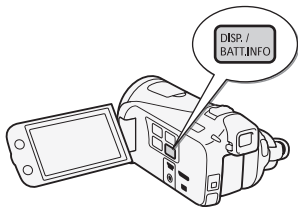

i NOTES

- The LCD backlight does not affect the brightness of the recordings.
- Using the bright setting will shorten the effective usage time of the battery pack.
- You can further adjust the brightness of the LCD screen with the **[]** **[]** **[]** [LCD Brightness] setting, or dim it with the **[]** **[]** **[]** [LCD Screen Dimmer] setting to use in places where the light from the LCD screen can be a nuisance.
- For details about how to take care of the touch screen, refer to *Handling Precautions* (📖 179), *Cleaning* (📖 184).

HF M41 Using the Viewfinder

If it is difficult to use the LCD screen even after turning on the LCD backlight, you can use the viewfinder. You can also use the viewfinder when you rotate the LCD panel 180 degrees to let the subject watch the recording.

Press **VIEWFINDER** to activate the viewfinder.

- You can close the LCD panel or rotate it toward the subject as you prefer.
- Adjust the viewfinder as necessary with the dioptic adjustment lever.
- The LCD backlight setting is common to the LCD screen and the viewfinder.

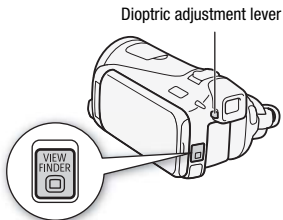

i NOTES

- For details about how to take care of the viewfinder, refer to *Handling Precautions* (📖 179), *Cleaning* (📖 184).

Basic Operation of the Camcorder

Using the Touch Screen

The control buttons and menu items that appear on the touch screen change dynamically depending on the operating mode and the task you are performing. With the intuitive touch screen interface you have all the controls at your fingertips. You can also use the supplied stylus pen for a more precise operation.

Touch

Press firmly on an element displayed on the touch screen.

Used to start playing back a scene in an index screen, to select a setting from the menus, to select the subject whom the camcorder will recognize as the main subject of the scene, etc.

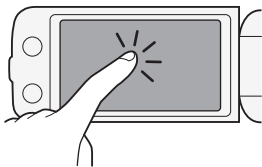

Drag

While applying pressure, swipe your finger up and down or left and right across the screen.

Used to scroll menus, to browse through index screen pages or to adjust slider controls like the volume.

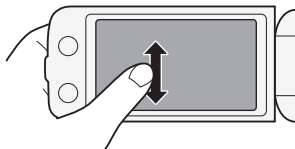







! IMPORTANT

- **The camcorder uses a pressure-sensitive touch screen. Press firmly when using touch operations.**
- In the following cases, you may not be able to perform touch operations correctly.
 - Using your fingernails or hard-tipped objects other than the supplied stylus pen, such as ballpoint pens.
 - Operating the touch screen with wet or gloved hands.
 - Applying excessive force or forcefully scratching the touch screen.
 - Attaching commercially available screen protectors or adhesive film onto the touch screen's surface.



Operating Modes

Recording



In recording mode, the camcorder's operating mode is determined by the position of the mode switch.

Operating mode	Mode switch	Operation
		Let the camcorder take care of all the settings while you concentrate on recording (📖 46). Great for beginners or if you just prefer not to bother with detailed camcorder settings.
		Enjoy full access to menus, settings and advanced functions (📖 84).
		Give your recordings a cinematic look and use cinematic look filters to create unique movies (📖 67).

Playback

Press the camera/play button  to switch the camcorder between camera (recording) mode and playback mode. You can press  when the camcorder is off to turn it on directly in playback mode.



Operating mode	Operation
	Playing back movies (📖 55).
	Viewing photos (📖 121).

NOTES

- When switching to a playback mode, the memory selected for playback will be the same currently used for recording.
- You can also press and hold  on the wireless controller for more than 2 seconds to switch between recording and playback mode.

Using the Menus

Many of the camcorder's functions can be adjusted from the FUNC. panel and the setup menus. For details about the available menu options and settings, refer to the appendix *Menu Options Lists* (📖 146).

FUNC. Panel

Operating modes: **AUTO** **M** CINEMA | 📺 📹

The FUNC. panel shows a convenient overview of frequently used shooting functions. Touch [FUNC.] to access the FUNC. panel and then touch the function you want to set or adjust.

You may need to drag your finger up and down along the scroll bar to find the control button of the desired function. In **AUTO** mode, access to functions is limited.

FUNC. panel in **M** mode

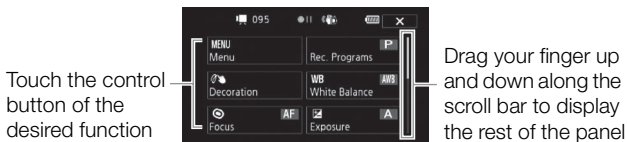

Edit Panel

Operating modes: **AUTO** **M** CINEMA | 📺 📹

Touch [Edit] to display a panel showing available operations (copying, deleting, etc.), and then touch the operation you want to perform.

Edit panel in 📺 mode

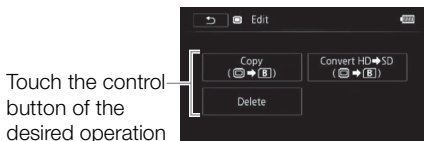

Setup Menus

Operating modes: **AUTO*** **M** **CINEMA** |  

* In **AUTO** mode setup menus cannot be accessed and most menu settings will be reset to default values.

1 **M** or **CINEMA** mode only: Touch **[FUNC.]**

2 Touch **[MENU]** to open the setup menus.

You can also press **[MENU]** on the wireless controller.

3 Touch the tab of the desired menu.

4 Drag your finger up and down to bring the setting you want to change into the orange selection bar.

- Menu items not available appear grayed out.
- You can touch any menu item on the screen to bring it directly into the selection bar.

5 When the desired menu item is inside the selection bar, touch the orange frame on the right.

6 Touch the desired option and touch **[X]**.

You can touch **[X]** to close the menu at any time.

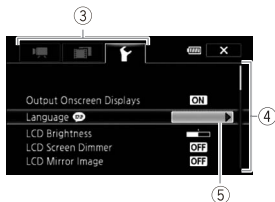

First Time Settings

Setting the Date and Time

You will need to set the date and time of the camcorder before you can start using it. The [Date/Time] screen will appear automatically when the camcorder's clock is not set.

When the [Date/Time] screen appears, the year will be selected.

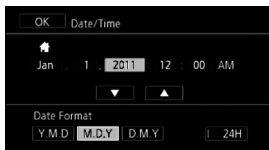



- 1 Touch a field you want to change (year, month, day, hours or minutes).
- 2 Touch [▲] or [▼] to change the field as necessary.
- 3 Set the correct date and time by changing all the fields in the same way.
- 4 Touch [Y.M.D], [M.D,Y] or [D.M.Y] to select the date format you prefer.

In some screens, the date will be displayed in short form (numbers instead of month names), but it will still follow the order you selected.

- 5 Touch [24H] to use 24-hour clock or leave it unselected to use 12-hour clock (AM/PM).
- 6 Touch [OK] to start the clock and close the setup screen.

NOTES

- You can adjust the date and time later on with the   [Date/Time] setting.
- When you do not use the camcorder for about 3 months, the built-in rechargeable lithium battery may discharge completely and the date and time setting may be lost. In such case, recharge the built-in lithium battery ( 182) and set the time zone, date and time again.

Changing the Language

The default language of the camcorder is English. You can set it to one of 26 other languages.



Operating modes: **AUTO** **M** **CINEMA** |

[FUNC.]* ➤ [MENU] ➤ ➤ [Language] ➤
Desired language ➤ [X]

* Only when performing the procedure in a recording mode.

NOTES

- Some control buttons, such as [ZOOM], [FUNC.] or [MENU], will appear in English regardless of the language selected.

Changing the Time Zone

Change the time zone to match your location. The default setting is New York.

Operating modes: **AUTO** **M** **CINEMA** |

1 Open the [Time Zone/DST] screen.

[FUNC.]* ➤ [MENU] ➤ ➤ [Time Zone/DST]

* Only when performing the procedure in a recording mode.

- 2 Touch to set the home time zone, or to set the time zone of your destination when you are traveling.
- 3 Touch or to set the desired time zone. If necessary, touch to adjust for daylight saving time.







4 Touch [X] to close the menu.

Using a Memory Card

Memory Cards Compatible for Use with the Camcorder

You can use the following types of commercially available Secure Digital (SD) cards with this camcorder.

As of October 2010, the movie recording function has been tested using SD/SDHC/SDXC memory cards made by Panasonic, Toshiba and SanDisk.

Memory card type:	 SD memory card,  SDHC memory card,  SDXC memory card
SD Speed Class*:	CLASS  CLASS  CLASS  CLASS 
Capacity:	128 MB or larger**.

* When using an SD memory card without a speed class rating, you may not be able to record movies, depending on the memory card used.

**SD memory cards with a capacity of 64 MB or smaller cannot be used to record movies.

NOTES

- **About the Speed Class:** Speed Class is a standard that indicates the minimum guaranteed data transfer speed of memory cards. When you buy a new memory card, look for the Speed Class logo on the package. We recommend using memory cards rated SD Speed Class 4, 6 or 10.

SDXC Memory Cards

You can use SDXC memory cards with this camcorder. When using memory cards with other devices, such as digital recorders, computers and card readers, **make sure that the external device is compatible with SDXC cards.** The table below summarizes compatibility by computer operating system, as of October 2010. For the latest information, however, contact the computer, operating system or memory card manufacturer.

Compatible operating systems for SDXC memory cards

Operating system	Compatibility
Windows 7	Compatible
Windows Vista	Compatible (requires Service Pack 1 or later)
Windows XP	Compatible (requires Service Pack 3 and KB955704 update)
Mac OS X	Not compatible

IMPORTANT

- If you use an SDXC memory card with a computer OS that is not SDXC-compatible, you may be prompted to format the memory card. In such case, **cancel the operation to prevent data loss.**
- After repeatedly recording, deleting and editing scenes (fragmented memory), it will take longer to write data on the memory and recording may stop. Save your recordings and initialize the memory.

Eye-Fi Cards

This product is not guaranteed to support Eye-Fi card functions (including wireless transfer). In case of an issue with an Eye-Fi card, please check with the card manufacturer.

Also note that an approval is required to use Eye-Fi cards in many countries or regions. Without approval, use of the card is not permitted. If it is unclear whether the card has been approved for use in the area, please check with the card manufacturer.

Inserting and Removing a Memory Card

Make sure to initialize (📖 44) all memory cards before using them with this camcorder.

1 Turn off the camcorder.

Make sure the ON/OFF (CHG) indicator is off.

2 Open the double memory card slot cover.

3 Insert the memory card straight, with the label facing up, all the way into one of the memory card slots until it clicks.

- You can also use two memory cards, one in each memory card slot.
- To use the wireless communication features of an Eye-Fi card, insert it into memory card slot **B**. Be sure you understand the information provided in *Eye-Fi Cards* (📖 40) before using an Eye-Fi card.

4 Close the double memory card slot cover.

Do not force the cover closed if the memory card is not correctly inserted.

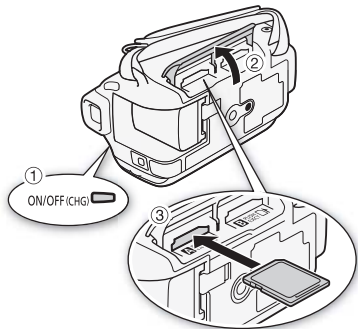

To remove the memory card

Push the memory card once to release it. When the memory card springs out, pull it all the way out.

! IMPORTANT

- Memory cards have front and back sides that are not interchangeable. Inserting a memory card facing the wrong direction can cause a malfunction of the camcorder. Be sure to insert the memory card as described in step 3.

Selecting the Memory for the Recordings

You can select to record your movies and photos in the built-in memory (**HFM41/M40** only) or on a memory card. The default memory for recording both is the built-in memory (**HFM41/M40**) or memory card **A** (**HFM400**).

Operating modes: **AUTO** **M** **CINEMA** |  





POINTS TO CHECK

- Be sure you understand the information provided in *Eye-Fi Cards* (📖 40) before using an Eye-Fi card.

HFM41/M40



[FUNC.] ➤ [MENU] ➤  ➤ [Rec Media for Movies] or [Rec Media for Photos] ➤  (built-in memory), [A] (memory card **A**) or [B] (memory card **B**)* ➤ [X]

HFM400



[FUNC.] ➤ [MENU] ➤  ➤ [Rec Media for Movies] or [Rec Media for Photos] ➤ [A] (memory card **A**) or [B] (memory card **B**)* ➤ [X]

* When selecting the memory, you can check the approximate available recording time/number of photos, based on currently used settings.





NOTES

- **HFM41/M40** Select to record movies in the built-in memory or memory card **A** if you later want to convert the movies to standard definition in order to upload them to the Web.

Relay Recording

You can activate the relay recording so if the memory you are using becomes full while recording movies, the recording will continue uninterrupted on a memory card.

When recording on memory card **A**, you can use memory card **B** for relay recording (**A** → **B**). **HFM41/M40** only: When recording in the built-in memory, you can choose to use only memory card **A** for relay recording ( → **A**), or use both memory cards ( → **A** → **B**).

Operating modes: **AUTO** **M** **CINEMA** |  

1 Insert a memory card that contains no video recordings into the card slot of the memory card you want to use for relay recording.

- When relay recording from the built-in memory (**HFM41/M40** only): memory card slot **A** or both memory card slots.
- When relay recording from memory card **A**: memory card slot **B** only.

2 Activate the relay recording.

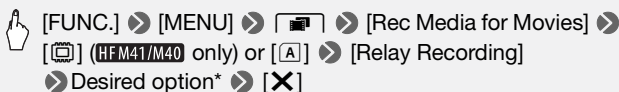

* The approximate available recording time will now reflect the combined space in the memories used for relay recording.

NOTES

- **HFM41/M40** You cannot use relay recording from the built-in memory to memory card **B**. When using a single memory card, be sure to insert it into memory card slot **A**.
- There will be a momentary stop in the scene at the point where the camcorder switches from one memory to another.
- Any of the following actions will deactivate the relay recording function:
 - Turning off the camcorder.
 - Opening the double memory card slot cover.
 - Changing the position of the mode switch.
 - Changing the camcorder's operating mode.
 - Changing the memory used for recording movies.

Initializing the Memory

Initialize memory cards when you use them with this camcorder for the first time. You can also initialize a memory card or the built-in memory (HFM41/M40 only) to permanently delete all the recordings it contains.

HFM41/M40 At the time of purchase, the built-in memory comes pre-initialized and contains music files for use as background music and images for use with the image mix function (image mix frames).





Operating modes: **AUTO** **M** **CINEMA** |  

1 Power the camcorder using the compact power adapter.



Do not disconnect the power source or turn off the camcorder until the initialization is completed.

2 Initialize the memory.

HFM41/M40

 [FUNC.]¹ ➤ [MENU] ➤  ➤ [Initialize / ] ➤
[ Built-in Mem.], [**A** Mem. Card A] or [**B** Mem. Card B]
➤ [Initialize] ➤ [Complete Initialization]² ➤ [Yes]³ ➤ [OK]
➤ [X]

HFM400

 [FUNC.]¹ ➤ [MENU] ➤  ➤ [Initialize ] ➤
[**A** Mem. Card A] or [**B** Mem. Card B] ➤ [Initialize] ➤
[Complete Initialization]² ➤ [Yes]³ ➤ [OK] ➤ [X]

¹ Only when performing the procedure in a recording mode.

² Touch this option if you want to physically erase all the data rather than just clear the file allocation table of the memory.

³ If you selected the [Complete Initialization] option, you can touch [Cancel] to cancel the initialization while it is in progress. All recordings will be erased and the memory can be used without any problem.

IMPORTANT

- Initializing the memory will permanently erase all recordings. Lost original recordings cannot be recovered. Make sure you save important recordings in advance using an external device (📖 131).
- Initializing a memory card will permanently erase any music files and images you may have transferred to the card. (HF M41/M40 The music files and image mix frames that come pre-installed in the built-in memory will be restored after it is initialized.) To transfer music files from the supplied Camcorder Supplemental Disc to the memory card:
 - Windows users: Use the supplied PIXELA's software. For details, refer to the Software Guide (PDF file) of the supplied PIXELA's software.
 - Mac OS users: Use Finder to transfer music files from the [MUSIC] folder on the supplied Camcorder Supplemental Disc to the memory card. Refer to *About the music files* (📖 197) for the folder structure of the memory card.
- At the time of purchase, Eye-Fi cards contain the necessary network configuration software. Be sure to install the software and complete the required configuration setup before you initialize the Eye-Fi card prior to using it with this camcorder.



AUTO Mode

This chapter covers how to easily record video and photos in **AUTO** mode, and how to use basic shooting functions like zoom and Quick Start. To enjoy full access to menus and more advanced functions, refer to *Recording in M (Manual) Mode* (📖 84).

Basic Recording

Shooting Video and Taking Photos in AUTO Mode

By default, movies and photos are recorded in the built-in memory (**HFM41/M40** only) or on memory card **A** (**HFM400**). You can select the memory that will be used to record movies and photos (📖 42). Please read the **IMPORTANT** section (📖 49) before using an Eye-Fi card.

Operating modes: **AUTO** **M** CINEMA |  



POINTS TO CHECK

- **Before you begin recording**, make a test recording first to check that the camcorder is operating correctly.

1 Set the mode switch to **AUTO**.

2 Turn on the camcorder.

To record video

Press **START/STOP** to begin recording.

- Press **START/STOP** again to pause the recording.
- The **ACCESS** indicator will flash from time to time while the scene is being recorded.

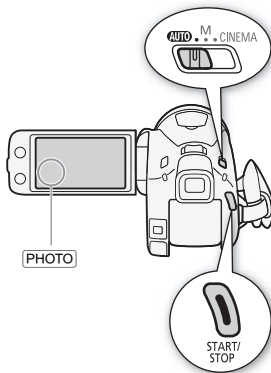

To take photos



Touch [PHOTO].

- A green icon (⊙) will appear momentarily on the screen and the ACCESS indicator will flash as the photo is recorded.
- You can record photos simultaneously while recording a movie.
- You can also press [PHOTO] on the wireless controller.









When you have finished recording

- 1 Make sure that the ACCESS indicator is off.
- 2 Turn off the camcorder.
- 3 Close the LCD panel.

Rating Scenes

You can turn on the scene rating option in recording mode with the   [Rate Scenes (Recording)] setting. Immediately after recording a scene, you will have the option to rate it by touching one of the rating buttons; you can also touch [. . .] or [X] to leave the scene unrated. Later you can play back scenes and perform other scene operations by rating.































About AUTO mode







- Only the following functions are available in  mode.
 - Zoom ( 51).
 - Quick Start ( 53).
 - Video snapshot ( 68).
 - Advanced image stabilization modes ( 90) to shoot video while walking or to stabilize the shot while zooming in on faraway subjects (telephoto).
 - Face detection ( 93) to get beautiful shots of people every time, tracking the subject even if the person moves.
 - Touch & Track ( 94) to track other moving subjects, keeping them in focus and using the best settings to record them.
 - Story Creator ( 65) to transform your movies into compelling video stories by following simple scripts for various scenarios.
 - Decoration ( 69) to add a fun personal touch using stamps, drawings, image mix and more.

About the Smart AUTO function

In  mode, the camcorder will automatically detect certain characteristics of the subject, background, lighting conditions, etc. It will then adjust various settings (focus, exposure, color, image stabilization, image quality, among others), selecting the best settings for the scene you want to shoot. The Smart AUTO icon will change to one of the following icons.

Smart AUTO icons

Background → (color of the icon)	Bright ² (grey)	Blue skies ² (light blue)	Vivid colors ² (green/red)	Sunsets (orange)
Subject ↓				
People (stationary)	 ()	 ()	 ()	—
People (moving)	 ()	 ()	 ()	—
Subjects other than people, such as landscapes	 ()	 ()	 ()	
Close objects	 /  ¹ ( /  ¹)	 /  ¹ ( /  ¹)	 /  ¹ ( /  ¹)	—

Background → (color of the icon)	Dark (dark blue)		
Subject ↓	Spotlight	Night scene	
People (stationary)		—	—
People (moving)		—	—
Subjects other than people, such as landscapes			
Close objects	 /  ¹	—	—

¹ This icon will appear under tele macro conditions.





² The icon in parentheses appears under backlight conditions.

! IMPORTANT

- Observe the following precautions while the ACCESS indicator is on or flashing. Failing to do so may result in permanent data loss or damage to the memory.
 - Do not open the double memory card slot cover.
 - Do not disconnect the power source or turn off the camcorder.
 - Do not change the camcorder's operating mode.

- Be sure to save your recordings regularly (📖 131), especially after making important recordings. Canon shall not be liable for any loss or corruption of data.
- Photos recorded on an Eye-Fi card in memory card slot **B** will be uploaded automatically after setting the camcorder to playback mode, if you are within the range of a configured network. Always verify that Eye-Fi cards have been approved in the country/region of use. See also *Using an Eye-Fi card* (📖 144).

NOTES

- **About the power saving mode:** If  ➤ [Power Saving Mode] ➤ [Auto Power Off] is set to [**ON** On], the camcorder will shut off automatically to save power when it is powered by a battery pack and is left without any operation for 5 minutes. Press **[POWER]** to turn on the camcorder.
- When recording in bright places, it may be difficult to use the LCD screen. In such cases, you can turn on the LCD backlight (📖 30) or adjust the brightness of the LCD screen with the  ➤ [LCD Brightness] setting. **[HFM41]** only: You can also use the viewfinder (📖 31).
- Under certain conditions, the Smart AUTO icon that appears on the screen may not match the actual scene. Especially when shooting against orange or blue backgrounds, the Sunset or one of the Blue Skies icons may appear and the colors may not look natural. In such case, we recommend recording in **[M]** mode (📖 84).
- In **[AUTO]** mode, most camcorder settings will return to default values, but the following settings will be maintained even after setting the mode switch to **[AUTO]**.
 - FUNC. panel: [Decoration], [Zoom].
 -  menu: [AF mode], [Auto Slow Shutter].
 -  menu: [Video Snapshot Length], [Rate Scenes (Recording)], [Rec Media for Movies], [Recording Mode], [Rec Media for Photos].
 -  menu: All settings.
- Photos are recorded as JPG files. The photo size (1920x1080) and quality cannot be changed. At this size, a 1 GB memory card can hold approximately 670 photos. However, the actual number of photos that can be recorded will vary depending on the subject and shooting conditions.

Zooming

Operating modes: **AUTO** **M** CINEMA |  

There are three ways you can zoom in and out: using the zoom lever on the camcorder, using the zoom buttons on the wireless controller or using the zoom controls on the touch screen.

In addition to the 10x optical zoom, in **M** mode, you can turn on the digital zoom (40x or 200x) with the  ➤ [Digital Zoom] setting.

Using the Zoom Lever or Wireless Controller

Move the zoom lever toward **W** (wide angle) to zoom out. Move it toward **T** (telephoto) to zoom in.

- By default, the zoom lever operates at a variable speed – press gently for a slow zoom; press harder for faster zooms.
- You can also use the zoom buttons on the wireless controller.

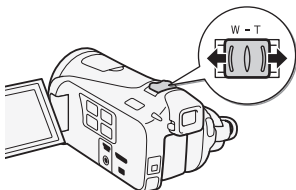

1 Display the zoom controls on the touch screen.

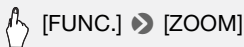

- The zoom controls appear on the left side of the screen.

2 Touch the zoom controls to operate the zoom.

Touch anywhere within the **W** area to zoom out or anywhere within the **T** area to zoom in. Touch closer to the center for a slow zoom; touch closer to the **W/T** icons for faster zooms.



3 Touch [X] to hide the zoom controls.

NOTES

- Keep at least 1 m (3.3 ft.) away from the subject. At full wide angle, you can focus on a subject as close as 1 cm (0.39 in.). Using tele macro (📖 101), you can focus on a subject as close as 40 cm (1.3 ft.) at full telephoto.
- In **[M]** or **[CINEMA]** mode, you can also set **[📺] [ZOOM SPEED]** to one of three constant speeds (3 is the fastest, 1 the slowest).
- When **[ZOOM SPEED]** is set to **[VAR Variable]**:
 - When you use the **T** and **W** buttons on the wireless controller, the zoom speed will be constant at **[🔍 Speed 3]**.
 - The zoom speed will be faster in record pause mode than when actually recording, except when pre-recording (📖 92) is activated.
- See *Specifications* (📖 196) for notes about this function when the recording program is set to **[👤 Underwater]** or **[🌊 Surface]**.

Quick Start Function

When you close the LCD panel with the camcorder on, the camcorder enters the standby mode. In standby mode the camcorder consumes only about 1/3 the power used when recording, saving energy when you are using a battery pack. Additionally, when you open the LCD panel or press **VIEWFINDER** (**HFM41** only), the camcorder is ready to start recording in approximately 1 second*, allowing you to record the subject right away.

* The actual time required varies depending on the shooting conditions.

Operating modes: **AUTO** **M** **CINEMA** |  

1 With the camcorder on and in a recording mode, close the LCD panel.

- A beep will sound and the green ON/OFF (CHG) indicator will change to orange to indicate the camcorder entered standby mode.
- **HFM41** When recording using only the viewfinder (with the LCD panel closed), you can press **VIEWFINDER** to set the camcorder in standby mode.

2 When you wish to resume recording, open the LCD panel.

- The ON/OFF (CHG) indicator turns back green and the camcorder is ready to record.
- **HFM41** You can also press **VIEWFINDER** to start recording with the LCD panel closed. Press **VIEWFINDER** again to return the camcorder to standby mode.

IMPORTANT

- Do not disconnect the power source during standby mode (while the ON/OFF (CHG) indicator is lit in orange).

NOTES

- The camcorder will not enter standby mode if the LCD panel is closed while the ACCESS indicator is on or flashing, while a menu is being displayed or while using the viewfinder (**HFM41** only). The camcorder may also not enter standby mode when the battery charge is too low. Check that the ON/OFF (CHG) indicator changes to orange.

- **About standby mode and auto power off:**

- The camcorder will power off automatically if left in standby mode for 10 minutes. Press **[POWER]** to turn on the camcorder.
 - You can select the length of time until shut-off or turn off the Quick Start function altogether with the **[]** **[▶]** **[Power Saving Mode]** **[▶]** **[Quick Start (Standby)]** setting.
 - The usual 5-minute auto power off setting of **[Power Saving Mode]** is not applicable while the camcorder is in standby mode.
- Changing the position of the mode switch while the camcorder is in standby mode will reactivate the camcorder in the operating mode selected.



Video

This chapter covers functions related to movies, including playback, advanced shooting, using Story Creator and other advanced functions. For details about basic video shooting, refer to *AUTO Mode* (📖 46).

Basic Playback

Playing Back Video

Operating modes: **AUTO** **M** **CINEMA** |  

1 Press .

You can also press and hold  on the wireless controller for more than 2 seconds to switch between shooting and playback mode.

2 Open the date index screen, if it is not displayed.

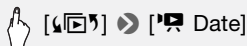
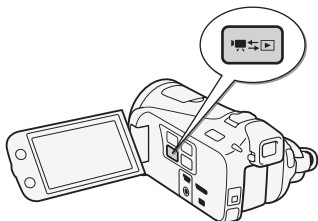

3 Look for the scene you want to play back.

Move the zoom lever toward **W** to show 15 scenes per page; move it toward **T** to show 6 scenes per page.



- 1 Memory being read.
- 2 Recording date.
- 3 Division line between recording dates.
- 4 Drag your finger left for the next index page*.
- 5 Drag your finger right for the previous index page*.
- 6 Open the index selection screen (📖 59).
- 7 3D Flip View (📖 59).
- 8 Scene's timeline (📖 115).

* While browsing through index pages, a scroll bar will appear at the bottom of the screen for a few seconds. When you have a large number of scenes it may be more convenient to drag your finger along the scroll bar.

4 Touch the desired scene to play it back.

- Playback will start from the scene selected and continue until the end of the last scene in the index screen.
- Touch the screen to display the playback controls. During playback, the playback controls will disappear automatically after a few seconds without operation. In playback pause, touch the screen again to hide the playback controls.

During playback:

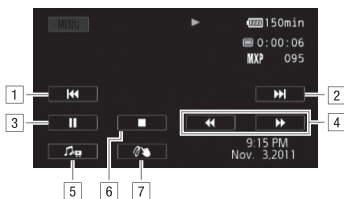

- 1 Jump to the beginning of the scene. Double-tap to jump to the previous scene.
- 2 Jump to the beginning of next scene.
- 3 Pause the playback.
- 4 Fast playback* backward/forward.
- 5 Display the volume (🔊 57) and background music mix balance (🎵 77) controls.
- 6 Stop the playback.
- 7 Decoration (📖 69).

* Touch several times to increase the playback speed to approximately 5x → 15x → 60x the normal speed. During fast playback, touch anywhere on the screen to return to normal playback.

Adjusting the volume

- 1 During playback, touch the screen to display the playback controls.
- 2 Touch [🔊], drag your finger along the [Speaker Volume]* bar to adjust the volume and touch [↶].

* When [🔊] ➔ [AV/Headphones] is set to [🎧 Headphones], adjust the [Headphone Volume] bar instead.

During playback pause:



- 1 Resume playback.
- 2 Slow playback* backward/forward.
- 3 Capture the displayed frame as a photo (📖 118).
- 4 Decoration (📖 69).

* Touch several times to increase the playback speed 1/8 → 1/4 the normal speed. During slow playback, touch anywhere on the screen to return to playback pause.

! IMPORTANT

- Observe the following precautions while the ACCESS indicator is on or flashing. Failing to do so may result in permanent data loss.
 - Do not open the double memory card slot cover.
 - Do not disconnect the power source or turn off the camcorder.
 - Do not change the camcorder's operating mode.
- You may not be able to play back with this camcorder movies recorded on a memory card using another device.

i NOTES

- You can turn off the recording date and time display or change the information displayed with the  [Data Code] setting.
- Depending on the recording conditions, you may notice brief stops in video or sound playback between scenes.
- During fast/slow playback, you may notice some anomalies (blocky video artifacts, banding, etc.) in the playback picture.
- The speed indicated on the screen is approximate.
- Slow reverse playback will look the same as continuous frame reverse.

3D Flip View

Touch [] in the date index screen to switch to 3D Flip View. This fun way of displaying scenes grouped by recording date in a 3D layout can be useful to flip through a large number of recordings.

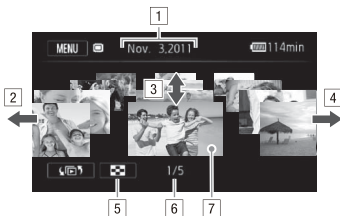

- 1 Recording date.
- 2 Drag your finger left to go to the next date with recordings.
- 3 Drag your finger up and down to browse through the scenes recorded in the displayed date.
- 4 Drag your finger right to go to the previous date with recordings.
- 5 Return to the date index screen.
- 6 Current scene / Total number of scenes recorded on the selected date.
- 7 Touch the scene in the front to play it back.

The Index Selection Screen: Selecting the Content to Play Back

From the index selection screen you can select the content you want to play back (original scenes by date or by story, or photos, for example). You can also select the memory from which you want to play back your recordings.

Operating modes: **AUTO** **M** **CINEMA** |  





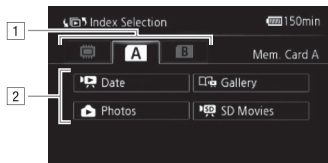

In any index screen, touch [].

During single photo view, touch the screen once to display the controls then touch [] to open the [Photos] index screen.



- 1 Touch the tab of the desired memory: built-in memory (**HFM41/M40** only), memory card **A** or memory card **B**.
- 2 Touch a control button to select the content you want to play back.

Options

- [ **Date**] Scenes organized by recording date.
- [ **Gallery**] Scenes organized by story ( 74).
- [ **Photos**] Photos' index screen.
- [ **SD Movies**] (**HFM41/M40** only when a memory card is selected)
Scenes that were converted to standard definition to upload them to the Web ( 139).

NOTES

- **HFM41/M40** Fast/slow playback modes are not available for scenes converted to standard definition. Scenes in the [SD Movies] index screen can only be played back at normal speed.

Two playback modes: the date index screen vs. the gallery

In the **date index screen** you can find all the movies you have recorded, conveniently organized by recording date. When you play back scenes from the date index screen they will be played back in chronological order.

In the **gallery**, you can find your scenes grouped as video stories. If you record movies using the Story Creator function (📖 65), your scenes will appear in the story you created; scenes recorded without using this function will appear in the [Unsorted] story (or [Video Snapshot] story, in the case of video snapshot scenes). When you play back a story from the gallery, scenes will be played back in the order of the story's outline, regardless of their recording date.

Deleting Scenes and Stories

You can delete those scenes and stories that you are not interested in keeping. Deleting scenes allows you also to free up space on the memory.

Operating modes: **AUTO** **M** **CINEMA** |  

Deleting a Single Scene

- 1 Play back the scene you wish to delete.
- 2 Touch the screen to display the playback controls.
- 3 Delete the scene.



Deleting Scenes from the Date Index Screen

- 1 Open the date index screen.

To delete all the scenes recorded on a specific date, drag your finger left/right until the desired date appears in the title bar.

2 Delete the scenes.



[Edit] ➤ [Delete] ➤ Desired option* ➤ [Yes]** ➤ [OK]

* When you select [Select], perform the following procedure to select the individual scenes you want to delete before touching [Yes].

** Touch [Stop] to interrupt the operation while it is in progress. Some scenes may be deleted nevertheless.

To select individual scenes

1 Touch on the individual scenes you want to delete.

- A checkmark ✓ will appear on the scenes you touch. The total number of selected scenes will appear next to the icon.
- Touch a selected scene to remove the checkmark. To remove all checkmarks at once, touch [Remove All] ➤ [Yes].

2 After selecting all the desired scenes, touch [OK].

Options

[date] Delete all the scenes recorded on the date shown in the control button.

[Select] Select individual scenes to delete.

[All Scenes] Delete all the scenes.

Deleting a Single Scene from a Story

1 Open the list of scenes of the story that contains the scene you want to delete.



[📁] ➤ [📁 Gallery] ➤ Bring the desired story to the front ➤ [Scene List]

2 In the [Scene List] screen, drag your finger up/down to select the scene you want to delete.

3 Touch the orange box on the right to open the [Edit Scene] screen.

4 Delete the scene.

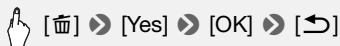

Deleting Scenes from a Story by Rating

- 1 Open the information screen of the story that contains the scenes you want to delete.

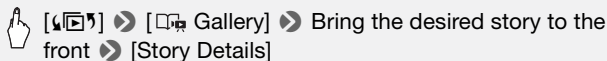

- 2 Open the rating selection screen.

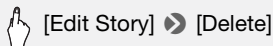

- 3 Touch one or more of the rating buttons to select all the applicable scenes.

A grayed out rating button indicates that no scenes in the story have been given that particular rating.

- 4 Delete all applicable scenes.



* Touch [Stop] to interrupt the operation while it is in progress. Some scenes may be deleted nevertheless.

Deleting Stories

Deleting a story permanently deletes all the scenes it contains. The two preexisting stories, [Unsorted] and [Video Snapshot], cannot be deleted.

- 1 Open the gallery.

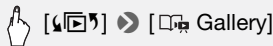

2 Select the story you want to delete.

Drag your finger right/left to bring the desired story to the front.

3 Delete the story.



[Story Details] ➤ [Edit Story] ➤ [Delete Story] ➤ [Yes]*

➤ [OK]

* Touch [Stop] to interrupt the operation while it is in progress. Some scenes may be deleted nevertheless.

! IMPORTANT

- Be careful when deleting recordings. Once deleted, scenes cannot be recovered.
- Deleting a story permanently deletes all the scenes it contains.
- When deleting scenes, scenes will be removed from the date index screen and from any stories in the gallery they may have belonged to, regardless of the method used to delete them.
- Save copies of important scenes before deleting them (📖 134).
- Observe the following precautions while the ACCESS indicator is on or flashing (while scenes are being deleted).
 - Do not open the double memory card slot cover.
 - Do not disconnect the power source or turn off the camcorder.
 - Do not change the camcorder's operating mode.

i NOTES

- To delete all movies and make all recordable space available again you may prefer to initialize the memory (📖 44).

Video Stories and Cinema Style

Using Story Creator to Create Compelling Stories

Story Creator is a helpful function that offers suggestions for typical scenes in a number of situations. With Story Creator, creating interesting video stories is as easy as selecting one of the story themes, such as [Travel], [Party] or [Kids & Pets], and following the suggested categories to record video. During playback, select your story from the gallery to play back the scenes you recorded as a single, compelling video story (📖 74).

Operating modes: **AUTO** **M** **CINEMA** |  

Creating a New Story

1 Press .

If the memory already contains other stories, the story selection screen will appear. In that case, touch [New Story].

2 Select the desired theme.

- Drag your finger left/right to browse through the themes and touch the thumbnail of the desired theme.
- A list of the suggested categories (story scenes) for the selected theme will appear.

3 Drag your finger up/down to select a category and touch [OK].

4 In the confirmation screen, touch [Yes] to create the story.

- Initially, the current date will be used as the story's title, but you can change it (📖 82) before pressing [Yes].
- A new story will be created and the camcorder will enter record pause mode. The selected story scene category will appear at the bottom of the screen.

Recording a Scene within a Story

Press **START/STOP** to record movies within the selected story scene (category).

- Use the displayed recommended length as a reference when recording scenes.

- Scenes will be recorded under the story and category currently selected.
- You can also record video snapshot scenes (📷 68).

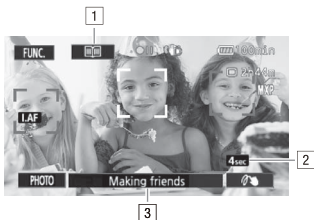

- 1 Return to the list of story scenes (categories).
- 2 Recommended length of scenes in this category.
- 3 Currently selected story scene (category). You can also touch here to return to the list of story scenes.

To select a different story scene (category)

- 1 Touch [📖] to return to the list of story scenes.
When it appears on the screen, you can also touch the button of the current story scene.
- 2 Drag your finger up/down to select another category and touch the orange frame on the right (number of scenes).

To exit Story Creator mode

Press [📷] and touch [Yes].

NOTES

- When recording video snapshot scenes, you can have the camcorder automatically link the length of video snapshot scenes to the recommended length of story scenes with the [📷] ➤ [Video Snapshot Length] setting.

Recording Additional Scenes within an Existing Story

- 1 Press [📷].
- 2 Select the story to which you want to add new scenes.

The list of story scenes will appear. The orange frame on the right will show how many scenes you have recorded in each story scene (category).

3 Drag your finger up/down to select a category and touch the orange frame on the right (number of scenes).

The camcorder will enter record pause mode and the selected story scene category will appear at the bottom of the screen.

4 Press  to record a scene within the selected story scene.



CINEMA Mode and Cinema-Look Filters

In  mode, the camcorder will adjust the frame rate and several other picture-related settings to give your recordings a cinematic look. In this mode you can also use a variety of professional cinema-look filters to create unique movies with a distinctive appearance.

Operating modes:    |  

1 Set the mode switch to CINEMA.

2 Select the desired cinema-look filter.

 [FILTER 1]  Desired cinema-look filter*  [OK]

* When you select a cinema-look filter other than [Cinema Standard], you can change the effect level with the following procedure before touching [OK].

- The selected cinema-look filter will be applied and its number will appear on the control button.

To select the effect level of the cinema-look filter

 []  [L] (low), [M] (medium) or [H] (high)  []

Options (♦ Default value)

The camcorder offers 9 cinema-look filters. Select the desired filter while previewing the effect on the screen.

[1: Cinema Standard]♦

[2: Vivid]

[3: Dream]

[4: Cool]

[5: Nostalgic]

[6: Sepia]

[7: Old Movies]

[8: Memory]

[9: Dramatic B&W]

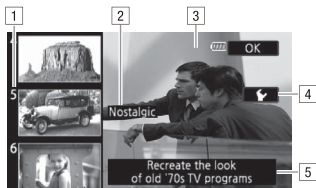



- 1 Filter number (will appear on the control button)
- 2 Filter name
- 3 Preview the effect on the screen
- 4 Select the effect level
- 5 Brief description (onscreen guidance)

NOTES

- Photos cannot be recorded while the camcorder is set to **CINEMA** mode.

Video Snapshot

Record a series of short scenes. Then, play back your video snapshot scenes set to your favorite music ( 77) to create your own fun music video. You will be surprised how by changing the background music, you can give your scenes an entirely new feel.

The default length of a video snapshot scene is 4 seconds but you can change it to 2 or 8 seconds, or to the length recommended for the selected story scene (category) in Story Creator, with the   [Video Snapshot Length] setting.

Operating modes: **AUTO** **M** **CINEMA** |  

1 Press **VIDEO SNAP**.

- A blue border appears on the screen.
- Press **VIDEO SNAP** again to return to normal video recording mode.

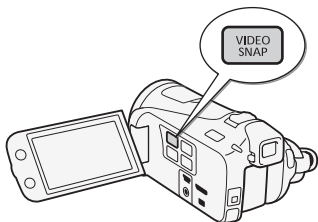

2 Press **START/STOP**.

- The camcorder records for a few seconds (the blue frame serves as a visual progress bar) and then automatically returns to record pause mode.
- When the camcorder stops recording, the screen will momentarily turn black as if a camera shutter had released.

i NOTES

- Changing the camcorder's operating mode will deactivate the video snapshot mode.

Decoration: Adding a Personal Touch

Add a new level of enjoyment to your scenes by decorating them. You can add animated graphics, stamps and even your own freehand drawings. The supplied stylus pen will be especially useful for decorating scenes. You can decorate scenes as they are being recorded, during playback or just before converting them to standard definition (**HFM41/M40** only).

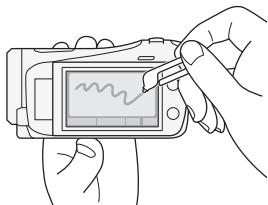

Operating modes: **AUTO** **M** **CINEMA** |  

1 Open the decoration screen.



- The decoration screen will open automatically also when you stow the LCD panel with the touch screen facing out.





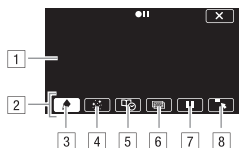

2 Use a tool from the toolbar as explained in the following procedures.

3 Press **[START/STOP]** to record movies with your decorations.

You can add decorations even while recording a scene.

4 Touch **[X]** to exit the decoration screen.



- 1 Canvas - The area where you will draw and see your decorations in action.
- 2 Toolbar.
- 3  [Pens and Stamps] Select the type of pen or stamp and its color. You can also save a canvas or load a previously saved canvas.
- 4  [Animated Stamps] Select animated stamps to add to your decoration.
- 5  [Captions] Add the date, date and time, story title or story theme as a caption that will be included in the recording.
- 6 * [Image Mix] Choose one of 27 different frames to add onto the canvas. Image mix can be used in combination with the pens, stamps and animated stamps.
- 7 * In recording mode: pause the live video. Touch  again to restore the live video. You can add decorations to and record the frozen image.

In playback mode: pause the playback. Touch [▶] to resume playing back the scene.

- 8 [☰] Minimize the toolbar to the top of the screen to view almost all of the canvas. Touch [☰] to restore the toolbar.

* Not available in **CINEMA** mode.

To use [Pens and Stamps]

- 1 Touch [✎].

The [Pens and Stamps] screen will appear.

- 2 Select the desired pen or stamp from [Tools].

- 3 Select white or black from [Colors].

Alternatively, you can touch [✎] and select a color from the color palette.

- 4 Draw freely on the canvas.

Touch [✎] ➤ [Clear] ➤ [Yes] to clear the canvas and start again.

- 5 When you finish drawing, save the canvas.

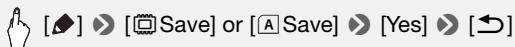

- The freehand drawings and stamps will be saved in the built-in memory (**HFM41/M40** only) or on memory card **A** (**HFM400** only).

To load a previously saved canvas

In the decoration screen:

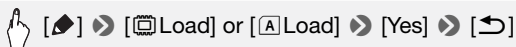

- The camcorder will apply the last freehand drawings and stamps that were saved in the built-in memory (**HFM41/M40** only) or on memory card **A** (**HFM400** only).

To use [Animated Stamps]

- 1 Touch [🌀].

The [Animated Stamps] screen will appear.

- 2 Touch one of the control buttons.

- 3 Touch anywhere on the canvas to place the selected animated stamp. You can also drag the animated stamp to a different location.

To use [Captions]

- 1 Touch [🗨️].
The [Captions] screen will appear.
- 2 Touch [Date] or [Time].
When recording a scene using Story Creator, you can also select [Title] (the story's title) or [Story Scene] (the story scene category).
- 3 Select the desired text settings and touch [↵].
 - Touch [👉] (white text on dark background), [□] (white text) or [■] (black text).
 - The selected caption will appear in the center of the screen.
- 4 Touch the caption and drag it to the desired location.

To use image mix

- 1 Open the [Select Image] screen.



- 2 Touch [+] or [-] to select a different image mix frame.
You can touch one of the memory icons at the bottom of the screen to read image mix frames saved on a different memory (HFM41/M40): only when recording on or playing back scenes from a memory card).
- 3 Touch [↵] to mix the selected frame with the live video.

Mixing Your Own Images with Live Video

You can use images you make on your computer for the image mix (Chroma Key) function. Make sure that the image you want to use has a blue or green area, which will be replaced by the live video using Chroma Key mixing. Refer to *About the image files for the Image Mix function* (📖 197) for details about the types of image files that can be used and where to transfer them.

Example of an image used for Chroma Key

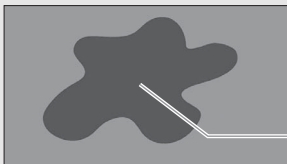

Blue/Green area that will be replaced by the live video

To use the Chroma Key function

- 1 Open the [Select Image] screen of the image mix function (📖 72).
- 2 Touch [+] or [-] to select the image you created.
- 3 Touch [▶] to open the [Chroma Key] screen.
- 4 Touch [Green] or [Blue] depending on the characteristics of the image you want to use and touch [◀] or [▶] or drag your finger along the bottom bar to adjust the chroma key setting as necessary.
- 5 Touch [▶] at the top of the screen to open the [Transparency] screen.
- 6 Touch [◀] or [▶] or drag your finger along the bottom bar to adjust the overall transparency of the image as necessary.
- 7 Touch [↻] to mix your image with live video.

Decorating Scenes during Playback



Operating modes: **AUTO** **M** **CINEMA** |  

- 1 Play back the scene you want to decorate.

- 2 Touch the screen to display the playback controls.
- 3 Touch  to open the decoration screen.
- 4 Decorate the scene using the tools from the toolbar as explained in the previous section.

In playback mode, the decorations will not be saved with the original recording.

NOTES

- Initializing a memory will erase any [Pens and Stamps] drawing canvas and image files you may have saved. (HFM41/M40 The image mix frames that come pre-installed in the built-in memory will be restored after it is initialized.)
- Animated stamps and captions cannot be used at the same time.
- HFM41/M40 When   [Rec Media for Movies] is set to  (the built-in memory), you will not be able to select image mix frames saved on a memory card.
- Image mix cannot be selected during playback or while converting a scene to standard definition (HFM41/M40 only). Select the image mix during playback pause or before starting the conversion.

Playing Back Stories from the Gallery

You can play back recordings made using Story Creator to play them back as a single compelling video story following the order of the story's script. Regular scenes and video snapshot scenes recorded without using Story Creator, will appear in the gallery under the [Unsorted] or [Video Snapshot] stories. When playing back stories from the gallery, you can choose to play back only scenes with a certain rating.

Operating modes:    |  

1 Open the gallery.

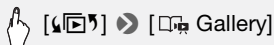

- From the date index screen you can also press  to open the gallery on the same memory.



- 1 Drag your finger right or left to select a story.
- 2 Story's theme.
- 3 Selected story (large thumbnail in the front).
- 4 Story's title (📖 82).
- 5 Open the index selection screen (📖 59).
- 6 Details about the story (number of scenes, total playback time) and editing options.
- 7 List of scenes recorded in the selected story.

2 Select the story you want to play back.

Drag your finger right/left to bring the desired story to the front.

3 Select the rating of the stories you want to play back.

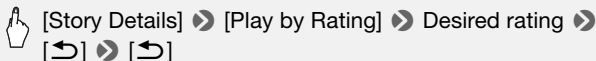

4 Touch the story's thumbnail to start the playback.

- The complete story will be played back from the first scene to the last. When playback ends, the camcorder will return to the gallery.
- Touch the screen to display the playback controls. Touch [📖] to display the scene's category during playback. Touch [📖] to turn the story scene display off.
- Playback controls are the same as when playing back scenes from the date index screen (📖 57).

! IMPORTANT

- Observe the following precautions while the ACCESS indicator is on or flashing. Failing to do so may result in permanent data loss.

- Do not open the double memory card slot cover.
- Do not disconnect the power source or turn off the camcorder.
- Do not change the camcorder's operating mode.

Rating Scenes

You can rate story scenes immediately after recording them (📖 48) or during playback. You can then select multiple scenes with the same rating, for example, in order to play back or copy only your favorite scenes.

Operating modes: **AUTO** **M** CINEMA |  

Rating Scenes from the List of Scenes

- 1 Open the list of scenes of the story that contains the scenes you want to rate.

 [📖] ➤ [🖼️ Gallery] ➤ Bring the desired story to the front ➤ [Scene List]

- 2 In the [Scene List] screen, drag your finger up/down to select the scene you want to rate.
- 3 Touch the orange box on the right to open the [Edit Scene] screen.
- 4 Touch the control button of the desired rating and touch [↩️] twice to return to the gallery.

Rating Scenes During Playback

- 1 Play back from the gallery the story that contains the scenes you want to rate.
- 2 During playback of a scene you want to rate, pause the playback and rate the scene.

 Touch the screen ➤ [⏸️] ➤ [Edit] ➤ [Rating] ➤ Desired rating ➤ [X]

- 3 Touch [▶] to resume the playback and rate other scenes in the same way or touch [■] to return to the gallery.

Playback with Background Music

Play back movies (or a photo slideshow) with background music. You can use one of the supplied music tracks or connect an external audio player to use your favorite songs as background music.

Operating modes:    |  

Using One of the Supplied Music Tracks as Background Music

The supplied Camcorder Supplemental Disc contains 3 music tracks you can use as background music. **HFM41/M40**: The music files come pre-installed in the built-in memory.

You can mix the original audio and the background music and adjust the background music mix balance to your preference.



POINTS TO CHECK

- To play back scenes or a slideshow of photos recorded on the memory card, you will need to transfer the music tracks to the memory card in advance. See the NOTES section (80).

1 Open the gallery or date index screen.

 [◀▶] ➤ [📁 Gallery] or [📅 Date]

2 Select the music track.

 [MENU] ➤ [🔊] ➤ [Select Music] ➤ [ON On] ➤ [▲] or [▼] to select the desired music track

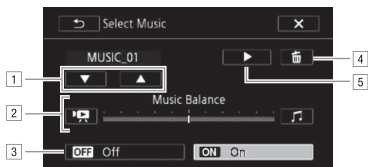

- 1 Select the desired music track.
- 2 Adjust the background music balance.
- 3 Play back the original sound (no background music).
- 4 Delete the music track selected.
- 5 Listen to the music track selected. Touch again (■) to stop the playback.

3 Adjust the mix balance between the original sound and the background music.

Touch [■] (more of the original sound) or [♪] (more of the background music) or drag your finger along the [Music Balance] bar to adjust the background music balance as desired.

4 Touch [X] and then touch a story or scene to start the playback with the selected background music.

To adjust the background music balance during playback

- 1 During playback, touch the screen to display the playback controls.
- 2 Touch [♪], drag your finger along the [Music Balance] bar to adjust the background music balance as desired and touch [↶].

To delete a music track

In the [Select Music] screen, touch [▲] or [▼] to select the track you want to delete.



Using an External Audio Player for Background Music

Use your favorite songs as background music by connecting an external player.

POINTS TO CHECK

- You will need a commercially available audio cable with at least one mini-stereo plug (to connect to the MIC terminal on the camcorder); the other end will depend on external player used).

1 Open the gallery or date index screen.



2 Activate the external audio input.

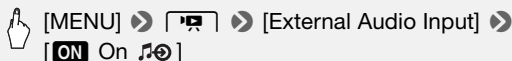

3 Connect the external player to the camcorder's MIC terminal.

4 Adjust the audio input as necessary.

- Start the music playback on the external player and adjust its volume according to the onscreen indications. When the audio input is in the correct range, stop the music playback and touch [X] on the camcorder.
- Touch [External Player Link] to link the video playback to the start/end of the music from the external player.

Playback with the video linked to the external audio

5 Start the music playback on the external player.

- Playback will start from the first scene in the story or index screen.
- When the external audio input stops, video playback will pause. When the external audio input is restored, video playback will resume automatically.
- Even when the video playback stops, audio playback on the external player will not stop automatically.

Playback with the video not linked to the external audio

- 5 Touch a story or scene to start the video playback.
- 6 Start the music playback on the external player.

IMPORTANT

- If you use copyrighted songs and music tracks in your video creations, remember that music under copyright may not be used without permission from the copyright holder, except for cases permitted under applicable laws, such as for personal use. Make sure to follow applicable laws when using music files.

NOTES





- Initializing a memory card will permanently erase any music files you may have transferred to the card. (HF M41/M40 The music files that come pre-installed in the built-in memory will be restored after it is initialized.) To transfer music files from the supplied Camcorder Supplemental Disc to the memory card:
 - Windows users: Use the supplied PIXELA's software. For details, refer to the Software Guide (PDF file) of the supplied PIXELA's software.
 - Mac OS users: Use Finder to transfer music files from the [MUSIC] folder on the supplied Camcorder Supplemental Disc to the memory card. Refer to *About the music files* ( 197) for the folder structure of the memory card.
- Transfer music files to the memory card that contains the recordings you want to play back with background music.
- **About video playback linked to the external player:**
 - In some cases, the video playback may not be correctly linked to the external player. For example, if the volume of external player is too low or if the audio signal contains a lot of noise, etc.
 - When you connect the MIC terminal to the audio outputs on the external player and cannot adjust the strength of the signal, the camcorder will automatically decrease the volume of the external player when the audio signal is too loud.

Copying and Moving Scenes Within/Between Stories

You can copy and move scenes in the gallery within the same story scene (category), between story scenes in the same story, and between stories recorded in the same memory.

Operating modes: **AUTO** **M** **CINEMA** |  

- 1 Open the list of scenes of the story that contains the scene you want to copy or move.

 []  [ Gallery]  Bring the desired story to the front  [Scene List]

- 2 In the [Scene List] screen, drag your finger up/down to select the scene you want to copy/move.
- 3 Touch the orange box on the right to open the [Edit Scene] screen and touch [Copy] or [Move].
- 4 Select the destination.
Drag your finger right/left to select the desired story and touch its thumbnail. Then, drag your finger up/down to select the desired category and touch the orange frame on the right (number of scenes). And last, drag your finger up/down to move the orange bar within the category to select the position of the scene.
- 5 Copy or move the scene.

 [Set]*  [Yes]**  [OK]  []

* This step is not necessary when copying/moving a scene into a story scene category that contains no other scenes.

**When copying a scene, you can touch [Stop] to interrupt the operation while it is in progress.

NOTES

- You cannot copy or move scenes to the two preexisting stories, [Unsorted] and [Video Snapshot].

Selecting a Story's Thumbnail Image

Initially, the image used as the story's thumbnail is the first frame of the first scene in the story. You can set your favorite scene as the thumbnail that will represent the story in the gallery.

Operating modes: **AUTO** **M** CINEMA |  

1 Open the gallery.

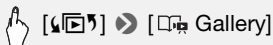

2 Select the story whose thumbnail you want to change.

Drag your finger right/left to bring the desired story to the front.

3 Open the [Story Thumbnail] screen.



4 Locate the frame you want to use as the story's thumbnail.

Playback controls will appear on the screen ( 57). Use any special playback modes (fast/slow playback, frame reverse/advance) as necessary to locate the desired image.

5 Touch [Set] to change the story's thumbnail.

6 Touch [] to return to the gallery.

Changing a Story's Title

When you first create a story, the current date will be used as the story's title but you can change the title later on. The title can be up to 14 characters long (available characters are limited). The title of the two preexisting stories, [Unsorted] and [Video Snapshot] cannot be changed.

Operating modes: **AUTO** **M** CINEMA |  

1 Open the gallery.



2 Select the story whose title you want to change.

Drag your finger right/left to bring the desired story to the front.

3 Open the [Edit Title] screen.

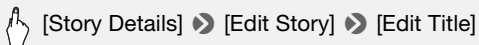

4 Use the virtual keyboard to change the title.

5 Touch [OK] ► [↶] ► [↷] to return to the gallery.



- 1 Switch between letters and numbers/special characters.
- 2 Change the position of the cursor.
- 3 Delete the character to the cursor's left (backspace).
- 4 Caps Lock. When the numerical keyboard is displayed, [#%?] switches between set 1 and set 2 of special characters.

Advanced Functions

Recording in **M** (Manual) Mode

When the mode switch is set to **M** (Manual mode), you can enjoy full access to the menus and manually adjust the exposure, focus, white balance and many more of the camcorder's settings to your preference. Even in **M** mode, though, the camcorder can help you with the settings. For example, by using Special Scene recording programs (87).

By default, movies and photos are recorded in the built-in memory (HFM41/M40 only) or on memory card **A** (HFM400). You can select the memory that will be used to record movies and photos (42). Please read the IMPORTANT section before using an Eye-Fi card.

Operating modes: **AUTO** **M** **CINEMA** |  

1 Set the mode switch to **M**.

2 Turn on the camcorder.

3 Record movies and photos.

The procedure is the same as in **AUTO** mode (46).

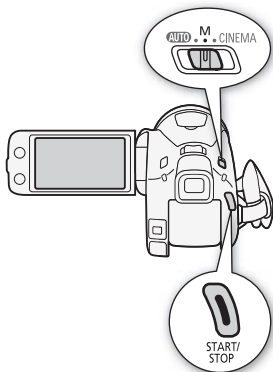

IMPORTANT

- Observe the following precautions while the ACCESS indicator is on or flashing. Failing to do so may result in permanent data loss or damage to the memory.
 - Do not open the double memory card slot cover.
 - Do not disconnect the power source or turn off the camcorder.
 - Do not change the camcorder's operating mode.

- Be sure to save your recordings regularly (📖 131), especially after making important recordings. Canon shall not be liable for any loss or corruption of data.
- Photos recorded on an Eye-Fi card in memory card slot **B** will be uploaded automatically after setting the camcorder to playback mode, if you are within the range of a configured network. Always verify that Eye-Fi cards have been approved in the country/region of use. See also *Using an Eye-Fi card* (📖 144).

NOTES

- The zoom, Quick Start function, power saving modes, etc. operate the same way in **M** mode as in **AUTO** mode. For details, refer to *AUTO Mode* (📖 46).
- Photos cannot be recorded while the digital zoom is activated or while fading in or fading out a scene.

Reviewing the Latest Scene Recorded

You can review the last 4 seconds of the last scene recorded with the camcorder without switching to playback mode. While reviewing the latest scene, the picture will be played back without sound.

Operating modes: **AUTO** **M** CINEMA |  

- 1 Set the mode switch to **M** or CINEMA.
- 2 Review the last 4 seconds of the scene.

 [FUNC.] ➤ [📺 Review Recording]

Selecting the Video Quality (Recording Mode)

The camcorder offers 5 recording modes. Changing the recording mode will change the recording time available on the memory. Select MXP or FXP mode for better movie quality; select LP mode for longer recording times. The following table gives approximate recording times.

Operating modes: **AUTO** **M** CINEMA |  



[FUNC.] ➤ [MENU] ➤  ➤ [Recording Mode] ➤
Desired recording mode ➤ [X]

NOTES

- Movies recorded in MXP mode cannot be saved on AVCHD discs. Use an external Blu-ray Disc recorder to copy MXP movies onto Blu-ray discs or use the supplied software **VideoBrowser** to create AVCHD discs*.
- The camcorder uses a variable bit rate (VBR) to encode video so the actual recording times will vary depending on the content of the scenes.
- The camcorder retains the last setting used even if you set the camcorder to **AUTO** mode.

* MXP scenes will be converted to an image quality similar to that of FXP scenes.

Approximate recording times

◆ Default value

Recording mode →	MXP ¹	FXP ¹	XP+	SP [◆]	LP
Memory ↓					
4 GB Memory card	20 min.	30 min.	40 min.	1 hr. 10 min.	1 hr. 30 min.
8 GB Memory card	40 min.	1 hr.	1 hr. 25 min.	2 hr. 20 min.	3 hr.
16 GB Memory card/ HFM40 Built-in memory ²	1 hr. 25 min.	2 hr. 5 min.	2 hr. 50 min.	4 hr. 45 min.	6 hr. 5 min.
32 GB Memory card/ HFM41 Built-in memory ²	2 hr. 55 min.	4 hr. 10 min.	5 hr. 45 min.	9 hr. 35 min.	12 hr. 15 min. ³

¹ Recorded in 1,920 x 1,080 resolution. Movies recorded using other recording modes are recorded in 1,440 x 1,080 resolution.

² **HFM41/M40** At the time of purchase, the built-in memory contains about 70 MB of music files (background music) and 5 MB of image files (image mix frames).

³ A single scene can be recorded continuously for 12 hours; at that point, the camcorder will stop for about 3 seconds before resuming recording.

Selecting the Frame Rate

You can change the frame rate (the number of frames recorded per second) to change the look of your movies.

Operating modes: **AUTO** **M** **CINEMA** |  

 [FUNC.] ➤ [MENU] ➤  ➤ [Frame Rate] ➤
Desired frame rate ➤ [X]

Options

[60i 60i (Standard)] 60 fields per second, interlaced. Standard frame rate of NTSC analog TV signals.

[PF30 PF30] Shooting at 30 frames per second, progressive*. Use this frame rate to easily edit your recordings, for example, to post them on the Web.



[PF24 PF24] Shooting at 24 frames per second, progressive*. Using this frame rate will give your recordings a cinematic look. Recording in **CINEMA** mode will further enhance the effect.

* Recorded as 60i.

Special Scene Recording Programs

Recording in a very bright ski resort or capturing the full colors of a sunset or a fireworks display becomes as easy as selecting a Special Scene recording program.

Operating modes: **AUTO** **M** **CINEMA** |  

 [FUNC.] ➤ [Rec. Programs] ➤  Portrait] ➤
Desired recording program ➤ [X]

Options (♦ Default value)

[Portrait]♦ The camcorder uses a large aperture, to achieve a sharp focus on the subject while blurring the background.



[Sports] To record sports scenes such as tennis or golf.



[Night Scene] To record nightscapes with lower noise.



[Snow] To record in bright ski resorts without the subject being underexposed.



[Beach] To record on a sunny beach without the subject being underexposed.



[Sunset] To record sunsets in vibrant colors.



[Low Light] To record in low-light situations.



[Spotlight] To record spotlit scenes.



[🎆 Fireworks] To record fireworks.



[🐠 Underwater] To record underwater scenes in natural colors.









[🏊 Surface] To record after getting out of the water, such as on a boat after diving.



i NOTES

- [👤 Portrait]/[🏊 Sports]/[❄️ Snow]/[🏖️ Beach]: The picture may not appear smooth during playback.
- [👤 Portrait]: The blur effect of the background increases the more you zoom in (**T**).
- [❄️ Snow]/[🏖️ Beach]: The subject may become overexposed on cloudy days or in shaded places. Check the image on the screen.
- [💡 Low Light]:
 - Moving subjects may leave a trailing afterimage.
 - Picture quality may not be as good as in other modes.
 - White points may appear on the screen.
 - Autofocus may not work as well as in other modes. In such case, adjust the focus manually.
- [🎆 Fireworks]: To avoid camcorder blur (blur due to the camcorder moving) we recommend using a tripod.
- [🐠 Underwater]/[🏊 Surface]:
 - Use these recording programs when making recordings while the camcorder is in the optional WP-V3 Waterproof Case.
 - The [🐠 Underwater] recording program is for making recordings underwater*. When using underwater lighting equipment or making recordings while on land, we recommend using the [🏊 Surface] recording program.
 - To switch the recording program between [🐠 Underwater] and [🏊 Surface] while the camcorder is in the waterproof case, turn on the camcorder while moving the zoom lever toward **T** or **W**. Keep

pushing the zoom lever until the  or  icon appears on the screen.





-  will appear on the screen when the camcorder's temperature becomes too high. If this happens, turn off the camcorder, take it out of the waterproof case and keep it in a cool place until the temperature goes down. If the camcorder becomes too hot, it will turn off automatically.
- When making recordings underwater with the [ Underwater] recording program, the image on the LCD screen will appear redder than the actual subject. This will not affect the recording.
- When a commercially available wide-converter or other accessory is attached to the waterproof case, the camcorder may focus on the accessory. In such case, move the zoom lever toward **T** to focus on the subject.
- See *Specifications* ( 196) for additional notes about the [ Underwater] and [ Surface] recording programs.

* Underwater is a unique environment that is ever-changing, depending on factors such as the weather and water conditions. In addition, water absorbs red light, which causes objects to appear bluer and greener.

Advanced Image Stabilization

The image stabilizer reduces camcorder blur (blur due to the camcorder moving) so you can get nice, stable shots. Select the image stabilization mode according to the shooting conditions.

Operating modes:    |  

 [FUNC.]  [Image Stabilizer]  Desired IS mode  [X]

Options (♦ Default value)

[ **Dynamic**][♦] (Compensates for a higher degree of camcorder shake, such as when shooting while walking, and is more effective as the zoom approaches full wide angle.)







[ Standard] Compensates for a lower degree of camcorder shake, such as when shooting while remaining stationary, and is suitable for shooting natural-looking scenes. Use this setting when recording movies with the optional Wide-converter or Tele-converter.

[ Off] Use this setting when the camcorder is mounted on a tripod.

Powered IS



You can use Powered IS to make the image stabilization even more powerful. Powered IS is most effective when you are stationary and zooming in on far subjects using high zoom ratios (the more you approach the telephoto end). Holding the LCD panel with your left hand will add to the stability of the shot.

Press and hold **POWERED IS** as long as you want to activate Powered IS.

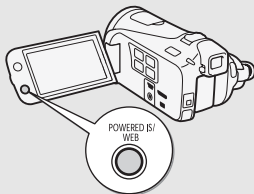
-  appears in yellow, while Powered IS is activated. The degree of camcorder shake will be indicated by the icon itself ( - ) , but you can turn off this indication with the  [Camcorder Shake Indicator] setting.
- You can change the operation of the **POWERED IS** button (long press or toggle on/off) with the   [POWERED IS Button] setting.



NOTES





- If the degree of camcorder shake is too high, the image stabilizer may not be able to fully compensate.
- For surveying and following shots, when you pan the camcorder from side to side or tilt it up and down, we recommend setting the IS mode to [ Dynamic] or [ Standard].

Pre-Recording

The camcorder will start recording 3 seconds before you press **[START/STOP]**, ensuring you do not miss important shooting opportunities. This is especially useful when it is difficult to predict when to start recording.

Operating modes: **AUTO** **M** **CINEMA** |  

1 Activate the pre-recording function.

 **[FUNC.]**  **[Pre REC]**  **[ON On]**  **[X]**

-  will appear on the screen.
- Repeat, selecting **[OFF Off]**, to turn off pre-recording.

2 Press **[START/STOP]**.

The scene recorded in the memory will start 3 seconds before **[START/STOP]** was pressed.

NOTES

- The camcorder will not record the full 3 seconds prior to pressing **[START/STOP]** if the button was pressed within 3 seconds of having turned on pre-recording or having finished the previous recording.
- Any of the following actions will deactivate the pre-recording function.
 - Leaving the camcorder without any operation for 5 minutes.
 - Changing the position of the mode switch.
 - Pressing  or **VIDEO SNAP**.
 - Opening the decoration screen.
 - Closing the LCD panel to set the camcorder to standby mode.
 - Touching any of the following control buttons in the FUNC. panel: **[MENU]**, **[Rec. Programs]**, **[White Balance]**, **[AGC Limit]**, **[Image Stabilizer]**, **[Faders]** or **[Review Recording]**.





Face Detection

The camcorder automatically detects people's faces and uses this information to select the optimal settings for beautiful videos and photos.

Operating modes: **AUTO*** **M** CINEMA |  

* Face detection is always activated in **AUTO** mode.

POINTS TO CHECK

- Select a recording program other than [ Night Scene], [ Low Light], [ Fireworks] or [ Underwater].

By default, face detection is activated. If the function was turned off, perform the following procedure to turn it on.

 [FUNC.] ➤ [MENU] ➤  ➤ [Face Detection & Tracking]
➤ [ON] On [] ➤ []

To select the main subject

If there is more than one person in the picture, the camcorder will automatically select one person it determines is the main subject. The main subject is indicated by a white face detection frame and the camcorder will optimize the settings for that person. Other faces will have gray frames.

Touch a different face on the touch screen to optimize the camcorder's settings for that person using the Touch & Track function.

Main subject



NOTES

- The camcorder may mistakenly detect the faces of non-human subjects. In such case, turn face detection off.
- In certain cases, faces may not be detected correctly. Typical examples include:

- Faces extremely small, large, dark or bright in relation to the overall picture.
- Faces turned to the side, at a diagonal or partially hidden.
- Face detection cannot be used when the shutter speed used is slower than 1/30 (1/24 if the frame rate is set to [PF24 PF24]) or when the digital zoom is activated at more than 40x zoom (dark blue area on the zoom bar).
- When face detection is activated, the slowest shutter speed used by the camcorder is 1/30 (1/24 if the frame rate is set to [PF24 PF24]).

Touch & Track

When recording a group of people using face detection, the camcorder will automatically detect one person as the main subject. You can use Touch & Track to tell the camcorder to track and optimize settings for a different person. You can also use Touch & Track to always keep in focus other moving subjects, such as pets or moving vehicles.

Operating modes:    |  

1 Make sure face detection is activated (📖 93).

Face detection is always activated in  mode.

2 Point the camcorder at a moving subject and touch the subject on the touch screen.

- A white double frame will appear around the subject and track it as it moves.
- Touch [Cancel 

NOTES

- Touching somewhere with a color or pattern unique to the subject will make it easier to track. However, if there is another subject in the vicinity that shares similar characteristics to the selected subject, the camcorder may start tracking the incorrect subject. Touch the screen again to select the desired subject.
- In certain cases, Touch & Track may not be able to track the subject. Typical examples include:
 - Subjects extremely small or large in relation to the overall picture.
 - Subjects too similar to the background.
 - Subjects lacking sufficient contrast.

- Fast moving subjects.
- When shooting indoors with insufficient lighting.

Faders

The camcorder offers two professional looking transition effects to fade-in or fade-out scenes. You have the option to activate the fader only one time or every time you start or stop recording.



Operating modes:    |  

 [FUNC.] ➤  Faders ➤ Desired fader* ➤ 



* You can preview the transition effect on the screen.

- The icon of the selected fader appears in green.

To fade in/out

Press  in record pause mode (●||) to start recording with a fade in. Press  while recording (●) to fade out and pause the recording.

NOTES

- When you apply a fader, not only the picture but also the sound will fade in or out.
- Faders cannot be used in the following cases:
 - While using the [Old Movies] cinema-look filter in  mode.
 - When recording scenes with decorations.
 - When recording video snapshot scenes.
 - While pre-recording is activated.
- You can select whether to fade to/from a black screen or a white screen with the  ➤ [Fader Setting] setting.

Manually Setting the Shutter Speed or Aperture

[P Programmed AE] is the default automatic exposure (AE) recording program; using it, you can change functions like the white balance or image effects. Select one of the other AE recording programs to control the shutter speed or aperture.

Operating modes:    |  

 [FUNC.] ➤ [Rec. Programs] ➤ [TV Shutter-Pri. AE] or [Av Aperture-Pri. AE] ➤ [◀] or [▶]* to set the desired shutter speed (TV) or aperture value (Av) ➤ [X]

* You can also drag your finger along the dial.

Options (♦ Default value)

[P Programmed AE]♦ The camcorder automatically adjusts the aperture and shutter speed to obtain the optimal exposure for the subject.

[TV Shutter-Pri. AE] Set the shutter speed value. The camcorder automatically sets the appropriate aperture value.

[Av Aperture-Pri. AE] Set the aperture value. The camcorder automatically sets the appropriate shutter speed.

NOTES

- [TV Shutter-Pri. AE]:
 - On screen only the denominator is displayed – [TV 250] indicates a shutter speed of 1/250 second, etc.
 - When the frame rate is set to [PF24 PF24], the shutter speeds available will be the following: 1/6, 1/12, 1/24, 1/48, 1/60, 1/100, 1/250, 1/500, 1/1000 and 1/2000.
 - When recording in dark surroundings, you can obtain a brighter picture by using slow shutter speeds; however, image quality may not be as good and autofocus may not work well.
 - The image may flicker when recording with fast shutter speeds.
 - **Recording movies under fluorescent lights:** If the screen starts to flicker, select [TV Shutter-Pri. AE] and set the shutter speed to 1/100.

- [Av Aperture-Pri. AE]: The actual range of values available for selection will vary depending on the initial zoom position.
- When setting a numeric value (aperture or shutter speed), the number displayed will flash if the aperture value or shutter speed is not appropriate for the recording conditions. In such case, select a different value.
- During exposure lock, the aperture value/shutter speed cannot be changed. Set the aperture value or shutter speed before manually adjusting the exposure.

Shutter Speed and Aperture Value Guidelines



▶ With slower shutter speed you can add a nice motion blur and sense of movement.

With faster shutter speeds you can “freeze the action” for powerful images of moving subjects.

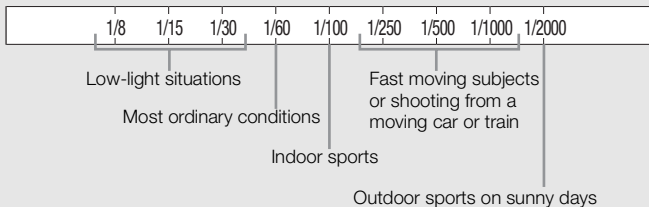

▶ With small aperture values only the subject is in focus and the background is softly blurred. Great for portraits or to isolate a single object.

With large aperture values every part of the image is clearly in focus. Good for landscapes and architectural shots.

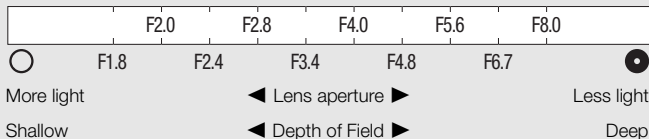

Manual Exposure Adjustment

At times, backlit subjects may appear too dark (underexposed) or subjects under very strong lights may appear too bright or glaring (overexposed). To correct this, you can adjust the exposure manually or use the Touch AE function to automatically set the optimal exposure for the subject you select. This is convenient when the brightness of the subject you want to shoot is noticeably brighter/darker than the general brightness of the image.

Operating modes:    |  

POINTS TO CHECK

- Select a recording program other than [ Fireworks].

1 Open the exposure adjustment screen.

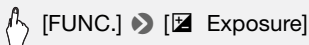

2 Touch a subject that appears inside the frame.

- The Touch AE mark () will flash and the exposure will be adjusted automatically so the area you touched will be correctly exposed. You have the option to further adjust the exposure manually as necessary.
- You can touch [**M**] instead to adjust the exposure manually without activating the Touch AE function.
- The manual adjustment dial appears and the adjustment value is set at ± 0 .
- Touch [**M**] again to return the camcorder to automatic exposure.



3 Touch [] or [] or drag your finger along the dial to set the exposure adjustment value.

The adjustment range may vary depending on the initial brightness of the image, and some values may be grayed out.

4 Touch [] to lock the exposure at the selected value.

During exposure lock,  and the selected exposure adjustment value will appear on the screen.

NOTES





- If the recording program is changed during exposure lock, the camcorder will return to automatic exposure.
- When shooting subjects with a strong light source behind them, the camcorder automatically corrects for the backlight*. You can turn off the automatic backlight correction with the   [Auto Backlight Correction] setting.

* Except in  mode when using a cinema-look filter other than [Cinema Standard].

Automatic Gain Control (AGC) Limit

When recording in dark surroundings, the camcorder will automatically increase the gain to try to get a brighter picture. However, using higher gain values may result in more noticeable video noise. You can select the AGC limit to curb the amount of noise by setting the maximum gain value to be used. The smaller the AGC limit, the picture will be darker but will have less the noise.

Operating modes:    |  

 [FUNC.]  [AGC AGC Limit]  [M Manual]* 
[◀] or [▶]** to set the AGC limit  [X]

* Touch [A Automatic] to remove the limit for the automatic gain control.

**You can also drag your finger along the dial.

- The selected AGC limit will appear on the screen.

Manual Focus Adjustment

Autofocus may not work well on the following subjects. In such case, focus manually.

- Reflective surfaces
- Subjects with low contrast or without vertical lines
- Fast moving subjects
- Through wet windows
- Night scenes

Operating modes: **AUTO** **M** **CINEMA** |  

POINTS TO CHECK

- Adjust the zoom before you start the procedure.



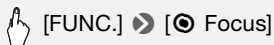

1 Open the manual focus screen.



2 Touch a subject that appears inside the frame.

- The Touch AF mark () will flash and the focusing distance will be adjusted automatically. You have the option to further adjust the focus manually as necessary.
- You can touch **[MF]** instead to adjust the focus manually without activating the Touch AF function.
- The manual focus controls and an estimate of the current focusing distance appear.
- Touch **[MF]** again to return the camcorder to autofocus.

3 Touch and hold or to adjust the focus.

- The center of the screen will be magnified to help you focus more easily. You can also turn off this function with the   [Focus Assistance] setting.
- The focusing distance displayed will change as you adjust the focus. You can change the units used for the distance display with the   [Distance Units] setting.
- If you wish to focus on faraway subjects such as mountains or fireworks, touch and hold  until the focusing distance changes to ∞ .

4 Touch to lock the focus at the selected distance.

During manual focus, **[MF]** will appear on the screen.

Tele Macro

Using tele macro, the camcorder can focus at a shorter distance (up to 40 cm (1.3 ft.) from the subject at full telephoto), allowing you get closer shots of small subjects like flowers and insects. This function also adds a soft focus to the background, so the subject not only looks larger but it also stands out more.

Operating modes: **AUTO*** **M** **CINEMA** |  



* In **AUTO** mode, tele macro will be activated automatically when you zoom in to full telephoto and bring the camcorder up close to the subject.



POINTS TO CHECK

- Select a recording program other than [: Fireworks].





[FUNC.] ➤ [ZOOM] ➤ []* (tele macro) ➤ []

* Touch again to turn off the tele macro function.

- The camcorder will automatically adjust the zoom to the telephoto end.



NOTES

- Any of the following actions will deactivate the tele macro function.
 - Turning off the camcorder.
 - Pressing .
 - Setting the camcorder to **AUTO** mode.
 - Zooming out toward **W** (wide angle).
 - Changing the recording program to [: Fireworks].
- Tele macro cannot be turned on/off while recording.

White Balance

The white balance function helps you to accurately reproduce colors under different lighting conditions so that white objects will always look truly white in your recordings.

Operating modes: **AUTO** **M** **CINEMA** |  

POINTS TO CHECK

- Select a recording program other than the Special Scene recording programs.

 [FUNC.] ➤ [WB White Balance] ➤ Desired option* ➤ [X]









* When you select [ Custom WB], set the custom white balance with the following procedure before touching [X].

To set the custom white balance

Point the camcorder at a white object, so it fills the whole screen, and touch [Set WB].

When the adjustment is completed,  stops flashing and disappears. The camcorder will retain the custom white balance even if you turn it off.

Options (Default value)

- [ **Automatic**] The camcorder automatically sets the white balance for natural looking colors.
- [ **Daylight**] To record outdoors on a bright day.
- [ **Shade**] To record in shaded places.
- [ **Cloudy**] To record on a cloudy day.
- [ **Fluorescent**] To record under warm white, cool white or warm-white-type (3-wavelength) fluorescent lighting.
- [ **Fluorescent H**] To record under daylight or daylight-type (3-wavelength) fluorescent lighting.
- [ **Tungsten**] To record under tungsten and tungsten-type (3-wavelength) fluorescent lighting.
- [ **Custom WB**] Use the custom white balance setting to make white subjects appear white under colored lighting.

NOTES







- **When you select the custom white balance:**
 - Set   [Digital Zoom] to  Off].
 - Reset the white balance when you change locations or the lighting or other conditions change.
 - Depending on the light source,  may keep flashing. The result will still be better than with [AWB Automatic].
- Custom white balance may provide better results in the following cases:
 - Changing lighting conditions
 - Close-ups
 - Subjects in a single color (sky, sea or forest)
 - Under mercury lamps and certain types of fluorescent lights
- Depending on the type of fluorescent light, optimal color balance may not be obtained with  Fluorescent] or  Fluorescent H]. If the color looks unnatural, select [AWB Automatic] or  Custom WB].

Image Effects

You can adjust the color depth, brightness, contrast, and sharpness of the image.



Operating modes:    |  

POINTS TO CHECK

- Select a recording program other than the Special Scene recording programs.

1 Open the image effects screen.

 [FUNC.]  [Image Effects]

- 2 Touch [ON] and then touch [Color Depth], [Sharpness], [Contrast] or [Brightness].
Repeat, selecting [OFF], to turn off the image effects.
- 3 Touch  or  or drag your finger along the dial to adjust the effect level.

- + levels: richer colors, sharper image, stronger contrast, brighter image.
- levels: shallower colors, softer image, softer contrast, darker image.

- 4 Touch **[X]** to save and apply the customized picture settings.
A_c will appear on the screen.

Self Timer

Operating modes: **AUTO** **M** **CINEMA** |  

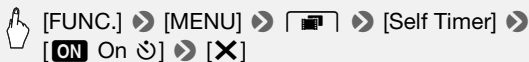

-  will appear on the screen.
- Repeat, selecting **[OFF Off]**, to turn off the self timer.

Movies: In record pause mode, press **START/STOP**.

The camcorder starts recording after a 10-second countdown*. The countdown appears on the screen.

Photos: In record pause mode, touch **[PHOTO]**.

The camcorder will record the photo after a 10-second countdown*. The countdown appears on the screen.

* 2 seconds when using the wireless controller.

NOTES



- Once the countdown has begun, any of the following actions will cancel the self timer.
 - Pressing **START/STOP**, when recording movies.
 - Pressing **PHOTO** (on the wireless controller) or touching **[PHOTO]** (on the screen), when recording photos.
 - Turning off the camcorder.
 - Changing the camcorder's operating mode.
 - Closing the LCD panel to set the camcorder to standby mode.

Audio Recording Level

You can adjust the audio recording level of the built-in or an external microphone. You can display the audio level indicator while recording.

Operating modes: **AUTO** **M** CINEMA |  

POINTS TO CHECK

- Select a recording program other than [ Underwater] or [ Surface].

Manual Adjustment of the Audio Recording Level

1 Open the manual audio recording level adjustment screen.

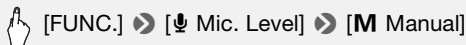

- The audio level indicator and current audio recording level will appear on the screen. When [ Audio Mix] is set to [**ON** On], two audio level indicators will appear, the top one for the built-in microphone, and the bottom one for the external audio.
- Touch [**A** Automatic] to return the camcorder to automatic audio recording levels.

External audio

Using audio mix (📖 108)



Built-in microphone

Manual audio level adjustment



Audio level indicator

Current audio level

Audio level adjustment bar

2 Touch and hold [] or [] to adjust the audio recording level as necessary.

As a guideline, adjust the audio recording level so that the audio level meter will go to the right of the -12 dB mark (yellow area) only occasionally.

3 Touch [**X**] to lock the audio recording level at the current level.

To display the audio level indicator

Usually, the audio level indicator will be displayed only after activating the manual adjustment of the audio recording level. You can choose to display it also when the audio level is adjusted automatically.

 [FUNC.] ➤ [🎤 Mic. Level] ➤ [A Automatic] ➤
[Audio Level Indicator] ➤ [X]

NOTES

- When the audio level meter reaches the red point (0 dB), the sound may be distorted.
- If the audio level is too high and the sound gets distorted, activate the microphone attenuator with the  ➤ [Microphone Attenuator] setting (or [Surround Mic Attenuator] when the optional SM-V1 Surround Microphone is attached to the camcorder).
- We recommend using headphones to check the sound level while adjusting the audio recording level or when the microphone attenuator is activated.

Built-In Microphone Directionality



You can change the directionality of the built-in microphone to have more control over how sound is recorded.

Operating modes:    |  

 [FUNC.] ➤ [MENU] ➤  ➤ [Built-in Mic Directionality]
➤ Desired option ➤ [X]

Options Default value)



 **Monaural** Mono recording that emphasizes sound coming from the front of the camcorder/microphone.

 **Normal**  Standard stereo recording; a middle point between the [Wide] and [Monaural] settings in reach.

[2ch WIDE] Wide Stereo recording of ambient sound over a more extensive area that adds to the sense of presence of movies.

[2ch ZOOM] Zoom Stereo recording with the sound linked to the zoom position. The larger the subject appears on the screen, the louder the sound will be.

NOTES

- Except when using the audio mix function, an external microphone overrides the built-in microphone. In the following cases, the built-in microphone's directionality cannot be changed.
 - When an external microphone is attached to the mini advanced shoe.
 - When an external microphone is connected to the MIC terminal with   [Audio Mix] set to **[OFF Off]**.

Audio Equalizer

You can use the audio equalizer to adjust sound levels by specifically targeting the high- or low-frequency range and selecting one of 3 available levels. The audio equalizer settings are only available when recording sound using the built-in microphone.

Operating modes: **AUTO** **M** **CINEMA** |  



[FUNC.]  [MENU]    [Built-in Mic Freq. Response]  Desired option  **[X]**

Options [♦] (Default value)

[NORM Normal]♦ Appropriate for balanced sound under most normal recording conditions.

[LB Boost LF Range] Accentuates the low-frequency range for more powerful sound.

[LC Low Cut Filter] Filters the low-frequency range to reduce the noise of blowing wind, a car's engine and similar ambient sounds.

[MB Boost MF Range] Best for recording human voices and dialog.

[LH3 Boost HF+LF Range] Best, for example, for recording live music and clearly capture the special sound characteristics of a variety of instruments.

Audio Mix

When recording, you can mix audio from the built-in microphone with external audio from the MIC terminal and adjust the mix balance for original sound effects. The external audio input can be from the optional WM-V1 Wireless Microphone, a commercially available external microphone or from an external audio player (analog Line In).

Operating modes:    |  

- 1 Connect the external source to the MIC terminal.
- 2 Select the type of audio input.

 [FUNC.] ➤ [MENU] ➤  ➤ [MIC Terminal Input] ➤
[LINE External Audio] or [MIC Microphone] ➤ [↶]

- This step is not necessary after connecting an optional WM-V1 wireless microphone.

- 3 Activate the audio mix.

 [Audio Mix] ➤ [ON On]

- 4 Adjust the audio mix balance as necessary.

Touch [INT] (more of the sound from the built-in microphone) or [EXT] (more of the sound from the external audio) or drag your finger along the audio mix bar to adjust the mix balance as desired.

- 5 Touch [X] to set the audio mix and close the menu.

Using Headphones

Use headphones for playback or to check the audio level while recording. The headphones are connected to the AV OUT/🎧 terminal, which is used for both the headphones and the audio/video output. Before connecting the headphones, follow the procedure below to change the function of the terminal from AV output to 🎧 (headphones) output.

Operating modes: **AUTO*** **M** **CINEMA** | 📺 📽

* Headphones can be used also in **AUTO** mode but the function of the terminal cannot be changed in this mode. Change the setting in advance in one of the other operating modes.

1 Change the function of the terminal to headphones output.

👆 [FUNC.]* ➤ [MENU] ➤ ⏪ ➤ [AV/Headphones] ➤
[Headphones] ➤ [↩]

* Only when performing the procedure in a recording mode.

2 Connect the headphones to the AV OUT/🎧 terminal.

3 Adjust the volume as necessary.

👆 [Volume] ➤ [🎧] or [🎧🔊]** to adjust the volume ➤ [X]

**You can also drag your finger along the [Headphones] bar.

- 🎧 will appear on the screen.

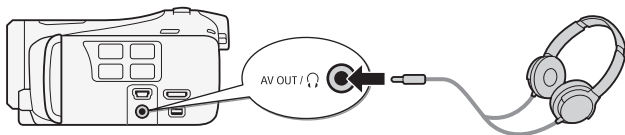

To adjust the volume during playback

In 📺 mode, and in 📽 mode during slideshow playback, adjust the headphones volume the same way you adjust the speaker's volume (📖 57).

! IMPORTANT

- When using headphones, make sure to lower the volume to an appropriate level.
- Do not connect the headphones to the AV OUT/🎧 terminal if the 🎧 icon does not appear on the screen. The noise output in such case may be harmful to your hearing.

i NOTES

- Use commercially available headphones with a \varnothing 3.5 mm minijack.
- Even if [AV/Headphones] was set to [🎧 Headphones] in a playback mode, the function of the AV OUT/🎧 terminal will return automatically to AV output when you turn off the camcorder.

Using the Mini Advanced Shoe

Using the mini advanced shoe, you can attach to the camcorder a range of optional accessories to expand its functionality. For details about optional accessories available for use with your camcorder, refer to *Accessories* (📖 186). For details about how to attach and use the accessories, refer also to the instruction manual of the accessory used.

1 Open the mini advanced shoe cover.

2 Attach the optional accessory to the mini advanced shoe.

When a compatible accessory is attached to the mini advanced shoe, “🎧” will appear on the screen.

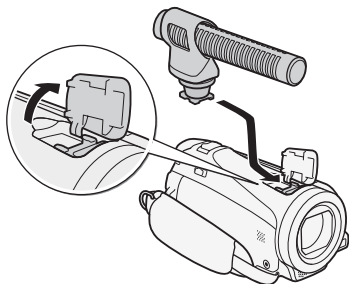

Example: Attaching an optional DM-100 Directional Stereo Microphone.

NOTES

- Accessories designed for the Advanced Accessory Shoe cannot be used with this camcorder. Look for video accessories bearing this logo to ensure compatibility with the **mini advanced shoe**.



Using an External Microphone

When recording in very quiet surroundings, the built-in microphone may pick up the sound of the camcorder's internal machinery. In such case, we recommend using an external microphone.

Operating modes: **AUTO** **M** **CINEMA** |  

Using the SM-V1 Surround Microphone or DM-100 Directional Stereo Microphone

Using the SM-V1 you can add a sense of depth and presence to your recordings with 5.1ch surround sound. Using the DM-100 you can accurately record audio coming directly from the direction you are recording.

Attach the optional SM-V1 Surround Microphone or DM-100 Directional Stereo Microphone to the mini advanced shoe.

Refer to *Using the Mini Advanced Shoe* (📖 110).

“S” will appear on the screen.
For details about using the optional external microphone, refer to the instruction manual of the accessory used.

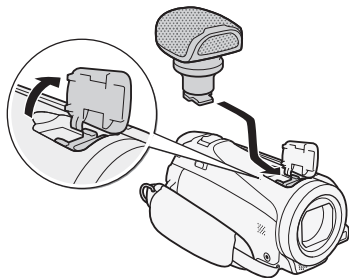

Using the WM-V1 Wireless Microphone

Using the WM-V1 you can reliably record sound even when recording subjects at a distance exceeding the practical range of the built-in microphone. You can also mix and record audio from the WM-V1 with audio from the built-in microphone.

- 1 Attach the receiver to the camcorder's grip belt.
- 2 Connect the receiver to the camcorder's MIC terminal.

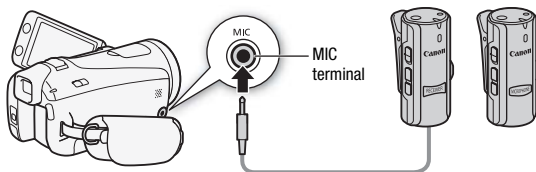

- 3 If necessary, activate the audio mix function (📖 108) and adjust the audio mix balance.
- 4 Attach the microphone (transmitter) to the subject.
For details about using the WM-V1, refer to the instruction manual supplied with the microphone.

Using Commercially Available Microphones

You can also use commercially available condenser microphones with their own power supply. You can connect almost any stereo microphone with a \varnothing 3.5 mm plug but audio recording levels may vary.

- 1 Connect the external microphone to the MIC terminal.
- 2 Change the audio input to external microphone.

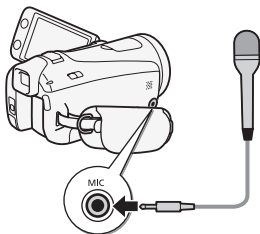

 [FUNC.] ➤ [MENU] ➤  ➤ [MIC Terminal Input] ➤
[Microphone] ➤ [X]

- If necessary, activate and adjust the audio mix balance with the  ➤ [Audio Mix] setting.



NOTES

- When an external microphone is connected to the camcorder,  ➤ [Wind Screen] will automatically be set to [OFF Off ].
- If the audio level is too high and the sound gets distorted, adjust the audio recording level manually ( 105) or activate the microphone attenuator with the  ➤ [Microphone Attenuator] setting.
- **When using the optional SM-V1 Surround Microphone:**
 - Change the microphone's directionality mode with the  ➤ [Surround Mic Directionality] setting.
 - If the sound gets distorted, activate the microphone attenuator with the  ➤ [Surround Mic Attenuator] setting.
 - You can enjoy the full effect of recordings made with 5.1ch surround sound on HDTVs compatible with 5.1ch surround sound connected to the camcorder using the supplied HDMI cable. Audio output from the AV OUT/ terminal (including headphone output) will be converted to 2ch stereo. The camcorder's built-in speaker is monaural.

Using an External Video Light

You can use the optional VL-5 Video Light or VFL-2 Video Flash Light when you need to record movies in dark locations.

Attach the optional video light to the mini advanced shoe.

- Refer to *Using the Mini Advanced Shoe* ( 110).
-  will appear on the screen when you turn on the optional video light (ON or AUTO). For details about using the optional video light, refer to the instruction manual of the accessory used.
- The optional VFL-2 Video Flash Light cannot be used as a flash with this camcorder.

Using a Zoom Remote Controller

By attaching the optional RA-V1 Remote Control Adapter to the mini advanced shoe, you can use the optional ZR-2000 or ZR-1000 Zoom Remote Controller. Doing so will allow you to use certain functions while viewing the picture on an external monitor without touching the camcorder. This is particularly useful while the camcorder is mounted on a tripod and you want to ensure maximum stability of a shot.

Operating modes: **AUTO** **M** **CINEMA** |  

Attach the optional RA-V1 Remote Control Adapter to the mini advanced shoe.

Refer to *Using the Mini Advanced Shoe* (📖 110).

„S“ will appear on the screen. For details about using the adapter, refer to the instruction manual of the RA-V1. For details about using the zoom remote controller, refer to the instruction manual of the ZR-2000 or ZR-1000.

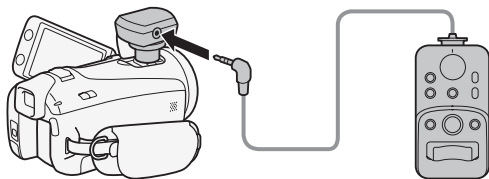

Functions Available with the Zoom Remote Controller

Using the ZR-2000 or ZR-1000: turning the power on/off, starting/stopping a recording, zoom, focus adjustment and displaying on-screen displays on an external monitor.

Using the ZR-2000 only: switching between autofocus and manual focus, Push AF* and focus assistance (MAGNIFYING button).

* The Push AF function allows you to switch to autofocus temporarily during manual focus.

NOTES

- In **AUTO** mode, the only available functions are turning the power on/off, starting/stopping a recording, and zoom.

Selecting the Playback Starting Point

If you have a very long scene, you may want to start playing back the scene from a certain point. You can use the movie timeline to break the scene to segments at fixed time intervals ranging from 6 seconds to 6 minutes.

Operating modes: **AUTO** | **M** | **CINEMA** |  | 

- 1 Open the date index screen.
- 2 Open the scene's [Timeline] screen.

 **[i]**  Desired scene

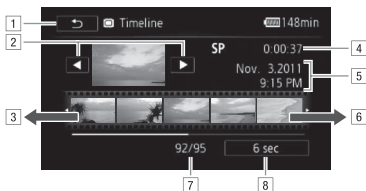

The [Timeline] screen appears. The large thumbnail will show the first frame of the scene. Below it, the timeline ruler shows frames taken from the scene at fixed intervals.

- 3 Touch the desired frame in the timeline ruler to start playing back the scene from that point.



- 1 Touch twice to return to the index screen.
- 2 Previous/next scene.
- 3 Drag your finger left along the ruler to display the next 5 frames.
- 4 Scene's recording mode and length.
- 5 Recording date and time.
- 6 Drag your finger right along the ruler to display the previous 5 frames.
- 7 Current scene / Total number of scenes.
- 8 Currently selected interval between frames.

To change the interval between frames

 [6 sec] ➤ Desired interval ➤ [

Onscreen Displays and Data Code

You can turn most onscreen displays on or off.

Operating modes:    |  

Repeatedly press  to turn the onscreen displays on/off in the following sequence:

,  mode:

- All displays on
- Most displays off¹

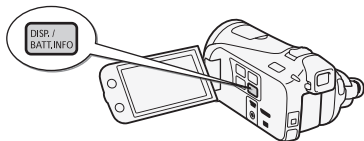

,  mode²:



- Only data code on
- All displays on

¹ Pressing  will turn off most of the icons and displays that appear automatically but will not remove control buttons ([FUNC.], [PHOTO], etc.) and onscreen displays that were turned on manually (for example, onscreen markers or the audio level meter).

² Touch the screen to display the playback controls.

About the Data Code

With every scene or photo recorded, the camcorder keeps a data code (date/time of recording, information about the camera setup, etc.).

You can select the information to be displayed with the  /   [Data Code] setting.

Capturing Photos and Video Snapshot Scenes from a Movie



You can capture video snapshot scenes, single photos or a series of continuous photos from a previously recorded scene. For example, you may want to print photos from video recorded at a party or create a small video clip using video snapshot scenes from the highlights of an event.

Operating modes:    |  

Capturing a Video Snapshot Scene

1 Play back the scene or story from which you want to capture the video snapshot scene.

2 Press  to capture the video snapshot scene.

The camcorder captures the video snapshot scene for about 4 seconds (the blue frame serves as a visual progress bar), and then enters playback pause mode. You can change the length of the video snapshot scenes you capture to 2 or 8 seconds with the   [Video Snapshot Length] setting.

3 Touch  to stop the playback.

NOTES

- A video snapshot scene can be captured only during playback; it cannot be captured during playback pause mode.
- The captured video snapshot scene is saved to the same memory that contains the source scene.
- Video snapshot scenes cannot be captured from any of the following types of scenes.
 - Scenes shorter than 1 second
 - Scenes that were edited using the supplied software **VideoBrowser** and were then transferred back to the camcorder.
- When the source scene is itself a video snapshot scene, you may not be able to capture a video snapshot scene depending on the length of the source scene and the length currently selected for video snapshot scenes.
- When you start capturing a video snapshot scene less than 1 second from the end of the scene, the video snapshot scene will be captured starting from the beginning of the following scene.

- During the playback of video snapshot scenes captured from a previously recorded movie, you may notice some anomalies in the picture/sound at the point where the playback switches to a new scene.

Capturing Photos

You can capture a single photo or a series of photos. The size of the captured photos will be 1920x1080 and it cannot be changed. Please read the **IMPORTANT** section before using an Eye-Fi card.

To select the photo capture settings

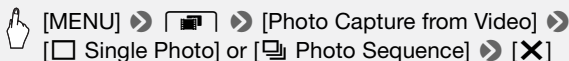

To capture the photos

- 1 Play back the scene or story from which you want to capture the photo.
- 2 Pause the playback at the point you want to capture.
- 3 Touch [PHOTO].
To capture a photo sequence, keep touching [PHOTO]. The scene will be played back frame-by-frame and each frame captured as a separate photo.
- 4 Touch [■] to stop the playback.

! IMPORTANT

- When capturing photos on an Eye-Fi card in memory card slot **B**, photos will be uploaded automatically if you are within the range of a configured network. Always verify that Eye-Fi cards have been approved in the country/region of use. See also *Using an Eye-Fi card* (📖 144).

i NOTES

- The data code of the photos will reflect the date and time of recording of the original scene.
- Photos captured from a scene with a lot of fast movement may be blurred.
- Photos will be recorded on the memory selected for recording photos.

- [📷 Photo Sequence]:
 - Up to 100 photos can be captured at a time.
 - The photo sequence capture will stop when the end of the scene is reached (playback will pause at the beginning of the following scene).
 - Photos will be captured at intervals of 1/30 second (1/24 second, if the scene was recorded at a frame rate of [PF24 PF24]).

Dividing Scenes

You can divide scenes in order to leave out the best parts and later cut out the rest.

Operating modes: [AUTO] [M] [CINEMA] | [📺] [📷]

- 1 **Play back the scene you want to divide.**
- 2 **Pause the playback at the point where you want to divide the scene.**
- 3 **Open the scene division screen.**

 [Edit] ➤ [Divide]

- 4 **Bring the scene to a precise point, if necessary.**

Playback controls will appear on the screen (📖 57). Use any special playback modes (fast playback, frame reverse/advance) as necessary to locate the desired point.

- 5 **Divide the scene.**

 [~~⏪~~ Divide] ➤ [Yes]

- The video from the division point to the end of the scene will appear as a new scene in the index screen.

NOTES

- When advancing/reversing frames while dividing the scenes, the interval between frames is about 0.5 seconds.

- If the scene cannot be divided at the point where you paused the playback, advance/reverse a frame and then divide the scene.
- During the playback of a scene that was divided, you may notice some anomalies in the picture/sound at the point where the scene was cut.
- The following scenes cannot be divided:
 - Video snapshot scenes and other scenes that are too short (less than 3 seconds).
 - Scenes that were edited using the supplied software **VideoBrowser** and were then transferred back to the camcorder.
- Scenes cannot be divided within 1 second from the beginning or the end of the scene.



Photos

Refer to this chapter for details on viewing photos and other photo-related operations.

Viewing Photos

Operating modes: **AUTO** **M** **CINEMA** |  

1 Press .

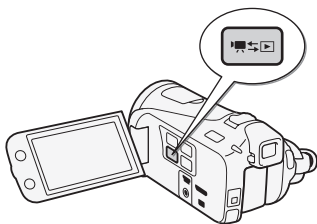

2 Open the [Photos] index screen, if it is not displayed.



3 Look for the photo you want to play back.

Move the zoom lever toward **W** to show 15 photos per page; move it toward **T** to show 6 photos per page.



- 1 Memory being read.
- 2 Drag your finger left for the next index page.*
- 3 Drag your finger right for the previous index page*.
- 4 Open the index selection screen (📖 59).
- 5 Division line between recording dates.

* While browsing through index pages, a scroll bar will appear at the bottom of the screen for a few seconds. When you have a large number of photos it may be more convenient to drag your finger along the scroll bar.

4 Touch the photo you wish to view.

- The photo is displayed in single photo view.
- Drag your finger left/right to browse through the photos one by one.

To return to the index screen from single photo view

- 1 Touch the screen to display the playback controls.
- 2 Touch [📺].

Photo Jump Function

When you have recorded a large number of photos, you can jump easily through the photos using the scroll bar.

- 1 Touch the screen to display the playback controls.
- 2 Jump through the photos using the scroll bar.

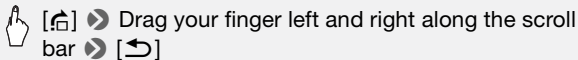

IMPORTANT

- Observe the following precautions while the ACCESS indicator is on or flashing. Failing to do so may result in permanent data loss.
 - Do not open the double memory card slot cover.
 - Do not disconnect the power source or turn off the camcorder.
 - Do not change the camcorder's operating mode.
- The following image files may not be displayed correctly.
 - Images not recorded with this camcorder.
 - Images edited on a computer.
 - Images whose file names have been changed.



Deleting Photos

You can delete those photos that you are not interested in keeping.

Operating modes:    |  

Deleting a Single Photo

- 1 In single photo view, select the photo you want to delete.
- 2 Touch the screen to display the playback controls.
- 3 Delete the photo.

 [Edit] ➤ [Delete] ➤  Proceed] ➤ [Yes]

- 4 Drag your finger left/right to select another photo to delete or touch .

Deleting Photos from the Index Screen

- 1 Open the [Photos] index screen.

   ➤ [Photos]

2 Delete the photos.



[Edit] ➤ [Delete] ➤ Desired option* ➤ [Yes]** ➤ [OK]

* When you select [Select], perform the following procedure to select the individual photos you want to delete before touching [Yes].

** Touch [Stop] to interrupt the operation while it is in progress. Some photos will be deleted nevertheless.

To select individual photos

1 Touch on the individual photos you want to delete.

- A checkmark ✓ will appear on the photos you touch. The total number of selected photos will appear next to the icon.
- Touch a selected photo to remove the checkmark. To remove all checkmarks at once, touch [Remove All] ➤ [Yes].

2 After selecting all the desired photos, touch [OK].

Options

[Select] Select individual photos to delete.

[All Photos] Delete all the photos.



IMPORTANT

- Be careful when deleting photos. Deleted photos cannot be recovered.
- Photos that were protected with other devices cannot be deleted with this camcorder.

Slideshow

You can play a slideshow of all the photos and even set it to music.

Operating modes: **AUTO** **M** CINEMA |  

1 Open the [Photos] index screen.



[⏪] [⏩] ➤ [Photos]

- 2 Select the background music to use during the photo slideshow.
Music tracks: Step 2 (📖 77). External audio: Steps 2 - 4 (📖 79).

Slideshow set to a music track

- 3 Touch the photo that will open the slideshow to display it in single photo view.
- 4 Touch the screen to display the playback controls, then touch [▶] to play back the slideshow set to the selected music track.

Slideshow not linked to the external audio

- 3 Touch the photo that will open the slideshow to display it in single photo view.
- 4 Touch the screen to display the playback controls, then touch [▶] to start the slideshow.
- 5 Start the music playback on the external player.

Slideshow linked to the external audio

- 3 Start the music playback on the external player.
 - Playback will start from the first photo in the index screen.
 - Photos will be displayed continuously until the music stops. When the external audio input stops, the slideshow will stop as well.

During the photo slideshow

- Touch the screen and drag your finger left and right along the volume bar to adjust the volume.
- Touch the screen and touch [⏏] to stop the slideshow. Hide the playback controls if necessary.

To change the slideshow's transition effects

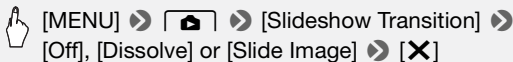



External Connections

This chapter explains how to connect your camcorder to an external device such as a TV, VCR, or computer.

Terminals on the Camcorder

Open the LCD panel to access the terminals on the camcorder.

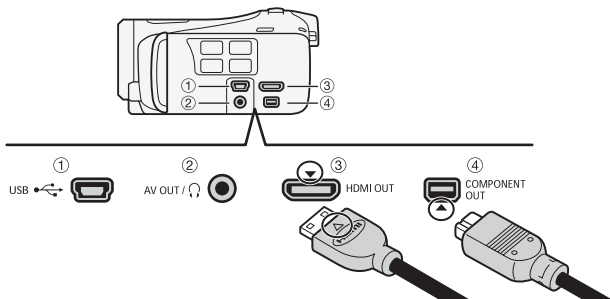

① USB Terminal

② AV OUT / AV IN Terminal

Sound from the built-in speaker will be muted while the STV-250N Stereo Video Cable is connected to the camcorder. Adjust the volume on the connected TV.

③ HDMI OUT Terminal*

The HDMI OUT terminal offers a high-quality digital connection that combines audio and video in a single convenient cable.

④ COMPONENT OUT Terminal*

The component video terminal is for video only. When you use connection ②, do not forget the audio connections using the AV OUT / AV IN terminal.

* When connecting a cable to the camcorder, make sure to align the triangle marks on the cable's connector and on the camcorder's terminal.

Connection Diagrams

In the following connection diagrams, the left side shows the terminals on the camcorder and the right side shows (for reference only) an example of terminals on a connected device.

Connection 1

HDMI

Type: Digital • Quality: High definition • Output only

Connect to a high-definition TV (HDTV) with an HDMI input terminal. If your HDTV supports HDMI-CEC or 1080p input, you can activate these functions with the [Control for HDMI] and [HDMI 1080p Output] settings, respectively. You can check the standard of the current output signal with the [HDMI Status] setting.

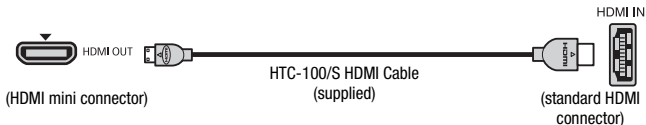

About the HDMI™ connection

The HDMI (High-Definition Multimedia Interface) connection (1) is a convenient all-digital connection using a single cable for both video and audio. When you connect the camcorder to an HDTV equipped with an HDMI terminal, you can enjoy video and audio playback at the highest quality.

- The HDMI OUT terminal on the camcorder is for output only. Do not connect it to an HDMI output terminal on an external device, as this may damage the camcorder.
- While the camcorder is connected to an HDTV using connection 1, there will be no video output from other terminals.
- Correct operation cannot be guaranteed when connecting the camcorder to DVI monitors.
- Depending on the HDTV, correct playback of personal video content may not be possible using connection 1. Try one of the other connections.

Type: Digital data connection

Connect to a computer to save your recordings, or to a compatible digital video recorder to copy your recordings.

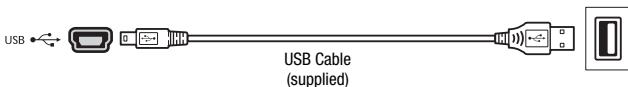
**i** NOTES

- Power the camcorder using the compact power adapter and only then connect it to the computer using the supplied USB cable in the following cases.
 - To write back scenes recorded with this camcorder that were previously saved on a computer.
 - To transfer music files from the supplied Camcorder Supplemental Disc to a memory card in the camcorder in order to use them as background music.

Playback on a TV Screen

Connect the camcorder to a TV to enjoy your recordings with family and friends. Playback on an HDTV using one of the high-definition connections will ensure the best playback quality.

Operating modes: **AUTO** **M** **CINEMA** |  

1 Turn off the camcorder and the TV.

2 Connect the camcorder to the TV.

Refer to *Connection Diagrams* (📖 127) and select the most appropriate connection for your TV.

3 Turn on the connected TV.

On the TV, select as the video input the same terminal to which you connected the camcorder. Refer to the instruction manual of the connected TV.

4 Turn on the camcorder and set it to or mode.

Play back the movies or photos.

NOTES

- To correctly play back movies recorded with x.v.Color (📖 155) on an HDTV compatible with this standard, additional settings may be required on the connected HDTV. Refer to the TV's instruction manual.
- We recommend powering the camcorder using the compact power adapter.
- Connection : When you play back your 16:9 movies on standard TV sets with a 4:3 aspect ratio, the TV set will switch automatically to wide-screen mode if it is compatible with the Video ID-1 system. Otherwise, change the aspect ratio of the TV manually.

Saving and Sharing Your Recordings

Copying Recordings to a Memory Card

You can copy your recordings only one way: from the built-in memory (HFM41/M40 only) or from memory card **A** to memory card **B**. Scenes and photos will be copied from the index screen or from a story in the gallery on the source memory to the same index screen or story on memory card **B**.

Please read the IMPORTANT section (📖 134) before using an Eye-Fi card.



Copying Scenes from the Date Index Screen

Operating modes: **AUTO** **M** **CINEMA** |  

1 Open the date index screen.

- Check that you have selected the  tab (built-in memory, HFM41/M40 only) or **A** tab (memory card **A**).
- To copy all the scenes recorded on a specific date, drag your finger left/right until the desired date appears in the title bar.

2 Copy the scenes.

 [Edit] ➤ [Copy ( ➤ **B**)] (HFM41/M40 only) or
[Copy (**A** ➤ **B**)] ➤ Desired option* ➤ [Yes]** ➤ [OK]

* When you select [Select], perform the following procedure to select the individual scenes you want to copy before touching [Yes].

**Touch [Stop] to interrupt the operation while it is in progress.

To select individual scenes

1 Touch on the individual scenes you want to copy.

- A checkmark ✓ will appear on the scenes you touch. The total number of selected scenes will appear next to the  icon.
- Touch a selected scene to remove the checkmark. To remove all checkmarks at once, touch [Remove All] ➤ [Yes].

2 After selecting all the desired scenes, touch [OK].

3 Copy the photo.

 [Edit] ➤ [Copy (📷 ➔ B)] (HFM41/M40 only) or [Copy (A ➔ B)] ➤ [📷 Proceed] ➤ [Yes]

4 Drag your finger left/right to select another photo to copy or touch [X].

Copying Photos from the Index Screen

Operating modes: **AUTO** | **M** | **CINEMA** |  

1 Open the [Photos] index screen.

Check that you have selected the  tab (built-in memory, HFM41/M40 only) or **A** tab (memory card **A**).

2 Copy the photos.

 [Edit] ➤ [Copy (📷 ➔ B)] (HFM41/M40 only) or [Copy (A ➔ B)] ➤ Desired option* ➤ [Yes]** ➤ [OK]

* When you select [Select], perform the following procedure to select the individual photos you want to copy before touching [Yes].

** Touch [Stop] to interrupt the operation while it is in progress.

To select individual photos

1 Touch on the individual photos you want to copy.

- A checkmark ✓ will appear on the photos you touch. The total number of selected photos will appear next to the  icon.
- Touch a selected photo to remove the checkmark. To remove all checkmarks at once, touch [Remove All] ➤ [Yes].

2 After selecting all the desired photos, touch [OK].

Options

[Select] Select individual photos to copy.

[All Photos] Copy all the photos.

IMPORTANT

- Observe the following precautions while the ACCESS indicator is on or flashing. Failing to do so may result in permanent data loss.
 - Do not open the double memory card slot cover.
 - Do not disconnect the power source or turn off the camcorder.
 - Do not change the camcorder's operating mode.
- When copying photos onto an Eye-Fi card in memory card slot **B**, photos will be uploaded automatically if you are within the range of a configured network. Always verify that Eye-Fi cards have been approved in the country/region of use. See also *Using an Eye-Fi card* ( 144).

NOTES

- In the following cases, you will not be able to copy recordings to the memory card:
 - If the double memory card slot is open.
 - If the LOCK switch on memory card **B** is set to prevent writing.
 - If there is no memory card in memory card slot **B**.
- Scenes that were edited using the supplied software **VideoBrowser** and were then transferred back to the camcorder cannot be copied to the memory card.
- If there is not enough space on memory card **B**, as many photos as possible will be copied before stopping the operation.

Saving Recordings on a Computer

Movies recorded with this camcorder are saved in the built-in memory (**HFM41/M40** only) or on a memory card. Because space is limited, make sure to save your recordings on a computer on a regular basis.

Saving Movies (Windows only)

With the supplied software **Transfer Utility** or **VideoBrowser** you can save to your computer the scenes you have recorded. Additionally, the supplied software **VideoBrowser** offers many options for organizing your video library, editing video, creating discs and more.

Installation

Install the software before you connect the camcorder to the computer for the first time. Refer to the Installation Guide (supplied leaflet) and follow the instructions in the Software Guide (PDF file) to install the supplied PIXELA's software.

Connecting the Camcorder to a Computer

1 Power the camcorder using the compact power adapter.

If the camcorder is connected to the computer while it is powered only by the battery pack, previously saved video files cannot be transferred back to the camcorder and music files cannot be transferred from the supplied Camcorder Supplemental Disc to a memory card in the camcorder.

2 Open the date index screen.



3 Connect the camcorder to the computer using the supplied USB cable.

Connection . Refer to *Connection Diagrams* ( 129).

4 Camcorder: Select [All (for PC only)].

Camcorder: When the connection is successfully established, [USB Connection] appears on the screen.

5 Computer: Depending on the software you chose to install, Transfer Utility or VideoBrowser will start up automatically.

- **Transfer Utility:** Click [Video file import] to start transferring files. For details about using the software, click [Help] to open the Software Guide (PDF file).
- **VideoBrowser:** Click  in the menu panel to start transferring files. For details about using the software, click  to open the Software Guide (PDF file).

Saving Photos (Windows/Mac OS)

With the supplied software **Photo Application** you can save photos to your computer and easily organize and edit them.

Installation

Install the software before you connect the camcorder to the computer for the first time. See also the relevant sections in the 'Photo Application' Instruction Manual ([PHOTO] > , PDF file in the [MANUALS_ENGLISH] folder on the supplied Camcorder Supplemental Disc).

Install the supplied Photo Application software following the instructions in the software's instruction manual.

[PHOTO] > Refer to *Installing Photo Application*.

First-time connection to a computer running Windows

Windows users only: The first time you connect the camcorder to the computer, you also need to select the CameraWindow auto-launch setting.

[PHOTO] > Refer to *Starting CameraWindow*.

Connecting the Camcorder to a Computer

1 Power the camcorder using the compact power adapter.

2 Open the [Photos] index screen.

Select in advance the memory that contains the photos you want to save.

3 Connect the camcorder to the computer using the supplied USB cable.

- Connection [4]. Refer to *Connection Diagrams* (📖 129).
- Camcorder: When the connection is successfully established, [USB Connection] appears on the screen.

4 Save the photos onto the computer.

[PHOTO] > Refer to *Downloading Still Images to the Computer*.

IMPORTANT



• **When the camcorder is connected to a computer:**

- Do not open the double memory card slot cover and do not remove the memory cards.
- Do not access, change or delete any of the camcorder's folders or files directly from the computer as this may result in permanent data

loss. Always use only the supplied PIXELA's software to save your movies on the computer and, if necessary, to transfer back previously saved video files to the camcorder.

- Observe the following precautions while the ACCESS indicator is on or flashing. Failing to do so may result in permanent data loss.
 - Do not open the double memory card slot cover.
 - Do not disconnect the USB cable.
 - Do not turn off the camcorder or the computer.
 - Do not change the camcorder's operating mode.
- When restoring to the camcorder video files that were previously saved to the computer, do not disconnect the USB cable or turn off the camcorder or computer. Doing so may result in scenes that cannot be played back on the camcorder.
- Operation may not work correctly depending on the software and the specifications/settings of your computer.
- If you wish to use the image files on your computer, make copies of them first. Use the copied files, retaining the originals.

NOTES

- Refer also to the computer's instruction manual.
- With the supplied PIXELA's software you can also choose to save complete stories from the gallery. In such case, all the scenes in the story will be merged and saved as a single video file.
- **Users of Windows 7, Windows Vista, Windows XP and Mac OS X:** Your camcorder is equipped with the standard Picture Transfer Protocol (PTP) allowing you to transfer photos (JPEG only) simply by connecting the camcorder to a computer using the supplied USB cable, without having to install the supplied software **Photo Application**.
- If you connect the camcorder to the computer while it is set to  mode, the process of creating scene thumbnails will start automatically. If your intention was to save photos to the computer, you can touch [Skip] to stop the process and use the computer's Safely Remove Hardware function (Windows) or Eject function (Mac OS) to end the connection to the camcorder. Disconnect the USB cable, set the camcorder to  mode and restore the connection.

Copying Recordings to an External Video Recorder



Operating modes:    |  

In High Definition

Connect the camcorder to Blu-ray Disc recorders and other AVCHD-compatible digital video recorders using the supplied USB cable to make perfect copies of your movies in high definition. If the external digital video recorder has an SD memory card slot*, you can use the memory card to copy your movies without connecting the camcorder.

* Make sure the external device is compatible with the type of memory card used.

Connecting

- 1 Power the camcorder using the compact power adapter.
- 2 Open the date index screen or gallery.
- 3 Connect the camcorder to the digital video recorder using the supplied USB cable.
Connection  4. Refer to *Connection Diagrams* ( 129).
- 4 **Camcorder:** Select the memory that contains the scenes you want to copy.
 - Select an option other than [All (for PC only)].
 - Camcorder: When the connection is successfully established, [USB Connection] appears on the screen.

Recording

Details will vary depending on the device used so be sure to refer to the instruction manual of the digital video recorder.



In Standard Definition

You can copy your movies by connecting the camcorder to a VCR or a digital video recorder with analog audio/video inputs. Video output will be in standard definition, although the original scenes are in high definition.

Connecting

Connect the camcorder to the VCR using Connection 3. Refer to *Connection Diagrams* (📖 128).

Recording

- 1 External recorder: Load a blank cassette or disc and set the recorder to record pause mode.**
- 2 Turn on the camcorder and set it to  mode.**
 - We recommend powering the camcorder using the compact power adapter.
 - Verify that   [AV/Headphones] is set to [**AV** AV].
- 3 Camcorder: Locate the scene or story you wish to copy and pause the playback shortly just before the desired scene.**
- 4 Camcorder: Resume playback.**

By default, onscreen displays will be embedded in the output video signal. You can change the displays by repeatedly pressing  (📖 116).
- 5 External recorder: Start recording when the scene you wish to copy appears; stop recording when it ends.**
- 6 Camcorder: Stop playback.**

Uploading Movies to Video Sharing Web Sites

You can convert your high-definition scenes into standard-definition movies in the camcorder and then use the supplied PIXELA's software in order to upload them to your favorite video sharing Web site. You can even decorate scenes so your unique decorations will be embedded in the converted SD movies.

If you are using an Eye-Fi card, you can upload the standard-definition scenes wirelessly, directly from the camcorder. Refer to Eye-Fi's homepage for the latest information on compatible Web sites.



Installation

Install the software before you connect the camcorder to the computer for the first time. Refer to the Installation Guide (supplied leaflet) and

follow the instructions in the Software Guide (PDF file) to install the supplied PIXELA's software.

Converting Scenes into Standard Definition from the Date Index Screen

Operating modes: **AUTO** **M** **CINEMA** |  

- 1 Power the camcorder using the compact power adapter.**
- 2 Make sure there is a memory card in memory card slot **B** with sufficient available space.**
- 3 Open the date index screen.**
 - Check that you have selected the  tab (built-in memory) or **A** tab (memory card **A**).
 - To convert all the scenes recorded on a specific date, drag your finger left/right until the desired date appears in the title bar.
- 4 Press **WEB** to convert all the scenes recorded in the selected date. Alternatively, touch [Edit] ➤ [Convert HD➔SD ( ➔ **B**)] or [Convert HD➔SD (**A** ➔ **B**)] and select one of the options for converting multiple scenes.**
 - You can convert all the scenes recorded on the date shown in the control button, select individual scenes to convert or convert all the scenes.
 - When you select [Select], perform the procedure described below to select the individual scenes you want to convert.
- 5 Review the conversion settings and touch [Next].**
 - If a copyright notice appears, read it carefully and touch [OK] if you agree.
 - Before touching [Next], you can touch  to change the conversion settings as described below.
- 6 Touch [START] to convert the scenes.**

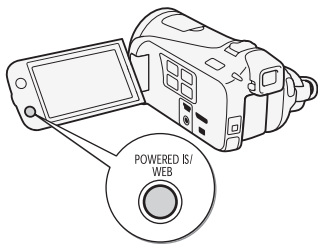

- Before touching [START], you can touch [] to decorate the converted SD movies (69), or touch [] to adjust the volume (57) and background music balance (78).
- You can also decorate the scenes as they are being converted.
- Touch [STOP] to interrupt the operation while it is in progress.

7 When the conversion is completed, a confirmation screen will appear.

Connect the camcorder to the computer at this point (142) to continue uploading the converted videos to the Web or touch [End Without Connecting] to connect to the computer later.

To select individual scenes (step 4)

1 Touch on the individual scenes you want to convert.

- A checkmark ✓ will appear on the scenes you touch. The total number of selected scenes will appear next to the icon.
- Touch a selected scene to remove the checkmark. To remove all checkmarks at once, touch [Remove All] [Yes].

2 After selecting all the desired scenes, touch [OK].

To select the bit rate (step 5)

Using a higher bit rate will result in better video quality for the converted scenes, while a lower bit rate will result in smaller file sizes and faster uploads.

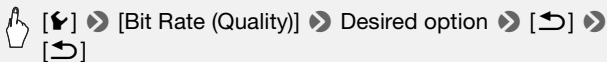

To automatically divide scenes (step 5)

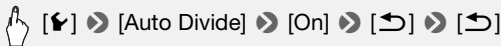

If you are converting a long scene, you can have the camcorder divide it into 10-minute SD movies to make uploading easier.



1 Connect the camcorder to the computer using the supplied USB cable.

Connection  4. Refer to *Connection Diagrams* ( 129).

2 Computer: Depending on the software you chose to install, Transfer Utility or VideoBrowser will start up automatically.

- **Transfer Utility:** Click [Web Upload] to upload your SD movies to the Web. For details about using the software, click [Help] to open the Software Guide (PDF file).
- **VideoBrowser:** Click  in the menu panel to upload your SD movies to the Web. For details about using the software, click  to open the Software Guide (PDF file).

IMPORTANT

- While the camcorder is connected to the computer, do not open the double memory card slot cover and do not remove the memory cards.
- Observe the following precautions while the ACCESS indicator is on or flashing. Failing to do so may result in permanent data loss.
 - Do not open the double memory card slot cover.
 - Do not disconnect the USB cable.
 - Do not disconnect the compact power adapter or turn off the camcorder or the computer.



NOTES

- The time required to convert scenes is approximately equal to the total playback time of the converted scenes. In most cases this is still faster than converting the scenes in the computer so we recommend you convert scenes in the camcorder.
- If after converting the scenes you selected the [End Without Connecting] option, you will need to upload the SD movies manually when you connect the camcorder to the computer. First, open the [SD Movies] index screen on the memory card that contains the converted SD movies and save them to the computer ( 134). Then, use the supplied PIXELA's software to upload the SD movies to the Web.
- You can check and play back the converted SD movies from the [SD Movies] index screen on the memory card used for the conversion.

Converting Scenes into Standard Definition from a Story by Rating

1 Open the gallery and bring the desired story to the front.



- Check that you have selected the  tab (built-in memory) or  tab (memory card **A**).

2 Select the rating of the stories you want to convert.

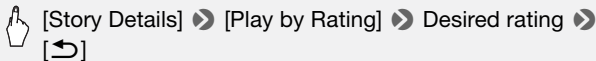

3 Press **WEB** and continue the conversion to standard definition from step 5 in the previous procedure (📖 140).

NOTES

- **When converting scenes from a story:**
 - All the scenes are merged into one converted SD movie.
 - If the converted SD movie is too large, it will be split into smaller 10-minute long movies.
 - The maximum total playback time of the scenes to be converted is 2 hours and 30 minutes.

Converting Only Part of a Scene or Story

1 Play back the scene or story that you want to partially convert.

Check that you have selected a scene recorded in the built-in memory or on memory card **A**.

2 Pause the playback where you want the converted SD movie to begin.

3 Press **WEB** and continue the conversion to standard definition from step 5 in the previous procedure (📖 140).

The video from the playback pause until the end of the scene/story (or up to a maximum of 10 minutes, in case of longer scenes/stories) will be converted to standard definition.







Uploading your Videos Wirelessly

If you are using an Eye-Fi card, you can automatically upload the converted SD movies to your favorite video sharing Web site. You will need to have installed the software supplied with your Eye-Fi card and completed all the required configuration setup in advance. Refer to the instruction manual of the Eye-Fi card.

Please read the **IMPORTANT** section before using an Eye-Fi card.

1 Insert your Eye-Fi card into memory card slot **B and make sure there is sufficient available space on the memory card.**

2 Convert the desired movies (📖 140).



- When the conversion is completed, touch [End Without Connecting].
- If you are within the range of a configured network, Web upload will start automatically.
- The status of the wireless communication is shown by the Eye-Fi icon as follows:
 -  (grayed out) Communication not established
 -  (white, flashing) Connecting;  (white, continuously on) Wireless upload on standby
 -  (animated) Wireless upload in progress
 -  [Eye-Fi Communication] is set to [**OFF** Off]
 -  Wireless upload stopped by the camcorder (📖 170)
 -  Error reading from the Eye-Fi card (📖 168)

IMPORTANT

Using an Eye-Fi Card

- This product is not guaranteed to support Eye-Fi card functions (including wireless transfer). In case of an issue with an Eye-Fi card, please check with the card manufacturer. Also note that an approval is required to use Eye-Fi cards in many countries or regions. Without approval, use of the card is not permitted. If it is unclear whether the card has been approved for use in the area, please check with the card manufacturer.
- Do not use Eye-Fi cards on airplanes and in other places where wireless communication is forbidden. Remove the Eye-Fi card from the camcorder beforehand.

NOTES

- Depending on the amount of data to be uploaded and the network's wireless connection conditions, it can take some time to upload video files. If the wireless connection is too weak, the wireless upload may fail and the video files will be registered as incomplete uploads.
 - **About power saving:**
 - Wireless communication drains the power of the battery pack faster than usual. We recommend powering the camcorder using the compact power adapter.
 - While files are being uploaded wirelessly, the camcorder's automatic power off function will be disabled.
 - Wirelessly uploading files is not possible when the Eye-Fi card is in memory card slot **A** (the Eye-Fi icon will not appear on the screen). Be sure to insert the Eye-Fi card into memory card slot **B**.
 - While using an Eye-Fi Card, the ACCESS indicator may flash from time to time.
 - Wireless communication is available only in playback mode. Any wireless transfer in progress will be stopped if you set the camcorder to recording mode.
 - Wireless communication is not available when the optional WM-V1 Wireless Microphone is attached to the camcorder. Any wireless transfer in progress will be stopped the moment you attach the WM-V1 to the camcorder.
 - You can turn off the wireless communication with the   [Eye-Fi Communication]* setting.
 - If the LOCK switch on the Eye-Fi card is set to prevent writing, you will not be able to turn the wireless communication on/off and the status icon will change to . To use wireless communication make sure the switch on the Eye-Fi card is not in the LOCK position.
- * This menu option will appear only when using an Eye-Fi card.



Additional Information

This chapter contains troubleshooting advice, screen messages, handling and maintenance tips, and other information.

Appendix: Menu Options Lists

Menu items not available appear grayed out. For details about how to select an item, refer to *Using the Menus* (📖 34). For details about each function, see the reference page. Menu options without a reference page are explained after the tables. Underlined menu options indicate default values.

FUNC. Panel

FUNC. Panel - Recording Modes



Control Button	Setting options/Function	AUTO	M	CINEMA	📖
[MENU]	Open the menu	–	●	●	35
[Rec. Programs]	<u>[P] Programmed AE</u> , [Tv Shutter-Pri. AE], [AV Aperture-Pri. AE]	–	●	●	96
	[👤 Portrait], [🏀 Sports], [🌃 Night Scene], [❄️ Snow], [🏖️ Beach], [🌅 Sunset], [💡 Low Light], [🎪 Spotlight], [🎆 Fireworks], [👉 Underwater], [🌊 Surface]	–	●	–	87
[👤 Decoration] ¹	[🖋️ Pens and Stamps], [🎞️ Animated Stamps], [🗣️ Captions] ²	●	●	●	69
	[🎞️] (image mix): Toggle on (I) or off (O), [⏸️] (pause live video)	–	●	–	
	[🔍] (minimize toolbar)	●	●	●	
[WB White Balance]	<u>[AWB Automatic]</u> , [☀️ Daylight], [🌑 Shade], [☁️ Cloudy], [💡 Fluorescent], [💡 Fluorescent H], [🔥 Tungsten], [🎨 Custom WB]	–	●	●	102





Control Button	Setting options/Function	AUTO	M	CINEMA	
[Focus]	[MF] (manual focus): Toggle on (I) or off (O), Touch AF frame	–	●	●	99
[Exposure]	[M] (manual exposure): Toggle on (I) or off (O), Touch AE frame	–	●	●	98
[ZOOM]	Zoom controls, [START]/[STOP] control	●	●	●	52
	[] (tele macro): Toggle on (I) or off (O)	–	●	●	101
[Mic. Level] ¹	[A Automatic], [M Manual] [Audio Level Indicator]: Toggle on (I) or off (O)	–	●	●	105
[Image Effects]	[ON], [OFF] When [ON] - [Color Depth], [Sharpness], [Contrast], [Brightness]: ± 0 (-2 to +2)	–	●	–	103
[AGC Limit]	[A Automatic], [M Manual]: (0 dB to 24 dB)	–	●	●	99
[Image Stabilizer]	[Dynamic], [Standard], [Off]	–	●	●	90
[Faders] ¹	[Off], [F1] Fade Trigger/Once], [F1] Fade Trigger/Always], [F2] Wipe/Once], [F2] Wipe/Always]	–	●	●	95
[Pre REC] ¹	[ON On], [OFF Off]	–	●	●	92
[Review Recording] ¹	–	–	●	●	85

¹ Option available only for recording movies.

² Some options are available only when recording a story using Story Creator.

Edit Panel - Mode

Control Button	Date Index Screen	[SD Movies] Index Screen	Playback Pause	
[Copy (A → B)] ¹ HFM41/M40 [Copy ( → B)] ¹	<date>, [Select], [All Scenes]	–	–	131
HFM41/M40 [Convert HD → SD (A → B)] ¹ [Convert HD → SD ( → B)] ¹	<date>, [Select], [All Scenes]	–	–	140
[Delete]	<date>, [Select], [All Scenes]	[This Scene], [All Scenes]	[This Scene]	61
[Divide]	–	–	●	119

Control Button	[Edit Story] from the [Story Details] screen	[Edit Scene] from the [Scene List] screen	Playback Pause	
[Copy (A → B)] ¹ HFM41/M40 [Copy ( → B)] ¹	<by scene rating>	–	–	132
HFM41/M40 [Convert HD → SD (A → B)] ¹ [Convert HD → SD ( → B)] ¹	<by scene rating>	–	–	143
[Delete] or []	<by scene rating>	[This Scene]	[This Scene]	61
[Delete Story] ²	●	–	–	63
[Story Thumbnail] ²	●	–	–	82

Control Button	[Edit Story] from the [Story Details] screen	[Edit Scene] from the [Scene List] screen	Playback Pause	
[Edit Title] ²	●	–	–	82
[Copy]	–	●	–	81
[Move]	–	●	–	81
[Divide]	–	–	●	119
[Rating]	–	[★★★★], [★★★•], [★★••], [••••] (unrated), [----] (others)		76

¹ Operation not available for recordings on memory card **B** (tab).

² Operation not available for the two preexisting stories, [Unsorted] and [Video Snapshot].

Edit Panel - Mode



Control Button	Index Screen	Single Photo View	
[Copy (→)]*	[Select], [All Photos]	●	132, 133
HFM41/M40 [Copy (→)]*			
[Delete]		●	123

* Operation not available for recordings on memory card **B** (tab).

Setup Menus

Camera Setup

Menu item	Setting options	M	CINEMA	
[Digital Zoom]	[OFF Off], [40x 40x], [200x 200x]	●	–	–
[Zoom Speed]	[VAR Variable], [Speed 3], [Speed 2], [Speed 1]	●	●	51
[AF Mode]	[LAF Instant AF], [AF Normal AF]	●	●	–
[Focus Assistance] ¹	[ON On], [OFF Off]	●	●	–
[Face Detection & Tracking]	[ON On], [OFF Off]	●	●	93

Menu item	Setting options	M	CINEMA	
[Auto Backlight Correction]	[ON On], [OFF Off]	●	●	99
[Auto Slow Shutter]	[ON On], [OFF Off]	●	●	—
[Conversion Lens]	[Tele Tele-converter], [Wide Wide-converter], [OFF Off]	●	●	—
[Fader Setting] ¹	[BLACK Black Screen], [WHITE White Screen]	●	●	95
[Onscreen Markers]	[OFF Off], [EW Level (White)], [EG Level (Gray)], [EWG Grid (White)], [EGG Grid (Gray)]	●	●	—
[Camcorder Shake Indicator]	[ON On], [OFF Off]	●	●	—
[Wind Screen] ¹	[A Automatic], [OFF Off ]	●	●	—
[Microphone Attenuator] ¹	[A Automatic], [ON On ATT]	●	●	—
[MIC Terminal Input] ¹	[LINE External Audio], [MIC Microphone]	●	●	108
[Audio Mix] ¹	[OFF Off], [ON On], [INT] [EXT] [Internal Microphone]/[MIC Terminal Input]	●	●	108
[Built-in Mic Freq. Response]	[NORM Normal], [LB Boost LF Range], [LC Low Cut Filter], [MB Boost MF Range], [LHB Boost HF+LF Range]	●	●	107
[Built-in Mic Directionality]	[2ch MONO Monaural], [NORM Normal], [2ch WIDE Wide], [2ch ZOOM Zoom]	●	●	106
[Surround Mic Directionality] ^{1, 2}	[5.1ch Surround], [5.1ch ZOOM Zoom], [5.1ch GUN Shotgun]	●	●	—
[Surround Mic Attenuator] ^{1, 2}	[ON On ATT], [OFF Off]	●	●	—

¹ Option available only for recording movies.

² Option available only when the optional SM-V1 Surround Microphone is attached to the camcorder after having updated the camcorder's firmware using the memory card supplied with the SM-V1.

[Digital Zoom]: Determines the operation of the digital zoom. The color of the indicator indicates the zoom.

- When activated, the camcorder will switch automatically to digital zoom when you zoom in beyond the optical zoom range.
- With the digital zoom the image is digitally processed, so the image resolution will deteriorate the more you zoom in.

Optical zoom	Digital zoom	
White	Light blue	Dark blue
Up to 10x	10x - 40x	40x - 200x

[AF Mode]: Select how fast the autofocus will operate.

- With [**IAF** Instant AF] the autofocus adjusts quickly to a new subject. This is convenient, for example, when changing the focus from a near subject to a far subject in the background, or when recording moving subjects.
- When the optional Wide-converter or Tele-converter is attached to the camcorder, it may partially obstruct the Instant AF sensor. Set the AF mode to [**AF** Normal AF].
- When the recording program is set to [Underwater] or [Surface], the AF mode is automatically set to [**AF** Normal AF].

[Focus Assistance]: When focus assistance is activated, the image at the center of the screen is magnified to help you focus manually (99).

- Using focus assistance will not affect the recordings. It will be cancelled automatically after 4 seconds or when you start recording.

[Auto Slow Shutter]: The camcorder automatically uses slow shutter speeds to obtain brighter recordings in places with insufficient lighting.





- Minimum shutter speed used: 1/30; 1/12 when the frame rate is set to [**PF24** PF24]; 1/15 when it is set to [**PF30** PF30].
- The auto slow shutter can only be activated when the recording program is set to [**P** Programmed AE], but the setting will not change even if you set the camcorder to [**AUTO** mode].
- If a trailing afterimage appears, set the slow shutter to [**OFF** Off].
- When the recording program is set to [Underwater] or [Surface], the auto slow shutter is automatically set to [**OFF** Off].

[Conversion Lens]: When you attach to the camcorder an optional tele-converter or wide-converter, set the appropriate conversion lens setting to obtain optimal image stabilization.

- When you select a setting other than **[OFF Off]**, the AF mode is automatically set to **[AF Normal AF]**.

[Onscreen Markers]: You can display a grid or a horizontal line at the center of the screen. Use the markers as a reference to make sure your subject is framed correctly (vertically and/or horizontally).

- Using the onscreen markers will not affect the recordings.

[Camcorder Shake Indicator]: The degree of camcorder shake will be indicated by the POWERED IS icon (5 levels: , , , , ) to help you be aware of excessive movement.



[Wind Screen]: The camcorder automatically reduces the background sound of wind when recording outdoors.

- Some low-frequency sounds will be suppressed along with the sound of wind. When recording in surroundings unaffected by wind or if you want to record low-frequency sounds, we recommend setting the wind screen to **[OFF Off **.

[Microphone Attenuator]: Helps prevent audio distortions.

[A Automatic]: The camcorder will automatically activate the microphone attenuator as necessary for optimal audio recording levels so high audio levels will not be distorted.

[ON On ATT]: The microphone attenuator will be activated at all times to reproduce more faithfully the sound dynamics. **ATT** will appear on the screen.

- This menu option is not available when the optional SM-V1 Surround Microphone is attached to the camcorder. In that case, activate the microphone attenuator with the [Surround Mic Attenuator] setting.
- When the recording program is set to  Underwater] or  Surface], the microphone attenuator is automatically set to **[OFF Off]**.

[Surround Mic Directionality]: Sets the directionality mode of the optional SM-V1 Surround Microphone.













[5.1ch Surround]: Records 5.1ch surround sound.

[5.1ch ZOOM Zoom]: Records 5.1 audio channels. Additionally, the audio is linked to the zoom position. The larger the subject appears on the screen, the louder the sound will be as well.

[5.1ch GUN Shotgun]: Records monaural audio with a highly directional setting that is most sensitive to sound coming directly from the front of the camcorder/microphone.

[Surround Mic Attenuator]: Helps prevent audio distortions due to high audio recording levels when the optional SM-V1 Surround Microphone is attached to the camcorder. When set to **[ON On ATT]**, **ATT** will appear on the screen.

/ Playback Setup

Menu item	Setting options			
[Select Music]	[OFF Off] , [ON On] When [ON On] - list of music tracks,   (Original sound/Background music)	●	●	77
[External Audio Input]	[OFF Off] , [ON On]  When [ON On] - [External Player Link]: Toggle on (I) or off (II)	●	●	79
[Data Code]	[OFF Off] ,  Date],  Time],  Date and Time],  Camera Data]	●	●	-
[Slideshow Transition]	[OFF Off] ,  Dissolve],  Slide Image]	-	●	124
[TV Type]*	[4:3 Normal TV] , [16:9 Wide TV]	●	●	-

* Option not available when the camcorder is connected to an HDTV using the supplied HDMI cable.

[Data Code]: Displays the date and/or time when the scene or photo was recorded.

[ Camera Data]: Displays the aperture (f-stop) and shutter speed used when recording the scene or photo.











[TV Type]: When you connect the camcorder to a TV using the supplied STV-250N Stereo Video Cable, select the setting according to the type of TV in order to display the picture in full and in the correct aspect ratio.

[4:3 Normal TV]: TV sets with 4:3 aspect ratio.

[16:9 Wide TV]: TV sets with 16:9 aspect ratio.

- When the TV type is set to **[4:3 Normal TV]**, during the playback of video originally recorded with an aspect ratio of 16:9, the picture will not be displayed fullscreen.

Recording & Connections Setup

Menu item	Setting options	M	CINEMA			
[Self Timer]	[ON On  , [OFF Off]	●	●	–	–	104
[Video Snapshot Length] ¹	[2sec 2 sec], [4sec 4 sec], [8sec 8 sec], [Story Length-Based]: Toggle on (I) or off (II)	●	●	●	–	68, 117
[Rate Scenes (Recording)] ¹	[ON On], [OFF Off]	●	●	–	–	–
[Rec Media for Movies] ¹	HFM41/M40 [] (built-in memory), [A] (memory card A), [B] (memory card B), [Relay Recording]: [OFF Off], [ → A], [ → A → B], [A → B] HFM400 [A] (memory card A), [B] (memory card B), [Relay Recording]: [OFF Off], [A → B]	●	●	–	–	42
[Recording Mode] ¹	[MPX High Quality 24 Mbps], [FXP High Quality 17 Mbps], [XP+ High Quality 12 Mbps], [SP Standard Play 7 Mbps], [LP Long Play 5 Mbps]	●	●	–	–	85
[Frame Rate] ^{1, 2}	[60i 60i (Standard)], [PF30 PF30], [PF24 PF24]	●	●	–	–	87
[Rec Media for Photos] ³	[]* (built-in memory), [A] (memory card A), [B] (memory card B) * HFM41/M40 only.	●	–	●	–	42
[Photo Capture from Video] ³	[ Single Photo], [ Photo Sequence]	–	–	●	–	118

Menu item	Setting options	M	CINEMA			
[Memory Info]	[]* (built-in memory), [] (memory card A), [] (memory card B) * HFM41/M40 only.	●	●	●	●	—
[x.v.Color]	[ON On color], [OFF Off]	●	●	—	—	—
[Photo Numbering] ³	[Reset], [Continuous]	●	—	●	●	—

¹ Option available only for recording movies.

² Can be set independently for and mode. The default value in mode is [**PF24** PF24].

³ Option available only for recording photos.

[Rate Scenes (Recording)]: When set to [**ON** On], the scene rating scene will appear after every scene you record.

[Memory Info]: Displays a screen where you can verify how much of the built-in memory (**HFM41/M40** only) or the memory card is currently in use (total recording time and total number of photos) and how much space remains available for recording.

- Estimated figures about available movie recording time and available number of photos are approximate and based on the recording mode and photo quality/size settings currently in use.
- In the information screen of a memory card you can also check its Speed Class.
- **HFM41/M40** The [Total space] shown for the built-in memory indicates actually usable space. It may be slightly smaller than the nominal built-in memory capacity listed in the specifications.

[x.v.Color]: Uses a color space with an extended gamut to achieve deeper colors, closer to real life.

- Use this function to record video only when you intend to play back your recordings on an HDTV compatible with x.v.Color, connected to the camcorder using the supplied HDMI cable. If recordings made with x.v.Color are played back on a non-compatible TV, colors may not be reproduced correctly.











[Photo Numbering]: Select the photo numbering method to be used on a new memory card. Photos are automatically assigned consecutive numbers from 0101 to 9900, and stored in folders containing up to 100 photos. Folders are numbered from 101 to 998.

[Reset]: Photo numbers will restart from 101-0101 every time you insert a new memory card.

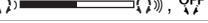

[] Continuous: Photo numbers will continue from the number following that of the last photo recorded with the camcorder.

- If the memory card you insert already contains a photo with a larger number, a new photo will be assigned a number one higher than that of the last photo on the memory card.
- We recommend using the **[] Continuous** setting.
- The photo number indicates the name and location of the file on the memory card. For example, the file name of a photo numbered 101-0107 is "IMG_0107.JPG", stored under the folder "DCIM\101\CANON".

System Setup

Menu item	Setting options	M	CINEMA			
[Output Onscreen Displays]	[ON On] , [OFF Off]	●	●	●	●	–
[Language 	[Česky], [Dansk], [Deutsch], [Ελληνικά], [English], [Español], [Français], [Italiano], [Magyar], [Melayu], [Nederlands], [Norsk], [Polski], [Português], [Română], [Suomi], [Svenska], [Türkçe], [Русский], [Українська], [العربية], [فارسی], [ภาษาไทย], [简体中文], [繁體中文], [한국어], [日本語]	●	●	●	●	37
[LCD Brightness]		●	●	●	●	–
[LCD Screen Dimmer]	[ON On] , [OFF Off]	●	●	●	●	–
[LCD Mirror Image]	[ON On] , [OFF Off]	●	●	–	–	–
[AV/Headphones]	[AV AV] ,  Headphones	●	●	●	●	109
[Volume]	Speaker: 	–	–	●	●	57
	Headphone: 	●	●	●	●	109
[Notification Sounds]	[ High Volume] , [ Low Volume] , [OFF Off]	●	●	●	●	–
[Wireless Remote Control]	[ON On] , [OFF Off] 	●	●	●	●	–

Menu item	Setting options	M	CINEMA			
[POWERED IS Button]	[ON] Press and Hold], [OFF] Toggle On/Off]	●	●	–	–	91
[Autostart Decoration]	[ON] On], [OFF] Off]	●	●	●	–	–
[Power Saving Mode]	[Auto Power Off]: [OFF] Off], [ON] On] [Quick Start (Standby)]: [Off], [10 min], [20 min], [30 min]	●	●	●	●	–
HFM41/M40 [Initialize /]	[Built-in Mem.]*, [Mem. Card A], [Mem. Card B] * HFM41/M40 only.	●	●	●	●	44
HFM400 [Initialize]	[Complete Initialization]: Toggle on () or off ()					
[Time Zone/DST]	[] (home time zone) or [] (travel time zone): <u>[New York]</u> , list of world time zones [] (DST adjustment): Toggle on () or off ()	●	●	●	●	37
[Date/Time]	[Date/Time]: – [Date Format]: [Y.M.D], [<u>M.D.Y</u>], [D.M.Y] (Y- year, M- month, D- day) [24H]: Toggle on (, 24-hour clock) or off (, 12-hour clock)	●	●	●	●	36
[Battery Info]	–	●	●	●	●	–
[Control for HDMI] ¹	[ON] On], [OFF] Off]	●	●	●	●	–
[HDMI 1080p Output] ¹	[ON] On], [OFF] Off]	●	●	●	●	–
[HDMI Status]	[Video Output], [Audio Output]	●	●	●	●	–
[Distance Units]	[m] meters], [ft] feet]	●	●	–	–	–
[Demo Mode]	[ON] On], [OFF] Off]	●	●	–	–	–
[Firmware]	–	–	–	–	●	–

Menu item	Setting options	M	CINEMA			
[Eye-Fi Communication] ²	[A Automatic], [OFF Off]	●	●	●	●	144

¹ Option not available when the camcorder is connected to an HDTV using the supplied HDMI cable.

² Option available only after having inserted an Eye-Fi card into memory card slot **B**.

[Output Onscreen Displays]: When set to [**ON** On], the camcorder's onscreen displays will appear also on the screen of a TV or monitor connected to the camcorder.

[LCD Brightness]: Adjusts the brightness of the LCD screen.

- Changing the brightness of the LCD screen does not affect the brightness of your recordings or the brightness of the playback image on a TV.

[LCD Screen Dimmer]: When set to [**ON** On], the LCD screen is dimmed. Doing so is ideal when using the camcorder in locations where the LCD's illumination could become a nuisance to others. Hold [**DISP**] pressed down for about 2 seconds to restore the LCD screen to its previous brightness setting.

- Dimming the LCD screen does not affect the brightness of your recordings or the brightness of the playback image on a TV.
- When the screen dimmer is set to [**OFF** Off], the LCD screen will return to the brightness level that was in use before the screen was dimmed.

[LCD Mirror Image]: When set to [**ON** On], you can rotate the LCD panel 180 degrees to let the subject check the image while you record. While the LCD panel is rotated toward the subject you will not be able to decorate the scene.

[Notification Sounds]: A beep will accompany some operations like turning on the camcorder, the self-timer countdown, etc.

- While pre-recording ( 92) is activated, the camcorder will not emit any notification sounds.

[Wireless Remote Control]: Allows the camcorder to be operated with the wireless controller.

[POWERED IS Button]: Determines the operation mode of the POWERED IS button.

[**ON**] Press and Hold]: Powered IS will be activated while you hold the button pressed down.

[ Toggle On/Off]: Each press of the button will turn the Powered IS function on and off.

[Autostart Decoration]: When set to [ On], the decoration screen will open automatically when you stow the LCD panel with the LCD screen facing out.





[Power Saving Mode]: Controls the camcorder's automatic power off settings.

[Auto Power Off]: In order to save power when the camcorder is powered by a battery pack, it will automatically shut off if left without any operation for 5 minutes.

- Approximately 30 seconds before the camcorder shuts off, [Auto Power Off] will appear.
- In standby mode, the camcorder will shut off after the time selected for the [Quick Start (Standby)] setting.



[Quick Start (Standby)]: Select whether to activate the Quick Start function ( 53) when you close the LCD panel in a recording mode and the length of time after which the camcorder will end the standby mode and shut off automatically.

- You can set Quick Start to [Off], for example, if the camcorder is set on a fixed position and you want to keep recording video with the LCD panel closed in order to conserve the battery's power.

[Battery Info]: Displays a screen where you can verify the battery charge (as a percentage) and the remaining recording time (,  mode) or playback time (,  mode).

[Control for HDMI]: Activates the HDMI-CEC (Consumer Electronics Control) function. When you connect the camcorder to an HDTV compatible with HDMI-CEC using the supplied HDMI cable, you can control the camcorder's playback using the remote control of the TV.

- If set to [ On], when the camcorder is connected to a compatible HDTV using the supplied HDMI cable, the video input on the TV will automatically be set to the camcorder's video input. Then, you can use the up/down/left/right buttons and the OK or SET button on the TV's remote control to play back your recordings.
- Depending on the TV set, additional settings may be required on the TV itself to activate the HDMI-CEC function. Refer to the TV's instruction manual.
- Correct operation of the HDMI-CEC function cannot be guaranteed even when connecting the camcorder to compatible TV sets. If you cannot use the remote control of the TV, set [Control for HDMI] to

- [**OFF** Off] and operate the camcorder directly or use the camcorder's wireless controller.
- The remote control of the TV can only be used to play back movies or photos ( or  mode only). If the camcorder is connected to the TV while it is set to a recording mode, depending on the TV used, turning off the TV will automatically turn off the camcorder even if it is recording at the time.
 - We recommend not connecting more than 3 HDMI-CEC compatible devices at a time.

[HDMI 1080p Output]: If set to [**ON** On], when the camcorder is connected to an HDTV that supports the 1080p standard using the supplied HDMI cable, your video recordings (made in 1080i) will be converted and output as 1080p.

[HDMI Status]: Displays a screen where you can verify the standard of the output signal from the HDMI OUT terminal.

[Distance Units]: Selects the units to use for the focusing distance display during manual focus.

[Demo Mode]: The demonstration mode displays the camcorder's main features. It starts automatically when the camcorder is powered with the compact power adapter if you leave it turned on without a memory card for more than 5 minutes.

- To cancel the demo mode once it has started, press any button or turn off the camcorder.

[Firmware]: You can verify the current version of the camcorder's firmware. This menu option is usually unavailable.

Appendix: Onscreen Icons and Displays

AUTO Recording Movies (using Story Creator)

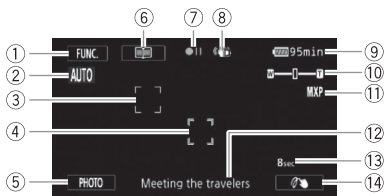

- ① Control button [FUNC.]: Open the FUNC. panel (📖 34)
- ② Smart AUTO (📖 48)
- ③ Face detection frame (📖 93)
- ④ Touch & Track frame (📖 94)
- ⑤ Control button [PHOTO]: Take a photo (📖 46, 84, 118)
- ⑥ Control button [📖]: Return to the list of story scenes (📖 65)
- ⑦ Memory operation (📖 164)
- ⑧ Image stabilizer (📖 90)
- ⑨ Remaining battery time (📖 164)
- ⑩ Zoom (📖 52)
- ⑪ Recording mode (📖 85)
- ⑫ Current story scene (category) (📖 65)
- ⑬ Recommended scene length (📖 65)
- ⑭ Decoration (📖 69)

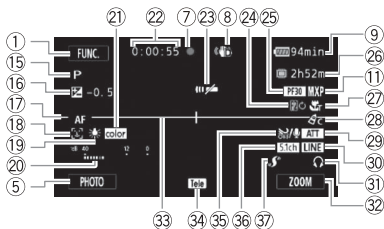
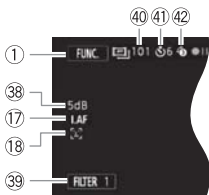
M, **CINEMA** **Recording Movies****M** Manual mode**CINEMA** mode

- 15 Recording program (87, 96)
- 16 Manual exposure (98)
- 17 **LAF** Instant AF/**AF** Normal AF (151), MF Manual focus (99)
- 18 Face detection (93)
- 19 White balance (102)
- 20 Audio level indicator (105)
- 21 x.v.Color (155)
- 22 While recording/during playback:
Scene counter (hours : minutes : seconds)
- 23 Remote sensor off (158)
- 24 Fader (95)
- 25 Frame rate (87)
- 26 Remaining recording time
A/**B** On the memory card
In the built-in memory*
Relay recording (43)
* **HFM41/M40** only.
- 27 Tele macro (101)
- 28 Image effects (103)
- 29 Microphone attenuator (152)
- 30 External audio input (108)
- 31 Headphone output (109)
- 32 Control button: Last function used ([ZOOM] in this case)
- 33 Level marker (152)
- 34 Conversion lens (Tele-converter shown) (151)
- 35 Wind screen off (152)
- 36 Directionality of the optional SM-V1 Surround Microphone (111)
- 37 Mini advanced shoe (110)
- 38 AGC (automatic gain control) limit
- 39 Control button [FILTER 1]: Cinema-look filters (67)
- 40 In record pause mode:
Total number of scenes
- 41 Self timer (104)
- 42 Pre-recording (92)



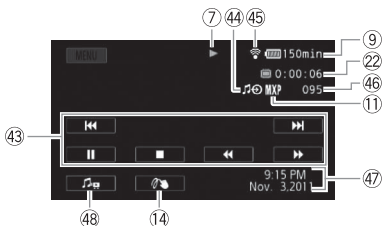



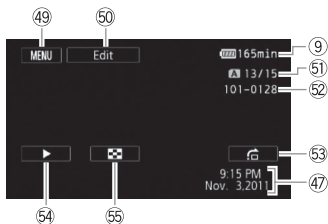

Playing Movies (during playback)



- ④③ Playback control buttons ( 57)
- ④④ External audio input ( 79)
- ④⑤ Eye-Fi wireless communication ( 144)
- ④⑥ Scene number
- ④⑦ Data code ( 116, 153)
- ④⑧ Volume and background music balance controls ( 57, 78)

Viewing Photos



- ④⑨ Control button [MENU]: Open the setup menus ( 149)
- ④⑩ Control button [Edit]: Open the Edit panel ( 149)
- ④⑪ Current photo / Total number of photos
- ④⑫ Photo number ( 155)
- ④⑬ Control button []: Photo jump ( 122)
- ④⑭ Control button []: Slideshow ( 124)
- ④⑮ Control button []: Return to the [Photos] index screen ( 121)



⑦ Memory operation

- Record, ●|| Record pause, ► Playback, || Playback pause, ►► Fast playback, ◄◄ Fast reverse playback, ► Slow playback, ◄ Slow reverse playback, ►► Frame advance, ◄|| Frame reverse.

⑨ Remaining battery time

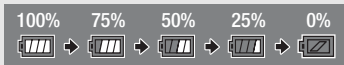
- The icon shows a rough estimate of the remaining charge as a percentage of the full charge of the battery pack. The remaining recording/playback time of the battery pack is displayed, in minutes, next to the icon.



- When  is displayed in red, replace the battery pack with a fully charged one.
- When you attach an empty battery pack, the power may turn off without displaying .
- Depending on the conditions under which the camcorder and the battery pack are used, the actual battery charge may not be indicated accurately.
- When the camcorder is off, press **[BATT.INFO]** to display the charge status of a battery pack. The Intelligent System will display the charge status (as a percentage) and the remaining recording time (in minutes) for 5 seconds. If the battery pack is exhausted, the battery information may not be displayed.

⑳ Remaining recording time

When there is no more free space on the memory, **[End]** (built-in memory, **HFM41/M40** only) or **[A End]** (memory card **A**) or **[B End]** (memory card **B**) will be displayed in red and the recording will stop.

Troubleshooting

If you have a problem with your camcorder, refer to this section. Sometimes what you think is a malfunction of the camcorder may have the simplest of solutions - please read the "CHECK THIS FIRST" box before going on to the more detailed problems and solutions. Consult your dealer or a Canon Service Center if the problem persists.

CHECK THIS FIRST

Power supply

- Is the battery charged? Is the compact power adapter correctly connected to the camcorder? (📖 24)

Recording

- Did you turn the camcorder on and correctly set it to a recording mode? (📖 46, 84) If you are recording on a memory card, is one correctly inserted into the camcorder? (📖 41)

Playback

- Did you turn the camcorder on and correctly set it to playback mode? (📖 55, 121) If you are playing back recordings from a memory card, is one correctly inserted into the camcorder? (📖 41) Does it contain any recordings?

Other

- Does the camcorder make a rattling sound? The internal lens fixture can move when the camcorder is turned off or in a playback mode. This is not a malfunction.

Power source

The camcorder will not turn on or it turns off by itself.

- The battery pack is exhausted. Replace or charge the battery pack.
- Remove the battery pack and reattach it correctly.
- When the recording program is set to [Underwater] or [Surface], the camcorder may turn off automatically if it becomes too hot. Turn off the camcorder and let it cool down.

Cannot charge the battery pack.

- Make sure the camcorder is off so charging can start.
- The temperature of the battery pack is outside its operating range (approximately 0 – 40 °C (32 – 104 °F)). Remove the battery pack, warm it or let it cool down, as necessary, and try charging it again.
- Charge the battery pack in temperatures between approximately 0 °C and 40 °C (32 °F and 104 °F).

- The battery pack is faulty. Replace the battery pack.
- The camcorder cannot communicate with the battery pack attached. Battery packs not recommended by Canon for use with this camcorder cannot be charged using this camcorder.
- If you are using a battery pack recommended by Canon for use with this camcorder, there may be a problem with the camcorder or battery pack. Consult a Canon Service Center.

A noise can be heard from the compact power adapter.



- A faint sound can be heard while the compact power adapter is connected to a power outlet. This is not a malfunction.

The battery pack is exhausted extremely quickly even at normal temperatures.

- The battery may have reached the end of its battery life. Buy a new battery pack.

Recording



Pressing  will not start recording.

- You cannot record while the camcorder is writing previous recordings onto the memory (while the ACCESS indicator is on or flashing). Wait until the camcorder has finished.
- The memory is full or it already contains the maximum number of scenes (3,999 scenes). Delete some recordings ( 61, 123) or initialize the memory ( 44) to free some space.

The point where  was pressed does not match the beginning/end of the recording.



- There is a slight interval between pressing  and the actual start/end of recording. This is not a malfunction.



The camcorder will not focus.

- Autofocus does not work on the subject. Focus manually ( 99).
- The lens or Instant AF sensor is dirty. Clean the lens or sensor with a soft lens-cleaning cloth ( 184). Never use tissue paper to clean the lens.



When a subject flits across in front of the lens, the image appears slightly bent.

- This is a phenomenon typical of CMOS image sensors. When a subject crosses very quickly in front of the camcorder, the image may seem slightly warped. This is not a malfunction.



Changing the operating mode between recording ()/record pause ()/playback () takes longer than usual.

- When the memory contains a large number of scenes, some operations may take longer than usual. Save your recordings ( 134) and initialize the memory ( 44).

Movies or photos cannot be recorded properly.

- This may occur as movies and photos are recorded/deleted over time. Save your recordings ( 134) and initialize the memory ( 44).

Cannot record a photo while recording movies.

- You cannot take photos in  mode, while the digital zoom is activated ( 151) or while fading in or fading out a scene ( 95).

After using the camcorder for a long time, it becomes hot.

- The camcorder may become hot after using it continuously for long periods of time; this is not a malfunction. If the camcorder becomes unusually hot or it becomes hot after using it only for a short while, it may indicate a problem with the camcorder. Consult a Canon Service Center.

Cannot create a new story.

- A memory can contain a maximum of 98 user-created stories. Delete some stories from the gallery (📖 63) or select a different memory (📖 42).

Playback

Cannot copy/move scenes in a story.

- The memory is full. Delete some recordings (📖 61, 123) to free some space.

Cannot delete a scene.

- You may not be able to delete scenes recorded or edited using another device.

Deleting scenes takes longer than usual.

- When the memory contains a large number of scenes, some operations may take longer than usual. Save your recordings (📖 134) and initialize the memory (📖 44).

Cannot capture a video snapshot scene from a movie.

- You cannot capture video snapshot scenes from scenes recorded or edited using another device.
- The memory is full. Delete some recordings (📖 61, 123) to free some space.

When playing back scenes/slideshow with background music, the music track is not played back correctly.

- This can occur when you transfer the music files to a memory card after repeatedly recording and deleting scenes (fragmented memory). Save your recordings (📖 134) and initialize the memory card (📖 44). Then, transfer the music files first and only then transfer the video files.
- Music tracks will not play back correctly if the connection was interrupted while transferring the music files to a memory card. Delete the music tracks and transfer the music files again.
- The transfer rate of the memory card used is too slow. Use a recommended memory card (📖 39).

When playing scenes/a slideshow linked to external audio, the video playback is not correctly linked to the external player.

- The volume of external player may be too low. Try increasing the volume of the external player.

Cannot divide scenes

- You cannot divide scenes recorded or edited using another device.
- The memory is full. Delete some recordings (📖 61, 123) to free some space.

Cannot copy scenes/photos

- You may not be able to copy scenes/photos recorded or edited using another device.

Cannot mark individual scenes/photos in the index screen with a checkmark ✓

- You cannot select more than 100 scenes/photos individually. Select the [All Scenes] or [All Photos] option instead of [Select].

Indicators and Onscreen Displays

lights up in red.

- Battery pack is exhausted. Replace or charge the battery pack.

appears on the screen.

- The camcorder cannot communicate with the battery pack attached so the remaining battery time cannot be displayed.

lights up in red.

- A memory card error occurred. Turn off the camcorder. Remove and reinsert the memory card. Initialize the memory card if the display does not change back to normal.
- The memory card is full. Replace the memory card or delete some recordings ( 61, 123) to free some space on the memory card.

Even after stopping recording, the ACCESS indicator does not go off.

- The scene is being recorded in the memory. This is not a malfunction.

appears on the screen.

- The camcorder has become hot while in the [Underwater] or [Surface] recording program. Turn off the camcorder and let it cool down.

The red ON/OFF (CHG) indicator flashes rapidly (one flash at 0.5-second intervals).

- Charging has stopped because the compact power adapter or the battery pack is faulty. Consult a Canon Service Center.

The red ON/OFF (CHG) indicator flashes very slowly (one flash at 2-second intervals).

- The temperature of the battery pack is outside its operating range (approximately 0 – 40 °C (32 – 104 °F)). Remove the battery pack, warm it or let it cool down, as necessary, and try charging it again.
- Charge the battery pack in temperatures between approximately 0 °C and 40 °C (32 °F and 104 °F).
- The battery pack is damaged. Use a different battery pack.

appears on the screen

- The LOCK switch on the Eye-Fi card is set to prevent accidental erasure. Change the position of the LOCK switch.

- An error occurred when trying to access control data on the Eye-Fi card. Turn the camcorder off then on again. If the icon appears often, there might be a problem with the Eye-Fi card. Contact the card manufacturer's customer care.

Picture and Sound

The screen appears too dark.

- The LCD screen was dimmed. Hold **[DISP]** pressed down for 2 seconds to restore the LCD screen to its previous brightness setting.

Screen displays turn on and off repeatedly.

- The battery pack is exhausted. Replace or charge the battery pack.
- Remove the battery pack and reattach it correctly.

Abnormal characters appear on the screen and the camcorder does not operate properly.

- Disconnect the power source and reconnect it after a short time. If the problem still persists, remove the battery pack and disconnect all other power sources from the camcorder. Then, press the RESET button with a pointed object to reset all the camcorder's settings to default values.

Video noise appears on screen.

- Keep a distance between the camcorder and devices that emit strong electromagnetic fields (plasma TVs, cellular phones, etc.).

Horizontal bands appear on the screen.

- This is a phenomenon typical of CMOS image sensors when recording under some types of fluorescent, mercury or sodium lamps. To reduce the symptoms, set the recording program to [Programmed AE] or [Shutter-Pri. AE] (📖 96). This is not a malfunction.

HFM41 No picture appears on the viewfinder.

- Press **[VIEWFINDER]** to activate the viewfinder (📖 31).
- No picture will be output to the viewfinder if a cable is connected to the HDMI OUT, COMPONENT OUT or AV OUT/🔌 terminal in playback mode. Remove the cable.

HFM41 Viewfinder picture is blurred.

- Adjust the viewfinder with the diopter adjustment lever (📖 31).



Sound is distorted or is recorded at lower levels.

- When recording near loud sounds (such as fireworks, shows or concerts), sound may become distorted or it may not be recorded at the actual levels. Activate the microphone attenuator (📖 152) or adjust the audio recording level manually (📖 105).

There are brief stops in the sound recorded with the optional WM-V1 Wireless Microphone.

- This may occur if the LOCK switch on the Eye-Fi card was set to prevent writing, causing wireless communication to occur while recording. Change the position of the LOCK switch.

The picture is displayed correctly but there is no sound from the built-in speaker.





- Speaker volume is turned off. Adjust the volume.
- If the STV-250N Stereo Video Cable is connected to the camcorder, disconnect it.
- The AV terminal is set to headphone output. Set   [AV/Headphones] to [AV].

Memory Card and Accessories



Cannot insert the memory card.

- The memory card was not facing the correct direction. Turn the memory card over and insert it.





Cannot record on the memory card.

- The memory card is full. Delete some recordings ( 61, 123) to free some space or replace the memory card.
- Initialize the memory card ( 44) when you use it with the camcorder for the first time.
- The LOCK switch on the memory card is set to prevent accidental erasure. Change the position of the LOCK switch.
- A compatible memory card must be used to be able to record movies on a memory card ( 39).
- The folder and file numbers have reached their maximum value. Set   [Photo Numbering] to [Reset] and insert a new memory card.

The wireless controller will not work.

- Set   [Wireless Remote Control] to [On].
- Replace the battery of the wireless controller.

Cannot upload files wirelessly using an Eye-Fi card.

- You may have inserted the Eye-Fi card into memory card slot **A**. Insert it into memory card slot **B**.
-   [Eye-Fi Communication] is set to [Off] ( appears onscreen). Set it to [Automatic].
- Wireless communication is not available in recording mode or while the optional WM-V1 Wireless Microphone is attached to the camcorder. Set the camcorder to playback mode or remove the WM-V1.
- Opening the LCD panel may help when the wireless connection is not strong enough.
- During wireless transfer, wireless communication may stop when the wireless signal conditions worsen ( appears onscreen). Perform wireless transfer in a place with good signal conditions.
- Contact the card manufacturer's customer care.

The wireless communication status icon does not appear

- You may have inserted the Eye-Fi card into memory card slot **A**. Insert it into memory card slot **B**.

Connections with External Devices

Video noise appears on the TV screen.

- When using the camcorder in a room where a TV is located, keep a distance between the compact power adapter and the power or antenna cables of the TV.

Playback looks fine on the camcorder but there is no image on the TV screen.

- The video input on the TV is not set to the video terminal to which you connected the camcorder. Select the correct video input.
- There will be no video output from the AV OUT terminal while the optional CTC-100 Component Cable is connected to the camcorder's COMPONENT OUT terminal. Disconnect the CTC-100 Component Cable in advance to use the AV OUT terminal.

There is no sound from the TV.

- When connecting the camcorder to an HDTV using the optional CTC-100 Component Cable, make sure to connect also the audio connections using the white and red plugs of the STV-250N Stereo Video Cable.

The camcorder is connected using the supplied HDMI cable, but there is no picture or sound from the HDTV.

- Disconnect the supplied HDMI cable and then restore the connection or turn the camcorder off and then on again.

The camcorder is connected using the supplied HDMI cable, but HDMI-CEC does not work (cannot play back using the TV's remote control).

- Disconnect the HDMI cable and turn off the camcorder and the TV. After a short while turn them on again and restore the connection.
-  [Control for HDMI] is set to [Off]. Set it to [On].
- HDMI-CEC is not activated on the connected TV. Activate this function on the TV.
- Even with TV sets compatible with HDMI-CEC the range of functions available differs depending on the type of TV. Refer to the instruction manual of the connected TV.

The computer does not recognize the camcorder even though the camcorder is connected correctly.

- Disconnect the USB cable and turn off the camcorder. After a short while, turn it on again and restore the connection.
- Connect the camcorder to a different USB port on the computer.

Cannot save photos on my computer

- When the memory contains too many photos (Windows – 2,500 photos or more, Macintosh – 1,000 photos or more), you may not be able to transfer photos to a computer. Try using a card reader to transfer the photos on the memory card. **HFM41/M40** only: To transfer the photos in the built-in memory, copy them to the memory card in advance ( 131).

List of Messages (in alphabetical order)

Accessing the memory card. Do not remove the memory card.

- You opened the double memory card slot cover while the camcorder was accessing the memory card or the camcorder started accessing the memory card as you opened the double memory card slot cover. Do not remove the memory card until this message disappears.

Back up recordings regularly

- This message may appear when you turn on the camcorder. In the event of a malfunction, recordings may be lost so back up your recordings regularly.

Buffer overflow. Recording was stopped.

- The data transfer rate was too high for the memory card in use and the recording was stopped. Replace the memory card with one rated SD Speed Class 2, 4, 6 or 10.
- After repeatedly recording, deleting and editing scenes (fragmented memory), it will take longer to write data on the memory and recording may stop. Save your recordings (📖 134) and initialize the memory (📖 44).

HF M41/M40 Built-in memory error

- The built-in memory could not be read. Contact a Canon Service Center.

HF M41/M40 Built-in memory is full

- The built-in memory is full (“📷 End” appears on the screen). Delete some recordings (📖 61, 123) to free some space. Alternatively, save your recordings (📖 134) and initialize the built-in memory (📖 44).



HF M41/M40 Cannot access the built-in memory

- There is a problem with the built-in memory. Contact a Canon Service Center.

Cannot communicate with the battery pack. Continue using this battery pack?

- You attached a battery pack that is not recommended by Canon for use with this camcorder.
- If you are using a battery pack recommended by Canon for use with this camcorder, there may be a problem with the camcorder or battery pack. Consult a Canon Service Center.

HF M41/M40 Cannot convert

- Cannot access the memory card. Check the memory card and make sure it is inserted correctly.
- You inserted a MultiMedia Card (MMC) into the camcorder. Use a recommended memory card (📖 39).
- There was an error creating the file name. Set   [Photo Numbering] to [Reset] and initialize the memory card (📖 44) or delete all the photos (📖 123) and converted SD movies (📖 61).

Cannot copy

- The total size of the scenes you selected to copy exceeds the available space on the memory card. Delete some recordings on the memory card (📖 61, 123) or reduce the number of scenes to copy.

- The memory card already contains the maximum number of scenes (3,999 scenes). Delete some scenes (📖 61) to free some space.
- The gallery already contains the maximum number of stories (98 stories in any one given memory). Delete some stories (📖 63) to free some space.

Cannot divide the scene. Initialize only using the camcorder.

- The scene could not be divided because the camcorder's internal scene management data log is full. Save your recordings (📖 134) and initialize the memory (📖 44). Transfer back the backup files and try dividing the scene again.
- Use the supplied software VideoBrowser to save the scene and divide it on the computer.

Cannot enter standby mode now

- The camcorder cannot enter standby mode if the remaining battery charge is too low. Charge or replace the battery pack (📖 24).

Cannot load canvas

- The canvas file that was saved on the memory is corrupted.
- Canvas data cannot be read from canvas files created using other devices.

Cannot play back

- There is a problem with the memory. If this message appears often without apparent reason, contact a Canon Service Center.

HF M41/M40 Cannot play back Cannot access the built-in memory

- There is a problem with the built-in memory. Save your recordings (📖 134) and initialize the built-in memory using the [Complete Initialization] option (📖 44). If the problem persists, contact a Canon Service Center.

Cannot play back Check the memory card

- There is a problem with the memory card. Save your recordings (📖 134) and initialize the memory card using the [Complete Initialization] option (📖 44). If the problem persists, use a different memory card.

HF M41/M40 Cannot play the movies in the built-in memory Initialize only using the camcorder

- The camcorder's built-in memory was initialized using a computer. Initialize the built-in memory with this camcorder (📖 44).

Cannot play the movies on this memory card

- Movies cannot be played back from a 64 MB or smaller memory card. Use a recommended memory card (📖 39).

Cannot play the movies on this memory card Initialize only using the camcorder

- The memory card in the camcorder was initialized using a computer. Initialize the memory card with this camcorder (📖 44).

Cannot record

- You cannot capture video snapshot scenes from scenes recorded or edited using another device.
- There is a problem with the memory. If this message appears often without apparent reason, contact a Canon Service Center.

HF M41/M40 Cannot record Cannot access the built-in memory

- There is a problem with the built-in memory. Save your recordings (📖 134) and initialize the built-in memory using the [Complete Initialization] option (📖 44). If the problem persists, contact a Canon Service Center.

Cannot record Check the memory card

- There is a problem with the memory card. Save your recordings (📖 134) and initialize the memory card using the [Complete Initialization] option (📖 44). If the problem persists, use a different memory card.

HF M41/M40 Cannot record movies in the built-in memory Initialize only using the camcorder

- The camcorder's built-in memory was initialized using a computer. Initialize the built-in memory with this camcorder (📖 44).

Cannot record movies on this memory card

- Movies cannot be recorded on a 64 MB or smaller memory card. Use a recommended memory card (📖 39).

Cannot record movies on this memory card Initialize only using the camcorder

- The memory card in the camcorder was initialized using a computer. Initialize the memory card with this camcorder (📖 44).

Cannot save the canvas

- Cannot save your [Pens and Stamps] drawings on the memory. Save your recordings (📖 134) and initialize the memory (📖 44).

Change the battery pack

- Battery pack is exhausted. Replace or charge the battery pack.

Check the memory card

- Cannot access the memory card. Check the memory card and make sure it is inserted correctly.
- A memory card error occurred. The camcorder cannot record or display the image. Try removing and reinserting the memory card, or use a different memory card.
- You inserted a MultiMedia Card (MMC) into the camcorder. Use a recommended memory card (📖 39).
- If after the message disappears, **A/B** appears in red, perform the following: Turn off the camcorder and remove and reinsert the memory card. If **A/B** turns back to green you can resume recording/playback. If the problem persists, save your recordings (📖 134) and initialize the memory card (📖 44).

Do not disconnect the power source. Do not disconnect the USB cable unless you first use the computer to safely end the connection.

- When the camcorder is in  mode and is connected to the computer with the supplied USB cable, the camcorder cannot be operated. Disconnecting the USB cable or power source while this message appears may result in permanent loss of the recordings in the camcorder. Use the computer's Safely Remove Hardware function to end the connection and disconnect the USB cable before using the camcorder.
- To be able to write back scenes and to transfer music files to the camcorder, power the camcorder using the compact power adapter and only then connect it to the computer using the supplied USB cable.





Do not disconnect the power source. Cannot write data with this connection. To write data to the camcorder, connect the compact power adapter then reconnect the camcorder and computer. Do not disconnect the USB cable unless you first use the computer to safely end the connection.

- The camcorder cannot be operated while it is not being powered by the compact power adapter and is connected to a computer with the supplied USB cable. In addition, scenes cannot be written back and music files cannot be transferred to the camcorder. To avoid corrupting the data in the camcorder's memory, use the computer's Safely Remove Hardware function to end the connection and disconnect the USB cable before using the camcorder.
- To be able to write back scenes and to transfer music files to the camcorder, use the computer's Safely Remove Hardware function to end the connection, disconnect the USB cable, power the camcorder using the compact power adapter and only then connect it to the computer again.

Error writing on the memory card. Data may be recovered if the memory card has not been removed. Attempt recovering the data?

- This message will appear the next time you turn on the camcorder if power supply was accidentally interrupted while the camcorder was writing on the memory card. Select [Recover] to try to recover the recordings. If you removed the memory card and used it with another device after this happened, we recommend you select [Give Up].

File name error

- The folder and file numbers have reached their maximum value. Set   [Photo Numbering] to [Reset] and delete all the photos on the memory card ( 123) or initialize it ( 44).

Initialize only using the camcorder

- There is a problem with the file system that prevents accessing the selected memory. Initialize the memory with this camcorder ( 44).

LCD Screen has been dimmed

- Hold  pressed for 2 seconds to restore the LCD screen to its previous brightness setting.

May not be possible to record movies on this memory card

- You may not be able to record movies on a memory card without a Speed Class rating. Replace the memory card with one rated SD Speed Class 2, 4, 6 or 10.

Mem. Card Number of scenes already at maximum

- The memory card already contains the maximum number of scenes (3,999 scenes); no further scenes can be copied onto the memory card. Delete some scenes (📖 61) to free some space.

Mem. Card Unable to recognize the data

- The memory card contains scenes recorded using a video configuration that is not supported (PAL or SECAM). Play back the recordings in the memory card with the device originally used to record them.

Memory card cover is open

- After inserting a memory card, close the double memory card slot cover.

Memory card is full

- The memory card is full. Delete some recordings (📖 61, 123) to free some space or replace the memory card.

Memory card is write-protected

- The LOCK switch on the memory card is set to prevent accidental erasure. Change the position of the LOCK switch.

Need to recover files from the memory card. Change the position of the LOCK switch on the memory card.

- This message will appear the next time you turn on the camcorder if power supply was accidentally interrupted while the camcorder was writing on the memory card and later the position of the card's LOCK switch was changed to prevent erasure. Change the position of the LOCK switch.

No memory card

- Insert a compatible memory card into the camcorder (📖 41).

No photos

- There are no photos to play back. Have fun taking some photos (📖 46).

No scenes

- There are no scenes in the memory selected. Have fun shooting some video (📖 46).

HF M41/M40 Not enough available space

- Delete some recordings on the memory card (📖 61, 123) or select the [3 Mbps] bit rate for the conversion to SD.

Number of scenes already at maximum

- The maximum number of scenes (3,999 scenes) has been reached. Delete some scenes (📖 61) to free some space.

Number of stories already at maximum

- The gallery already contains the maximum number of stories (98 stories in any one given memory). Delete some stories (📖 63) or change the recording memory for movies (📖 42).

Recording program: Underwater / Surface

Turn on the camcorder while holding the zoom lever toward T or W to change the recording program .

- Follow the instructions to switch the recording program between [Underwater] and [Surface] while the camcorder is secured inside the optional WP-V3 Waterproof Case.

Scene recorded using another device. Cannot divide the scene.

- Scenes that were not recorded with this camcorder cannot be divided with this camcorder.

Scene recorded using another device. Cannot play back the scene.

- Scenes that were not recorded with this camcorder cannot be played back.

Select the desired scene number

- A number of scenes have the same recording date but different file control information. This can occur for example when you edit photos and write the files back to the camcorder. Select a number to display the corresponding group of scenes.

HF M41/M40 Some scenes could not be converted

- Some scenes selected for conversion to SD were recorded using another device. These scenes were not converted.
- Among the scenes selected for conversion to SD there are scenes recorded with another device using 24p frame rate. When converting scenes to SD, leave out scenes recorded using another devices.

Some scenes could not be deleted

- Movies that were protected/edited with other devices cannot be deleted with this camcorder.

Some scenes were recorded using another device and cannot be copied.

- Scenes that were not recorded with this camcorder cannot be copied to memory card **B**.



Task in progress. Do not disconnect the power source.

- The camcorder is updating the memory. Wait until the operation ends and do not disconnect the compact power adapter or remove the battery pack.

There are no scenes with the selected rating

- No scenes have been rated yet. Rate the scenes as you like ( 76).
- The criteria you used to select scenes by rating resulted in no applicable scenes. Change the criteria used to select scenes by rating.

This memory card contains scenes. Delete all scenes to use relay recording.

- Save your movies ( 134) if necessary, and delete all the movies from the memory card ( 61).

This photo cannot be displayed

- You may not be able to display photos taken with other devices or image files created or edited on a computer.

This scene was recorded using another device and cannot be copied.

- Scenes that were not recorded with this camcorder cannot be copied to memory card **B**.

To record video on this memory card, it is recommended to use only the XP+/SP/LP recording modes

- Movies may not be recorded correctly on this memory card if the recording mode is set to MXP or FXP mode (📖 85).

To use the wireless function, insert the Eye-Fi card into slot B.

- You may have inserted the Eye-Fi card into memory card slot **A**. Insert it into memory card slot **B**.

Too many photos. Disconnect the USB cable.

- Disconnect the USB cable. Try using a memory card reader or decrease the number of photos on the memory card to fewer than 2,500 photos (Windows), or 1,000 photos (Mac OS).
- If a dialog box appeared on the computer screen, close it. Disconnect the USB cable, and restore the connection after a short while.

HFM41/M40 Total play time is too long

- When converting scenes from a story, the maximum total playback time of the scenes to be converted is 2 hours and 30 minutes. Reduce the number of scenes to be converted to SD.

Unable to recognize the data

- You transferred data to the camcorder recorded using a video configuration that is not supported (PAL or SECAM). Play back the recordings with the device originally used to record them.

Unable to recover data

- Could not recover a corrupted file. Save your recordings (📖 134) and initialize the memory using the [Complete Initialization] option (📖 44).

Unsupported gallery data detected. Cannot record or edit. Delete gallery data?

- The gallery data of the movies in the selected memory card is not supported. The movies can be played back but you cannot edit them or record additional scenes to this gallery. Select [Yes] to delete the unsupported gallery data. Note that after doing so, you will not be able to play back the movies with the device originally used to record the unsupported gallery data.

Handling Precautions

Camcorder

Be sure to observe the following precautions to ensure maximum performance.

- **Save your recordings periodically.** Make sure to transfer your recordings to an external device such as a computer or digital video recorder (📖 131) and save them on a regular basis. This will protect your important recordings in case of damage and create more free space on the memory. Canon shall not be liable for any data loss.
- Do not carry the camcorder by the LCD panel. Be careful when closing the LCD panel. When using a wrist strap, do not allow the camcorder to swing and hit an object.
- **Handle the touch screen with care.** Do not apply excessive force and, with the exception of the supplied stylus pen, do not use ballpoint pens or other hard-tipped tools to operate the touch screen. This may damage the touch screen's surface or the pressure-sensitive layer beneath it.
- Do not attach protective film on the touch screen. The touch screen's operation is based on detecting applied pressure, so you may not be able to correctly operate the touch screen with an additional protective layer.
- Do not leave the camcorder in places subject to high temperatures (like the inside of a car parked under direct sunlight), or high humidity.
- Do not use the camcorder near strong electromagnetic fields such as above TVs, near plasma TVs or mobile phones.
- Do not point the lens or viewfinder (HFM41 only) at strong light sources. Do not leave the camcorder pointed at a bright subject.
- Do not use or store the camcorder in dusty or sandy places. The camcorder is not waterproof – avoid also water, mud or salt. If any of the above should get into the camcorder it may damage the camcorder and/or the lens.
- Be careful of heat generated by lighting equipment.
- Do not disassemble the camcorder. If the camcorder does not function properly, consult qualified service personnel.
- Handle the camcorder with care. Do not subject the camcorder to shocks or vibration as this may cause damage.

- When mounting the camcorder on a tripod, make sure that the tripod's fastening screw is shorter than 5.5 mm (0.2 in.). Using other tripods may damage the camcorder.

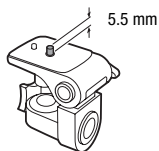

- **When recording movies, try to get a calm, stable picture.** Excessive camcorder movement while shooting and extensive use of fast zooms and panning can result in jittery scenes. In extreme cases, the playback of such scenes may result in visually induced motion sickness. If you experience such a reaction, stop the playback immediately and take a rest break as necessary.
- Do not insert the supplied stylus pen into the mouth. If swallowed, seek medical assistance immediately.
- Handle the supplied stylus pen with extreme care and keep it out of the reach of children. If mishandled, the stylus pen can present a risk of severe eye injury and even blindness.

Long-term storage

If you do not intend to use the camcorder for a long time, store it in a place free of dust, in low humidity, and at temperatures not higher than 30 °C (86 °F).

Battery Pack

DANGER!

Treat the battery pack with care.

- Keep it away from fire (or it might explode).
 - Do not expose the battery pack to temperature higher than 60 °C (140 °F). Do not leave it near a heater or inside a car in hot weather.
 - Do not try to disassemble or modify it.
 - Do not drop it or subject it to shocks.
 - Do not get it wet.
- Dirty terminals may cause a poor contact between the battery pack and the camcorder. Wipe the terminals with a soft cloth.



Long-term storage

- Store battery packs in a dry place at temperatures no higher than 30 °C (86 °F).
- To extend the battery life of the battery pack, discharge it completely before storing it.
- Charge and discharge all your battery packs fully at least once a year.

Remaining battery time

If the remaining battery time displayed is not correct, charge the battery pack fully. Still, the correct time may not be displayed after a large number of repeated uses, if a fully charged battery pack is left unused, or if a battery pack is used for long periods of time in high temperatures. Use the time shown on the screen as an approximation.

Regarding the use of non-Canon battery packs

- For your safety, battery packs that are not genuine Canon battery packs will not be charged even if you attach them to this camcorder or to the optional CG-800 Battery Charger.
- We recommend using genuine Canon battery packs bearing the Intelligent System mark.  **Intelligent Li-ion Battery**
- If you attach to the camcorder battery packs that are not genuine Canon battery packs,  will appear and the remaining battery time will not be displayed.

Memory Card

- We recommend backing up the recordings on the memory card onto your computer. Data may be corrupted or lost due to memory card defects or exposure to static electricity. Canon shall not be liable for lost or corrupted data.
- Do not touch or expose the terminals to dust or dirt.
- Do not use memory cards in places subject to strong magnetic fields.
- Do not leave memory cards in places subject to high humidity and high temperature.
- Do not disassemble, bend, drop, or subject memory cards to shocks and do not expose them to water.

- Check the direction before inserting the memory card. Forcing a memory card into the slot if it is not correctly oriented may damage the memory card or the camcorder.
- Do not attach any labels or stickers on the memory card.
- Secure Digital (SD) memory cards have a physical switch to prevent writing on the card so as to avoid the accidental erasure of the card's content. To write-protect the memory card set the switch to the LOCK position.

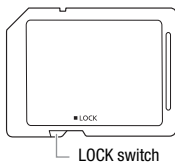

Built-in Rechargeable Lithium Battery

The camcorder has a built-in rechargeable lithium battery to keep the date/time and other settings. The built-in lithium battery is recharged while you use the camcorder; however, it will discharge completely if you do not use the camcorder for about 3 months.

To recharge the built-in lithium battery: Connect the compact power adapter to the camcorder and leave it connected for 24 hours with the camcorder off.

Lithium Button Battery

WARNING!

- The battery used in this device may present a fire or chemical burn hazard if mishandled.
 - Do not disassemble, modify, immerse in water, heat above 100 °C (212 °F) or incinerate the battery.
 - Replace with a CR2025 battery made by Panasonic, Hitachi Maxell, Sony, FDK, or with Duracell2025. Use of other batteries may present a risk of fire or explosion.
 - Do not insert the battery into the mouth. If swallowed, seek medical assistance immediately. The battery case may break and the battery fluids may cause internal injuries.
 - Keep the battery out of the reach of children.
 - Do not recharge, short-circuit or insert the battery in the wrong direction.
 - Dispose of the used battery according to applicable recycling regulations.
-
- Do not pick up the battery using tweezers or other metal tools, as this will cause a short circuit.
 - Wipe the battery with a clean dry cloth to ensure proper contact.
 - **For California, USA only:** The lithium battery included contains Perchlorate Material – special handling may apply.
See www.dtsc.ca.gov/hazardouswaste/perchlorate for details.

Disposal

When you delete movies or initialize the memory, only the file allocation table is altered and stored data is not physically erased. Take the necessary precautions when you dispose of the camcorder or memory card, for example by physically damaging it to prevent the leakage of private data.

If giving the camcorder or memory card to another person, initialize the built-in memory (**HFM41/M40** only) or memory card using the [Complete Initialization] option (📖 44). Fill it up with unimportant recordings, and then initialize it again using the same option. This makes recovering the original recordings very difficult.

Maintenance/Others

Cleaning

Camcorder Body

- Use a soft, dry cloth to clean the camcorder body. Never use chemically treated cloths or volatile solvents such as paint thinner.

Lens, Viewfinder (HFM41 only) and Instant AF

- If the lens surface or Instant AF sensor is dirty, autofocus may not work properly.
- Remove any dust or dirt particles using a non-aerosol type blower brush.
- Use a clean, soft lens-cleaning cloth to gently wipe the lens or viewfinder (HFM41 only). Never use tissue paper.

LCD Touch Screen

- Clean the LCD touch screen using a clean, soft lens-cleaning cloth.
- Condensation may form on the surface of the screen when the temperature changes suddenly. Wipe it with a soft dry cloth.

Condensation

Moving the camcorder rapidly between hot and cold temperatures may cause condensation (water droplets) to form on its internal surfaces. Stop using the camcorder if condensation is detected. Continued use may damage the camcorder.

Condensation may form in the following cases:

- When the camcorder is moved quickly from cold to warm places
- When the camcorder is left in a humid room
- When a cold room is heated rapidly

To avoid condensation

- Do not expose the camcorder to sudden or extreme changes in temperature.

- Remove the memory card and battery pack. Then, place the camcorder in an airtight plastic bag and let it adjust gradually to temperature changes before removing it from the bag.

When condensation is detected

The camcorder automatically shuts off.

The precise time required for water droplets to evaporate will vary depending on the location and weather conditions. As a general rule, wait for 2 hours before resuming use of the camcorder.

Using the Camcorder Abroad

Power Sources

You can use the compact power adapter to operate the camcorder and to charge battery packs in any country with power supply between 100 and 240 V AC, 50/60 Hz. Consult a Canon Service Center for information on plug adapters for overseas use.

Playback on a TV Screen

You can only play back your recordings on TVs compatible with the NTSC system. NTSC is used in the following regions/countries:

Americas: All of North America and Central America; most Caribbean islands (except in French territories like Guadeloupe and Martinique); most of South America (except in Argentina, Brazil and Uruguay). **Asia:** Only in Japan, the Philippines, South Korea, Taiwan and Myanmar. **Oceania:** US territories (Guam, American Samoa, etc.) and some Pacific islands like Micronesia, Samoa and Tonga.

Accessories (Availability differs from area to area)

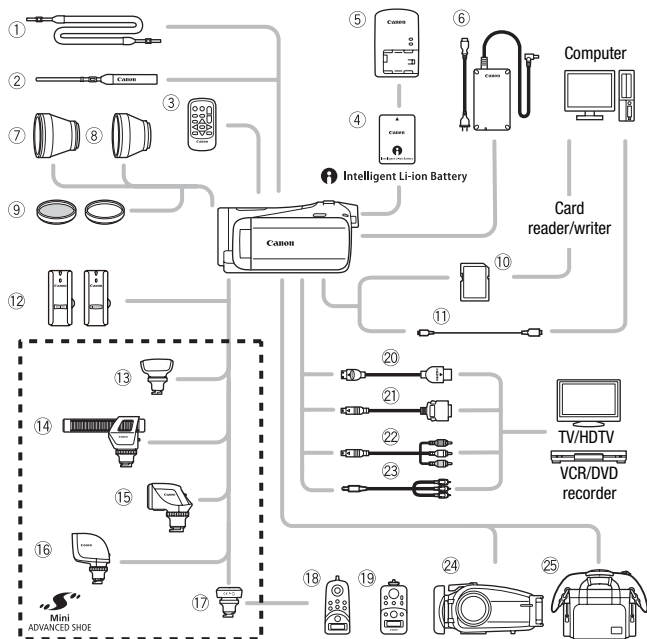

Optional accessories not listed below are described in more detail in the following pages.

- | | |
|---|------------------------------------|
| ① SS-600/SS-650 Shoulder Strap | ⑱ ZR-1000 Zoom Remote Controller |
| ② WS-20 Wrist Strap | ⑲ ZR-2000 Zoom Remote Controller |
| ③ WL-D89 Wireless Controller | ⑳ HTC-100/S* or HTC-100 HDMI Cable |
| ⑥ CA-570 Compact Power Adapter | ㉑ DTC-100 D Terminal Cable |
| ⑩ Memory card | ㉒ CTC-100 Component Cable |
| ⑪ IFC-300PCU/S* or IFC-300PCU USB Cable | ㉓ STV-250N Stereo Video Cable |

* Supplied with the camcorder; not available as an optional accessory.

i NOTES

- Accessories that are compatible with the Advanced Accessory Shoe cannot be attached to this camcorder. Look for the **Mini ADVANCED SHOE** logo to ensure compatibility with the mini advanced shoe.

Optional Accessories

Call or visit your local retailer/dealer for genuine Canon video accessories. You can also obtain genuine accessories for your Canon camcorder by calling: 1-800-828-4040, Canon U.S.A. Information Center.

Use of genuine Canon accessories is recommended.

This product is designed to achieve excellent performance when used with genuine Canon accessories. Canon shall not be liable for any damage to this product and/or accidents such as fire, etc., caused by the malfunction of non-genuine Canon accessories (e.g., a leakage and/or explosion of a battery pack). Please note that this warranty does not apply to repairs arising out of the malfunction of non-genuine Canon accessories, although you may request such repairs on a chargeable basis.

④ Battery Packs

When you need extra battery packs, select one of the following models: BP-808*, BP-809(B)*, BP-809(S)*, BP-819, or BP-827.

* Please note that the shape/color of this battery does not match the external design of the camcorder.

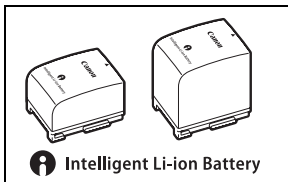

When you use battery packs bearing the Intelligent System mark, the camcorder will communicate with the battery and display the remaining usage time (accurate to 1 minute). You can only use and charge these battery packs with camcorders and chargers compatible with Intelligent System.

⑤ CG-800 Battery Charger

Use the battery charger to charge the battery packs. It plugs directly into a power outlet without a cable.

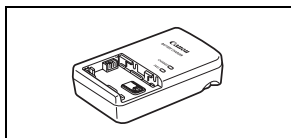

Charging, Recording and Playback Times

The charging times given in the following table are approximate and vary according to charging conditions and initial charge of the battery pack.

Battery pack→	BP-808 BP-809	BP-819	BP-827
Charging conditions↓			
Using the camcorder	150 min.	260 min.	385 min.
Using the CG-800 Battery Charger	105 min.	190 min.	260 min.

Recording and playback times given in the following tables are approximate and vary according to recording mode and charging, recording or playback conditions. The effective usage time of the battery pack may decrease when recording in cold surroundings, when using the brighter screen settings, etc.

HFM41/M40 Using the built-in memory

Battery pack	Recording mode	Recording (maximum)		Recording (typical)*		Playback
		LCD	HFM41 Viewfinder	LCD	HFM41 Viewfinder	LCD
BP-808 BP-809	MXP	120 min.	120 min.	75 min.	80 min.	185 min.
	FXP	120 min.	125 min.	75 min.	80 min.	190 min.
	XP+	125 min.	125 min.	80 min.	80 min.	190 min.
	SP	125 min.	125 min.	80 min.	80 min.	195 min.
	LP	125 min.	125 min.	80 min.	80 min.	195 min.
BP-819	MXP	240 min.	250 min.	150 min.	160 min.	375 min.
	FXP	245 min.	250 min.	150 min.	160 min.	380 min.
	XP+	255 min.	260 min.	160 min.	165 min.	385 min.
	SP	255 min.	260 min.	160 min.	165 min.	390 min.
	LP	255 min.	260 min.	160 min.	165 min.	390 min.

Battery pack	Recording mode	Recording (maximum)		Recording (typical)*		Playback
		LCD	HF M41 Viewfinder	LCD	HF M41 Viewfinder	LCD
BP-827	MXP	375 min.	380 min.	230 min.	240 min.	575 min.
	FXP	375 min.	380 min.	235 min.	240 min.	580 min.
	XP+	385 min.	390 min.	240 min.	255 min.	595 min.
	SP	385 min.	395 min.	240 min.	255 min.	600 min.
	LP	385 min.	395 min.	245 min.	255 min.	600 min.

Using a memory card

Battery pack	Recording mode	Recording (maximum)		Recording (typical)*		Playback
		LCD	HF M41 Viewfinder	LCD	HF M41 Viewfinder	LCD
BP-808 BP-809	MXP	115 min.	120 min.	70 min.	80 min.	185 min.
	FXP	120 min.	120 min.	75 min.	80 min.	185 min.
	XP+	125 min.	125 min.	80 min.	80 min.	190 min.
	SP	125 min.	125 min.	80 min.	80 min.	195 min.
	LP	125 min.	125 min.	80 min.	80 min.	195 min.
BP-819	MXP	235 min.	250 min.	145 min.	155 min.	375 min.
	FXP	240 min.	250 min.	150 min.	160 min.	375 min.
	XP+	250 min.	255 min.	160 min.	165 min.	385 min.
	SP	255 min.	260 min.	160 min.	165 min.	390 min.
	LP	255 min.	260 min.	160 min.	165 min.	390 min.
BP-827	MXP	370 min.	375 min.	230 min.	240 min.	575 min.
	FXP	375 min.	380 min.	230 min.	240 min.	580 min.
	XP+	380 min.	390 min.	240 min.	255 min.	590 min.
	SP	385 min.	395 min.	240 min.	255 min.	595 min.
	LP	385 min.	395 min.	240 min.	255 min.	600 min.

* Approximate times for recording with repeated operations such as start/stop, zooming, and power on/off.

⑦ **TL-H43 Tele-converter**

This Tele-converter lens increases the focal length of the camcorder lens by a factor of 1.5.

- The image stabilizer is not as effective when the Tele-converter is attached.
- The minimum focusing distance at full telephoto with the TL-H43 is 3.3 m (10.8 ft.).

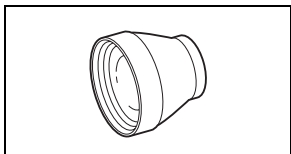

⑧ **WD-H43 Wide-converter**

This Wide-converter lens decreases the focal length by a factor of 0.7, giving you a wide perspective for indoor shots or panoramic views.

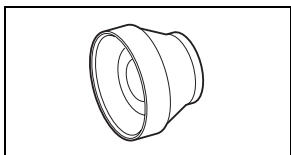

⑨ **FS-H43U II Filter Set**

Neutral density and MC protector filters help you to control difficult lighting conditions.

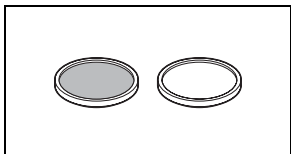

⑫ **WM-V1 Wireless Microphone**

Reliably record rich sound even when shooting subjects at a distance. The transmitter is conveniently equipped with a clothing clip and the receiver can be attached to the camcorder's grip belt.

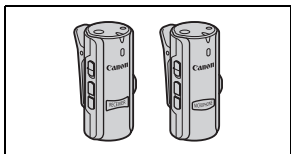

⑬ **SM-V1 Surround Microphone**

Use 5.1ch surround sound to add a sense of presence to your movies. You can link the surround sound to the zoom position or use the microphone as a highly directional shotgun microphone (monaural).

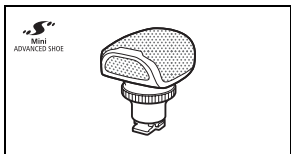

⑭ **DM-100 Directional Stereo Microphone**

This highly sensitive, super-directional microphone attaches to the camcorder's mini advanced shoe. It can be used as directional microphone (monaural) or stereo microphone.

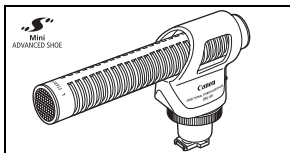

⑮ **VL-5 Video Light**

This video light enables you to record brightly in color even in dark places. It attaches to the camcorder's mini advanced shoe for cable-free operation.

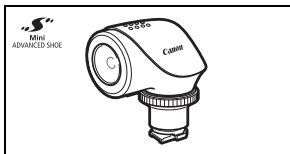

⑯ **VFL-2 Video Flash Light**

This video flash light allows you to record photos and movies even at night or in dark places. It attaches to the camcorder's mini advanced shoe for cable-free operation.

- The VFL-2 cannot be used as a flash with this camcorder.

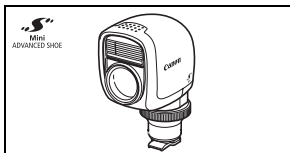

⑰ **RA-V1 Remote Control Adapter**

Attaching this adapter to the mini advanced shoe allows you to use the optional ZR-2000 or ZR-1000 Zoom Remote Controller, which is useful when operating the camcorder while it is mounted on a tripod.

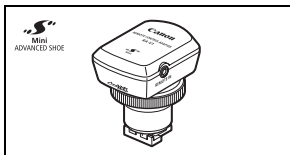

⑳ **WP-V3 Waterproof Case**

This case allows you to record movies and take photos underwater without getting the camcorder wet.

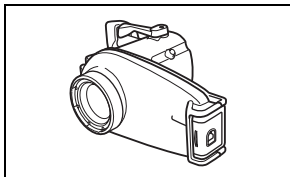

25 **SC-2000 Soft Carrying Case**

A handy camcorder bag with padded compartments and plenty of space for accessories.



This mark identifies genuine Canon video accessories. When you use Canon video equipment, we recommend Canon-brand accessories or products bearing the same mark.



Product Codes

Provided Accessories

CA-570 Compact Power Adapter	8468A002AA
BP-808 Battery Pack	2740B002AA
WL-D89 Wireless Controller	D83-0790-000
STV-250N Stereo Video Cable	3067A002AA (D82-0590-002)

Optional Accessories

BP-809 Battery Pack	2588B003AA (silver), 2588B004AA (black)
BP-819 Battery Pack	2589B002AA
BP-827 Battery Pack	3185B002AA
CG-800 Battery Charger	2590B002AA
TL-H43 Tele-converter	2071B001AA
WD-H43 Wide-converter	2072B001AA
FS-H43U II Filter Set	7150A004AA
VL-5 Video Light	3186B001AA
VFL-2 Video Flash Light	3574B001AA
WM-V1 Wireless Microphone	5068B001AA
SM-V1 Surround Microphone	4464B001AA
DM-100 Directional Stereo Microphone	2591B002AA
RA-V1 Remote Control Adapter	3924B001AA
ZR-1000 Zoom Remote Controller	3089A002AA
ZR-2000 Zoom Remote Controller	0973B002AA
WP-V3 Waterproof Case	5090B002AA
HTC-100 HDMI Cable	2384B001AA
CTC-100 Component Cable	1719B001AA
IFC-300PCU USB Cable	6906A001AA
SS-650 Shoulder Strap	3123A001AA
SS-600 Shoulder Strap	3122A001AA
WS-20 Wrist Strap	3118A002AA
SC-2000 Soft Carrying Case	9389A001AA

Specifications

VIXIA HF M41 / VIXIA HF M40 / VIXIA HF M400

◆ — Values given are approximate figures.

System

• Recording System

Movies: AVCHD Video compression: MPEG-4 AVC/H.264;
Audio compression: Dolby Digital 2ch; Dolby Digital 5.1ch*
* Only when using the optional SM-V1 Surround Microphone.

Photos: DCF (Design rule for Camera File system), compatible with Exif* Ver. 2.2
Image compression: JPEG

* This camcorder supports Exif 2.2 (also called "Exif Print"). Exif Print is a standard for enhancing the communication between camcorders and printers. By connecting to an Exif Print-compliant printer, the camcorder's image data at the time of shooting is used and optimized, yielding extremely high quality prints.

• Video Signal Configuration

1080/60i*

* Recordings made with the [PF24], [PF30] frame rate are converted and recorded on the memory as 60i.

• Recording Media

- **HF M41/M40** Built-in memory: **HF M41** 32 GB, **HF M40** 16 GB
- SD, SDHC (SD High Capacity) or SDXC (SD eXtended Capacity) memory card (not included)

• Maximum Recording Time◆

HF M41 32 GB built-in memory:

MXP mode: 2 hr. 55 min. **FXP** mode: 4 hr. 10 min. **XP+** mode: 5 hr. 45 min.
SP mode: 9 hr. 35 min. **LP** mode: 12 hr. 15 min.

HF M40 16 GB built-in memory:

MXP mode: 1 hr. 25 min. **FXP** mode: 2 hr. 5 min. **XP+** mode: 2 hr. 50 min.
SP mode: 4 hr. 45 min. **LP** mode: 6 hr. 5 min.

Commercially available 8 GB memory card:

MXP mode: 40 min. **FXP** mode: 1 hr. **XP+** mode: 1 hr. 25 min.
SP mode: 2 hr. 20 min. **LP** mode: 3 hr.

• Image Sensor

1/3-inch CMOS, 2,370,000 pixels◆

Effective pixels: 2,070,000 pixels◆

• LCD Touch Screen: 3 inch, wide, TFT color, 230,000 dots◆, touch operation

• **HF M41** Viewfinder: 0.24 inch, wide, color, equivalent to 260,000 dots◆

• Microphone: Stereo electret condenser microphone with multiple directionality settings

• Lens

f=6.1-61 mm, F/1.8-3.0, 10x optical zoom, iris aperture

35 mm equivalent: 43.6 – 436 mm◆

- **Lens Configuration:** 11 elements in 9 groups (1 double-sided aspheric element)
- **AF System**
Autofocus (TTL + external distance sensor when set to [Instant AF]) or Manual focus
- **Filter Diameter:** 43 mm
- **Minimum Focusing Distance**
1 m (3.3 ft.); 40 cm (1.3 ft.) with tele macro on at full telephoto; 1 cm (0.39 in.) at full wide angle
- **White Balance**
Auto white balance, Custom white balance or Preset white balance settings:
Daylight, Shade, Cloudy, Tungsten, Fluorescent, Fluorescent H
- **Minimum Illumination**
0.1 lx ([Low Light] recording program, Shutter speed at 1/2)
1.5 lx ([Programmed AE] recording program, Auto slow shutter [On], Shutter speed at 1/30)
- **Recommended Illumination:** More than 100 lx
- **Image Stabilization:** Optical-Shift Image Stabilizer
- **Size of Video Recordings**
MPX, FXP mode: 1920 x 1080 pixels; **XP+, SP, LP** mode: 1440 x 1080 pixels
- **Size of Photos:** 1920 x 1080 pixels

Terminals

- **AV OUT/** Terminal
 \varnothing 3.5 mm minijack; output only (dual purpose terminal also for headphones stereo output)
 Video: 1 V_{p-p} / 75 Ω unbalanced
 Audio: -10 dBV (47 k Ω load) / 3 k Ω or less
- **USB Terminal:** mini-B, USB 2.0 (Hi-Speed USB)
- **COMPONENT OUT Terminal (proprietary mini-D terminal)**
 Luminance (Y): 1 V_{p-p} / 75 Ω ; Chrominance (P_B/P_R): \pm 350 mV / 75 Ω
 1080i (D3) compatible; output only
- **HDMI OUT Terminal**
 HDMI mini connector; output only; compatible with HDMI-CEC and x.v.Color
- **MIC Terminal**
 \varnothing 3.5 mm stereo minijack
 -57 dBV (with 600 Ω microphone) / 5 k Ω or more

Power/Others

- **Power supply (rated)**
7.4 V DC (battery pack), 8.4 V DC (compact power adapter)
- **Power consumption** ♦
 2.9 W (SP mode, AF on, LCD normal brightness)
HFM41 2.8 W (SP mode, AF on, viewfinder)
 Maximum rated power consumption: 9.4 W
- **Operating temperature** ♦: 0 – 40 °C (32 – 104 °F)

- **Dimensions** ♦ [W x H x D] (excluding the grip belt)
 - HFM41** 74 x 71 x 137 mm (2.9 x 2.8 x 5.4 in.)
 - HFM40/M400** 74 x 71 x 131 mm (2.9 x 2.8 x 5.2 in.)
- **Weight** ♦ (camcorder body only)
 - HFM41** 360 g (12.7 oz.)
 - HFM40/M400** 350 g (12.3 oz.)
- **When the recording program is set to [Underwater] or [Surface]**
 - The following functions are not available: face detection (available only for [Surface]), Instant AF, auto slow shutter, manual audio recording level adjustment, microphone attenuator, zoom speed adjustment (zoom speed is faster than [Speed 3] when [Zoom Speed] is set to [Variable])
 - The following settings are adjusted: white balance, image effects
 - Minimum focusing distance from the waterproof case lens window
 - In the water: approx. 75 cm (2.5 ft.) at full telephoto; approx. 5 cm (2 in.) at full wide angle
 - In the air: approx. 1 m (3.3 ft.) at full telephoto; approx. 5 cm (2 in.) at full wide angle

CA-570 Compact Power Adapter

- **Power supply:** 100 – 240 V AC, 50/60 Hz
- **Rated output / consumption:** 8.4 V DC, 1.5 A / 29 VA (100 V) – 39 VA (240 V)
- **Operating temperature** ♦: 0 – 40 °C (32 – 104 °F)
- **Dimensions** ♦: 52 x 29 x 90 mm (2.1 x 1.1 x 3.5 in.)
- **Weight** ♦: 135 g (4.8 oz.)

BP-808 Battery Pack

- **Battery type**
Rechargeable lithium ion battery, compatible with Intelligent System
- **Rated voltage:** 7.4 V DC
- **Operating temperature** ♦: 0 – 40 °C (32 – 104 °F)
- **Battery capacity:** 890 mAh (typical); 6.3 Wh / 850 mAh (minimum)
- **Dimensions** ♦: 30.7 x 23.3 x 40.2 mm (1.2 x 0.9 x 1.6 in.)
- **Weight** ♦: 46 g (1.6 oz.)

About the music files

The specifications of the music files compatible with the camcorder are as follows.

Audio encoding: Linear PCM

Audio sampling: 48 kHz, 16 bits, 2 channels

Minimum length: 1 second

File type: WAV

The music data is saved in the memory under the following folders.

HFM41/M40 In the built-in memory:

\CANON\MY_MUSIC\MUSIC_01.WAV to MUSIC_99.WAV

On the memory card:

\CANON\PRIVATE\MY_MUSIC\MUSIC_01.WAV to
MUSIC_99.WAV

About the image files for the Image Mix function

The specifications of image files that can be used with the image mix function are as follows.

Image size: 1920x1080 pixels

File type: Baseline JPEG

Color sampling: 4:2:2 or 4:2:0

Image files are saved in the memory under the following folders.

HFM41/M40 In the built-in memory:

\CANON\MY_PICT\MIX_01.JPG to MIX_99.JPG

On the memory card:

\CANON\PRIVATE\MY_PICT\MIX_01.JPG to MIX_99.JPG

Weight and dimensions are approximate. Errors and omissions excepted.
The information in this manual is verified as of January 2011. Subject to change without notice.

Index

3D Flip View 59

A

Abroad, using the camcorder 185
AGC (automatic gain control) limit 99
Aperture (f number) 96
Aspect ratio of a connected
 TV (TV type) 153
Audio equalizer 107
Audio mix 108
Audio recording level 105
AUTO mode 46
Auto slow shutter 151
Autofocus (AF):
 Instant AF/Normal AF 151
Automatic backlight correction 99
Av (recording program) 96
AV OUT/ \square terminal 109, 126, 128
AVCHD specifications 8

B

Background music 77
Battery pack
 Battery information 159, 164
 Charging 24
 Remaining charge indicator 164
Beach (recording program) 88
Built-in backup battery 182

C

Camcorder supplemental disc 19
Capturing photos/video snapshot
 scenes from a movie 117
Chroma key 73
CINEMA mode 67
Cinema-look filters 67
COMPONENT OUT terminal 126, 128
Condensation 184
Connections to external devices 127
Copying recordings to a memory
 card 131

D

Data code 116, 153
Date and time 36
Decoration 69
Deleting
 Movies 61
 Photos 123
Dividing scenes 119

E

Edit panel 34, 148
Editing stories 81, 82
Error messages 172
External audio input 79, 108
External microphone 111
Eye-Fi card 144

F

Face detection 93
Faders 95
Fireworks (recording program) 89
Frame rate 87
FUNC. panel 34, 146

G

Gallery 61, 74

H

HD to SD conversion* 140, 143
HDMI OUT terminal 126, 127
HDMI-CEC 159
Headphones 109

I

Image effects 103
Image mix 72
Image stabilizer 90
Index screen selection 59
Initializing the memory 44

* HFM41/M40 only.

L		Recording	
Language	37	Movies	46, 67, 84
LCD screen dimmer	158	Photos	46, 84
LCD touch screen	29, 32	Recording mode	85
Low light (recording program)	88	Recording programs	87, 96
		Recording time	86
M		Relay recording	43
M (Manual) mode	84	Remote sensor	26
Maintenance	184	Resetting all camcorder settings	169
Manual exposure	98	Reviewing recordings	85
Manual focus	99		
Markers	152	S	
Memory card	39, 181	Saving recordings	131
MIC terminal	112	Transferring to a computer	134
Microphone attenuator	152, 153	Using external	
Microphone directionality	106	video recorders	138
Mini advanced shoe	110	Selecting the memory	
Mode switch	33	for playback	59
		for recording	42
N		Self timer	104
Night scene (recording program)	88	Serial number	22
Notification sounds	158	Setup menus	35, 149
		Shutter speed	96
O		Slideshow	124
Onscreen display selection	116	Smart AUTO	48
Onscreen icons	161	Snow (recording program)	88
		Sports (recording program)	88
P		Spotlight (recording program)	88
P (recording program)	96	Story Creator	65
Photo numbers	155	Sunset (recording program)	88
Playback		Surface (recording program)	89
Movies	55, 74		
Photos	121	T	
Portrait (recording program)	88	Tele macro	101
Power saving	50	Telephoto	51
Powered IS	91	Time zone/DST	37
Pre-recording	92	Timeline	115
		Touch & Track	94
Q		Touch AE	98
Quick Start	53	Touch AF	99
		Touch screen operations	32
R		Tripod	180
Rating scenes	48, 76	Troubleshooting	165
		Tv (recording program)	96

U

Underwater (recording program) . . .	89
Uploading movies to video sharing	
Web sites	139
USB terminal	126, 129, 138

V

Video snapshot	68
Viewfinder**	31
Volume	57

W

White balance	102
Wide angle	51
Wind screen	152
Wireless controller	26

Z

Zoom	51
Digital zoom	151
Zoom speed	51, 149

** **HF M41** only.

CANON CONSUMER DIGITAL VIDEO EQUIPMENT LIMITED WARRANTY FOR THE UNITED STATES

The limited warranty set forth below is given by Canon U.S.A., Inc. ("Canon USA") with respect to Canon Consumer Digital Video Equipment (the "Equipment") purchased in the United States. This limited warranty is only effective upon presentation of your Bill of Sale or other proof of purchase.

The Equipment is warranted under normal, non-commercial, personal use, against defective materials or workmanship as follows:

Parts: Defective parts will be exchanged for new parts or comparable rebuilt parts for a period of ONE YEAR from the date of original purchase, except for a defective Video Head, which will be exchanged for a period of three months from the date of purchase.

Labor: For a period of ONE YEAR from the date of original purchase, labor will be provided free of charge by our factory service centers or designated service facilities located in the United States.

When returning Equipment under this warranty, you must pre-pay the shipping charges, and you must enclose the Bill of Sale or other proof of purchase with a complete explanation of the problem. During the ONE-YEAR warranty period, repairs will be made and the Equipment will be return-shipped to you free of charge. For repairs after the warranty period is over, you will be given an estimate of the cost of repair and an opportunity to approve or disapprove of the repair expense before it is incurred. If you approve, repairs will be made and the Equipment will be return-shipped to you. (shipping charges apply). If you disapprove, we will return-ship the equipment at no charge to you.

Non-Canon brand peripheral equipment and software which may be distributed with, or factory loaded on, the Equipment, are sold "AS IS" without warranty of any kind by Canon USA, including any implied warranty regarding merchantability or fitness for a particular purpose. The sole warranty with respect to such non-Canon brand items is given by the manufacturer or producer thereof. If the Equipment contains a hard disk drive, Canon USA recommends that data stored on that drive be duplicated or backed up to prevent its loss in the event of failure or other malfunction of such drive.

Canon USA shall have no responsibility under this limited warranty for use of the Equipment in conjunction with incompatible peripheral equipment and incompatible software.

In order to obtain warranty service, contact the authorized Canon retail dealer from whom you purchased the Equipment or call the CANON INFORMATION CENTER AT 1-800-OK-CANON). You will be directed to the nearest service facility for your Equipment.

This Limited Warranty covers all defects encountered in normal use of the Equipment and does not apply in the following cases:

- A) Loss or damage to the Equipment due to abuse, mishandling, accident, improper maintenance, or failure to follow operating instructions;
- B) If the Equipment is defective as a result of leaking batteries, sand, dirt or water damage;
- C) If defects or damages are caused by the use of unauthorized parts or by service other than by Canon USA's factory service centers or authorized service facilities;
- D) If the Equipment is used for commercial or industrial use.

This Limited Warranty does not cover cabinet (exterior finish), video cassette tape, head cleanings, nor does it apply to Equipment purchased outside the United States. This warranty does not cover units sold to rental firms, military operations, hotels, schools, hospitals or for other commercial, industrial, or institutional applications.

These uses are covered only by such specific warranty as Canon may issue with such sales.

This Limited Warranty does not apply to accessories or consumables for the Equipment, which are sold "AS IS", without warranty of any kind by Canon USA.

Please retain this warranty card and your Bill of Sale as a permanent record of your purchase. This card is most important in order to be sure you are contacted right away should there be a safety inspection, modification or product recall under applicable laws or regulations.

NO IMPLIED WARRANTY, INCLUDING MERCHANTABILITY AND FITNESS FOR A PARTICULAR PURPOSE APPLIES TO THIS EQUIPMENT AFTER THE APPLICABLE PERIOD OF EXPRESS WARRANTY OR GUARANTY, EXCEPT AS MENTIONED ABOVE, GIVEN BY ANY PERSON, FIRM OR CORPORATION WITH RESPECT TO THIS EQUIPMENT SHALL BIND THE UNDERSIGNED (SOME STATES DO NOT ALLOW LIMITATIONS ON HOW LONG AN IMPLIED WARRANTY LASTS, SO THE ABOVE LIMITATION OR EXCLUSION MAY NOT APPLY TO YOU). CANON USA SHALL NOT BE LIABLE FOR LOSS OF REVENUES OR PROFITS, EXPENSE FOR SUBSTITUTE EQUIPMENT OR SERVICE, STORAGE CHARGES,

LOSS OR CORRUPTION OF DATA, INCLUDING WITHOUT LIMITATION, LOSS OR CORRUPTION OF DATA STORED ON THE EQUIPMENT'S HARD DRIVE, OR ANY OTHER SPECIAL, INCIDENTAL OR CONSEQUENTIAL DAMAGES CAUSED BY THE USE, MISUSE OR INABILITY TO USE THE EQUIPMENT, REGARDLESS OF THE LEGAL THEORY ON WHICH THE CLAIM IS BASED, AND EVEN IF CANON USA HAS BEEN ADVISED OF THE POSSIBILITY OF SUCH DAMAGES. NOR SHALL RECOVERY OF ANY KIND AGAINST CANON USA BE GREATER THAN THE PURCHASE PRICE OF THE EQUIPMENT SOLD BY CANON USA AND CAUSING THE ALLEGED DAMAGE. WITHOUT LIMITING THE FOREGOING, YOU ASSUME ALL RISK AND LIABILITY FOR LOSS, DAMAGE OR INJURY TO YOU AND YOUR PROPERTY AND TO OTHERS AND THEIR PROPERTY ARISING OUT OF USE, MISUSE OR INABILITY TO USE THE EQUIPMENT NOT CAUSED DIRECTLY BY THE NEGLIGENCE OF CANON USA. (SOME STATES DO NOT ALLOW THE EXCLUSION OR LIMITATION OF INCIDENTAL OR CONSEQUENTIAL DAMAGES, SO THE ABOVE LIMITATION MAY NOT APPLY TO YOU). THIS WARRANTY SHALL NOT EXTEND TO ANYONE OTHER THAN THE ORIGINAL PURCHASER OF THIS EQUIPMENT OR THE PERSON FOR WHOM IT WAS PURCHASED AS A GIFT.

This warranty gives you specific legal rights, and you may also have other rights which vary from state to state. CANON U.S.A., INC.

CANON CONSUMER DIGITAL VIDEO EQUIPMENT LIMITED WARRANTY

The limited warranty set forth below is given by Canon Canada Inc. ("Canon Canada") with respect to Canon Consumer Digital Video Equipment (the "Equipment") purchased in Canada. This limited warranty is only effective upon presentation of a bill of sale or other proof of purchase for this Equipment to a Canon Service Facility when repairs are required. The Equipment is warranted under normal, non-commercial, personal use, against defective materials or workmanship as follows:

Parts: Defective parts will be exchanged for new parts or, at Canon Canada's option, comparable rebuilt parts for a period of one year from the date of original purchase, except Video Heads which will be exchanged for a period of 3 months from the date of purchase.

Labour: For a period of one year from the date of original purchase, labour will be provided free of charge by our Canon Service Facilities in Canada.

This limited warranty covers all defects except where:

(a) The loss or damage to the product results from:

- i) accident, natural disaster, mishandling, abuse, neglect, unauthorized product modification or failure to follow instructions contained in the instruction manual;
- ii) the use of accessories, attachments, products, supplies, parts or devices with the Equipment that do not conform to Canon specifications or that cause abnormally frequent service problems;
- iii) repairs or services performed by any party other than a Canon Service Facility;
- iv) defective batteries or any exposure to water, sand or dirt;
- v) shipping (claim must be presented to the shipper);

(b) Any serial number on the video equipment is altered or removed.

(c) The Equipment is used for commercial, professional or industrial purposes.

This limited warranty does not cover the cabinet (exterior finish) of the Equipment, media, nor does it apply to Equipment purchased outside Canada.

If the Equipment contains a hard disk drive, Canon Canada recommends that data stored on that drive be duplicated or backed up to prevent its loss in the event of a failure or other malfunction of such drive.

TO OBTAIN WARRANTY SERVICE

Ship your Equipment in its original carton, box or equivalent, properly packed, fully insured with shipping charges prepaid, together with a copy of your bill of sale or other proof of purchase and a description of the problem to any of the Canon Service Facilities in Canada.

LIMITATIONS

Except as otherwise required by applicable legislation, this warranty is in lieu of all other warranties, conditions, guarantees or representations, express or implied, statutory or otherwise, relative to the Equipment, including implied warranties or conditions of merchantability or fitness for a particular purpose.

Canon Canada assumes no liability for special, consequential or incidental damages, loss or corruption of data including, without limitation, data stored on the hard disk drive of the Equipment or loss that may arise, whether on account of negligence or otherwise, from the use, misuse or inability to use the Equipment (including loss of profit, revenue, media or enjoyment) or from failure to conform to any express or implied warranties, conditions, guarantees or representations. Any recovery under this limited warranty shall not exceed the purchase price of the equipment. Canon Canada does not assume or authorize any other person to assume for Canon Canada any other liability with respect to this equipment.

This warranty does not extend to any person other than the original purchaser of the Equipment or the person for whom it was purchased as a gift and states your exclusive remedy.

NOTICE TO CONSUMER

If you plan to take important videos or if the product has not been used for some time, please check all functions with the instruction book before using it.

Canon

USA

CANON U.S.A., INC. NEW JERSEY OFFICE

100 Jamesburg Road, Jamesburg, NJ 08831 USA

CANON U.S.A., INC. CHICAGO OFFICE

100 Park Blvd., Itasca, IL 60143 USA

CANON U.S.A., INC. LOS ANGELES OFFICE

15955 Alton Parkway, Irvine, CA 92618 USA

CANON U.S.A., INC. HONOLULU OFFICE

210 Ward Avenue, Suite 200, Honolulu, HI 96814 USA

- ❖ If you have any questions, call the Canon U.S.A. Information Center toll-free at 1-800-828-4040 (USA only).
-

CANADA

CANON CANADA INC.

6390 Dixie Road, Mississauga, ON L5T 1P7

- ❖ If you have any questions, call the Canon Canada Information Center toll free (in Canada only) at 1-800-OK-CANON (1-800-652-2666).
 - ❖ Si vous avez des questions, veuillez téléphoner 1-800-OK-CANON (1-800-652-2666, sans frais au Canada seulement).
-

MÉXICO

CANON MEXICANA, S DE RL DE CV

Blvd. Manuel Ávila Camacho No. 138, Piso 17

Col. Lomas de Chapultepec, C.P. 11000 México, D.F., México

CANON U.S.A., INC. NEW JERSEY OFFICE

100 Jamesburg Road, Jamesburg, NJ 08831 USA

CENTRO Y SURAMÉRICA

CANON LATIN AMERICA, INC.

703 Waterford Way, Suite 400, Miami, FL 33126 USA

ASIA

CANON HONGKONG COMPANY LTD.

19/F, The Metropolis Tower, 10 Metropolis Drive,

Hunghom, Kowloon, Hong Kong

Tel: +852 3191 2333, Fax: +852 2428 3963

For support concerning the supplied PIXELA's software, please call PIXELA customer support (see the back cover of the Installation Guide for PIXELA's software).