



Getting Started

Digi 002[®] & Digi 002 Rack[™]

Version 7.0



Copyright

© 2005 Digidesign, a division of Avid Technology, Inc. All rights reserved. This guide may not be duplicated in whole or in part without the express written consent of Digidesign.

Avid, Digidesign, Digi 002, Digi 002 Rack, and Pro Tools are either trademarks or registered trademarks of Avid Technology, Inc. in the US and other countries. All other trademarks contained herein are the property of their respective owners.

Product features, specifications, system requirements, and availability are subject to change without notice.

PN 9106-17747-00 REV A 11/05

Communications & Safety Regulation Information

Compliance Statement

The model Digi 002 complies with the following standards regulating interference and EMC:

- FCC Part 15 Class B
- EN55022
- EN55024
- AS/NZS 3548 Class B
- CISPR 22 Class B

Radio and Television Interference

This equipment has been tested and found to comply with the limits for a Class B digital device, pursuant to Part 15 of the FCC Rules.

DECLARATION OF CONFORMITY

We Digidesign,

3401-A Hillview Avenue

Palo Alto, California 94304-1348, USA

650-842-7900

declare under our sole responsibility that the product

Digi 002

complies with Part 15 of FCC Rules.

Operation is subject to the following two conditions: (1) this device may not cause harmful interference, and (2) this device must accept any interference received, including interference that may cause undesired operation.

NOTE: This equipment has been tested and found to comply with the limits for a Class B digital device, pursuant to Part 15 of the FCC Rules. These limits are designed to provide reasonable protection against harmful interference in a residential installation. This equipment generates, uses, and can radiate radio frequency energy and, if not installed and used in accordance with the instructions, may cause harmful interference to radio communications. However, there is no guarantee that interference will not occur in a particular installation. If this equipment does cause harmful interference to radio or television reception, which can be determined by turning the equipment off and on, the user is encouraged to try and correct the interference by one or more of the following measures:

- Reorient or locate the receiving antenna.
- Increase the separation between the equipment and receiver.
- Connect the equipment into an outlet on a circuit different from that to which the receiver is connected.
- Consult the dealer or an experienced radio/TV technician for help.

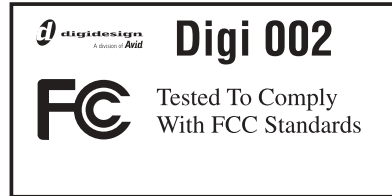

Any modifications to the unit, unless expressly approved by Digidesign, could void the user's authority to operate the equipment.

Canadian Compliance Statement:

This Class B digital apparatus complies with Canadian ICES-003

Cet appareil numérique de la classe B est conforme à la norme NMB-003 du Canada

Australian Compliance

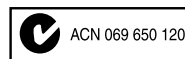

European Compliance



Safety Statement

This equipment has been tested to comply with USA and Canadian safety certification in accordance with the specification of UL Standards : UL1419 and Canadian CAN C22.2NO.1-98, IEC60950. Digidesign Inc., has been authorized to apply the appropriate UL & CUL mark on its compliant equipment.

Warning!



Important Safety Instructions

When using electric or electronic equipment, basic precautions should always be followed, including the following:

- Read all instructions before using this equipment.
- To avoid the risk of shock, keep this equipment away from rain water, and other moisture. Do not use this equipment if it is wet.
- The equipment should only be connected to the correct rating power supply as indicated on the product.
- Do not attempt to service the equipment. There are no user-serviceable parts inside. Please refer all servicing to authorized Digidesign personnel.
- Any attempt to service the equipment will expose you to a risk of electric shock, and will void the manufacturer's warranty.
- The product should be connected only to the correct power supply as indicated on the product.
- Do not block any ventilation openings. Install in accordance with the manufacture's instructions.
- Do not install near any heat sources such as radiators, heat registers, stoves, or other apparatus (including amplifiers) that produce heat.
- Do not defeat the safety purpose of the polarized or grounding-type plug. A polarized plug has two blades with one wider than other, A grounding type plug has two blades and a third grounding prong. The wide blade or the third prong are provided for your safety. If the provided plug does not fit into your outlet, consult an electrician for replacement of the obsolete outlet.
- Protect the power cord from being walked on or pinched particularly at plugs, convenience receptacles, and the point where they exit from the apparatus.
- Only use attachments/accessories specified by the manufacturer.
- Clean only with dry cloth.



This symbol on the product or its packaging indicates that this product must not be disposed of with other waste. Instead, it is your responsibility to dispose of your waste equipment by handing it over to a designated collection point for the recycling of waste electrical and electronic equipment. The separate collection and recycling of your waste equipment at the time of disposal will help conserve natural resources and ensure that it is recycled in a manner that protects human health and the environment. For more information about where you can drop off your waste equipment for recycling, please contact your local city recycling office or the dealer from whom you purchased the product.

contents

Chapter 1. Welcome to Digi 002 and Digi 002 Rack	1
Digi 002 and Digi 002 Rack Packages	1
Digi 002 and Digi 002 Rack Features	1
Pro Tools LE Capabilities	3
System Requirements	3
Digidesign Registration	5
About the Pro Tools Guides	5
About www.digidesign.com	6
Chapter 2. Windows Configuration	7
Installation Overview	7
Testing Digi 002	7
Windows System Optimization	8
Hard Drive Configuration and Maintenance	11
Connecting Digi 002 or Digi 002 Rack to the Computer	12
Connecting FireWire Drives	13
Powering On the Digi 002 or Digi 002 Rack	14
Installing Pro Tools LE	14
Optional Software on the Pro Tools Installer CD	15
Removing Pro Tools LE	16

Chapter 3. Macintosh Configuration	17
Installation Overview.	17
Testing Digi 002.	17
Macintosh System Optimization.	18
Hard Drive Configuration and Maintenance.	19
Installing Pro Tools LE.	20
Optional Software on the Pro Tools Installer CD.	20
Connecting Digi 002 or Digi 002 Rack to the Computer.	21
Connecting FireWire Drives.	21
Powering On the Digi 002 or Digi 002 Rack.	22
Removing Pro Tools LE.	22
Chapter 4. Launching and Configuring Pro Tools LE	23
Launching Pro Tools LE.	23
Configuring Pro Tools LE.	23
Chapter 5. Digi 002 Top Panel	29
Digi 002 Operating Modes.	29
The Digi 002 Top Panel.	30
Fader Section.	32
Console/Channel View Section.	35
Transport and Navigation Controls.	38
Mic/Line/Instrument Input Controls.	40
Monitor Section.	40
Keyboard Modifier Switches.	41
Status Indicators and Display Controls.	42
Chapter 6. The Digi 002 Rack Front Panel	45
Mic/Line/Instrument Input Controls.	46
Monitor Controls.	46
Status Indicators.	47

Chapter 7. Digi 002 and Digi 002 Rack Back Panels	49
Chapter 8. Connecting Your Studio	55
Connecting Digi 002 or Digi 002 Rack to a Computer	55
Monitoring Audio	58
Connecting Audio Sources to Digi 002 or Digi 002 Rack	59
Using External Effects Devices	61
Monitoring and Recording from Alternate Sources	62
Mirroring the Main Outputs	63
Connecting a Recorder for Mixdowns	64
MIDI Connections	65
Chapter 9. Working with Pro Tools LE	67
Session Basics	67
Transport Controls	73
Tracks	74
Region List	77
Navigating in a Session	78
Importing Data into Pro Tools Sessions	81
Basic Recording	83
Editing	90
Mixing	93
Plug-Ins	96
Mix Automation	97
Final Mixdown	97
Chapter 10. Using Digi 002 as a Stand-Alone Mixer	99
Overview	100
Entering Stand-Alone Mode	102
Digital Audio Connections in Stand-Alone Mode	102
Views in Stand-Alone Mode	104
Working with Effects	110
Working with Sends	112
Storing Snapshots	114

Appendix A. Configuring MIDI Studio Setup (Windows Only)	115
MIDI Studio Setup	115
MIDI Patch Name Support	117
Appendix B. Configuring AMS (Mac OS X Only)	119
Audio MIDI Setup	119
Patch Name Support	122
Appendix C. Digi 002 Stand-Alone Block Diagram	123
Appendix D. Troubleshooting	127
Backing Up Your Work	127
Common Issues	127
Performance Factors	128
Before You Call Digidesign Technical Support	128
Index	131

chapter 1

Welcome to Digi 002 and Digi 002 Rack

Welcome to Digi 002 and Digi 002 Rack, Digi-design's cross-platform Pro Tools workstations for music, sound design, and multimedia production.

Digi 002 and Digi 002 Rack Packages

The Digi 002 and Digi 002 Rack packages include the following:

- Digi 002 or Digi 002 Rack unit
- Installer CD-ROMs containing Pro Tools LE software, DigiRack RTAS (Real-Time Audio-Suite) and AudioSuite plug-ins, and electronic PDF guides
- This *Digi 002 & Digi 002 Rack Getting Started Guide*, covering installation, configuration, and basic tutorials for Digi 002 and Digi 002 Rack
- The *Digi 002 & Digi 002 Rack Basics Guide*, designed to give new users specific methods for accomplishing common tasks (such as getting sound in and out of your unit, connecting a mic or instrument, and recording a session)
- FireWire cable for connecting the Digi 002 or Digi 002 Rack to a computer
- AC power cable
- Digidesign Registration card

Digi 002 and Digi 002 Rack Features

Audio and MIDI Features

(Digi 002 and Digi 002 Rack)

The Digi 002 and Digi 002 Rack units provide the following input and output capacity:

- 8 analog audio inputs (4 with mic preamps), with A/D converters supporting up to 24-bit, 96 kHz audio
- 48V phantom power on mic preamps, switchable in channel pairs
- -10 dBV input pair for direct monitoring of tape or CD input sources
- Eight analog audio outputs, with D/A converters supporting up to 24-bit, 96 kHz audio
 - Monitor Output pair (+4 dBu) mirrors Main Outputs 1–2 with dedicated volume control for direct connection to powered speakers
 - Alternate Main Output pair (-10 dBV) mirrors Main Outputs 1–2 for direct output to -10 dBV devices.
- Stereo headphone output with level control
- Optical connectors for 8 channels of ADAT I/O (up to 48 kHz) or 2 channels of Optical S/PDIF I/O (up to 96 kHz)

- RCA connectors for 2 channels of S/PDIF digital I/O supporting up to 24-bit, 96 kHz audio
- 1 MIDI In port and 2 MIDI Out ports, providing up to 16 channels of MIDI input and up to 32 channels of MIDI output
- Footswitch jack for punching in and out while recording

Control Surface Features

(Digi 002 Only)

Digi 002 provides an integrated control surface for software control that includes the following:

- Eight touch-sensitive moving faders and dedicated solo, mute and channel select/record arm controls
- Eight multi-function rotary encoders for operating pan, send, and plug-in controls
- Transport and navigation controls
- Ten scribble strips for channel information display

Stand-Alone Mixing Features

(Digi 002 Only)

Digi 002 can be used as a stand-alone 8-channel digital mixer with the following features:

- 8 analog inputs (4 with mic preamps), with dedicated volume, pan, solo and mute controls
- Dedicated three-band EQ available on input channels 1–8
- Dedicated Compressor/Limiter available on input channels 1–4
- Built-in high-quality Reverb and Delay
- Four sends on each input channel:
 - Sends 1–2 dedicated to internal Delay and Reverb effects
 - Sends 3–4 for integrating external effects
- Stereo outputs with dedicated Master Fader controls, including:
 - Main Output pair (+4 dBu fixed signal)
 - Monitor Output pair (+4 dBu) mirrors Main Outputs 1–2 with dedicated volume control for direct connection to powered speakers
 - Alternate Main Output pair (–10 dBV) mirrors Main Outputs 1–2 for direct output to –10 dBV devices
- Stereo headphone output with level control
- Ten scribble strips for pan/volume and effects control, send levels, and track names
- Channel metering available using rotary encoder LED rings (in Meter mode)

Pro Tools LE Capabilities

Pro Tools LE 7.0 on Windows or Macintosh provides the following capabilities with Digi 002 and Digi 002 Rack:

- Record and play back up to 32 mono digital audio tracks, depending on your computer's capabilities
- Up to 128 audio tracks (with 32 voiceable tracks maximum), 128 Auxiliary Input tracks, 64 Master Fader tracks, 256 MIDI tracks, and 32 Instrument tracks per session
- 16-bit or 24-bit audio resolution, at sample rates up to 96 kHz
- Non-destructive, random-access editing and mix automation
- Audio processing with up to 5 RTAS plug-ins per track, depending on your computer's capabilities
- Up to 5 inserts per track
- Up to 10 sends per track
- Up to 32 internal mix busses

⚠ *Pro Tools LE uses your computer's CPU to mix and process audio tracks (host processing). Computers with faster clock speeds yield higher track counts and more plug-in processing.*

System Requirements

Digi 002 and Digi 002 Rack can be used with a Digidesign-qualified Windows or Macintosh computer running Pro Tools LE software.

For complete system requirements, visit the compatibility page of the Digidesign Web site (www.digidesign.com/compato).

Compatibility Information

Digidesign can only assure compatibility and provide support for hardware and software it has tested and approved.

For a list of Digidesign-qualified computers, operating systems, hard drives, and third-party devices, refer to the latest compatibility information on the Digidesign Web site (www.digidesign.com/compato).

MIDI Requirements

Digi 002 and Digi 002 Rack include one MIDI In port and two MIDI Out ports, providing 16 channels of MIDI input and 32 channels of MIDI output.

If you require additional MIDI ports, add a MIDI interface to your system.

USB MIDI interfaces work effectively with Pro Tools systems on Windows or Macintosh. Serial MIDI interfaces are supported on Windows systems only.

⚠ *Only USB MIDI interfaces are compatible with Pro Tools systems for Mac OS X. Modem-to-serial port adapters and serial MIDI devices are not supported.*

For a list of supported adapters, refer to the Digidesign Web site (www.digidesign.com).

Hard Drive Requirements

For a list of qualified hard drives, see our Web site (www.digidesign.com/compato).

If you are using an ATA/IDE or FireWire hard drive, initialize your drive with Windows Disk Management (Windows) or the Disk Utility application included with Apple System software (Macintosh).

Avoid Recording to the System Drive

Recording to your system drive is not recommended. Recording and playback on a system drive may result in lower track counts and fewer plug-ins.

⚠ *Digidesign does not recommend recording to the system drive. Record to a system drive only when necessary.*

Hard Disk Storage Space

Mono audio tracks recorded with 16-bit resolution at 44.1 kHz (CD-quality) require approximately 5 MB of hard disk space per minute. The same tracks recorded with 24-bit resolution require about 7.5 MB per minute.

Recording at higher sample rates (88.2 kHz or 96 kHz) requires about twice the hard disk space.

Table 2 lists the required disk space for certain track numbers and track lengths, to help you estimate your hard disk usage.

Table 2. Required hard drive space for audio tracks

Number of tracks and length	16-bit at 44.1 kHz	16-bit at 48 kHz	24-bit at 44.1 kHz	24-bit at 48 kHz	16-bit at 88.2 kHz	16-bit at 96 kHz	24-bit at 88.2 kHz	24-bit at 96 kHz
1 mono track 1 minute	5 MB	5.5 MB	7.5 MB	8.2 MB	10 MB	11 MB	15 MB	16.4 MB
1 stereo track 5 minutes	50 MB	55 MB	75 MB	83 MB	100 MB	110 MB	150 MB	164 MB
1 stereo track 60 minutes	600 MB	662 MB	900 MB	991 MB	1.2 GB	1.3 GB	1.8 GB	2 GB
32 mono tracks 5 minutes	800 MB	883 MB	1.2 GB	1.4 GB	1.6 GB	1.8 GB	2.4 GB	2.8 GB
32 mono tracks 60 minutes	9.4 GB	10.4 GB	14 GB	15.5 GB	18.8 GB	20.8 GB	28 GB	31 GB

Digidesign Registration

Review the enclosed registration information card and follow the instructions on it to quickly register your purchase online. Registering your purchase is the only way you can be eligible to receive complimentary technical support and future upgrade offers. It is one of the most important steps you can take as a new user.

About the Pro Tools Guides

This *Getting Started with Digi 002 & Digi 002 Rack Guide* explains how to install and use Digi 002 or Digi 002 Rack to record, edit, and mix audio and MIDI tracks in Pro Tools LE.

If you are new to working with digital workstations, it is recommended that you read the following:

- *Digi 002 and Digi 002 Rack Basics Guide* provides simple steps for how to get sound in and out of your Digi 002 or Digi 002 Rack, connect a microphone or instrument, record to a Pro Tools session, import audio from a CD, create an audio CD from a Pro Tools session, and other topics.

For additional information, see the following online guides:

- *Pro Tools Reference Guide* explains Pro Tools LE software in detail.
- *Pro Tools Menus Guide* covers all the Pro Tools on-screen menus.
- *DigiRack Plug-Ins Guide* explains how to use the RTAS and AudioSuite plug-ins included with Pro Tools LE.
- *Digidesign Plug-Ins Guide* explains how to use optional Digidesign plug-ins.
- *DigiBase Guide* provides details on using Pro Tools DigiBase databasing and browsers for data and media management.
- *Pro Tools Keyboard Shortcuts* lists keyboard shortcuts for Pro Tools LE.

PDF versions of the Pro Tools guides are installed automatically with Pro Tools, and are accessible from the Pro Tools Help menu. To view or print the PDF guides, you can use Adobe Reader or Apple Preview.



Printed copies of the Pro Tools Reference Guide and other guides in the Pro Tools guide set can be purchased separately from the DigiStore (www.digidesign.com).

Conventions Used in This Guide

Digidesign guides use the following conventions to indicate menu choices and key commands:

Convention	Action
File > Save	Choose Save from the File menu
Control+N	Hold down the Control key and press the <i>N</i> key
Control-click	Hold down the Control key and click the mouse button
Right-click (Windows)	Click with the right mouse button

The following symbols are used to highlight important information:

 *User Tips are helpful hints for getting the most from your system.*

 *Important Notices include information that could affect your data or the performance of your system.*

 *Shortcuts show you useful keyboard or mouse shortcuts.*

 *Cross References point to related sections in other Digidesign guides.*

About www.digidesign.com

The Digidesign Web site (www.digidesign.com) is your best source for information to help you get the most out of your Pro Tools system. The following are just a few of the services and features available.

Registration Register your purchase online. See the enclosed registration form for instructions.

Support Contact Digidesign Technical Support or Customer Service; download software updates and the latest online manuals; browse the Compatibility documents for system requirements; search the online Answerbase; join the worldwide Pro Tools community on the Digidesign User Conference.

Training and Education Become a certified Pro Tools Operator or Expert; study on your own using courses available online, or find out how you can learn in a classroom setting at a certified Pro Tools Training Center.

Products and Developers Learn about Digidesign products; download demo software; learn about our Development Partners and their plug-ins, applications, and hardware.

News and Events Get the latest news from Digidesign; sign up for a Pro Tools demo.

To learn more about these and other resources available from Digidesign, visit the Digidesign Web site (www.digidesign.com).

Windows Configuration

This chapter contains information for Windows systems only. If you are installing Pro Tools on a Macintosh computer, see Chapter 3, “Macintosh Configuration.”

⚠ *Before installing this version of Pro Tools, refer to the Read Me information included on the Pro Tools LE Installer CD.*

Installation Overview

Installing the Digi 002 or Digi 002 Rack on a Windows computer includes the following steps:

- 1 “Testing Digi 002” on page 7.
- 2 “Windows System Optimization” on page 8.
- 3 “Connecting Digi 002 or Digi 002 Rack to the Computer” on page 12.

⚠ *When connecting Digi 002 to your computer the first time, your computer should be off. If your computer is on, power it down.*

- 4 “Installing Pro Tools LE” on page 14.
- 5 Launching Pro Tools LE. (See Chapter 4, “Launching and Configuring Pro Tools LE.”.)
- 6 Making audio and MIDI connections to the Digi 002 or Digi 002 Rack. (See Chapter 8, “Connecting Your Studio.”)

Testing Digi 002

(Digi 002 Only)

Before you install Pro Tools LE software or connect Digi 002 to your computer for the first time, you should power up the unit to be sure it is working correctly.

⚠ *When connecting Digi 002 to your computer the first time, your computer should be off. If your computer is on, power it down.*

To set up and test the Digi 002:

- 1 Plug the Digi 002 into a standard AC receptacle, using the AC power cable included with the unit.

Digi 002 is auto power-selecting (100V to 240V) and will work automatically when plugged into an AC power receptacle in any country.

- 2 Power on the Digi 002 unit by turning on the power switch on the back panel. After a short power-up sequence, the Channel Scribble Strips on the unit show “Digi 002 Standby,” and the Standalone switch flashes to indicate Standby mode.
- 3 Press the Standalone switch in the upper right of the top panel of Digi 002. The Channel Scribble Strips on the unit will show “Enter Standalone Mode?”

4 Press the Channel Select switch under “Yes” to enter Stand-alone mode. The Channel Scribble Strips on the unit will show the default names of the channel inputs, “In1” through “In8.”

5 To return Digi 002 to Standby mode, press the Standalone switch a second time. The Channel Scribble Strips on the unit will show “Exit Standalone Mode?”

6 Press the Channel Select switch under “Yes” to return to Standby mode.

7 Power down the unit.

Windows System Optimization

Before configuring your computer, make sure you are logged in as an Administrator for the account where you want to install Pro Tools. For details on Administrator privileges, refer to your Windows documentation.

Required Optimizations

To ensure optimum performance with Pro Tools LE, configure the following settings before you install Pro Tools hardware and software.

 *When you are finished changing Windows system settings, restart your computer.*

Enabling DMA

Enabling your computer's DMA (Direct Memory Access) frees up CPU bandwidth so your computer can do other Pro Tools tasks.

In most cases the DMA option will already be set correctly, as Windows XP detects and activates DMA mode by default.

To enable DMA for any IDE hard drives:

- 1 Choose Start > Control Panel.
- 2 In Classic View, launch System.
- 3 Click the Hardware tab.
- 4 Under Device Manager, choose Device Manager.
- 5 In the Device Manager window, double-click IDE ATA/ATAPI controllers, then double-click the Primary IDE Channel for your IDE hard drive.
- 6 Click the Advanced Settings tab.
- 7 For each device, set the Transfer Mode to “DMA if available,” and click OK.
- 8 Repeat steps 5–7 for any additional IDE Channels.
- 9 Close the Computer Management window.

Disabling System Standby and Power Management

When using Pro Tools, the Windows System Standby power scheme must be set to Always On. This helps prevent long record or playback passes from stopping due to system resources powering down.

To configure Windows Power Management:

- 1 Choose Start > Control Panel.
- 2 Double-click Power Options.
- 3 Click the Power Schemes tab.
- 4 From the Power Schemes pop-up menu, select Always On.
- 5 Click OK.

This sets System Standby, System Hibernate, and “Turn off hard disks” to Never.

 *On AMD processors, be sure to check and disable Cool N’Quiet in the System BIOS (in the Cool & Quiet Configuration section). Refer to the manufacturer’s documentation for instructions on disabling this power option, if necessary.*

Disabling ClearType Font Smoothing

When using Pro Tools, the Effects “Clear Type” setting must be disabled.

To disable ClearType font smoothing:

- 1 Choose Start > Control Panel.
- 2 Double-click Display.
- 3 Click the Appearance tab.
- 4 Click Effects.
- 5 Deselect “Use the following method to smooth edges of screen fonts.”
- 6 Click OK to save your settings and close the Effects dialog.
- 7 Click OK.
- 8 Restart the computer.

Recommended Optimizations

Pro Tools can also be affected by other software and hardware drivers installed on your computer. For best possible performance, it is recommended (but not required) that you do the following:

- Avoid running any unneeded programs at the same time as Pro Tools.
- Turn off any software utilities that run in the background, such as Windows Messenger, calendars, and disk maintenance programs.

- Turn off any non-essential USB devices while running Pro Tools.
- If your video display card supports it, enable Bus Mastering in the manufacturer’s Control Panel. Refer to the manufacturer’s instructions for details.

Optional Optimizations

The following system optimizations may help Pro Tools perform better on some systems. It is recommended that you only try these optimizations if necessary, as they may disable or adversely affect the functionality of other programs on your system.

Disabling Network Cards

If applicable, disable any networking cards (other than the FireWire card that you are using to connect the Digi 002 or Digi 002 Rack or any FireWire drives to your system).

To disable a network card:

- 1 Right-click My Computer and choose Manage.
- 2 Under System Tools, select Device Manager.
- 3 In the Device Manager window, double-click Network adapters, then double-click the Network Adapter card you want to disable.
- 4 Under the General tab, choose “Do not use this device (disable)” from the Device Usage pop-up menu, and click OK.
- 5 Close the Computer Management window.

Adjusting Processor Scheduling

To Adjust Processor Scheduling Performance:

- 1 Choose Start > Control Panel.
- 2 In Classic View, double-click System.

- 3 Click the Advanced tab.
- 4 Under the Performance section, click the Settings button.
- 5 In the Performance Options window, click the Advanced tab.
- 6 Under the Processor scheduling section, select the Background Services option.
- 7 Under the Memory Usage section, select the System cache option.
- 8 Click OK to close the Performance Options window.
- 9 Click OK to close the System Properties window.
- 10 Restart the computer for the changes to take effect.

Disabling Hyper-Threading

Pro Tools LE 7.0 takes advantage of the added processing power of computers that have multiple processors, or that feature multi-core processing or Hyper-Threading, for RTAS processing.

However, if you set the number of processors available for RTAS processing to 1 (in the Pro Tools Playback Engine dialog), some computers with Hyper-Threading capability may experience decreased performance.

If this occurs, you can increase the number of RTAS processors in the Playback Engine dialog, or you can disable Hyper-Threading on the computer.

Refer to your computer's documentation for steps on how to enter the computer's BIOS and disable Hyper-Threading.

Disabling System Startup Items

The fewer items in use by your computer, the more resources are available for Pro Tools. Some startup applications may be consuming unnecessary CPU resources, and should be turned off.

If you disable any of the following startup items, do so carefully:

- Portable media serial number (required for applications that utilize a copy protection key)
- Plug and play
- Event log
- Cryptographic services
- DHCP Client, TCP/IP Net BIOS, and other networking-related items (unless the computer has no network or internet connection, in which case these items can be disabled)

To Disable System Startup Items:

- 1 From the Start menu, choose Run.
- 2 Type "msconfig" and click OK. The System Configuration Utility opens.
- 3 Under the General tab, choose Selective Startup.
- 4 Deselect Load Startup Items and click OK.
- 5 Click Restart to restart the computer.
- 6 After restarting, the computer displays a System Configuration message. Check to see if Pro Tools performance has increased before you deselect the "Don't show this message again" option. If performance has not changed, run "msconfig" and return your computer Selective Startup back to Normal Startup. Alternatively, try disabling Startup items and non-essential processes individually.

Hard Drive Configuration and Maintenance

It is recommended that you start with a newly initialized audio drive. You should also periodically defragment your audio drive to ensure continued system performance.

⚠ *Always back up any important data on your drive before initializing it, as it will erase all data on the drive.*

Avoid Recording to the System Drive

Recording to your system drive is not recommended. Recording and playback on a system drive may result in lower track counts, or fewer plug-ins.

Formatting an Audio Drive

For optimum performance, audio drives should be formatted as FAT32 or NTFS.

To format an audio drive:

- 1 Right-click My Computer and choose Manage.
- 2 Under Storage, choose Disk Management.

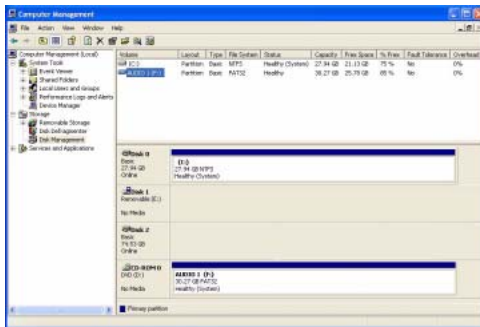

Disk Management window (Windows XP)

3 In the Disk Management window, right-click the hard drive you will use for audio and choose Format.

4 Do one of the following:

- Select the Quick Format option. Quick option should be sufficient for qualified mechanisms.

– or –

- For optimal disk performance, you can select 32K from the Allocation unit size pop-up menu (make sure Quick Format is not selected). Though this option takes longer to complete, it can increase efficiency of drive recording and playback.

5 Click Start, and follow the on-screen instructions.

⚠ *Pro Tools only supports Basic drive Types.*

6 When formatting is complete, close the Format window.

Audio Drives and Disk Cleanup

The process of recording and editing can quickly decrease overall drive performance. It is suggested that you regularly use Disk Cleanup (or an equivalent utility) to assess the condition of drives and, if necessary, delete temporary files and other unused data.

To use Disk Cleanup:

- 1 Choose Start > Control Panel.
- 2 Double-click Administrative Tools.
- 3 Double-click Computer Management.
- 4 Double-click Storage.
- 5 Double-click Disk Management.

- 6 Select the desired volume in the list, then choose File > Options.

Disk Cleanup determines how performance is being affected by drive conditions, and lets you review and delete unnecessary files from the selected volume. For more information, see your Windows XP documentation.

Defragmenting an Audio Drive

Periodically *defragment* audio drives to maintain system performance.

To defragment an audio drive:

- 1 Right-click My Computer and choose Manage.
- 2 Under Storage, choose Disk Defragmenter.
- 3 In the Disk Defragmenter window, choose the drive you want to defragment
- 4 Click the Defragment button and follow the on-screen instructions.
- 5 When defragmenting is complete, close the Computer Management window.

Connecting Digi 002 or Digi 002 Rack to the Computer

Before installing Pro Tools LE software and the Digi 002 or Digi 002 Rack software, you need to connect Digi 002 or Digi 002 Rack to the computer.

- ⚠** *When connecting Digi 002 or Digi 002 Rack to your computer the first time, your computer should be off. If your computer is on, power it down.*

To connect the Digi 002 or Digi 002 Rack to your computer:

- 1 Locate the FireWire cable that came with your unit.

⚠ *Be sure to note the orientation of the FireWire cable connector when you insert it in your Digi 002 or Digi 002 Rack. It is possible to damage the FireWire port if you force the connector in upside down.*

- 2 Plug one end of the FireWire cable into one of the ports marked “1394” on the back panel of the Digi 002 or Digi 002 Rack. Either port will work.

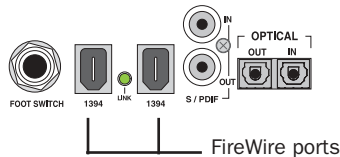

Digi 002 & Digi 002 Rack FireWire ports (back panel)

- 3 Do one of the following, depending on your system configuration:
 - Plug the other end of the FireWire cable into an available FireWire port on your computer.
 - Plug the other end of the FireWire cable into an available FireWire port on a FireWire hard drive connected to your computer. (See “Connecting FireWire Drives” on page 13.)

Connecting FireWire Drives

Connect FireWire hard drives directly to a FireWire port on your computer. Do not connect a FireWire hard drive to the second FireWire port on the back panel of Digi 002 or Digi 002 Rack because the FireWire ports do not pass audio data when the unit is powered off.

To connect a FireWire hard drive:

- If your computer has more than one FireWire port, connect the FireWire hard drive to one FireWire port on the computer, and connect Digi 002 or Digi 002 Rack to another FireWire port on the computer.

– or –

- If your computer has only one FireWire port, connect the FireWire hard drive directly to your computer and then connect Digi 002 or Digi 002 Rack to an available FireWire port on the drive.

⚠ *While it is possible to connect a FireWire hard drive to an available port on Digi 002 or Digi 002 Rack, if the unit is powered off, any mounted FireWire drives will lose their data connection with the computer. This may result in hard drive errors or data loss.*

4-Pin FireWire Cable

Digi 002 and Digi 002 Rack include a 6-pin to 6-pin FireWire cable. Some Windows laptops include a 4-pin FireWire port. To use Digi 002 or Digi 002 Rack with these computers, a 4-pin to

6-pin cable is required. Purchase this cable (model #CS625) through your authorized Digi-design dealer or online through the DigiStore (www.digidesign.com).

⚠ *This cable can also be purchased at computer supply stores. Maximum supported cable length for FireWire (IEEE-1394) is 14 feet (4.3 meters).*

Connecting Other FireWire Devices to Digi 002 or Digi 002 Rack

The second FireWire port on the Digi 002 or Digi 002 Rack unit is available for daisy-chaining FireWire devices such as digital cameras or digital video recorders. Even when it is powered off, Digi 002 or Digi 002 Rack supplies power from the computer through its FireWire ports, letting you recharge batteries in connected FireWire devices.

Powering On the Digi 002 or Digi 002 Rack

After you have made all cable connections, you are ready to power on the Digi 002 or Digi 002 Rack.

To power on the Digi 002 or Digi 002 Rack:

- Toggle the power switch on the back panel (Digi 002), or pressing the power switch on the front panel (Digi 002 Rack). After a short power-up sequence the Sample Rate LED and Monitor Mute switch illuminate to indicate the unit is on.

⚠ *Do not disconnect the FireWire connection to the Digi 002 or Digi 002 Rack while the unit is powered on. Connecting and disconnecting the FireWire cable after the unit is powered up can cause errors and may damage the unit.*

Be sure to power down all components of the system before disconnecting them.

Installing Pro Tools LE

To install Pro Tools LE:

- 1 Start Windows, logging in with Administrator privileges. For details on Administrator privileges, refer to your Windows documentation.
- 2 Wait for the Found New Hardware Wizard dialog to appear and leave it open: Do not click Next.
- 3 Insert the Pro Tools Installer CD for Windows in your CD-ROM drive. Locate and open the Pro Tools Installer folder, and double-click the Setup icon.
- 4 Click Next to begin installation.

5 Select any options you want to install. For more information, see “Optional Software on the Pro Tools Installer CD” on page 15.

6 Click Next.

⚠ *If you get a warning dialog about the driver not passing Windows Logo testing, click Continue Anyway.*

7 Wait for the installer to finish installing all software components, drivers, and PACE System files before proceeding to the next step.

8 When installation is complete, click Finish.

Installing QuickTime

QuickTime 6.5 or later is required for Pro Tools if you plan to include movie files, or import MP3 or MP4 (AAC) files in your sessions. QuickTime for Windows XP is available as a free download from the Apple Web site (www.apple.com).

To install QuickTime:

- 1 Visit www.apple.com and go to the QuickTime page.
- 2 Download the QuickTime installer application to your computer.
- 3 Double-click the QuickTime installer application and follow the on-screen installation instructions.
- 4 Restart your computer.

Optional Software on the Pro Tools Installer CD

Your Pro Tools Installer CD includes several software options.

Digidesign ASIO Driver

The Digidesign ASIO (Audio Sound Input Output) Driver is a single-client multichannel sound driver that allows third-party audio programs that support the ASIO standard to record and play back through Digidesign hardware.

The Digidesign ASIO Driver is automatically installed when you install Pro Tools.

 For detailed information on configuring the Digidesign ASIO Driver, see the *Digidesign ASIO Guide*.

 To use the Digidesign ASIO Driver without Pro Tools, you can install the standalone version of the Digidesign ASIO Driver, available on the Digidesign Web site (www.digidesign.com)

Digidesign WaveDriver

The Digidesign WaveDriver is a single-client, multichannel sound driver that allows third-party audio programs that support the WaveDriver MME (Multimedia Extension) standard to play back through Digidesign hardware.

The Digidesign WaveDriver is automatically installed when you install Pro Tools.

 For detailed information on configuring the Digidesign WaveDriver, see the *Digidesign WaveDriver Guide*.

 To use the Digidesign WaveDriver without Pro Tools, you can install the standalone version of the Digidesign WaveDriver, available on the Digidesign Web site (www.digidesign.com).

Digidesign Ethernet Software for Control Surface Support

Control|24 Only

If you plan to use a Digidesign Control|24 with your system, you will need to install the Digidesign Ethernet software.

To install Digidesign Ethernet software:

- 1 Click Start, right-click My Network Places, and then choose Properties.
- 2 Right-click the relevant Local Area Connection icon, and then choose Properties.
- 3 Click Install, select Protocol, and click Add.
- 4 Click Have Disk.
- 5 Select the DigiNet.inf file (on your Pro Tools Installer CD, in the Controllers folder), and click OK.

The Installer installs the DigiNet.inf files in the Program Files\Common Files\Digidesign\DAE\Controllers folder.

- 6 Click Close.

Pro Tools Demo Session

The Pro Tools LE Installer CD includes a demo session that you can use to verify that your system is working.

⚠ *Before installing the demo session to your audio drive, make sure the drive is configured as described in “Formatting an Audio Drive” on page 11.*

To install the demo session:

- 1 Insert the Pro Tools LE Installer CD into your CD-ROM drive.
- 2 From your CD-ROM drive, locate and open the Additional Files/Pro Tools LE Demo Session Installer folder.
- 3 Double-click Setup.exe.
- 4 Select your audio drive as the install location and click Install.
- 5 When installation is complete, click OK.

MacDrive

The MacDrive utility lets you mount Macintosh-based HFS+ drives on a Windows-based Pro Tools system and use them as Transfer drives.

⚠ *Transfer drives can be used for storage, but not for playback or recording. To use Mac-based audio files on a Windows Pro Tools system, copy the files from the Mac-based HFS+ audio drive to a Windows-based NTFS audio drive.*

To install the MacDrive demo included with Pro Tools:

- 1 Insert the Pro Tools Installer CD into your CD-ROM drive.
- 2 From your CD-ROM drive, locate and open the Additional Files/MacDrive Demo Installer folder.
- 3 Double-click the MacDrive demo installer.
- 4 Follow the on-screen instructions to install MacDrive. After installation is complete, restart your computer.

⚠ *All formatting and maintenance of HFS+ drives should be carried out when the drives are connected to a Macintosh. Do not use the MacDrive utility to initialize or partition Macintosh drives.*

Removing Pro Tools LE

If you need to remove Pro Tools LE software from your computer, you can use the Add or Remove Programs command.

To remove Pro Tools from your computer:

- 1 Choose Start > Control Panel.
- 2 Double-click Add or Remove Programs.
- 3 From the Currently Installed Programs list, select Digidesign Pro Tools LE.
- 4 Click the Change/Remove button.
- 5 Follow the on-screen instructions to remove Pro Tools LE.

chapter 3

Macintosh Configuration

This chapter contains information for Macintosh systems only. If you are installing Pro Tools on a Windows computer, see Chapter 2, “Windows Configuration.”

▲ *Before installing this version of Pro Tools, refer to the Read Me information included on the Pro Tools Installer CD.*

Installation Overview

Installation of the Digi 002 or Digi 002 Rack on a Macintosh includes the following steps:

- 1 “Testing Digi 002” on page 17.
- 2 “Macintosh System Optimization” on page 18.
- 3 “Installing Pro Tools LE” on page 20.
- 4 “Connecting Digi 002 or Digi 002 Rack to the Computer” on page 21.

▲ *When connecting Digi 002 to your computer the first time, your computer should be off. If your computer is on, power it down.*

- 5 Launching Pro Tools LE. (See Chapter 4, “Launching and Configuring Pro Tools LE.”)
- 6 Making audio and MIDI connections to the Digi 002 or Digi 002 Rack. (See Chapter 8, “Connecting Your Studio.”)

Testing Digi 002

(Digi 002 Only)

Before you install Pro Tools LE software or connect Digi 002 to your computer for the first time, you should power up the unit to be sure it is working correctly.

▲ *When connecting Digi 002 to your computer the first time, your computer should be off. If your computer is on, power it down.*

To set up and test the Digi 002:

- 1 Plug the Digi 002 into a standard AC receptacle, using the AC power cable included with the unit.

Digi 002 is auto power-selecting (100V to 240V) and will work automatically when plugged into an AC power receptacle in any country.

- 2 Power on the Digi 002 unit by turning on the power switch on the back panel. After a short power-up sequence, the Channel Scribble Strips on the unit show “Digi 002 Standby,” and the Standalone switch flashes to indicate Standby mode.

- 3 Press the Standalone switch in the upper right of the top panel of Digi 002. The Channel Scribble Strips on the unit show “Enter Standalone Mode?”

4 Press the Channel Select switch under “Yes” to enter Stand-alone mode. The Channel Scribble Strips on the unit will show the default names of the channel inputs, “In1” through “In8.”

5 To return Digi 002 to Standby mode, press the Standalone switch a second time. The Channel Scribble Strips on the unit will show “Exit Standalone Mode?”

6 Press the Channel Select switch under “Yes” to return to Standby mode.

7 Power down the unit.

Macintosh System Optimization

To ensure optimum performance with Pro Tools LE, configure your computer before installing Pro Tools software.

Before configuring your computer, make sure you are logged in as an Administrator for the account where you want to install Pro Tools. For details on Administrator privileges in Mac OS X, refer to your Apple OS X documentation.

⚠ *Do not use the Mac OS X automatic Software Update feature, as it may upgrade your system to a version of Mac OS that has not yet been qualified for Pro Tools. For details on qualified versions of Mac OS, refer to the latest compatibility information on the Digidesign Web site (www.digidesign.com/compato).*

Turning Off Software Update

To turn off the Software Update feature:

- 1 Choose System Preferences from the Apple menu and click Software Update.
- 2 Click Update Software and deselect Check for Updates.

Turning Off Energy Saver

To turn off the Energy Saver feature:

- 1 Choose System Preferences from the Apple menu and click Energy Saver.
- 2 Click Sleep and do the following:
 - Set the computer sleep setting to Never.
 - Set the display sleep setting to Never.
 - Deselect “Put the hard disk(s) to sleep when possible” option.

Setting Processor Performance (Macintosh G5 Computers Only)

To set the Processor Performance:

- 1 Choose System Preferences from the Apple menu and click Energy Saver.
- 2 Click Options and set Processor Performance to Highest.

Disabling Spotlight Indexing

The Mac OS X Spotlight feature indexes files and folders in the background, affecting system performance. It is recommended that you disable Spotlight indexing before using Pro Tools.

To disable Spotlight indexing:

- 1 Choose System Preferences from the Apple menu and click Spotlight.
- 2 In the Spotlight window, click Privacy.
- 3 To prevent indexing of a drive, drag its icon from the desktop into the list.

Disabling the Spotlight Shortcuts

The Mac OS X Spotlight feature uses the same key commands Pro Tools uses to start recording (Command+Spacebar), and to record online (Command+Option+Spacebar). If you want to retain use of these key commands in Pro Tools, these shortcuts must be disabled.

To disable the Spotlight keyboard shortcut:

- 1 Choose System Preferences from the Apple menu and click Spotlight.
- 2 Deselect “Spotlight menu keyboard shortcut” and “Spotlight window keyboard shortcut.”

Disabling the Dashboard Shortcut

The Mac OS X Dashboard feature uses the same key command Pro Tools uses to start recording (F12). If you want to retain use of this key command in Pro Tools, this shortcut must be disabled.

To disable the Dashboard keyboard shortcut:

- 1 Choose System Preferences from the Apple menu and click Dashboard and Exposé.
- 2 Set the Dashboard keyboard shortcut to “–” to disable the shortcut.

Hard Drive Configuration and Maintenance

It is recommended that you start with a newly initialized audio drive.

⚠ *Always back up any important data on your drive before initializing it, as initializing will erase all data on the drive.*

Avoid Recording to the System Drive

Recording to your system drive is not recommended. Recording and playback on a system drive may result in lower track counts, fewer plug-ins, or drive errors.

Formatting an Audio Drive

For optimum performance, audio drives should be formatted as Mac OS Extended (Journaled).

To format an audio drive:

- 1 Launch the Disk Utility application, located in Applications/Utilities.

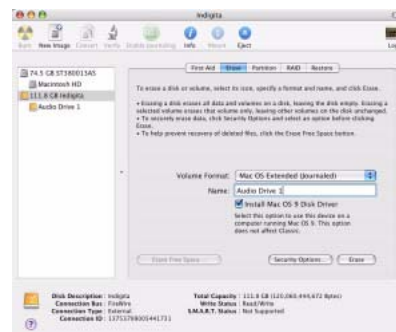

Disk Utility (Mac OS X)

- 2 Click the Erase tab.
- 3 Select the drive you want to initialize in the column on the left side of the window.
- 4 Choose the Mac OS Extended (Journaled) format.

⚠ Do not choose the “Case-Sensitive” format option. Pro Tools will not operate properly with case-sensitive formatted drives.

- 5 Type a name for the new volume.
- 6 If you plan to connect the drive to a Mac OS 9 computer, select Install Mac OS 9 Drivers.
- 7 Click Erase.

The drive appears on the Desktop with the new volume name.

Installing Pro Tools LE

After the Apple System software settings are configured, you are ready to install Pro Tools LE.

To install Pro Tools LE:

- 1 Make sure you are logged in as an Administrator for the account where you want to install Pro Tools. For details on Administrator privileges in Mac OS X, refer to your Apple Mac OS X documentation.
- 2 Insert the Pro Tools LE Installer CD in your CD-ROM drive. Double-click “Install Pro Tools LE.”
- 3 Enter your Administrator password and click OK to authenticate the installation.
- 4 Follow the on-screen instructions to continue and accept installation.
- 5 In the Installer window, make sure the Install Location is on your Startup drive.
- 6 In the Installer window, choose Custom Install from the pop-up menu, and click Install.
- 7 Follow the remaining on-screen instructions to install Pro Tools and any options. (See also “Optional Software on the Pro Tools Installer CD” on page 20.

- 8 When installation is complete, click Restart.

Digidesign CoreAudio Driver

The Digidesign CoreAudio Driver is a multi-client, multichannel sound driver that allows CoreAudio compatible applications to record and play back through Digidesign hardware.

The CoreAudio Driver is installed by default when you install Pro Tools.

 For detailed information on configuring the Digidesign CoreAudio Driver, see the CoreAudio Usage Guide.

Optional Software on the Pro Tools Installer CD

Your Pro Tools LE Installer CD includes separate installers for the following optional items.

Standalone CoreAudio Driver

The Digidesign CoreAudio Driver can be installed as a standalone driver on Macintosh systems that do not have Pro Tools installed.

 For detailed information on installing and configuring CoreAudio Driver, see the CoreAudio Usage Guide.

Pro Tools Demo Session

The Pro Tools LE Installer CD includes a demo session that you can use to verify that your system is working.

To install the demo session:

- 1 Insert the Pro Tools LE Installer CD in your CD-ROM drive. Locate and double-click the demo session installer icon.

- 2 Select your audio drive as the install location and click Install.
- 3 When installation is complete, click Quit.

Connecting Digi 002 or Digi 002 Rack to the Computer

After installing Pro Tools LE software and re-starting your computer, connect the Digi 002 or Digi 002 Rack to the computer before launching Pro Tools LE.

⚠ *When connecting Digi 002 or Digi 002 Rack to your computer the first time, your computer should be off. If your computer is on, power it down.*

To connect the Digi 002 or Digi 002 Rack to your computer:

- 1 Locate the FireWire cable that came with your unit.

⚠ *Be sure to note the orientation of the FireWire cable connector when you insert it in your Digi 002 or Digi 002 Rack. It is possible to damage the FireWire port if you force the connector in upside down.*

- 2 Plug one end of the FireWire cable into one of the ports marked “1394” on the back panel of the Digi 002 or Digi 002 Rack. Either port will work.

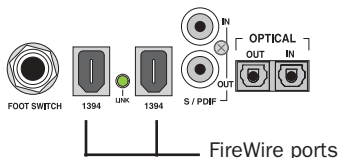

Digi 002 & Digi 002 Rack FireWire ports (back panel)

- 3 Do one of the following, depending on your system configuration:

- Plug the other end of the FireWire cable into an available FireWire port on your computer.
- Plug the other end of the FireWire cable into an available FireWire port on a FireWire hard drive connected to your computer. (See “Connecting FireWire Drives” on page 21.)

Connecting FireWire Drives

Connect FireWire hard drives directly to a FireWire port on your computer. Do not connect a FireWire hard drive to the second FireWire port on the back panel of Digi 002 or Digi 002 Rack because the FireWire ports do not pass audio data when the unit is powered off.

To connect a FireWire hard drive:

- If your computer has more than one FireWire port, connect the FireWire hard drive to one FireWire port on the computer, and connect Digi 002 or Digi 002 Rack to another FireWire port on the computer.

– or –

- If your computer has only one FireWire port, connect the FireWire hard drive directly to your computer and then connect Digi 002 or Digi 002 Rack to an available FireWire port on the drive.

⚠ *While it is possible to connect a FireWire hard drive to an available port on Digi 002 or Digi 002 Rack if the unit is powered off, any mounted FireWire drives will lose their data connection with the computer. This may result in hard drive errors or data loss.*

4-Pin FireWire Cable

Digi 002 and Digi 002 Rack include a 6-pin to 6-pin FireWire cable. Some Windows laptops include a 4-pin FireWire port. To use Digi 002 or Digi 002 Rack with these computers, a 4-pin to 6-pin cable is required. Purchase this cable (model #CS625) through your authorized Digi-design dealer or online through the DigiStore (www.digidesign.com).

A *This cable can also be purchased at computer supply stores. Maximum supported cable length for FireWire (IEEE-1394) is 14 feet (4.3 meters).*

Connecting Other FireWire Devices to Digi 002 or Digi 002 Rack

The second FireWire port on the Digi 002 or Digi 002 Rack unit is available for daisy-chaining FireWire devices such as digital cameras or digital video recorders. Even when it is powered off, Digi 002 or Digi 002 Rack supplies power from the computer through its FireWire ports, letting you recharge batteries in connected FireWire devices.

Powering On the Digi 002 or Digi 002 Rack

After you have made all cable connections, you are ready to power on the Digi 002 or Digi 002 Rack.

To power on the Digi 002 or Digi 002 Rack:

- Toggle the power switch on the back panel (Digi 002), or press the power switch on the front panel (Digi 002 Rack). After a short power-up sequence the Sample Rate LED and Monitor Mute switch illuminate to indicate the unit is on.

A *Do not disconnect the FireWire connection to the Digi 002 or Digi 002 Rack while the unit is powered on. Connecting and disconnecting the FireWire cable after the unit is powered up can cause errors and may damage the unit.*

Be sure to power down all components of the system before disconnecting them.

Removing Pro Tools LE

If you need to remove Pro Tools LE software from your computer, you can use the Installer CD or the downloaded Installer file.

To remove Pro Tools from your computer:

- 1 Make sure you are logged in as an Administrator for the account where Pro Tools is installed. (For more information, refer to your Mac OS X documentation.)
- 2 Insert the Pro Tools Installer CD-ROM in your CD-ROM drive or locate the downloaded Installer file.
- 3 Double-click “Install Pro Tools LE.”
- 4 Enter your Administrator password and click OK.
- 5 In the Installer window, choose Uninstall from the pop-up menu, and click Uninstall.
- 6 Follow the on-screen instructions to remove Pro Tools LE.
- 7 When finished, click Quit to close the Installer window.

chapter 4

Launching and Configuring Pro Tools LE

After you have connected your system and installed Pro Tools LE software, you are ready to launch and configure Pro Tools LE.

Launching Pro Tools LE

When launching Pro Tools LE the first time, you are prompted to enter an authorization code to validate your software.

To authorize Pro Tools LE software:

1 Do one of the following:

- Double-click the Pro Tools LE shortcut on the desktop (Windows) or click the Pro Tools LE icon in the Dock (Macintosh).
- or –
- Locate and double-click the Pro Tools LE application on your hard drive.

A *If you get a warning dialog about updating the firmware for your hardware, follow the on-screen instructions to perform the firmware update. See “Updating Digi 002 or Digi 002 Rack Firmware” on page 23.*

2 Enter the authorization code in the dialog (making sure to type it exactly as printed, and observing any spaces and capitalization), then click Validate.

Your authorization code is located on the inside cover of this guide.

Updating Digi 002 or Digi 002 Rack Firmware

When you launch Pro Tools software, it automatically checks the version of the unit’s firmware, and prompts you to update it if a newer version is available.

If you update your unit’s firmware, let the update complete before disconnecting or turning off your system.

When the download and reprogramming process is complete, you may get a message that Pro Tools cannot communicate with Digi 002 or Digi 002 Rack. In this case, wait up to 30 seconds. If the message does not go away, power off the Digi 002 or Digi 002 Rack and then power it on again.

Configuring Pro Tools LE

Pro Tools System Settings

Pro Tools LE lets you adjust the performance of your system by changing *system settings* that affect its capacity for processing, playback, and recording

In most cases, the default settings for your system provide optimum performance, but you may want to adjust them to accommodate large or processing-intensive Pro Tools sessions.

Hardware Buffer Size

The Hardware Buffer Size (H/W Buffer Size) controls the size of the buffer used to handle host processing tasks such as Real-Time AudioSuite (RTAS) plug-ins. The H/W Buffer setting can also be used to manage monitoring latency.

- ◆ Lower Hardware Buffer Size settings reduce monitoring latency, and are useful when you are recording live input.
- ◆ Higher Hardware Buffer Size settings allow for more audio processing and effects, and are useful when you are mixing and using more RTAS plug-ins.

⚠ *In addition to causing slower screen response and monitoring latency, higher Hardware Buffer Size settings can increase the latency caused by RTAS plug-ins, and affect the accuracy of plug-in automation, mute data, and MIDI track timing.*

To change the Hardware Buffer Size:

- 1 Choose Setup > Playback Engine.

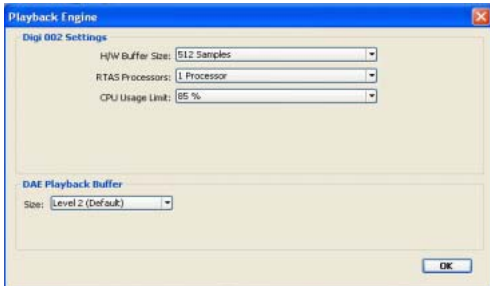

Playback Engine dialog (Digi 002 shown)

- 2 From the H/W Buffer Size pop-up menu, select the audio buffer size, in samples.
- 3 Click OK.

RTAS Processors

The RTAS Processors setting determines the number of processors in your computer allocated for RTAS plug-in processing.

With computers that have multiple processors, or that feature multi-core processing or hyper-threading, this setting lets you enable multi-processor support for RTAS processes. Used in combination with the CPU Usage Limit setting, the RTAS Processors setting lets you control the way RTAS processing and other Pro Tools tasks are carried out by the system.

- ◆ A higher number of processors reserves more CPU processing capacity for RTAS plug-in processing. This is useful for sessions with large number of RTAS plug-ins.
- ◆ A lower number of processors leaves more CPU processing capacity for automation, screen redraws, and video playback in Pro Tools, or for other application running at the same time as Pro Tools.

To set the number of RTAS Processors:

- 1 Choose Setup > Playback Engine.
- 2 From the RTAS Processors pop-up menu, select the number of available processors you want to allocate for RTAS plug-in processing.
- 3 Click OK.

CPU Usage Limit

The CPU Usage Limit controls the percentage of CPU resources allocated to Pro Tools host processing tasks. Used in combination with the RTAS Processors setting, the CPU Usage Limit setting lets you control the way Pro Tools tasks are carried out by the system.

- ◆ Lower CPU Usage Limit settings limit the effect of Pro Tools processing on other CPU-intensive tasks, such as screen redraws, and are useful when you are experiencing slow system response, or when running other applications at the same time as Pro Tools.
- ◆ Higher CPU Usage Limit settings allocate more processing power to Pro Tools, and are useful for playing back large sessions or using more real-time plug-ins.

The maximum available CPU Usage Limit depends on the number of processors in your computer and on the number of processors you specify for RTAS processing. This value can range from 85 percent for single-processor computers to 99 percent for multi-processor computers.

 *Increasing the CPU Usage Limit may slow down screen response on slower computers.*

To change the CPU Usage Limit:

- 1 Choose Setup > Playback Engine.
- 2 From the CPU Usage Limit pop-up menu, select the percentage of CPU processing you want to allocate to Pro Tools.
- 3 Click OK.

DAE Playback Buffer Size

The DAE Playback Buffer Size determines the amount of memory DAE allocates for disk buffers. The optimum DAE Playback Buffer Size for most disk operations is Level 2.

- ◆ DAE Playback Buffer Size settings lower than Level 2 may improve playback and recording initiation speed, but may make it difficult to play or record tracks reliably with sessions containing a large number of tracks or a high density of edits, or with systems that have slower or heavily fragmented hard drives.
- ◆ DAE Playback Buffer Size settings higher than Level 2 will allow for a higher density of edits in a session or a higher track count when using slower hard drives. However, a higher setting can also cause a time lag to occur when starting playback or recording, or longer audible time lag while editing during playback.



Using a larger DAE Playback Buffer Size leaves less system memory for other tasks. The default setting of Level 2 is recommended unless you are encountering -9073 (“Disk too slow or fragmented”) errors.

To change the DAE Playback Buffer Size:

- 1 Choose Setup > Playback Engine.
- 2 From the DAE Playback Buffer pop-up menu, select a buffer size.
- 3 Click OK.

MIDI Studio Setup

(Windows Only — Optional)

If you plan to use any MIDI devices with Pro Tools, configure your MIDI setup with MIDI Studio Setup. See Appendix A, “Configuring MIDI Studio Setup (Windows Only)” for details.

Audio MIDI Setup (AMS)

(Macintosh Only — Optional)

If you plan to use any MIDI devices with Pro Tools, configure your MIDI setup with the Apple Audio MIDI Setup (AMS) utility. See Appendix B, “Configuring AMS (Mac OS X Only).”

Pro Tools Hardware Settings

Pro Tools lets you set the default sample rate and clock source for your system, and configure the digital inputs on the Digi 002 or Digi 002 Rack.

Default Sample Rate

The Sample Rate setting appears as the default sample rate when you create a new session. (This setting is available in the Hardware Setup dialog only when no session is open.)

 You can change the sample rate when creating a new Pro Tools session by selecting a different sample rate in the New Session dialog. (Refer to the Pro Tools Reference Guide for details.)

To change the default Sample Rate:

- 1 Choose Setup > Hardware.

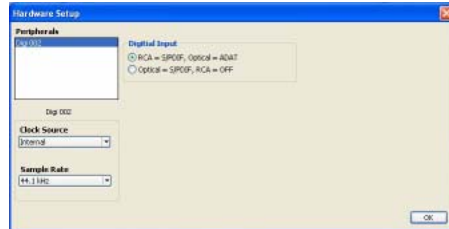

Hardware Setup dialog (Digi 002 shown)

- 2 Select the sample rate from the Sample Rate pop-up menu.
- 3 Click OK.

Clock Source

The Pro Tools Hardware Setup dialog lets you select the Clock Source for the system.

If you are recording directly into Pro Tools, you will usually use the Internal setting. If you are transferring material from an external digital device, select the corresponding clock source. (See “Recording a Digital Source” on page 27.)

To select the Clock Source:

- 1 Choose Setup > Hardware.
- 2 Choose the clock source from the Clock Source pop-up menu.
- 3 Click OK.

 Your digital input device must be connected and turned on for Pro Tools to synchronize to it. If your input device is not turned on, leave the Clock Source set to Internal.

Recording a Digital Source

If you are recording from an optical or S/PDIF device, you will need to select a Clock Source. In most cases, you will synchronize the Pro Tools clock to the external device.

To configure Pro Tools LE for a digital source:

1 Connect an ADAT or Optical S/PDIF format device to the Optical In connector, or an RCA S/PDIF format device to the RCA S/PDIF In connector on the back of the Digi 002.

2 Choose Setup > Hardware.

3 Make sure the correct digital input option is selected for your setup. When you select RCA S/PDIF, the Optical ports are available for standard ADAT Optical (or “Lightpipe”) input. When you select Optical S/PDIF, the RCA digital input connector is inactive.

⚠ You can use only one pair of S/PDIF inputs (either RCA or Optical) at a time.

4 From the Clock Source pop-up menu, select Internal if you are synchronizing the external device to Digi 002 or Digi 002 Rack. If you are synchronizing the Pro Tools clock to the external device, select ADAT, RCA (S/PDIF) or Optical (S/PDIF), depending on where you connected your digital device.

⚠ Your digital input device must be connected and powered on. If your input device is not powered on, leave the Clock Source set to Internal.

Configuring I/O Setup

Using the I/O Setup dialog, you can label Pro Tools LE input, output, insert, and bus *signal paths*. The I/O Setup dialog provides a graphical representation of the inputs, outputs, and signal routing of the Digi 002 and Digi 002 Rack.

Pro Tools LE has default I/O Setup settings that will get you started. Use the I/O Setup dialog only if you want to rename the default I/O paths.

To rename I/O paths in I/O Setup:

1 Choose Setup > I/O.

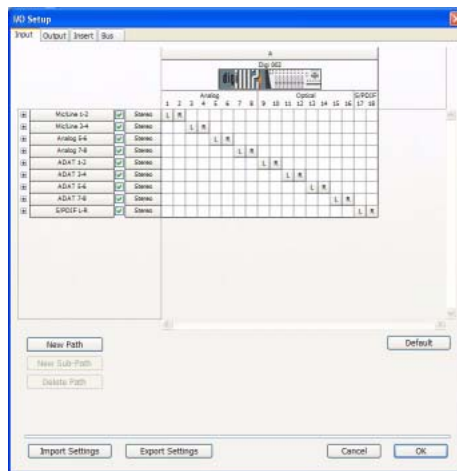

I/O Setup dialog, Input tab (Digi 002 shown)

2 Click the Input, Output, Insert, or Bus tab to display the corresponding paths.

3 To change the name of a path or subpath, double-click directly on the Path Name, type a new name for the path, and press Enter (Windows) or Return (Macintosh).

4 Click OK.



Refer to the Pro Tools Reference Guide (or choose Help > Pro Tools Reference Guide) for more information on renaming I/O paths.

Backing Up your System Configuration

After configuring your system and Pro Tools, you should save an image of your system drive using a backup utility such as Norton Ghost (Windows) or Bombich Carbon Copy Cloner (Macintosh). By doing this, you can quickly restore your system configuration and settings if you encounter any problems.

chapter 5

Digi 002 Top Panel

Digi 002 Operating Modes

Digi 002 can be in any of three states when it is powered on: Standby mode, Pro Tools mode, or Stand-alone mode.

Standby Mode

Digi 002 is in this mode when you first power on the unit, waiting for you to either launch Pro Tools or put the unit in Stand-alone mode.

In Standby mode, the unit displays “Digi 002” and “Standby” in the Scribble Strips, and the Standalone LED flashes.

Pro Tools Mode

Digi 002 is in this mode when the Digi 002 unit is connected to a computer and Pro Tools LE software is running.

If no Pro Tools session is open, the unit displays “Open or create a new session.” When a Pro Tools session is open, the unit mirrors the on-screen controls. In this mode, the Stand-alone LED is off.

To put Digi 002 in Pro Tools mode:

- 1 Make sure the Digi 002 unit is properly connected to the computer and in Standby mode.
- 2 Launch Pro Tools LE and open or create a Pro Tools session.

Stand-Alone Mode

When you put Digi 002 in Stand-alone mode, the unit becomes an 8-channel digital mixer that operates independently from Pro Tools.

See Chapter 10, “Using Digi 002 as a Stand-Alone Mixer” for more information on stand-alone operation of Digi 002.

The Digi 002 Top Panel

The Digi 002 top panel is arranged in sections of controls with related functions. The Fader section includes standard channel strip controls, similar to any small-format mixer. The Console/Channel View section provides powerful multi-state controls for viewing and controlling inserts, plug-ins and sends in Pro Tools. The Transport and Navigation controls provide access to many of the on-screen navigation features of Pro Tools.

This chapter covers each of the Digi 002 sections in relation to its function while in Pro Tools mode.

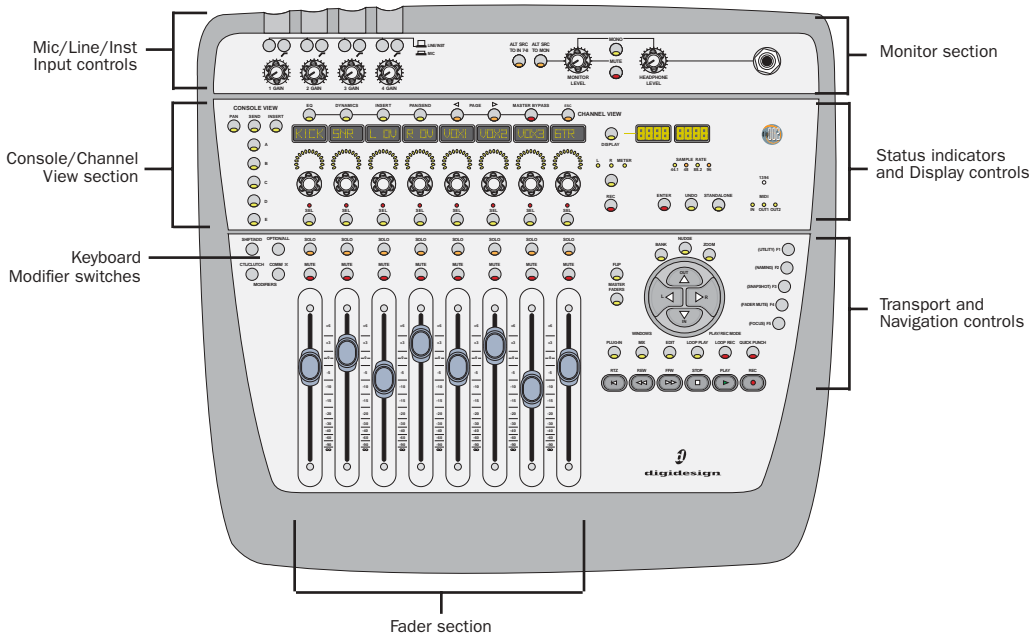

Figure 1. Major sections of the Digi 002 top panel

Views in Pro Tools Mode

When Digi 002 is used with Pro Tools, many of its controls perform more than one function, depending on which *view* you are in. When in Pro Tools mode, the Digi 002 control surface operates in one of three main views: *Home View*, *Console View* or *Channel View*.

Home View

Home View is the default view in Pro Tools that you see when you first open a session, and is actually the same as Console View with the Pan controls displayed.

To put Digi 002 in Home View:

- Press the Pan switch in the upper left-hand corner of the Console View area.

Console View

Console View lets you toggle the Digi 002 to show pan position, send assignments or insert assignments for all channels on the control surface. You can think of Console View as a global view of a given control (pan, send, or insert) on each channel. (See “Console View” on page 35.)

- ◆ In Console view, the touch-sensitive faders on Digi 002 mirror the volume faders in Pro Tools. Fader assignments are shown on-screen in Pro Tools by blue outlines around the track names.
- ◆ In Console view, the LED rings above the rotary encoders indicate either the pan position, the send level, or the insert level for each channel, depending on which Console View switch is lit.



When you first open a Pro Tools session, Digi 002 is in Console View with the Pan switch lit. This default view is also known as “Home View.”

Digi 002 is in Console View when any of the Console View selectors (Pan, Send, or Insert) are lit in the Console View area.

To put Digi 002 in Console View:

- Press the Pan, Send, or Insert switch in the upper left-hand corner of the Console View area.

Channel View

Channel View lets you display all of a selected channel’s plug-in assignments, insert names, or send assignments at the same time. You can think of Channel View as a way to temporarily focus on all the inserts or sends on a single channel.

- ◆ In Channel View, the touch-sensitive faders on Digi 002 mirror the volume faders in Pro Tools.
- ◆ In Channel View, the LED rings above the rotary encoders indicate values for the selected control, such as plug-in parameters, insert levels, or pan values and send levels, depending on which Channel View switch is lit.

Digi 002 is in Channel View when any of the Channel View selectors (EQ, Dynamics, Insert or Pan/Send) are lit in the Channel View area.

To put Digi 002 in Channel View:

- Press the EQ, Dynamics, Insert, or Pan/Send switch in the Channel View area above the Channel Scribble Strips.

Fader Section

The Digi 002 fader section consists of 8 identical channel strips, each with a touch-sensitive fader, solo and mute switches, a multi-state Select switch, and a rotary encoder.

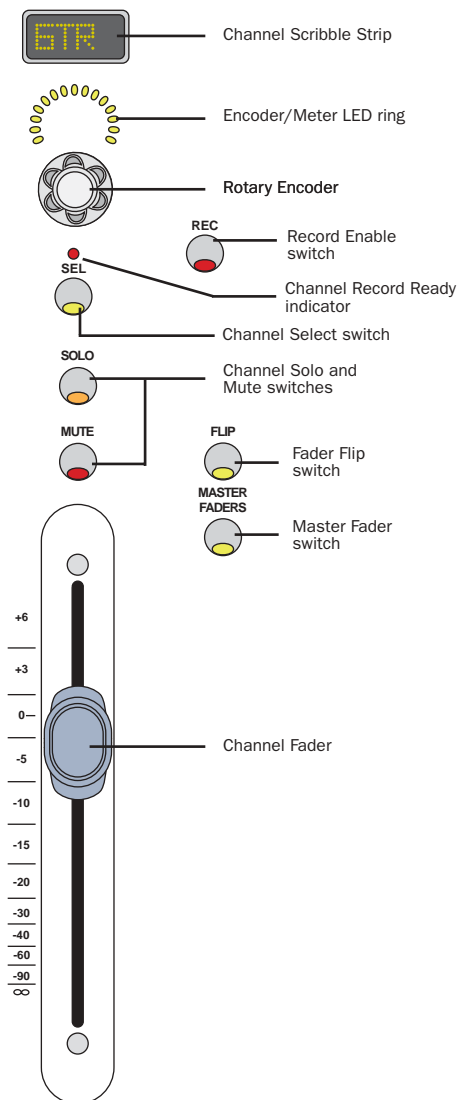

Digi 002 fader section and global fader controls

Channel Strip Controls

Channel Faders

Each channel has its own touch-sensitive, motorized fader for controlling levels of audio and MIDI tracks, Auxiliary Inputs, and Master Faders. In Flip mode, other controls, such as send levels or plug-in parameters, can be controlled by the faders.

Channel Solo/Mute Switches

Each channel has Solo and Mute switches, located above the fader. These switches show the Pro Tools solo and mute status for each track. When a track is soloed, the Mute switches on other tracks in the session flash. When a track is muted, the Mute switch is lit continuously.

The Solo switch function follows the Pro Tools Operation preference for latched operation. (See the *Pro Tools Reference Guide* for details.)

Channel Select Switch

Each channel has a Channel Select switch that performs several functions, depending on the view:

Home View The Channel Select switches allow you to select the corresponding track (indicated on-screen by a highlighted track name) for grouping and other channel-related commands in Pro Tools.

Console View The Channel Select switches are used to select inserts on a particular channel for editing, or to select pre- or post-fader operation for sends.

Channel View The Channel Select switches are used to select and edit individual send or insert settings as displayed across the Channel Scribble Strips.

Channel Record Ready Indicator

Each channel has a Record Ready LED. When a track is record-enabled and the transport is stopped, this LED flashes. When Pro Tools is recording, it is lit continuously. (See “Record Enable Switch” on page 33 for details on record-enabling tracks.)

Rotary Encoders

These knobs control a variety of parameters, depending on the view:

Home View The rotary encoders control pan position for each track, with the LED rings indicating the pan position with a single LED.

Console View The rotary encoders control send levels for each track, with the LED rings indicating the send levels with an expanding series of LEDs.

Channel View The rotary encoders control plug-in, pan/send, or insert settings, depending on the Channel View selection, with the LED rings showing corresponding states.

Encoder/Meter LED Ring

Each rotary encoder has a circle of 15 LEDs above it for indicating data values controlled by the encoder. The style of display depends on the type of data. For example, discrete or stepped information such as pan position or frequency value is shown by a single LED, while an expanding series of LEDs shows values such as send levels, gain, or filter bandwidth.

The LED rings can also be set to show track levels by pressing the Encoder/Meter Mode switch to the right of the encoder area. When set to Meter mode, the LED rings show increasing levels in a clockwise manner, with the last red LED indicating clipping.

Channel Scribble Strip

Each channel has a 4-character scribble strip that displays a variety of information, including track, send and insert names, pan position, send levels, or plug-in control information. The default display is the name of the displayed element. When you move a fader or rotary encoder, the scribble strip will temporarily display the value for that control, then return to the default display.

Global Fader Controls

Immediately to the right of the channel faders, there are global controls that affect the assignment and operation of all the faders.

Record Enable Switch

Pressing the Record Enable switch followed by a Channel Select switch arms the corresponding track for recording.

To enable tracks for recording:

- 1 Press the Record Enable switch. When the Record Enable function is active, the Record Enable switch flashes.
- 2 Press the Channel Select switch for the tracks you want to enable for recording. When a track is armed for recording, its Record Ready indicator flashes. During recording, its Record Ready indicator is lit continuously.
- 3 To deactivate the Record Enable function, press the Channel Select switch for the track, then press the Record Enable switch a second time.

To disable tracks for recording:

1 Press the Channel Select switch on any track whose Record Ready indicator is flashing to disarm the track for recording.

2 Press the Record Enable switch a second time to deactivate the Record Enable function.

Fader Flip Switch

The Fader Flip switch invokes Flip mode, which transfers control assignments from the rotary encoders to the corresponding channel faders, allowing you to use the touch-sensitive faders to edit and automate control values. There are several types of Flip mode, depending on the view.

To transfer controls from the rotary encoders to the touch-sensitive faders:

- Press the Flip switch. This switch flashes when Flip mode is activated.
- To exit Flip mode, press the Flip switch a second time.

Send Flip Mode When you are in Home View or Console View, the Flip switch moves the send level controls to the channel faders, and the send pan controls to the rotary encoders. The Channel Scribble Strips display the selected send (A–E) for each channel.

For stereo tracks with stereo sends, you can toggle the encoder display between left and right send pan by pressing the Encoder Mode switch immediately to the right of the encoders. Both the Display Scribble Strip and the LEDs above the Encoder Mode switch indicate whether the left or right pan position is displayed.

For mono tracks with stereo sends, only the left pan indicator shows a pan position; the right pan indicator is inactive.

Plug-In Flip Mode When you are in Channel View and working with a plug-in insert, the Flip switch moves any plug-in control assignments from the rotary encoders to the faders, allowing you to use the touch-sensitive faders to edit and automate plug-in control values. The details of the controls depend on the particular plug-in you are using.

See “Channel View” on page 36 for more details on working with plug-ins in Channel View.

Pan/Send Flip Mode When you are in Channel View and working with the pan and send assignments on a channel, the Flip switch moves the send level controls to channel faders 3–7, and the send pan controls to rotary encoders 3–7. (The first Channel Scribble Strip and encoder continue to show track pan position for that track.)

In this mode, the Channel Select switches toggle pre- and post-fader metering for the corresponding send.

For stereo tracks with stereo sends, you can toggle the encoder display between left and right send pan by pressing the Encoder Mode switch immediately to the right of the encoders.

See “Channel View” on page 36 for more details on working with pan controls and sends in Channel View.

Master Fader Switch

Pressing the Master Fader switch arranges all Master Fader tracks in the current session on the right-hand side of the control surface. Pressing this switch a second time returns the control surface to the previous view.

Console/Channel View Section

The Console/Channel View section uses many of the channel fader controls to display and edit pan, send, and insert controls, giving you control over many on-screen elements in Pro Tools.

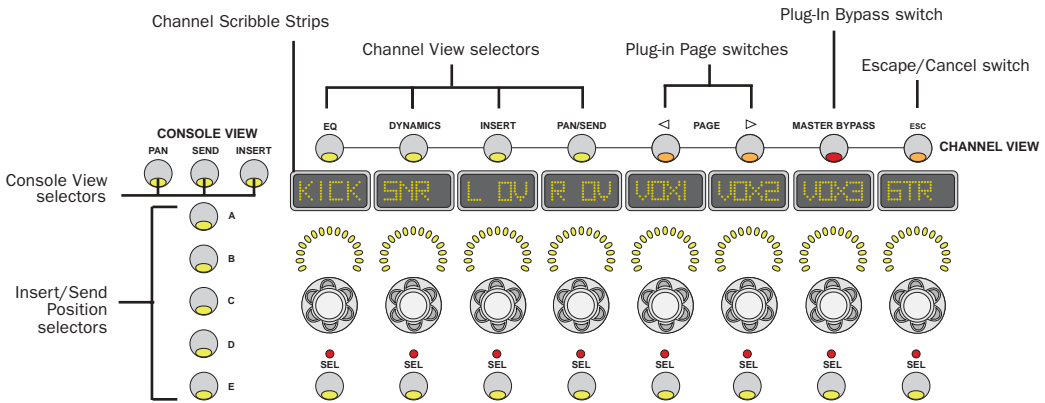

Digi 002 Console and Channel View controls

Console View

Console View lets you toggle the Digi 002 to show pan position, send controls or insert names for all channels on the control surface.

Console View Selectors

These switches toggle the center section of Digi 002 to display one of the three following types of controls: pan, sends, or inserts.

Pan View This is the default view that appears when you first launch a Pro Tools session, where the faders control track volume and the rotary encoders control channel pan positions. The Channel Scribble Strips show the track names, and temporarily show the channel pan positions when the encoder is moved, or volume information when the fader is moved. In this view, pressing a Channel Select switch selects the corresponding track in Pro Tools.

Send View This view assigns send level controls to the rotary encoders. The Channel Scribble Strips show the names of currently assigned sends across all channel strips for a given send position (Sends A–J in Pro Tools).

In this view, pressing a Channel Select switch toggles the selected send on that track between pre- and post-fader operation. (See the *Pro Tools Reference Guide* for details.)

Insert View This view displays the names of currently assigned inserts (hardware inserts or plug-ins) across all channel strips for a given insert position (Inserts A–E in Pro Tools) in the Channel Scribble Strips.

If a hardware insert or plug-in is selected in Pro Tools, its name flashes in the Scribble Strip. In this view, pressing a Channel Select switch directly under a plug-in name puts Digi 002 into Channel View and displays the plug-in controls across all channel strips.

Insert/Send Position Selectors

These switches determine which of the five available insert positions (marked A–E in Pro Tools) or ten available send positions (marked A–J in Pro Tools) are displayed in Console View.

- ◆ To view Inserts A–E, put Digi 002 in Inserts view, and press the corresponding switch A–E.
- ◆ To view Sends A–E, put Digi 002 in Sends view, and press the corresponding switch (A, B, C, D, or E).
- ◆ To view Sends F–J, put Digi 002 in Sends view, then hold Shift/Add and press the corresponding switch (A=F, B=G, C=H, D=I, or E=J). The switches flash to indicate display of Sends F–J.

Channel View

Channel View zooms in on a single track and displays all controls of a certain type (sends, inserts, or plug-ins) horizontally, across all of the Channel Scribble Strips on Digi 002. From this view, you can recall and edit parameters for all the sends on a single track, or all the parameters of a single plug-in.

Channel View Selectors

These switches determine the type of information displayed for a selected track. The first two switches focus on particular types of plug-ins, while the second two address all types of inserts and sends.

EQ When you press the EQ switch, Digi 002 identifies channels with equalizer plug-ins assigned to them by illuminating their Channel Select switches. If no EQ plug-ins are present, no Channel Select switches will be lit.

When you press an illuminated Channel Select switch, controls for the first EQ plug-in on that track are assigned to the rotary encoders and displayed in the Channel Scribble Strips. Switched controls, such as Master Bypass or Phase Invert functions, are controlled by the Channel Select switches.

To cycle through all the EQ plug-ins on a channel, hold the EQ switch and repeatedly press the track's Channel Select switch. If a plug-in window is open on-screen, it will update to reflect the plug-in selected on the Digi 002.

Dynamics When you press the Dynamics switch, Digi 002 identifies channels with dynamics plug-ins (such as compressors or limiters) assigned to them by illuminating their Channel Select switches. If no dynamics plug-ins are present, no Channel Select switches will be lit.

When you press an illuminated Channel Select switch, controls for the first Dynamics plug-in on that track are assigned to the rotary encoders and displayed in the Channel Scribble Strips.

Switched controls, such as Phase Invert or In/Out for EQ bands, are controlled with the Channel Select switches below the corresponding Scribble Strips.

To cycle through all the Dynamics plug-ins on a channel, hold the Dynamics switch and repeatedly press the track's Channel Select switch. If a plug-in window is open on-screen, it will update to reflect the plug-in selected on the Digi 002.

Inserts When you press the Inserts switch, Digi 002 identifies channels with any insert assigned to them (including software plug-ins or hardware I/O inserts) by illuminating their Channel Select switches. If no inserts are present, no Channel Select switches will be lit.

When you press an illuminated Channel Select switch, the names of all inserts on that track are displayed in the Channel Scribble Strips. To select a plug-in insert for editing, press the corresponding Channel Select switch. (While the names of hardware I/O inserts are displayed, they have no editable parameters, so the Channel Select switches and the rotary encoders have no effect on them.)

To cycle through all the inserts on a channel, hold the Insert switch and repeatedly press the track's Channel Select switch.

Pan/Send When you press the Pan/Send switch, Digi 002 identifies channels with sends assigned to them by illuminating their Channel Select switches. If no sends are present, no Channel Select switches will be lit.

When you press an illuminated Channel Select switch, Channel Scribble Strip 1 and the first rotary encoder show track pan position for that track. (If the track is a stereo track, you can toggle between left and right pan by pressing the Encoder Mode switch immediately to the right of the encoders.)

Channel Scribble Strips 3–7 show the names and their rotary encoders control the levels for the first five sends on that track. (Channel Scribble Strip 2 is inactive.) In this mode, the Channel Select switches on channels 3–7 toggle pre- and post-fader metering for the corresponding send.

Plug-In Page Switches Plug-In controls are organized in *pages*. In a process much like banking of channel faders, when a plug-in has more controls than can fit on the Channel Scribble Strips at one time, you can use these switches to page through the plug-in controls.

When a plug-in has multiple pages of controls, one of the Plug-In Page switches will flash to indicate a next or previous page. The total number of pages is shown in the Status Display when you press the flashing Plug-In Page switch.

Multi-Mono Plug-ins

When working with a multi-mono plug-in, you can toggle the view between the left and right sides of the plug-in by holding down the Display switch when you press the Channel Select switch to select a plug-in from Channel view.

The resulting display shows “left” and “right” in the Scribble Strips, allowing you to choose between the two sides of the multi-mono plug-in by pressing the corresponding Channel Select switch.

Plug-In Master Bypass Switch This switch bypasses either a single plug-in or all plug-ins on a channel, depending on the current view. If the controls for only one plug-in are displayed, only that plug-in will be bypassed. If all the plug-ins on a channel are displayed, all of those plug-ins will be bypassed.

If no plug-ins are displayed, the Master Bypass function is unavailable.



Hardware I/O inserts cannot be bypassed in Pro Tools, so the Plug-In Master Bypass switch has no effect on them.

Esc (Escape/Cancel) Switch When flashing, this switch allows you to cancel certain operations on the Digi 002, such as Channel View selections. The Escape/Cancel switch also functions as a “cancel” button for many on-screen dialogs in Pro Tools.

Transport and Navigation Controls

These Digi 002 controls mirror the operation of on-screen transport and navigation controls in Pro Tools. In addition, Function keys allow you to invoke special control surface commands and move quickly between different display modes.

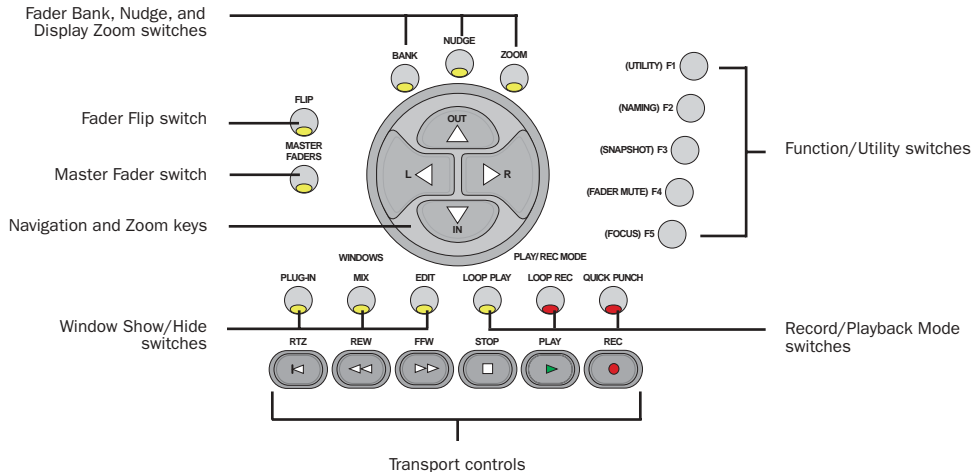

Digi 002 transport and navigation controls

Transport Controls

These switches correspond to transport functions in Pro Tools.

RTZ (Return to Zero) Sets the playback cursor to the beginning of the session

REW (Rewind) Rewinds through the session from the current cursor position

FFW (Fast Forward) Fast-forwards through the session from the current cursor position

STOP Stops playback or recording

PLAY Begins playback from the current cursor position

REC (Record) Arms Pro Tools for recording

Record/Playback Mode Switches

Loop Play Toggles Loop Playback on and off

Loop Rec Toggles Loop Record mode on and off

QuickPunch Toggles QuickPunch Record mode on and off

Window Show/Hide Switches

Plug-In Opens or closes the window for the currently selected plug-in

Mix Opens, brings forward, or closes the Pro Tools Mix window

Edit Opens, brings forward, or closes the Pro Tools Edit window

Navigation and Zoom Section

These multi-purpose keys control the display of Pro Tools tracks on the Digi 002 control surface, on-screen zoom functions, and other Pro Tools navigation functions.

Fader Bank, Nudge and Display Zoom Switches

Bank When the Bank switch is lit, the Left and Right arrow keys move the Digi 002 tracks across the Pro Tools mixer eight faders at a time.

Nudge When the Nudge switch is lit, the Left and Right arrow keys move the Digi 002 tracks across the Pro Tools mixer one track at a time.

Zoom When the Zoom switch is lit, the Left and Right arrow keys zoom the Pro Tools Edit window display horizontally, and the In and Out keys zoom the display vertically.

Navigation and Zoom Keys

Text Entry Fields When you are editing numerical values such as Selection Start, End, and Length, or Pre- and Post-Roll in the Edit or Transport windows, the Left and Right arrow keys let you navigate among editable fields. The In and Out keys increment or decrement the selected value.

Selection In/Out Points In Bank and Nudge modes, the Navigation keys mirror the function of the Up and Down arrow keys on the computer keyboard. You can press these keys to mark In and Out points during playback, in order to make selections in the Pro Tools Edit window. If you have already made a selection in the Edit window, the Up and Down arrow keys move the selection up and down your track list.

Function/Utility Switches

F1 (Utility) Enters Utility mode during Digi 002 stand-alone operation only. This is where you set control surface and input preferences, as well as run pre-programmed diagnostic tests on the Digi 002 unit.

F2 (Naming) Allows you to name channels while using Digi 002 in Stand-alone mode only. (See “Naming Channels” on page 107.)

F3 (Snapshot) Allows you to store and recall up to 24 mixer configurations for quick recall or for use as mixer templates, in Stand-alone mode only. (See “Storing Snapshots” on page 114.)

F4 (Fader Mute) Temporarily disables Digi 002 fader movement while working with Pro Tools, allowing you to monitor audio playback without fader noise. To disable fader movement, press F4 while in Pro Tools mode. To restore fader movement, press F4 a second time.

The Fader Mute feature has no effect on fader automation or audio levels during playback.

F5 (Focus) Displays controls in the Digi 002 Channel Scribble Strips for the currently active plug-in window, as in Channel View. To return to the last Console view, press F5 a second time.

Mic/Line/Instrument Input Controls

Digi 002 is equipped with four high-quality preamplifiers with adjustable gain and phantom power (switchable in pairs, for Inputs 1–2 and Inputs 3–4). The phantom power switches are on the back panel of Digi 002.

Inputs 1–4 accept microphone, instrument (direct in) or line-level signals. Inputs 5–8 accept line-level signals only.

When Digi 002 is used to control Pro Tools, these inputs show up as “Mic/Line 1–4” in the default Pro Tools I/O Setup.

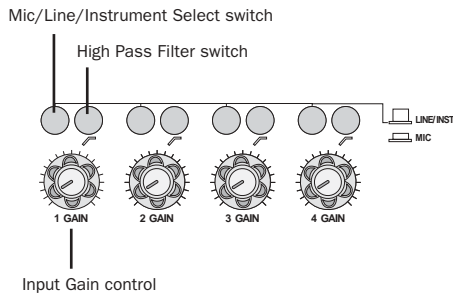

Digi 002 input controls for Inputs 1–4

Inputs 1–4 have the following controls:

Mic/Line/Instrument Selector This switch toggles the input between microphone or line (instrument) operating levels.

High Pass Filter Switch This switch enables a high pass filter (75 Hz, 12 dB/octave rolloff) on the input, for filtering out rumble or AC hum.

Input Gain Control This knob adjusts gain for the input, with a range of +15 dB to +60 dB of gain.

⚠ Engage the Mic selector only if you have an XLR cable plugged in to the mic connector. Leaving the switch engaged with nothing connected may introduce low-level noise.

Monitor Section

The Monitor section of Digi 002 provides several options for routing outputs and monitoring alternate input sources.

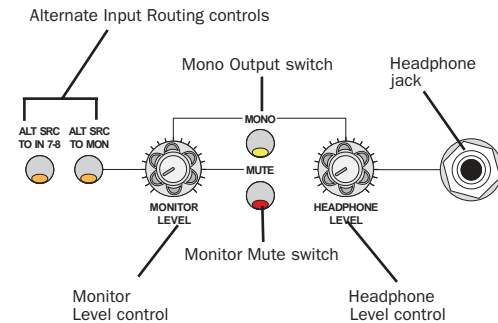

Digi 002 monitor and headphone controls

Alternate Input Routing Controls

In addition to its 8 standard analog inputs, Digi 002 provides a separate –10 dBV input pair for a device such as a CD player or tape deck.

Alt Src to Mon This switch routes the –10 dBV input pair directly to the Monitor and Headphone Outputs on Digi 002. This function also works when Digi 002 is in Stand-alone mode.

Alt Src to 7–8 This switch routes the –10 dBV input pair directly to Inputs 7 and 8 of Pro Tools, and does not send it to the Monitor Outputs. This allows you to route the input signal directly into Pro Tools without the need to repatch any cables.

When Alt Src to 7–8 is enabled, analog inputs 7–8 (1/4-inch TRS connectors on the back panel of Digi 002) are disabled.

Monitor and Headphone Level Controls

Monitor Level Control Digi 002 provides a pair of Monitor Outputs that mirror its Main Outputs (or outputs 1–2), which correspond to outputs 1–2 in Pro Tools. This knob controls the volume of those Monitor Outputs.

Headphone Level Control The Headphone Output on Digi 002 also mirrors outputs 1–2 in Pro Tools, and is independent of the Monitor Outputs. This knob controls the volume of the independent Headphone Output.

Monitor Mute Switch This switch mutes the Digi 002 Monitor Outputs only, and has no effect on the Main Outputs or the Headphone Output. Monitor Mute is automatically engaged when you power up the Digi 002 unit.

Mono Output Switch This switch temporarily combines the output signals 1 and 2 in both the Monitor Outputs and the Headphone Output. This is helpful for checking phase relationships of stereo material. The Mono Output switch has no effect on the Main Outputs.

Headphone Jack This jack accepts a standard 1/4-inch stereo headphone connector.

Keyboard Modifier Switches

Many keyboard commands in Pro Tools use *modifier keys*, which are pressed in combination with other keys or with a mouse action.

 Refer to the electronic PDF versions of the *Pro Tools Reference Guide* and the *Keyboard Shortcuts* for more information.

The Modifier switches on the left-hand side of Digi 002 mirror the functions of modifier keys on the computer keyboard. You can use these switches on Digi 002 in any combination with keys on your computer while working with Pro Tools.

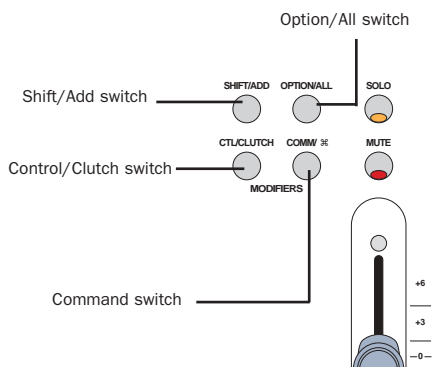

Digi 002 keyboard modifier keys

Shift/Add Switch Allows you to extend a track selection or add to a group of selected items

Option/All Switch Applies an action or command to all tracks in a Pro Tools session

Control/Clutch Switch Temporarily disengages a control from grouped behavior

Command Switch Allows fine adjustment of controls and automation breakpoints

Status Indicators and Display Controls

The area above the Transport and Navigation Controls on Digi 002 contains status indicators, an 8-character LED Scribble Strip, and controls for displaying information about Pro Tools sessions.

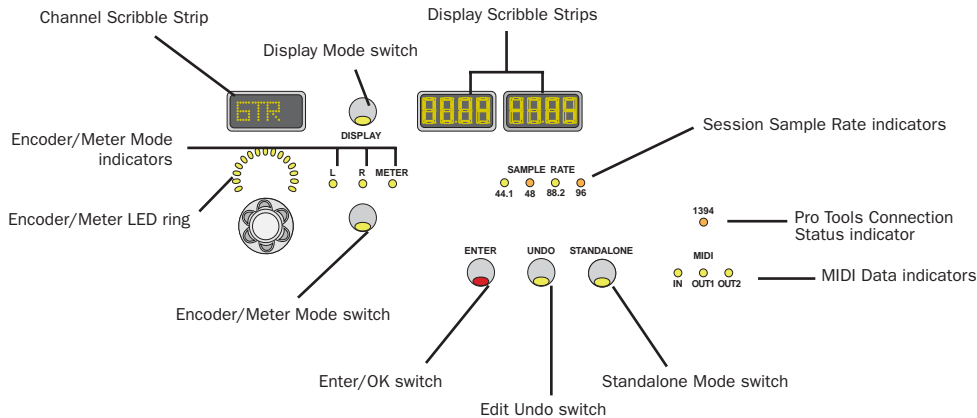

Digi 002 status indicators and display controls

Display Scribble Strips and Display Mode Switch

The Display Scribble Strips have two modes: Status mode, which shows the current status of the Channel Scribble Strips, and Counter mode, which mirrors the main counter in Pro Tools. To toggle between the two display modes, press the Display Mode switch directly to the left of the Display Scribble Strips.

In addition, pressing the Command switch in tandem with the Display Mode switch allows you to set channels to display numerical parameter values by default, rather than control names. For example, in Pan view, when you press Command+Display, fader volume levels (in dB) are the default display.

Status Mode

In Status mode, the Display Scribble Strips show information about the current view.

Console View When Digi 002 is in Console View, the Display Scribble Strips show which Console mode is active (Pan, Send, or Insert).

When in Pan mode, the Display Scribble shows which pan controls are visible in the rotary encoders, left pan or right pan. (Right pan controls are available for stereo tracks only.)

When in Send mode, the Display Scribble shows the position of the displayed send (A–E).

When in Insert mode, the Display Scribble shows the position of the displayed insert (A–E).

Channel View When Digi 002 is first put into Channel View, the Display Scribble Strips on the right-hand side of the unit identify which Channel View selector is active (EQ, Dynamics, Inserts, or Pan/Send).

When plug-in controls are displayed in the Channel Scribble Strips, the Display Scribble shows the name of the plug-in.

When pan and send controls are shown in the Channel Scribble Strips, the Display Scribble shows the name of the parent track.

While in Channel View, you can hold the Display Mode switch and press an active track's Channel Select switch to temporarily display an expanded description of its function.

Counter Mode

In Counter mode, the Display Scribble Strips show the current value in the Pro Tools Main Location indicator. This value can be in Bars:Beats, Minutes:Seconds, or Samples, depending on which of these is chosen as the Main Time Scale in Pro Tools.

The Display Mode switch is lit when Digi 002 is in Counter mode.

Pan/Meter Indicators and Encoder/Meter Mode Switch

The Pan/Meter indicators show what type of data is displayed in the Encoder/Meter LED ring: *L* indicates left pan, *R* indicates right pan (available on stereo channels or sends), and *Meter* indicates that the Encoder LEDs are functioning as level meters.

For stereo tracks or sends, when *L* and *Meter* are both lit, the LED rings display levels for the left channel; when *R* and *Meter* are both lit, the LED rings display levels for the right channel.

Enter/OK Switch

Pressing the Enter/OK switch is equivalent to pressing Return or Enter on the computer keyboard. This allows you to OK on-screen dialogs and create new Memory Locations in Pro Tools directly from the control surface.

Edit Undo Switch

Pressing the Edit/Undo switch is equivalent to choosing Edit > Undo in Pro Tools. (See the *Pro Tools Reference Guide* for details on multiple undo capabilities.)

Standalone Mode Switch

The Standalone Mode switch turns Digi 002 into a stand-alone 8-channel mixer. (See Chapter 10, "Using Digi 002 as a Stand-Alone Mixer.")

Session Sample Rate Indicators

The Session Sample Rate LEDs indicate the sample rate of the current Pro Tools session.

Pro Tools Connection Status Indicator

This status LED, marked "1394," indicates that communication has been established between Digi 002 and Pro Tools LE software via FireWire.

MIDI Data Indicators

The MIDI Data LEDs indicate the presence of MIDI data on the Digi 002 MIDI In or MIDI Out ports.

chapter 6

The Digi 002 Rack Front Panel

The Digi 002 Rack front panel includes controls for Inputs 1–4, options for routing outputs and monitoring alternate input sources, and indicators for session sample rate, connections status, and MIDI data.

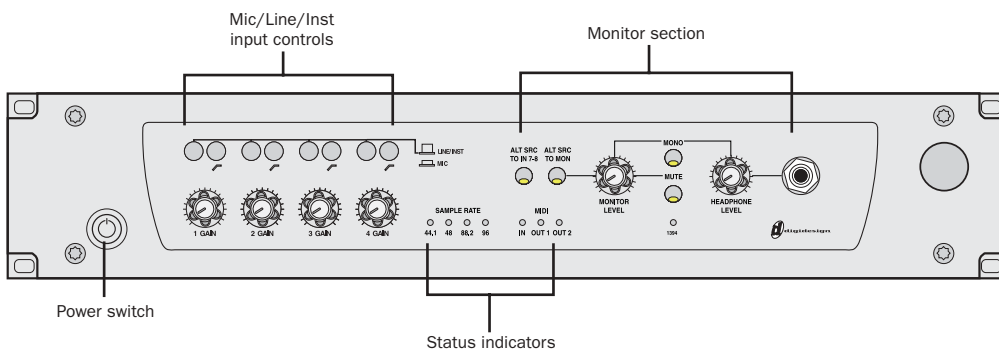

Figure 2. Digi 002 Rack front panel

Mic/Line/Instrument Input Controls

Digi 002 Rack is equipped with four high-quality preamplifiers with adjustable gain and phantom power (switchable in pairs, for Inputs 1–2 and Inputs 3–4). The phantom power switches are on the back panel of Digi 002 Rack.

Inputs 1–4 accept microphone, instrument (direct in) or line-level signals. Inputs 5–8 accept line-level signals only.

These inputs appear as “Mic/Line 1–4” in the default Pro Tools I/O Setup.

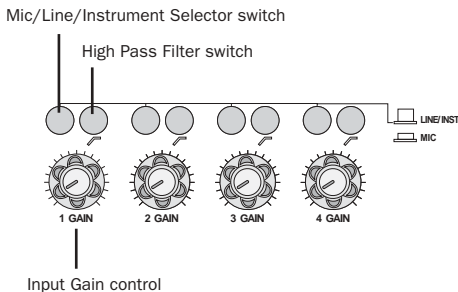

Digi 002 Rack input controls for Inputs 1–4

Inputs 1–4 have the following controls:

Mic/Line/Instrument Selector This switch toggles the input between microphone or line (instrument) operating levels.

High Pass Filter Switch This switch enables a high pass filter (75 Hz, 12 dB/octave rolloff) on the input, for filtering out rumble or AC hum.

Input Gain Control This knob adjusts gain for the input, with a range of +15 dB to +60 dB of gain.

⚠ Engage the Mic selector only if you have an XLR cable plugged in to the mic connector. Leaving the switch engaged with nothing connected may introduce low-level noise.

Monitor Controls

The Monitor controls of Digi 002 Rack provide several options for routing outputs and monitoring alternate input sources.

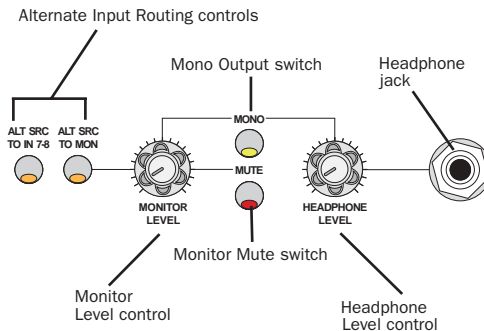

Digi 002 Rack monitor and headphone controls

Alternate Input Routing Controls

In addition to its 8 standard analog inputs, Digi 002 Rack provides a separate –10 dBV input pair for a device such as a CD player or tape deck.

Alt Src to 7–8 This switch routes the –10 dBV input pair directly to Inputs 7 and 8 of Pro Tools, and does not send it to the Monitor Outputs. This allows you to route the input signal directly into Pro Tools without the need to repatch any cables.

When Alt Src to 7–8 is enabled, analog inputs 7–8 (1/4-inch TRS connectors on the back panel of Digi 002 Rack) are disabled.

Alt Src to Mon This switch routes the –10 dBV input pair directly to the Monitor and Headphone Outputs on Digi 002 Rack.

Monitor and Headphone Level Controls

Monitor Level Control Digi 002 Rack provides a pair of Monitor Outputs that mirror its Main Outputs (or outputs 1–2), which correspond to outputs 1–2 in Pro Tools. This knob controls the volume of those Monitor Outputs.

Headphone Level Control The Headphone Output on Digi 002 Rack also mirrors outputs 1–2 in Pro Tools, and is independent of the Monitor Outputs. This knob controls the volume of the independent Headphone Output.

Monitor Mute Switch This switch mutes the Digi 002 Rack Monitor Outputs only, and has no effect on the Main Outputs or the Headphone Output. Monitor Mute is automatically engaged when you power up the Digi 002 Rack unit.

Mono Output Switch This switch temporarily combines the output signals 1 and 2 in both the Monitor Outputs and the Headphone Output. This is helpful for checking phase relationships of stereo material. The Mono Output switch has no effect on the Main Outputs.

Headphone Jack This jack accepts a standard 1/4-inch stereo headphone connector.

Status Indicators

Session Sample Rate Indicators

The Session Sample Rate LEDs indicate the sample rate of the current Pro Tools session.

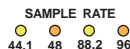

Digi 002 Rack Sample Rate LEDs

Pro Tools Connection Status Indicator

This status LED, marked “1394,” indicates that communication has been established between Digi 002 Rack and Pro Tools LE software through FireWire.



Connection Status LED

MIDI Data Indicators

The MIDI Data LEDs indicate the presence of MIDI data on the Digi 002 Rack MIDI In or MIDI Out ports.



MIDI Data LEDs

chapter 7

Digi 002 and Digi 002 Rack Back Panels

The Digi 002 and Digi 002 Rack back panels house all the audio, MIDI and computer connectors for the unit. The function of each connector and their associated switches are explained in this section.

See Figure 3 on page 50 and Figure 4 on page 50.

Operating Levels and Headroom

All Digi 002 and Digi 002 Rack audio inputs and outputs are set for 14 dB of headroom below 0 dB, or full code. This means at the nominal reference input level (+4 dBu or -10 dBV) you can have up to 14 dB of headroom before input or output clipping occurs.

The maximum input and output of Digi 002 or Digi 002 Rack using balanced TRS cables on any of the +4 dBu, 1/4-inch connectors is +18 dBu (6.15 Vrms).

Sample Rate and Resolution Support

The Analog-to-Digital and Digital-to-Analog converters on all Digi 002 and Digi 002 Rack analog inputs and outputs, as well as the S/PDIF Digital I/O ports, support sample rates of 44.1, 48, 88.2, and 96 kHz. The Optical I/O ports support sample rates of 44.1 and 48 kHz in ADAT Optical mode, and sample rates up to 96 kHz in Optical S/PDIF mode.

All the analog and digital inputs and outputs on Digi 002 and Digi 002 Rack support up to 24-bit resolution audio.

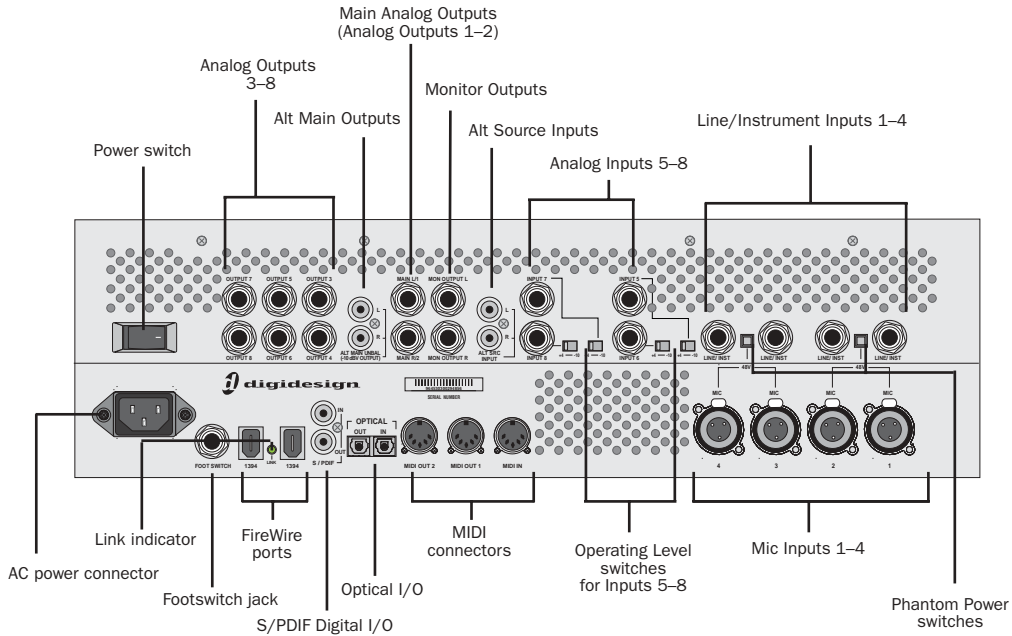

Figure 3. Digi 002 back panel

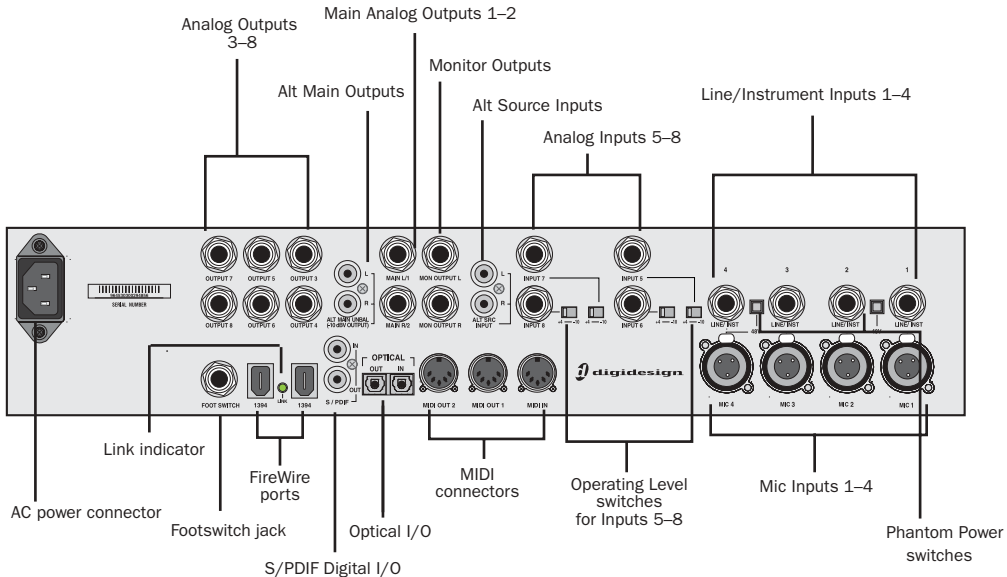

Figure 4. Digi 002 Rack back panel

Analog Inputs

Mic Inputs 1–4

These are balanced, three-conductor XLR connectors for microphone-level analog inputs. Gain is controlled by the corresponding Input Gain control (on the top panel of Digi 002, and on the front panel of Digi 002 Rack).

Line/Instrument Inputs 1–4

These are balanced, 1/4-inch TRS jacks for line-level or instrument-level analog audio input connections. Operating levels for these line/instrument inputs are fixed at +4 dBu. Gain is controlled by the corresponding Input Gain knob (on the top panel of Digi 002, and on the front panel of Digi 002 Rack).

Unbalanced connections are also possible with the use of standard 1/4-inch mono plugs.

⚠ *Digidesign does not recommend the use of unbalanced cables. Unbalanced connections may introduce noise into your audio system. Whenever possible, use balanced cables to make connections to Digi 002 and Digi 002 Rack.*

Phantom Power

These switches apply 48V phantom power to Inputs 1–2 and Inputs 3–4 channel pairs respectively, for microphones that require phantom power to operate.

Dynamic microphones (like a Shure SM57) do not require phantom power to operate, but are not harmed by it. Most *condenser* microphones (like an AKG C3000) *do* require phantom power

to operate. If you are not sure about the phantom power requirements for your microphone, contact the manufacturer, or read your microphone's documentation.

⚠ *Although phantom power can be used safely with most microphones, ribbon microphones can be damaged by it. Always turn off phantom power and wait at least 30 seconds before connecting a ribbon microphone.*

Analog Inputs 5–8

These are balanced, 1/4-inch TRS jacks for line-level analog audio input connections.

Operating levels for each of these line-level inputs is switchable between +4 dBu and –10 dBV, using the Operating Level switches immediately to the right of the input jacks.

While Inputs 5–8 do accept unbalanced connections, this may result in a noisier signal than a balanced-to-balanced connection. If the devices you are connecting to Digi 002 or Digi 002 Rack have balanced outputs, be sure to use balanced cables for optimal signal-to-noise performance.

Alt Source Inputs

These are unbalanced, two-conductor RCA-connectors for connecting alternate audio sources such as CD players or tape decks. The signal from these inputs can be routed directly to the Monitor Outputs (for monitoring) or to Inputs 7–8 (for direct input into Pro Tools) from the top panel of Digi 002 (or the front panel of Digi 002 Rack). Operating levels for these inputs are fixed at –10 dBV.

Analog Outputs

Monitor Outputs

These are balanced, 1/4-inch TRS jacks for line-level analog audio output connections. These outputs correspond to Outputs 1–2 in Pro Tools, allowing you to route mixes to a studio monitoring system. Operating levels for these outputs are fixed at +4 dBu.

Monitor Output level is controlled by the Monitor Level knob on the top panel of Digi 002 (or the front panel of Digi 002 Rack).

Main Analog Outputs 1–2

These are balanced, 1/4-inch TRS jacks for line-level analog audio output connections. Operating levels for these outputs are fixed at +4 dBu.

While the Main Analog Outputs do accept unbalanced connections, this may result in a noisier signal than a balanced-to-balanced connection. If the devices you are connecting to Digi 002 or Digi 002 Rack have balanced inputs, be sure to use balanced cables for optimal signal-to-noise performance.

Alt Main Analog Outputs 1–2

These are unbalanced, two-conductor RCA connectors for direct output to devices such as stereo receivers or tape decks. Operating levels for these inputs are fixed at –10 dBV.

Analog Outputs 3–8

These are balanced, 1/4-inch TRS jacks for line-level analog audio output connections. Operating levels for these outputs are fixed at +4 dBu. Unbalanced connections are also supported with the use of standard 1/4-inch mono plugs.



If you plan on connecting Analog Outputs 3–8 to –10 dBV gear, you may want to place a transformer-based line level attenuator between the Digi 002 or Digi 002 Rack output and the input of the destination device to compensate for level differences.

Digital I/O

S/PDIF Digital I/O

The Sony Phillips Digital Interface Format (S/PDIF) is used in many professional and consumer CD players and DAT recorders. These S/PDIF input and output jacks are unbalanced 2-conductor phono (RCA) jacks that utilize a full 24-bit, 2-channel digital data stream. To avoid RF interference, use 75-ohm coaxial cable for S/PDIF transfers and keep the cable length to a maximum of 10 meters.

Digi 002 and Digi 002 Rack support *consumer mode* S/PDIF output format (IEC-958 Type 2) at sample rates of 44.1 kHz and 48 kHz, and *professional mode* S/PDIF output format (IEC-958 Type 1) at sample rates of 88.2 kHz and 96 kHz. For information on which S/PDIF formats are supported by your S/PDIF-compatible gear, refer to the manufacturer's documentation.

Optical I/O

These are a pair of TOS-link style connectors for ADAT Optical (8 channels of I/O) or S/PDIF Optical (2 channels of I/O) devices. You can choose between these Optical I/O formats in the Pro Tools Hardware Setup dialog. When transferring material in one of these formats to Pro Tools, be sure to select the appropriate Optical I/O format as the Clock Source in the Hardware Setup dialog.

The Optical I/O ports support sample rates of 44.1 and 48 kHz in ADAT Optical mode, and sample rates up to 96 kHz in Optical S/PDIF mode. The Optical I/O ports support 24-bit, 20-bit and 16-bit resolutions in both modes.

The Optical I/O ports use a standard optical “lightpipe” cable.

About Lightpipe-Compatible Devices

Lightpipe is an industry standard, eight-channel optical digital audio connection developed by Alesis. Lightpipe is found on many devices, including Optical (ADAT) decks, modular digital multitracks (MDMs), sound cards, stand-alone A/D or D/A converters, and digital consoles.

MIDI Connectors

Digi 002 and Digi 002 Rack can act as a MIDI interface. With one MIDI input and two MIDI outputs, Digi 002 and Digi 002 Rack provide 16 channels of MIDI input and 32 channels of MIDI output.

 *MIDI ports are only active when Pro Tools is launched.*

A MIDI driver for these MIDI ports is installed when you install Pro Tools LE, and is recognized automatically by Windows Multimedia (Windows) and Audio MIDI Setup (Macintosh). These connectors accept standard 5-pin MIDI cables.

IEEE-1394 (FireWire) Ports

These ports, marked “1394” in reference to their IEEE specification, are commonly known as *FireWire* ports. These provide connections to the computer and other FireWire devices.

FireWire offers a high rate of data transfer and reliability that makes it ideal for audio applications. FireWire devices can be daisy-chained together without the need for terminators.

Connecting Digi 002 or Digi 002 Rack and FireWire Hard Drives

The FireWire ports on Digi 002 and Digi 002 Rack do not pass audio data when they are powered off, so if you daisy-chain FireWire devices from your computer, it is best to connect FireWire hard drives directly to your computer and not to Digi 002. This will prevent hard drive errors and data loss in case the Digi 002 unit is powered off.

Connecting other FireWire Devices to Digi 002 or Digi 002 Rack

The second FireWire port on Digi 002 or Digi 002 Rack is available for daisy-chaining FireWire devices such as digital cameras or digital video recorders. Even when they are powered off, Digi 002 and Digi 002 Rack supply power from the computer through their FireWire ports, letting you recharge batteries in other FireWire devices.

Footswitch Jack

This connector allows footswitch control of QuickPunch audio punch-in and punch-out, and MIDI punch-in and punch-out recording features. Both continuous on/continuous off and instantaneous on/off pedals with a 1/4-inch TRS connector are supported. For more information, see “QuickPunch Recording” on page 88.

Power Switch and AC Power Connector

The AC power connectors on Digi 002 and Digi 002 Rack accept a standard modular AC power cable.

Digi 002 and Digi 002 Rack are auto power-selecting (100V to 240V) and will work automatically when plugged into an AC power receptacle in any country.

Link Indicator

The Link indicator lights when Pro Tools is launched and the connection to the Digi 002 or Digi 002 Rack is recognized.

chapter 8

Connecting Your Studio

This chapter explains how to connect your Digi 002 or Digi 002 Rack to a monitoring system, digital recorders, and other studio devices, and how to connect audio sources for recording.

Connecting Digi 002 or Digi 002 Rack to a Computer

Your studio setup will differ depending on the type of work you do and the equipment in your studio. The illustrations that follow show two possible setups. Figure 5 shows Digi 002 as the hub of a small recording and mastering studio with Pro Tools. Figure 6 shows Digi 002 Rack as part of a small composing workstation.

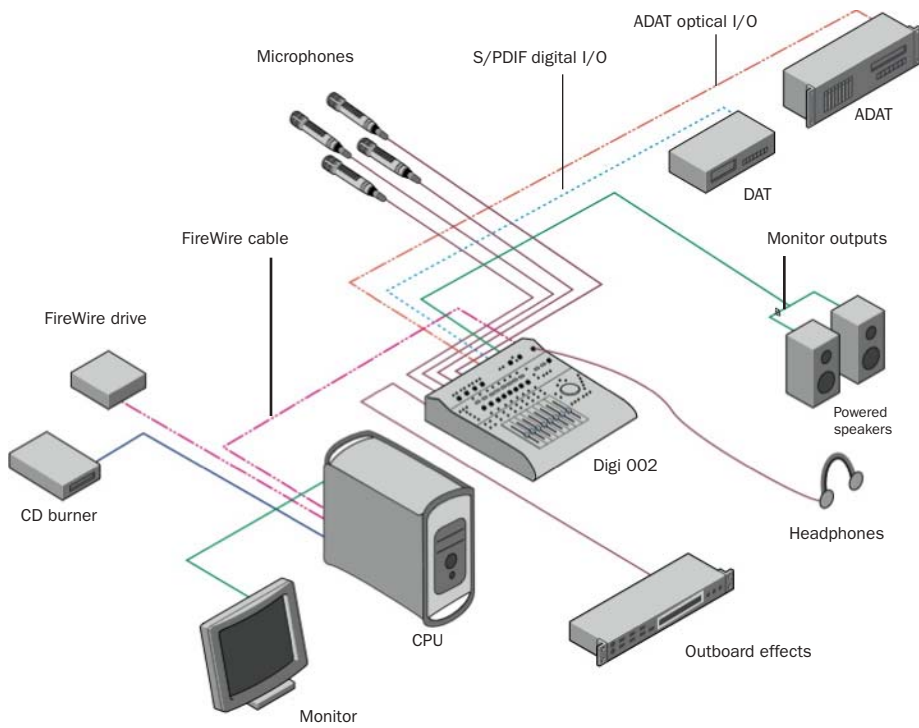

Figure 5. Digi 002 project studio configuration running Pro Tools on a desktop computer

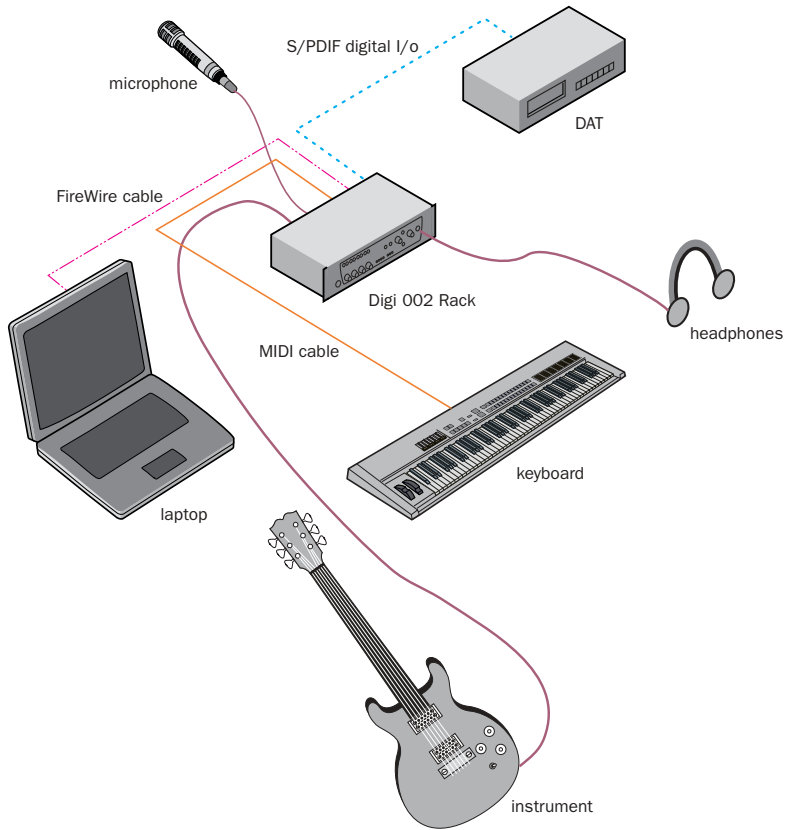

Figure 6. Digi 002 Rack micro studio configuration running Pro Tools on a laptop computer

Monitoring Audio

You can use Digi 002 and Digi 002 Rack with a variety of audio monitoring setups, including a power amplifier and speakers, self-powered speakers, and headphones.

The Digi 002 and Digi 002 Rack Monitor Outputs and Headphone Output mirror the output signal on Main Outputs 1–2. The Monitor Output and Headphone Output levels are directly affected by the following front panel controls:

Monitor Mute When you power up Digi 002 or Digi 002 Rack, the Monitor Outputs are automatically muted. To unmute the Monitor Outputs, press the Mute switch (located at the top right-hand corner of Digi 002, and on the front panel of Digi 002 Rack).

Monitor Level and Headphone Level Levels for the Monitor Output and Headphone Output are adjusted separately with the level controls (located in the upper right-hand side of the Digi 002 top panel, and on the front panel of the Digi 002 Rack).

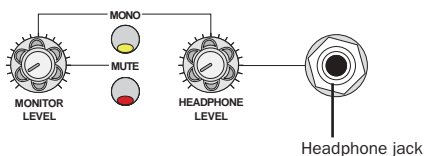

Monitor Level controls (located on the top panel of Digi 002, and on the front panel of Digi 002 Rack)

Connecting Headphones

To connect headphones:

1 Connect headphones to the Headphone jack on the Digi 002 or the Digi 002 Rack. The Headphone input accepts a stereo 1/4-inch plug. If your headphones have a smaller mini-plug, you can purchase an adapter from your local dealer. For best results, use high-quality, closed-ear headphones.

2 Adjust headphone volume with the Headphone Level knob.

⚠ *The Digi 002 and Digi 002 Rack Headphone Outputs can produce very loud output levels. Prolonged exposure can cause hearing damage. Adjust headphone volume carefully.*

Connecting Monitor Speakers

To connect monitor speakers with a power amp or self-powered monitor speakers:

1 Connect 1/4-inch cables to the left and right Monitor Outputs on the back of the Digi 002 or the Digi 002 Rack.

2 Connect the other end of the cables to the left and right power amp inputs, or to the left and right self-powered speakers.

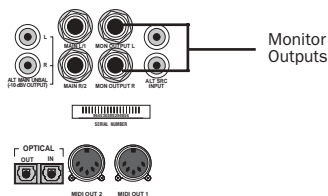

Monitor Outputs (back panel)

Connecting Audio Sources to Digi 002 or Digi 002 Rack

You can connect both analog and digital audio signal sources to Digi 002 or Digi 002 Rack.

⚠ Before making any audio connections to Digi 002 or Digi 002 Rack, turn down Monitor and Headphone levels or mute the Monitor Output to prevent damage to your monitoring system.

Analog Audio Connections

Digi 002 and Digi 002 Rack have eight analog inputs, plus two additional inputs for alternate analog sources, such as a tape deck or CD player.

Microphone-Level Signals

Analog audio signals are output by microphones, synths, mixers, and instruments with magnetic pickups. Of these sources, microphones and magnetic pickup instruments (such as electric guitars) output the quietest signals, and generally require the most amplification.

Digi 002 and Digi 002 Rack include preamps for these sources on Inputs 1–4, with adjustable gain and available 48-volt phantom power. These inputs have both XLR and 1/4-inch connectors; the XLR inputs are specifically for connecting microphones, and the 1/4-inch inputs are for connecting instrument outputs.

Line-Level Signals

Keyboards, preamps, and mixers output line-level audio, which varies with each device between the -10 dBV and $+4$ dBu standards.

You can connect line-level devices to any of Digi 002 or Digi 002 Rack's Inputs 1–8, as follows:

Inputs 1–4 Inputs 1–4 have both XLR and 1/4-inch TRS connectors. The XLR connectors are for connecting microphones only. The 1/4-inch TRS connectors are for connecting line-level devices or instruments. Since these inputs have adjustable gain, they are especially useful for devices that output low-level signals.

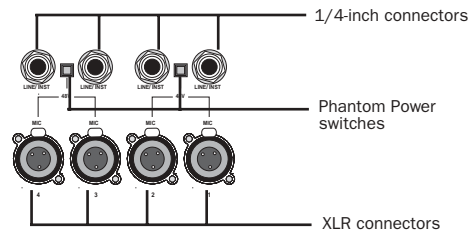

Mic/Line Inputs 1–4 (back panel)

⚠ The XLR connectors on Inputs 1–4 are wired specifically to match the impedance of microphones. Do not use these XLR connectors for line inputs; use the 1/4-inch connectors instead.

Inputs 5–8 These inputs accept 1/4-inch balanced or unbalanced connections, and can be switched between -10 dBV and $+4$ dBu operation.

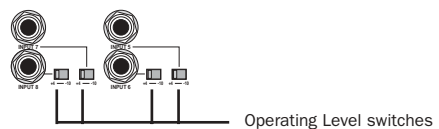

Line Inputs 5–8 (back panel)

Making Analog Audio Connections

To connect an analog audio source to Digi 002 or Digi 002 Rack, do the following for your type of input:

Microphones Plug a microphone directly into any of the available XLR Microphone Inputs 1–4 on the back panel of the Digi 002 or Digi 002 Rack.

- Press the Mic/Line/Instrument Selector switch (located on the top panel of Digi 002, and on the front panel of Digi 002 Rack) for the corresponding input so that it is in the “Mic” position.

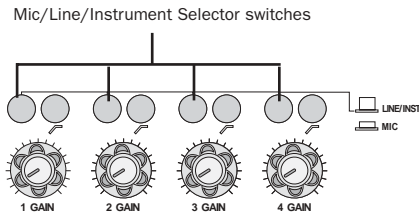

Mic/Line/Instrument Selector switches (located on the front panel of Digi 002, and top panel of Digi 002 Rack)

- If your microphone requires phantom power, press the Phantom Power switch (labeled 48V) on the back panel for the corresponding input pair.

⚠ Although phantom power can be used safely with most microphones, ribbon microphones can be damaged by it. You should always turn off phantom power and wait at least 30 seconds before connecting or disconnecting a ribbon microphone.

Instruments Without Preamps Plug instruments that output low-level signals (such as electric guitars) directly into any of the available 1/4-inch TRS Inputs 1–4 on the back panel of Digi 002 or Digi 002 Rack. Since these inputs have adjustable gain, they are especially useful for devices that output low-level signals

- Press the Mic/Line/Instrument Selector switch (located on the top panel of Digi 002, and on the front panel of Digi 002 Rack) for the corresponding input so that it is in the “Line/Inst” position. Inputs 1–4 are designed for input signals with a nominal operating level of +4 dBu. (The Input gain knob should be turned down all the way for +4 dBu devices at unity gain.)

Line-Level Devices Plug line-level sources (such as a synthesizer, or a microphone or guitar that has been amplified by an outboard preamp) into any of the 1/4-inch analog inputs on the back of Digi 002 or Digi 002 Rack.

- For Inputs 1–4, press the Mic/Line/Instrument Selector switch (located on the top panel of Digi 002, and on the front panel of Digi 002 Rack) for the corresponding input so that it is in the “Line/Inst” position. Inputs 1–4 are designed for input signals with a nominal operating level of +4 dBu. (The Input gain knob should be turned down all the way for +4 dBu devices at unity gain.)

- For Inputs 5–8, choose either a –10 dBV or +4 dBu operating level for the corresponding input using the switch on the back panel. For information on the appropriate operating level for your input device, refer to the manufacturer’s specifications.

Digital Audio Connections

Digi 002 and Digi 002 Rack each provide up to ten digital inputs and outputs, including:

- Optical input and output for eight channels of ADAT input or two channels of Optical S/PDIF input
- Two channels of S/PDIF digital input and output (RCA connectors)

ADAT Format

The ADAT format was developed by Alesis for use in their ADAT multitrack recorders. Each ADAT optical connection provides eight channels of digital audio with 24-bit capability. You can connect an ADAT or other ADAT optical format device directly to the Optical I/O on the Digi 002 or Digi 002 Rack (see “Connecting an ADAT” on page 64). The optical I/O connectors accept optical cables.

When set for ADAT format, these Optical ports support 44.1 kHz or 48 kHz sample rates only.

S/PDIF

S/PDIF (Sony/Phillips Digital Interchange Format) I/O is available on many DAT decks, compact disc players, and other digital devices. Each S/PDIF connection provides 2 channels of digital audio with 24-bit capability. You can connect a S/PDIF digital input to either the Optical connector or to the S/PDIF RCA connector on the back panel of the Digi 002 or the Digi 002 Rack (see “Connecting a Digital Deck (DAT)” on page 64). The Optical connectors accept standard optical “lightpipe” cables; the RCA connectors accept standard RCA cables.

Both the RCA and Optical ports accept S/PDIF signals at sample rates up to 96 kHz.

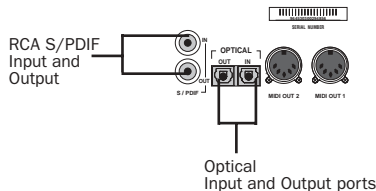

Digital connectors (back panel)

- ▲ *Only one S/PDIF input pair can be used at a time. For example, if you use the optical input for S/PDIF data, you cannot use the RCA inputs.*

Using External Effects Devices

The Digi 002 and Digi 002 Rack can make dedicated connections to external analog or digital devices. You can send and return signals to analog devices using the analog inputs and outputs on the Digi 002 and the Digi 002 Rack. You can also send and return a digital signal to an external device that supports digital I/O (such as a reverb unit), and monitor the return by connecting its analog outputs to available inputs on Digi 002 and Digi 002 Rack.

When you use the digital inputs and outputs on your Pro Tools LE system as effects sends and returns to a digital effects device, Pro Tools LE should be the clock master in most cases. Set your digital effects device to accept an external digital clock so that it synchronizes to Pro Tools LE.

To connect an external analog device to your system:

- 1 Connect each input of the external signal processor to an available analog output on the Digi 002 or Digi 002 Rack.
- 2 Connect each output of the external signal processor to an available analog input on the Digi 002 or Digi 002 Rack.

 *If you plan to use the external device as an Insert in Pro Tools, connect it to inputs and outputs of the same number (for example, Input 5 and Output 5) of Digi 002 or Digi 002 Rack.*

To set up a send to an external digital effects device (digital sends/returns only):

- 1 Connect the digital inputs and outputs of the external signal processor to the appropriate digital connectors (the S/PDIF RCA connectors or the Optical ports) on Digi 002 or Digi 002 Rack.
- 2 In Pro Tools, choose Setup > Hardware.
- 3 Under Digital Input, select one of the following options:
 - If the external effects device is connected to the S/PDIF RCA jacks, select “RCA = S/PDIF.”
 - If the external effects device is a S/PDIF device and connected to the Optical ports, select “Optical = S/PDIF.”
 - If the external effects device is an ADAT Optical compatible device, select “Optical = ADAT.”
- 4 Choose Internal from the Clock Source pop-up menu.

5 Click OK.

 *You can use the I/O Setup dialog (Setup > I/O) to label the inputs and outputs you are using in Pro Tools LE and identify them as inserts or sends when working in a session. Refer to the Pro Tools Reference Guide for details.*

Monitoring and Recording from Alternate Sources

Digi 002 and Digi 002 Rack provide a pair of additional inputs for monitoring and recording from an external sound source such as a CD player or tape deck. This alternate input is equipped with standard RCA connectors and is designed for input signals with a nominal operating level of -10 dBV.

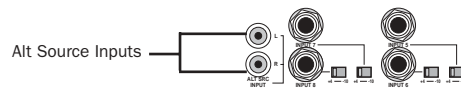

Alternate Source Input connectors (back panel)

To monitor an alternate sound source through the Digi 002 or Digi 002 Rack Monitor Outputs:

- 1 Connect the outputs of the external device to the left and right Alternate Source Inputs on the back panel of Digi 002 or Digi 002 Rack.
- 2 Press the “Alt Src to Mon” switch (located on the top panel of Digi 002, and on the front panel of Digi 002 Rack) to route the signal to the Monitor Output.
- 3 Adjust Monitor Output or Headphone Output levels to audition the input.

 *To monitor an external device through the Alternate Source Inputs, Digi 002 or Digi 002 Rack must be powered on.*

To record an alternate sound source directly into Pro Tools:

- 1 Connect the outputs of the external device to the left and right Alternate Source Inputs on the back panel of Digi 002 or Digi 002 Rack.
- 2 Press the “Alt Src to 7–8” switch (located on the top panel of Digi 002, and on the front panel of Digi 002 Rack) to route the signal directly to Inputs 7–8 in Pro Tools.

When the “Alt Src to 7–8” switch is engaged, Inputs 7 and 8 on the back panel are inactive. Also, because the signal can be monitored from Pro Tools, it no longer passes directly to the Monitor Outputs.

Mirroring the Main Outputs

When using Digi 002 or Digi 002 Rack with Pro Tools, you can send any pair of outputs (such as outputs 1–2) to the S/PDIF digital outputs at the same time by assigning the stereo mix to multiple output destinations. This is commonly known as *mirroring* the outputs.

Output mirroring is useful for recording to multiple media, creating separate monitoring mixes, or for output to digital effects processors.

To mirror the Digi 002 or Digi 002 Rack Main Outputs on the S/PDIF outputs:

- 1 Open the Pro Tools session whose channel outputs you want to mirror.
- 2 In the Mix window, click the Output selector of any audio or Auxiliary Input track to select the main output destination, for example, Analog 1–2.

- 3 Hold the Control key and click the same Output selector again, then select a second output for the same track (for example S/PDIF L-R).

The newly selected destination is indicated by an additional check mark in the output pop-up menu, and a plus sign in the Output selector.

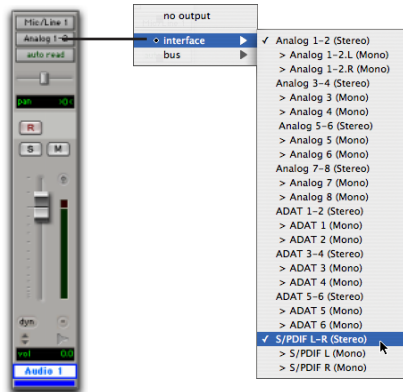

Choosing multiple output destinations for a track

Connecting a Recorder for Mixdowns

After you record and mix your sessions using Digi 002 or Digi 002 Rack, you may want to mix them down to a DAT, audio cassette, or other stereo 2-track recording device.

Connecting an Analog Deck

- ◆ If your recorder operates at -10 dBV level, connect its inputs to the Alt Main Outputs on the back of the Digi 002 or the Digi 002 Rack. These outputs are RCA connectors.
- ◆ If your recorder operates at $+4$ dBu level, connect its inputs to the Main Outputs 1–2 on the back of the Digi 002 or the Digi 002 Rack. These outputs are 1/4-inch jacks. You may need adapter cables if your mixdown deck has RCA inputs (and the Alt Main Outputs are not available).

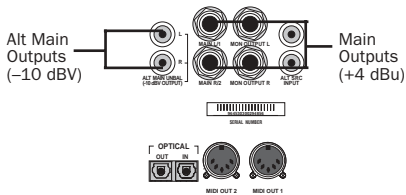

Alt Main and Main Outputs (back panel)

Connecting a Digital Deck (DAT)

If you have a DAT or other digital device that can receive S/PDIF digital audio data, connect it to the S/PDIF In and S/PDIF Out RCA jacks on the back of the Digi 002 or the Digi 002 Rack.

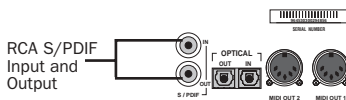

S/PDIF Input and Output

Connecting an ADAT

To connect an ADAT to Digi 002 or Digi 002 Rack:

- 1 Connect the Optical output on the ADAT to the Optical In port on the Digi 002 or Digi 002 Rack.
- 2 Connect the Optical input on the ADAT to the Optical Out port on the Digi 002 or Digi 002 Rack. (When the Digi 002 or Digi 002 Rack is on, its Optical Out port emits a red light.)

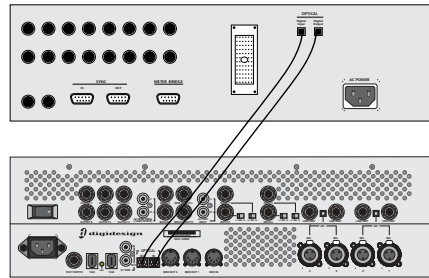

Connecting an ADAT to Digi 002

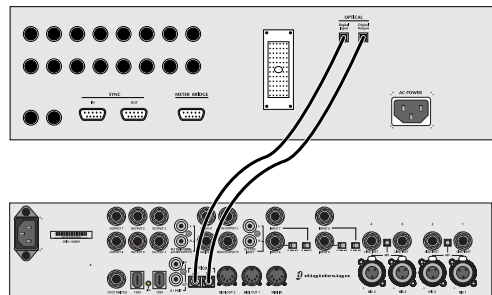



Connecting an ADAT to Digi 002 Rack

MIDI Connections

Using the Digi 002 or Digi 002 Rack built-in MIDI ports, a MIDI keyboard controller and MIDI instruments, you can take full advantage of the MIDI features of Pro Tools LE. These include recording and editing MIDI tracks, synchronizing to MIDI Time Code or MIDI Beat Clock (this requires an appropriate MIDI interface) and using a MIDI control surface.

 See the *Digi 002 and Digi 002 Rack Basics Guide* for information on basic MIDI concepts.

 **MIDI ports are only active when Pro Tools is launched.**

 See Appendix A, “Configuring MIDI Studio Setup (Windows Only)” or Appendix B, “Configuring AMS (Mac OS X Only)” for detailed information on how to identify external MIDI devices connected to your MIDI interface and configure your MIDI studio for use with Pro Tools.

To connect MIDI devices to Digi 002 or Digi 002 Rack:

- 1 Using standard 5-pin MIDI cables, connect the MIDI Out port of the MIDI device or controller to the MIDI In port of your Digi 002 or Digi 002 Rack.
- 2 Connect the MIDI In port of your MIDI device or controller to either of the two MIDI Out ports of the Digi 002 or Digi 002 Rack.

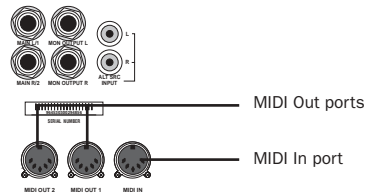

MIDI In and Out ports (back panel)

- 3 Connect the audio outputs of your device to available audio inputs of the Digi 002 or Digi 002 Rack.

chapter 9

Working with Pro Tools LE

This tutorial of Pro Tools LE software introduces its main windows and features, and also includes a step-by-step overview of audio recording.

All features described in this chapter are explained fully in the *Pro Tools Reference Guide*.

You can view an electronic PDF version of the *Reference Guide* by choosing it from the Pro Tools Help menu.

Session Basics

Pro Tools LE projects are created and saved as *sessions*. Sessions store all tracks, audio, MIDI, and other session information. Audio files, and fade files, Region group files, and backup Session files are stored in folders within the session folder.

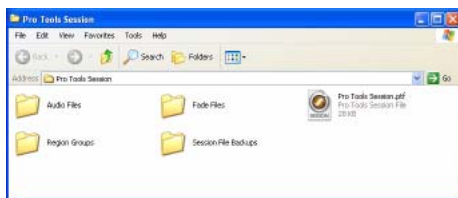

Session folder containing the session file and its associated folders

Starting a Session

To create a new session:

- 1 Launch Pro Tools LE.
- 2 Choose File > New Session.
- 3 In the New Session dialog, set the audio file type, sample rate, and bit depth parameters for the new session.



New Session dialog

- 4 Choose where you want to save your session. If you are using external hard drives with your Pro Tools system, make sure you select the appropriate drive in the New Session dialog.
- 5 Type a name for your session.
- 6 Click Save. The new session opens its Mix, Edit, and Transport windows.

Main Windows

The Mix, Edit, and Transport windows are the main Pro Tools work areas. You can show any of these windows by choosing them from the Window menu.

Edit Window Displays tracks in the session along the Timeline, for editing of audio, MIDI, and automation data.

Mix Window Displays the Pro Tools mixer, with its familiar fader strip controls for volume, pan, solo, mute, and signal routing.

 To switch between the Edit and Mix windows, press Control+Equals (=) (Windows) or Command+Equals (=) (Macintosh).

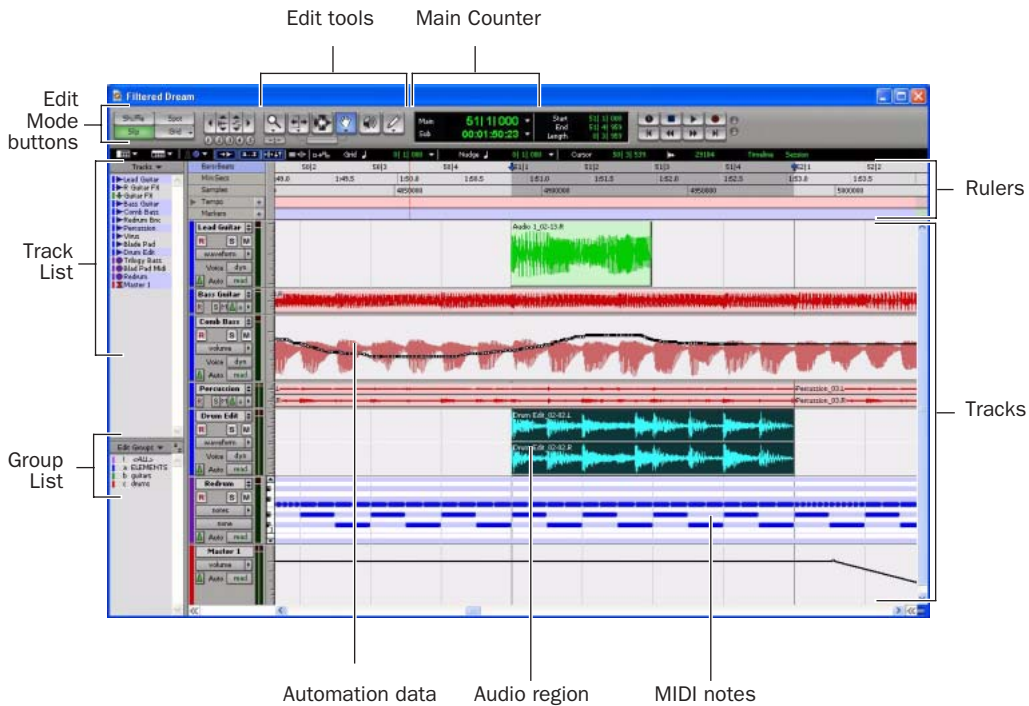

Figure 7. Edit window

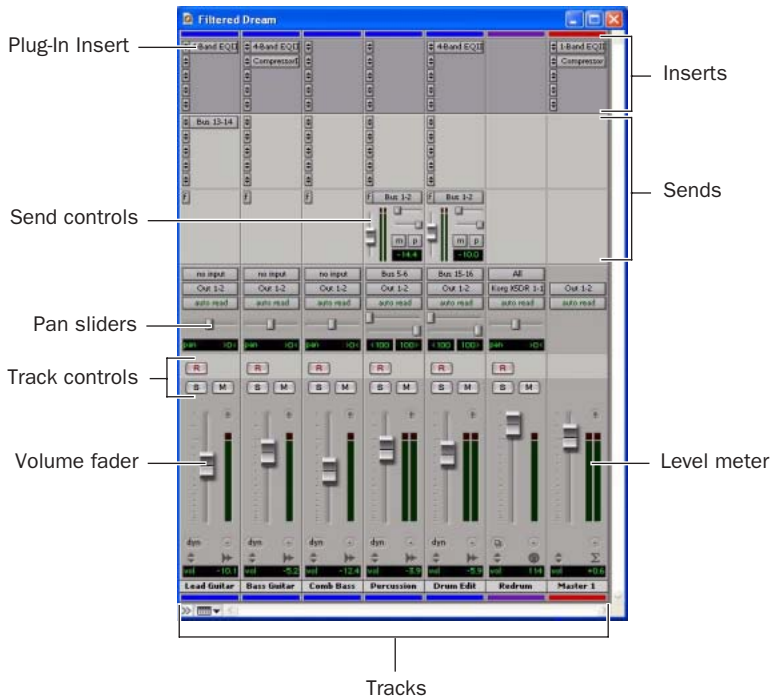

Figure 8. Mix window

Transport Window Provides controls for Play, Stop, Rewind, Fast-Forward, Pause, and Record. The Transport window can also show Counter and MIDI Control displays.

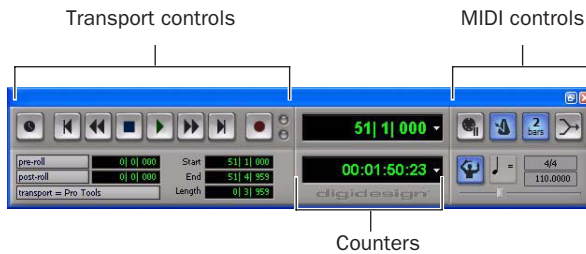

Figure 9. Transport window

Rulers

Pro Tools LE provides several different rulers to help navigate your session.

Timebase Rulers

Timebase rulers, displayed along the top of the Edit window, include *Bars:Beats*, *Minutes:Seconds*, and *Samples*. The current timebase determines the format of the Main counter, and provides the basis for the Edit window Grid.

To select a Timebase Ruler:

- Click the name of the ruler at the top left side of the Edit window.

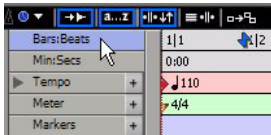

Selecting a Timebase ruler

Conductor Rulers

The Conductor rulers, displayed just below the Timebase rulers, include *Tempo*, *Meter*, and *Markers*. The Meter and Tempo rulers indicate changes in meter and tempo within the session. The Markers ruler displays markers to important track locations.

Setting a Tempo

You can set the tempo for your session by using the Song Start Marker, located in the Tempo ruler.

To set the session tempo with the Song Start Marker:

- 1 In the Tempo ruler, double-click the Song Start Marker.

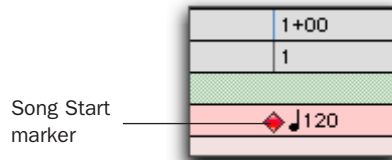

Song Start marker

- 2 In the Tempo Change dialog, enter the BPM (beats per minute) value you will use for the session. The inserted tempo event replaces the default session tempo.



Change Tempo dialog

- 3 To base the BPM value on a different note value (such as an eighth note rather than the default quarter note), select a note value from the Resolution pop-up menu.
- 4 Click OK.

Using the Click Plug-In

The Click plug-in creates an audio click during session playback. This works like a metronome that you can use as a tempo reference when performing and recording.

The Click plug-in is synchronized to the tempo and meter of the Pro Tools session, and follows any changes in tempo and meter.

 *The Click plug-in is one of many plug-ins that can be inserted on a Pro Tools track. See “Plug-Ins” on page 96.*

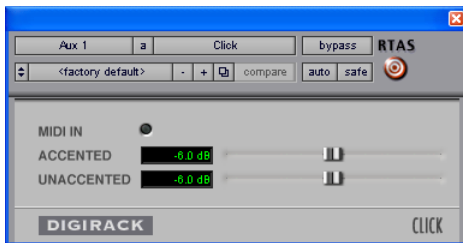

Click plug-in

Click Parameters

MIDI In LED Illuminates each time the Click plug-in receives a click message from the Pro Tools application, indicating the tempo.

Accented Controls the output level of the accent beat (beat 1 of each bar) of the audio click.

Unaccented Controls the output level of the unaccented beats of the audio click.

To use the Click plug-in:

1 Choose Options > Click to enable the Click option.

– or –

Enable the Metronome Click button in the Transport window.

Metronome Click button

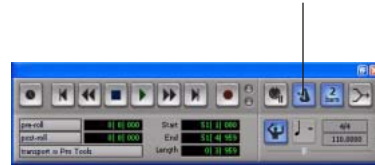

Click controls in the Transport window

2 Create a mono Auxiliary Input (Aux Input) track.

3 Insert a Click plug-in on the Auxiliary Input track.

4 In the Click plug-in window, choose a click sound from the Librarian pop-up menu (this menu displays “factory default” when you first insert the plug-in).



Selecting a Click sound

5 Choose Setup > Click and set the Click and Countoff options.

 *The Note, Velocity, Duration, and Output options in this dialog are for use with MIDI instrument-based clicks and do not affect the Click plug-in.*

6 Click OK.

7 Begin playback. A click is generated according to the tempo and meter of the current session and the settings in the Click/Countoff Options dialog.

Using an External MIDI Click

Pro Tools also lets you use an external MIDI device to play the click. This feature can be turned on and off in the Transport window, and is configured from the Click/Countoff Options dialog.

To configure and enable an external MIDI click:

- 1 Choose Setup > Click.

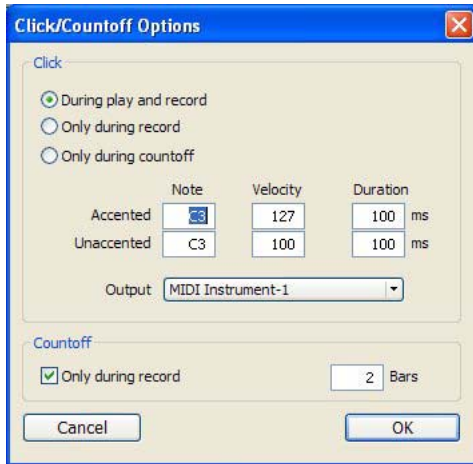

Click/Countoff Options dialog

- 2 Configure the click parameters as needed for your MIDI sound source.

 See Appendix A, “Configuring MIDI Studio Setup (Windows Only)” or Appendix B, “Configuring AMS (Mac OS X Only)” for information on identifying external MIDI devices connected to your hardware and configuring your MIDI studio for use with Pro Tools.

- 3 Choose a MIDI sound source from the Output pop-up menu and click OK.

- 4 During recording or playback, you can turn the Click on or off with the Metronome Click button in the MIDI Controls display of the Transport window.

Metronome Click button



Click controls in the Transport window

Saving Sessions

As you build a session by adding tracks and changing session controls, you will want to save your work. Pro Tools provides three ways to save sessions.

To save a session:

- Choose File > Save, File > Save As, or File > Save Copy In.

Save Saves the currently open session file, leaving it open for you to continue working.

Save As Creates a duplicate session file with the name you choose, and leaves the duplicate open for you to continue working. This can be useful if you want to experiment with different arrangements in the session without affecting the original session.

Save Copy In Saves a copy of the session file and lets you save copies of all audio files that are used in the session. This can be useful for archiving a session, preparing a session for transfer to another system, saving to older Pro Tools session formats, or saving a session at another sample rate.

System Resources and Settings

You can change specific Pro Tools system settings to optimize system performance.

Playback Engine Dialog

The Playback Engine dialog lets you adjust system buffer sizes and allocate CPU processing power in Pro Tools.

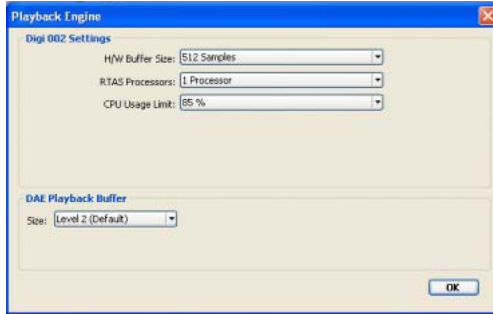

Playback Engine dialog for Pro Tools LE system

To configure system resources:

- Choose Setup > Playback Engine.

See Chapter 4, “Launching and Configuring Pro Tools LE” for details on configuring system settings.

System Usage Window

The System Usage window displays approximate information on CPU load and overall disk performance, so you can gauge your system’s processing capacity.

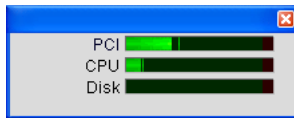

Meters in the System Usage window

To view system resources and usage:

- Choose Window > System Usage.

Transport Controls

The Transport window provides access to all Pro Tools LE transport commands. Different transport controls can be displayed or hidden in this window.

To show the Transport window:

- Choose Window > Transport.

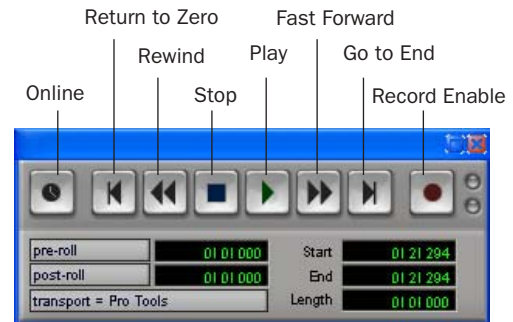

Transport window (Expanded view shown)

To configure the Transport window:

- Choose View > Transport and select from the available view options.

The Transport window provides Play, Stop, and other standard transport controls.

The Expanded view of the Transport window provides pre- and post-roll, start, end, and length indicators for Timeline selection, as well as the Transport Master selector.

The Transport window can also display the following MIDI controls: Wait for Note, Metronome Click, Countoff, MIDI Merge, Conductor, Meter, and Tempo.

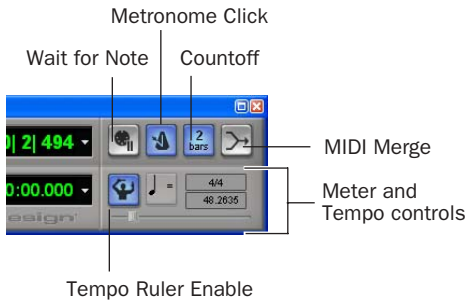

Transport window (MIDI Controls)

To start and stop playback:

- 1 Click Play in the Transport window to begin playback.
- 2 Click Stop in the Transport window to stop playback.

 Press the Spacebar on your computer keyboard to start and stop playback.

 *Pro Tools LE starts playing from the location of the cursor, or from the beginning of the current selection. The current setting of the Link Edit and Timeline Selection command in the Options menu also affects playback. See the Pro Tools Reference Guide for more information.*

Tracks

Pro Tools LE lets you create tracks for audio and MIDI recording, submixing, routing, automating, and editing.

Pro Tools LE provides five types of tracks: audio tracks, Auxiliary Input tracks, Master Faders, MIDI tracks, and Instrument tracks. Audio tracks, Auxiliary Inputs, Master Faders, and Instrument tracks can be mono or stereo.

Audio Tracks Record and play back audio to and from hard disk, monitor audio input when record-enabled, and edit audio regions

Auxiliary Inputs Audio mixer channels, used for input, routing, and submixing

Master Faders Provide master channel controls and options for any output or bus path

MIDI Tracks Record, play back, and edit MIDI data

Instrument Tracks Combine the functions of MIDI and Auxiliary Input tracks, letting you control and monitor instrument plug-ins or external MIDI devices in a single channel strip.

To create a new track:

- 1 Choose Track > New.

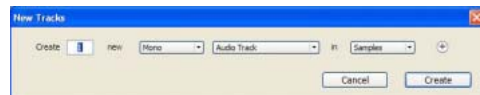

New Track dialog

- 2 Specify the number of tracks, track type, and mono or stereo (for all types except MIDI).

To create multiple new track types in one step, click the “+” button in the New Tracks dialog. Specify the number of tracks, track type, and track format for each additional row of new tracks you want to create.

3 Click Create.

In the Mix window, audio tracks, Auxiliary Inputs, Master Faders, MIDI tracks, and Instrument tracks appear as vertical channel strips.

Track type is indicated by the Track Type icons just below the faders, and by the track colors.



Tracks in the Mix window

In the Edit window, tracks are displayed horizontally along the Timeline. The area in which audio appears for each track is the playlist.

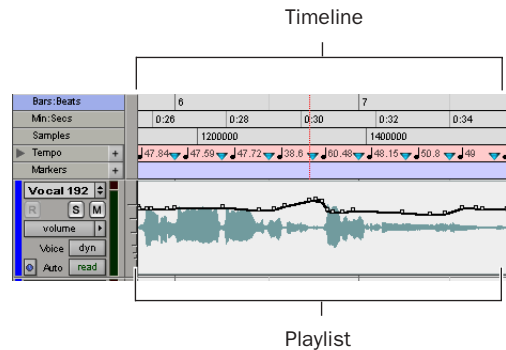

Timeline rulers and an audio track in the Edit window

Audio tracks, Auxiliary Inputs, Master Faders, MIDI tracks, and Instrument tracks can all be automated. See “Mix Automation” on page 97 for more information.

Audio Tracks

Audio tracks, Auxiliary Inputs, and Master Faders share many identical controls. Figure 10 shows the controls found in audio or Auxiliary Input tracks. Master Faders provide all the same features as audio tracks and Auxiliary Inputs, with the following exceptions:

Input Selector A Master Fader’s output assignment determines its input, or source.

Inserts Inserts on Master Faders are post-fader only. (Audio track and Aux Input track inserts are all pre-fader.)

Sends Master Faders do not provide sends. To send an output to another destination, use an Auxiliary Input track.

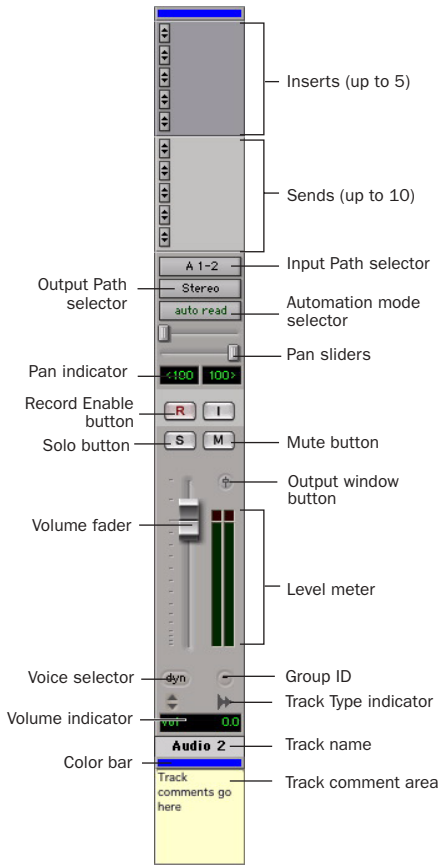

Figure 10. Stereo audio track in the Mix window

MIDI Tracks

MIDI tracks provide volume, solo, and mute, in addition to MIDI input, output, channel, and program (patch) controls. Figure 11 shows the controls found in MIDI tracks.

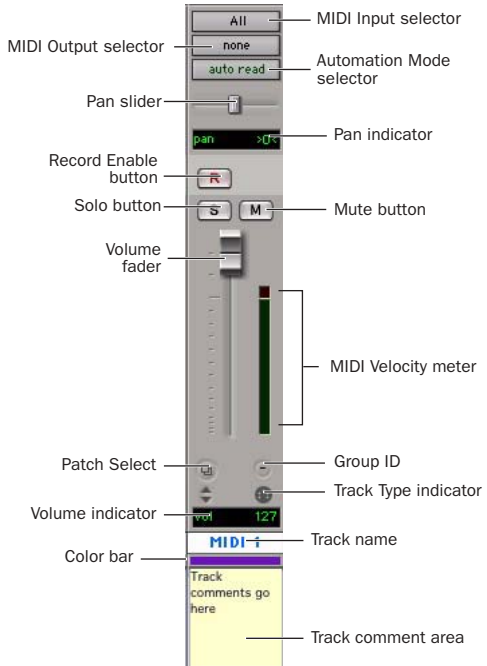

Figure 11. MIDI track in the Mix window

Instrument Tracks

Instrument tracks have many controls in common with audio tracks, and also have an additional Instruments View, which provides controls for MIDI input, output, mute, volume, and pan. Figure 12 shows the controls found in Instrument tracks.

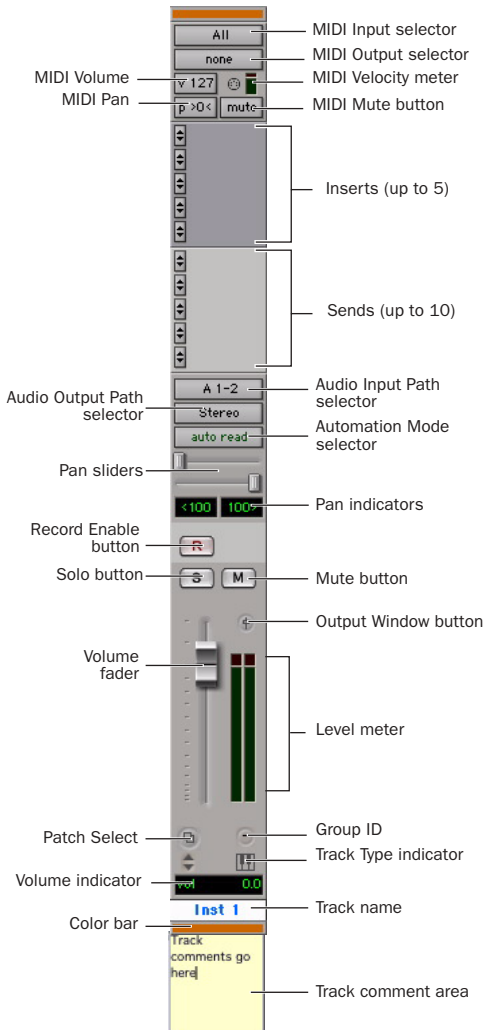

Figure 12. Stereo Instrument track in the Mix window

Region List

A region is a piece of audio or MIDI data that can also have associated automation data. For example, a region could be a loop, a guitar riff, a verse of a song, a sound effect, a piece of dialog, or an entire sound file.

In Pro Tools, regions are created from audio or MIDI files, and can be arranged in audio, MIDI, and Instrument track playlists.

All regions that are recorded, imported, or created by editing appear in the Region List. Regions can be dragged from the list to tracks and arranged in any order. Audio regions can also be auditioned from the Region List by Alt-clicking (Windows) or Option-clicking (Macintosh) the audio region name. The Region List pop-up menu provides features for managing regions and files (such as sorting, selecting, importing, or exporting files).

Drag border to resize width of Region List Click Regions button for pop-up menu

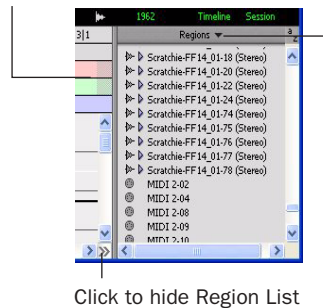

Click to hide Region List

Region List

 For more information on the Region List, see the Pro Tools Reference Guide.

Navigating in a Session

Pro Tools LE provides many ways to navigate in a session, including using the mouse or entering a memory location into one of the counters.

To navigate to a location in the Edit window:

- 1 In the Options menu, make sure Link Timeline and Edit Selection is enabled.
- 2 Enable the Selector tool at the top of the Edit window by clicking it.



Edit tools in Edit window

- 3 Click in a track or Timebase ruler. The cursor appears at the selected location and the counters display the current time location.

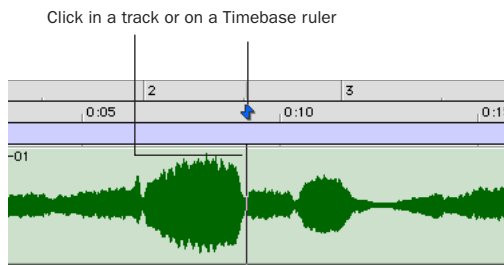

Clicking with the Selector tool in the Edit window

To navigate using the counters:

- 1 Click in the Main counter and enter a location using your computer keyboard.

- 2 Press Enter (Windows) or Return (Macintosh).



Navigating with the Counter

 Press the * (asterisk) key on the numeric keypad as an alternative to clicking in the counter. (The cursor will always appear in the Transport window's Main Counter if it is displayed.)

Memory Locations

Memory Locations and markers provide another way to navigate within sessions. Memory Locations appear as markers under the Timebase rulers. You can store up to 999 Memory Locations or markers in a session.

To define a memory location:

- 1 Navigate to the location where you want to store a marker or memory location.

– or –

Begin playback somewhere before the point where you want to store a Memory Location or marker.

- 2 Create a memory location by doing one of the following:

- Press Enter on the numeric keypad.

– or –

- Click the Add Marker/Memory Location (“+”) button, located to the left of the Markers ruler.

 On some Windows laptops, you can press **Fn+Enter** to create a memory location. This is especially useful for laptops that do not have a numeric keypad.

In the New Memory Location dialog, you can define a marker, store a selection, or store any combination of the other available settings. These settings include Track Height, Group Enables, Pre- and Post-Roll values, and Track Show/Hide status.

3 Choose settings for the Memory Location and click OK.

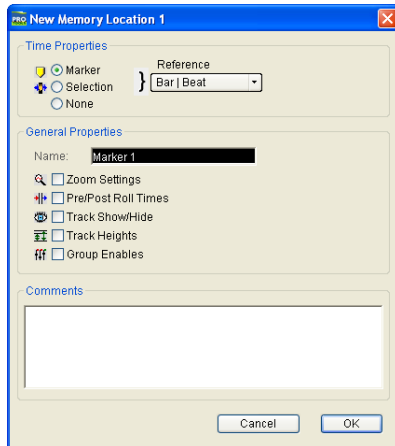

New Memory Location dialog

To go to a stored memory location:

- 1 Choose Window > Memory Locations.
- 2 In the Memory Locations window, click the name of the Memory Location.



Memory Locations window

Viewing and Zooming

When viewing tracks in the Edit window, you can adjust the height of tracks as well as zoom in vertically and horizontally using the Track Height selector and Zoom tools.

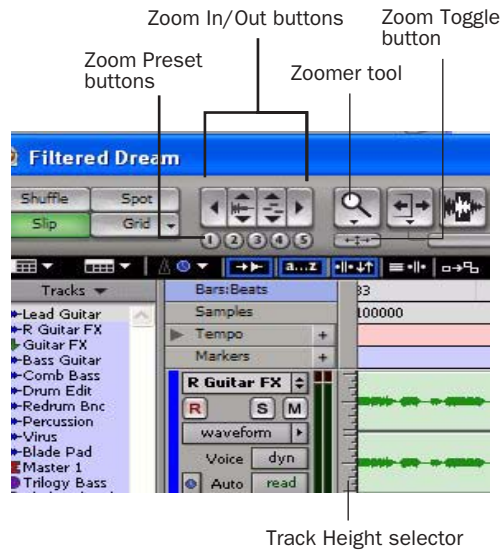

Zoom and Track Height tools in the Edit window

To change track height:

- Click the Track Height selector (the scaled vertical bar at the left of the track), and select a track height from the pop-up menu.

💡 You can apply many commands, including track height selection, to more than just a single track. Hold down the Alt key (Windows) or Option key (Macintosh) while performing an operation to apply it to all tracks. Hold down both the Shift and Alt keys (Windows) or Shift and Option keys (Macintosh) while performing an operation to apply it to all selected tracks.

To Zoom in or out on any area of a track in the Edit window:

- 1 Click to select the Zoomer tool.
- 2 Click or drag with the Zoomer tool to zoom in horizontally for a track or ruler.

– or –

Press Alt (Windows) or Option (Macintosh) and click with the Zoomer tool to zoom out horizontally for a track or ruler.

To zoom in or out incrementally:

- Click the appropriate Zoom button:
 - Zoom Out button (Left Arrow)
 - Zoom In button (Right Arrow)
 - Audio or MIDI Zoom buttons, to increase or decrease vertical zoom of the corresponding track type

To zoom in or out continuously:

- 1 Select the Zoom tool.
- 2 Hold the Start key (Windows) or Control (Macintosh) and drag in a track as follows:
 - Drag up to zoom in vertically
 - Drag down to zoom out vertically
 - Drag to the right to zoom in horizontally
 - Drag to the left to zoom out horizontally

Zoom Toggle

The Zoom Toggle button lets you store a zoom state and toggle between it and the current zoom state. When Zoom Toggle is enabled, the Edit window displays the stored zoom state. When Zoom Toggle is disabled, the Edit window reverts to the last zoom state.

To store a zoom state using Zoom Toggle:

- 1 Make an Edit selection.
- 2 Click the Zoom Toggle button so that it is highlighted.



Zoom Toggle button

Zoom Toggle button in the Tool bar

- 3 Adjust Track Height, Vertical Zoom, Track view, and the Grid setting.
- 4 Make any desired edits.
- 5 Click the lit Zoom Toggle button again to revert to the last zoom state.
- 6 Make another edit selection and click the Zoom Toggle button to recall the stored zoom state, and continue editing.

Zoom Presets

Pro Tools provides five Zoom Preset buttons. You can use these to immediately return to established zoom levels. You can define the magnification level for each preset, on a session-by-session basis.

To store a new Zoom preset definition:

- 1 Use the Zoom tool to establish a Zoom setting.
- 2 Click a Zoom Preset button (1–5) and choose Save Zoom Preset from the Zoom Preset pop-up menu.



Zoom Preset pop-up menu

To recall a saved Zoom preset:

- Click the corresponding Zoom Preset button (1–5).

Using Memory Locations for Zoom Control

Pro Tools Memory Locations let you store many attributes with each marker or memory location, including Track Height and Zoom Settings. By creating Memory Locations that are neither markers nor selections, but have Track Height, Zoom Settings, or other options enabled, you can use Memory Locations to zoom in and out using just the numeric keypad.

For more information on creating memory locations, see “Memory Locations” on page 78.

Importing Data into Pro Tools Sessions

Pro Tools LE lets you import audio, MIDI, and a wide range of Pro Tools session data into your current session.

Importing Audio

Pro Tools LE lets you import audio files from your hard drive or from CD. This is very useful if you have audio files already recorded to disk or if you are working with CD-based sample libraries that you want to use in a session.

To import audio files or regions from disk:

- Choose File > Import > Audio to Track to import files and regions to new audio tracks (they will also appear as regions in the Region List).

– or –

- Choose File > Import > Audio to Region List to import files and regions to the Region List only.

To import a CD audio track:

- 1 Put the source CD into your computer’s CD drive.
- 2 Choose Window > Workspace and click the Audio CD icon to show the files on the CD.
- 3 Click the speaker icon in the waveform column of the Workspace browser to audition the corresponding file. Press the Spacebar to stop playback.

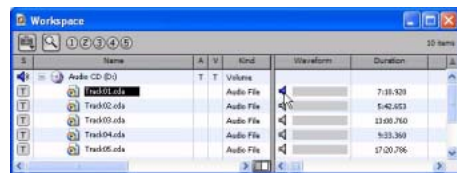

Auditioning an audio file in the Workspace Browser

4 Do one of the following:

- Drag audio files from the Workspace browser to the Track List in the Edit window to import the files to new audio tracks (they will also appear as regions in the Region List).

– or –

- Drag audio files from the Workspace browser to the Region List in the Edit window to import the files to the Region List only.

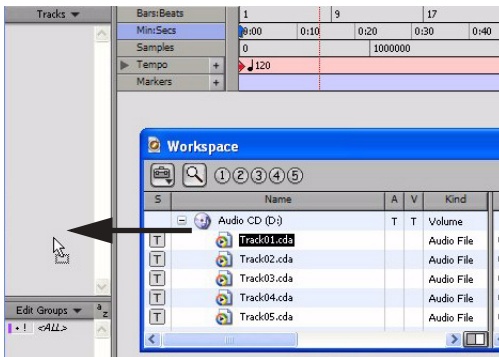

Dragging an audio file from the Workspace Browser to the Edit window Track List

 For more information on searching, auditioning, and importing audio with DigiBase, refer to the DigiBase Guide.

Importing MIDI

Pro Tools lets you import MIDI files into the Region List or directly into MIDI tracks in a session.

To import MIDI files into the Region List:

- Choose File > Import > MIDI to Region List.

To import MIDI files to tracks:

1 Choose Window > Workspace and locate the MIDI files you want to import.

2 Drag MIDI files from the Workspace browser to the Track List.

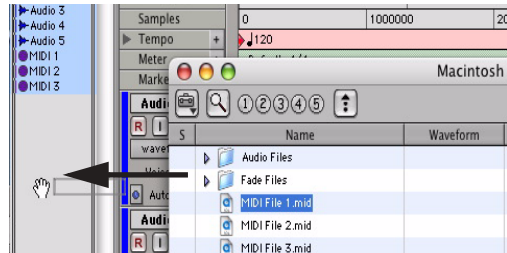

Dragging a MIDI file from the Workspace Browser to the Edit window Track List

3 In the Import MIDI Settings dialog box, choose the import location and settings for the MIDI you are importing.

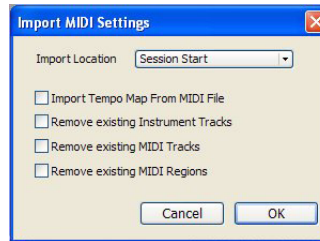

Import MIDI Settings dialog

Importing Files from Windows Explorer and Macintosh Finder

Pro Tools lets you drag and drop audio, MIDI, region group, REX, and ACID files directly from Windows Explorer or Macintosh Finder to the Timeline or the Region List of a Pro Tools session.

 For more information on importing data into Pro Tools sessions, see the Pro Tools Reference Guide.

Basic Recording

This section describes how to record audio and MIDI into Pro Tools LE.

Preparing for Recording

To prepare an audio track for recording:

- 1 Verify the connections to your microphones or instruments. Refer to Chapter 8, “Connecting Your Studio” for more information about connecting microphones or instruments to Digi 002 or Digi 002 Rack.
- 2 Choose **Track > New**. Specify 1 Mono or Stereo audio track (depending on your sound source) and click **Create**.
- 3 In the Mix window, click the **Audio Input Path** selector on the new track.

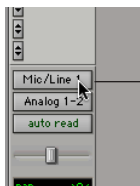

Audio Input Path selector

Choosing an input in the Mix window

- 4 From the pop-up menu, select the interface input you want to record. For example, select **Mic/Line 1** if your audio source is plugged into the **Mic 1** or **Line/Inst 1** jack on the back of Digi 002 or Digi 002 Rack.

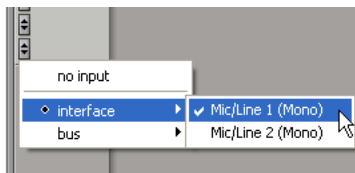

Routing an input to a mono track

Setting Input Levels

Input levels for Mic/Line 1–4 are adjustable using the gain knobs (located on the top panel of the Digi 002, and on the front panel of the Digi 002 Rack). Input levels for all other inputs on Digi 002 or Digi 002 Rack cannot be adjusted in Pro Tools, and need to be set at the source.

When you feed a signal into Pro Tools, make sure to adjust the input level to optimize the dynamic range and signal-to-noise ratio of the recorded file. If the input level is too low, you will not take full advantage of the dynamic range of your Pro Tools system. If the input level is too high, the waveform will be clipped, distorting the recording.

Try to set levels so that they register within the top 6 dB of the input meter without triggering the clipping indicator, on your audio interface.

⚠ *Set input levels to avoid clipping. Clipping is indicated by the red clip light at the top of the Pro Tools on-screen meters.*

To adjust input levels on Mic/Line inputs 1–4:

- 1 Connect an audio source to the appropriate input connector on the back panel of Digi 002 or Digi 002 Rack. Microphones should be plugged into an XLR connector. Line inputs or instruments should be plugged into a 1/4-inch TRS connector.
- 2 Press the **Mic/Line/Instrument Selector** switch (located on the top panel of the Digi 002, and on the front panel of the Digi 002 Rack) to match the type of device you connected.
- 3 Choose **Track > New** and specify 1 Mono Auxiliary Input track, then click **Create**.
- 4 Set the track input to the correct Digi 002 or Digi 002 Rack input channel (Mic/Line 1–4).

5 Play the instrument or sound source at the volume you will record.

6 Adjust the input gain for the channel using the gain knob (located on the top panel of the Digi 002, and on the front panel of the Digi 002 Rack). Increase or decrease gain until you are able to achieve maximum peak levels in the Auxiliary Input track meter without clipping. Typically such peak levels are in the yellow area of the meter.

Mic/Line High-Pass Filters

Mic/Line Inputs 1–4 include a high-pass filter set at 75 Hz. This filter can be useful for filtering out low-end rumble from a noisy recording environment, microphone handling, or AC noise.

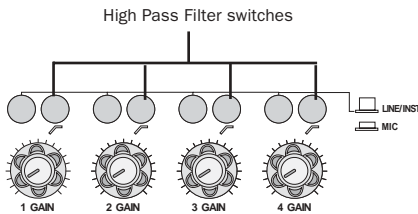

High Pass Filter switches (front panel)

Recording an Audio Track

To record an audio track:

- 1 Assign the input for a track and set its input levels.
- 2 Click the Track Record Enable button.



Record enabling a track in the Mix window

3 Choose Window > Transport to display the Transport window.



Transport window (Expanded view shown)

4 Click Return To Zero to start recording from the beginning of the session. You can also record according to a selection or from the cursor location in the Edit window.

5 Click Record in the Transport window to enable recording.

6 Click Play or press the Spacebar to record on all record-enabled tracks.

7 Record your performance.

8 Click Stop in the Transport window or press the Spacebar when you are finished recording.

To play back a recorded track:

1 Click the track's Record Enable button a second time to take it out of Record mode.

2 Click Play in the Transport window or press the Spacebar to start playback.

3 Click Stop in the Transport window or press the Spacebar to stop playback.

Recording To and From Digital Devices

Digi 002 and Digi 002 Rack provide both S/PDIF (RCA) digital input connectors and Optical connectors for transfer of digital audio.

Setting Digital Format and Clock Source

Before recording from a digital source, make sure you have enabled the appropriate Digital Format in the Hardware Setup dialog. For more information, see “Recording a Digital Source” on page 27.

Recording To and From an ADAT

You can use Digi 002 or Digi 002 Rack to interface with an ADAT, either to record tracks from an ADAT into Pro Tools LE for editing, or to record tracks from Pro Tools LE to an ADAT.

To record ADAT tracks into Pro Tools LE:

- 1 Open or create a session in Pro Tools LE.
- 2 Record enable up to eight audio tracks (depending on how many tracks are used on the ADAT tape).
- 3 Assign ADAT Optical Inputs 1–8 to your eight tracks.
- 4 Verify that Pro Tools LE is synchronized to Optical, and that the Optical Format is set to ADAT.
- 5 Click Record in the Transport window.
- 6 Click Play in the Transport window to begin recording, then press Play on the ADAT.
- 7 When playback from the ADAT tape is finished, click Stop in the Transport window, or press the Spacebar.

To record Pro Tools LE tracks to an ADAT:

- 1 Open the session you want to record to ADAT.
- 2 Record enable up to eight audio tracks on the ADAT.
- 3 Route the output of up to eight audio tracks in Pro Tools to the Optical outputs on Digi 002 or Digi 002 Rack.
- 4 Verify that Pro Tools LE is referencing its Internal Clock Source in the Hardware Setup dialog.
- 5 Start recording on the ADAT, then click Play in the Transport window in Pro Tools LE. When playback is complete, stop both systems.

 For detailed information on connecting an ADAT to your system, see “Connecting an ADAT” on page 64.

Monitoring Latency and Recording

Because Pro Tools LE uses the host processor in your computer for audio processing, playback, and recording, there is a small amount of audio delay, or *latency*, when monitoring audio through the system. You can set the latency to be shorter when you are recording and monitoring through Digi 002 or Digi 002 Rack, and longer when you are trying to achieve higher track counts with more plug-ins.

Set latency in the Playback Engine dialog. Latency is controlled by the H/W Buffer Size setting, and is displayed in samples. The recommended range of settings for listening back to audio is 512–2048 samples. For recording, when monitoring through Digi 002 or Digi 002 Rack, the recommended range of settings is 128–256 samples.

To set the Hardware Buffer Size for record or playback:

- 1 Choose Setup > Playback Engine.
- 2 Choose the number of samples from the H/W Buffer Size pop-up menu, then click OK.

Low Latency Monitoring

Pro Tools LE includes a feature called Low Latency Monitoring for Digi 002 or Digi 002 Rack systems. This feature allows you to use a built-in mixer in the Digi 002 unit or Digi 002 Rack unit to record and monitor up to 18 inputs (8 analog, 8 ADAT, and 2 RCA-S/PDIF) with extremely low latency. This mode is useful for recording multiple instruments at the same time.

To use Low Latency Monitoring, tracks must be record-enabled, assigned to an actual audio input (not an internal bus), and assigned to Outputs 1 or 2.

To enable Low Latency Monitoring:

- Select Options > Low Latency Monitoring.

When Low Latency Monitoring is enabled, any plug-ins and sends assigned to record-enabled tracks (routed to Outputs 1–2) are automatically bypassed, and must remain bypassed. Also, these tracks will not register on meters for Master Faders.

Recording MIDI

Instrument tracks combine a MIDI track and Auxiliary Input into a single channel strip that provides both MIDI and audio capabilities. Instrument tracks let you record MIDI and monitor audio from software and hardware instruments.

To create an Instrument track and configure it for recording:

- 1 Choose Setup > MIDI > Input Devices and make sure your input device is selected in the MIDI Input Enable window, and Click OK.
- 2 Choose Track > New and specify 1 Mono Instrument Track, then click Create.
- 3 Select View > Mix Window > Instruments to display the MIDI controls at the top of the Instrument track in the Mix window.
- 4 Click the track's MIDI Input selector and assign the device and channel to be recorded, or leave it set to All.

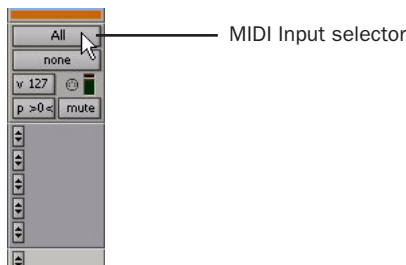

MIDI Input selector in an Instrument track

5 Do one of the following, depending on the type of instrument you are using:

- If you are using an instrument plug-in, click an Insert selector and insert the plug-in on the Instrument track. The track's MIDI output is automatically assigned to the instrument plug-in.

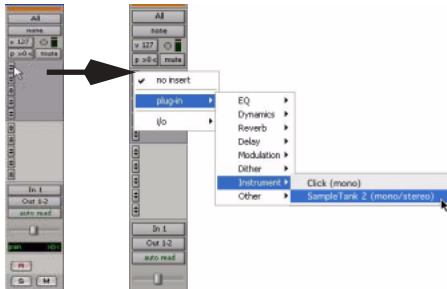

Inserting an instrument plug-in on an Instrument track

- If you are using an external MIDI device, click the track's MIDI Output selector (at the top of the Instrument track) and assign the device and channel to receive the MIDI output (the choices will vary depending on the device).

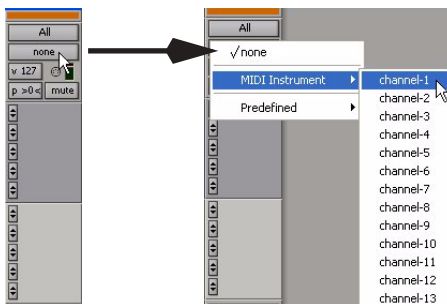

MIDI Output selector in an Instrument track

 If your connected MIDI device does not appear, check that you have configured your computer and its MIDI settings. See Appendix A, “Configuring MIDI Studio Setup (Windows Only)” or Appendix B, “Configuring AMS (Mac OS X Only)” for more information.

6 You can assign a default program change to the track by clicking the Patch Select button in the Mix window and making the necessary selections for program and bank select, and then clicking Done. Default program changes are sent when playing the track.



Patch Select button

Patch Select button in an Instrument track

7 If you are using an external MIDI device and connected its audio output to an audio interface for monitoring in Pro Tools, click the Input selector of the Instrument track and choose the corresponding audio input.

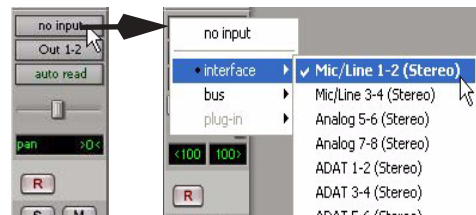

Choosing an audio input for an Instrument track

8 Click the Track Record Enable button to enable the Instrument track for MIDI recording.

9 Make sure Options > MIDI Thru is selected.

10 Play some notes on your MIDI controller and look for the track's MIDI Velocity meter to move. Remember, MIDI is not audio, and the MIDI meter is not registering sound output, but MIDI activity.

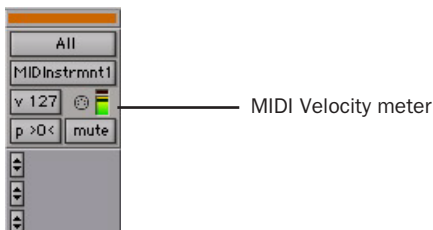

MIDI meter in Instrument track showing MIDI activity

11 Adjust the audio output level of the Instrument track with its Volume fader.

To record MIDI on the Instrument track:

- 1** Verify that the Instrument track you want to record to is record-enabled and receiving MIDI.
- 2** In the Transport window, click Return To Zero to start recording from the beginning of the session. You can also record to a selection in a track, or from the cursor location in the Edit window.
- 3** Click Record in the Transport window.
- 4** Do one of the following:
 - Click Play in the Transport window or press the Spacebar to begin recording.
 - If you are using Wait for Note, the Play, Record, and Wait for Note buttons flash. Recording begins when the first MIDI event is received.
 - If you are using Countoff, click Play. The Record and Play buttons flash during the Countoff, then recording begins.
- 5** Play your MIDI controller or input device.

6 When you have finished recording, click Stop in the Transport window, or press the Spacebar. The newly recorded MIDI data appears as a MIDI region on the track in the Edit window, as well as in the Region List.

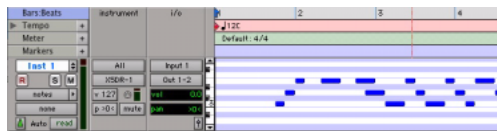

MIDI data in the Instrument track

To play back recorded MIDI data:

- 1** Click the Record Enable button to take the Instrument track out of Record mode.
- 2** In the Transport window, click Return To Zero to play back from the beginning of the track.
- 3** Click Play in the Transport window to begin playback. The recorded MIDI data plays back through the track's assigned instrument and channel.

QuickPunch Recording

With QuickPunch recording you can punch in and out of audio recording on armed tracks. Recording can be triggered from the Transport window, or using a standard footswitch. You can use a standard footswitch (such as a keyboard sustain pedal) with QuickPunch to *punch in* when recording audio. You can also punch in when recording MIDI, without enabling QuickPunch.

 For more information on QuickPunch and punch recording, see the *Pro Tools Reference Guide*.

To connect a footswitch to Digi 002 or Digi 002 Rack:

- 1 Turn off the Digi 002 or Digi 002 Rack unit.
- 2 Plug the footswitch into the Footswitch connector on the back panel of Digi 002 or Digi 002 Rack.
- 3 Power on the Digi 002 or Digi 002 Rack unit.

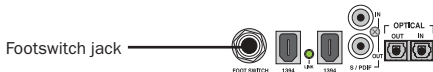

Footswitch jack (back panel)

⚠ Footswitch polarity is detected by Digi 002 or Digi 002 Rack firmware when you power up the unit. Make sure the footswitch is connected and not pressed when turning on the Digi 002 or Digi 002 Rack.

To punch in with QuickPunch when recording audio:

- 1 Select Options > QuickPunch.
- 2 Set input routing and click the Record Enable button on each audio track you want to punch in. You can punch in on up to 8 audio tracks while playing back 32 tracks, or you can punch in on up to 16 tracks while playing back 24 tracks.
- 3 Click Play in the Transport window.
- 4 Click Record in the Transport window or step on the footswitch to begin recording (punch in) on all record-enabled tracks.
- 5 Click Record in the Transport window or step on the footswitch again to stop recording (punch out).

Note that the session continues to play, and you can continue to punch in and out as many times as you want.

 With QuickPunch enabled, press *Control+Spacebar (Windows) or Command+Spacebar (Macintosh)* to punch in and punch out.

Punching in When Recording MIDI

You can punch record MIDI at any time. QuickPunch is not required to punch in on MIDI or Instrument tracks.

To punch in when recording MIDI:

- 1 Set your MIDI input routing and click the Record Enable button on each MIDI or Instrument track you want to punch in.
- 2 Click Play in the Transport window.
- 3 Click Record in the Transport window or step on the footswitch to begin recording (punch in) on all record-enabled tracks.
- 4 Click Record in the Transport window or step on the footswitch again to stop recording (punch out).

Editing

Pro Tools LE provides several tools for editing audio and MIDI. In the Edit window, audio and MIDI tracks can be edited into regions or repeated in different locations to create loops, re-arrange sections or entire songs, or to assemble tracks using material from multiple takes.



Edit modes and tools

Audio and MIDI editing are typically used to:

- Fix or replace mistakes
- Re-arrange songs and projects
- Clean up track timing and rhythm by aligning hits to Grid values like bars and beats
- Create final tracks using selections from multiple takes (also known as *comp tracks*).

Edit Modes

Pro Tools LE has following Edit modes: Shuffle, Spot, Slip, and two Grid modes, Absolute (standard Pro Tools Grid mode), and Relative.

The Edit mode is selected by clicking the corresponding button in the upper left of the Edit window.



Edit mode buttons

 Press F1 (Shuffle), F2 (Slip), F3 (Spot), and F4 (Grid) to set the Edit mode.

The Edit mode affects the movement and placement of audio and MIDI regions (and individual MIDI notes), how commands like Copy and Paste function, and also how the various edit tools (Trimmer, Selector, Grabber, and Pencil) work.

 For detailed descriptions of Edit modes, see the Pro Tools Reference Guide.

Edit Tools

Pro Tools LE has seven Edit tools: Zoomer, Trimmer, Selector, Grabber, Scrubber, Pencil, and Smart Tool. Select an Edit tool by clicking it in the Edit window. The Zoomer, Trimmer, Grabber, and Pencil tools have multiple modes, which you can select from a pop-up menu when you click the tool.

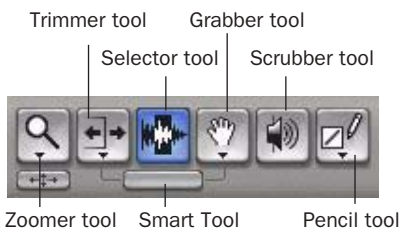

Edit tools in Edit window

 Press the Escape key to toggle through the Edit tools.

 For detailed descriptions of the Edit Tools, see the Pro Tools Reference Guide.

Playlists and Nondestructive Editing

Playlists let you create and retrieve multiple versions of track edits. A playlist can be a complete take, an overdub, or an arrangement of selections from multiple takes. You can duplicate playlists to save edits in their current state, then continue making additional edits to the new playlist knowing you can always go back to the previous version.

To create multiple playlists for editing:

- 1 Start with a track on which you want to try different edits.
- 2 Click the Playlist selector, and from the pop-up menu, choose Duplicate.



Playlist selector

Playlist selector

- 3 Name the duplicated playlist and click OK.
- 4 Make your first series of edits.
- 5 Click the Playlist selector and select the original playlist from the pop-up menu.
- 6 Repeat steps 2–5 for any further edits.

In this way, you can try out different edits of a track, and switch back and forth between playlists for comparison.

Editing Regions

The Edit tools in Pro Tools LE are used to edit regions in the Edit window.

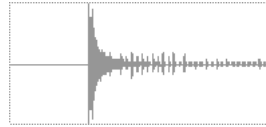

Audio region

Trimming Regions

After recording an audio track, you will have an audio region on that track. If there is some silence at the beginning of the region, or there is some extra audio at the end of the region, you can use the Trimmer tool in Slip mode to shorten the beginning or end of the region.



Audio region on a track

To trim an audio region:

- 1 Select Slip mode.
- 2 Select the Trimmer tool.
- 3 Move the cursor near the beginning of the audio region (notice the cursor displays as a "[").



Trimming the beginning of a region

- 4 Click at the beginning of the region and drag right to shorten the region.

5 Move the cursor near the end of the audio region (notice the cursor displays as a “]”).



Trimming the end of a region

6 Click at the end of the region and drag left to shorten the region.



The trimmed region

You can also extend a region using the Trimmer tool if there is audio data beyond the current boundaries of the region. To extend the region’s beginning, drag to the left; to extend the region’s end, drag to the right.

Arranging Regions

There are many ways to edit and arrange regions; the following example demonstrates how you might create and arrange a drum loop to compose a rhythm track.

To create and arrange a rhythm sequence:

- 1 Open or create a session in Pro Tools LE.
- 2 Set the session meter and tempo by doing the following in the Edit window:
 - Click the Ruler View selector and select both Tempo and Meter.
 - Click the Add Tempo Change button and specify the tempo.

- Click the Add Meter Change button and specify the meter.

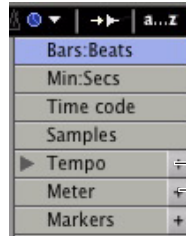

— Add Tempo Change
— Add Meter Change

Add Tempo Change and Add Meter Change buttons

3 Click the Grid mode button to put Pro Tools in Grid mode.

4 Prepare to record using a click (see “Using the Click Plug-In” on page 71 or “Using an External MIDI Click” on page 72).

5 Record a drum track (see “Recording an Audio Track” on page 84) keeping in mind that you want to use only the best bar (measure). Your recording should fit the grid at the specified tempo and meter.

– or –

Import an existing audio file, such as a drum loop from a sample library, and place it on an audio track (see “Importing Audio” on page 81).

6 Click the Selector tool, and drag on the waveform to make a one-bar selection. Note that the selection snaps to the specified grid.

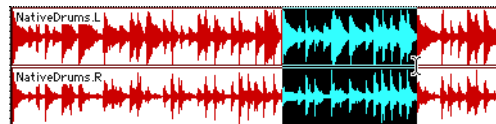

Making a selection in Grid mode

7 Choose Track > New and create a new Stereo Audio track.

8 Click the Grabber tool and select the Separation Grabber tool.

9 With the Separation Grabber tool, drag the selection to the beginning of the new audio track. A new region is created and appears at the beginning of the new track.

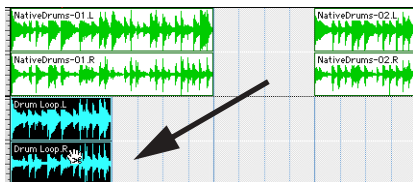

Dragging a selection with the Separation Grabber tool

10 With the new region still selected, choose Region > Loop.

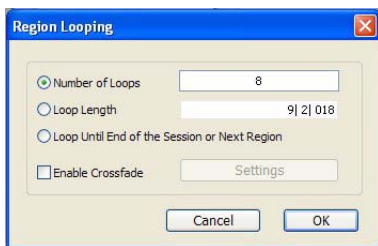

Region Looping dialog

11 In the Region Looping dialog, enter the number times you want to loop the region, and click OK.

You now have a new rhythm track with a “looped” (repeated) phrase.

You can use these editing tools and Beat Detective to do much more advanced editing of regions.

Grouping Regions

The Region Groups feature in Pro Tools lets you group regions on multiple adjacent audio, MIDI, and Instrument tracks. Region Groups are useful for groove and tempo manipulation, editing, and arranging.

 For more information on Region Groups, see the Pro Tools Reference Guide.

Mixing

The Pro Tools mix environment provides many familiar channel strip controls for setting volume, pan, solo, and mute. Mixer and I/O controls can be shown in both the Mix and Edit windows.

To view the Mix window:

- Select Window > Mix.



Press Control+Equals (=) (Windows) or Command+Equals (=) (Macintosh) to switch between the Edit and Mix windows.



There are also dedicated Mix and Edit window buttons on the Digi 002.

Using Channel Strip Controls

The following controls are common to Audio, Auxiliary Input, and Instrument tracks.

Volume Fader Increase or decrease the track level by dragging its Volume fader up or down.

Pan Slider Pan a track left or right in the mix by dragging its Pan slider left or right.

Solo Button Solo a track (muting all other tracks) by clicking its Solo button.

Mute Button Mute a track by clicking its Mute button.

Basic Signal Routing

Signal routing is accomplished by assigning track inputs and outputs. Audio track inputs can be from any hardware input or bus path. Once recorded, an audio track's input is its audio file on disk. Auxiliary Inputs can be any hardware input or internal bus path. For all types of audio tracks, outputs can be routed to any hardware output or internal bus path.

You can use these signal routing features to set up virtually any mixer architecture for your projects, including sends and returns for effects processing and submixing.

Send and Return Submixing for Effects Processing

When you are submixing for reverb, delay, and similar effects processing, you can use sends and Auxiliary Inputs to achieve traditional send/return bussing. You can use a real-time plug-in (see “Plug-Ins” on page 96) as a shared resource for all tracks included in a submix. The wet/dry balance in the mix can be controlled using the track faders (dry level) and Auxiliary Input fader (wet, or effect return level).

Creating a Send

Pro Tools LE provides up to ten sends per audio track. A send can be mono or stereo, routing to an output or one of 32 internal bus paths.

To assign a send on a track:

- 1 Make sure the Sends you want to use are visible in the Mix window (View > Mix Window > Sends A–E or Sends F–J).
- 2 In the Mix window, click a Send selector on an audio track and choose a path from the pop-up menu.

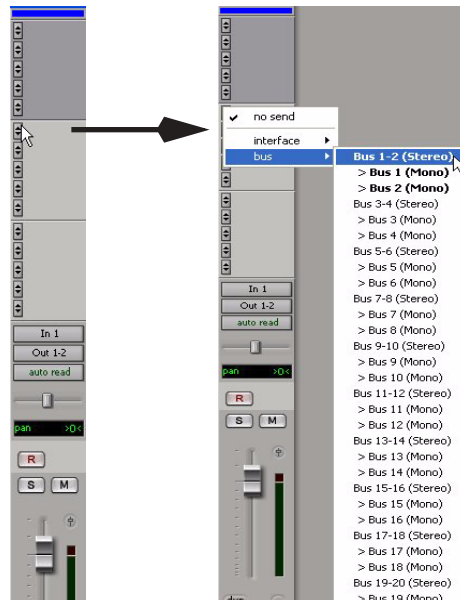

Assigning a send to a stereo bus path

- 3 Set the output level of the send. You can set the send level to zero by Alt-clicking (Windows) or Option-clicking (Macintosh) the Send fader.

 You can configure the default level for new sends to be $-\infty$ or at unity gain (0 dB) by enabling or disabling the Sends Default To “-INF” option in the Operation Preferences page.

Creating a Return

Auxiliary Inputs can be created to act as return channels for busses, as well as for inputs from hardware sources.

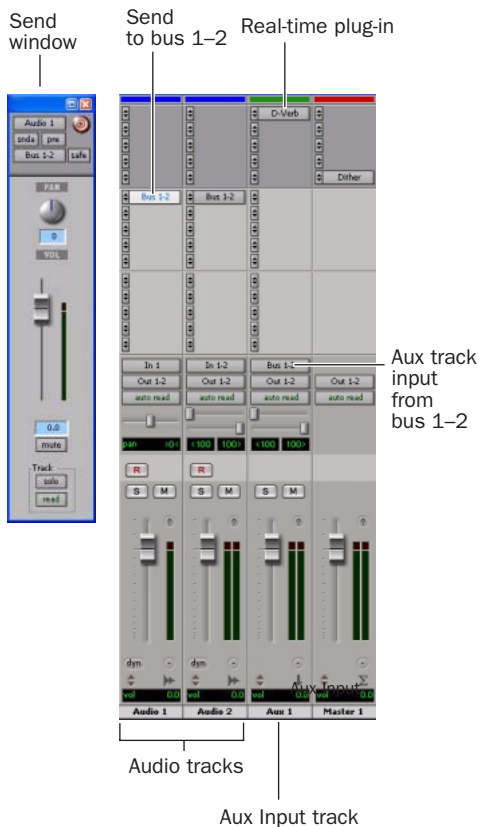

Audio and Auxiliary Input tracks configured for a send and return

To create a return:

- 1 Choose Track > New and specify 1 Mono or Stereo Auxiliary Input, then click Create.
- 2 Click the Input selector of the Auxiliary Input and set it to the bus path you assigned to the sends on the source tracks.
- 3 Click the Output selector of the Auxiliary Input and choose an output path.

Master Faders

Master Faders are used as output and bus masters, and can control any mono or stereo output or bus path in a session. You can then use the controls on the Master Fader to control the volume, solo and mute, or apply inserts to those paths.

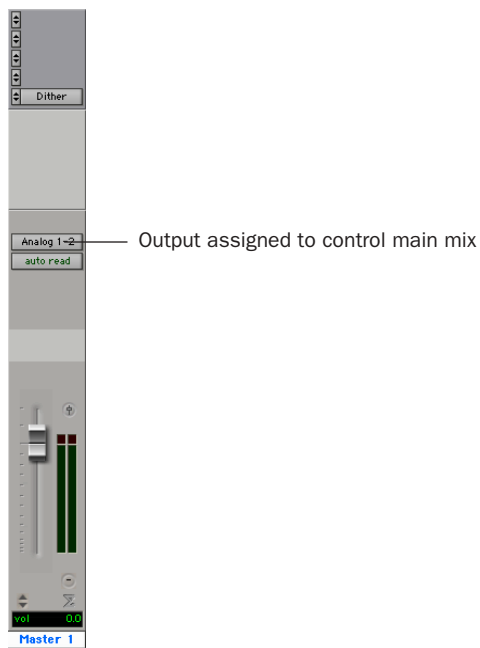

Master Fader controlling main output path

To create a Master Fader:

- 1 Choose Track > New and specify 1 Mono or Stereo Master Fader track, then click Create.
- 2 In the Mix window, click the Master Fader's Output selector and choose the output path that you want to control. You can choose either outputs or internal busses.

To use a Master Fader as a master stereo volume control for all tracks in a session:

- 1 Choose Track > New and specify 1 Stereo Master Fader track, then click Create.
- 2 Set the outputs of all audio tracks in the session to Outputs 1–2 and set the panning of each track.
- 3 Set the output of the Master Fader to your main output path (Outputs 1–2).

Plug-Ins

Plug-ins provide EQ, dynamics, delay, and many other types of effects processing, and function either in real time (RTAS) or in non-real time (AudioSuite).

RTAS plug-ins are nondestructive effects, which are inserted on tracks to process audio in real time, during playback—just like an external hardware processor.

AudioSuite plug-ins are used to process and modify audio files on disk, rather than nondestructively in real time. Depending on how you configure a non-real-time AudioSuite plug-in, it will either create an entirely new audio file, or alter the original source audio file.

Real-time plug-ins are assigned to tracks from the Inserts view in the Mix or Edit windows. Once assigned to a track, plug-ins appear in the track's Inserts view, and can be opened by clicking the Insert button.

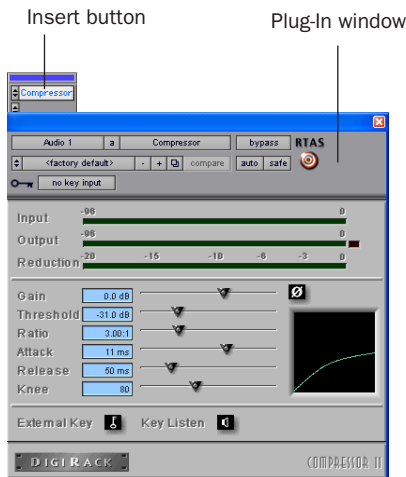

Compressor plug-in

To insert a real-time plug-in on a track:

- 1 Make sure the Inserts View is shown in the Mix or Edit window.
- 2 Click the Insert selector on the track and select the plug-in that you want to use.

Pro Tools comes with a complete set of DigiRack plug-ins, and many more are available from Digidesign and our Development Partners.

 For more information about plug-ins included with Pro Tools, see the *DigiRack Plug-Ins Guide*.

Mix Automation

Mix automation lets you record, or *automate*, changes to track volume, send levels, mutes, pan, and plug-in parameters.

To write automation:

- 1 Choose Window > Automation Enable.
- 2 In the Automation Enable window, enable an automation *type* (volume, pan, mute, send level, send pan, send mute, or any plug-in automation) by clicking its button so that it is highlighted.

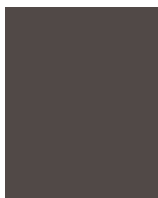

Enabling automation

- 3 In each track you want to automate, select an automation *mode* with the Automation Mode selector (Write, Touch, or Latch mode).



Setting the Automation mode of a track

- 4 Start playback and begin writing automation by adjusting faders and other controls during playback. Pro Tools LE remembers all moves performed on enabled parameters.

Once written, automation can be re-written or displayed and edited graphically in the Edit window.

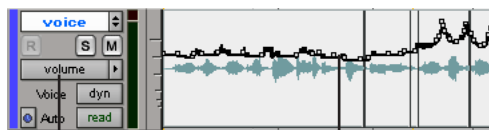

Track View Volume breakpoint automation

Volume automation in a track in the Edit window

 For more information on using automation, see the Pro Tools Reference Guide.

Final Mixdown

The Bounce to Disk command lets you write a final mix to disk, create a new loop, print effects, or bounce any submix. Once you have bounced your final mix to disk, you can use another program to burn the resulting file to CD.

When you bounce a track to disk, the bounced mix includes the following:

Audible Tracks All audible tracks are included in the bounce. Any muted tracks do not appear in the bounce. If you solo a track or region, only the soloed elements appear in the bounced mix.

Automation All read-enabled automation is played back and incorporated in the bounced mix.

Inserts and Sends All active inserts, including real-time plug-ins and hardware inserts, are applied to the bounced mix.

Selection or Track Length If you make a selection in a track, the bounced mix will be the length of the selection. If there is no selection in any track, the bounce will continue until it reaches the end of the session.

To Bounce to Disk:

- 1 Choose File > Bounce to > Disk.
 - 2 Select any mono or stereo output or bus path as the source for the bounce.
 - 3 Select the File Type (such as WAV), Format (such as mono or stereo), Resolution (such as 16-bit), and Sample Rate (such as 44.1 kHz).
-  *To create a mixdown that can be written to an audio CD, be sure to select WAV, stereo interleaved, 16-bit, and 44.1 kHz.*
- 4 If you are changing the sample rate of the bounced file, choose a Conversion Quality setting.
 - 5 Click Bounce.

Using Dither on Mixdown

You should use a dither plug-in whenever you are bouncing or mixing down audio to a lower bit depth (for example, when mastering a 24-bit session to 16-bit resolution for release on an audio CD.)

If you are bouncing or mixing down audio for reuse at the same bit depth (for example, for transfer from one 24-bit capable system to another), you do not need to dither the output.

It is preferable to use Master Faders instead of Auxiliary Inputs for applying dither, because Master Fader inserts are post-fader. With a Master Fader, any changes to the track's Volume fader will be processed by the dither plug-in.

To dither audio for mixdown:

- 1 Create a Master Fader and assign it to control the output path for the audio you want to mix down or bounce.
- 2 Insert the included POW-r Dither plug-in (or another dither plug-in) on the Master Fader, after any other plug-ins or inserts on the track.
- 3 In the dither plug-in window, click the Bit Resolution button and select the destination bit depth (20-bit or 16-bit).
- 4 In the dither plug-in window, click the Noise Shaping button and select a Noise Shaping setting. Type 1 is appropriate for mono files, and Type 2 or Type 3 are appropriate for stereo files.
- 5 Choose File > Bounce to Disk to perform the mixdown.

Sample Rate Conversion on Mixdown

When you specify a different sample rate for a bounced file (for example, when mixing down a session recorded at 96 kHz to 44.1 kHz for release on an audio CD), a Conversion Quality setting becomes available in the Bounce to Disk dialog.

There are five possible Conversion Quality settings, ranging from Low (lowest quality) to TweakHead (highest quality). The higher the quality of sample rate conversion, the longer it takes to convert the bounced file.

 *For more information on using dither and sample rate conversion when mixing down, see the Pro Tools Reference Guide.*

chapter 10

Using Digi 002 as a Stand-Alone Mixer

In addition to its function as an integrated front end and control surface for Pro Tools, Digi 002 can operate as a stand-alone digital mixer in a variety of settings. Figure 13 shows Digi 002 as the hub of a small studio setup, with analog audio and digital audio. Figure 14 shows Digi 002 in a small live performance setup.

See Chapter 8, “Connecting Your Studio” for details on analog audio, and “Digital Audio Connections in Stand-Alone Mode” on page 102 for details on making digital audio connections to Digi 002.

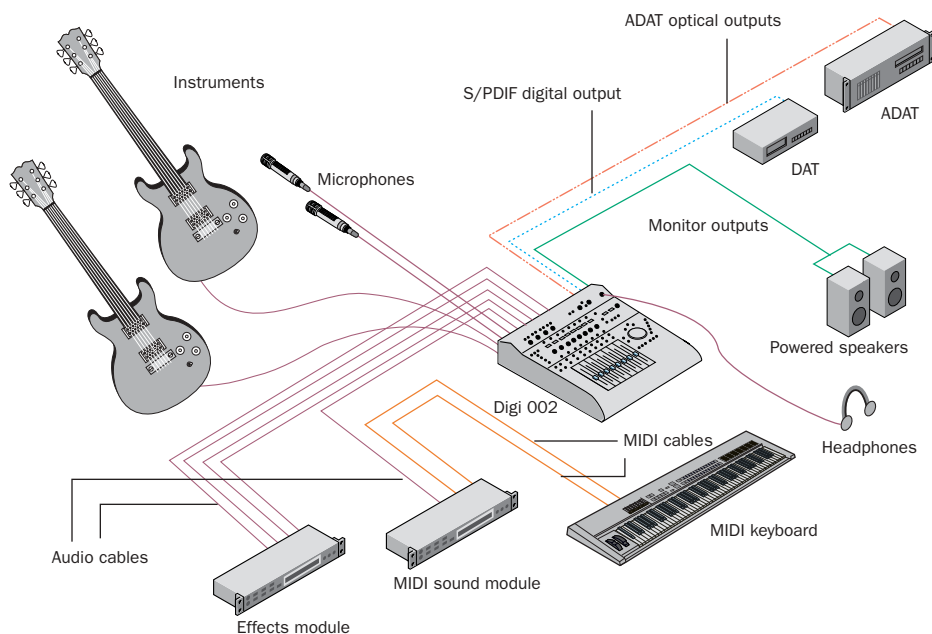

Figure 13. Digi 002 stand-alone studio configuration

The stand-alone mixing and processing capabilities of Digi 002 are provided by a powerful built-in digital signal processor (DSP). The Digi 002 unit does not need to be connected to a computer to operate in Stand-alone mode. See Appendix C, “Digi 002 Stand-Alone Block Diagram” for an overview of signal flow in Stand-alone mode.

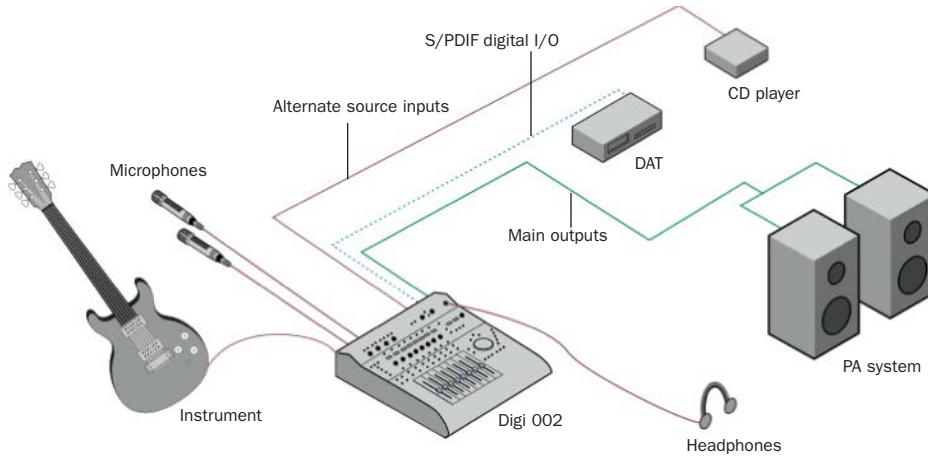

Figure 14. Digi 002 stand-alone live configuration

Overview

When operating in Stand-alone mode, Digi 002 is a 8x4x2 digital mixer, consisting of:

- Eight inputs corresponding to Analog Inputs 1–8 on the Digi 002 back panel, controlled by the eight channel strips on the top panel
 - Dedicated, in-line three-band EQ on input channels 1–8
 - Dedicated, in-line compressor on input channels 1–4
- Four available sends on each channel, for adding internal Delay or Reverb effects, or for integrating external effects processors
- A stereo output corresponding to Main Outputs 1–2 on the Digi 002 back panel

Digital Mixer Sample Rate

In Stand-alone mode, Digi 002 functions as a digital mixer with a nominal sample rate of 44.1 kHz. Analog input signals are converted to digital signals for processing and mixing.

In Stand-alone mode, Digi 002 supports digital inputs at sample rates up to 48 kHz.

⚠ *In Stand-alone mode, Digi 002 will not operate correctly with an external clock source greater than 48 kHz.*

Mixer Inputs

Inputs 1–4 These inputs accept microphone-, line-, or instrument-level signals, and provide variable gain with the Input Gain control on the Digi 002 top panel.

Phantom power is available to Inputs 1–4, in channel pairs, using the Phantom Power switches on the back panel of Digi 002.

Inputs 5–8 These inputs accept line-level signals and are switchable between –10 dBV and +4 dBu with the operating level switches on the Digi 002 back panel.

Alt Src Inputs These inputs are active in Stand-alone mode, allowing you to connect and monitor alternate audio sources such as CD players or tape decks. The signal from the Alt Src Inputs can be routed directly to the Monitor and Headphone Outputs (by pressing the Alt Src to Mon switch) or to Input channels 7–8 (by pressing the Alt Src to 7–8 switch).

When Alt Src to 7–8 is enabled, analog inputs 7–8 (1/4-inch TRS connectors on the back panel of Digi 002) are disabled.

S/PDIF Digital Inputs In Stand-alone mode, you can activate these digital inputs so that they appear on inputs 5–6, allowing you to bring a stereo digital signal into the Digi 002. (See “Digital Audio Connections in Stand-Alone Mode” on page 102.)

Sends

Each of the eight channels of Digi 002 can send to any or all of the four available sends at the same time. Sends can be either pre- or post-fader.

Send A Routes the input signal to the internal Delay processor

Send B Routes the input signal to the internal Reverb processor

Send C Routes the input signal to output 7 on the back panel of Digi 002

Send D Routes the input signal to output 8 on the back panel of Digi 002



All the send assignments in Stand-alone mode are fixed, and cannot be changed.

Dynamics

Input channels 1–4 have a dedicated, in-line compressor, with controls for the following parameters:

- Input gain
- Threshold
- Compression ratio
- Attack and release times
- Hard or soft knee (slope)
- Phase inversion
- Output gain

EQ

Each of the eight Input channels has a dedicated, in-line 3-band equalizer, consisting of the following:

- Switchable high pass/low shelf EQ band
- Parametric EQ band
- Switchable low pass/high shelf EQ band

These EQ bands can be used in conjunction with the built-in hardware high-pass filters available on Inputs 1–4.

Mixer Outputs

Main Outputs In Stand-alone mode, all eight Input channels, the Delay return, and the Reverb return are summed to outputs 1–2, which are routed to the Main Outputs, Alt Main Outputs, and the S/PDIF outputs on the back panel of Digi 002. Outputs 1–2 are also mirrored on the Monitor Outputs and Headphone Output.

ADAT Optical Outputs In Stand-alone mode all eight Input channels are passed directly to the eight ADAT Optical Outputs, pre-fader, pre-effects, except for the high-pass filter on channels 1–4. This allows you to route input signals directly to an ADAT device without repatching cables.

Entering Stand-Alone Mode

You can put Digi 002 into Stand-alone mode when the unit is in Standby mode or in Pro Tools mode. However, if Digi 002 is in Pro Tools mode when you put it in Stand-alone mode, communication with Pro Tools is suspended, and Pro Tools posts a warning dialog, allowing you to either return to Pro Tools mode, or save your session and quit Pro Tools.

To put Digi 002 in Stand-alone mode:

- 1 Press the Standalone switch on the right-hand side of the Digi 002 top panel. Digi 002 displays “Enter Standalone mode? Yes/No.”
- 2 Press the flashing Channel Select switch under “Yes” to enter Stand-alone mode. Press the switch under “No” to remain in the previous state.

⚠ *If you enter Stand-alone mode while you are in Pro Tools mode, Pro Tools software will prompt you to either exit Standalone mode or quit Pro Tools. If a Pro Tools session is open, you can save the session before quitting Pro Tools.*

To exit Stand-alone mode:

- Press the Standalone switch a second time. Digi 002 goes into Standby mode, or enters Pro Tools mode automatically if Pro Tools software is still running.

Digital Audio Connections in Stand-Alone Mode

Digital Inputs

In Stand-alone mode, you can set Inputs 5–6 to accept S/PDIF digital input instead of analog input.

When Inputs 5–6 are set to S/PDIF, the 1/4-inch analog connectors for Inputs 5–6 (on the back panel of Digi 002) are inactive.

To set Inputs 5–6 to S/PDIF digital input:

- 1 In Stand-alone mode, press the Utility (F1) switch.
- 2 Press the illuminated Channel Select switch under Pref.
- 3 Press the illuminated Channel Select switch under In56 (Inputs 5–6).
- 4 Press the illuminated Channel Select switch repeatedly to toggle Inputs 5–6 to Analog or S/PDIF.
- 5 Press the Escape (Esc) switch to exit Input 5–6 preferences.

6 Press the far right-hand Channel Select switch to save the preference settings.

7 Press the Escape (Esc) switch twice to exit Utility mode.

Digital Input Format

You can set Digi 002 to receive S/PDIF input at the RCA Input connector or the Optical Input port on the back panel of Digi 002. See “Digital Audio Connections” on page 61 for details on S/PDIF input format.

In Stand-alone mode, the RCA and Optical ports accept S/PDIF signals at sample rates up to 48 kHz.

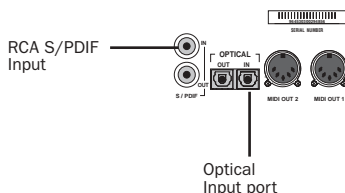

Digital input connectors (back panel)

To change the digital input format for Inputs 5–6:

- 1 In Stand-alone mode, press the Utility (F1) switch.
- 2 Press the illuminated Channel Select switch under Pref.
- 3 Press the illuminated Channel Select switch under SPDF (S/PDIF).
- 4 Press the illuminated Channel Select switch repeatedly to toggle the digital format to RCA or Optical.
- 5 Press the Escape (Esc) switch to exit SPDF preferences.
- 6 Press the far right-hand Channel Select switch to save the preference settings.

7 Press the Escape (Esc) switch twice to exit Utility mode.

⚠ Only one S/PDIF input pair can be used at a time. For example, if you use the optical input for S/PDIF data, you cannot use the RCA inputs.

Digital Clock Source

When you connect an external digital source, you can set Digi 002 to synchronize to external Word Clock (the clock signal coming from the device) or internal Word Clock (generated by Digi 002). In most cases, such as with DAT decks, you will use external clock.

To change the clock source for the digital inputs on Inputs 5–6:

- 1 In Stand-alone mode, press the Utility (F1) switch.
- 2 Press the illuminated Channel Select switch under Pref.
- 3 Press the illuminated Channel Select switch under WClk (Word Clock).
- 4 Press the illuminated Channel Select switch repeatedly to toggle the clock source to Internal or S/PDIF (external).
- 5 Press the Escape switch to exit SPDF preferences.
- 6 Press the far right-hand Channel Select switch to save the preference settings.
- 7 Press the Escape (Esc) switch twice to exit Utility mode.

When the Word Clock source is set to S/PDIF (external), the Sample Rate indicator flashes to indicate that no clock signal is present, or that Digi 002 is not receiving valid clock signal. The Sample Rate indicator lights solid to indicate Digi 002 is receiving valid clock signal.

Digital Outputs

The output configuration of Digi 002 in Stand-alone mode depends on the digital output format chosen in the S/PDIF preference setting. (This is the same setting used to configure the digital input format.)

S/PDIF Outputs

In Stand-alone mode, the S/PDIF outputs on the back panel of Digi 002 mirror outputs 1–2 at all times. If RCA is chosen in the S/PDIF preferences, only the RCA S/PDIF connector is active. If Optical is chosen in the S/PDIF preferences, *both* the RCA and Optical S/PDIF connectors are active.

If Optical is chosen in the S/PDIF preferences, only Main Outputs 1–2 are mirrored in the Optical Output port.

ADAT Optical Outputs

In Stand-alone mode, if RCA is chosen in the S/PDIF preferences, all 8 Input channels are passed directly to the ADAT Optical Output port, pre-fader and pre-effects. This allows you to route input signals directly to an ADAT device and record raw input data on all 8 channels.

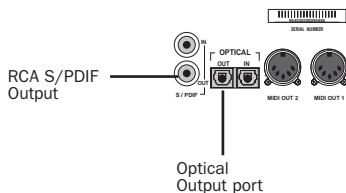

Digital output connectors (back panel)

To change the digital output format:

- 1 In Stand-alone mode, press F1 (Utility).
- 2 Press the illuminated Channel Select switch under Pref.
- 3 Press the illuminated Channel Select switch under SPDF (S/PDIF).
- 4 Press the illuminated Channel Select switch repeatedly to toggle the digital format to RCA or Optical.
- 5 Press the Escape (Esc) switch to exit SPDF preferences.
- 6 Press the far right-hand Channel Select switch to save the preference settings.
- 7 Press the Escape (Esc) switch twice to exit Utility mode.

Views in Stand-Alone Mode

In Stand-alone mode, Digi 002 can display the mixer controls in several views.

Home View

Home View is the default mixer view that you see when you first enter Stand-alone mode. This view is actually the same as Console View with the Pan controls displayed on the Rotary Encoders, and channel names on the Channel Scribble Strips.

To put Digi 002 in Stand-alone Home View:

- In Stand-alone mode, press the Pan switch in the upper left-hand corner of the Console View area.

Console View

Console View lets you toggle the Digi 002 to display either the pan position controls or the send controls for each channel.

Pan View This is the default mixer view that appears when you first enter Stand-alone mode. In Pan View, the faders control Input channel volume and the rotary encoders control pan position.

In this view, the Channel Scribble strips show the channel names. Channel names can be changed in this view. (See “Naming Channels” on page 107.)

To display pan position for all channels:

- In Stand-alone mode, press the Pan switch in the upper left-hand corner of the Console View area.

Send View This view displays the send level controls for each track on the rotary encoders. In Send View, the faders continue to control Input channel volume.

In Send view, the Channel Scribble Strips show the names associated with each send position (Send A=Dly, Send B=Rvrb, Send C=Snd C, Send D=Snd D in Stand-alone mode) across all channel strips.

To display send level controls for all channels:

- 1 In Stand-alone mode, press the Send switch in the upper left-hand corner of the Console View area.

- 2 Press any of the Send Position switches (A–D) to display the levels for the corresponding send in the rotary encoders. (In Stand-alone mode, the switch for Send E is inactive.)

When you are displaying individual sends in Send view, the Channel Select switches toggles the send between pre- and post-fader operation.

When you first display sends, the send names are shown in the Channel Scribble Strips. To see the send level value in a Scribble Strip, move its Rotary Encoder. By default, send levels are turned all the way down (– INF).

Master Fader View

Master Fader View displays 5 channels in the Digi 002 channel strip area. The Master Faders and Effects Returns appear, with the Master Faders on the right.

To put Digi 002 into Master Fader View:

- In Stand-alone mode, press the Master Fader switch to the left of the Navigation and Transport controls.

Master Faders The left and right Master Faders control the output level to Main Outputs 1–2 on the back panel of Digi 002.

Reverb Returns These are the left and right returns for Send B, the internal Reverb effect. The amount of reverb effect in the mix output can be controlled with these faders.

Delay Return This is a mono return for Send A, the internal Delay effect. The fader controls the amount of delay effect, and the rotary encoder controls its pan position in the mix output.

Reverb and Delay Mute

You can mute the Reverb and Delay effect returns by pressing the Mute switch on the respective channel while in Master Fader View. This allows you to audition the source tracks with the effects temporarily removed.

Reverb and Delay Solo Safe

In Stand-alone mode, the Reverb and Delay returns have a *Solo Safe* feature. If any input channel (1–8) has a send assigned to the Reverb or Delay and the solo switch is pressed on an input channel, the Reverb and Delay effect returns are not muted, and the effect can still be heard. You can disable the Solo Safe feature by changing the Solo preference setting.

To change the Solo Safe preference:

- 1 In Stand-alone mode, press F1 (Utility).
- 2 Press the illuminated Channel Select switch under Pref.
- 3 Press the illuminated Channel Select switch under Solo.
- 4 Press the illuminated Channel Select switch repeatedly to toggle the Solo Safe feature On or Off.
- 5 Press the Escape switch to exit Solo Safe preferences.
- 6 Press the far right-hand Channel Select switch to save the preference settings.
- 7 Press the Escape switch twice to exit Utility mode.

Channel Strip Controls

In Console View, each of the 8 channel strips on Digi 002 controls its corresponding input.

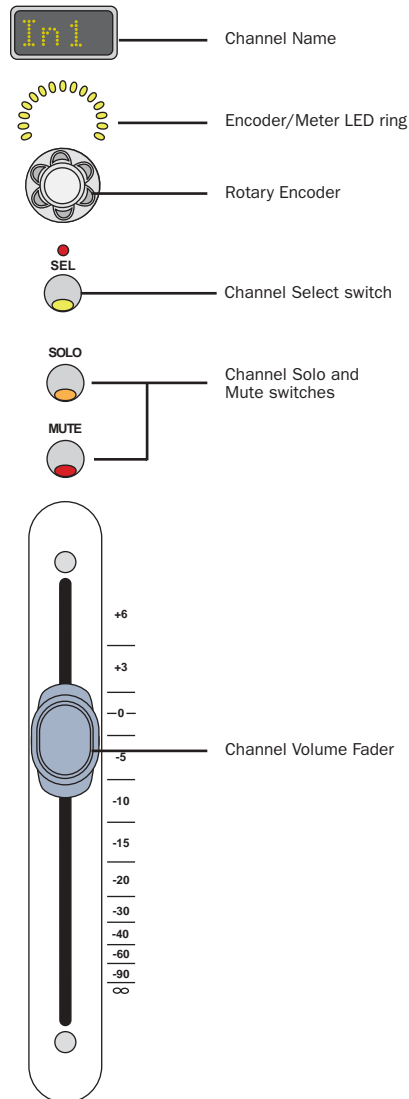

Digi 002 channel strip controls in Stand-alone mode

Channel Name

The name of each channel appears in the Channel Scribble strips. If you move a fader or rotary encoder, the scribble strip temporarily shows the volume level or pan position. You can rename each of the input channels. (See “Naming Channels” on page 107.)

Encoder/Meter LED Ring

Encoder Mode In normal mode (when the “L” and “R” Encoder/Meter indicators are lit), the LED rings above the rotary encoders indicate one of the following:

- ◆ In Pan View (or Home View), the LED rings indicate channel pan position.
- ◆ In Send View, the LED rings indicate the level for the selected send (A–D) for each channel.
- ◆ In Master Fader View, the Delay Return LED ring shows pan position. (No other Rotary Encoders are active in this view.)
- ◆ In Channel View, the LED rings display EQ, Compressor, or Pan/Send information.

Meter Mode When you press the Encoder/Meter mode switch to the right of the Channel View area so the Meter LED is lit, the LED rings act as meters in the following ways:

- ◆ In Pan View and Send View, the LED rings act as post-fader meters for each input channel.
- ◆ In Master Fader View, the LED rings act as post-fader meters for the effect return and Master Fader channels.
- ◆ When viewing EQ controls in the Channel View area, the LED rings act as post-fader meters for each input channel.
- ◆ When viewing compressor controls in the Channel View area, the LED rings act as input, output, and gain reduction meters for the displayed compressor.

Channel Volume Fader

The volume of each input is controlled by its corresponding channel fader.

Pan

The pan position of each input on the stereo output bus is controlled by its corresponding rotary encoder when Digi 002 is in Pan View.

Solo and Mute

The solo and mute status of each channel are controlled by the corresponding switches on each channel strip. In Stand-alone mode, the Solo switches behave in latched fashion, allowing more than one channel to be soloed at the same time.

Channel Select Switch

Depending on the current view, the Channel Select switch performs a variety of functions. In Pan/Send View, this switch toggles the corresponding send between pre- and post-fader operation. In Channel View, you press this switch to select a channel and display the controls for any of the internal effects on Digi 002.

Naming Channels

In Stand-alone mode, you can name the input channels so that the name appears in each channel’s scribble strip. (The names of the Master Fader and Effect Return channels cannot be changed.)

To change the name of an input channel:

- 1 If Digi 002 is not in Home View, press the Pan switch in the upper left-hand corner of the Console View area to return the unit to Home View.

2 Press F2 (Naming). The Channel Select switches flash on channels 2–8 and a cursor appears beneath the first character in the Scribble Strip of channel 1. The Channel Select switch below channel 1 lights solid to indicate that its name is being edited.

3 Turn the Rotary Encoder for the first channel to select the first character. (Available characters include uppercase and lowercase letters, numerals, and symbols.)

4 Press the Left and Right Arrow keys in the Navigation section of Digi 002 to move the cursor left and right in the Scribble Strip display.

5 When you are finished naming the first channel, you can press the Channel Select switch or move the Rotary Encoder for another channel to edit its name.

6 When you are finished naming channels, press the Escape switch or F2 again to return to Home View.

The new channel names are retained in Stand-alone mode as long as Digi 002 remains powered on.

 *To save the channel names for recall at a later time, you can store the names as part of a Snapshot. See “Storing Snapshots” on page 114.*

Channel View

Channel View lets you display the controls for the internal EQ and Dynamics effects on each channel, and also offers a way to view the all pan and send controls on a single channel.

EQ

Each Input channel offers a dedicated 3-band EQ, accessible from EQ switch in the Channel View area.

To display the EQ controls for a track:

1 In Stand-alone mode, press the EQ switch in the Channel View area.

2 Select a channel whose EQ controls you want to display by pressing its Channel Select switch. The Display Scribble Strips show “EQ” and the number of the selected channel.

Digi 002 displays the EQ controls across the Channel Scribble Strips.

See “EQ Controls” on page 110 for more information on working with EQ effects.

Dynamics

Input channels 1–4 offer a dedicated compressor, accessible from the Dynamics switch in the Channel View area.

To display the compressor controls for a track:

1 In Stand-alone mode, press the Dynamics switch in the Channel View area.

2 Select from channels 1–4 the channel whose Dynamics controls you want to display by pressing its Channel Select switch.

Digi 002 displays the compressor controls across the Channel Scribble Strips. The Display Scribble Strips show “Dyn” and the number of the selected channel.

See “Dynamics Controls” on page 111 for more information on working with Dynamics effects.

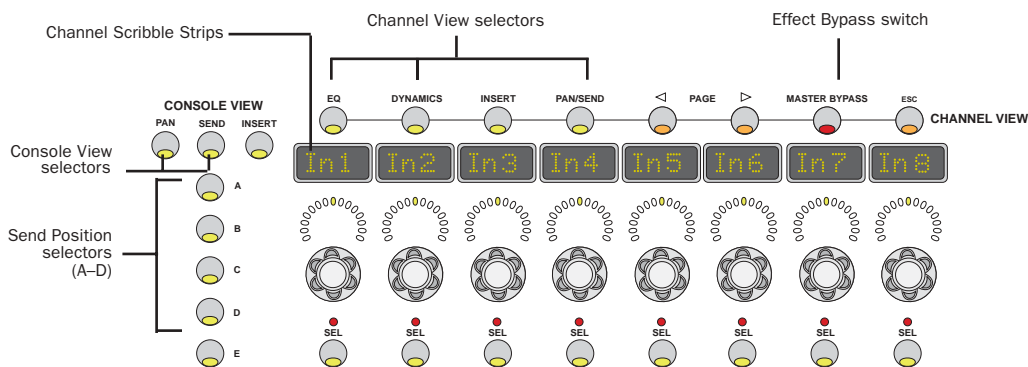

Digi 002 Console and Channel View controls in Stand-alone mode

Pan/Send

The Pan/Send view allows you to view the pan position and the controls for all of the sends on a selected track across all the Channel Scribble Strips.

To display the pan and send controls for a track:

- 1 In Stand-alone mode, press the Pan/Send switch in the Channel View area.
- 2 Select a channel whose Pan and Send controls you want to display by pressing its Channel Select switch. The Display Scribble Strips show “P/S” and the number of the selected channel.

Channel Scribble Strip 1 and the first rotary encoder show track pan position for the selected channel.

Channel Scribble Strips 3–6 show the names and their rotary encoders control the levels for all four sends on that track. (Channel Scribble Strips 2, 7 and 8 are inactive.)

When you are displaying sends in Pan/Send view, the Channel Select switches toggles the send between pre- and post-fader operation.

Displaying Parameter Values

The default view for channels, inserts in sends shows the name of the control in the Channel Scribble Strips, and the control’s numerical value is shown only when the control is touched or moved.

By pressing the Command switch and the Display mode switch in tandem, you can change the default view to the numerical value of a control rather than its name.

To revert to the default display, press the Command switch and the Display mode switch a second time.

In addition, pressing the Command switch in tandem with the Display mode switch allows you to set channels to display numerical parameter values by default, rather than control names. For example, in Pan view, when you press Command + Display, fader volume levels (in dB) are the default display.

Working with Effects

In Channel view, the controls for the Digi 002 EQ and Dynamics effects are displayed across the Channel Scribble Strips.

EQ Controls

To access EQ controls for a track:

- 1 Press the EQ switch in the Channel View area above the Channel Scribble Strips.
- 2 Press the Channel Select switch on the channel whose EQ controls you want to display.

The onboard EQ controls are distributed across the Channel Scribble Strips as shown in Table 11. The second row of the table shows the function of the Rotary Encoders, and the bottom row of the table shows the function of the Channel Select switches in this view.

- 3 When you are finished setting the EQ controls, return to Home View by pressing the Pan switch in the Console View area.

While EQ controls are displayed, you can bypass EQ processing by pressing the Master Bypass switch in the Channel View area. The Master Bypass switch bypasses all 3 bands of EQ for the selected channel.

To bypass EQ controls for a track:

- 1 Press the EQ switch in the Channel View area above the Channel Scribble Strips.
- 2 Press the Channel Select switch on the channel whose EQ controls you want to bypass.
- 3 Press the Master Bypass switch while in Channel View. The switch flashes to indicate that the displayed EQ is currently bypassed.

Table 11. EQ controls in Digi 002 Stand-alone mode

Display	Inpt	> F or ~F	> G or ~G	^ F	^ Q	^ G	< F or ~ F	<G or ~ G
Rotary Encoder	Input Gain	Low Shelf Frequency or High Pass Frequency	Low Shelf Gain	Peak Frequency	Peak Q	Peak Gain	High Shelf Frequency or Low Pass Frequency	High Shelf Gain
Channel Select		Toggle between filters	Bypass Low Band			Bypass Mid-Band	Toggle between filters	Bypass High Band

Dynamics Controls

To access Dynamics controls for a track:

- 1 Press the Dynamics switch in the Channel View area above the Channel Scribble Strips.
- 2 Press the Channel Select switch on the channel whose Dynamics controls you want to display.

The onboard compressor controls are distributed across the Channel Scribble Strips as shown in Table 12. The second row of the table shows the function of the Rotary Encoders, and the bottom row of the table shows the function of the Channel Select switches in this view.

- 3 When you are finished setting the Dynamics controls, return to Home View by pressing the Pan switch in the Console View area.

You can bypass Dynamics processing at any time by pressing the Master Bypass switch in the Channel View area. The Master Bypass switch bypasses compression for the selected channel.

To bypass Dynamics controls for a track:

- 1 Press the Dynamics switch in the Channel View area above the Channel Scribble Strips.
- 2 Press the Channel Select switch on the channel whose Dynamics controls you want to bypass.
- 3 Press the Master Bypass switch. The switch flashes to indicate that the displayed compressor is currently bypassed.

Table 12. Compressor controls in Digi 002 Stand-alone mode

Display	Inpt	Thsh	Rtio	Atck	Rels	Knee	Phas	Outp
Rotary Encoder	Input Gain	Threshold	Compression Ratio	Attack Time	Release Time	Knee Type	Phase Invert	Output Gain
Channel Select						Toggle Hard and Soft Knee	Toggle Normal and Invert	

Working with Sends

In Stand-alone mode, each Input channel has four fixed sends, with the first two dedicated to the internal Delay and Reverb processing of Digi 002.

To display and edit the sends to the Delay:

- 1 Press the Send switch in the upper left-hand corner of the Digi 002 unit, in the Console View area.
- 2 Press the Send A switch (located immediately below the Send switch you just pressed). The rotary encoders show the levels for the corresponding sends on each track.
- 3 Adjust the rotary encoders as desired to send signal to the onboard Delay.
- 4 Press the Master Fader switch, located to the left of the Navigation and Transport section. The return track for Send A is named *Dly*.
- 5 Adjust the fader volume and pan position for the return track.
- 6 Press the Master Fader switch again to return to the previous view, or press the Pan switch to return to Home View.

To display and edit the sends to the Reverb:

- 1 Press the Send switch in the upper left-hand corner of the Digi 002 unit, in the Console View area.
- 2 Press the Send B switch. The rotary encoders show the levels for the corresponding sends on each track.
- 3 Adjust the rotary encoders as desired to send signal to the onboard Reverb.
- 4 Press the Master Fader switch, located to the left of the Navigation and Transport section. The stereo return tracks for Send B are named *RvbL* and *RvbR*.
- 5 Adjust the fader volume for the return tracks.
- 6 Press the Master Fader switch again to return to the previous view, or press the Pan switch to return to Home View.

Delay Controls

To access the controls for the onboard Delay:

- 1 Press the Master Fader switch.
- 2 Press the Channel Select switch on the Delay return channel.

The onboard Delay controls are distributed across the Channel Scribble Strips as shown in Table 13. The first row of the table shows the function of the Rotary Encoders, and the bottom row of the table shows the function of the Channel Select switches in this view.

- 3 When you are finished setting the Delay controls, press the Escape key to return to the Master Fader view.

Reverb Controls

To access the controls for the onboard Reverb:

- 1 Press the Master Fader switch.
- 2 Press the Channel Select switch on either of the Reverb return channels.

The onboard Reverb controls are distributed across the Channel Scribble Strips as shown in Table 14. The table shows the function of the Rotary Encoders in this view.

- 3 When you are finished setting the Reverb controls, press the Escape key to return to the Master Fader view.

Table 13. Delay controls in Digi 002 Stand-alone mode

Display	Time	Fdbak	LPF		D → R
Rotary Encoder	Delay Time	Feedback	Low-pass Filter		Delay Send to Reverb
Channel Select					Pre/Post

Table 14. Reverb controls in Digi 002 Stand-alone mode

Display	Room	PDly	LPF	Smer	Damp	Diff	Time
Rotary Encoder	Room Type	Pre-Delay Time	Low-Pass Filter	Smear	Damping	Diffusion	Reverb Decay Time

Storing Snapshots

Digi 002 allows you to store up to 24 stand-alone mix configurations and recall them at any time. You can use snapshots to create mix templates or to capture a mix in progress.

A 25th mix configuration, containing stand-alone system defaults, can be recalled, but cannot be modified or renamed.

Snapshots store the following information for each input channel:

- Channel name
- Channel fader position
- Channel pan position
- EQ and compressor settings
- Send levels

To store a snapshot of a mix configuration:

- 1** Arrange mixer controls, name channels, and set effects controls as desired.
- 2** Return to Home View by pressing the Pan switch in the upper left-hand corner of the Console View area.
- 3** Press F3 (Snapshot).
- 4** Press the Channel Select switch under Save.
- 5** Turn the Rotary Encoder under the snapshot number to set the number (1–24).
- 6** Press the Left and Right Arrow keys in the Navigation section of Digi 002 to move the cursor in the Scribble Strip display.
- 7** If you want to rename the snapshot, press the Left and Right Arrow keys in the Navigation Section, and turn the Rotary Encoder under the snapshot number to change each character in the snapshot name.

8 Press the flashing Channel Select switch to save the snapshot, or press the Escape switch twice to cancel the operation and return to Home View.

To recall a snapshot:

- 1** Return to Home View by pressing the Pan switch in the upper left-hand corner of the Console View area.
- 2** Press F3 (Snapshot).
- 3** Press the Channel Select switch under Load.
- 4** Turn the Rotary Encoder under the snapshot number to recall the desired snapshot. (Snapshot #25 returns Digi 002 to its default settings.)
- 5** Press the flashing Channel Select switch to load the snapshot, or press the Escape switch twice to cancel the operation and return to Home View.

appendix a

Configuring MIDI Studio Setup (Windows Only)

MIDI Studio Setup

MIDI Studio Setup (MSS) lets you configure the MIDI controllers and sound modules that are connected to your system, and control the routing of MIDI data between your MIDI equipment and Pro Tools.

MSS automatically finds MIDI interfaces, and lets you specify a custom name for each of the MIDI ports within the MIDI Studio Setup document.

MSS also supports XML-based patch file names for storing and importing patch names for your external MIDI devices.

Entire MIDI Studio Setup configurations created within MSS can be imported and exported.

MIDI Studio Setup Window

The MIDI Studio Setup window is organized into three sections. Interface controls are at the top of the window. All the currently defined instruments are displayed in the Instrument Name list on the left side of the window. A detailed view of MIDI parameters is shown in the Properties section on the right.

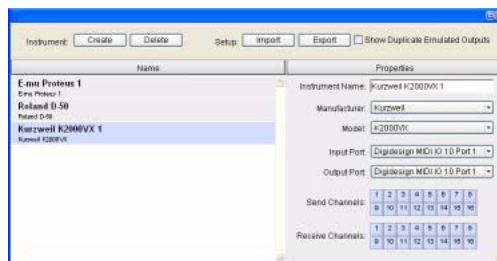

MIDI Studio Setup window

Interface Controls

Create This button adds a new instrument to the Instrument Name list.

Delete This button deletes the instrument or instruments selected in the Instrument Name list.

Import This button lets you import an existing MIDI Studio Setup file.

Export This button lets you export the current MIDI Studio Setup file.

Show Duplicate Emulated Ports If you are using a MIDI interface that supports timestamping (such as MIDI I/O), when the Show Duplicate Emulated Outputs option is selected, the MIDI Studio Setup window shows both the Direct-Music time-stamped output ports, and non-stamped duplicate emulated output ports.

⚠ *Some MIDI Interfaces will not properly load or unload their drivers unless you quit and re-launch Pro Tools. Check the documentation that came with your MIDI interface for more information.*

Instrument List

The Instrument list contains all the currently defined instruments. Selecting an instrument in the list displays that instrument's properties in the Properties section of the window.

Properties Section

The Properties section lets you edit information for new instruments, or instrument currently selected in the Instrument list.

MIDI Studio Setup Properties section

When a previously defined instrument is selected in the Instrument list, the Properties section changes to reflect the properties of the selected instrument.

To define an instrument with MIDI Studio Setup:

- 1 Choose Setup >MIDI > MIDI Studio.
- 2 Click Create.
- 3 In the Instrument Name field, type the name of your instrument, and press enter.

💡 *If you do not enter an instrument name, the Instrument Name field will automatically inherit information from the Manufacturer and Model pop-up menu.*

- 4 Set a manufacturer and model for the new device from the corresponding pop-up menus. If the Manufacturer and Model pop-up menus do not provide a name for your particular device, choose None.

- 5 From the Input pop-up menu, choose the input port on your MIDI interface that is connected to the MIDI Out of your instrument.

- 6 From the Output pop-up menu, choose the output port on your MIDI interface that is connected to the MIDI In of your instrument.

- 7 Enable the appropriate MIDI channels (1–16) for the Send Channels and Receive Channels options (These determine which channels send and receive MIDI.)

Instrument Name

The Instrument Name field shows the user-definable instrument name for the currently selected instrument.

Manufacturer

The Manufacturer pop-up menu provides a list of MIDI equipment manufacturers. This list is derived from the XML-based MIDI device files.

📖 *For more information, see “MIDI Patch Name Support” on page 117.*

Model

The Model pop-up menu provides a list of MIDI devices, filtered by the manufacturer name. This list is derived from the XML-based MIDI device files provided with your Pro Tools installation.

 For more information, see “MIDI Patch Name Support” on page 117.

Input Port

The Input Port pop-up menu displays a list of available MIDI interface input ports. The MIDI interface port that is set and displayed here is the port through which MIDI data is sent from the external MIDI device specified in the Instrument Name field into your MIDI interface.

 If you set the input port to None, the defined instrument will not appear as a choice in a MIDI Input selector.

Output Port

The Output Port pop-up menu displays a list of available MIDI interface output ports. The port set and displayed here is the port through which MIDI data is sent from your MIDI interface to the MIDI device specified in the Instrument Name field.

 If you set the output port to None, the defined instrument will not appear as a choice in a MIDI Output selector.

Send Channels

The Send Channels grid sets the send channels for the MIDI device specified in the Instrument Name field.

Receive Channels

The Receive Channels grid sets the receive channels for the MIDI device specified in the Instrument Name field.

MIDI Patch Name Support

Pro Tools supports XML (Extensible Markup Language) for storing and importing patch names for your external MIDI devices. Pro Tools installs MIDI patch name files (.midnam) for the factory default patch names of many common MIDI devices. These files reside in directories, sorted by manufacturer, in Program Files\Common Files\Digidesign\MIDI Patch Names\Digidesign.

To import MIDI patch names into Pro Tools:

- 1 Verify the MIDI Device name in the MIDI Studio Setup window (see “MIDI Studio Setup” on page 115).
- 2 Verify the MIDI track’s output is correctly assigned to the MIDI device.
- 3 Click the MIDI track’s Patch Select button.



Patch Select button, Edit window



Patch Select button, Mix window

4 In the Patch Select dialog, click the Change button.

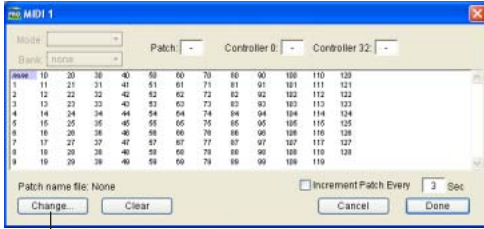

Change button

Patch Select dialog

5 In the Open dialog, navigate to Program Files\Common Files\Digidesign\MIDI Patch Names\Digidesign\

6 Click Open.

The Patch Select dialog is populated with patch names and the Patch Name Bank pop-up menu appears in the upper left hand corner of the window.

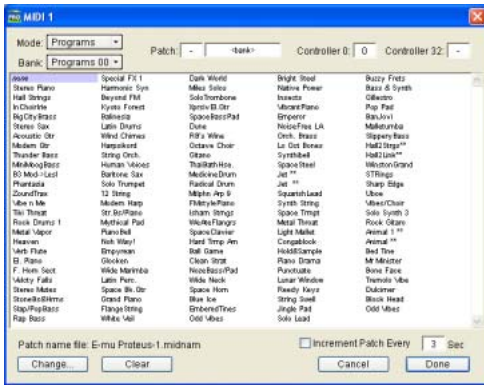

Patch Select dialog with patch names

Once patch names have been imported into Pro Tools, they are available for that MIDI device in all sessions.

To clear patch names:

- In the Patch Select dialog, click the Clear button, and click Done.

💡 MIDI patch name files (.midnam) can be edited in any text editor, or you can use third party patch librarian and editor software to create your own custom patch names.

appendix b

Configuring AMS (Mac OS X Only)

Audio MIDI Setup

Pro Tools recognizes the ports on your MIDI interface as generic ports. With Mac OS X, you use Apple's Audio MIDI Setup (AMS) utility to identify external MIDI devices connected to your MIDI interface and configure your MIDI studio for use with Pro Tools.

To configure your MIDI studio in AMS:

1 Launch Audio MIDI Setup (located in Applications/Utilities).

– or –

In Pro Tools, choose Setup > MIDI > MIDI Studio.

2 Click the MIDI Devices tab. AMS scans your system for connected MIDI interfaces. If your MIDI interface is properly connected, it appears in the window with each of its ports numbered.

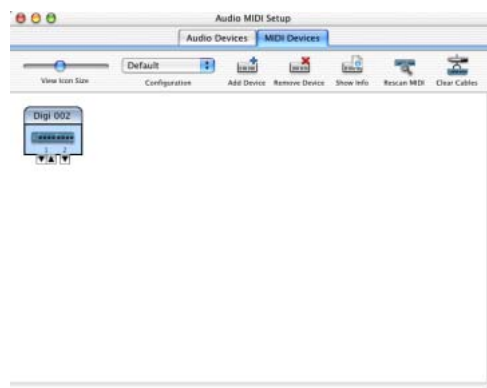

Audio MIDI Setup (MIDI Devices tab)

3 For any MIDI devices connected to the MIDI interface, click Add Device. A new external device icon with the default MIDI keyboard image will appear.

4 Drag the new device icon to a convenient location within the window.

5 Connect the MIDI device to the MIDI interface by clicking the arrow for the appropriate output port of the device and dragging a connection or “cable” to the input arrow of the corresponding port of the MIDI interface.

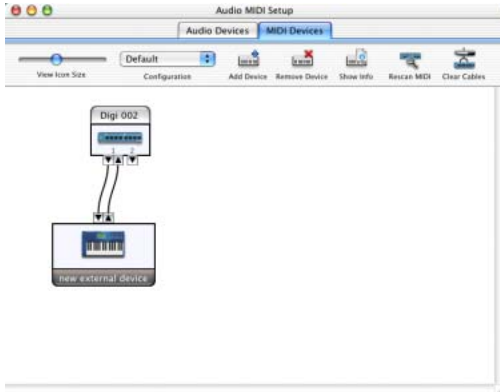

Making MIDI input and output connections

6 Click the arrow for the appropriate input port of the device and drag a cable to the output arrow of the corresponding port of the MIDI interface.

 To remove a connection, select the cable and press Delete. To delete all connections, click Clear Cables.

7 Repeat steps 3–6 for each MIDI device in your MIDI setup.

To configure an external MIDI device:

1 Select the external device icon and click Show Info (or double-click the new device icon).



External Device Icon

2 Select a manufacturer and model for the new device from the corresponding pop-up menus. (If the Manufacturer and Model pop-up menus do not provide a name for your particular device, you can type a name.)



Naming a new MIDI device

 For Manufacturer and Model names, AMS refers to one or more files with the suffix “.middev” in the directory Root/Library/Audio/MIDI Devices. Pro Tools installs a file that contains information for many commercially available MIDI devices, named “Digidesign Device List.middev.” If the Manufacturer or Model names for any of your external MIDI devices is not available in the AMS Manufacturer and Model pop-up menus, you can add them by editing the .middev file in any text editor (such as TextEdit).

3 Click the More Properties arrow to expand the dialog, then enable the appropriate MIDI channels (1–16) for the Transmits and Receives options. (These determine which channels the device will use to send and receive MIDI.)

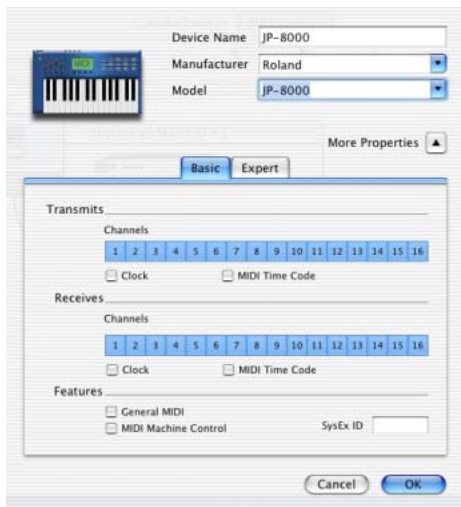

Enabling MIDI channels

4 Click the device image. The window expands to show images for various MIDI devices (such as keyboards, modules, interfaces, and mixers). Select an icon for your device.



Selecting a device icon

 *To use your own custom icons, you can place TIFF image files in /Library/Audio/MIDI Devices/Generic/Images, and they will appear as choices in the AMS device window.*

5 Click OK.

The device names you enter appear as MIDI input and output choices in Pro Tools.

Patch Name Support

Pro Tools supports XML (Extensible Markup Language) for storing and importing patch names for you external MIDI devices. Pro Tools installs MIDI patch name files (.midnam) for the factory default patch names of many common MIDI devices. These files reside in directories, sorted by manufacturer, in /Library/Audio/MIDI Patch Names/Digidesign.

To import MIDI patch names into Pro Tools:

- 1 Verify the MIDI Device name in the Audio MIDI Setup window (see “Audio MIDI Setup” on page 119).
- 2 Verify the MIDI track’s output is correctly assigned to the MIDI device.
- 3 Click the MIDI track’s Patch Select button.



Patch Select button, Edit window



Patch Select button, Mix window

- 4 In the Patch Select dialog, click the Change button.

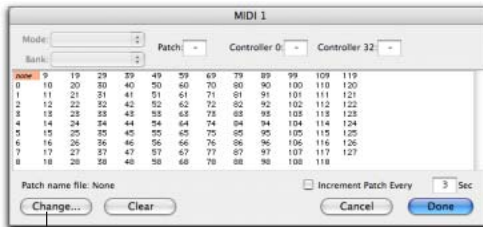

Change button

Patch Select dialog

- 5 In the Open dialog, navigate to /Library/Audio/MIDI Patch Names/Digidesign/<name of manufacturer>, and select the MIDI Patch Name file (.midnam) for the MIDI device.
- 6 Click Open.

The Patch Select dialog is populated with patch names and the Patch Name Bank pop-up menu appears in the upper left hand corner of the window.

Once patch names have been imported into Pro Tools, they are available for that MIDI device in all sessions.

To clear patch names:

- In the Patch Select dialog, click the Clear button, and click Done.



MIDI patch name files (.midnam) can be edited in any text editor, or you can use third party patch librarian and editor software to create your own custom patch names.

appendix c

Digi 002 Stand-Alone Block Diagram

The diagram on the following pages shows the basic signal flow of Digi 002 in Stand-alone mode.

The diagram shows the Digi 002 mixer divided into two sections, with the first page showing Input Channels 1–4, the second page showing Input channels 5–8 and the Master Faders, Effect Returns, and Outputs. The two sections share the four send busses (A–D), the main stereo bus (L–R), and the ADAT Optical output bus (ADAT 1–8).

⚠ *This signal flow diagram is not a detailed circuit diagram or wiring schematic. It is intended to provide an overview of the mixer functions of Digi 002 in Stand-alone mode only.*

DIGIDESIGN
 DIGI 002
 STAND-ALONE MODE
 BLOCK DIAGRAM

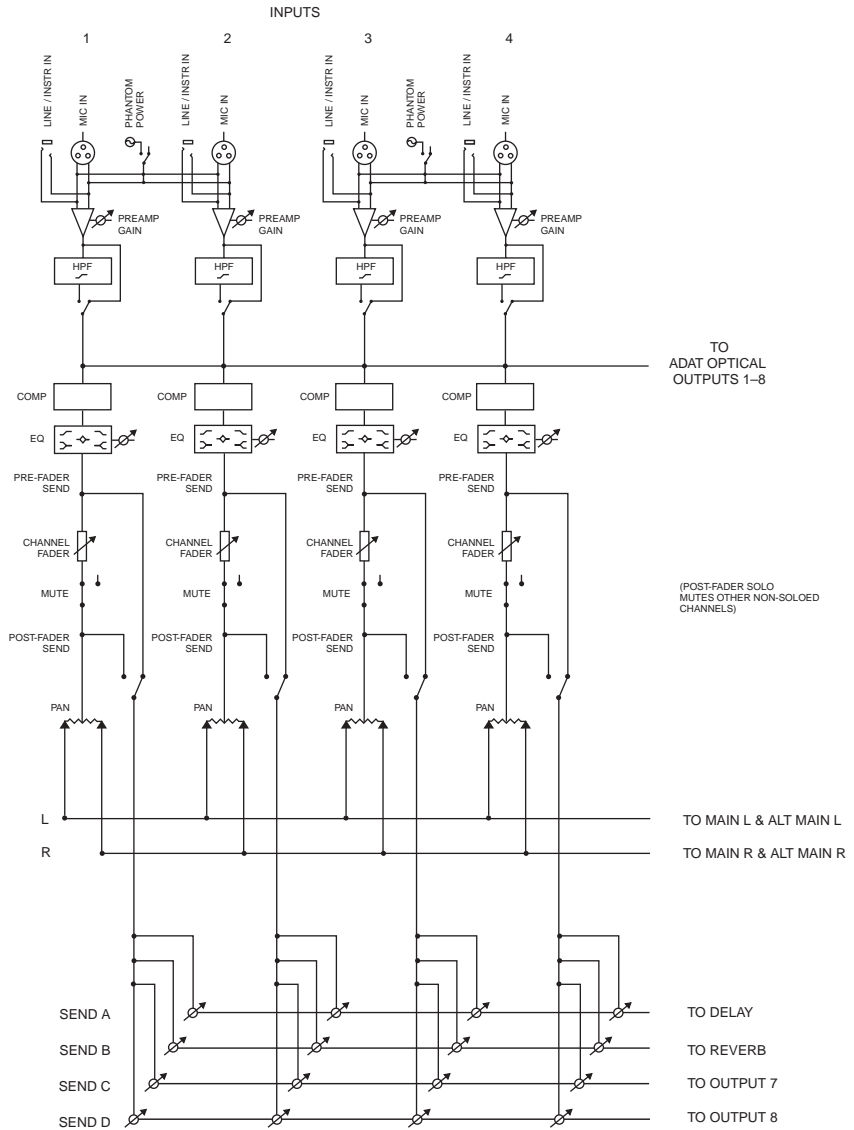

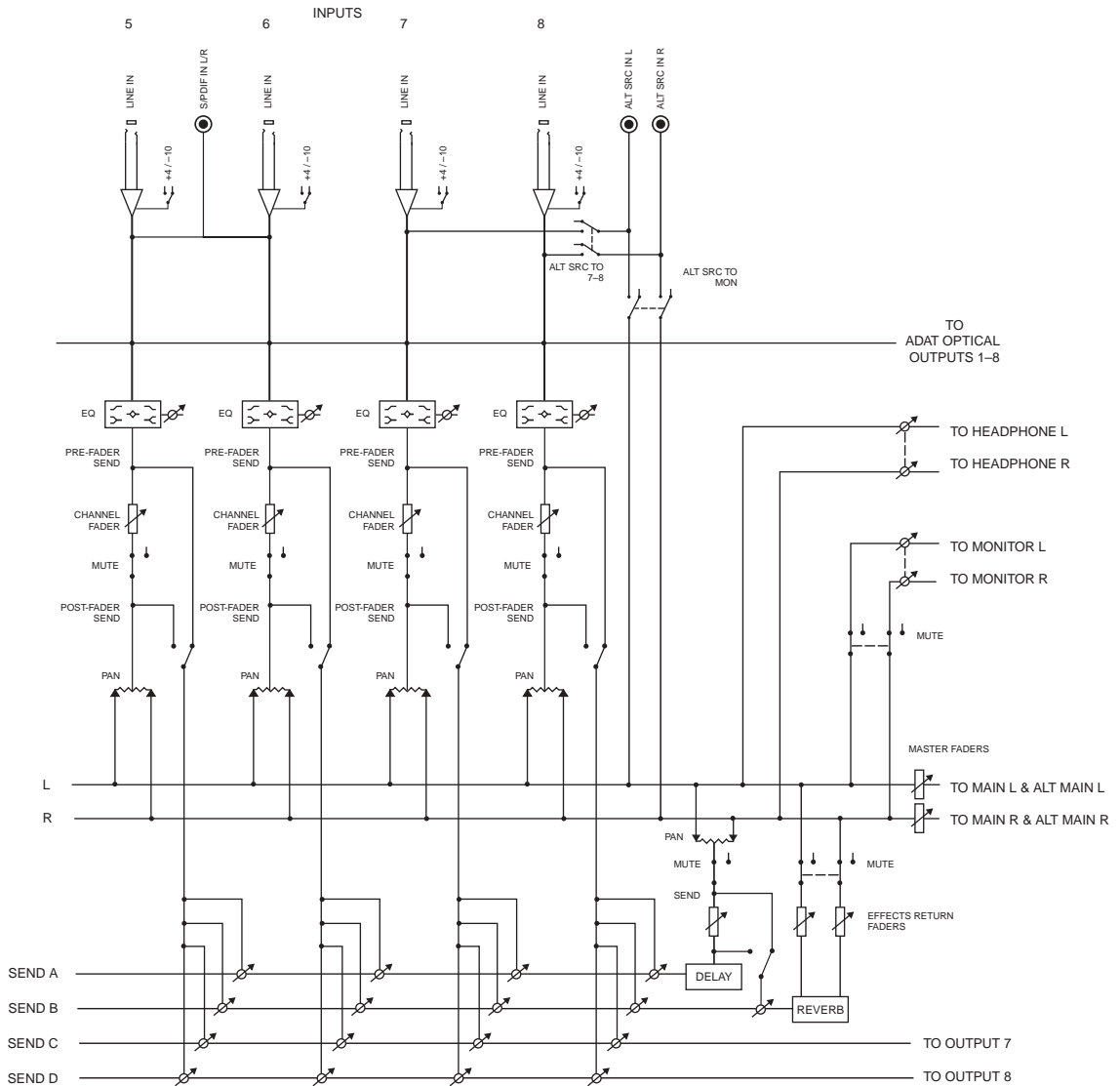

Appendix D: Troubleshooting

Backing Up Your Work

It is highly recommended that you back up your work on a regular basis, and especially before making changes to your system configuration.

Backing Up Your Session Data

Back up your session and audio data frequently. There are a variety of media that are suited to back up projects of various sizes, from automated tape backup systems to high-capacity optical drives, or to CD burners.

The best way to back up an entire session is to use the Save Copy In command. This command lets you save the session file and all of its associated files to a new location.



You can also use the Auto Save Backup feature (in the Operation Preferences page) to have Pro Tools automatically save backups of the session file while you work.

Backing Up Your System Configuration

After configuring your system and Pro Tools, you should save an image of your system drive using a backup utility such as Norton Ghost (Windows) or Bombich Carbon Copy Cloner (Macintosh). By doing this, you can quickly restore your system configuration and settings if you encounter any problems.

Common Issues

Pro Tools Won't Launch

Problem

When you double-click the Pro Tools application or a Pro Tools session file, Pro Tools doesn't launch, or displays an error message.

Possible Solutions

- ◆ Check to be sure your computer has the required amount of RAM to launch Pro Tools. See the compatibility page of the Digidesign Web site (www.digidesign.com/compato).
- ◆ Try a complete restart. Turn off your audio interfaces, computer peripherals and your computer, and then turn them on again in the proper sequence.
- ◆ If you tried to launch Pro Tools by double-clicking a Pro Tools session file, do the following:
 - Close any error message.
 - Double-click the Pro Tools application.
 - In Pro Tools, choose File > Open Session to open the session.
- ◆ Reinstall the Pro Tools application, using the Pro Tools Installer CD.

Audio Interface Is Not Recognized

Problem

When you launch Pro Tools it does not recognize an audio interface, or a connected audio interface is not available.

Possible Solutions

- ◆ Turn off your computer and check to be sure your cables are properly and securely connected to your computer and to your audio interface.
- ◆ Verify that your Hardware Setup dialog settings are correct.

Performance Factors

There are several conditions that may adversely affect the performance of Pro Tools. These include:

Network Connections Close any network connections unless you are using them for network interchange of audio data.

Background Applications Any software utilities that run in the background or generate disk activity, such as virus protection, disk optimization, or file savers, should be turned off or removed.

Screen Savers Screen saver software should be completely disabled on your computer before running Pro Tools.

Power Saver Features Some automatic power saver features, such as those that spin down the system hard drive, can affect Pro Tools performance. These features should be turned off.

Before You Call Digidesign Technical Support

Register Your System

Register your purchase immediately after reviewing the registration information card included with every Pro Tools system. Registering your purchase is the only way you become eligible to receive complimentary technical support and future upgrade offers. Registering is one of the most important steps to complete as a new user.

Use Digidesign Resources

In addition to the printed and PDF versions of Pro Tools guides, your system includes the following sources of information:

Read Me Files These contain late-breaking information and known issues pertaining to Pro Tools software and hardware configurations. Read Me files are installed in Documentation folder when you install Pro Tools.

Answerbase This is a database of common problems and DAE errors, and their solutions based on the latest information from Digidesign Technical Support. This database is installed in the Digidesign folder when you install Pro Tools. Answerbase is also available on the Digidesign Web site (www.digidesign.com).

Web Site (www.digidesign.com) This is your best online source for information to help you get the most out of your Pro Tools system.

Gather Important Information

Digidesign wants to help you resolve problems as quickly and efficiently as possible. If you have the following information handy when you contact Technical Support, it will make the diagnosis of your problem easier. Take a few minutes to collect the following basic information:

System Information

Computer

- Make, model, processor speed
- Amount of system RAM
- Operating system (version of Windows or Macintosh)
- Any Drivers, Disk Utilities, or other system-related applications you may have installed

Digidesign Hardware

- Type of cards, interfaces, or peripherals

Hard Drives

- Make, Model
- Drive size (GB)
- Drive speed (RPM)
- Drive type (SCSI, FireWire, IDE/ATA)
- Utility used to format the drive
- Number and size of partitions on the drive

Digidesign Software

- Pro Tools software version
- Plug-in versions
- Other Digidesign software
- Additional plug-ins from Digidesign Development Partners

Other Hardware

Refer to the manufacturer's documentation for operational details.

The most common hardware additions include:

- 1394 (FireWire) cards for Windows systems (manufacturer, model)
- Video Capture cards (manufacturer, model)

To verify that your hardware is qualified for use with your Pro Tools system, refer to the compatibility page of the Digidesign Web site (www.digidesign.com/compato).

Other Software

If you are using other audio or video applications, refer to the manufacturer's documentation for operational details.

Make note of any other software that was running when a problem occurred.

Diagnostic Information

Note any DAE errors or other error codes you encounter. Additionally, note the ability to reproduce the problem under different conditions, for example, with another session, or after changing settings (such as the Hardware Buffer Size).

index

A

- ADAT
 - connecting 64
 - recording from Pro Tools LE 85
 - recording to Pro Tools LE 85
- adjusting Mic/Line input gain 83
- analog audio 59
- analog devices, connecting 60
- analog tape deck, connecting 64
- ASIO driver (Windows) 15
- audio
 - editing 90
 - importing 81
 - routing 83, 94
 - tracks 74, 75
- audio drivers
 - ASIO driver (Windows) 15
 - CoreAudio driver (Macintosh) 20
 - WaveDriver (Windows) 15
- Audio MIDI Setup (AMS) (Macintosh) 119
- authorizing Pro Tools LE 23
- automation 97
 - editing 97
 - writing 97
- Auxiliary Inputs 74, 75, 94

B

- Bounce to Disk command 97

C

- CD audio 81
- channel controls
 - Channel Select switch 32
 - faders 32
 - Mute switch 32
 - Record Ready switch 33
 - rotary encoders 33
 - scribble strip 33
 - Solo switch 32
- Channel Select switch 32, 107
- channel strip controls
 - Mute 93
 - Pan 93
 - Solo 93
 - Volume 93
- Channel View 31, 36
- channels
 - naming 107
- click
 - external MIDI 72
- Clock Source 26, 103
- Conductor ruler 70
- connecting
 - a footswitch 89
 - analog devices 60
 - digital devices 64
 - headphones 58
 - microphones 60
 - MIDI devices 65
 - speakers 58
 - to a mixdown recorder 64
 - to an ADAT 64
- Console View 31, 35
- CoreAudio driver (Macintosh) 20
- CPU Usage Limit 25

D

- DAE Playback Buffer Size 25
- DAT recorder, connecting 64
- defragmenting hard drives
 - maintenance 12
- Delay 113
- Digi 002
 - connecting 12, 21
 - features 1, 2
 - top panel 30
 - what's included 1
- Digi 002 Rack
 - connecting 12, 21
 - features 1
 - front panel 45
- digital audio
 - ADAT format 61
 - S/PDIF format 61
- digital devices, connecting 64
- drive formatting
 - Macintosh 19
 - Windows 11
- drive maintenance
 - Macintosh 19
 - Windows 11
- drive requirements 4
- Dynamics 36
 - in Channel View 36, 108
 - in Stand-alone mode 100, 101

E

- Edit modes 90
 - Grid 90
 - selecting 90
 - Shuffle 90
 - Slip 90
 - Spot 90
- Edit tools 90
 - Grabber 90
 - Pencil 90
 - Scrubber 90
 - Selector 90
 - Smart Tool 90
 - Trimmer 90
 - Zoomer 90
- Edit window 68

- editing 90
 - regions 91
- EQ 36
 - in Channel View 36, 108
 - in Stand-alone mode 100, 101
- Ethernet Support software 15
- external effects devices 61, 62

F

- fade files 67
- Fader Flip 34
- faders 32
- FireWire 53
 - cable types 13, 22
 - connecting devices 13, 22, 53
 - connecting drives 13, 21, 53
 - connection status 47
- footswitch 54

G

- gain
 - adjusting for Mic/Line inputs 83
- Grabber tool 90
- Grid mode 90

H

- hard drives
 - FireWire 13, 21, 53
 - formatting 11, 19
 - MacDrive utility 16
 - maintenance 11, 19
 - requirements 4
 - storage space for audio 4
- Hardware Buffer Size 24
- hardware installation 8
- headphones
 - connecting 58
- headroom 49
- high-pass filter 84
- Home View 31

I

- I/O Setup 27
- importing
 - audio 81
 - CD audio 81
 - files with drag and drop 82
 - MIDI 82
- importing audio 81
- input controls 40, 46
- input levels 83
- inputs 40, 46, 51, 101
 - alternate inputs 40, 46
 - analog 51
 - digital 52, 102
 - optical 53
 - S/PDIF 52, 101
- inserts 36
 - in Channel View 36
 - plug-ins 96
- installing Pro Tools LE
 - Macintosh 20
 - Windows 14
- installing QuickTime (Windows) 14
- Instrument tracks 74

K

- key commands 6

L

- latency for recording and monitoring 85
- Lightpipe 53
- line-level sources, connecting 60
- Link indicator 54
- Link Timeline and Edit Selection option 78
- Low Latency Monitoring 86

M

- MacDrive utility (Windows) 16
- Master Faders 34, 74, 75, 95, 96
- memory locations 78
 - defining 78
 - recalling 79
 - using for zoom control 81
- Meter ruler 70
- Mic/Line high-pass filter 84
- microphone 51

- microphones, connecting 60
- MIDI
 - connections 65
 - editing 90
 - importing 82
 - requirements 3
 - setup (Macintosh) 119
 - setup (Windows) 115
- MIDI controls 74, 76, 77
 - MIDI Input selector 86
 - MIDI Output selector 87
 - MIDI Velocity meter 88
 - Patch Select button 87
- MIDI devices, connecting 65
- MIDI Studio Setup (MSS) (Windows) 115
- MIDI tracks 74, 76
 - recording with footswitch 89
- mix automation 97
- Mix window 68, 93
- mixdown 97
 - and bit resolution 98
 - and sample rate conversion 98
- mixdown and connecting a recorder 64
- mixing 93
- modes
 - Counter mode 43
 - Display mode 42
 - Flip mode 34
 - Pro Tools mode 29
 - Stand-alone mode 29
 - Standby 29
 - Status Mode 42
- modifier keys 41
 - Command 41
 - Control 41
 - Option 41
 - Shift 41
- monitor controls
 - level 41, 47
 - Mono switch 41, 47
 - mute 41, 47
- monitoring latency 85
- Mute button 93
- Mute switch 32

N

- navigation controls 38
- network connections 128

O

- operating levels 49
- outputs
 - ADAT Optical 104
 - analog 52
 - digital 52, 104
 - in Stand-alone mode 100, 102
 - S/PDIF 104

P

- Pan slider 93
- Pan/Send controls 37
 - in Channel View 37
- Pencil tool 90
- phantom power 51
- playback 74
 - MIDI 88
- Playback Engine dialog 73
- playlists 91
- plug-ins 37, 96
 - AudioSuite 96
 - in Channel View 37
 - inserting on tracks 96
 - RTAS (Real-Time AudioSuite) 96
- power amp and speakers, connecting 58
- power management settings
 - Macintosh 18
 - Windows 8, 9
- Pro Tools LE
 - authorizing 23
 - capabilities 3
 - demo session 16, 20
 - installing (Macintosh) 20
 - installing (Windows) 14
 - main windows 68
 - removing 16, 22
- Pro Tools mode 29
- Program Change dialog 118, 122
- punch-in recording with footswitch 89

Q

- QuickPunch recording 89
- QuickTime
 - installing (Windows) 14

R

- Record Ready switch 33
- recording
 - audio 84
 - audio tracks with QuickPunch 89
 - from ADAT tracks 85
 - MIDI 86, 88
 - MIDI tracks with footswitch 89
 - monitoring latency 85
 - to ADAT tracks 85
- Region List 77
- regions 77
 - arranging 92
 - creating 77
 - editing 91
 - grouping 93
 - trimming 91
- removing Pro Tools LE 16, 22
- returns 95
- Reverb 113
- rotary encoders 33
- RTAS Processors setting 24
- rulers 70
 - Conductor 70
 - Meter 70
 - Tempo 70
 - Timebase 70

S

- Sample Rate 26, 49
 - in Stand-alone mode 100
- screen savers 128
- scribble strip 33
- Scrubber tool 90
- Selector tool 90
- sends 75, 94, 101
 - assigning 94
 - in Stand-alone mode 100, 112
- sends to external effects devices 62

- sessions 67
 - creating 67
 - duplicating 72
 - navigating 78
 - saving 67, 72
 - saving copies of 72
- Shuffle mode 90
- Slip mode 90
- Smart Tool 90
- snapshots 114
 - recalling 114
 - storing 114
- Solo button 93
- solo safe 106
 - disabling 106
- Solo switch 32
- speakers, connecting 58
- Spot mode 90
- Stand-alone mode 29, 99
 - entering 102
- Standby mode 29
- submixing 94
- system optimization
 - Macintosh 18, 19
 - Windows 8, 9, 10
- system requirements 3
- system settings 73
 - Clock Source 26
 - CPU Usage Limit 25
 - DAE Playback Buffer Size 25
 - Hardware Buffer Size 24
 - I/O Setup 27
 - RTAS Processors 24
 - Sample Rate 26
- System Usage window 73

T

- tempo 70, 71
- Tempo Change dialog 70
- Tempo ruler 70
- Timebase ruler 70
- track height 79

- tracks 74
 - audio 74, 75
 - Auxiliary Inputs 74, 75, 94
 - creating 74
 - Instrument 74
 - Master Faders 74, 75, 95
 - MIDI 74, 76
 - playing back audio 84
 - playing back MIDI 88
 - recording audio 84
 - recording MIDI 86, 88
 - types 74
- Transport
 - MIDI controls 74
- transport controls 38
- Transport window 69, 73, 74
- Trimmer tool 90

V

- views
 - Channel View 31, 36, 43, 108
 - Console View 31, 35, 42, 105
 - Home View 31, 104
 - Master Fader View 105
- Volume fader 93

W

- WaveDriver (Windows) 15
- windows 68
 - Edit window 68
 - Mix window 68, 93
 - Transport window 69, 73, 74
- Word Clock 103

Z

- zoom controls 39
- Zoom Presets 81
- Zoom Toggle 80
- Zoomer tool 90
- Zooming 79



www.digidesign.com

DIGIDESIGN

2001 Junipero Serra Boulevard
Daly City, CA 94014-3886 USA
Tel: 650.731.6300
Fax: 650.731.6399

TECHNICAL SUPPORT (USA)

Tel: 650.731.6100
Fax: 650.731.6384

PRODUCT INFORMATION (USA)

Tel: 650.731.6102
Fax: 800.333.2137

INTERNATIONAL OFFICES

Visit our Digidesign Web site
for contact information