

**SONY®**

PROFESSIONAL DISC FIELD STATION

# PDW-HR1

**XDCAM™**

**MPEG HD422**



**CINEALTA**

OPERATION MANUAL

English

1st Edition (Revised 2)

## Important Safety Instructions

- Read these instructions.
- Keep these instructions.
- Heed all warnings.
- Follow all instructions.
- Do not use this apparatus near water.
- Clean only with dry cloth.
- Do not block any ventilation openings.
- Install in accordance with the manufacturer's instructions.
- Do not install near any heat sources such as radiators, heat registers, stoves, or other apparatus (including amplifiers) that produce heat.
- Do not defeat the safety purpose of the polarized or grounding-type plug. A polarized plug has two blades with one wider than the other. A grounding-type plug has two blades and a third grounding prong. The wide blade or the third prong are provided for your safety. If the provided plug does not fit into your outlet, consult an electrician for replacement of the obsolete outlet.
- Protect the power cord from being walked on or pinched particularly at plugs, convenience receptacles, and the point where they exit from the apparatus.
- Only use attachments/accessories specified by the manufacturer.
- Use only with the cart, stand, tripod, bracket, or table specified by the manufacturer, or sold with the apparatus. When a cart is used, use caution when moving the cart/apparatus combination to avoid injury from tip-over.



- Unplug this apparatus during lightning storms or when unused for long periods of time.
- Refer all servicing to qualified service personnel. Servicing is required when the apparatus has been damaged in any way, such as power-supply cord or plug is damaged, liquid has been spilled or objects have fallen into the apparatus, the apparatus has been exposed to rain or moisture, does not operate normally, or has been dropped.

## WARNING

**To reduce the risk of fire or electric shock, do not expose this apparatus to rain or moisture.**

**To avoid electrical shock, do not open the cabinet. Refer servicing to qualified personnel only.**

**THIS APPARATUS MUST BE EARTHED.**

### CAUTION

The apparatus shall not be exposed to dripping or splashing. No objects filled with liquids, such as vases, shall be placed on the apparatus.

Do not install the appliance in a confined space, such as book case or built-in cabinet.

The unit is not disconnected from the AC power source (mains) as long as it is connected to the wall outlet, even if the unit itself has been turned off.

This apparatus is provided with a main switch on the rear panel. Install this apparatus so that user can access the main switch easily.

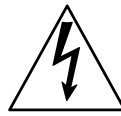
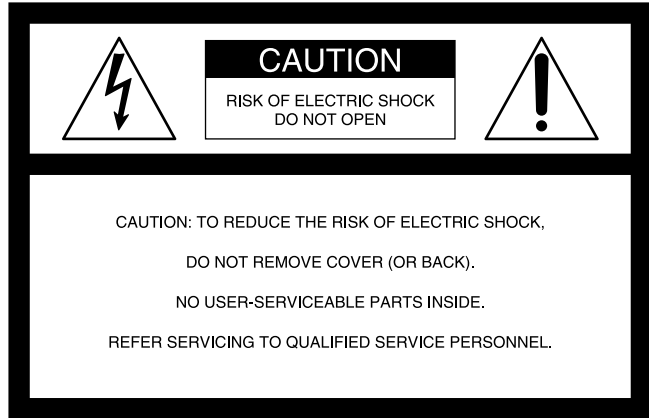

This symbol is intended to alert the user to the presence of uninsulated "dangerous voltage" within the product's enclosure that may be of sufficient magnitude to constitute a risk of electric shock to persons.



This symbol is intended to alert the user to the presence of important operating and maintenance (servicing) instructions in the literature accompanying the appliance.

**WARNING: THIS WARNING IS APPLICABLE FOR USA ONLY.**

If used in USA, use the UL LISTED power cord specified below.  
**DO NOT USE ANY OTHER POWER CORD.**

Plug Cap	Parallel blade with ground pin (NEMA 5-15P Configuration)
Cord Length	Type SJT, three 16 or 18 AWG wires Minimum 1.5 m (4 ft. 11 in.), Less than 2.5 m (8 ft. 3 in.)
Rating	Minimum 10 A, 125 V

Using this unit at a voltage other than 120 V may require the use of a different line cord or attachment plug, or both. To reduce the risk of fire or electric shock, refer servicing to qualified service personnel.

**WARNING: THIS WARNING IS APPLICABLE FOR OTHER COUNTRIES.**

1. Use the approved Power Cord (3-core mains lead)/Appliance Connector/Plug with earthing-contacts that conforms to the safety regulations of each country if applicable.

2. Use the Power Cord (3-core mains lead)/Appliance Connector/Plug conforming to the proper ratings (Voltage, Ampere).

If you have questions on the use of the above Power Cord/ Appliance Connector/Plug, please consult a qualified service personnel.

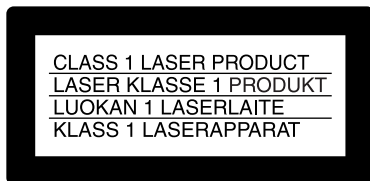

This Professional Disc Field Station is classified as a CLASS 1 LASER PRODUCT.

#### Laser diode properties

Wave length: 400 to 410 nm  
Emission duration: Continuous  
Laser output power: 135 mW (max. of pulse peak), 65 mW (max. of CW)  
Standard: IEC60825-1 (2001)

#### Egenskaber for laserdiod

Bølgelængde: 400 til 410 nm  
Strålingsvarighed: Kontinuerlig  
Afgivet lasereffekt: 135 mW (maks stråletoppunkt), 65 mW (maks ved kontinuerlig stråling)  
Standard: IEC60825-1 (2001)

#### Tekniska data för laserdiod

Våglängd: 400 till 410 nm  
Emissionslängd: Kontinuerlig  
Laserut effekt: 135 mW (max. för pulstopp), 65 mW (max. för kontinuerlig våg)  
Standard: IEC60825-1 (2001)

#### Egenskaper for laserdiod

Bølgelængde: 400 til 410 nm  
Strålingsvarighet: Uavbrutt  
Utgangseffekt for laser: 135 mW (maks av pulshøyde), 65 mW (maks av CW)  
Standard: IEC60825-1 (2001)

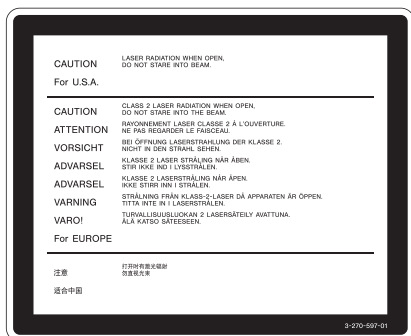

This label is located on the top panel of the drive unit.

Denna etikett finns på ovansidan av driftenheten.

Denne mærkat sidder på drevenhedens øverste panel.

Tämä kyltti sijaitsee ajurilaitteen yläpinnalla.

Dette merket er plassert på oversiden av driverenheten.

#### CAUTION

The use of optical instruments with this product will increase eye hazard.

#### CAUTION

Use of controls or adjustments or performance of procedures other than those specified herein may result in hazardous radiation exposure.

#### WARNING

Excessive sound pressure from earphones and headphones can cause hearing loss.

In order to use this product safely, avoid prolonged listening at excessive sound pressure levels.

#### VAROITUS!

LAITTEEN KÄYTTÄMINEN MUULLA KUIN TÄSSÄ KÄYTTÖOHJEESSA MAINITULLA TAVALLA SAATTAA ALTISTAA KÄYTTÄJÄN TURVALLISUUSLUOKAN 1 YLITTÄVÄLLE NÄKYMÄTTÖMÄLLE LASERSÄTEILYLLE.

#### VARNING

OM APPARATEN ANVÄNDS PÅ ANNAT SÄTT ÄN I DENNA BRUKSANVISNING SPECIFICERATS, KAN ANVÄNDAREN UTSÄTTAS FÖR OSYNLIG LASERSTRÅLNING, SOM ÖVERSKRIDER GRÄNSEN FÖR LASERKLASS 1.

When installing the installation space must be secured in consideration of the ventilation and service operation.

- Do not block the ventilation slots at the right side and bottom of front side panels, and vents of the fans.
- Leave more than 25 cm of space in the rear of the unit.
- Leave more than 2 cm of space in the left side and right side of the unit.

And leave the space that can open and close the display panel in the top of the unit.

#### WARNING

Batteries shall not be exposed to excessive heat such as sunshine, fire or the like.

#### For the customers in the USA

This equipment has been tested and found to comply with the limits for a Class A digital device, pursuant to Part 15 of the FCC Rules. These limits are designed to provide reasonable protection against harmful interference when the equipment is operated in a commercial environment. This equipment generates, uses, and can radiate radio frequency energy and, if not installed and used in accordance with the instruction manual, may cause harmful interference to radio communications. Operation of this equipment in a residential area is likely to cause harmful interference in which case the user will be required to correct the interference at his own expense.

You are cautioned that any changes or modifications not expressly approved in this manual could void your authority to operate this equipment.

All interface cables used to connect peripherals must be shielded in order to comply with the limits for a digital device pursuant to Subpart B of Part 15 of FCC Rules.

This device complies with Part 15 of the FCC Rules. Operation is subject to the following two conditions: (1) this device may not cause harmful interference, and (2) this device must

accept any interference received, including interference that may cause undesired operation.

Lamp in this product contains mercury. Disposal of these materials may be regulated due to environmental considerations. For disposal or recycling information, please contact your local authorities or the Electronic Industries Alliance ([www.eiae.org](http://www.eiae.org)).

**For the customers in Canada**

This Class A digital apparatus complies with Canadian ICES-003.

**For the customers in Europe**

This product with the CE marking complies with both the EMC Directive and the Low Voltage Directive issued by the Commission of the European Community.

Compliance with these directives implies conformity to the following European standards:

- EN60065: Product Safety
- EN55103-1: Electromagnetic Interference (Emission)
- EN55103-2: Electromagnetic Susceptibility (Immunity)

This product is intended for use in the following Electromagnetic Environment(s):

E1 (residential), E2 (commercial and light industrial), E3 (urban outdoors) and E4 (controlled EMC environment, ex. TV studio).

The manufacturer of this product is Sony Corporation, 1-7-1 Konan, Minato-ku, Tokyo, Japan.

The Authorized Representative for EMC and product safety is Sony Deutschland GmbH, Hedelfinger Strasse 61, 70327 Stuttgart, Germany.

**For kundene i Norge**

Dette utstyret kan kobles til et IT-strømfordelingssystem. Apparatet må tilkoples jordet stikkontakt

**För kunderna i Sverige**

Apparaten skall anslutas till jordat uttag

**Suomessa asuville asiakkaille**

Laite on liitettävä suojamaadoituskoskettimilla varustettuun pistorasiaan

**For the Customers in Taiwan only**



廢電池請回收

---

# Table of Contents

---

## Chapter 1 Overview

<b>Features</b> .....	<b>10</b>
Features of this unit .....	10
<b>System Configurations</b> .....	<b>13</b>

---

## Chapter 2 Names and Functions of Parts

<b>Configuration</b> .....	<b>14</b>
<b>Control Panel</b> .....	<b>15</b>
<b>Display Panel</b> .....	<b>23</b>
Display screen.....	24
<b>Connector Panel</b> .....	<b>31</b>

---

## Chapter 3 Preparations

<b>Preparing Power Sources</b> .....	<b>34</b>
Supplying power.....	34
Attaching a battery pack .....	34
<b>Initial Setup</b> .....	<b>35</b>
<b>Connections and Settings</b> .....	<b>37</b>
Connections for using the supplied application software .....	37
Connections for cut editing.....	38
Using in an edit list editing system.....	41
Connections for pool coverage .....	42
<b>Synchronization Reference Signals</b> .....	<b>43</b>
<b>Setting System Frequency</b> .....	<b>44</b>
<b>Setting Timecode</b> .....	<b>44</b>
<b>Superimposed Text Information</b> .....	<b>47</b>
<b>Basic Function Menu Operations</b> .....	<b>49</b>
Function menu operations.....	49
Function menu settings .....	50
<b>Handling Discs</b> .....	<b>53</b>
Discs used for recording and playback .....	53
Notes on handling .....	53
Write-protecting discs.....	54

Loading and unloading a disc .....	54
Formatting a disc .....	54

---

## Chapter 4 Recording and Playback

<b>Recording .....</b>	<b>55</b>
Mixed recording of clips in different formats on the same disc .....	55
Preparations for recording .....	55
Carrying out recording .....	56
Continuing recording while exchanging discs (disc exchange cache function) .....	57
Recording with the HDSDI remote control function .....	57
Recording with the Clip Continuous Rec function .....	58
Handling of discs when recording does not end normally (salvage functions) .....	58
<b>Playback .....</b>	<b>60</b>
Playback operation .....	61
Playback operations using thumbnails .....	63

---

## Chapter 5 Operations in GUI Screens

<b>Overview .....</b>	<b>64</b>
Switching between GUI screens .....	64
Information and controls in thumbnail screens .....	65
Displaying menus .....	68
GUI screen operations .....	71
<b>Thumbnail Operations .....</b>	<b>72</b>
Selecting thumbnails .....	72
Searching with thumbnails .....	73
Playing the scene you have found .....	75
Selecting clips by type (Filter Clips function) .....	75
Selecting the information displayed on thumbnails .....	77
Changing clip index pictures .....	77
Checking clip properties .....	78
Setting clip flags .....	80
Locking (write-protecting) clips .....	81
Deleting clips .....	81
<b>Scene Selection (Clip List Editing) .....</b>	<b>83</b>
What is scene selection? .....	83
Creating and editing clip lists .....	84
Managing clip lists .....	89

<b>Disc Operations .....</b>	<b>90</b>
Checking disc properties.....	90
Using planning metadata .....	91
Checking user-defined essence marks .....	92
Formatting discs.....	92
Displaying disc and clip properties in a web browser .....	93
<b>Transferring clips (Direct FTP function).....</b>	<b>95</b>
Preparations for clip transfers .....	95
Uploading clips.....	96
Downloading clips .....	99
Copying clips directly between XDCAM devices.....	100
<b>Shortcut List .....</b>	<b>101</b>

---

## Chapter 6 Edit List Editing

<b>Overview.....</b>	<b>102</b>
Switching to the editing screens .....	102
Parts of the editing screens .....	104
Displaying the Edit Menu.....	105
Editing screen operations.....	107
<b>Editing Operations .....</b>	<b>108</b>
Editing modes .....	108
Executing edits.....	109
Performing voice-over editing .....	112

---

## Chapter 7 File Operations

<b>Overview.....</b>	<b>116</b>
Directory structure .....	116
File operation restrictions .....	117
Assigning user-defined clip titles .....	120
Assigning user-defined clip and clip list names .....	121
<b>File Operations in File Access Mode (for Windows).....</b>	<b>123</b>
Making FAM connections .....	123
Operating on files .....	124
Exiting file operations.....	124
<b>File Operations in File Access Mode (for Macintosh).....</b>	<b>125</b>
Making FAM connections .....	125
Operating on files .....	125
Exiting file operations.....	126
<b>FTP File Operations.....</b>	<b>126</b>

Making FTP connections.....	126
Command list .....	127
<b>Recording Continuous Timecode with FAM and FTP Connections .....</b>	<b>132</b>

---

## Chapter 8 Menus

<b>Menu System Configuration .....</b>	<b>133</b>
<b>Setup Menu .....</b>	<b>133</b>
Items in the basic menu .....	134
Basic menu operations.....	138
Items in the extended menu .....	140
Extended menu operations .....	155
<b>Maintenance Menu.....</b>	<b>157</b>
Items in the maintenance menu .....	157
Maintenance menu operations .....	161

---

## Chapter 9 Planning Metadata

<b>Overview.....</b>	<b>164</b>
Manipulating planning metadata .....	164
Setting clip names by using planning metadata .....	164
Setting essence mark names by using planning metadata .....	165
Setting volume labels by using planning metadata .....	166

---

## Appendix

<b>Important Notes on Operation.....</b>	<b>167</b>
Condensation .....	167
About the LCD panel .....	167
<b>Periodic Maintenance.....</b>	<b>168</b>
Digital hours meter .....	168
Note about the battery terminal .....	169
<b>Troubleshooting .....</b>	<b>170</b>
Alarms .....	170
Error messages .....	179
To eject discs with the unit powered off .....	180
<b>Specifications .....</b>	<b>180</b>
<b>Using UMID Data.....</b>	<b>184</b>



<b>Ancillary Data</b> .....	<b>186</b>
Ancillary data in HDSDI/SDSDI signals .....	186
Ancillary data in MXF files .....	186
General MXF metadata.....	186
Closed caption data.....	187
<b>List of Supported USB Keyboards</b> .....	<b>189</b>
<b>Trademarks and Licenses</b> .....	<b>192</b>
MPEG-4 visual patent portfolio license .....	192
MPEG-2 video patent portfolio license .....	192
About IJG (Independent JPEG Group).....	192
Character display software “iType”.....	192
<b>Glossary</b> .....	<b>193</b>
<b>Index</b> .....	<b>195</b>

## Features

The PDW-HR1 is a professional disc recorder supporting full HD (1920 × 1080 and 1280 × 720) playback and recording with Professional Disc <sup>1)</sup> media.

When you use this unit in combination with a nonlinear editing system, the FAM <sup>2)</sup> function enables data file transfers between the unit and computers over the i.LINK interface, allowing the unit to be used like an external hard drive. The unit can be used as a player for video editing and program output, and as a recorder for nonlinear editing. For these applications, it can be connected to Sony nonlinear editors, monitors, and video equipment with HDSDI interfaces via its standard HDSDI I/O connectors. It has a compact, lightweight body for easy portability outdoors, making it ideal for field applications and also for desktop viewing by journalists, producers, and other production staff.

1) Professional Disc is a trademark of Sony Corporation.

2) FAM: File access mode

## Features of this unit

The principal features of this unit are as follows.

### MPEG HD422 <sup>1)</sup> codec

#### High-quality video and audio recording and playback

The MPEG HD422 codec provides video compression compliant with the MPEG-2 422P@HL standard. It enables HD 4:2:2 (50 Mbps) digital component file recording in the 1080i (1,080 effective scanning lines, interlaced) or 720P (720 effective scanning lines, progressive) format currently in use by many broadcast facilities.

Uncompressed PCM recording of 24-bit 48 kHz audio enables 8-channel audio recording at high sound quality.

1) MPEG HD422 is a trademark of Sony Corporation.

### Long recording times

PDW-HR1 supports dual-layer Professional Discs (50 GB). When dual-layer Professional Discs are used, this unit can record about 95 minutes.

## Recording and playback functions

### Support for multiple SD and HD codecs

In addition to the MPEG HD422 codec, this unit supports the MPEG HD codec. <sup>1)</sup> It can record HD 4:2:0 digital component files at both 1080i (35/25/18 Mbps<sup>2)</sup>) and 720P (35/25 Mbps), allowing HD operation across a wide range of recording times and application objectives. The unit is also capable of SD (IMX 30/40/50 Mbps or DVCAM codec) recording and playback.

1) MPEG HD is a registered trademark of Sony Corporation.

2) Playback only supported for 18 Mbps.

### Support for multiple frame frequencies

This unit can record and play multiple frame frequencies at both 1080 (59.94i, 50i, 29.97P, 25P, and 23.98P) and 720 (59.94P and 50P) (for MPEG HD422). It can also perform pulldown playback of discs recorded at 23.98P.

### Support for mixed format recording mode

As long as the frame frequency group is the same, clips in different recording formats can be recorded or written to the same disc. <sup>1)</sup>

The system frequencies supported by this unit are divided into frame frequency groups, as shown in the following table.

1) The recording format is regarded as different whenever the system frequency, video resolution, video codec/bit rate, or number of audio channels or number of bits does not match.

Frame frequency group	System frequency
59.94Hz	59.94P
	59.94i
	29.97P

Frame frequency group	System frequency
50Hz	50P
	50i
	25P
23.98Hz	23.98P

You can record clips with different recording formats, for example HD422 and HD420SP clips, by putting this unit into mixed format recording mode.

#### Note

Continuous playback may not be possible at the transition point between two clips with different recording formats.

### SD upconvert function

This unit is provided with an upconvert function, allowing HD recording of SDDSI signals input to the SD/HDDSI INPUT connector and composite signals input to the COMPOSITE IN connector. The unit can also output HD signals while playing discs recorded as SD, allowing SD material to be utilized in an HD environment.

### HD downconvert function

The unit is provided with a downconvert function. HD disc playback signals can be downconverted to SD signals and then output as SDDSI or composite signals. This allows you to use SD nonlinear editors and monitors for editing and program output.

### 1080/720 cross-conversion

This unit supports cross-conversion output. It can output 720 while playing discs recorded as 1080, and output 1080 while playing discs recorded as 720.

### HDDSI remote recording

HDDSI connections can be made to camcorders with remote HDDSI support (PDW-F800/700 XDCAM HD422 camcorder, HDW-730/730S/750/790/F900R HDCAM<sup>1)</sup> camcorders) to enable recording synchronized to REC and STOP operations on the camcorder.

1) HDCAM is a trademark of Sony Corporation.

### Clip Continuous Rec function

Normally, a clip is generated as an independent file every time recording starts and stops. The Clip Continuous Rec function allows you to continue recording to the same clip until the function is stopped or turned off, regardless of how many times recording starts and stops. This is convenient if you want to avoid generating a large number of short clips, or if you want to record without worrying about the limit on the number of clips (maximum 300).

### Recording of proxy AV data

Proxy AV data is a low-resolution (1.5 Mbps video, 64 kbps per audio channel), MPEG-4 based version of a full resolution data stream. Whenever this unit records full resolution MPEG HD422 data, it simultaneously generates

and records low-resolution proxy AV data. Because of its small size, proxy AV data can be transferred quickly over computer networks, easily edited in the field with laptop computers, and readily used in a wide variety of applications, such as content management on small-scale servers.

### High-speed searches with the shuttle/jog dial

The shuttle/jog dial can be used to find scenes inside clips, in the same way as the shuttle and jog dials on conventional VTRs.

In jog and variable modes, you can search in field units at from -1 to +1 times normal speed. Shuttle mode supports high-speed searches up to a maximum of  $\pm 20$  times normal speed.

### Convenient disc-based playback and searching

Like previous products in the XDCAM series, this unit supports a number of convenient search functions, including scene selection, thumbnail searches, essence marks searches, and expand searches.

**Scene selection:** This function allows you to select clips from the disc and insert them into playlists. Clips can be inserted and played back in any order.

**Thumbnail searches:** The unit creates thumbnails from the first frame of each generated clip, and displays them in thumbnail lists on the color LCD or an external monitor. You can cue up clips very easily by simply by selecting them from thumbnail lists.

**Essence mark searches:** Essence marks can be recorded at any scene during or after recording. Lists of these marks can be displayed on the color LCD or an external monitor, allowing you to quickly find scenes that were marked for later reference.

**Expand searches:** This function allows you to look inside the clip selected in a thumbnail screen, or inside the segment from a selected essence mark to the next essence mark. The selection range is divided into 12 equal blocks, and the first frames of those blocks are displayed as thumbnails. By checking the thumbnails, you can easily find the scene you want.

## Usability features

### AC, DC, and battery power support

The unit can be used even where AC power is not available, for example outdoors or in cars or helicopters.

### Color LCD display

The unit is equipped with a 16:9, 9-inch widescreen color LCD which allows you to check the contents of the disc and use the menu system without connecting an external monitor.

### Waveform monitor and vectorscope

You can display a basic waveform monitor or a basic vectorscope.

### Video monitor display mode

You can set a video output to display on the video monitor to either HD or SD.

### Built-in stereo speakers

The unit features built-in speakers, allowing you to check recorded audio. You can check your clips and editing results on the color LCD and speakers even when no monitors or separate speakers are available.

### Compact size, lightweight and battery-powered operation

The PDW-HR1 is small and light enough to carry out into the field. It can be operated with batteries, allowing you to start work immediately in the field.

### Cache recording for seamless disc exchanges

About 30 seconds (this duration may differ depending on the state of a disc) of video and audio data can be recorded to the unit's internal memory cache during a disc exchange, and then written back to the newly loaded disc. This allows seamless recording across extended recording sessions, including recording of video feeds, with no important scenes lost while discs are being exchanged.

## IT friendly

### Computer access to files (file access mode)

Video and audio clip data are recorded as files. The FAM function enables quick random access by computers to the video, audio, and metadata files stored on Professional Discs, with the ability to display thumbnail lists on the computer screen and perform file-based reads and writes.

### Equipped with network connector

The unit features a Gigabit Ethernet connector as standard equipment. Via this connector, you can connect the unit to computers and networks to enable listing of the video, audio, and metadata files recorded on the Professional Disc, and rapid file transfers. Support for FTP commands makes it easy to carry out network file transfers from remote locations.

### Direct FTP function

You can use this unit as a local FTP host to send and receive MXF files to and from other XDCAM devices or a server, without using a computer. This function is available through simple operations on the GUI screen.

### User data recording mode

User data (files other than XDCAM AV files) can be recorded on Professional Discs as PC data via the i.LINK or FTP interface. This allows Professional Discs to be used as data recording media, with a data storage capacity of 46.4 GB (when dual-layer PFD50DLA discs are used).

### Supports a variety of interfaces

This unit supports the following interfaces.

- HDSDI video, 8-channel audio input and output

- SDSDI video, 8-channel audio input and output (the SD/HDSI INPUT connector doubles as an SDSDI input connector)
- SD composite input and output
- Analog audio 4-channel input and output
- Remote
  - RS-422A (D-sub 9-pin × 1)
 Video process control is available from the control panel.
- i.LINK TS (HDV) input and output (when the PDBK-202 option board is installed)
- DVB-ASI TS input and output (when the PDBK-202 option board is installed)
- HDMI output

# System Configurations

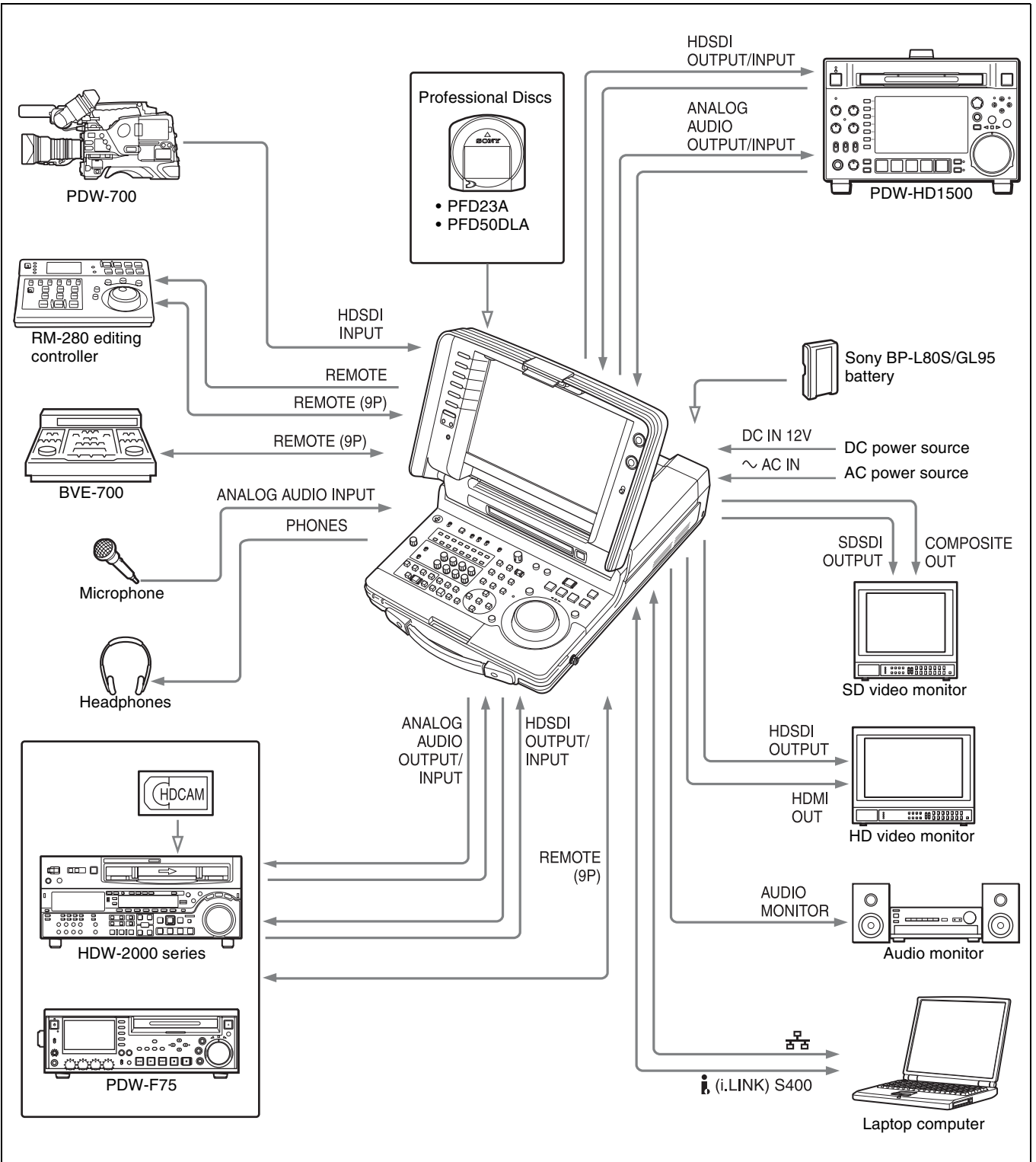

# Names and Functions of Parts

# Chapter 2

## Configuration

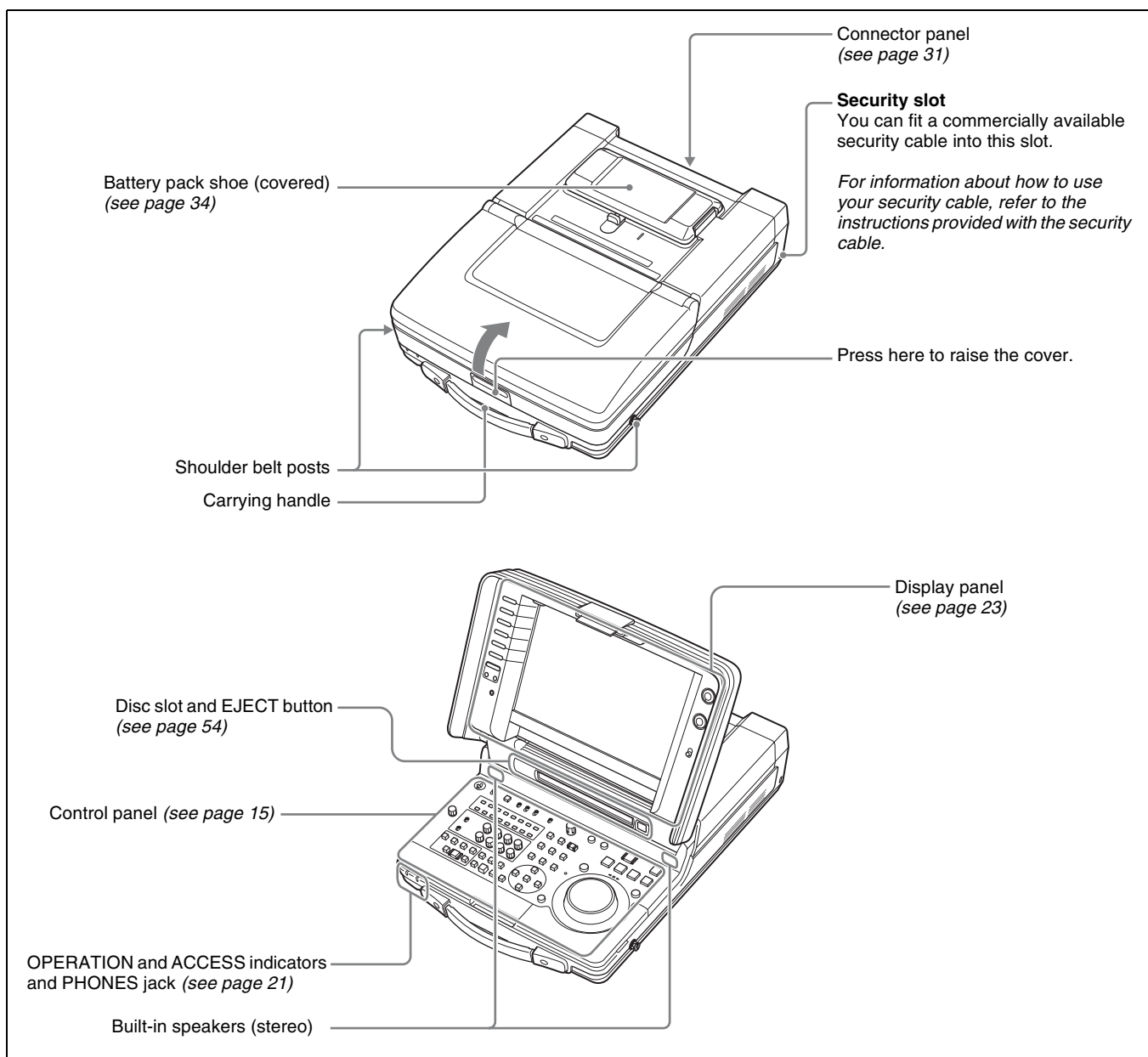

# Control Panel

The names and symbols of buttons and knobs on the control panel are color coded according to function.

**White:** Function when the button or knob is operated independently.

**Orange:** Function when the button is operated with the SHIFT button held down.

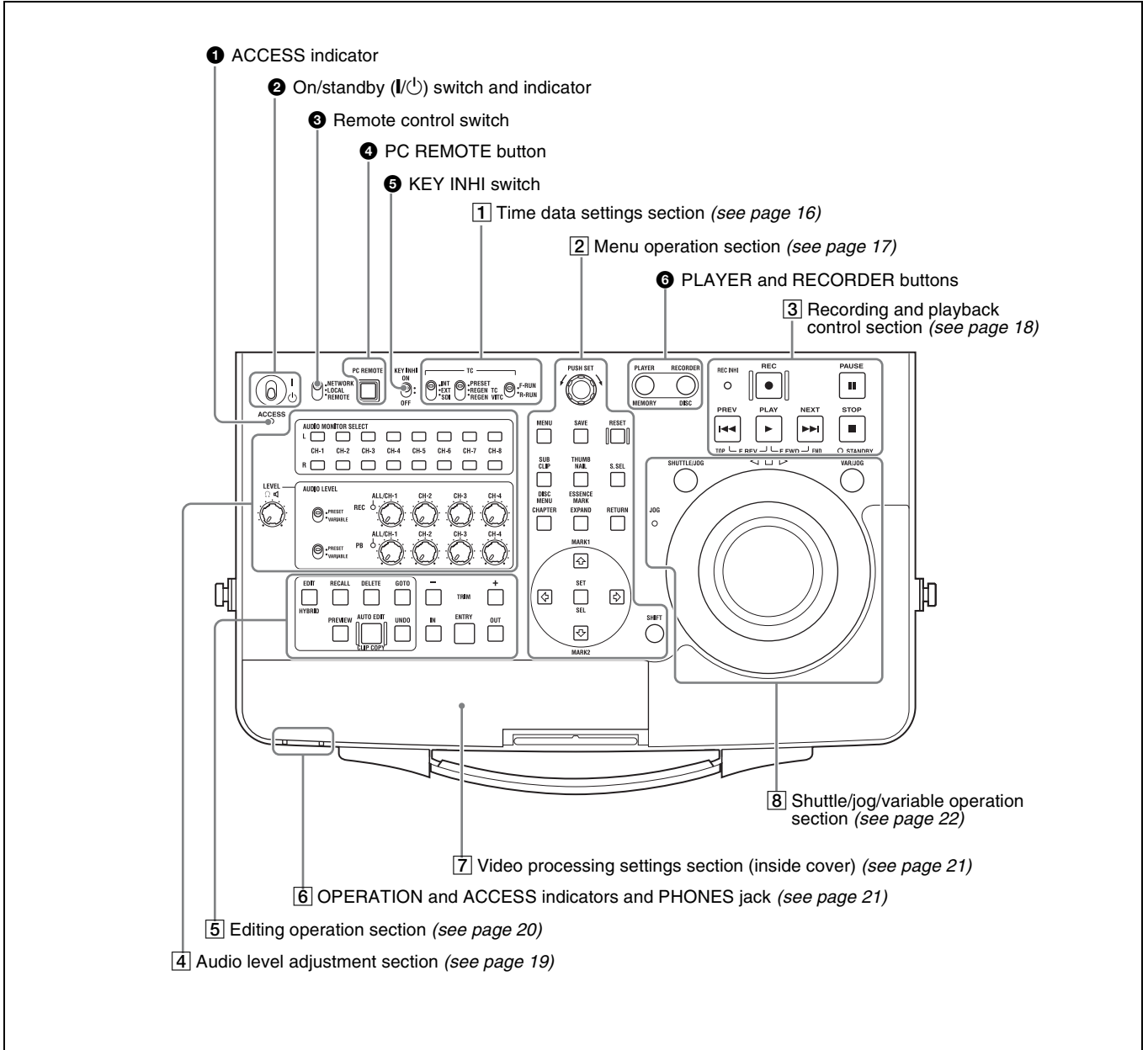

## 1 ACCESS indicator

This lights when the disc is accessed and when a file is opened by a FAM or FTP connection (see page 116). If the on/standby switch is set to the  position while this indicator is lit, access to the disc is completed before the unit switches to the standby state.

## Note

While the ACCESS indicator is lit, do not turn off the POWER switch on the connector panel or disconnect the power cord. This could lead to a loss of data from the disc.

## 2 On/standby (I/⏻) switch and indicator

When the POWER switch on the connector panel is set to the I position, and when DC power is connected to the DC IN 12V connector on the connector panel, this switches the unit between the operating state (the switch is in the I position and the indicator is lit green) and the standby state (the switch is in the ⏻ position). When the switch is moved to the I position, the indicator lights. When the switch is moved to the ⏻ position, the indicator goes off. When using this unit, normally leave the connector panel POWER switch in the I (on) position, and switch the unit between the operating and standby states using the on/standby switch.

## 3 Remote control switch

Different positions of the switch allow different operations as follows.

**NETWORK:** Enables access to the network. The indicator lights when an external network device is being accessed. In this state, operation from the control panel is not possible.

**LOCAL:** Enables operation from the control panel.

**REMOTE:** Enables remote control of this unit from the following devices:

- Devices connected to the REMOTE(9P) connector
- Devices connected to the SD/HDSDI INPUT connector with SDI remote control functions
- Devices connected to the i.LINK HDV TS connector<sup>1)</sup>

Use setup menu item 214 REMOTE INTERFACE to select which of the connectors is used for remote control (see page 143).

1) When the PDBK-202 option board is installed.

See “Setup Menu” on page 133 for more information about how to make extended menu settings.

## 4 PC REMOTE button

When you have connected this unit to a computer with a FAM or FTP connection, this button allows you to log in to and log off from the computer with the cable still connected.

**Lit:** Access possible (factory default setting)

**Off:** Access not possible

## 5 KEY INHI switch

This turns key operation inhibit mode on or off.

Use setup menu item 118 KEY INHIBIT to specify the keys to inhibit.

## 6 PLAYER and RECORDER buttons

Select use of this unit as a player or recorder when you are editing edit lists (see page 102).

## 1 Time data settings section

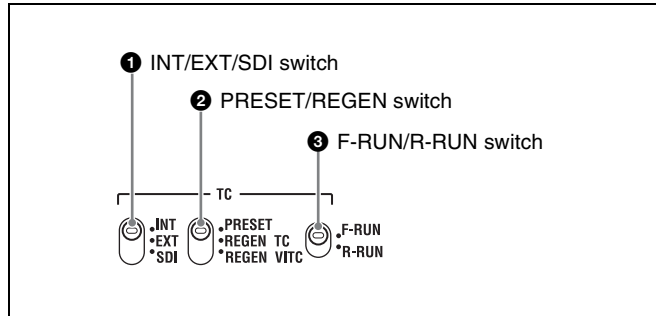

### 1 INT/EXT/SDI (internal/external/SDI) switch

Selects the timecode to which the internal timecode generator synchronizes.

**INT:** Synchronize to a value that was preset by an operation on the control panel or remotely from a device connected to the REMOTE(9P) connector, or synchronize to the playback timecode.

**EXT:** Synchronize to the timecode input to the TIME CODE IN connector.

**SDI:** Synchronize to the timecode input to timecode embedded in HDSDI signals input to the SD/HDSDI INPUT connector.

### Note

If you select “EXT” or “SDI” when i.LINK TS/DVB-ASI TS signals are being input, the internal timecode generator synchronizes to the timecode in the TS signals.

### 2 PRESET/REGEN (regenerate) switch

Selects one of the following regeneration modes for the internal timecode generator.

**PRESET:** Preset the initial value of the timecode generated by the internal timecode generator, as specified by a control panel operation or by remote control from a device connected to the REMOTE(9P) connector. This setting is enabled when “INT” is selected with the INT/EXT/SDI switch. When the switch is set to something else, the behavior is as if REGEN TC was selected.

**REGEN TC:** Synchronize to and regenerate the TC timecode read by the internal timecode reader.

**REGEN VITC:** Synchronize to and regenerate the VITC timecode read by the internal timecode reader.

### 3 F-RUN/R-RUN (free run/REC run) switch

Selects the timecode advance mode.

**F-RUN:** Timecode advances continuously as long as the unit is powered on, regardless of the unit’s operating mode.

**R-RUN:** Timecode advances while the unit is recording. When you select this mode, set the INT/EXT/SDI switch to “INT”, and set the PRESET/REGEN switch to “PRESET”.



For details, see “Setting Timecode” (page 44).

## 2 Menu operation section

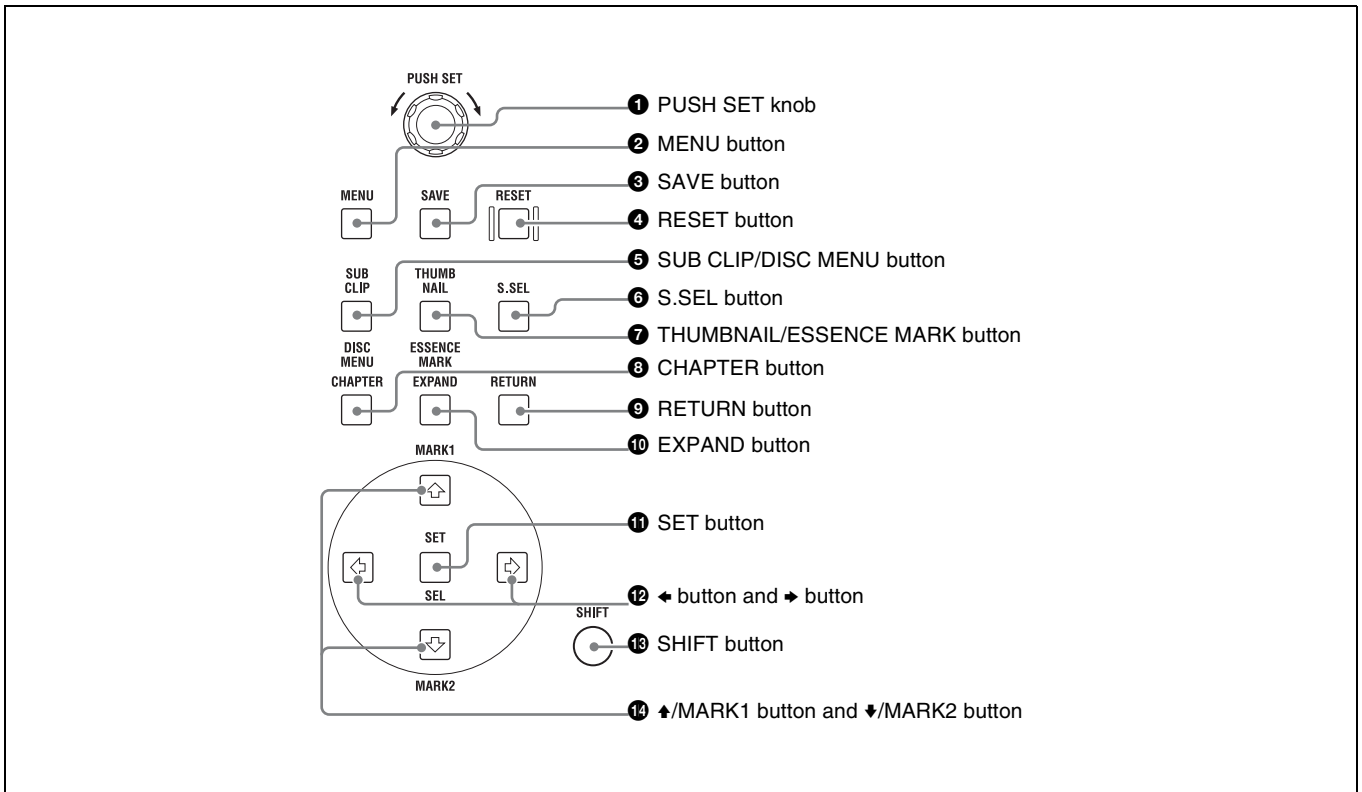

### 1 PUSH SET knob

Use this for menu settings and thumbnail operations in the GUI screens. Rotate the knob to select an item, and press the knob to confirm the selection. This knob is also used to select values for timecode and other numbers.

See “GUI screen operations” (page 71) for more information about operations in the GUI screens.

### 2 MENU button

Starts the setup menu and the menus in GUI screens. The settings of the setup menu appear if this button is pressed when no GUI screen is displayed. The same information also appears in an external monitor connected to this unit. The unit returns to the original display when this button is pressed again.

See “GUI screen operations” (page 71) for more information about operations in the GUI screens.

### 3 SAVE button

Saves function button setting in this unit’s internal memory.

### 4 RESET button

Resets counters and numeric values, such as settings for the timecode generator. This button is also used to cancel

setup menu settings and to stop scene selection and thumbnail searches.

### 5 SUB CLIP/DISC MENU button

When pressed alone, function as the SUB CLIP button. When pressed together with the SHIFT button, functions as the DISC MENU button.

**SUB CLIP button:** Press this button, turning it on, to start playback according to a clip list (see page 64). Press it again, turning it off, to stop playback. Jog and shuttle operations are possible during clip list playback. When you want to play clips in the order that they were recorded, press this button to turn it off.

**DISC MENU button:** When pressed together with the SHIFT button in a GUI screen, displays the Disc Menu (see page 90). The button lights when pressed. Press it again to turn it off and hide the Disc Menu.

See “GUI screen operations” (page 71) for more information about operations in the GUI screens.

### 6 S.SEL (scene selection) button

Confirms settings made by a scene search or scene selection operation, or cancels the operation.

### 7 THUMBNAIL/ESSENCE MARK button

When pressed alone, displays thumbnails of the index pictures of clips and sub clips. Press this button, turning it

on, when you want to perform a thumbnail search or create a clip list from a GUI screen. Press it again, turning it off, to return to full-screen display.

When pressed together with the SHIFT button, displays essence mark frames (frames where essence marks have been set). The essence mark selection menu appears. Select the desired essence mark to display frames where that essence mark has been set. Press the button again to turn it off and return to full-screen display.

See “GUI screen operations” (page 71) for more information about operations in the GUI screens.

### 8 CHAPTER button

When pressed in a thumbnail screen, displays a list of frames where essence marks are recorded (chapter function). When pressed again, returns to normal thumbnail display. Instead of index pictures, this function displays thumbnails of the frames where essence marks are set, allowing you to gain a quick overview of the clip. This is also convenient for cuing up long clips.

See page 74 for more information about the chapter function.

### 9 RETURN button

In setup menu and GUI screen operations, returns to the previous step of a setting or procedure.

### 10 EXPAND button

When pressed in a thumbnail screen, divides the selected clip into 12 blocks and displays a list of thumbnails of the first frame in each block (expand function). The division is repeated with each press (up to 3 times, for a total of 1,728 blocks).

When this button is pressed together with the SHIFT button, the unit returns to the previous division level. Press the RESET button to return to the thumbnail screen.

See page 73 for more information about the expand function.

### 11 SET button

When pressed in a setup menu or GUI screen operation, confirms the current settings.

### 12 ◀ button and ▶ button

When the THUMBNAIL/ESSENCE MARK button is lit, you can use these buttons to select clips.

### 13 SHIFT button

Switches between functions for any button with two functions.

### 14 ▲/MARK1 button and ▼/MARK2 button

When the THUMBNAIL/ESSENCE MARK button is lit, you can use these buttons to select thumbnails.

During recording or playback, a shot mark 1 or shot mark 2 essence mark is recorded when you press the PUSH SET knob or the SET button with the ▲/MARK1 or ▼/MARK2 button held down.

Essence marks can also be deleted and modified from the Thumbnail Menu of the chapter thumbnail screen (see page 67).

## 3 Recording and playback control section

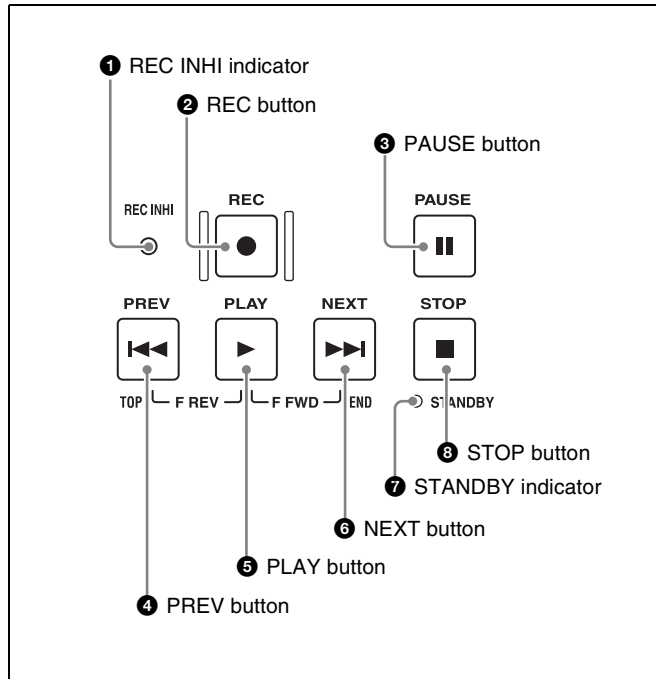

### 1 REC INHI (recording inhibit) indicator

This lights in the following cases.

- When a disc with recording inhibited is loaded.
- When REC INH on the HOME page of the function menu is set to “ON”.
- The format of the recorded part of the disc does not match the system frequency settings of the unit.

### 2 REC (record) button

To start recording, hold down this button, and press the PLAY button. The recording takes place on an unrecorded part of the disc.

To stop recording, press the STOP button.

### To monitor in E-E mode

You can press this button from stop mode to monitor input signals in E-E mode. The button lights when pressed. Press the STOP button to return to the original video.

You can also press this button during playback and searches. E-E mode playback continues for as long as the button is held down.

### 3 PAUSE button

Press this button, turning it on, to pause recording or playback.

Press it again to resume recording or playback.

#### 4 PREV (previous) button

Press this button, turning it on, to show the first frame of the current clip. While the first frame of a clip is shown, pressing this button jumps to the beginning of the previous clip. This button is also used together with other buttons for the following operations.

**Reverse direction high-speed search:** Hold down the PLAY button, and press this button. A high-speed search in the reverse direction is carried out.

**Displaying the first frame of the first clip:** Hold down the SHIFT button, and press this button.

#### 5 PLAY button

Press this button, turning it on, to start playback. When pressed during recording, this button stops recording and selects stop mode. If you do not want to stop recording when this button is pressed, set setup menu item 145 MODE KEY ENABLE DURING RECORDING to “stop & pause”.

#### 6 NEXT button

Press this button, turning it on, to jump to the next clip, and show the first frame. This button is also used together with other buttons for the following operations.

**Forward direction high-speed search:** Hold down the PLAY button, and press this button. A high-speed search in the forward direction is carried out.

**Displaying the last frame of the last clip:** Hold down the SHIFT button, and press this button.

#### 7 STANDBY indicator

Lights when the unit is in standby mode (STOP button and, STANDBY indicator lit).

After a certain time passes in a disc stop mode, the unit automatically enters standby off mode and the indicator goes off.

*You can specify the time until the unit enters standby off mode. For details, see the description of setup menu item 501 STILL TIMER (page 145).*

#### 8 STOP button

Press this button, turning it on, to stop recording or playback. The frame at the stop point appears. The unit enters standby off mode when you press this button with the SHIFT button held down. It returns from standby off mode to the original state when you press this button again with the SHIFT button held down. (The lit or unlit status of the STOP button does not change.)

#### Note

This button flashes when setup menu item 105 REFERENCE SYSTEM ALARM is set to “on” and the correct reference video input signal (as specified by OUT

REF on page P1 VIDEO of the function menu) is not being input.

*This unit can automatically enter standby off mode whenever a specified time elapses in disc stop mode. For details, see the description of setup menu item 501 STILL TIMER (page 145).*

## 4 Audio level adjustment section

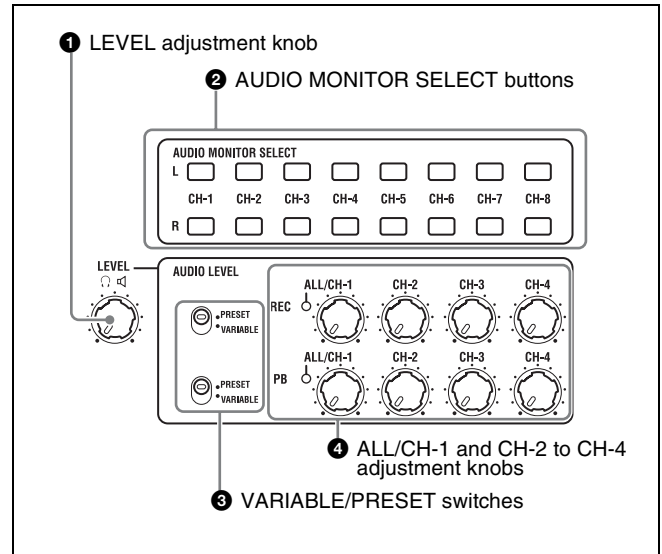

#### 1 LEVEL (volume) adjustment knob

Adjusts the volume of headphones or speakers. You can also cause this to simultaneously adjust the output volume from the ANALOG AUDIO OUTPUT 3 and 4 (MONITOR R and L) connectors on the connector panel. To do this, set setup menu item 114 AUDIO MONITOR OUTPUT LEVEL to “var”.

#### 2 AUDIO MONITOR SELECT (audio monitor channel selection) buttons

The upper (L) and lower (R) rows each contain buttons for channels 1 to 8 (CH1 to CH8). Press the buttons to select the audio channels to output. The audio is output from the PHONES jack on the control panel, from the speakers, and from the ANALOG AUDIO OUTPUT 3 and 4 (MONITOR R and L) connectors on the connector panel. By pressing multiple buttons in the L and R rows, you can monitor the mixed audio of the selected channels. (To cancel a channel selection, press the button for that channel again.)

#### 3 VARIABLE/PRESET switches

These switches select the settings that determine audio levels for recording (upper switch) and playback (lower switch).

**VARIABLE:** Settings made with the ALL/CH-1 and CH-2 to CH-4 adjustment knobs.

**PRESET:** Fixed as preset values.

#### 4 ALL/CH-1 and CH-2 to CH-4 adjustment knobs

These knobs adjust the audio levels of channels 1 to 4 (CH-1 to CH-4). The knobs in the upper row adjust recording levels, and the knobs in the lower row adjust playback levels. These settings are enabled when the corresponding VARIABLE/PRESET switch is set to VARIABLE.

You can use the function menu to adjust channels 5 to 8. For details, see page 52.

Setup menu item 131 AUDIO VOLUME allows you to enable simultaneous adjustment of all eight channels with the ALL/CH-1 knob. The ALL indicator lights when simultaneous adjustment is enabled.

### 5 Editing operation section

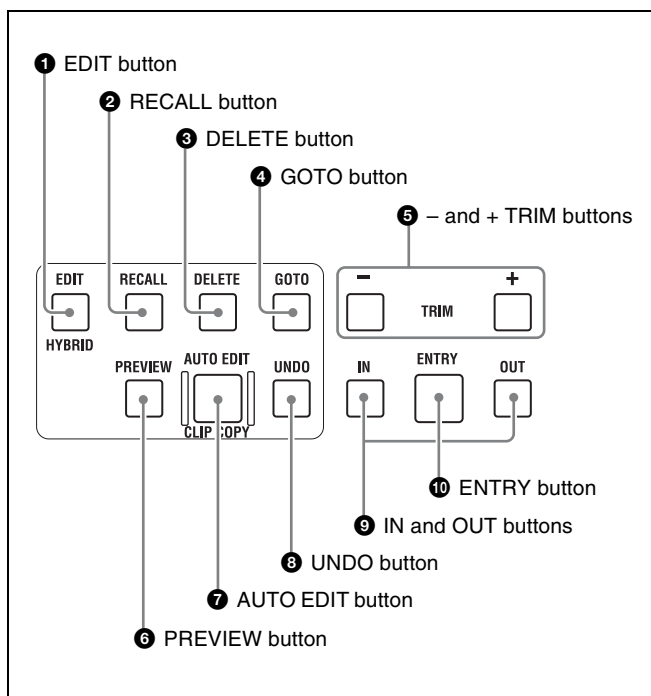

#### 1 EDIT button

Switches to the edit list editing screen (see page 102).

#### Note

The scene selection function is disabled in the edit list editing screens.

#### 2 RECALL button

When pressed together with the IN button or the OUT button after deleting the In or Out point of a clip or sub clip, recalls the In or Out point.

When pressed in the EDIT LIST screen, switches to the Clip List (Trim) screen, so that you can trim the positions of In and Out points (see page 111).

#### 3 DELETE button

Deletes an In or Out point in a clip or sub clip. Delete the point (if it exists) by holding down the IN or OUT button and pressing this button.

#### 4 GOTO button

Jumps to an In or Out point in a clip or sub clip. Jump to the point (if it exists) by holding down the IN or OUT button and pressing this button.

#### 5 - and + TRIM buttons

Trim an In or Out point in a clip or sub clip. Trim the point (if it exists) by holding down the IN or OUT button and pressing the [-] or [+] button. The In or Out point moves one frame forward or back.

When an edit list editing screen is displayed, the + TRIM and - TRIM buttons enlarge or reduce the time scale of the timeline. When a sub clip is selected in an edit list editing screen, these buttons function as trim buttons for audio split editing (see page 114) if you press them while holding down the GOTO button.

#### Note

Audio split editing function is enabled when the PDBZ-UPG03 Software Upgrade Key or PDBK-MK1 option board is installed.

#### 6 PREVIEW button

Flashes when preview is possible.

The editing screen switches to full-screen mode and one of the following sections are played back, depending on the screen that was displayed when you pressed the button.

**RECORDER mode screen:** The editing section, including preroll and postroll sections.

**PLAYER mode screen:** The editing section only.

#### Note

When PLAYER SEL in the Edit Menu is set to “external” and EDIT MODE is set to “insert”, the postroll section is not played, even if you press the button in RECORDER mode.

#### 7 AUTO EDIT button

Flashes when auto editing is possible.

Updates an edit list by adding material in the specified editing mode at the location specified by an edit point. When two edit points or less have been set, the editing screen changes into full-screen playback of a section until the edit section is confirmed, including the preroll and postroll sections.

#### Note

The preroll and postroll sections are not played when PLAYER SEL in the Edit Menu is set to “external”.

**8 UNDO button**

Undoes the immediately preceding operation.

**9 IN (set IN point) and OUT (set OUT point) buttons**

This buttons light when an In or Out point is set.

When either button is pressed alone, the timecode of the In or Out point appears. (“--:--:--:--” appears if the corresponding point has not been set.)

The IN and OUT buttons are used with the following buttons to execute the indicated functions.

Button	Function
ENTRY	Set In and Out points
-/+ TRIM	Trim In and Out points
DELETE	Delete In and Out points
RECALL	Recall deleted In and Out points
GOTO	Go to In and Out points

**10 ENTRY button**

When pressed with the IN or OUT button held down, sets an In or Out point at the current location in a clip or sub clip.

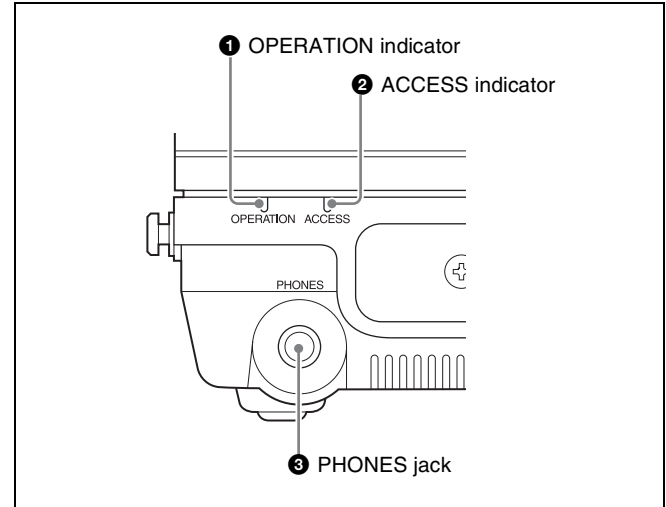
**6 OPERATION and ACCESS indicators and PHONES jack****1 OPERATION indicator**

Lights in green when this unit is operating.  
Lights in red when this unit is recording.

**2 ACCESS indicator**

Has the same function as the ACCESS indicator on the control panel (*see page 15*).

**3 PHONES jack**

Stereo jack for connection of stereo headphones for monitoring of audio during recording, playback, and editing. (Non-audio signals are muted.) Select the channels to monitor with the AUDIO MONITOR SELECT buttons.

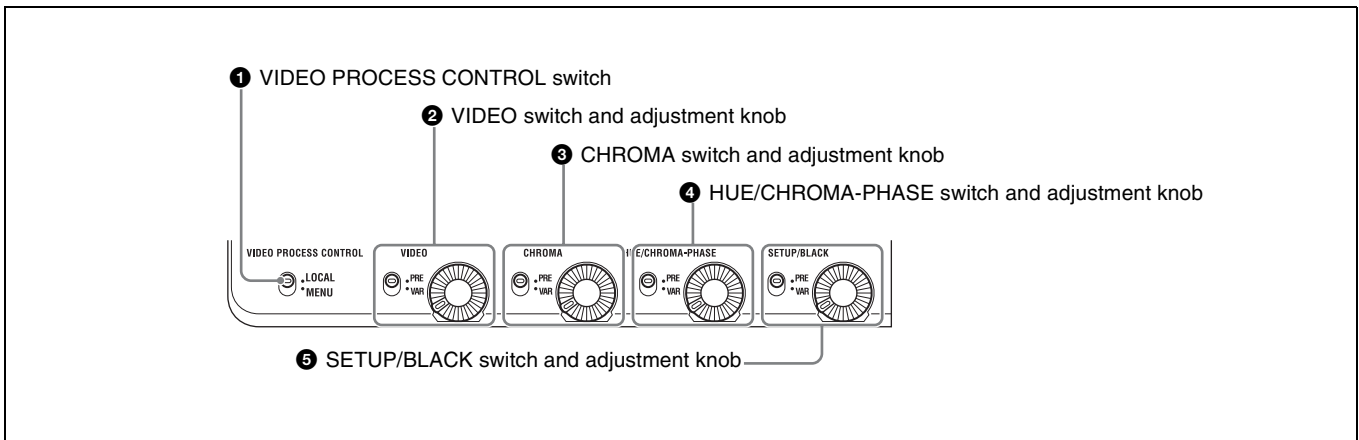
**7 Video processing settings section****1 VIDEO PROCESS CONTROL switch**

Selects the settings that control the unit’s internal digital video processor.

**LOCAL:** Settings made with the unit’s VIDEO, CHROMA, HUE/CHROMA-PHASE, and SETUP/BLACK switches and adjustment knobs.

**MENU:** Settings made with the setup menu.

**2 VIDEO switch and adjustment knob**

Set the video signal output levels for HD and SD output.  
**PRE:** Regardless of manual settings, set the video signal output levels to the standard levels.

**VAR:** Adjust the video signal output levels within the range  $-\infty$  to +3 dB by turning the adjustment knob.

**③ CHROMA switch and adjustment knob**

Set the chroma signal output levels for HD and SD output.

**PRE:** Regardless of manual settings, set the chroma signal output levels to the standard levels.

**VAR:** Adjust the chroma signal output levels within the range  $-\infty$  to +3 dB by turning the adjustment knob.

**④ HUE/CHROMA-PHASE switch and adjustment knob**

Set the chroma phase.

**PRE:** Regardless of manual settings, set the chroma phase to the standard value.

**VAR:** Adjust the chroma phase within the range  $\pm 30^\circ$  by turning the adjustment knob.

**⑤ SETUP/BLACK switch and adjustment knob**

Set the setup and black levels for HD and SD output.

**PRE:** Regardless of manual settings, set the setup and black levels to the standard levels.

**VAR:** Adjust the setup and black levels within the following ranges by turning the adjustment knob.

- Setup level (59.94i/59.94P/29.97P mode):  $\pm 30$  IRE
- Black level (50i/50P/25P mode):  $\pm 210$  mV

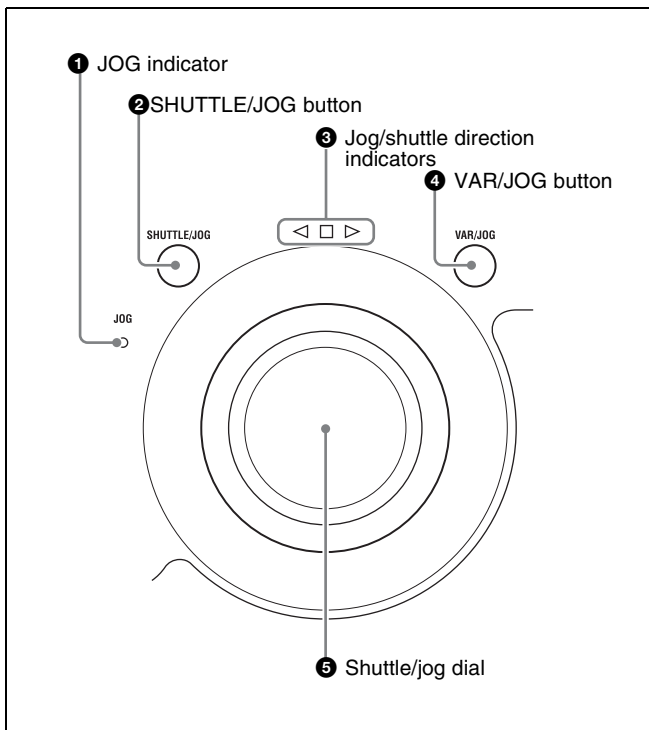
**⑧ Shuttle/jog/variable operation section****① JOG indicator**

Lights in green when the shuttle/jog dial is in jog mode.

**② SHUTTLE/JOG button**

Press this button, turning it on, to perform shuttle or jog playback with the shuttle/jog dial.

When pressed during recording, this button stops recording and selects shuttle/jog mode. If you do not want

recording to stop when this button is pressed, set setup menu item 145 MODE KEY ENABLE DURING RECORDING to “stop & pause”.

**③ Jog/shuttle direction indicators**

These show the playback direction in jog, shuttle, or variable speed mode.

◀ (green): Lights during playback in the reverse direction.

▶ (green): Lights during playback in the forward direction.

■ (red): Lights during still image display.

**④ VAR/JOG button**

Press this button, turning it on, to perform variable or jog playback with the shuttle/jog dial. When pressed during recording, this button stops recording and selects variable/jog mode.

If you do not want recording to stop when this button is pressed, set setup menu item 145 MODE KEY ENABLE DURING RECORDING to “stop & pause”.

**⑤ Shuttle/jog dial**

The dial switches between shuttle/variable mode and jog mode each time that you press it all the way in.

**Shuttle/variable mode:** The dial is in the raised position.

**Jog mode:** The dial is in the depressed position (the JOG indicator is lit).

Turn the dial to the right to play in the forward direction, and turn it to the left to play in the reverse direction.

- In jog mode, the playback speed varies from  $-1$  to  $+1$  times normal speed, according to the rotation speed of the dial. There are no detents.
- In shuttle mode, the playback speed varies in the range  $\pm 20$  times normal speed, according to the angular position of the dial. There is a detent at the center position, for still image playback.
- In variable mode, you can make fine adjustments to the playback speed over the range from  $-1$  to  $+1$  times normal speed, according to the angular position of the dial. There is a detent at the center position, for still image playback.

Regardless of the playback mode, you will normally press the SHUTTLE/JOG or VAR/JOG button before turning the dial. But it is also possible to put the unit into shuttle, jog, or variable mode simply by turning the dial (by setting setup menu item 101 SELECTION FOR SEARCH DIAL ENABLE to “dial”.)

**Note**

If you do set the above item to “dial”, then you should return the shuttle/jog dial to the center position after conducting shuttle or variable playback. If you do not return the dial to the center position, playback in shuttle or variable mode can start because of vibrations during other operations.

# Display Panel

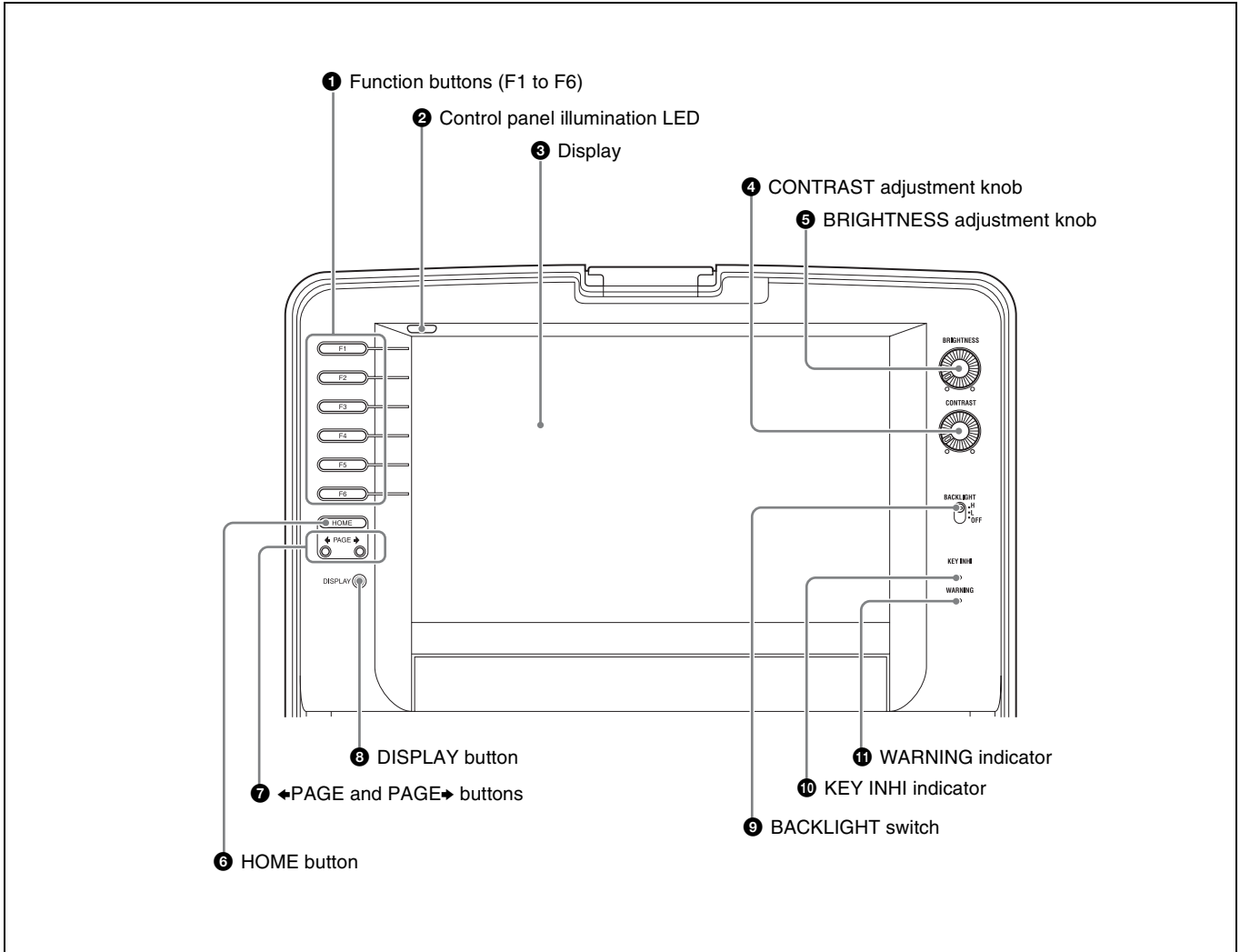

## 1 Function buttons (F1 to F6)

When these buttons are pressed with the function menu (see page 49) shown in the display, the display changes with each press to the menu items corresponding to the button position.

## 2 Control panel illumination LED

Illuminates the control panel. The LED can be turned on and off with the LIGHT item on page P4 OTHER of the function menu.

## 3 Display

Displays menus, audio level meters, timecode, clip information, and other data. You can use the DISPLAY button to switch the display between the basic operating screen and the video monitor.

For details, see “Display screen” (page 24).

## 4 CONTRAST adjustment knob

Adjusts the contrast of the video monitor.

## 5 BRIGHTNESS adjustment knob

Adjusts the brightness of the video monitor.

## 6 HOME button

When pressed with the function menu displayed, returns to the HOME page of the function menu.

## 7 ◀PAGE and PAGE▶ buttons

Display the function menu, if it is not already displayed. (The most recently displayed page of the function menu appears.)

If the function menu is already displayed, the ◀PAGE button switches to the previous page, and the PAGE▶ button switches to the next page.

## 9 BACKLIGHT switch

BACKLIGHT  
ON OFF

KEY INHI

WARNING

CONTRAST

BRIGHTNESS

11 WARNING indicator

10 KEY INHI indicator

8 DISPLAY button

7 ◀PAGE and PAGE▶ buttons

6 HOME button

**8 DISPLAY button**

With each press, switches the display between the basic operating screen and the video monitor.

**9 BACKLIGHT switch**

Selects the brightness of the display backlight.

**H:** High

**L:** Low

**OFF:** Off (nothing displayed)

**10 KEY INHI (inhibit key operations) indicator**

Lights when the KEY INHI switch is on and either the AUDIO/F-KEY item or the CONTROL PANEL item under setup menu item 118 KEY INHIBIT is set to “dis”.

**11 WARNING indicator**

Lights when the unit detects a hardware error such as condensation inside the unit or a laser diode error. Goes out when the error condition is corrected. When this indicator lights, an error message appears in the time data display area.

For details, see “Alarms” (page 170) and “Error messages” (page 179).

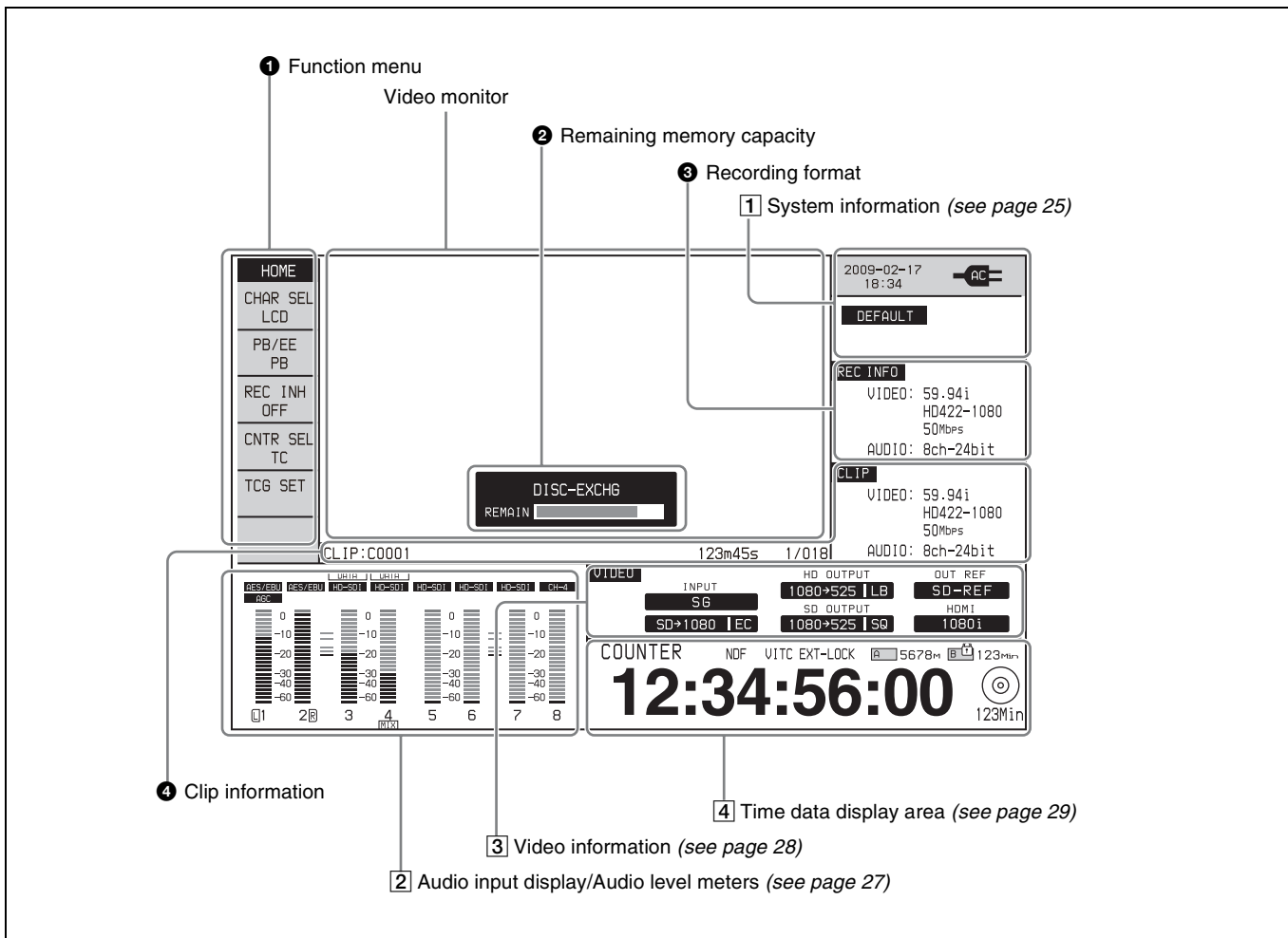
**Display screen****Basic operation display****1 Function menu**

Use the ◀PAGE, PAGE▶, and HOME buttons to display this menu and to switch between the pages (HOME, P1 to P4). Each page has items corresponding to the function

buttons. To change a setting, press the function button in that position.

For details, see “Basic Function Menu Operations” (page 49).



## 2 Remaining memory capacity

This is a popup window that displays the remaining capacity of the unit's internal memory. The popup window appears only when the disc exchange cache function is enabled and a disc is being exchanged.

## 3 Recording format

Displays the system frequency at the time of recording, the video format, and the audio format.

When "CLIP CONTINUOUS" (Clip Continuous Rec function) sub-item on setup menu item 150 is set to "on", the "CONT" display flashes, and changes to lit during recording.

See page 58 for more information about the Clip Continuous Rec function.

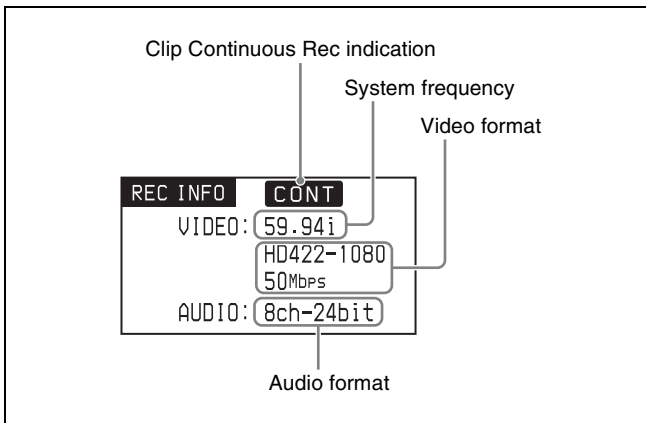

## 4 Clip information

Displays the following information about clips.

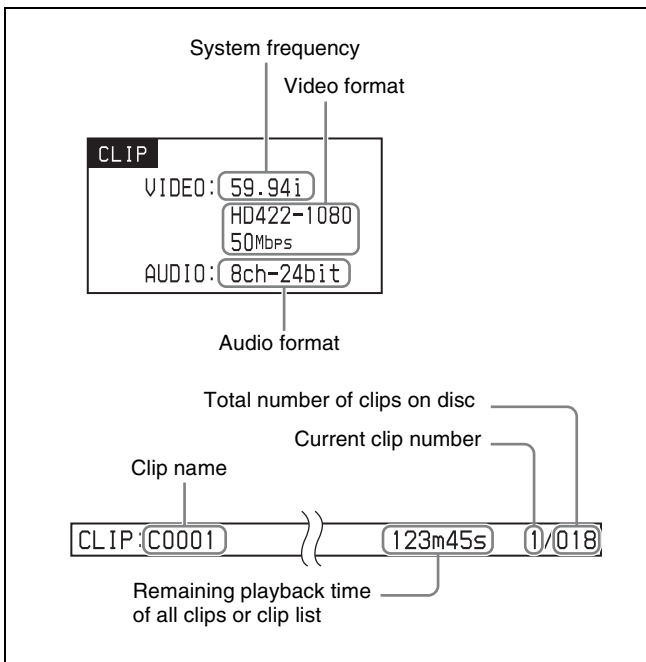

Clip names are displayed according to the setting of Settings > Display Title in the Disc Menu (see page 70).

The following characters can be displayed as clip names in this area.

- Digits: 0 to 9
- Alphabetic characters: a to z, A to Z
- The following symbols: !, ", #, \$, %, &, ', (, ), \*, +, , (comma), -, . (period), /, : (colon), ; (semicolon), <, =, >, ?, @, [, ], ^, \_, {, |, }, ~
- Space

## 1 System information

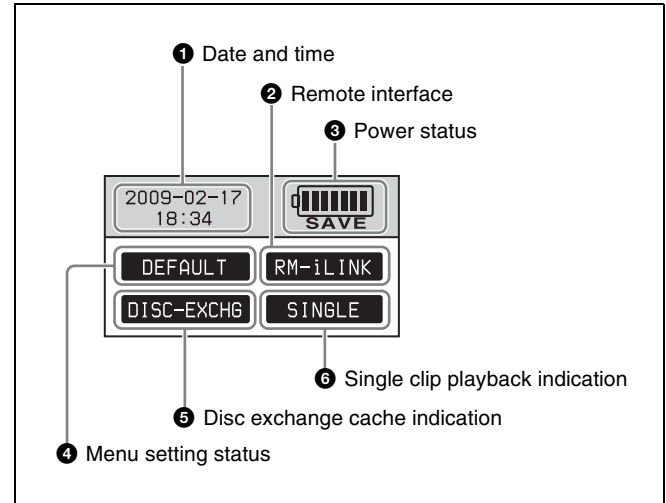

### 1 Date and time

Displays the current date and time.

### 2 Remote interface

When the remote control switch is set to "REMOTE", displays the name of the interface selected with setup menu item 214 REMOTE INTERFACE.

### 3 Power status

Displays the status of power supply to the unit.

Display	Power status	Notes
	AC power	–
	AC power (power saving mode)	–
	DC power	<ul style="list-style-type: none"> <li>• Remaining capacity expressed by length of bar</li> <li>• Flashing (1 Hz): Almost exhausted</li> <li>• Flashing (4 Hz): Exhausted</li> </ul>
	DC power (power saving mode)	
	Battery	
	Battery (power saving mode)	

### 4 Menu setting status

Displays the current setting status of setup menu.

Display	Description
BANK1	The current menu settings are the same as the settings in menu bank 1.

Display	Description
BANK2	The current menu settings are the same as the settings in menu bank 2.
BANK3	The current menu settings are the same as the settings in menu bank 3.
DEFAULT	The current menu settings are the same as the factory defaults.
No display	The current menu settings are different from all of the above.

### 5 Disc exchange cache indication

This appears when “DISC EXCHANGE” (disc exchange cache function) sub-item on setup menu item 150 is set to “on”.

*See page 57 for more information about the disc exchange cache function.*

### 6 Single clip playback indication

This appears when setup menu item 154 SINGLE CLIP PLAY MODE (single clip playback mode) is set to “on”.

*See page 60 for more information about the single clip playback mode.*

## 2 Audio input display/Audio level meters

Displays information about audio. There are two display modes for the audio level meter: FULL mode and FINE mode

mode, which can be switched over using AU METER on page P2 AUDIO of the function menu.

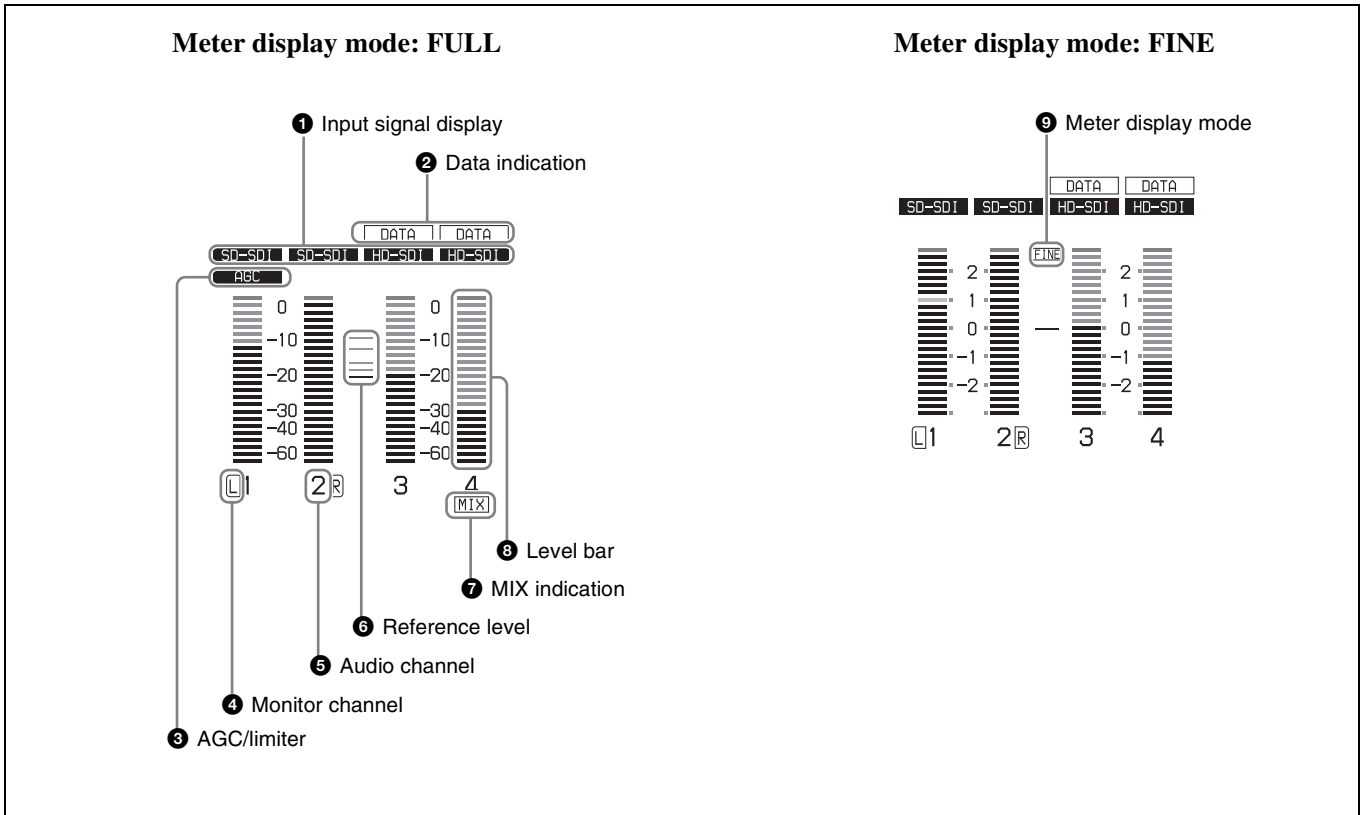

### 1 Input signal display

Displays the audio input signal.

Display	Input signal	
ANA-1	Analog audio signal	Channel 1
ANA-2		Channel 2
ANA-3		Channel 3
ANA-4		Channel 4
MIC-1	Input signal from the microphone connected to ANALOG AUDIO INPUT connector	Channel 1
MIC-2		Channel 2
MIC-3		Channel 3
MIC-4		Channel 4
HD-SDI	HDSDI audio signal (flashes when there is no input signal)	
SD-SDI	SDSDI audio signal (flashes when there is no input signal)	
SG	Test signal from the internal signal generator	
iLINK <sup>a)</sup>	i.LINK TS (HDV) audio signal	
DVB-ASI <sup>a)</sup>	DVB-ASI TS audio signal	
No indication	Undefined audio signal, or no audio input	

a) When the PDBK-202 option board is installed

### 2 Data indication

Appears when the input signals are non-audio signals.

### 3 AGC/limiter

When analog signals are selected for audio input, displays the AGC or limiter status.

**AGC:** An AGC value has been selected.

**LIMIT:** A limiter value has been selected.

### 4 Monitor channel

Displays the audio monitoring channels set with the AUDIO MONITOR SELECT buttons (see page 19).

### 5 Audio channel

Displays the audio channels.

### 6 Reference level

Displays the reference level for recording as set in the maintenance menu.

### 7 MIX (mixing)<sup>1)</sup>

Appears when a channel has been specified as an output destination. This indication appears when mixing has been set up with item 843 AUDIO OUTPUT ARRANGE<sup>1)</sup> in the setup menu, and MIX/SWAP<sup>1)</sup> on the P2 AUDIO page of the function menu has been set to "ON".

1) The indication and the menu items appear only when the PDBZ-UPG03 Software Upgrade Key or the PDBK-MK1 option board has been installed.

### 8 Level bars

Display the audio recording or playback levels of channels 1 to 8. The OVER indicators light when the audio level exceeds 0 dB.

### 9 Meter display mode

Displays the audio level meter display mode selected with AU METER on page P2 AUDIO of the function menu (*see page 52*).

### 3 Video information

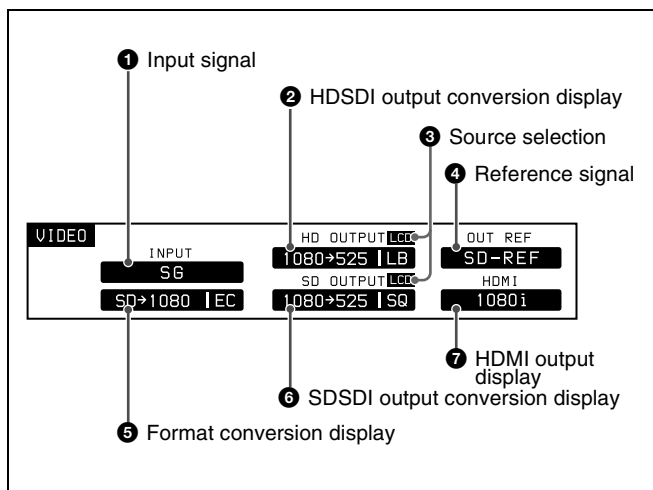

#### 1 Input signal

Displays the currently selected video input signal.

**HD-SDI:** HDSDI video signal

**SD-SDI:** SDDSII video signal

**COMPOSITE:** Composite video signal (when setup menu item 308 is set to “STD”)

**COMPOSITE(NSTD):** Composite video signal (when setup menu item 308 is set to “N-STD”)

**i.LINK:** i.LINK TS (HDV) signal <sup>1)</sup>

**DVB-ASI:** DVB-ASI TS signal <sup>1)</sup>

**SG:** Test video signal generated by the internal signal generator

1)When the PDBK-202 option board is installed

#### Note

The display flashes when there is no video input signal, and when the video input signal does not match the system frequency of this unit.

Select the video input signal with V INPUT on page P1 VIDEO of the function menu (*see page 50*).

#### 2 HDSDI output conversion display

When an upconverted or cross converted signal is being supplied to the HDSDI OUTPUT 1 and 2 (SUPER)

connectors, displays the formats before and after conversion and the conversion mode.

**SQ:** Squeeze mode

**EC:** Edge-crop mode

**LB:** Letter box mode

#### 3 Source selection

The video monitor displays the video output that is selected with the “SOURCE” sub-item of LCD MODE on the P1 VIDEO page of the function menu. “LCD” appears here in the display area of the selected output.

#### 4 Reference signal

Displays the reference signal to which this unit is synchronized.

**INPUT:** Input video signal

**HD-REF:** HD format reference signal

**SD-REF:** SD format reference signal

**No display:** Internal reference signal

#### Note

The HD-REF or SD-REF display flashes if the video input signal is not synchronized with the reference signal, or if the signals are synchronized but out of phase.

#### 5 Format conversion display

When up-conversion or down-conversion is being performed before recording, displays the formats before and after conversion and the conversion mode.

**SQ:** Squeeze mode

**EC:** Edge-crop mode

**LB:** Letter box mode

#### 6 SDDSII output conversion display

When a downconverted signal is being supplied to the SDDSII OUTPUT connector, displays the formats before and after conversion and the conversion mode.

**SQ:** Squeeze mode

**EC:** Edge-crop mode

**LB:** Letter box mode

#### 7 HDMI output display

Displays the signal output to the HDMI OUT connector.

**1080i:** 1080/59.94i or 1080/50i signal

**720P:** 720/59.94P or 720/50P signal

**480i:** 480/59.94i signal

**576i:** 576/50i signal

**480P:** 480/59.94P signal

**576P:** 576/50P signal

#### 4 Time data display area

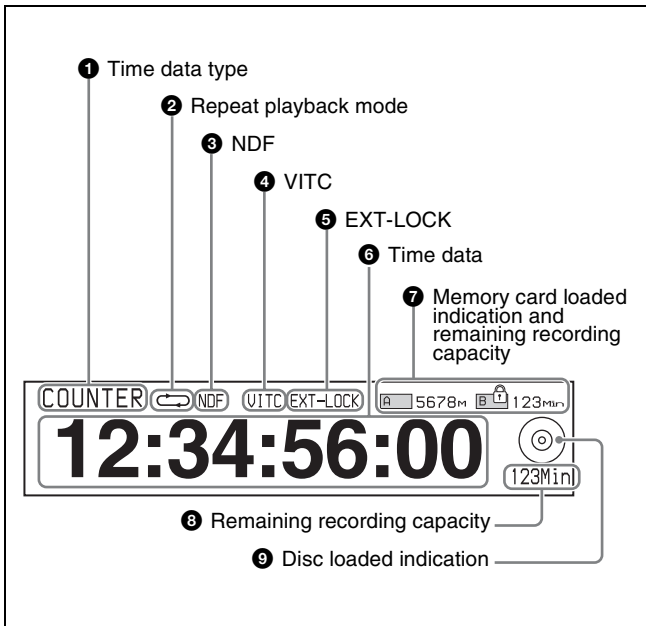

##### 1 Time data type

Displays the type of time data shown in the time data display area. The type of time data is selected with CNTR SEL on the HOME page of the function menu (see page 50).

Display	Type of time data
TC	Timecode
COUNTER	Elapsed recording/playback time
UB	User bits
VITC	VITC
VIUB	VIUB
TCG	Timecode generator value
UBG	User bits generator value

##### 2 Repeat playback mode

This appears when setup menu item 142 REPEAT MODE is set to “play”.

##### 3 NDF

Lights when the displayed timecode is NDF (non-drop-frame) timecode.

##### 4 VITC

Lights in the following cases.

- When VITC is being read in playback mode. (This has no relation to the display in the time data display area.)
- When VITC recording is possible.

##### 5 EXT-LOCK

Lights when the timecode of the timecode generator is synchronized with external timecode.

##### 6 Time data

Normally displays timecode or VITC, according to the selection made with TCR on page P3 TC of the function menu.

##### 7 Memory card loaded indication and remaining recording capacity

A memory card loaded indication and a remaining recording capacity indication appear when the PDBK-MK1 option board is installed in this unit and a memory card is loaded in one of the memory card slots (A/B).

Display	Card state
A / B	The memory card is writable.
A / B	The memory card is write protected.

##### 8 Remaining recording capacity

Displays the remaining recording capacity on the disc. This indication flashes at a rate of 1 Hz when the remaining capacity falls below two minutes, and flashes at a rate of 4 Hz when the disc is full.

##### 9 Disc loaded indication

A disc loaded indication appears when a disc is loaded in this unit.

The background color of the disc loaded indication indicates the status of the disc, as follows.

- Black:** Recording and playback possible
- Yellow:** Playback only possible
- Red:** Recording and playback not possible

##### Note

Even when the background color is black, recording is not possible in the following cases.

- The loaded disc is recording inhibited.
- REC INH in the HOME page of the function menu is set to “ON”.

# Video monitor display

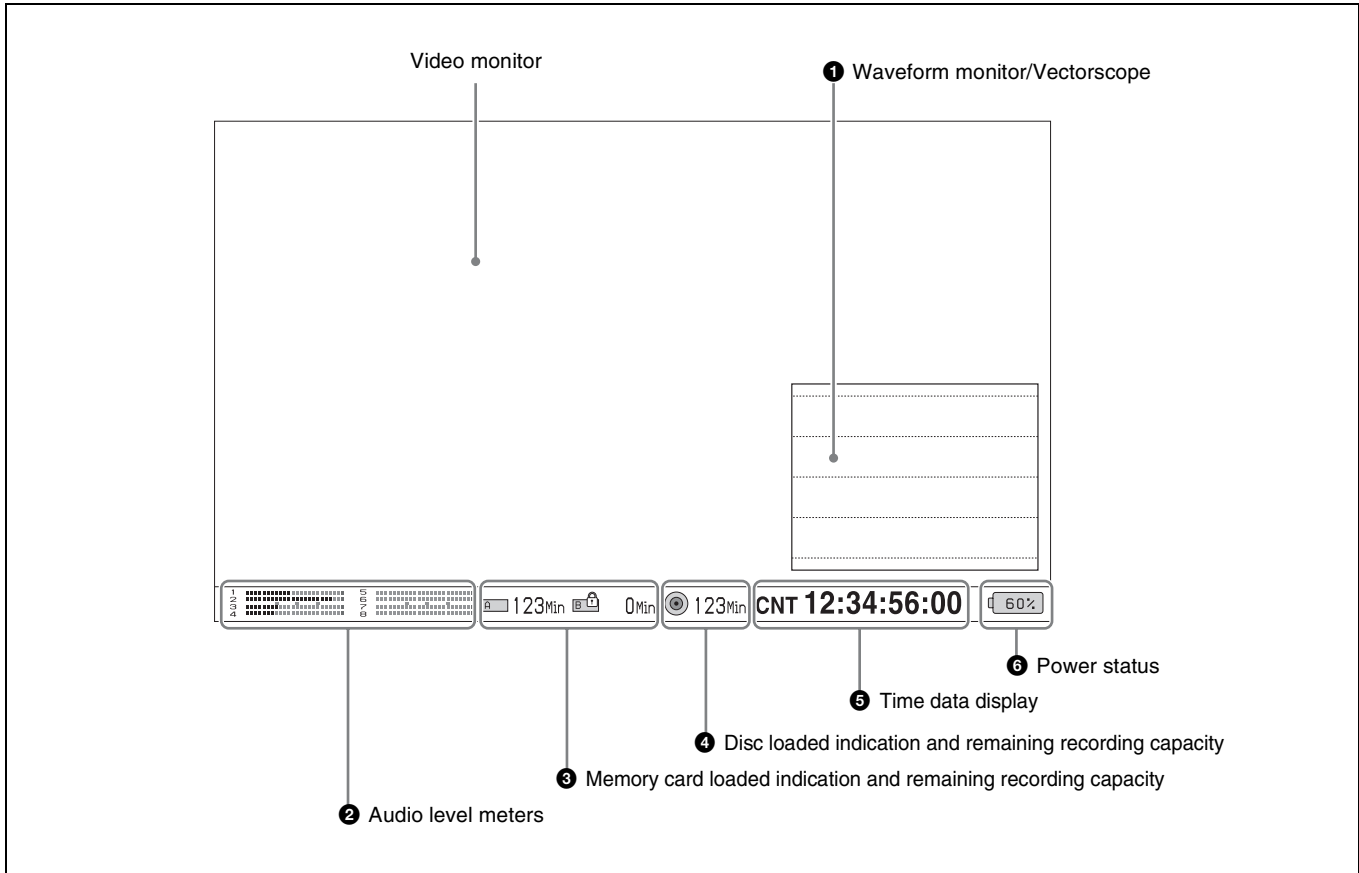

## 1 Waveform monitor/Vectorscope

You can display a basic waveform monitor or a basic vectorscope by switching the setting of the “MODE” subitem of WFM in the P1 VIDEO page of the function menu (see page 50).

You can use the waveform monitor or vectorscope to check video signal characteristics, or to display color bars and then adjust video process settings (video signal output levels, chroma signal output levels, hue) (see page 21).

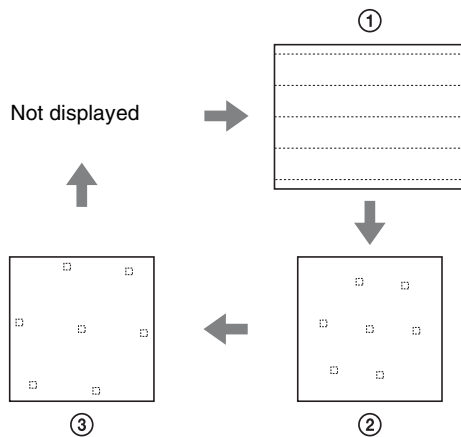

- ① Waveform monitor
- ② 75% color bar signal vectorscope
- ③ 100% color bar signal vectorscope

## 2 Audio level meters

Displays basic audio level meters.

## 3 Memory card indication mark and remaining recording capacity

Indicate whether a memory card is loaded, and the remaining recording capacity (see page 29).

## 4 Disc loaded indication and remaining recording capacity

A disc loaded indication and a remaining recording capacity appear when a disc is loaded in this unit.

## 5 Time data display

Displays the time data (see page 29).

## 6 Power status

Displays the status of power supply to the unit (see page 25).

# Connector Panel

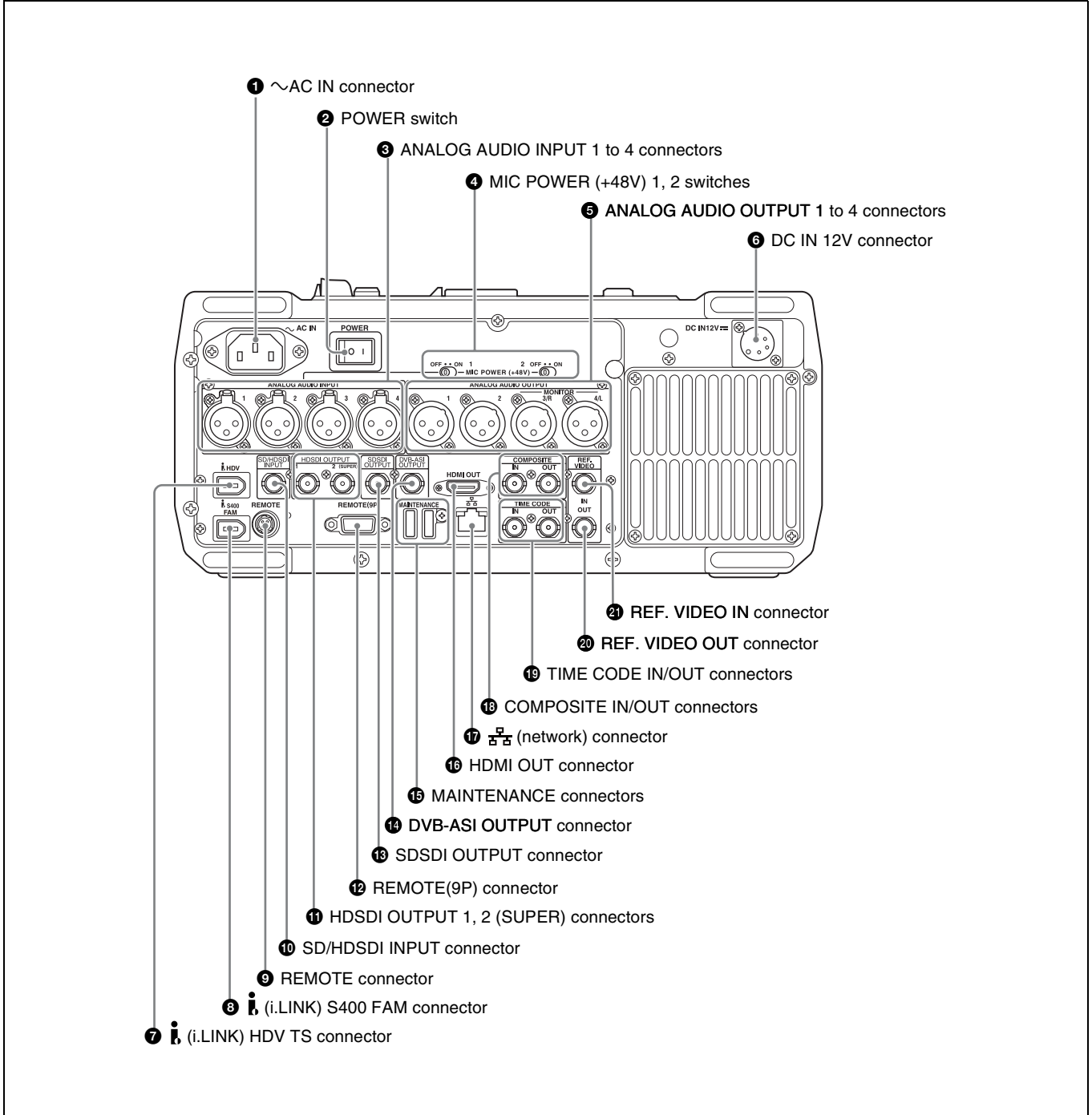

## 1 ~AC IN connector

Connect to an AC power supply with the specified power cord (not supplied) (see page 182).

## 2 POWER (main power) switch

Press the **I** side to power on the unit. Press the **O** side to power off.

When using the unit, normally leave the POWER switch in the **I** (on) position, and use the on/standby (**I/O**) switch on the control panel to switch the unit between the operating state and standby state.

**Note**

Before turning the main power off, always check to make sure that the indicator of the on/standby (I/O) switch on the control panel is not lit, and then press the main power switch to the O side.

**3 ANALOG AUDIO INPUT 1 to 4 connectors (XLR 3-pin, female)**

These input analog audio signals.

You can set the reference input level with the maintenance menu item M37: AUDIO CONFIG (see page 158). (Factory default setting: +4 dB)

**Microphone settings**

If you have connected a microphone to this unit, you can set input level, AGC, and limiter values for the microphone with setup menu items 834, 839, 840, and 841 (see page 152).

**Note**

An unpleasant sound may be output if you have connected a microphone to the ANALOG AUDIO INPUT 1 to 4 connector and power the microphone on with the input level too high. Check the input level setting before connecting a microphone.

**4 MIC POWER (+48 V) (microphone power (+48 V)) 1 and 2 switches**

When you connect microphones to the ANALOG AUDIO INPUT 1 and 2 connectors, set these switches as follows, according to the microphone power supply type.

**ON:** External power supply type microphone

**OFF:** Internal power supply type microphone

**5 ANALOG AUDIO OUTPUT 1 to 4 connectors (XLR 3-pin, male)**

These output analog audio signals.

When the unit is shipped from the factory, connectors 1 to 4 are set to audio channels 1 to 4. You can change these settings with setup menu item 824 ANALOG LINE OUTPUT SELECT (see page 151).

You can set the output level with the maintenance menu item M37: AUDIO CONFIG (see page 158). (Factory default setting: +4 dB)

Non-audio signals are muted.

By setting setup menu item 820 AUDIO OUTPUT CH3/CH4 SELECT to “monitor out”, you can output the signals of the audio channels selected with the AUDIO MONITOR SELECT buttons from connectors 3 and 4.

**6 DC IN 12V connector (XLR 4-pin, male)**

Connect to a DC power source of 12 V.

For details, see “Supplying power” on page 34.

**7 i.LINK) HDV TS connector (6-pin, IEEE1394 compliant)**

When the PDBK-202 option board is installed, i.LINK TS (HDV) signals can be input and output via this connector.

**8 i.LINK) S400 FAM connector (6-pin, IEEE1394 compliant)**

Connect a computer or other device, using an i.LINK cable.

**Notes**

- When this unit is connected to a device with a 6-pin i.LINK connector by an i.LINK cable, before plugging or unplugging the i.LINK cable, first power off the device and disconnect the power plug from the outlet. If the i.LINK cable is plugged or unplugged with the device power plug still connected, a current from an excessive voltage (8 to 40 V) output from the i.LINK connector of the device flows into this unit. This may cause a failure of the unit.
- When connecting this unit to a device with a 6-pin i.LINK connector, connect to the 6-pin i.LINK connector of the other device first.

**9 REMOTE connector (4-pin)**

Supplies power to the RM-280 Editing Controller.

**10 SD/HDSDI INPUT (SDSDI/HDSDI signal input) connector (BNC type)**

This inputs an SDSDI or HDSDI format video/audio signal.

When the PDBK-202 option board is installed, DVB-ASI TS signal can be input to this connector.

**11 HDSDI OUTPUT 1, 2 (SUPER) (HDSDI signal output 1, 2 (superimpose)) connectors (BNC type)**

These output HDSDI format video/audio signals.

When editing with two PDW-HR1 units, connect a cable between these connectors on the player unit and the SD/HDSDI INPUT connector on the recorder unit.

You can superimpose timecodes, menu settings, error messages, or other information on the output of the HDSDI OUTPUT 2 (SUPER) connector with the setting for CHAR SEL on the HOME page of the function menu or with the setting for setup menu item 028 HD CHARACTER. You can always disable to superimpose the data independent of the setting for CHAR SEL with the setting for setup menu item 028.

See “Basic Function Menu Operations” (page 49) for more information about the CHAR SEL settings.

See page 136 for more information about the setup menu item 028 HD CHARACTER.

To treat the input and output signals of these connectors as non-audio signals, set the maintenance menu item M37:



AUDIO CONFIG >M372: NON-AUDIO INPUT (recording) (see page 158) and setup menu item 823 NON-AUDIO FLAG PB (playback).

**12 REMOTE(9P) (remote control 9-pin) connector (D-sub 9-pin)**

To control this unit from a controller or VTR supporting the RS-422A Sony 9-pin VTR protocol, connect the device to this connector.

**13 SDDS I OUTPUT (SDI signal output) connector (BNC type)**

Output SDDS I format video/audio signals.

When the unit is shipped from the factory, audio signal output is eight channels with no switching, and RP188 timecode output is set to on. You can change these settings with setup menu item 828 SDI AUDIO OUTPUT SELECT and setup menu item 920 SD-SDI H-ANC CONTROL.

See page 138 for more information about setup menu operations.

**14 DVB-ASI OUTPUT connector**

When the PDBK-202 option board is installed, outputs DVB-ASI TS signals.

**15 MAINTENANCE connectors**

These are the USB connectors for maintenance.

Connect a Windows USB keyboard or mouse (see page 79), or a USB flash drive to access planning metadata stored on the drive (see page 91).

**16 HDMI OUT connector**

Outputs digital signals (video, audio, control signals). Use a HDMI cable to connect a high-definition projector, a high-definition television, or another consumer electronics product.

Signals of the audio channels selected with the AUDIO MONITOR SELECT buttons (see page 19) are output.

**17  (network) connector (RJ-45 type)**

This is a 10BASE-T/100BASE-TX/1000BASE-T connector for network connection.

**CAUTION**

- For safety, do not connect the connector for peripheral device wiring that might have excessive voltage to this port. Follow the instructions for this port.
- When you connect the network cable of the unit to peripheral device, use a shielded-type cable to prevent malfunction due to radiation noise.

**18 COMPOSITE IN/OUT (analog composite video input and output) connectors (BNC type)**

Input and output analog composite video signals.

**19 TIME CODE IN/OUT (timecode input and output) connectors (BNC type)**

Input SMPTE timecode generated by an external device to the IN connector.

The timecode output from the OUT connector depends on the operating status of this unit, as follows.

**During playback:** Playback timecode

**During recording:** The timecode from the internal timecode generator or the timecode input to the TIME CODE IN connector

**20 REF.VIDEO OUT (reference video signal output) connector (BNC type)**

When this unit is running, outputs the reference video signal that is input to the REF VIDEO IN connector.

**21 REF.VIDEO IN (reference video signal input) connector (BNC type)**

Inputs the system frequency reference video signal selected with setup menu item 013 SYSTEM FREQUENCY SELECT MENU. This connector is terminated with an impedance of 75 ohms.

## Preparing Power Sources

This unit can be powered by AC power, DC power, or a battery pack.

For safety, use only the Sony battery packs listed below.  
Lithium-ion battery pack: BP-L80S, BP-GL95

### Note

If you load or remove a battery pack incorrectly, it may fall and cause bodily injury. Follow the procedures described below to load or remove them.

## Supplying power

### AC power supply

Connect the AC IN connector to an AC power source using the specified AC power cord. To supply AC power to the unit, set the on/standby switch on the control panel to **I** (ON) and the POWER switch on the connector panel to **I** (ON).

### DC power supply

Connect the DC IN 12V connector to a DC power source. To supply DC power to the unit, set the on/standby switch on the control panel to **I** (ON) and the POWER switch on the connector panel to OFF. If the POWER switch on the connector panel is set to **I** (ON), AC power is supplied.

### Battery power supply

Battery packs that can be used with this unit are as follows.

- BP-L80S
- BP-GL95

### Continuous recording time at room temperature

BP-GL95 lithium-ion battery pack: 95 minutes

*For details on charging battery packs, refer to the operation manual for the battery charger.*

### Notes about battery usage

- Before using the batteries, be sure to charge them fully with the special battery charger. Refer to the operating instructions for your battery charger for more information about how to charge the batteries.
- Batteries may not be completely charged if you charge them immediately after use when they are still warm. You should wait until the batteries cool before charging them.

## Attaching a battery pack

Proceed as follows.

- 1 Remove the cover of the battery pack shoe.

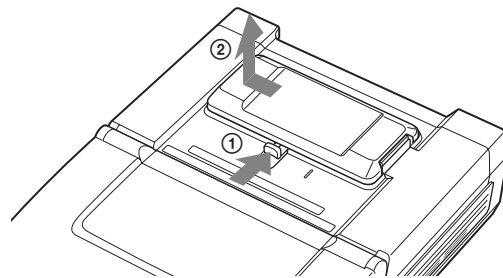

- 2 Fit the battery pack.

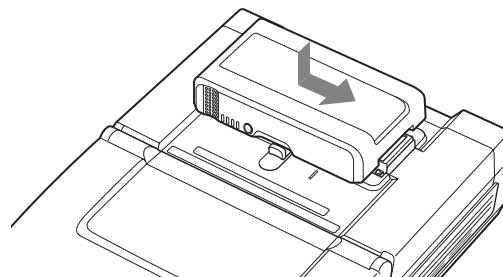

## To remove the battery pack

Follow the above procedure in the reverse flow. After the battery pack is removed, replace the cover of the battery pack shoe.

## Checking the remaining battery power

You can use the LEDs on the side panel of the battery to check the remaining power of the battery.

# Initial Setup

This unit is shipped with the area of use, system frequency, recording format, and current date and time still unset. Therefore, you need to make initial setup settings before using the unit. (You cannot use the unit without setting it up.)

Once the unit has been set up, the settings are retained even when the unit is powered off.

Use the following procedures.

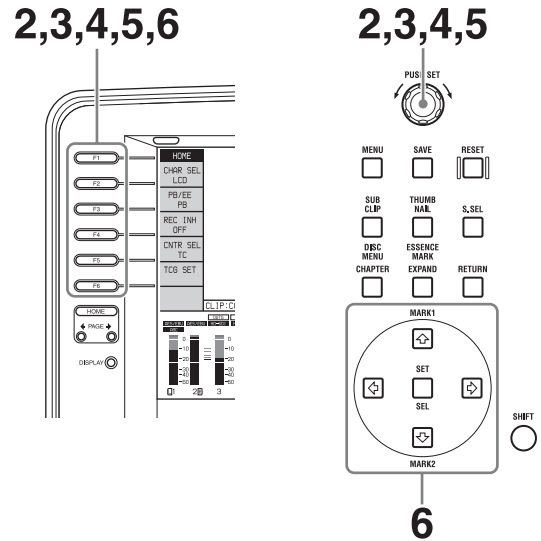

- 1 Power the unit on (*see page 34*).

The INITIAL SETUP screen appears on the display.

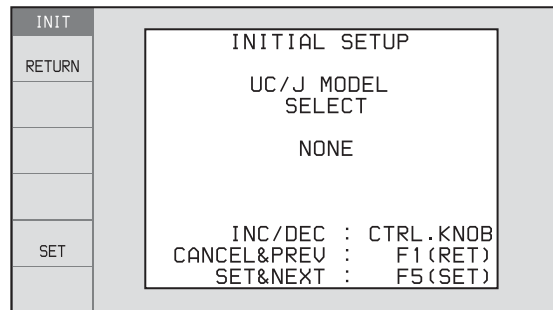

- 2 Turn the PUSH SET knob to select the area of use.

Display UC (for regions outside Japan) or J (for Japan), and then press the SET function button (F5). The system frequency screen appears.

- 3 Turn the PUSH SET knob to select the system frequency.

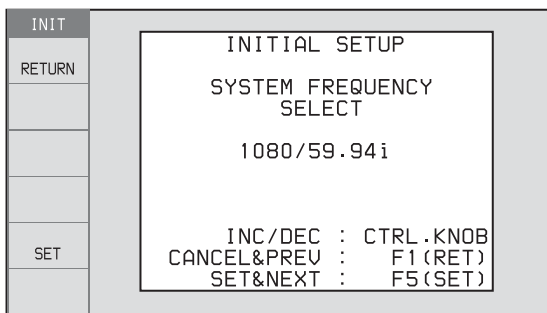

Display the system frequency that you want to use, and then press the SET function button (F5).

The recording format selection screen appears.

- 4** Turn the PUSH SET knob to select the recording format to use.

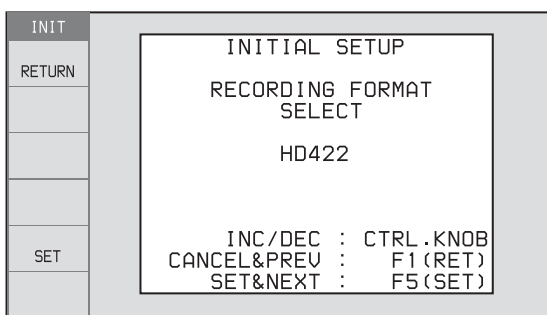

Display the recording format to use, and then press the SET function button (F5).

The DATE/TIME PRESET screen appears.

- 5** In the DATE/TIME PRESET screen, set the current date and time by setting the following items.

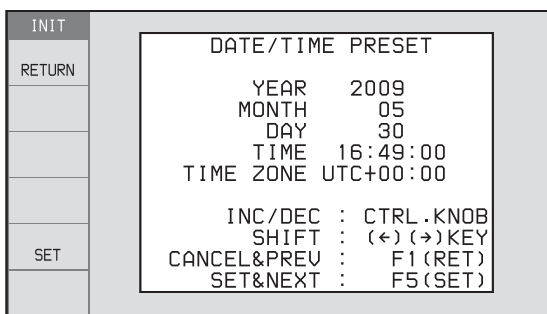

**YEAR:** Year

**MONTH:** Month

**DAY:** Day

**TIME:** Time

**TIME ZONE:** Time zone (as a difference in hours with respect to Coordinated Universal Time (UTC))

In the setting screen, you can change the value of the flashing digit.

Press the ◀ or ▶ button to make the previous digit or next digit start flashing.

Press the ▲/MARK1 or ▼/MARK2 button (or turn the PUSH SET knob) to increment or decrement the value of the flashing digit.

When you have finished making settings, press the SET function button (F5).

The date, time, and time zone settings are saved, and the message “NOW SAVING...” appears.

- 6** If you want to save the settings made up to this point, press the SET function button (F5) again.

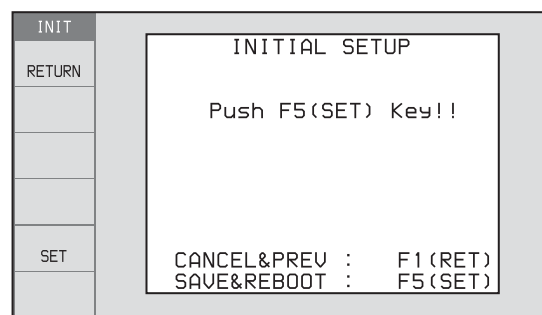

The message “NOW SAVING...” appears again, and the setting screen disappears. Then the unit powers itself off and on again.

### To return to the original screen without saving settings

Press the RETURN function button (F1).

#### Note

The time zone is reset to the factory default when you execute the maintenance menu item M49: RESET ALL SETUP. You will need to set it again. The date and time are not reset.

# Connections and Settings

## Note

Production of some of the peripherals and related devices described in this chapter has been discontinued. For advice about choosing devices, please contact your Sony dealer or a Sony sales representative.

## Connections for using the supplied application software

For an overview and installation of the application software, see the PDF file on the supplied CD-ROM. For information about how to use the software, refer to the Help provided in the software.

### Using the (network) connector (FTP connection)

The following shows an example of an FTP (File Transfer Protocol) connection.

## Note

The PDW-HR1 IP address and other network-related settings are required for connections.

For details of the network-related settings, see “To change network settings” (page 162).

### Connecting this unit directly to a laptop computer

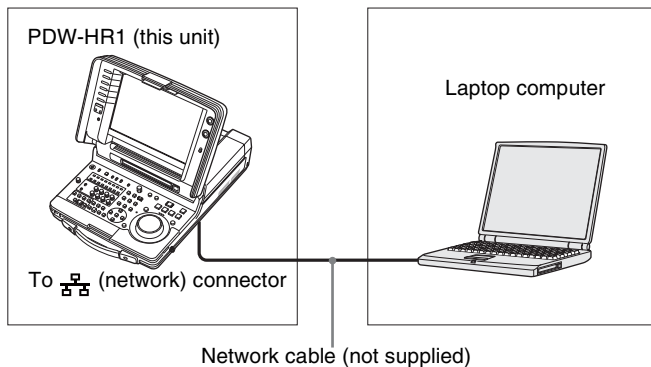

#### Settings on this unit

Remote control switch: NET (see page 16)
Setup menu item 257 NETWORK ENABLE: net

### Connecting three PDW-HR1 units to a laptop computer via a LAN

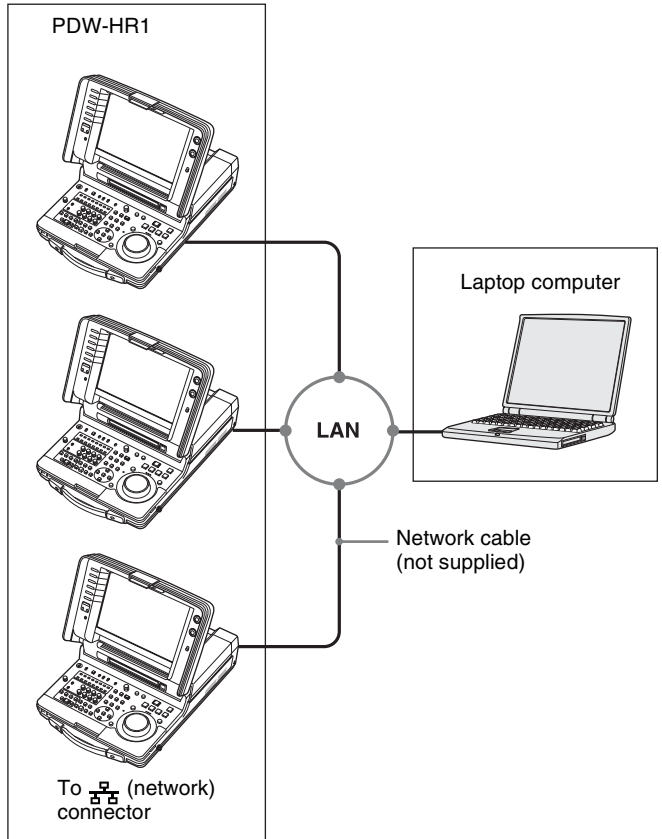

#### Settings on all PDW-HR1

Remote control switch: NET (see page 16)
Setup menu item 257 NETWORK ENABLE: net

### Using the (i.LINK) S400 FAM connector (FAM connection)

The following shows an example of a FAM (file access mode) connection.

## Note

The FAM driver must be installed in advance.

See “To install the FAM driver” (page 123 or 125) for more information about installing the FAM driver.

Some limitations apply to FAM connections. For details, see “File Operations in File Access Mode (for Windows)” (page 123).

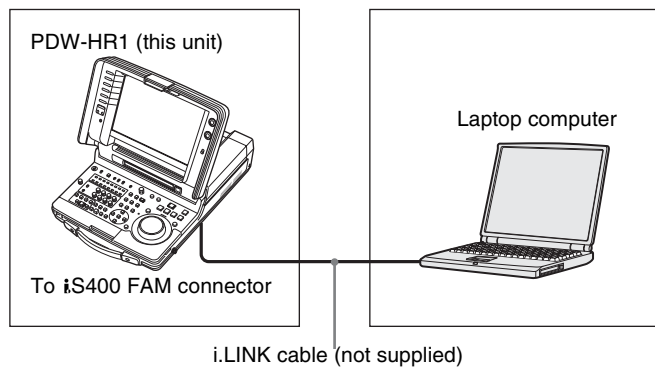

Use of a shielded cable is recommended.

## Connections for cut editing

The following figure shows a cut editing system with this unit as the player.

*When making the connections, also refer to the manuals provided with the equipment to be connected.*

*See page 40 for more information about editing control unit settings.*

### When using an editing control unit

#### Using the BVE-700/700A

The following figure shows a cut editing system comprising this unit as the player, an HDW-M2000/M2000P unit as the recorder, and a BVE-700/700A as the editing control unit.

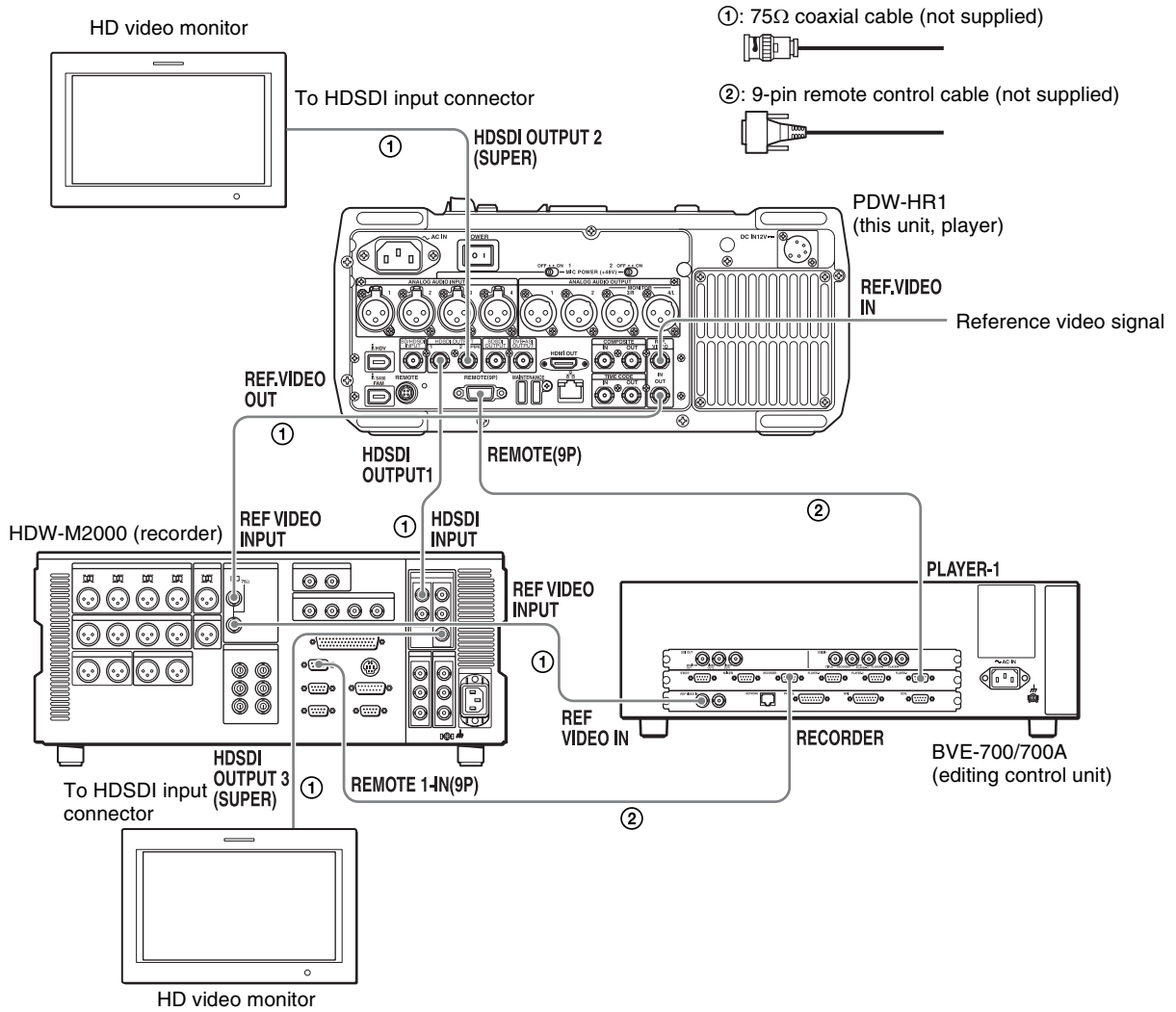

HDW-M2000 (recorder) settings	BVE-700/700A (editing control unit) setting	Settings on this unit
REMOTE 1 (9P) button: Lit	SYNCHRONIZE menu: OFF	Remote control switch: REMOTE (see page 16)
REF.VIDEO INPUT connector 75 Ω termination switch: OFF		Setup menu item 214 REMOTE INTERFACE: 9PIN
Audio selection function switching button INPUT button: HDSOI		
Function menu HOME >F1 (VID. IN): SDI		
Function menu page 1 >F1 (TCG): INT		
Function menu page 1 >F2 (PR/RGN): PRESET		
Function menu page 1 >F3 (RUN): FREE		

## Editing Control Unit Settings

When connecting an editing control unit (BVE-700/700A/2000/9100) to use with this unit, set VTR constants as follows.

System frequency	VTR CONSTANT															
	1	2	3	4	5	6	7	8	9	10	11	12	13	14	15	16
59.94i/ 59.94P/ 29.97P	A0	9A	00	96	--	--	03	80	0A	07	FE	00	80	5A	FF	5A
50i/50P/25P	A1	9A	00	7D	--	--	03	80	0A	07	FE	00	80	4C	FF	4B
23.98P	A2	9A	00	78	--	--	03	80	0A	07	FE	00	80	48	FF	48

### Using the RM-280

The following figure shows a cut editing system comprising this unit as the player, an HDW-M2000/

M2000P unit as the recorder, and an RM-280 as the editing controller.

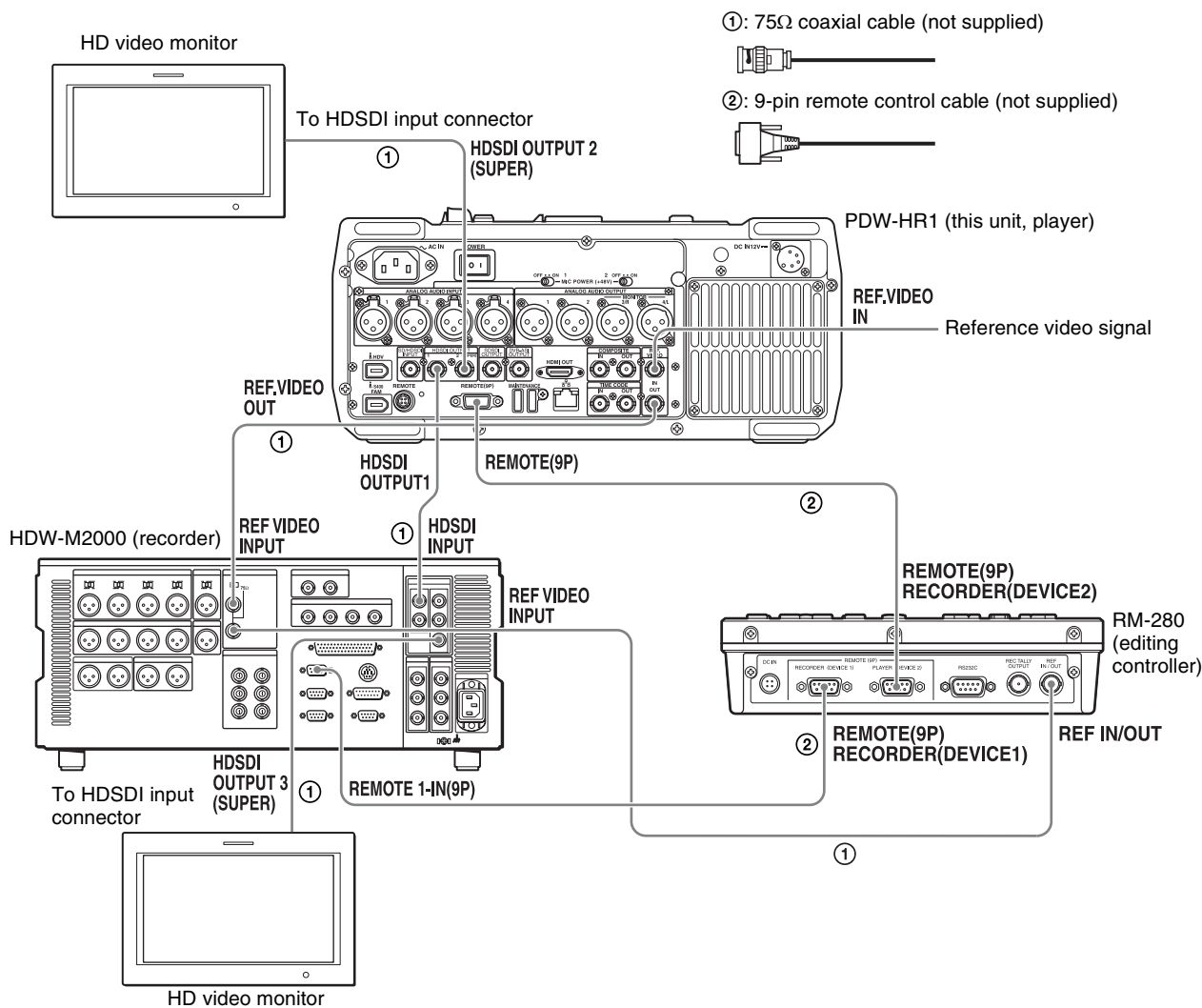

HDW-M2000 (recorder) settings	RM-280 (editing controller) settings	Settings on this unit
REMOTE 1 (9P) button: Lit	EDITOR/REMOTE CONTROL selector switch: EDITOR	Remote control switch: REMOTE (see page 16)



HDW-M2000 (recorder) settings	RM-280 (editing controller) settings	Settings on this unit
REF.VIDEO INPUT connector 75 Ω termination switch: OFF	Setup menu 01 PREROLL: 5s	Setup menu item 214 REMOTE INTERFACE: 9PIN
Audio selection function switching button INPUT button: HDSDI	Setup menu 05 SYNC SEL: ON	
Function menu HOME >F1 (VID. IN): SDI	Setup menu 06 SYNC VTR: RECORDER	
Function menu page 1 >F1 (TCG): INT	Setup menu 09 EDIT DLY: AUTO	
Function menu page 1 >F2 (PR/RGN): PRESET	Setup menu 10 R ST DLY: AUTO	
Function menu page 1 >F3 (RUN): FREE	Setup menu 11 P ST DLY: AUTO	

## Using in an edit list editing system

The following figure shows an edit list editing system comprising this unit as the recorder, and an HDW-M2000/M2000P unit as the player.

See page 102 for more information about edit list editing.

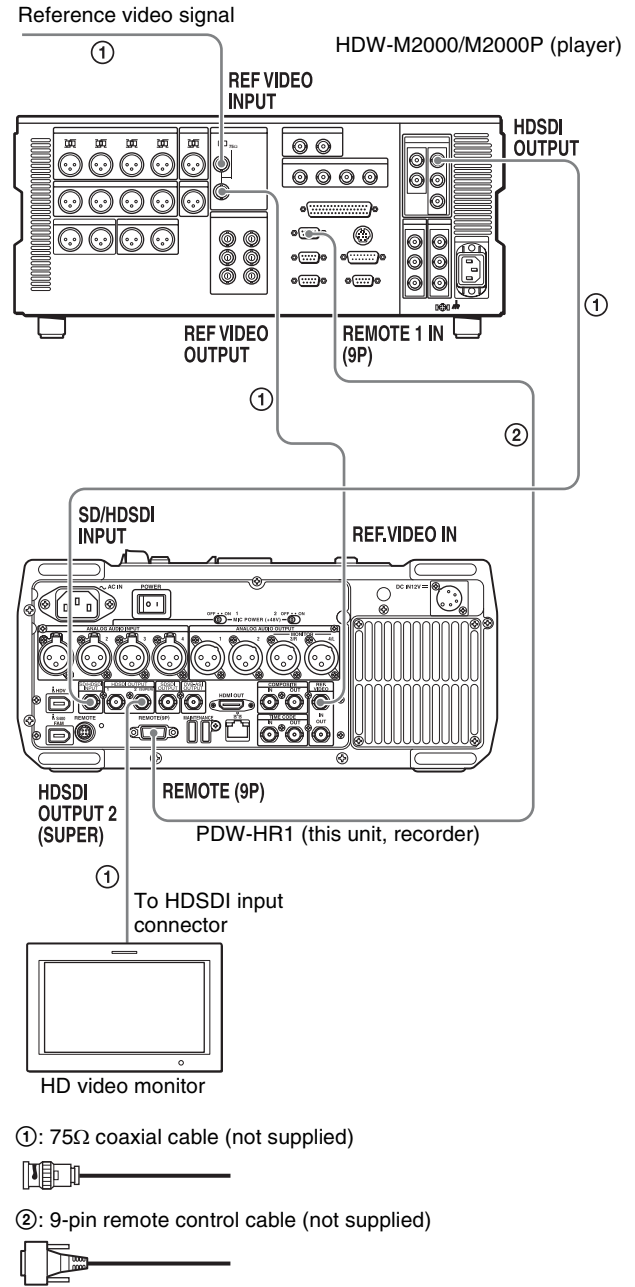

HDW-M2000 (recorder) setting	Settings on this unit
REMOTE 1 (9P) button: Lit	Remote control switch: REMOTE (see page 16)
	Setup menu item 214 REMOTE INTERFACE: 9PIN

For details of HDW-M2000/M2000P settings, refer to the HDW-M2000/M2000P Operation Manual.

## Connections for pool coverage

The following figure shows an example of connections for pool coverage, with the PDW-700 Professional Disc Camcorder connected.

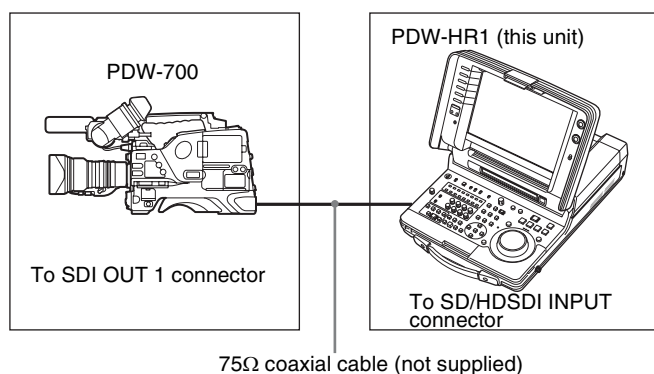

PDW-700 (camcorder) setting	Settings on this unit
HDSDI REMOTE I/F on page CAM CONFIG 1 of the MAINTENANCE menu: other than OFF	Remote control switch: REMOTE (see page 16)
	Setup menu item 214 REMOTE INTERFACE: SDI

# Synchronization Reference Signals

The synchronization reference signal generator of this unit synchronizes to a reference signal input to the REF. VIDEO IN connector or to a video input signal. External synchronization is as follows, depending on the setting of

OUT REF on page P1 VIDEO of the function menu, and on the type of the selected input signal. Video output signals are always synchronized to the internal synchronization signal.

Input to SD/HDSDI INPUT or COMPOSITE IN connector <sup>a)</sup>	Input to REF. VIDEO IN connector	Setting of OUT REF on page P1 VIDEO <sup>b)</sup>	
		REF	INPUT
Yes	Yes	Synchronize to the signal input to the REF. VIDEO IN connector	Synchronize to the signal input to the SD/HDSDI INPUT or COMPOSITE IN connector <sup>c)</sup>
Yes	No	Synchronize to the signal input to the SD/HDSDI INPUT or COMPOSITE IN connector <sup>c)</sup>	
No	Yes	Synchronize to the signal input to the REF. VIDEO IN connector	
No	No	No external synchronization is made	

a) When V INPUT on page P1 VIDEO of the function menu is set to "SG" and OUT REF is set to "INPUT", synchronize to the internal reference signal of this unit.

b) During FAM or FTP connections, always synchronize to the internal synchronization reference signal, regardless of the setting of OUT REF.

c) When setup menu item 308 SELECTION OF STD/NON-STD FOR COMPOSITE VIDEO IN is set to "N-STD", always synchronize to the internal synchronization reference signal.

# Setting System Frequency

This unit can record and play back video at the system frequencies of 59.94i, 50i, 29.97P, 25P, and 23.98P (1080) or 59.94P and 50P (720).

## To select the system frequency

- 1 Set setup menu item 013 SYSTEM FREQUENCY SELECT MENU to “on” and press the PUSH SET knob.

The system frequency selection screen appears.

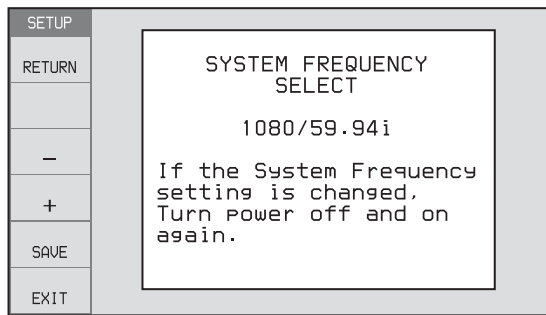

- 2 Turn the PUSH SET knob to select the system frequency to be used.

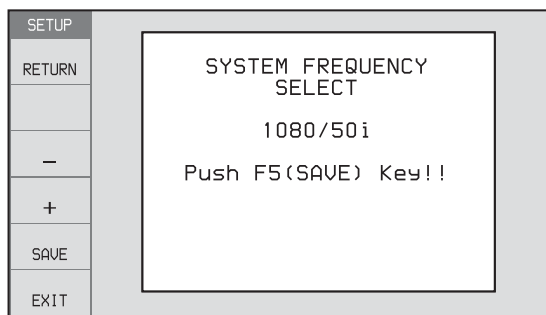

- 3 Press the PUSH SET knob, the SAVE function button (F5), or the save button.

The message “Turn off/on POWER!!” appears.

- 4 Move the on/standby (I/O) switch to the O position to power the unit off, and then power it on again.

# Setting Timecode

There are the following four ways of recording timecode:

**Internal Preset mode:** This records the output of the internal timecode generator, set beforehand to an initial value. The following run modes can be selected.

- Free Run: Timecode advances continually.
- Rec Run: Timecode advances only during recording.

**Internal Regen mode:** This records the output of the internal timecode generator, initialized to timecode following continuously upon the timecode of the last frame of the last clip on the disc.

**External Regen mode:** This records the output of the internal timecode generator, synchronized to an external timecode generator. As the external input, the timecode input to any of the following connectors can be selected.

- TIME CODE IN connector: LTC
- SD/HDSDI INPUT connector: SDI VITC, LTC, and DVB-ASI TC
- COMPOSITE IN connector: VITC
- i (i.LINK) HDV TS connector: TC

**External Preset mode:** This directly records the input of an external timecode generator. As the external input, the timecode input to any of the following connectors can be selected.

- TIME CODE IN connector: LTC
- SD/HDSDI INPUT connector: SDI, LTC, and DVB-ASI TC
- COMPOSITE IN connector: VITC
- i (i.LINK) HDV TS connector: TC

## To record timecode after setting an initial value (Internal Preset)

Proceed as follows with the function menu. To set the timecode, set the INT/EXT/SDI switch to INT and the PRESET/REGEN switch to PRESET.

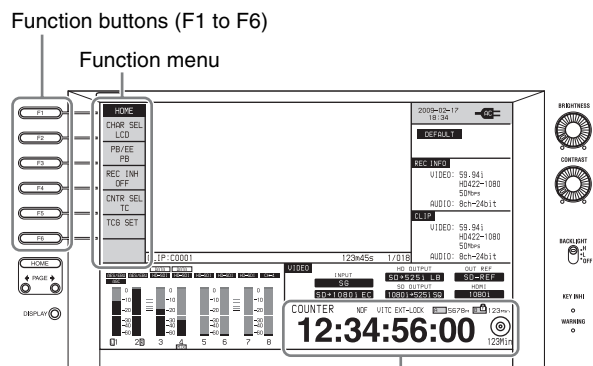

Time data display area

### To set an initial timecode value

- 1 Press the CNTR SEL function button on the HOME page of the function menu, and select TC.
- 2 Press the TCG SET function button (F5).

The first digit of the time data display starts flashing.

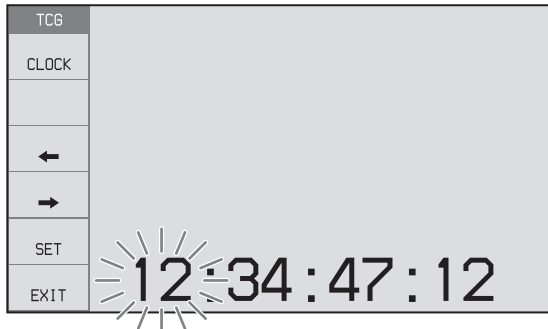

- 3 Press the ← or → function button (F3 or F4) to select a digit to be set.

The selected digit starts flashing.

- 4 Use the PUSH SET knob to set the value for the selected digit.

#### To set the next-most significant digit (10s place)

Turn the PUSH SET knob while holding down the SHIFT button.

Repeat steps **3** and **4** to set all digits that should be set.

#### To set to 00:00:00:00

Press the RESET button.

- 5 Press the SET function button (F5) or the SAVE button.

If the F-RUN/R-RUN switch is set to F-RUN, the timecode starts running.

### To cancel a setting

Press the EXIT function button (F6). Any new settings to that point are canceled, and the setting operation is terminated.

### To set the timecode to the current time

- 1 Set the F-RUN/R-RUN switch to F-RUN and DF/NDF on page P3 TC to DF (in 59.94i/59.94P/29.97P mode only).
- 2 Perform steps **1** to **4** of “Setting an initial timecode value” to set the timecode to a time slightly ahead of the current time.

- 3 Press the SET function button (F5) or the SAVE button at the instant when the current time matches the displayed timecode.

### To set user bits

You can record up to 8 hexadecimal digits of information (date, time, event number, etc.) on the timecode track. Select UB by pressing the CNTR SEL function button (F4) in step **1** of “Setting an initial timecode value” and carry out steps **2** to **5**. Settings are made in hexadecimal (0-9, A-F).

You can record ID codes in user bits.

### To record timecode that follows sequentially upon the last recorded timecode (Internal Regen)

You can record timecode so that it is continuous from one clip to the next on the disc.

Set the INT/EXT/SDI switch to INT and the PRESET/REGEN switch to REGEN TC or REGEN VITC. When this setting is in force, the unit reads the timecode of the last frame of the last recorded clip on the disc before starting to record, and internally generates timecode that follows upon the recorded timecode.

The frame count mode (for system frequency 59.94i/59.94P/29.97P only) is set to the same mode as the last recorded timecode on the disc (drop-frame or non-drop-frame).

### To record with the internal timecode generator synchronized to external timecode (External Regen)

Use this method to synchronize the timecode generators of a number of recorders, to record the playback timecode of external VTRs, or to record while maintaining synchronization between the source video and timecode. Use either of the following procedures according to the type of external timecode.

#### To synchronize to the timecode input to the TIME CODE IN connector

- 1 Connect the timecode output of an external device to the TIME CODE IN connector.
- 2 Set the INT/EXT/SDI switch to EXT and the PRESET/REGEN switch to REGEN TC.

#### To synchronize to the timecode multiplexed into a video signal input to the SD/HDSDI INPUT connector

- 1 Input an HDSDI signal containing LTC/VITC to the SD/HDSDI INPUT connector.

- 2 Set the INT/EXT/SDI switch to SDI and the PRESET/REGEN switch to REGEN TC or REGEN VITC.

### To synchronize to the VITC timecode of a video signal input to the SD/HDSDI INPUT connector

- 1 Input a SDDS signal containing VITC to the SD/HDSDI INPUT connector.
- 2 Set the INT/EXT/SDI switch to “EXT”, and set the PRESET/REGEN switch to “REGEN VITC”.

### To synchronize to the timecode of a video signal input to the COMPOSITE IN connector

- 1 Input a composite signal containing VITC to the COMPOSITE IN connector.
- 2 Set the INT/EXT/SDI switch to “EXT”, and set the PRESET/REGEN switch to “REGEN VITC”.

Executing either of these procedures starts the internal timecode generator running in synchronization with the external timecode generator.

Once the internal timecode generator is synchronized with the external timecode generator, the internal timecode generator continues to run even if the external timecode generator connection is removed.

The timecode advance mode is set automatically to Free Run. The frame count mode (for system frequency 59.94i/59.94P/29.97P only) is set to the same mode as the external timecode signal (drop-frame or non-drop-frame).

### To check the synchronization to the external signal

Press the STOP button to stop this unit, then press the REC button.

Check that the timecode value shown in the time data display coincides with the external timecode value.

### To record external timecode directly (External Preset)

When you use this method, the internal timecode generator advances without being affected by the external timecode.

### To directly record timecode input to the TIME CODE IN connector

- 1 Input the timecode output of an external device to the TIME CODE IN connector.
- 2 Set the INT/EXT/SDI switch to “EXT”, and set the PRESET/REGEN switch to “PRESET”.

### To record with no changes the timecode multiplexed into a video signal input to the SD/HDSDI INPUT connector

- 1 Input a SD/HDSDI signal containing LTC to the SD/HDSDI INPUT connector.
- 2 Set the INT/EXT/SDI switch to “SDI”, and set the PRESET/REGEN switch to “PRESET”.

### To record with no changes the timecode of a video signal input to the COMPOSITE IN connector

- 1 Input a composite signal containing VITC to the COMPOSITE IN connector.
- 2 Set the INT/EXT/SDI switch to “SDI”, and set the PRESET/REGEN switch to “PRESET”.

# Superimposed Text Information

The video signal output from the COMPOSITE OUT connector, SDDS I OUTPUT connector, or the HDS DI OUTPUT 2 (SUPER) connector contains superimposed text information, including timecode, menu settings, and alarm messages.

## Adjusting the text display

You can adjust the position, size and type of the superimposed text using setup menu items 002, 003, 005, 009, 011, and 012.

For details, see “Items in the basic menu” (page 134).

## Information displayed

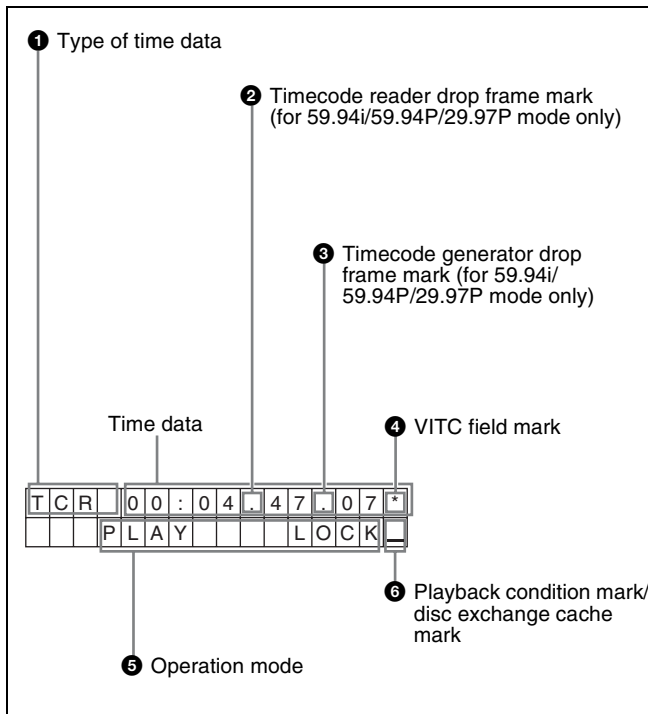

### Note

The display shown above corresponds to the factory default settings of the unit. You can change the type of information to be displayed in the lower line of the display by changing the setting of setup menu item 005 DISPLAY INFORMATION SELECT.

For details, see “Items in the basic menu” (page 134).

## 1 Type of time data

Display	Meaning
CNT	Counter data
TCR	TC reader timecode
UBR	TC reader user bits data
TCR.	VITC reader timecode
UBR.	VITC reader user bits data
TCG	TC generator timecode
UBG	TC generator user bits data
IN	In point time data
OUT	Out point time data
DUR	Duration between In point and Out point

### Note

If the time data or user bits data cannot be read correctly, they will be displayed with an asterisk. For example, “T\*R”, “U\*R”, “T\*R.” or “U\*R.”.

## 2 Timecode reader drop-frame mark (for 59.94i/59.94P/29.97P mode only)

“.”: Indicates drop-frame mode.

“.”: Indicates non-drop-frame mode.

## 3 Timecode generator drop-frame mark (for 59.94i/59.94P/29.97P mode only)

“.”: Indicates drop-frame mode (factory default setting).

“.”: Indicates non-drop-frame mode.

## 4 VITC field mark

“ ” (blank): Fields 1 and 3 (for 59.94i/59.94P/29.97P mode) or fields 1, 3, 5 and 7 (for 50i/50P/25P mode)

“\*”: Fields 2 and 4 (for 59.94i/59.94P/29.97P mode) or fields 2, 4, 6 and 8 (for 50i/50P/25P mode)

## 5 Operation mode

The field is divided into two blocks as shown below.

- Block A displays the operation mode.
- Block B displays the servo lock status or playback speed.

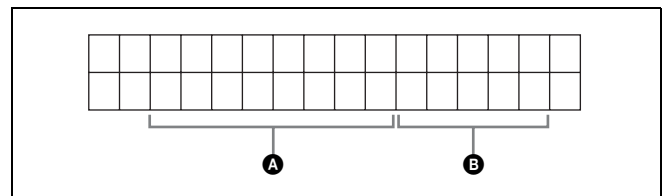

Display		Operation mode
Block A	Block B	
DISC OUT		Disc is not loaded.
LOADING		Disc is being loaded.
UNLOADING		Disc is being unloaded.
STANDBY OFF		Standby off mode

Display		Operation mode
Block A	Block B	
C.STANDBY OFF		Standby off mode <sup>a)</sup>
STOP		Stop mode
C.STOP		Stop mode <sup>a)</sup>
NEXT xxx		Cuing up to the first frame of the next clip.
PREV xxx		Cuing up to the first frame of the current clip.
F.FWD		Fast forward search
F.REV		Fast reverse search
PLAY		Playback mode (servo unlocked)
PLAY	LOCK	Playback mode (servo locked)
REC		Record mode (servo unlocked)
C.REC		Record mode (servo unlocked) <sup>a)</sup>
REC	LOCK	Record mode (servo locked)
C.REC	LOCK	Record mode (servo locked) <sup>a)</sup>
JOG	STILL	A still picture in jog mode
JOG	FWD	Jog mode in forward direction
JOG	REV	Jog mode in reverse direction
SHUTTLE	STILL	A still picture in shuttle mode
SHUTTLE	(Speed)	Shuttle mode
VAR	STILL	A still picture in variable mode
VAR	(Speed)	Variable speed mode
TOP 0001/xxxx		Cuing up to the first frame of the first clip.
END xxxx/xxxx		Cuing up to the last frame of the last clip.
PREROLL		Cuing up during thumbnail search

a) Appears when the unit is in Clip Continuous Rec mode.

## 6 Playback condition mark

One of three channel condition marks is displayed when the ACCESS indicator is lit during any mode except recording. Also, a “C” appears in this position when the disc exchange cache function is active.

See page 57 for more information about the meaning of the disc exchange cache mark.

### Meaning of the playback condition marks

Display	Name	Description
—	Green condition	There is no problem with the playback condition. This unit and the disc can be used just as they are. This corresponds to the “green” channel condition indicator of a VTR.

Display	Name	Description
=	Yellow condition	The playback condition has deteriorated to some degree. There are no read errors, but you should take the action described in the next section. This corresponds to the “yellow” channel condition indicator of a VTR.
≡	Red condition	The playback condition has deteriorated. There are no read errors, <sup>a)</sup> but you should take the action described in the next section. This corresponds to the “red” channel condition indicator of a VTR.

a) Read errors will occur if the playback condition continues to deteriorate. If a read error occurs, a “Disc Error!” alarm appears in the time data display, the picture freezes, and audio is muted.

To display playback condition marks, set setup menu item 012 CONDITION DISPLAY ON VIDEO MONITOR to “ena”, and set setup menu item 005 DISPLAY INFORMATION SELECT to “T&sta”.

For details about operation, see “Basic menu operations” (page 138).

## Playback condition displays

You can be alerted in advance to deteriorating playback conditions and to error correction rates which are approaching their limits.

Deteriorating playback may be due to the following causes.

- Scratches and dust on the disc surface  
This includes fingerprints, dust from the air, tar from cigarette smoke, and so on. Scratches and soiling which occur before recording are not a problem because they are registered in advance as defects, and recording avoids them. However, scratches and soiling which occur after recording can lead to deteriorating playback conditions.
- Aging of disc recording layers  
Over several decades, the recording layers of optical discs can age and cause deteriorating playback conditions. You can use this function to check archival discs and other discs which have been stored for extended periods, so that you can take action before the deterioration progresses further.
- Deteriorating laser diodes performance  
The performance of the laser diodes used in optical heads can worsen with age, leading to deteriorating playback conditions.

For details, see “Digital hours meter” (page 168) about this setting.



Refer to the Maintenance Manual for an approximate guide to when it is time to replace optical heads.

### To prevent playback conditions from deteriorating

Pay attention to the following points when handling discs.

- Do not open disc cartridges and touch discs directly with your hands.
- Do not store for long periods in locations which are dusty or exposed to air circulated by fans.
- Do not store for long periods under high temperatures or in locations exposed to direct sunlight.

### If playback conditions have deteriorated

If a yellow or red playback condition mark appears, check the following points.

**Whether the disc displays the same playback condition on other XDCAM devices:** If so, the surface of the disc may be dirty or scratched, or the performance of the recording layers on the disc may have worsened due to age. Do not use discs with these symptoms.

**Whether every disc inserted into an XDCAM device displays the same playback conditions:** If so, the performance of the laser diodes may have deteriorated. Check the total optical output time.

# Basic Function Menu Operations

The function menu provides access to frequently used settings, such as input video signal selection and timecode settings.

Menu settings are stored in nonvolatile memory and are preserved even after the unit is powered off.

## Function menu operations

The function menu appears on the color LCD of this unit. The following figure shows the buttons used in function menu operations.

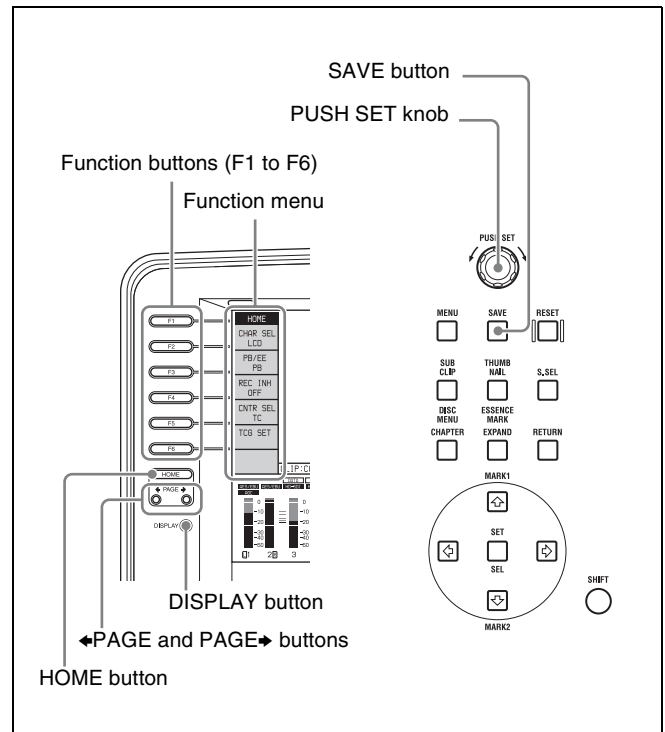

### To display the function menu

The function menu is made up of the HOME page and pages P1 to P4, (P5)<sup>1)</sup>, (HOME2)<sup>1)</sup>.

If the function menu is not already visible, press the ◀PAGE, PAGE▶, or HOME button to display it. (The most recently accessed function menu page appears.)

1) If a menu item is assigned using maintenance menu item M38: F-KEY CONFIG

### To display a different page

Each press of the ◀PAGE or PAGE▶ button displays the next function menu page in the order: HOME ↔ P1 ↔ P2 ↔ P3 ↔ P4 ↔ (P5)<sup>1)</sup> ↔ (HOME2)<sup>1)</sup> ↔ HOME...

1) If a menu item is assigned using maintenance menu item M38: F-KEY CONFIG

### To clear the function menu from the screen

**Basic operation display:** Press the DISPLAY button to switch to the video monitor display.

**Video monitor display:** After a menu operation, the menu disappears after about four seconds.

### To change the setting of a function menu item

Use the function buttons.

#### To select the value of the setting item

Press the button to the left of each setting item to change the value of the item. Keep pressing the button until the value you want appears.

#### To set the value of the setting item

- Press the button to the left of each setting item so that the setting value flashes to enable adjustment of the value and then turn the PUSH SET knob to increase or decrease the value.
- Turning the PUSH SET knob while holding down the SHIFT button increases the increment of adjustment.
- Pressing the button to the left of each setting item while the setting value is flashing causes the value to stop flashing and completes the adjustment.

## Function menu settings

The following tables list the setting items on each page and describe their setting values. Underlined values are the factory defaults.

### HOME page

Item	Setting
F1: CHAR SEL	Turns the display of character information on the color LCD and on an external monitor on and off. <b><u>ON</u></b> : Character information on <b>OFF</b> : Character information off <b>LCD</b> : Character information on for the color LCD only
F2: PB/EE	Selects the type of video and audio signals to output during fast forward, fast reverse, stop, and standby. <b><u>PB</u></b> : Playback signal <b>EE</b> : E-E signal
F3: REC INH	Specifies whether to inhibit recording to the disc. <b><u>OFF</u></b> : Do not inhibit recording. <b>ON</b> : Inhibit recording to the disc.
F4: CNTR SEL	Selects the type of time data to display in the time data display area. <b><u>TC</u></b> : Timecode <b>UB</b> : User bits <b>COUNTER</b> : Elapsed recording or playback time

Item	Setting
F5: TCG SET	<ul style="list-style-type: none"> <li>• When CNTR SEL is set to “TC”, displays a screen where you can set the initial value of the timecode generated by the internal timecode generator <sup>a)</sup> (see page 45).</li> <li>• When CNTR SEL is set to “UB”, displays a screen where you can set timecode user bits <sup>a)</sup> (see page 45).</li> </ul>
F6:	(Unassigned function button)

a) This is displayed only when the INT/EXT/SDI switch is set to “INT”, and the PRESET/REGEN switch is set to “PRESET”.

### P1 VIDEO page

Item	Setting
F1: V INPUT	Selects the video input signal. <b><u>HDSDI</u></b> : HDSDI signal <b>SDSDI</b> : SDDSI signal <b>CMPST</b> : Composite signal <b>i.LINK</b> : i.LINK signal (when the PDBK-202 option board is installed) <b>DVB-ASI</b> : DVB-ASI signal (when the PDBK-202 option board is installed) <b>SG</b> : Test signal from internal signal generator <sup>a)</sup>
F2: LCD MODE	Switches the video monitor display mode.
	<b>Sub-Item</b>
F1: SOURCE	Video output to display on the video monitor <b><u>HD</u></b> : Video output to the HDSDI OUTPUT 1 and 2 (SUPER) connectors <sup>b)</sup> <b>SD</b> : Video output to the SDDSI OUTPUT connector <sup>c)</sup>
F2: SDASPECT	Aspect ratio of the picture when “SD” is selected <b><u>4:3</u></b> <b>16:9</b>
F3: COLOR	Color temperature of the video monitor <b><u>HIGH</u></b> : High color temperature <b>LOW</b> : Low color temperature
F4:	–
F5:	–
F6: EXIT	Exits the video monitor display mode sub menu.

Item	Setting	
F3: WFM	Makes settings related to display of the waveform monitor or vectorscope. (The waveform monitor or vectorscope appear only when the display is showing the video monitor.)	
	<b>Sub-Item</b>	
	F1: MODE	Display mode <b>OFF</b> : Display neither. <b>WFM</b> : Waveform monitor <sup>d)</sup> <b>VEC75%</b> : 75% color bar signal vectorscope <sup>d)</sup> <b>VEC100%</b> : 100% color bar signal vectorscope <sup>d)</sup>
	F2: POSITION	Display position <b>R.B.</b> : Right bottom <b>R.T.</b> : Right top <b>L.T.</b> : Left top <b>L.B.</b> : Left bottom
	F3: BG	Background <b>BLACK</b> : Black (opaque) <b>HALF</b> : Transparent
	F4:	–
	F5:	–
F6: EXIT	Exits the waveform monitor/vectorscope display settings sub menu.	
F4: OUT REF	Selects the reference signal for the output signals of this unit. <b>REF</b> : Use the signal input to the REF.VIDEO INPUT connector as the output reference signal. <b>INPUT</b> : Use the input video signal as the output reference signal.	
F5: SYNC	Sets the sync phase of HD output signals. While the setting value is flashing, turn the PUSH SET knob to adjust the sync phase of output signals with respect to the input reference signal, over the range $\pm 15 \mu\text{s}$ . (The display shows $-128$ to $+127$ .)	
F6: FINE	Makes fine adjustment to the sync phase of HD output signals. While the setting value is flashing, turn the PUSH SET knob to adjust the sync phase of output signals with respect to the input reference signal, over the range $\pm 200 \text{ ns}$ . (The display shows 0 to 1023.)	

- a) When V INPUT is set to “SG”, “SDI” cannot be selected for AU INPUT on the P2 AUDIO page.  
b) The settings of setup menu item 950 UP CONVERTER MODE are reflected.  
c) The settings of setup menu item 930 DOWN CONVERTER MODE are reflected.  
d) Does not appear when a GUI screen is being displayed.

## P2 AUDIO page

Item	Setting	
F1: AU INPUT	Selects the audio input signal to assign to audio channels 1 to 8. <b>SDI</b> : Audio signal embedded into SDI signal <b>ANALOG1</b> : Analog 1 audio signal <b>SG</b> : Test signal from internal signal generator <b>i.LINK</b> : i.LINK signal (when the PDBK-202 option board is installed) <b>DVB-ASI</b> : DVB-ASI signal (when the PDBK-202 option board is installed)	
	<b>Sub-item</b>	
	F1: A1 INPUT (A5 INPUT)	Input signal of audio channel 1 (5)
	F2: A2 INPUT (A6 INPUT)	Input signal of audio channel 2 (6)
	F3: A3 INPUT (A7 INPUT)	Input signal of audio channel 3 (7)
	F4: A4 INPUT (A8 INPUT)	Input signal of audio channel 4 (8)
	F5: A5-A8 (A1-A4)	Switches to the sub menu for setting channels 5 to 8 (1 to 4).
	F6: EXIT	Exit the audio input signal selection sub-menu.
	F2: REC VOL	Sets the recording audio level of audio channels 5 to 8. <sup>a)</sup> The recording audio level can be adjusted within the range from $-200$ to $+200$ ( $-\infty$ to $+12 \text{ dB}$ ) by turning the PUSH SET knob.
		<b>Sub-item</b>
F1: A5 VOL		Recording audio level of audio channel 5
F2: A6 VOL		Recording audio level of audio channel 6
F3: A7 VOL		Recording audio level of audio channel 7
F4: A8 VOL		Recording audio level of audio channel 8
F5:		–
F6: EXIT	Exit the recording audio level setting sub-menu.	

Item	Setting
F3: PB VOL	Sets the playback audio level of audio channels 5 to 8. <sup>a)</sup> The playback audio level can be adjusted within the range from -200 to +200 (-∞ to +12 dB) by turning the PUSH SET knob.
<b>Sub-item</b>	
F1: A5 VOL	Playback audio level of audio channel 5
F2: A6 VOL	Playback audio level of audio channel 6
F3: A7 VOL	Playback audio level of audio channel 7
F4: A8 VOL	Playback audio level of audio channel 8
F5:	–
F6: EXIT	Exit the playback audio level setting sub-menu.
F4: MIX/SWAP <sup>b)</sup>	Enables or disables mixing output of audio/voice signals. <b>OFF:</b> Do not output <b>ON:</b> Output
F5: SPEAKER	Enables or disables output from this unit's speaker. <b>OFF:</b> Do not output <b>ON:</b> Output
F6: AU METER	Selects the display mode of the audio level meters. <b>FULL:</b> Display the range from -60 dB to 0 dB. <b>FINE:</b> Display a magnified section with 0.25 dB step marks.

- a) To enable this setting, the following settings are also required, in the same way as for volume operations for channels 1 to 4.
- On the control panel, set the VARIABLE/PRESET switch for playback to "VARIABLE".
  - Set setup menu item 131 AUDIO VOLUME to "each".
- b) Displayed only when the PDBZ-UPG03 Software Upgrade Key or PDBK-MK1 option board is installed.

### P3 TC page

Item	Setting
F1: TC UB	When the PRESET/REGEN switch is set to "PRESET", selects whether the user bits of the timecode generator are synchronized to the internal clock. <b>FIX:</b> Do not synchronize user bits. <b>TIME:</b> Synchronize user bits to the internal clock.
F2:	(Unassigned function button)
F3:	(Unassigned function button)
F4: DF/NDP	Selects the drop-frame mode for the internal timecode generator and the counter in 59.94i/59.94P/29.97P mode. <b>DF:</b> Drop-frame mode <b>NDP:</b> Non-drop-frame mode

Item	Setting
F5: PDPSET	When the system frequency is set to 1080/59.94i, 1080/29.97P, or 720/59.94P, presets the timecode of the A frame of the pulldown sequence. <b>24F TC.:</b> Reference timecode for A frame <b>30F TC.:</b> Timecode after pulldown conversion from 24-frame timecode
<b>Sub-Item</b>	
F1:	–
F2:	–
F3: ←	Move the flashing digit to the left or right.
F4: →	
F5: SET	Saves the new setting and exits the pulldown sequence preset sub menu.
F6: EXIT	Exits the pulldown sequence preset sub menu without saving the new setting.
F6: TCR	Selects the type of timecode to display in the time data display area. <b>TC:</b> Display TC. <b>VITC:</b> Display VITC.

### P4 OTHER page

Item	Setting
F1: ALRM LOG	Displays an alarm log screen.
<b>Sub-Item</b>	
F1: ALARM	Alarm messages
F2: DATE	Dates and times when the alarms occurred
F3: TC	Positions where alarms occurred (timecode)
F4: DETAIL	Alarm details
F5:	–
F6: EXIT	Exits the alarm log screen sub menu.
F2: ERR LOG	Displays an error log screen.
<b>Sub-Item</b>	
F1: ERROR	Error messages
F2: DATE	Dates and times when the errors occurred
F3: TC	Positions where errors occurred (timecode)
F4: DETAIL	Error details
F5:	–
F6: EXIT	Exits the error log screen sub menu.

Item	Setting														
F3: CLIP FLG	<p>Sets a clip flag for the clip being recorded or played back using the function button.</p> <p>If a clip flag is already set for the clip, "Marked" is displayed in the function menu item corresponding to one of the F1 to F3 buttons depending on the type of flag that has been set.</p> <p><i>A clip flag can also be set or deleted using the GUI screen. See page 80 for details.</i></p> <table border="1"> <thead> <tr> <th colspan="2">Sub-item</th> </tr> </thead> <tbody> <tr> <td>F1: OK</td> <td>Set an OK flag.</td> </tr> <tr> <td>F2: NG</td> <td>Set an NG flag.</td> </tr> <tr> <td>F3: KEEP</td> <td>Set a KEEP flag.</td> </tr> <tr> <td>F4:</td> <td>—</td> </tr> <tr> <td>F5: DELETE</td> <td>Delete the clip flag.</td> </tr> <tr> <td>F6: EXIT</td> <td>Exit the clip flag sub-menu.</td> </tr> </tbody> </table>	Sub-item		F1: OK	Set an OK flag.	F2: NG	Set an NG flag.	F3: KEEP	Set a KEEP flag.	F4:	—	F5: DELETE	Delete the clip flag.	F6: EXIT	Exit the clip flag sub-menu.
Sub-item															
F1: OK	Set an OK flag.														
F2: NG	Set an NG flag.														
F3: KEEP	Set a KEEP flag.														
F4:	—														
F5: DELETE	Delete the clip flag.														
F6: EXIT	Exit the clip flag sub-menu.														
F4: LIGHT	<p>Turns the control panel illumination LED on and off.</p> <p><b>OFF:</b> Off</p> <p><b>ON:</b> On</p>														
F5:	(Unassigned function button)														
F6:	(Unassigned function button)														

## Handling Discs

### Discs used for recording and playback

This unit can record and play back the following Professional Disc <sup>1)</sup> formats.

- PFD23A (capacity 23.3 GB)
- PFD50DLA (capacity 50.0 GB)

1) Professional Disc is a trademark of Sony Corporation.

#### Notes

- It is not possible to use the following discs for recording or playback:
  - Blu-ray Disc
  - Professional Disc for Data
- PFD50DLA discs can be used only by XDCAM devices with the DL mark (*see the following illustration*). They cannot be used by XDCAM devices without this mark.



### Notes on handling

#### Handling

The Professional Disc is housed in a cartridge, and is designed to allow handling free of risk from dust or fingerprints. However, if the cartridge is subjected to a severe shock, for example by dropping it, this can result in damage or scratching of the disc. If the disc is scratched, it may be impossible to record video/audio, or to play back the content recorded on the disc. The discs should be handled and stored carefully.

- Do not touch the surface of the disc itself within the cartridge.
- Deliberately opening the shutter may cause damage.
- Do not disassemble the cartridge.
- The supplied adhesive labels are recommended for indexing discs. Apply the label in the correct position.

#### Storage

- Do not store discs where they may be subjected to direct sunlight, or in other places where the temperature or humidity is high.
- Do not leave cartridges where dust may get inside.
- Store cartridges in their cases.

#### Care of the discs

- Remove dust and dirt on the outside of a cartridge using a soft dry cloth.

- If condensation forms, allow ample time to dry before use.

## Write-protecting discs

To protect the content recorded on the disc from accidental erasure, move the Write Inhibit tab on the lower surface of the disc in the direction of the arrow, as shown in the following figure.

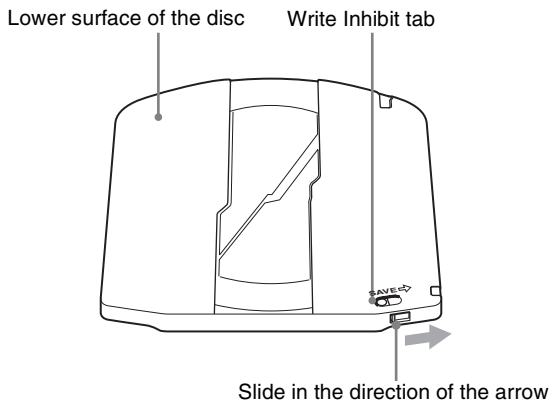

### Write Inhibit tab settings

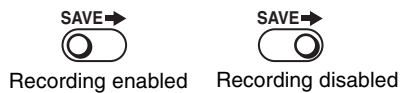

You can also write protect individual clips. For details, see “Locking (write-protecting) clips” (page 81).

## Loading and unloading a disc

When the indicator of the on/standby (I/⏻) switch is lit green, you can load and unload a disc as shown in the following figure.

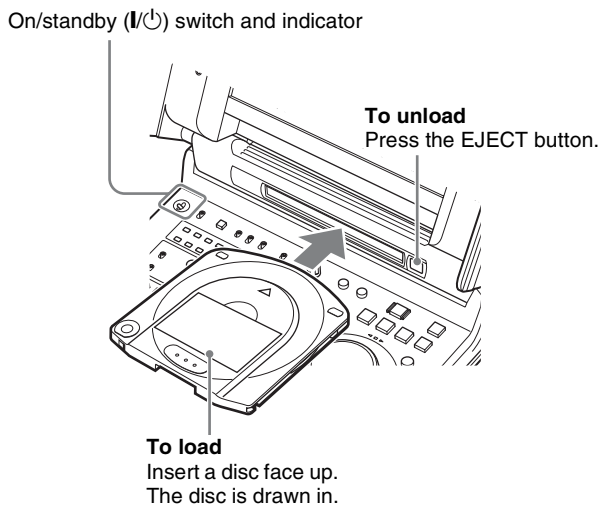

When the EJECT button is pressed during recording, recording stops and the disc is ejected. If you do not want to eject the disc and stop recording when the EJECT button is pressed during recording, set setup menu item 145 MODE KEY ENABLE DURING RECORDING to “stop”.

## Formatting a disc

Unused discs are formatted automatically when they are loaded into this unit.

To format a recorded disc, use the GUI screen.

For details, see “Formatting discs” (page 92).

## Recording

This section describes video and audio recording on the unit.

See page 49 “Basic Function Menu Operations” in Chapter 3 for more information.

See page 133 “Menus” in Chapter 8 for more information about setup menu operations.

### Mixed recording of clips in different formats on the same disc

As long as the frame frequency group is the same, clips in different recording formats can be recorded or written to the same disc.<sup>1)</sup>

In this manual, this is referred to as “mixed format recording mode”.

1) The recording format is regarded as different whenever the system frequency, video resolution, video codec/bit rate, or number of audio channels or number of bits does not match.

#### Notes

- Regardless of frame frequency group matching, it is not possible to mix clips with different video resolutions (number of system lines) in the same clip list.
- When the unit is in a mode that calls for playback across clips that were recorded in different recording formats, video and audio playback may stop at the point where the format changes from one format into another, and then start again.

#### Frame frequency groups

The system frequencies supported by this unit are divided into frame frequency groups, as shown in the following table.

Frame frequency group	System frequency
59.94 Hz	59.94P
	59.94i
	29.97P
50 Hz	50P
	50i
	25P
23.98 Hz	23.98P

You can record clips with different recording formats, for example HD422 and HD420SP clips, by putting this unit into mixed format recording mode.

#### To enable mixed format recording mode

Set maintenance menu item M390: MIXED REC to “ENABLE” (see page 158).

If you want to disable mixing of clips with different recording formats, leave this item set to “DISABLE”. However, regardless of the mixed format recording mode setting, it is always possible to mix clips in the following format groups.

- HD420 HQ, SP, and LP
- 1080/59.94i and 1080/29.97P
- 1080/50i and 1080/25P

### Preparations for recording

Make the following settings and adjustments before starting to record.

**Video input signal selection:** Select with V INPUT on page P1 VIDEO of the function menu.

**Audio input signal selection:** Select with A1 INPUT to A8 INPUT of sub-item AU INPUT on page P2 AUDIO of the function menu.

**Timecode and user bits settings:** See “Setting Timecode” (page 44).

**Selection of time data to display:** Select with CNTR SEL on HOME page of the function menu.

**Selection of audio channels to monitor:** Select with AUDIO MONITOR SELECT buttons.

**Volume adjustment of the monitor audio:** Adjust with the LEVEL knob.

**Remote/local setting:** Set the remote control switch. If you set it to REMOTE, also set setup menu item 214 REMOTE INTERFACE (“RM-” and the connector used appear on the system information of the display) (see page 143).

## SD up convert function

You can input SD signals to the SD/HDSDI INPUT connector and record them as HD signals.

## User data recording

You can record user data (files other than XDCAM AV files) on Professional Discs as PC data via the i.LINK or FTP interface.

This allows Professional Discs to be used as data recording media, with a data storage capacity of 46.4 GB (when dual-layer PFD50DLA discs are used).

## Carrying out recording

One recording segment (from the start to the end of recording) is called a “clip”.

See “Clips” (page 83) for more information about clips.

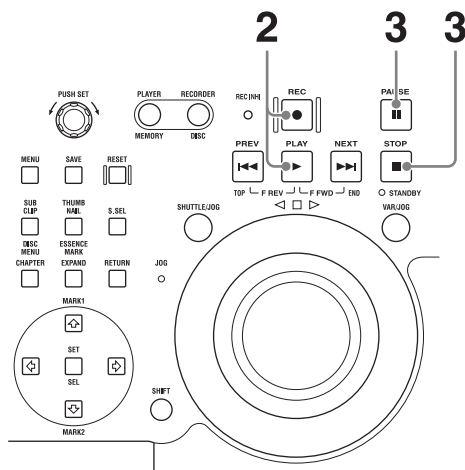

- 1 Insert a disc (see page 54).
- 2 Hold down the REC button, and press the PLAY button.  
Recording starts.
- 3 To stop recording, press the STOP button.  
To pause recording, press the PAUSE button.

During pause, press the PAUSE button again to resume recording.

### If the disc becomes full

Recording stops and the message “Disc Full!” appears on the monitor.

### Notes

- The shortest clip that can be recorded is 2 seconds long. Even if recording start and stop operations are performed within 2 seconds, a 2-second clip is recorded.
- The maximum number of clips that can be recorded is 300. If the loaded disc already contains 300 clips, recording operation is not possible. (The message “MAX # Clips” appears in the time data display area.)
- This unit can record video input signals that are not synchronized to a reference signal. However, in that case, video breakup and audio noise may occur in E-E playback.
- During recording, do not turn off the POWER switch on the connector panel or disconnect the power cord. This could cause the clip being recorded to be lost.

For details, see “Handling of discs when recording does not end normally (salvage functions)” (page 58).

## To adjust the audio recording levels

### When carrying out audio recording at a reference level

Set the VARIABLE/PRESET switch for recording to PRESET.

The audio signals will be recorded at a preset reference level.

You can change the reference level and the input levels with maintenance menu item M37: AUDIO CONFIG.

See page 161 for more information about how to make maintenance menu settings.

### Manually adjusting the audio recording levels

Set the VARIABLE/PRESET switch for recording to VARIABLE and adjust the ALL/CH-1 and CH-2 to CH-4 knobs so that the audio level indications on the audio level meters do not exceed 0 dB for a maximum volume. Carry out the adjustment in E-E mode.

See setup menu item 108 AUTO EE SELECT (page 141) for more information about the signal output settings in E-E mode.

## To set shot marks

A Shot Mark1 essence mark or Shot Mark2 essence mark is set if you hold down the ▲/MARK1 or ▼/MARK2 button and press the PUSH SET knob or the SET button during recording.



If the unit is set up to display superimposed text information (see page 47), “SHOTMARK1” or “SHOTMARK2” appears every time you set an essence mark.

When Shot Mark1 or Shot Mark2 essence marks are set, you can search for the shot marks by displaying thumbnails of the frames at those positions (see page 74). You can also use shot mark positions as edit points during scene selection operations (see page 83).

You can also set shot marks during playback. See page 61 for the procedure.

### To set a clip flag

You can set one of the three types of flag (OK, NG or KEEP) for the clip while it is being recorded by viewing its video image and using the function menu (see page 53).

You can also set a clip flag during playback. See page 62 for details.

You can also set a clip flag on the GUI screen. See page 80 for details.

## Continuing recording while exchanging discs (disc exchange cache function)

About 30 seconds (this duration may differ depending on the state of a disc) of video and audio data can be recorded to the unit’s internal memory cache during a disc exchange, and then written back to the newly loaded disc.

- 1 Check that the disc exchange cache indication is lit in the system information (see page 25) of the basic operation display.

- 2 If the disc exchange cache indication is not lit, set “DISC EXCHANGE” sub-item on setup menu item 150 to “on” (see page 142).

The setting of 150 REC MODE can be changed even during recording.

- 3 Exchange the disc.

During the period from the time when recording ends on the current disc and the disc is ejected until the time when the next disc is inserted, the unit records to its internal cache memory. Then, after the new disc is inserted, it copies the data from the cache to the disc and resumes normal recording.

During cache recording, a popup window appears to display the remaining capacity of the unit’s internal memory.

### “C” indications in superimposed text information and their meanings

Indication	Meaning
“C” flashes once per second	Recording to the cache
“C” flashes twice per second	Remaining memory capacity: Low
An alarm message appears instead of “C”.	Remaining memory capacity: None (disc full)

### To stop disc exchange cache recording

Do any of the following during cache recording.

- Press the STOP button.
- Set “DISC EXCHANGE” sub-item on setup menu item 150 to “off”.

### Notes

- If the disc becomes full while “DISC EXCHANGE” sub-item on setup menu item 150 is set to “on”, the disc is ejected and the unit continues to record to its internal memory (for about 30 seconds depending on the state of a disc).
- Recording and playback operations by all buttons and dials other than the STOP button are disabled during cache recording.
- If the amount of cache data exceeds the capacity of the unit’s internal memory during a disc exchange, an alarm message appears and the data in cache memory is overwritten. The internal memory always contains the latest cache data, so the clip data will be continuous after the next disc is inserted and recording to the disc resumes.
- If you insert a disc that cannot be recorded, it is ejected automatically. Insert a disc that can be recorded.

## Recording with the HDSDI remote control function

This section explains the settings required for recording in HDSDI remote control mode, and how the unit operates in this mode.

### Note

The unit (camcorder) that controls this unit must also support HDSDI remote output.

### Settings

Set setup menu item 214 REMOTE INTERFACE to “SDI”, and set the remote control switch on the control panel to “REMOTE”.

This unit enters HDSDI remote control mode, in which it is controlled by command packets received via the SD/HDSDI INPUT connector.

#### Note

The following limitations apply in HDSDI remote control mode.

- Commands received via the REMOTE(9P) connector are ignored.
- Recording and playback operations on the control panel are disabled, except for the EJECT button.

#### Monitor display in HDSDI remote control mode

“RM-SDI” appears in the remote interface display area (see page 25) of the monitor. This display lights if command packets are embedded into HDSDI signals, and flashes if they are not. However, the “RM-SDI” continues to flash until the time the controlling camcorder is powered on and the time that the REC button is pressed on the camcorder.

#### Recording operation

When a recordable disc is inserted, recording (or stop) is executed according to the REC (or STOP) command embedded into the HDSDI signals.

Recording stops automatically when the end of the disc is reached.

#### When HDSDI signals are interrupted during recording

Recording stops if HDSDI signals are interrupted during recording, for example because the HDSDI cable is disconnected or the controlling camcorder is powered off. When HDSDI signal input is restored, the unit resumes operation according to the embedded REC or STOP command.

#### Exchanging discs

Even during recording, it is possible to eject discs by pressing the EJECT button. After a disc is exchanged, the unit resumes operation according to the embedded REC or STOP command.

#### Note

This unit begins recording operation about one second after the camcorder.

### Recording with the Clip Continuous Rec function

Normally, a clip is generated as an independent file every time recording starts and stops. The Clip Continuous Rec function allows you to continue recording to the same clip until the function is stopped or turned off, regardless of how many times recording starts and stops. This is

convenient if you want to avoid generating a large number of short clips, or if you want to record without worrying about the limit on the number of clips (maximum 300). A Rec Start essence mark is recorded whenever recording starts, which makes it easy to find the recording start points (see page 75).

#### Note

A new clip may be created the next time you start recording if it is impossible to continue recording to the same clip because of signal noise or some other reason.

#### To enable the function

Set “CLIP CONTINUOUS” sub-item on setup menu item 150 to “on”.

#### To record

Hold down the REC button, and press the PLAY button.

#### To stop or restart recording

Press the PAUSE button.

#### To stop the function

Press the STOP button.

#### To turn the function off

Set “CLIP CONTINUOUS” sub-item on setup menu item 150 to “off”.

---

### Handling of discs when recording does not end normally (salvage functions)

Recording processing does not end normally if, for example, the POWER switch on the connector panel is turned off during recording, or if the power cord is disconnected during recording. Because the file system is not updated, video and audio data recorded in real time is not recognized as files and clip contents recorded up to that point are lost.

However, this unit has salvage functions which can hold losses to the minimum by reconstructing clips on such discs. There is a quick salvage function which executes automatically and a full salvage function which you can execute as required.

**Quick salvage:** Clips are reconstructed on the basis of backup data stored in nonvolatile memory and markers recorded on the disc. Processing time is about 5 seconds.

Quick salvage executes automatically if the unit is powered on with a disc still loaded after recording was interrupted by power off.

**Full salvage:** Clips are reconstructed on the basis of markers recorded on the disc. Nonvolatile memory

cannot be used, so processing takes longer than for a quick salvage (about 30 seconds, although it depends on the state of the disc).

You are prompted to execute a full salvage whenever you insert a disc that was removed manually from a powered off device after interruption of recording by power off.

Note that no recorded clip contents are lost when the on/standby (I/⏻) switch on the control panel is set to standby (⏻) during recording, because the unit does not enter standby mode until after the end of recording processing.

**Notes**

- Even after recording finishes, do not set the POWER switch on the connector panel to off until the ACCESS indicator has gone out.
- These functions salvage as much recorded material as possible after an unforeseen accident, but 100% restoration cannot be guaranteed.
- When recording on the PDW-HR1 does not end successfully, you can use another XDCAM system to perform a full salvage of the disc. As the other system, use the PDW-F1600, PDW-HD1500, PDW-F800, or PDW-700.
- The following alarm message (*see page 171*) may appear when you insert a disc:  
 “DISC CANNOT BE RECORDED. FORMAT DISC OR CONTACT SERVICE TO RUN CLIP SALVAGE PROGRAM. (XXXX)”

This message means that recording on that disc did not end normally. The “XXXX” in the message is a code for XDCAM devices that can salvage the disc. Refer to the following table and use one of the indicated devices to salvage the disc.

Code (XXXX)	Model
0002	PDW-1500/530/510/R1 PDW-F70/F350/F330
0200	PDW-F70/F350/F330 (Version 1.9 or higher) PDW-F75/F355/F335
0300 a)	PDW-HR1/HD1500/700
0301	PDW-HD1500/700/740 (Version 1.5 or higher) PDW-F1600/F800

a) Does not appear on this unit.

- Even when these functions are used, it is not possible to recover data from immediately before the interruption of recording. The amount of data lost is as follows.  
**Quick salvage:** From 2 to 4 seconds of data before the interruption of recording.  
**Full salvage:** From 4 to 6 seconds of data before the interruption of recording.

(More data may be lost when the unit is subject to vibrations, and when you switch frequently between recording and paused.)

- You are prompted to execute a full salvage every time you insert a disc that has not been salvaged, or power the unit on with such as disc loaded.
- No recording is possible on discs containing clips that have not been salvaged, although it is possible to play back the normally recorded sections. Recording becomes possible if you perform a quick format, but this erases all of the original recorded content.

**To restore clips with a full salvage**

- 1 Insert the disc on which recording did not end normally.

The message “Salvage ?” appears on the display.

**To cancel the clip salvage**

Press the RETURN button.

**Notes**

- The message “EJECT?” appears when “REC INHI” is displayed. If the disc is write protected, eject the disc, set the Write Inhibit tab to enable recording, and then insert the disc again. If REC INH on HOME page of the function menu is set to “ON”, set it to “OFF” (*see page 50*).
- This operation cannot be cancelled once it begins.

- 2 Press the PUSH SET knob.

Processing begins and the message “Executing.” appears.

When processing finishes, a message appears to display the results.

If the message reads “Incomplete!”, the clips that failed were lost.

# Playback

This section describes playback of video and audio on the unit.

Before starting playback, make the following settings and adjustments.

**Selection of time data to display:** Select with CNTR SEL on HOME page of the function menu.

**Selection of audio channels to monitor:** Select with AUDIO MONITOR SELECT buttons.

**Volume adjustment of the monitor audio:** Adjust with the LEVEL knob.

**Remote/local setting:** Set the remote control switch. If you set it to REMOTE, also set setup menu item 214 REMOTE INTERFACE (“RM-” and the connector used appear on the display (*see page 25*)).

## Clip playback modes

You can set the clip playback mode to either of the following.

**Continuous playback mode:** The playback target is all of the clips on the disc (factory default setting)

**Single clip playback mode:** The playback target is the currently selected clip only

### To select single clip playback mode

Set setup menu item 154 SINGLE CLIP PLAY MODE to “on”.

### Playback in single clip playback mode

Playback stops when it reaches the start or end of the clip. The next and preceding clips are not played, even if they exist on the disc. The available playback types include normal playback, high-speed playback in the forward or reverse directions, and jog, shuttle, and variable playback. To move to another clip, press the PREV, NEXT, SHIFT + PREV, or SHIFT + NEXT button, or perform a thumbnail search.

When the unit is set to repeat playback mode, the operation target of each playback mode is played repeatedly.

### To enable repeat playback mode

Set setup menu item 142 REPEAT MODE to “play”.

### Pull-down playback

When this unit’s system frequency is set to 1080/59.94i, 1080/29.97P, or 720/59.94P, clips recorded as 1080/23.98P are converted by 2-3 pull-down before playback (pull-down playback).

### Timecode in pull-down playback

During pull-down playback, timecode is also converted to 30 frames to match the output video signals.

The upper row of the time data display area displays the original 24-frame timecode, and the lower row displays the 30-frame timecode.

TC	00:59:59:23
PDT	00:59:59:29

You can superimpose the 30-frame timecode after pull-down on an external monitor. To do so, set setup menu item 005 DISPLAY INFORMATION SELECT to “time data only”.

TCR	00:59:59:23
PDT	00:59:59:29

## Disc playback start position

Although this unit uses optical discs, it is designed to offer the most convenient features of tape playback by VTRs. One of these is the playback start position, which works in the same way as tape, as described below.

### After playback stop

The unit stops at the position where the STOP button was pressed.

Press the PLAY button to resume playback at the stop position.

### After recording

The unit stops at the position where recording ended.

To play back a clip, press the PREV button to move to the start frame of any clip or press the PREV button with the PLAY button held down to move to any position.

### After disc insertion

The unit stops at the position of the disc when it was most recently ejected.

Press the PLAY button to resume playback at the most recent position.

The playback position is saved to the disc when the disc is ejected, which allows playback to start at that position whenever it is loaded into any XDCAM player.

### Note

This function is not available when the Write Inhibit tab of the disc is set to the recording disabled position, and when REC INH on HOME page of the function menu is set to “ON”.

The REC INHI indicator may light when neither of the above is true if the format of recorded sections on the disc is not the same as the recording settings of this unit. In this case, the playback position can be saved to the disc.

## 1080/720 cross convert function

You can output 720 while playing discs recorded as 1080, and output 1080 while playing discs recorded as 720. When the system frequency of the loaded disc (59.94i/59.94P/29.97P or 50i/50P/25P) matches the system frequency of the unit, but the system line settings (1080 or

720) do not match, then the formats before and after conversion appear in the HDS/SDI output conversion display (see page 28) and disc playback is cross converted automatically. E-E output is not cross converted.

## SD up convert function

You can output HD while playing discs recorded as SD.

## HD down convert function

You can always output SD while playing discs recorded as HD.

## To specify the frame to use as the thumbnail image

You can display a list of thumbnails of all clips on a disc, and use it to check the recorded content (see page 72).

When the unit is shipped from the factory, it is set up to display the first frame of each clip as the thumbnail. As required, you can select another frame to display as the thumbnail.

For example, if there are several seconds of color bars recorded at the start of the clip, selecting a frame several seconds after the end of the recording of color bars can make it easier to identify the clip.

The GUI screen allows you to select thumbnail frames while viewing the video.

For details, see “Changing clip index pictures” (page 77).

You can also use setup menu item 143 INDEX PICTURE POSITION to specify a different default frame. You can specify the initial frame in any of the first few seconds after the initial frame. The setting range is 0 seconds to 10 seconds.

## Playback operation

This section describes the following types of playback:

**Normal playback:** Playback at normal speed

**Playback in jog mode:** Variable-speed playback, with the speed determined by the speed of turning the shuttle/jog dial

**Playback in shuttle mode:** Variable-speed playback, with the speed determined by the angular position of the shuttle/jog dial

**Playback in variable-speed mode:** Variable-speed playback, with the speed finely determined by the angular position of the shuttle/jog dial

### Normal playback

First insert a disc.

For details of how to insert a disc, see “Loading and unloading a disc” (page 54).

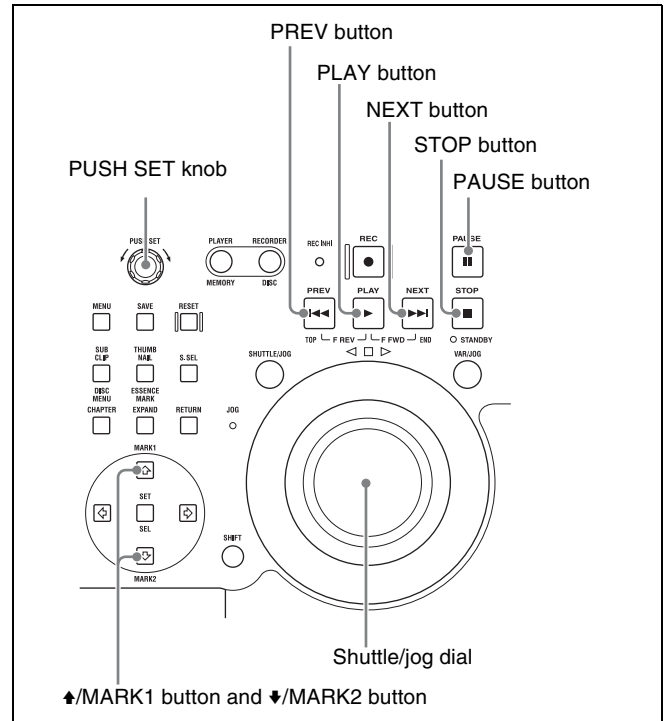

### To start playback

Press the PLAY button.

Playback starts.

When two or more clips are recorded on the disc, they are played back continuously.

### Note

No audio is output when non-audio signals are played back.

### To jump to the next or previous clip, then start playback

Use the PREV button, NEXT button, or shuttle/jog dial.

### To pause playback

Press the PAUSE button.

Press it again to resume playback.

### To stop playback

Press the STOP button.

If you play back to the end of the last clip, playback automatically stops.

If, in this state, you press the PLAY button, the message “Disc End!” appears on the display.

To carry out playback again, move back to the desired clip using the PREV button, or shuttle/jog dial.

### To set shot marks

While playing back a disc, you can set essence marks such as Shot Mark1 and Shot Mark2 in desired frames.

To set a Shot Mark1 or Shot Mark2, hold down the ▲/MARK1 or ▼/MARK2 button and press the PUSH SET knob or the SET button.

You can also delete and modify essence marks from the Thumbnail Menu of the chapter thumbnail screen (see page 74).

### To set a clip flag

You can set one of the three types of flag (OK, NG or KEEP) for the clip while it is being played back by viewing its video image and using the function menu (see page 53).

## Playback in jog mode

In jog mode, you can control the speed of playback by the speed of turning the shuttle/jog dial. The playback speed range is  $-1$  to  $+1$  times normal speed.

To carry out playback in jog mode, proceed as follows.

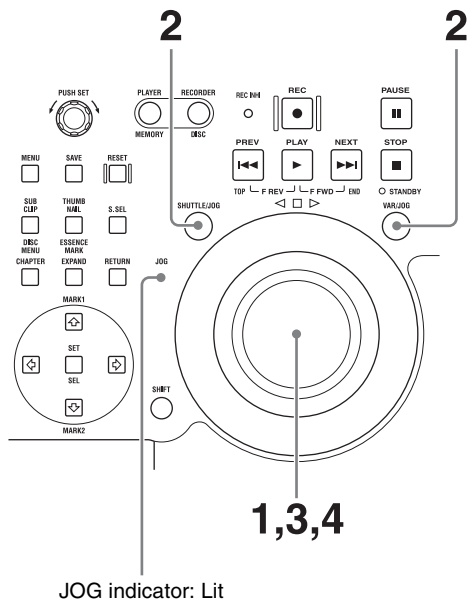

- 1** Press the shuttle/jog dial to light the JOG indicator.  
The shuttle/jog dial enters jog mode.
- 2** Press the SHUTTLE/JOG button or VAR/JOG button, turning it on.
- 3** Turn the shuttle/jog dial in the desired direction, at the speed corresponding to the desired playback speed.  
Playback in jog mode starts.
- 4** To stop playback in jog mode, stop turning the shuttle/jog dial.

When setup menu item 101 SELECTION FOR SEARCH DIAL ENABLE is set to “dial” (factory default setting), you can start jog playback by simply

rotating the shuttle/jog dial, even when the SHUTTLE/JOG and VAR/JOG buttons are not lit.

## Playback in shuttle mode

In shuttle mode, you can control the speed of playback by the angular position of the shuttle/jog dial. The range of playback speed is  $\pm 20$  times normal speed.

To carry out playback in shuttle mode, proceed as follows.

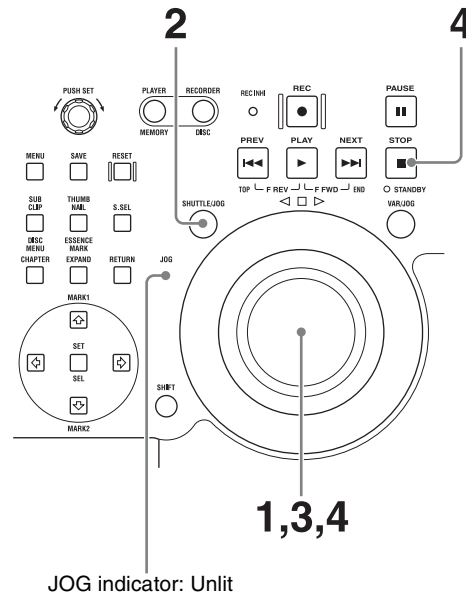

- 1** Press the shuttle/jog dial to turn off the JOG indicator.  
The shuttle/jog dial enters shuttle mode.
- 2** Press the SHUTTLE/JOG button, turning it on.
- 3** Turn the shuttle/jog dial to the desired angle corresponding to the desired playback speed.  
Playback in shuttle mode starts.
- 4** To stop playback in shuttle mode, return the shuttle/jog dial to the center position, or press the STOP button.

When setup menu item 101 SELECTION FOR SEARCH DIAL ENABLE is set to “dial” (factory default setting), you can start shuttle playback by simply rotating the shuttle/jog dial, even when the SHUTTLE/JOG button is not lit.

### To alternate between normal-speed playback and shuttle mode playback

Set the shuttle/jog dial to the position corresponding to the desired shuttle playback speed, then switch between normal-speed playback and shuttle playback by pressing the PLAY and SHUTTLE/JOG buttons alternately.

## Playback in variable-speed mode

In variable-speed mode, you can control the speed of playback in the range of -1 to +1 times normal speed. (You can use setup menu item 119 VARIABLE SPEED LIMIT IN KEY to specify the speed range of variable playback.) To carry out playback in variable-speed mode, proceed as follows.

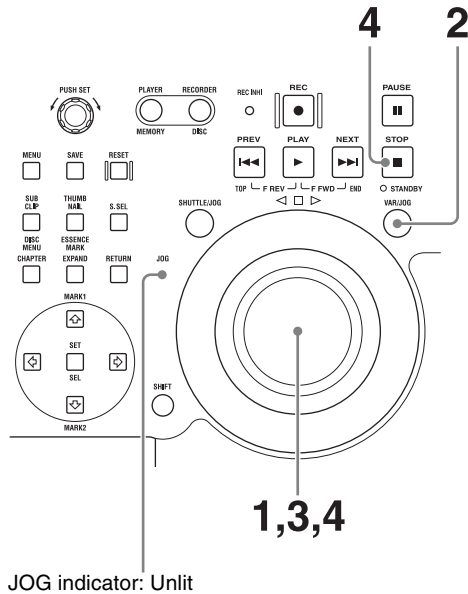

- 1** Press the shuttle/jog dial to turn off the JOG indicator.  
The shuttle/jog dial enters shuttle mode.
- 2** Press the VAR/JOG button, turning it on.
- 3** Turn the shuttle/jog dial to the desired angle corresponding to the desired playback speed.  
Playback in variable-speed mode starts.
- 4** To stop playback in variable-speed mode, return the shuttle/jog dial to the center position, or press the STOP button.

### To alternate between normal-speed playback and variable-speed mode playback

Set the shuttle/jog dial to the position corresponding to the desired variable playback speed, then switch between normal-speed playback and variable-speed mode playback by pressing the PLAY and VAR/JOG buttons alternately.

## Playback operations using thumbnails

Playback operations that you can perform with thumbnails include searching for clips, displaying clip information, playing clip lists created with the scene selection function,

and locking and deleting clip. This allows you to check the actual video as you work.

See “Thumbnail Operations” (page 72) for more information about thumbnail operations, and “Scene Selection (Clip List Editing)” (page 83) for more information about the scene selection function.

---

## Overview

You can perform scene searches, play the searched scenes, and select scenes (edit clip list) in Graphical User Interface (GUI) screens. The GUI screens are your gateways to discs and the data saved on discs.

(The GUI screens can display European languages, Japanese, Korean, Simplified Chinese, and Traditional Chinese for clip names and titles.)

---

## Switching between GUI screens

The most important GUI screens are:

**Clip thumbnail screen:** displays thumbnails of clips on the disc. “Clip” is displayed as the title at the upper left of the screen (*see page 65*).

**Clip list thumbnail screen:** displays thumbnails of sub clips in a clip list. “Clip List” is displayed as the title at the upper left of the screen (*see page 65*).

There are also two playback screens:

**Clip playback screen:** playback screen for normal video

**Clip list playback screen:** playback screen for clip list video

You will use the THUMBNAIL/ESSENCE MARK button **1** and the SUB CLIP/DISC MENU button **2** to switch between these four screens. Each press of these buttons switches between the screens as shown in the following figure. The THUMBNAIL and SUB CLIP/DISC MENU buttons light as follows, according to the type of screen that is currently displayed.

### Note

To switch between these four screens, a disc with recorded clips must be loaded in the unit.



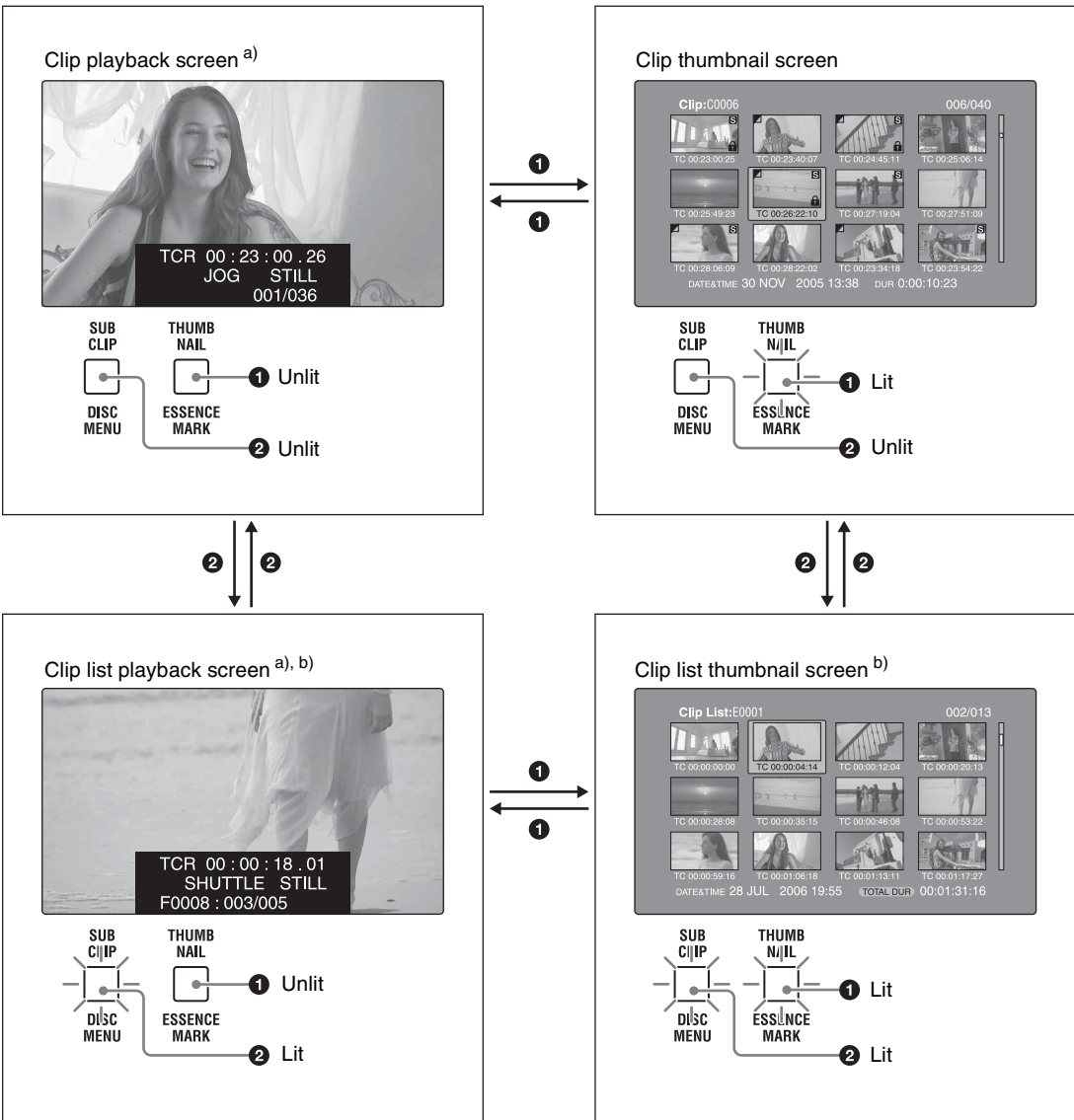

a) Playback screens appear when you switch to video monitor display. Use the DISPLAY button to switch from the basic monitor display to video monitor display (see page 24).  
 b) The clip list playback screen appears when a clip list is loaded into the unit's memory (see page 89).

- The other thumbnail screens are:
- Expand thumbnail screen
  - Chapter thumbnail screen
  - Essence mark thumbnail screen

## Information and controls in thumbnail screens

### About the display of clip and clip list names

You can specify that titles should appear instead of names in the clip name areas of thumbnail screens. You can also change the display language.

To specify that titles, if they exist, should be displayed with higher priority than names, select one of the following under Settings >Display Title in the Disc Menu.  
**On: Title1 "title1":** Display in the order title1, title2, clip or clip list name.  
**On: Title2 {title2}:** Display in the order title2, title1, clip or clip list name.

To change the display language according to the area of use (see page 35), select the desired language under Settings >Select Font in the Disc Menu.

Area of use setting	Select Font setting	Displayable languages
J (for Japan)	—	English/Japanese

Area of use setting	Select Font setting	Displayable languages
UC (for regions outside Japan)	European Alphabet	English/European languages
	Korean	English/Korean
	Simplified Chinese	English/Simplified Chinese
	Traditional Chinese	English/Traditional Chinese

## Clip thumbnail screen

This screen displays thumbnails of clips on the disc in the order that they were recorded. You can use this screen to work with clips – deleting or locking them, selecting their index pictures, adding them to clip lists, and so on.

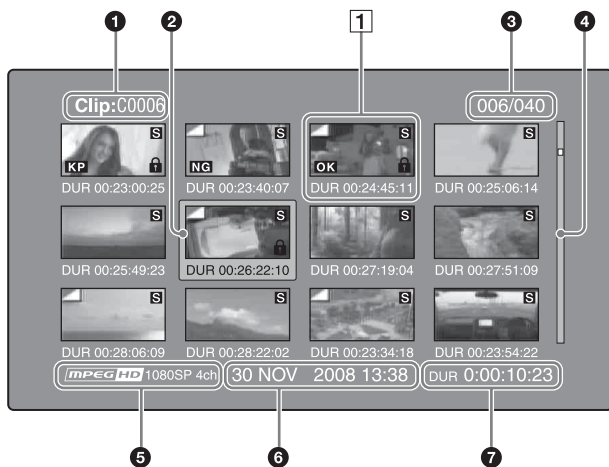

### 1 Clip name

Displays the name or a title of the selected clip (*see page 65*).

### 2 Selection frame

Indicates that the thumbnail is selected. To select another thumbnail, move the frame (*see page 71*). Multiple selection frames appear when multiple thumbnails are selected (*see page 71*).

### 3 Clip number/total number of clips

Displays the total number of clips on the disc, and the number of the selected clip.

### 4 Scrollbar

When not all of the thumbnails can be displayed in the thumbnail display area, the position of the slider shows the relative position of the currently displayed clips, and the length of the slider shows the relative length of currently displayed clips within all of the clips.

When you have a large number of thumbnails, you can save time by using the Skip Scroll function to jump directly to the thumbnail you want (*see page 72*).

### 5 Recording format

The recording format of the selected clip is displayed as a combination of the following information.

- Video format logo
- Number of system lines
- Recording quality
- Number of audio channels

### 6 Clip date and time

Displays the date and time when the selected clip was shot and recorded.

### 7 Duration

Displays the duration (recording time) of the selected clip.

## 1 Thumbnail display items

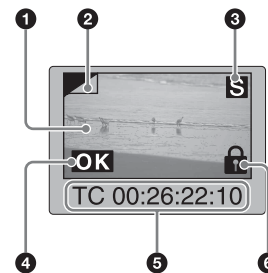

### 1 Index picture

Displays an image to stand for the content of the clip. The index picture is normally the first frame of the clip.

### 2 Index picture changed mark

This mark, like the folded-over corner of a page that you want to remember, appears when the index picture has been changed to any frame other than the first frame of a clip (*see page 77*).

### Note

When you cue up a clip, the unit always cues up the first frame, even when the index picture has been changed to a different frame.

### 3 S mark

This mark appears when shot marks or multiple Rec Start essence marks have been set in the clip (*see page 56*). The chapter thumbnail screen can be displayed for clips that show this mark (*see page 67*).

### 4 Clip flag icon

Displays the corresponding icon when a clip flag (OK/NG/KP (KEEP)) is set in the clip.

### 5 Clip and frame information

Displays the clip or frame information selected with the Clip Information item in the Thumbnail Menu (*see page 77*). The factory default selection is the timecode of the first frame or the timecode of the thumbnail frame.

## 6 Lock icon

This icon appears when the clip is locked (protected) (*see page 81*). Clips cannot be deleted and their clip information cannot be changed when this mark is displayed.

## Clip list thumbnail screen

This screen displays thumbnails of the clips in the current clip list. You can use this screen to create and edit clip lists.

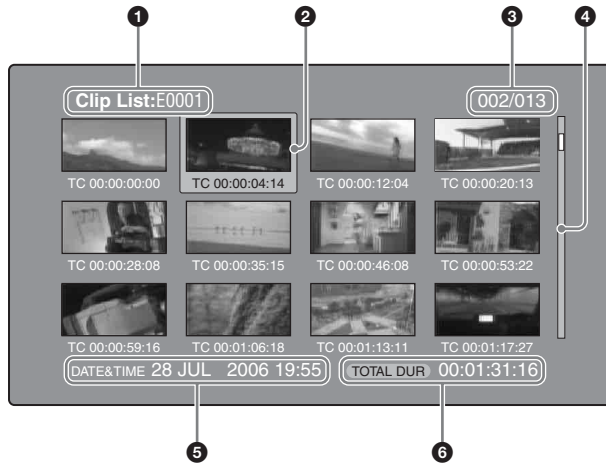

### 1 Clip list name

Displays the name or a title of the clip list (*see page 65*).

### 2 Selection frame

*See the description in “Clip thumbnail screen” (page 66).*

### 3 Sub clip number/number of sub clips

Displays the total number of sub clips in the clip list, and the number of the selected sub clip.

### 4 Scrollbar

*See the description in “Clip thumbnail screen” (page 66).*

### 5 Clip list date and time

Displays the date and time when the clip list was created, or the date and time of its most recent modification. An asterisk (\*) appears after the date and time of creation when the current clip list has not been saved to the disc.

## Notes

- “New File” appears when no clip list has been loaded into the unit’s memory, and when a clip list has been cleared from the unit’s memory.
- A  mark appears before the date of creation or modification when a disc is write protected, or when REC INH on HOME page of the function menu is set to “ON”. You can create clip lists when the unit is in this state, but you cannot save them.

## 6 Total duration

Displays the total duration of all sub clips in the clip list.

## Expand thumbnail screen

This screen displays thumbnails of equally sized divisions of the selected clip.

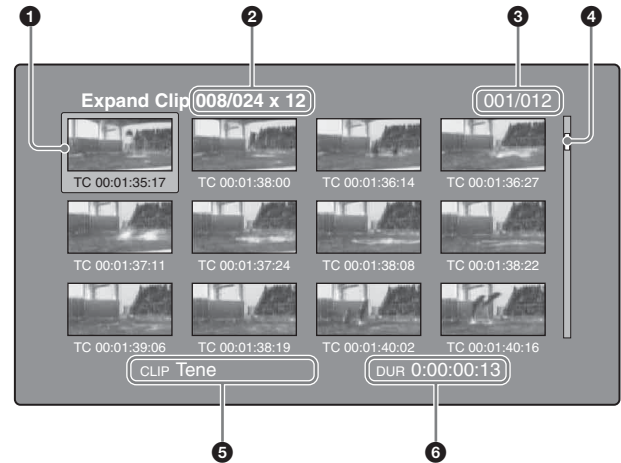

### 1 Selection frame

*See the description in “Clip thumbnail screen” (page 66).*

### 2 Clip number/total clips × number of divisions

Displays the number of the selected clip, the total number of clips on the disc, and the number of times that the selected clip has been divided to display the expansion thumbnails.

### 3 Thumbnail number/total thumbnails

Displays the total number of expanded thumbnails and the number of the selected thumbnail.

### 4 Scrollbar

*See the description in “Clip thumbnail screen” (page 66).*

### 5 Clip name

Displays the name or a title of the expanded clip (*see page 65*).

### 6 Duration

Displays the time from the selected thumbnail to the next one.

## Chapter thumbnail screen

The sections between shot mark and Rec Start essence marks in clips are called chapters. This screen allows you to display thumbnails of the chapters in the selected clip.

**Note**

Shot marks can be set during recording and playback. They can be deleted and moved.

Rec Start essence marks are set automatically at the start of recording. They cannot be deleted or moved.

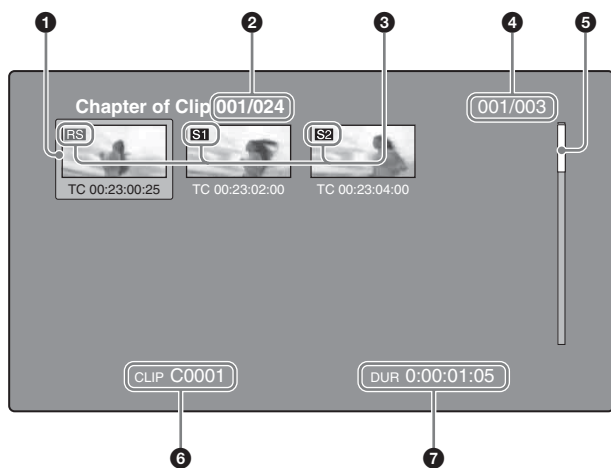
**1 Selection frame**

See the description in “Clip thumbnail screen” (page 66).

**2 Clip number/total clips**

Displays the total number of clips on the disc and the number of the clip that contains the displayed chapters.

**3 S1/S2/RS marks**

The “S1”, “S2”, and “RS” marks on the thumbnails indicate frames where Shot Mark1, Shot Mark2, and Rec Start essence marks are set.

**4 Chapter number/total chapters**

Displays the total number of chapters and the number of the selected chapter.

**Note**

The total number of chapters is the total number of chapters in the specified clip only.

**5 Scrollbar**

See the description in “Clip thumbnail screen” (page 66).

**6 Clip name**

Displays the name or a title of the clip whose chapter is displayed (see page 65).

**7 Duration**

Displays the time from the first frame of the selected chapter to the first frame of the next chapter.

**Essence mark thumbnail screen**

This screen displays thumbnails of the specified essence mark, found by searching all clips on the disc.

**1 Essence mark name**

Displays the name of the essence mark (Shot Mark1 here).

**2 Selection frame**

See the description in “Clip thumbnail screen” (page 66).

**3 Essence mark number/total essence marks**

Displays the total number of essence marks and the number of the selected essence mark.

**Note**

The total number of essence marks is the total number of essence marks that have been set in all clips on the disc.

**4 Scrollbar**

See the description in “Clip thumbnail screen” (page 66).

**5 Clip date and time**

Displays the date and time when the clip that contains the selected thumbnail was recorded or last modified.

**6 Clip name**

Displays the name or a title of the clip that contains the selected frame (see page 65).

**Displaying menus****Thumbnail Menu**

The Thumbnail Menu displays menu items that are valid for the currently displayed thumbnail screen.

### To display the Thumbnail Menu

To display the Thumbnail Menu, press the MENU button with a thumbnail screen displayed. To return to the original screen, press the MENU button again, or press the RETURN button.

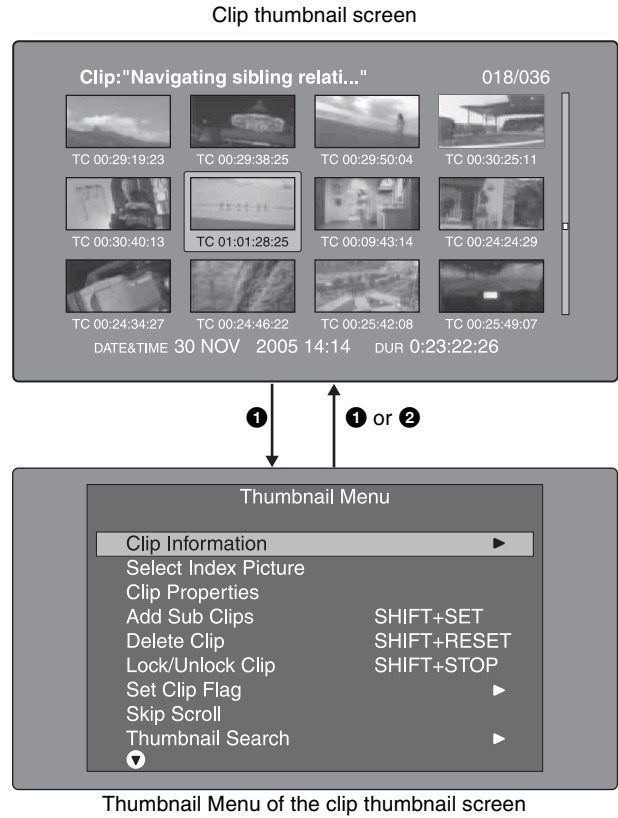
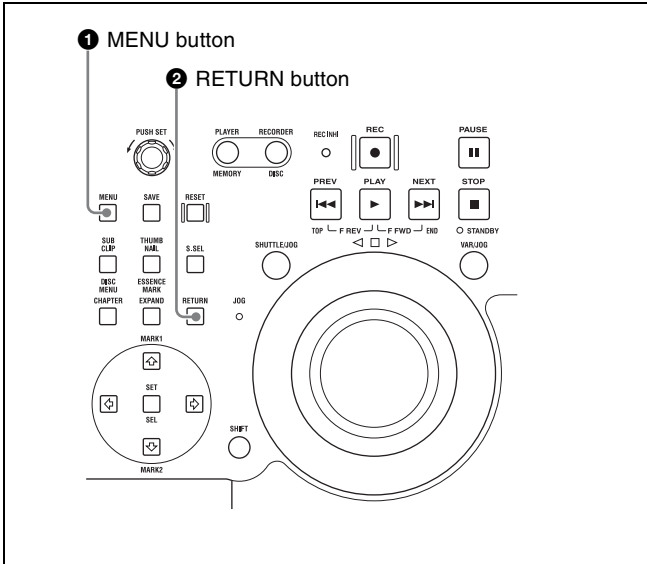

### Shortcut operations

Shortcut button names are displayed next to the menu items of commands that have shortcuts (*see page 101*).

#### Note

Shortcuts displayed within parentheses should be used with all menus closed.

### Thumbnail Menu submenus

- The Thumbnail Search Menu contains the basic commands for thumbnail searches.
- The Thumbnail View Menu contains the basic commands for moving to other menus.

### Disc Menu

The Disc Menu allows you to do the following. (Underlined values in the Operation/Setting column are the factory defaults.)

Item	Operation/Setting
Load Clip List	Load clip list into this unit's memory.
Save Clip List	Save a clip list on the disc under its current name, overwriting the old contents.
Save Clip List as...	Save a clip list on the disc under a new name.
Delete Clip List	Delete a clip list from the disc.
Clear Clip List	Clear the current clip list from the unit's memory.
Load Planning Metadata/Select Drive	Select a media disc or drive and load planning metadata into this unit's memory.

Item	Operation/Setting
Planning Metadata Properties	Display the properties of the currently loaded planning metadata.
Clear Planning Metadata	Clear the currently loaded planning metadata from the unit's memory.
Lock or Delete All Clips	<b>Sub-item</b>
	Lock All Clips Lock all clips.
	Unlock All Clips Unlock all clips.
	Delete All Clips Delete all clips.
Delete All Voice	Delete all voice data. <b>Note</b> This appears when the PDBZ-UPG03 Software Upgrade Key or PDBK-MK1 option board is installed.
Disc Properties	Display the properties of the currently loaded disc. Or edit the user disc ID, title, and title 2.
Format Disc	Format (initialize) the currently loaded disc.
Settings	<b>Sub-item</b>
	SET Key on Thumbnail Selects the behavior of the unit when the PUSH SET knob is pressed with one thumbnail selected. <b>Cue up &amp; Still:</b> Cue up the selected thumbnail. <b>Cue up &amp; Play:</b> Cue up and play the selected thumbnail.
	Sort Clip List by... Selects a method to sort the clip list. <b>Name (A-Z):</b> Sort in ascending alphabetic order. <b>Date (Newest First):</b> Sort by date and time of creation, newest clip list first.
	Sort Planning Metadata by... Selects a method to sort the planning metadata. <b>Name (A-Z):</b> Sort in ascending alphabetic order. <b>Date (Newest First):</b> Sort by date and time of creation, newest planning metadata first.
	Display Title Selects whether to display clip and clip list titles. <b>On: Title1 "title1":</b> Display the title in the following order of priority: Title1, Title2, Clip name or Clip list name. <b>On: Title2 {title2}:</b> Display the title in the following order of priority: Title2, Title1, Clip name or Clip list name. <b>Off:</b> Do not display the title. Always display the clip name or clip list name.
	Planning Clip Name in Clip Info. Area Selects whether to display in the video monitor screen the title contained in a planning metadata file that is loaded into this unit. <b>Off:</b> Do not display title. <b>ASCII Clip Name:</b> Display title in ASCII format. <b>Clip Name:</b> Display title in UTF-8 format.
	Setting Format Disc Selects whether to disable the Format Disc command. <b>Disable:</b> Disable the command. <b>Enable:</b> Enable the command.
	Select Font Selects the language (font) used to display clip names, clip list names, and title2 clip titles.
	Select USB Keyboard Language Selects a language of the USB keyboard used on the software keyboard.
	Select Mouse Pointer Speed Selects the speed of the USB mouse pointer used on the software keyboard from the following values. 5 Fast/4/3 Middle/2/1 Slow

### To display the Disc Menu

To display the Disc Menu, press the SUB CLIP/DISC MENU button with the SHIFT button held down in one of the following screens.

- Clip thumbnail screen
- Clip list thumbnail screen
- Clip playback screen

- Clip list playback screen

To return to the original screen, press the RETURN button.

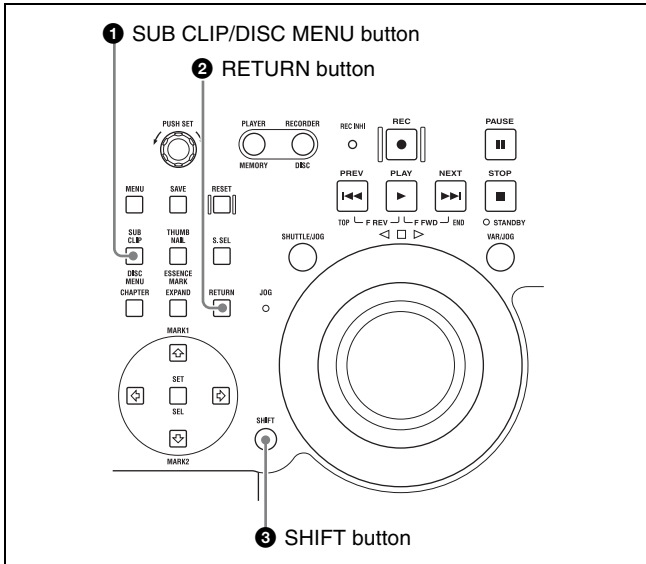

Clip list thumbnail screen

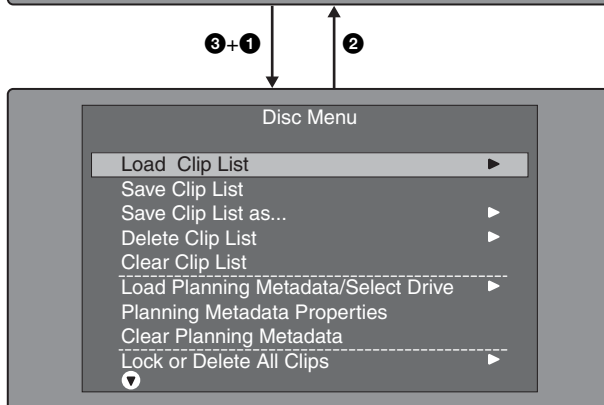
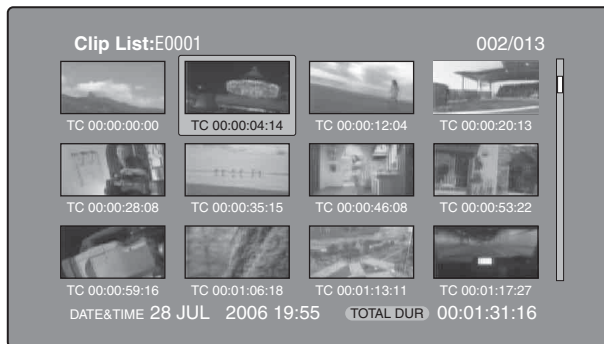

## GUI screen operations

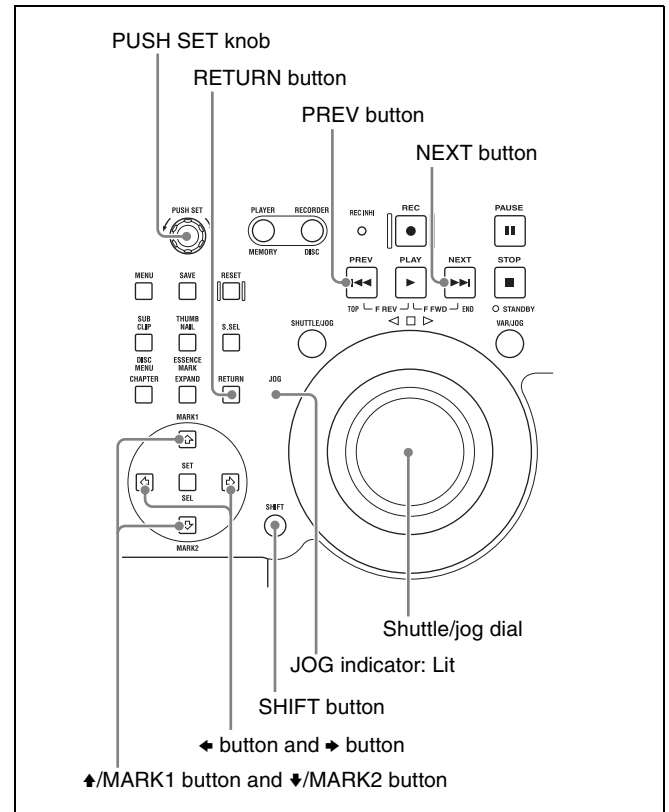

### To select items

Do one of the following to select thumbnails, menu items, timecode digits, and other items.

- Turn the PUSH SET knob.
- Put the shuttle/jog dial into jog mode (JOG indicator: lit), and then turn the dial.
- Press the ▲/MARK1, ▼/MARK2, ◀ or ▶ button.
- Press the PREV or NEXT button.
- With the SHIFT button held down, press the PREV or NEXT button (to move to the first or last item).
- With the SHIFT button held down, press the ▲/MARK1 or ▼/MARK2 button (to move to the previous or next page).

### To select multiple thumbnails

Do one of the following

- Turn the PUSH SET knob with the SHIFT button held down.
- With the SHIFT button held down, press the ◀ or ▶ button.

### To return to the previous screen

Press the RETURN button.

## To move from a menu level to the next lower or higher menu level

For a menu item displayed together with ◀ or ▶, you can move to the next lower or higher menu level by pressing the ◀ or ▶ button.

## To scroll hidden parts of the string into view

When a ◀ or ▶ mark is displayed for an item, you can press the ◀ or ▶ button to scroll the display by one character for each press.

The ▲/MARK1 and ▼/MARK2 buttons scroll the beginning and end of the string into view.

## To increment and decrement numbers

Do one of the following.

- Press the ▲/MARK1 or ▼/MARK2 button.
- Turn the PUSH SET knob.
- Put the shuttle/jog dial into jog mode (JOG indicator: lit), and then turn the dial.

## To confirm selections

Press the PUSH SET knob.

# Thumbnail Operations

You can use thumbnail screens to display clip information and to find, protect, and delete clips. The thumbnails provide visual confirmation of these and other operations.

## Selecting thumbnails

The thumbnail selection frame (*see page 66*) indicates the currently selected thumbnail.

## To move the thumbnail selection frame

Turn the PUSH SET knob.

## To skip quickly through thumbnails (Skip Scroll function)

When you have a large number of thumbnails, like in expand thumbnail screen, you can use the Skip Scroll function to skip through them quickly.

*See page 71 for more information about operations in thumbnail screens.*

- 1 In the screens like clip thumbnail screen or expand thumbnail screen, display the Thumbnail Menu.
- 2 Select Skip Scroll, and then press the PUSH SET knob.

A small popup window appears on the scrollbar to indicate the position of the currently selected thumbnail within the set of all thumbnails.



- 3 Turn the PUSH SET knob.

The current position moves by an amount equal to  $\frac{1}{10}$  of the total number of thumbnails.



### When you reach a point that is close to the thumbnail you want

Put the shuttle/jog dial into jog mode (JOG indicator: lit), and then turn the dial to move the selection frame in units of 1 thumbnail.

- 4 Press the PUSH SET knob at the new position.

The thumbnail at the position indicated in the small popup window appears in a thumbnail screen like the following <sup>1)</sup>.



1) Expand thumbnail screen

### To select multiple thumbnails

Move the selection frame to the first thumbnail that you want to select. Then, with the SHIFT button held down, turn the PUSH SET knob.

To cancel the multiple selection, move the selection frame without the SHIFT button held down.



## Searching with thumbnails

By using the thumbnails that appear in the various thumbnail screens, you can easily cue up and play clips and sub clips.

### Using thumbnails to find clips

The clip thumbnail screen displays thumbnails of all clips recorded on the disc. You can use this screen to cue up the selected clip and to carry out playback (*see page 75*).

*See “Selecting thumbnails” (page 72) for more information.*

### Using the expand function to find scenes

The expand function allows you to divide a selected clip into equally sized blocks, and to display thumbnails of the first frame in each block. This is a quick and efficient way to review the selected clip and search for target scenes.

You can specify 12, 144, or 1728 divisions.



#### Note

The maximum number of blocks may be other than 1728 when the recorded duration of the clip is short. In this case, the frame interval of expanded thumbnails is fixed at 1 frame. This allows you to view expanded thumbnails at equal intervals.

*See page 71 for more information about thumbnail screen operations.*

- 1 In the clip thumbnail screen, select the thumbnail of the clip that contains the scene you want to find.

- 2 Press the EXPAND button.

The selected clip is divided into 12 blocks, and a list appears in the expand thumbnail screen (*see page 67*) with the first frame of each block displayed as a thumbnail.

- 3 Select the thumbnail that you want to expand further.

- 4 Repeat steps 2 and 3 up to 2 times, as required.

#### Note

Thumbnails cannot be further expanded when they already have the minimum duration (1 frame).

### To return to the previous expansion level

Press the EXPAND button with the SHIFT button held down.

### To display the expand thumbnail screen of the previous or next clip

With the expand thumbnail screen still active, press the PREV button or the NEXT button.

## Using the chapter function to find scenes

Sections between shot marks and Rec Start are called chapters.

Rec Start essence marks are set automatically at the start of recording, but shot marks can be set at any scene during recording or playback.

The chapter function allows you to display thumbnails of the chapters in a clip.

See “To set shot marks” (page 56) for more information.

See page 71 for more information about thumbnail screen operations.

- 1 In the clip thumbnail screen, select the thumbnail of a clip with chapters set.

The “S” mark appears on the thumbnails of clips with chapters set.

- 2 Press the CHAPTER button.

The chapter thumbnail screen (see page 67) appears, with thumbnails of the frames where chapters are set.

The “S1”, “S2”, and “RS” marks on the thumbnails indicate frames where Shot Mark1, Shot Mark2, and Rec Start essence marks are set.

### To delete the shot mark at a chapter position

You can delete the shot mark (Shot Mark1 or Shot Mark2) at the chapter position in the chapter thumbnail screen. (Rec Start cannot be deleted.)

- 1 In the chapter thumbnail screen, select the thumbnail for the frame whose shot mark you want to delete.
- 2 Display the Thumbnail Menu.
- 3 Select Delete Shot Mark.

A message appears asking if you are sure that you want to delete the shot mark.

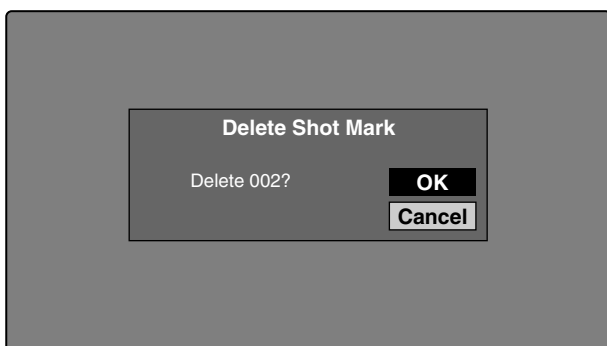

- 4 Select OK to delete the mark, or Cancel to cancel the deletion, and then press the PUSH SET knob.

## To adjust the position of shot marks at chapter positions

You can use the chapter thumbnail screen to adjust the position of shot marks (Shot Mark1 and Shot Mark2) at chapter positions. (The positions of Rec Start essence marks cannot be adjusted.)

- 1 In the chapter thumbnail screen, select the thumbnail of the shot mark whose position you want to adjust.
- 2 Display the Thumbnail Menu.
- 3 Select Move Shot Mark.

The Move Shot Mark screen is displayed.

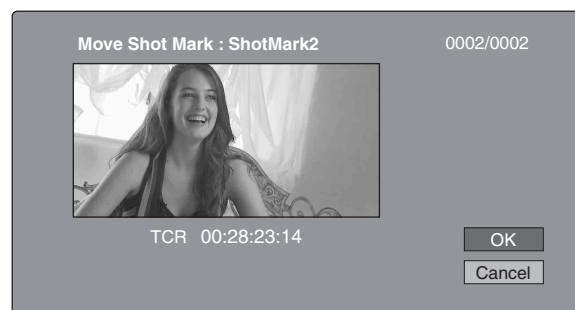

You can perform playback and searches in this screen.

- 4 Use the PLAY button or the shuttle/jog dial in jog mode (JOG indicator: lit) to display the frame you want.
- 5 Select OK, and then press the PUSH SET knob.

### To display the chapter thumbnail screen of the previous or next clip with chapters

With the chapter thumbnail screen still active, press the PREV button or the NEXT button.

The unit searches in the reverse or forward direction for the next clip with chapters, beginning with the previous or next clip.

## Using essence marks to find scenes

See page 71 for more information about thumbnail screen operations.

- 1 In the clip playback screen or the clip thumbnail screen, press the THUMBNAIL/ESSENCE MARK button with the SHIFT button held down.

The Select Essence Mark screen appears.

The names of essence marks that are not recorded on the disc are displayed in gray.

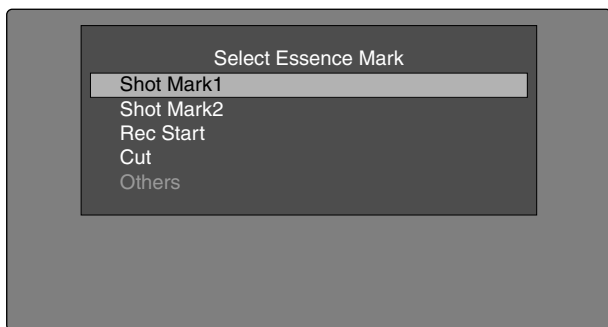

- 2 Select the essence mark that you want, and then press the PUSH SET knob.

The essence mark thumbnail screen displays a list of frames where the selected essence mark is set.

### To switch directly to the Rec Start essence mark thumbnail screen

Before starting, set setup menu item 153 FIND MODE to “clip & rec start mark”.

By pressing the DISPLAY button in the clip thumbnail screen, you can switch directly to the Rec Start essence mark thumbnail screen. As long as the setting of setup menu item 153 does not change, the DISPLAY button switches between the clip thumbnail screen and the Rec Start essence mark thumbnail screen.

This setting allows you to use the DISPLAY button as a shortcut to Rec Start essence mark thumbnail screen, which is convenient for checking start points in clip recorded with the Clip Continuous Rec function. Also, when the Rec Start essence mark thumbnail screen is displayed, each press of the THUMBNAIL button switches between that screen and the clip playback screen (Resume function). In the clip playback screen, the PREV and NEXT buttons jump to the previous or next recording start points.

#### Note

The DISPLAY button does not switch to the Rec Start essence mark thumbnail screen from the expand thumbnail screen or the chapter thumbnail screen.

## Playing the scene you have found

After finding a clip with one of the methods explained in the previous section, “Searching with thumbnails” (*see page 73*), you can cue up and play the clip that you have found.

### To search for a thumbnail position and cue it up

*See page 71 for more information about GUI screen operations.*

- 1 Select the thumbnail that you want to cue up.

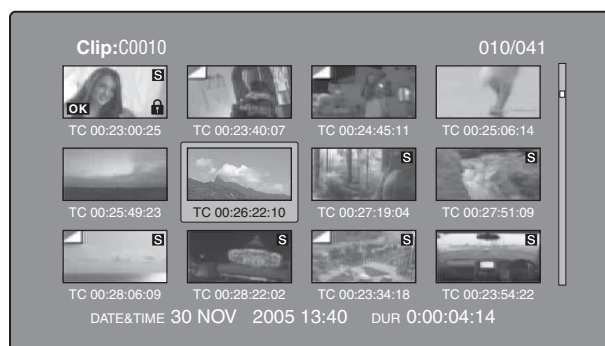

- 2 Press the PUSH SET knob.

### To play clips with the PUSH SET knob

In the Disc Menu, set Settings >SET Key on Thumbnail to “Cue up & Play”. Playback begins from the selected frame when you press the PUSH SET knob, in the same way as when you press the PLAY button.

### To search for a thumbnail position and play from there

*See page 71 for more information about GUI screen operations.*

- 1 Select the thumbnail that you want to play.
- 2 Press the PLAY button.

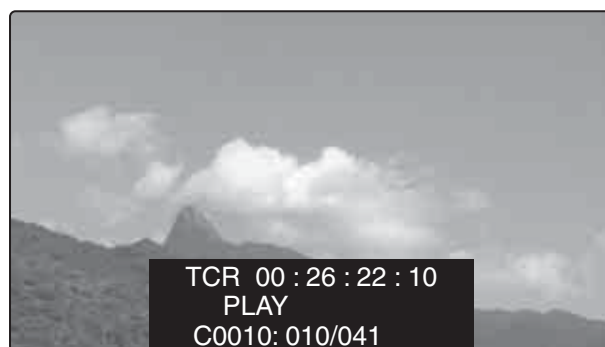

## Selecting clips by type (Filter Clips function)

You can select clips of a certain type from among all of the clips on a disc (Filter Clips function). For example, you can do the following.

- Select clips in a certain video format from a disc that contains clips in different video formats.
- Select clips that have been set “NG” as a clip flag, and delete all of those clips in one operation.
- Select only clips that have been recorded on the basis of a specified planning metadata entry, and transfer those

clips to an external device using the Direct FTP function (see page 95).

## To filter clips

See page 71 for more information about GUI screen operations.

- 1 Display the clip thumbnail screen.
- 2 If you want to select clips by video format, select the thumbnails of clips in that format.
- 3 Display the Thumbnail menu.
- 4 Select “Filter Clips”, and then press the PUSH SET knob.

The Filter Clips screen appears.

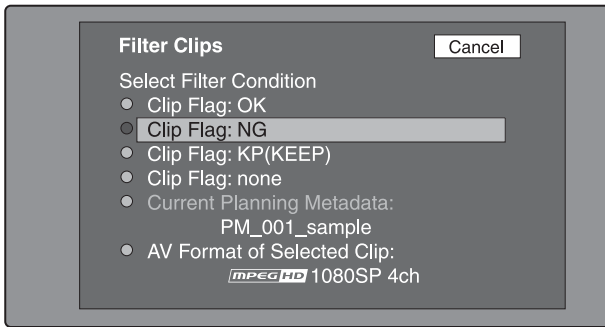

- 5 Select the clip filtering condition.

Item name	Filtering condition
Clip Flag: OK	Clip flag set in the clip (OK/NG/KP(KEEP)/none)
Clip Flag: NG	
Clip Flag: KP(KEEP)	
Clip Flag: none	
Current Planning Metadata	Clips that have been recorded according to the instructions in the currently loaded planning metadata
AV Format of Selected Clip	Video format of the selected clips

- 6 Press the PUSH SET knob.

A filter thumbnail screen appears, showing only clips that meet the specified condition. The filtering condition appears at the lower left of the screen.

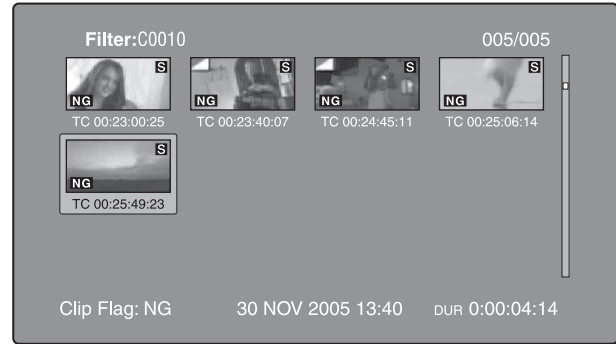

- 7 If you want to filter the clips again with a different filtering condition (to narrow down the filtering results), repeat steps 2 to 6. (The command name selected in step 4 changes to Filter Clips(Narrowing).)

## To play selected clips continuously

Register all of the filtered clips in an automatically generated clip list, and play the clip list.

- 1 Display the Thumbnail Menu in the filter thumbnail screen.
- 2 Select “Copy to Clip List”, and then press the PUSH SET knob.

A clip list thumbnail screen appears, showing filtered clips that have been registered in the clip list.



- 3 Press the PLAY button.

The screen changes to the clip playback screen, and playback starts.

## Operations on filtering results

You can use the Thumbnail Menu in the filter thumbnail screen to perform the following operations.

Item name	Function
Clip Information	Select the information to be displayed at the bottom of the thumbnails.
Lock or Delete All Filtered Clips >Lock All Filtered Clips	Lock all of the filtered clips.

Item name	Function
Lock or Delete All Filtered Clips >Unlock All Filtered Clips	Unlock all of the filtered clips.
Lock or Delete All Filtered Clips >Delete All Filtered Clips	Delete all of the filtered clips.
Filter Clips(Narrowing)	Narrow down the filtering results.
Copy to Clip List	Copy all of the filtered clips to a new clip list.
Upload Clips via Direct FTP	Transfer all of the filtered clips to an external device via a network.

### To display clip filtering conditions as Title2 titles

For clip lists created with the Copy to Clip List command, you can display the clip filtering conditions as Title2 titles. When Settings >Display Title in the Disc Menu is set to “On: Title2 {title2}”, the clip filtering conditions are displayed automatically in screens such as the Load Clip List screen.

## Selecting the information displayed on thumbnails

You can select the information to be displayed at the bottom of the thumbnails in thumbnail screens.

See page 71 for more information about thumbnail screen operations.

- 1 Display the Thumbnail Menu in the clip thumbnail screen.
- 2 Select Clip Information.

A window appears in which you can select the information to display.

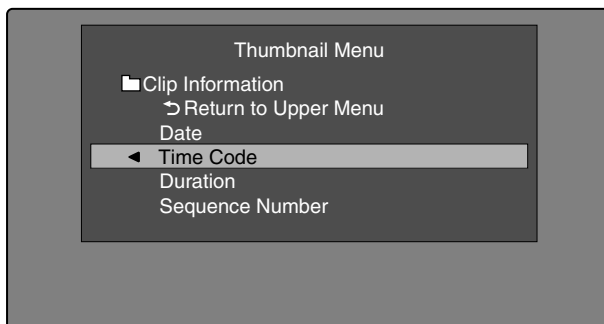

- 3 Select the items that you want to display.

**Date:** Date and time of creation, or date and time of the more recent modification

**Time Code:** Timecode of first frame

**Duration:** Playback time

**Sequence Number:** Thumbnail sequence number  
**Return to Upper Menu:** Returns to the Thumbnail Menu

The selected information will appear at the bottom of the thumbnails when you display a thumbnail screen.

## Changing clip index pictures

The clip thumbnail screen displays thumbnails as index pictures for clips. Normally the index picture is the first frame in a clip, but you can set any frame in the clip as the index picture.

### Note

You can only change index pictures from the clip thumbnail screen. The thumbnails shown in the clip list thumbnail screen, the expand thumbnail screen, and the chapter thumbnail screen cannot be changed.

### To select a clip index picture while viewing the video

See page 71 for more information about thumbnail screen operations.

- 1 In the clip thumbnail screen, select the thumbnail of the clip whose index picture you want to change.
- 2 Display the Thumbnail Menu.
- 3 Select Select Index Picture.  
Select Index screen appears.



You can play and search with this screen.

- 4 Select a frame with the PLAY button or the shuttle/jog dial in jog mode (JOG indicator: lit).
- 5 Select OK, and then press the PUSH SET knob.

## To select index pictures by using the expand and chapter functions

After using the expand function (*see page 73*) or chapter function (*see page 74*) to find a frame, you can set that frame as the index picture of the clip.

The following example explains how to do so from the expand thumbnail screen.

*See page 71 for more information about thumbnail screen operations.*

- 1 In the expand thumbnail screen, select the thumbnail to set as the index picture.
- 2 Display the Thumbnail Menu.
- 3 Select Set Index Picture.

A message appears asking you to confirm that you want to set the current frame as the index picture.

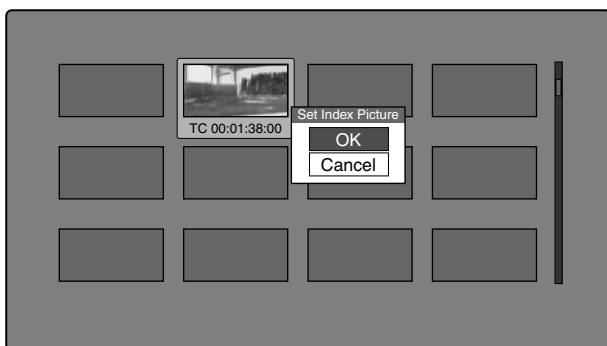

- 4 Select OK, and then press the PUSH SET knob.

After pressing the RETURN button to return to the clip thumbnail screen, check to make sure that the newly selected frame is displayed as the index picture.

## Checking clip properties

You can check clip properties such as the title, timecode, duration, date and time of creation, and date and time of the more recent modification.

*See page 71 for more information about thumbnail screen operations.*

- 1 Display the Thumbnail Menu in the clip thumbnail screen.
- 2 Select Clip Properties.

The Clip Properties screen appears.



**Clip No.:** Clip number/total number of clips

**Name:** Clip name <sup>1)</sup>

**Title1:** Title1

**Title2:** Title2 <sup>1)</sup>

**AV Format:** Recording format

**TC/DUR:** Timecode of the first frame/Recording time

**Created:** Date and time of creation

**Modified:** Date and time of most recent modification

**Rec Device:** Name of device that created clip (product number)

<sup>1)</sup> When the unit's area of use (UC/J MODEL SELECT) (*see page 35*) is set to "UC", titles can be displayed in European languages.

### To scroll hidden parts of the string into view

When a ◀ or ▶ mark is displayed for an item, you can press the ◀ or ▶ button to scroll the display by one character for each press.

The ▲/MARK1 and ▼/MARK2 buttons scroll the beginning and end of the string into view.

### To display the properties of the previous or the next clip

Press the PREV button or the NEXT button.

### To return to the clip thumbnail screen

Press the PUSH SET knob.

### To edit clip information

You can edit the name <sup>1)</sup>, title, and title 2 of a clip by using a software keyboard.

<sup>1)</sup> The "NAMING FORM" sub-item on setup menu item 036 must be set to "free" (*see page 137*).

### Notes

- The only characters that can be entered are the alphanumeric characters and symbols that appear on the software keyboard, and European language characters displayed on the keyboards illustrated in "List of Supported USB Keyboards" (page 189). Japanese kanji cannot be entered.
- Names and titles must be within the specified character length limits.

- Some symbols cannot be used in clip names. The keys for those symbols are disabled when you are editing a clip name.

See page 71 for more information about GUI screen operations.

**1** In the Clip Properties screen, turn the PUSH SET knob to select the item you want to edit (Name, Title1 <sup>1)</sup>, or Title2).

1) Only ASCII characters can be used for Title1.

**2** Press PUSH SET knob.

An input screen appears for the selected item. (If the area of use setting is “UC” (for regions outside Japan), a keyboard appears that corresponds to the font selected with Disc Menu item Settings >Select Font. A Japanese keyboard appears if the area of use setting is “J” (for Japan).)

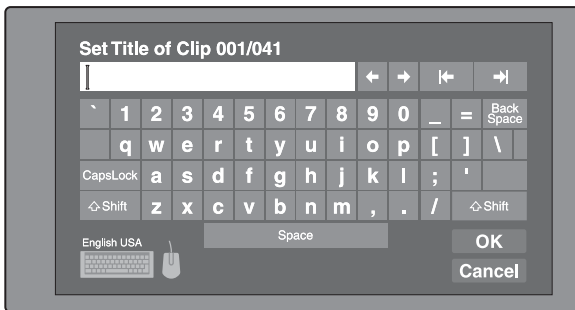

**3** Edit the string in the edit box.

**To enter characters**

Use the  $\blacktriangle$ /MARK1,  $\blacktriangledown$ /MARK2,  $\blacktriangleleft$  or  $\blacktriangleright$  buttons or turn the PUSH SET knob to select a key, and then press the PUSH SET knob.

**Functions of special keys**

Key	Function
$\blacktriangleleft$ , $\blacktriangleright$	Move the cursor one character forward or back.
$\blacktriangleleft$ , $\blacktriangleright$	Move the cursor to Home or End position.
Back Space	Deletes the character in front of the cursor.
CapsLock	Turns the Shift key on permanently (until pressed again), and enables input of capital letters and symbols.
$\blacktriangleup$ Shift	Enables input of capital letters and symbols. Turns off after entry of one character.

**4** Select OK, and then press the PUSH SET knob.

You return to the Clip Properties screen, and the results of the editing are reflected in the clip information.

**To enter text using a USB keyboard or USB mouse**

You can connect a Windows USB keyboard or a Windows USB mouse <sup>1)</sup> to the MAINTENANCE connector (see page 33), and use them together with the software keyboard to enter text.

Connect a Japanese keyboard if you have set the area of use to “J” (for Japan). <sup>2)</sup>

Connect a keyboard that corresponds to the font selected with Disc Menu item Settings >Select Font if you have set the area of use to “UC” (for regions outside Japan).

1) Some USB keyboards or USB mice may not be used. In this case, the message “Unknown USB” appears.

2) Only ASCII characters can be entered from a Japanese keyboard.

**To change the display language (font) for clip names, clip list names, and title2 clip titles:** Select one of the following languages (fonts) with the Disc Menu item Settings >Select Font.

- European Alphabet: The keyboard language can be selected with the Disc Menu item Settings >USB Keyboard Language (see following section).
- Korean: The Korean keyboard is selected automatically. You can enter Hangeul characters if you have connected a Korean USB keyboard.
- Simplified Chinese: The keyboard layout is identical to that of the English [United States] keyboard. Only ASCII characters can be entered.
- Traditional Chinese: The keyboard layout is identical to that of the English [United States] keyboard. Only ASCII characters can be entered.

**To change the keyboard language:** Select the desired language from the following values using Settings >Select USB Keyboard Language in the Disc Menu.

- English [United Kingdom]
- English [United States]
- French [France]
- German [Germany]
- Italian [Italy]
- Polish (Programmers) [Poland]
- Russian [Russia]
- Spanish [Spain]

See “List of Supported USB Keyboards” (page 189) for the characters that can be entered in each language.

**Note**

The keyboard language cannot be changed in the following cases.

- When the area of use is set to “J” (for Japan).
- When the area of use is set to “UC” (for regions outside Japan), and the Disc Menu item Settings >Select Font is set to “Korean”, “Simplified Chinese”, or “Traditional Chinese”.

The keyboard icon on the software keyboard is highlighted when a USB keyboard has been recognized and enabled for use with this unit, and the mouse icon is highlighted and a mouse pointer appears when a USB mouse has been enabled.

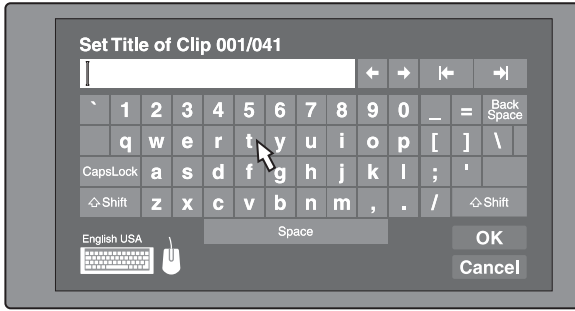

**Notes**

- Use the proper keyboard for the area of use. Some characters may not be entered correctly if you use a keyboard designed for use in another area.
- It is not possible to enter Japanese, even on a Japanese keyboard.

**USB keyboard special functions keys**

In addition to the special function keys of the software keyboard, you can use the following special function keys on a USB keyboard.

Key	Function
↑, ↓	<b>When the cursor is in an edit box:</b> Move the cursor to the start or end. <b>When “OK” or “Cancel” has the focus:</b> Moves the focus between “OK” and “Cancel”.
Delete	Deletes the character after the cursor.
Shift + ←, Shift + →	Selects the string before or after the cursor.
Ctrl + C, X, V, A	<b>Ctrl + C:</b> Copies the selected string. <b>Ctrl + X:</b> Cuts the selected string. <b>Ctrl + V:</b> Pastes a copied or cut string. <b>Ctrl + A:</b> Selects the entire string.
Enter	<b>When the cursor is in an edit box:</b> Moves the focus to Cancel. <b>When OK or Cancel has the focus:</b> Exits the software keyboard.
Esc	When the cursor is in an edit box, moves the focus to Cancel.
Tab	Moves the focus between OK and Cancel.

**USB mouse functions**

You can use the mouse to move the cursor on the software keyboard. You can also left click on a key to enter the character for that key.

**To change the speed of the mouse pointer:** Select the desired speed using Settings >Select Mouse Pointer

Speed in the Disc Menu. Select the speed that works best with the connected mouse.

**To exit the software keyboard from a USB keyboard**

**1** With the cursor in an edit box, press the Enter key or the Esc key to move the focus to Cancel.

**2** Do one of the following.

**To confirm the edit and then exit the software keyboard:** While OK is selected, press the Enter key.

**To discard the edit and then exit the software keyboard:** On the USB keyboard, press the ↓ key or the Tab key to move to Cancel, and then press the Enter key.

**To continue editing:** Press any key except the Enter key, the Esc key, and the Tab key.

**Setting clip flags**

You can set three types of clip flags (OK/NG/KP (KEEP)) during recording or playback. Setting these flags in each clip that you record makes it easy for editors and other colleagues to find and select the clips that they need.

*See page 71 for more information about thumbnail screen operations.*

**1** In the clip thumbnail screen, select the thumbnail of the clip where you want to set a flag.

**2** Display the Thumbnail Menu.

**3** Select Set Clip Flag.

The clip flag setting screen appears.

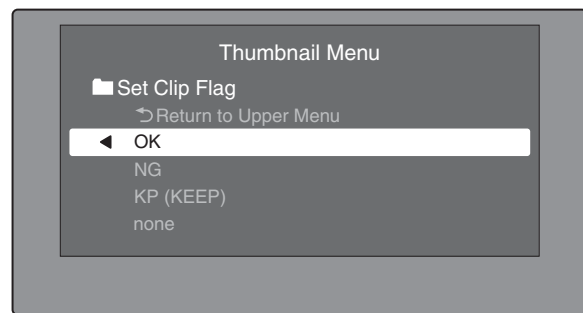

**4** Select the clip flag that you want to set (OK/NG/KP (KEEP)).

A clip flag icon (*see page 66*) appears for clips that have clip flags set.



### To clear clip flags

Carry out steps **1** to **3**, selecting a clip that has a flag set, and then select “none” in step **4**.

*You can also use CLIP FLG on page P4 OTHER of the function menu to set and clear clip flags (see page 53).*

## Locking (write-protecting) clips

In a clip thumbnail screen, you can lock the selected clips so that they cannot be deleted or altered.

Locking prevents the following operations on clips.

- Deletion
- Changing the index picture
- Adding and deleting shot marks
- Setting and clearing clip flags

### Notes

- Locked clips are deleted along with other clips when a disc is formatted.
- Clips cannot be locked or unlocked when the write inhibit tab of the disc is set to the recording disabled position, or when REC INH in the HOME page of the function menu is set to ON.

### To lock clips

*See page 71 for more information about thumbnail screen operations.*

- 1** In the clip thumbnail screen, select the thumbnails of the clips that you want to lock.
- 2** Display the Thumbnail Menu.
- 3** Select Lock/Unlock Clip.
- 4** Press the PUSH SET knob.

A lock icon (*see page 67*) appears on the thumbnail of the locked clips.

In step **1**, you can also perform a shortcut operation by pressing the STOP button with the SHIFT button held down.

### To lock all clips

- 1** Display the Disc Menu.
- 2** Select Lock or Delete All Clips, and then select Lock All Clips.

A message appears asking you to confirm locking all clips.

- 3** Select OK to lock all clips or Cancel to cancel it, and then press the PUSH SET knob.

### To unlock a specific clip

*See page 71 for more information about thumbnail screen operations.*

- 1** In the clip thumbnail screen, select the thumbnail of the clip that you want to unlock.
- 2** Display the Thumbnail Menu.
- 3** Select Lock/Unlock Clip.

A message appears asking you to confirm the unlocking.

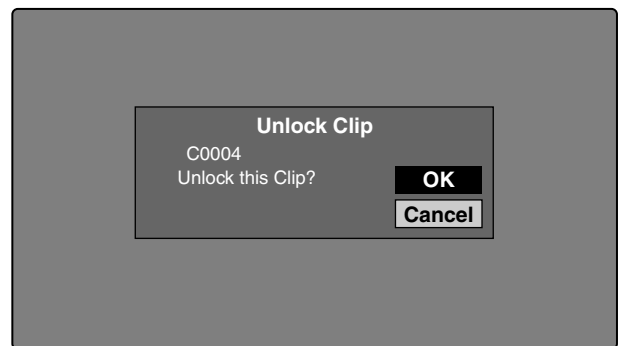

- 4** Select OK, and then press the PUSH SET knob.

In step **1**, you can also perform a shortcut operation by pressing the STOP button with the SHIFT button held down.

### To unlock all clips

- 1** Display the Disc Menu.
- 2** Select Lock or Delete All Clips, and then select Unlock All Clips.

A message appears asking you to confirm that you want to unlock all clips.

- 3** Select OK to execute the unlock, or Cancel to cancel it, and then press the PUSH SET knob.

## Deleting clips

You can delete clips while checking their contents.

### Notes

- Clips cannot be deleted when the write inhibit tab of the disc is set to the recording disabled position, or when

REC INH in HOME page of the function menu is set to ON.

- Locked clips cannot be deleted.
- If a deletion target clip is referenced by clip lists on the disc, all of those clip lists are deleted as well.
- If a deletion target clip is referenced in the current clip list, only those referencing sub clips are deleted at the same time as the deletion target clip.

See page 71 for more information about thumbnail screen operations.

- 1 In the clip thumbnail screen, select the thumbnail of the clip that you want to delete.
- 2 Display the Thumbnail Menu.
- 3 Select Delete Clip.

A window appears asking you to confirm the deletion. The window displays thumbnails of four frames from the target clip (the first frame, two intermediate frames, and the last frame), along with the name, title, date of creation, and duration of the clip.

One of the following messages also appears, depending on whether the clip is referenced in a clip list.

- **When the clip is not referenced in a clip list:** “Delete Clip”
- **When the clip is referenced in a clip list:** “Delete Clip & Clip List” (All clip lists that reference the target clip are deleted along with the clip.)

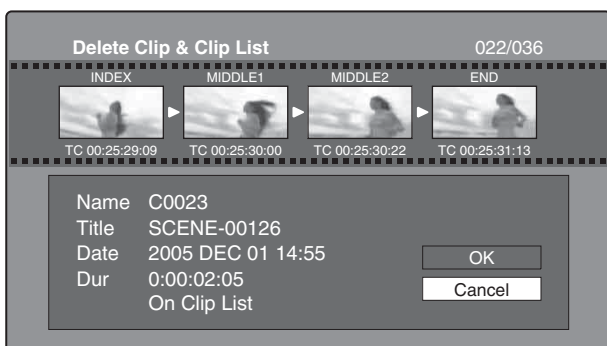

- 4 Select OK, and then press the PUSH SET knob.

The selected clip is deleted, and you return to the clip thumbnail screen.

In step 1, you can also perform a shortcut operation by pressing the DELETE button.

### To delete all clips

- 1 Display the Disc Menu.
- 2 Select Lock or Delete All Clips, and then select Delete All Clips.

A message appears asking you to confirm that you want to delete all clips.

- 3 Select OK to execute the deletion, or Cancel to cancel it, and then press the PUSH SET knob.

### Note

Locked clips cannot be deleted.

# Scene Selection (Clip List Editing)

## What is scene selection?

Scene selection is a function which allows you to select material (clips) from the material recorded on a disc and perform cut editing. You can do this by operating on this unit only.

- Scene selection is a convenient way to perform cut editing in the field and in other offline situations.
- In scene selection you create a clip list (editing data). Since the material itself is not affected, you can repeat this any number of times.
- You can play back the edit list created by scene selection on this unit.
- In scene selection you can add whole clips or add parts of a clip. You can add scenes using chapters, change the playback sequence, and amend or delete In and Out points. All of these operations can be carried out easily on this unit.
- Clip lists (editing data) created with the scene selection function can be used on XPRI and other full-feature nonlinear editing systems.

*You can perform insert editing and overlay editing with the edit list editing function. For details, see page 102.*

## Clips

Material recorded with this unit is managed in units called clips. A clip contains the material from a recording start point to a recording end point.

Clips have numbers beginning with C, for example C0001.

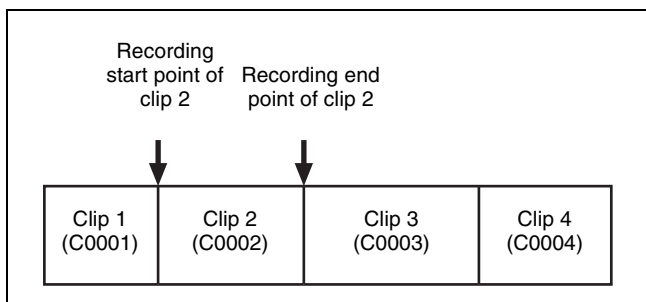

*You can also assign titles to your clips and use the titles to manage them, instead of the clip numbers. For more information, see “Assigning user-defined clip titles” (page 120).*

## Clip lists

You can use the scene selection function to select clips from the clips saved on a disc and create a cut edit list called a “clip list”.

Clip lists have numbers beginning with E, for example E0001. Up to 99 clip lists can be saved on a disc.

## Sub clips (clips in clip lists)

Clips (or parts of clips) that have been added to a clip list are called “sub clips”. Sub clips are virtual editing data that specify ranges in the original clips. You can use them without modifying the original data.

The following figure illustrates the relation between clips and sub clips.

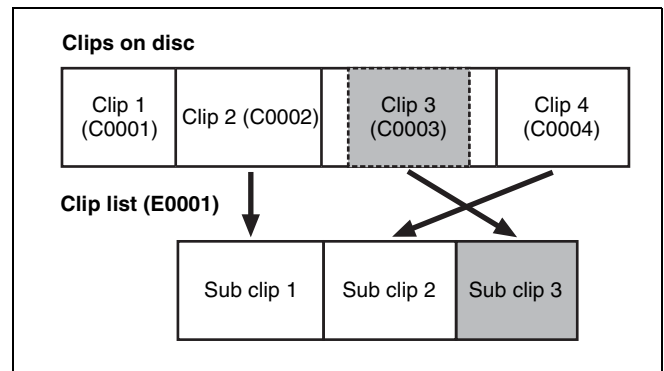

In the above example, the whole of clip 2 has been added as sub clip 1, and the whole of clip 4 has been added as sub clip 2.

Sub clip 3 is part of clip 3. Therefore, when clip list E0001 is played back, clip 4 is played after clip 2, and then the part of clip 3 shown in gray color is played.

## Clip list editing (current clip list)

To edit a clip list, you need to load the clip list from the disc into the unit’s internal memory.

The clip list which is currently loaded into the unit memory is called the “current clip list”.

The current clip list is always the target of sub clip creation and editing. Clip list playback also uses the current clip list.

After creating and editing a clip list, you need to save it to disc.

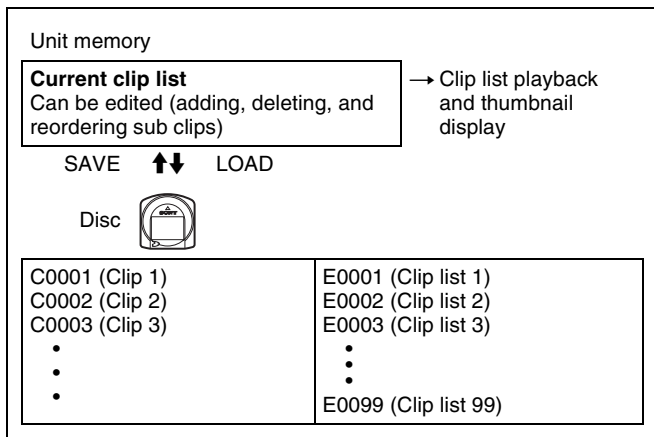

## Clip list playback

Clips and clip lists are saved together on a disc. To play a clip list, insert a disc into the unit, load the clip list that you want to play, and press the PLAY button. Clips are played according to the data in the clip list.

## Creating and editing clip lists

The following table lists the steps in the creation and editing of clip lists with the scene selection function. To create a clip list, you always need to carry out the steps inside the heavy lines. Other steps can be carried out as required.

1	<p><b>Add sub clips:</b> Use the Add Sub Clips command to add the clips you want to use to a clip list. You can add up to 300 sub clips to one clip list. This operation can be carried out in the following thumbnail screens.</p> <ul style="list-style-type: none"> <li>• Clip thumbnail screen</li> <li>• Expand thumbnail screen</li> <li>• Chapter thumbnail screen</li> <li>• Clip list thumbnail screen</li> </ul>
2	<p><b>Change the sub clip order:</b> Use the Move Sub Clips command to change the order of sub clips in a clip list.</p> <p><b>Delete sub clips:</b> Use the Delete Sub Clips command to delete specified sub clips from a clip list.</p> <p><b>Trim sub clips:</b> Use the Trim Sub Clip command to adjust the In and Out points of a sub clip. This function can also be used to adjust the overall duration of the clip list.</p> <p><b>Set the start timecode:</b> Use the Set Start Time Code command to set the timecode at the start of a clip list.</p>
3	<p><b>Play the clip list:</b> Use the PLAY button and other playback controls to play the current clip list and check its contents.</p>
4	<p><b>Save the clip list:</b> Use the Save Clip List or Save Clip List as... command to save the newly created clip list to the disc.</p>

## To reedit clip lists on the disc

Use the Load Clip List command to load the clip lists you want to edit, and perform the steps **2** to **4** in the previous section.

You can also delete clip lists on the disc.

For details, see "Managing clip lists" (page 89).

### Note

Clip lists can be created and edited even when the write inhibit tab of the disc is set to recording disabled, and when REC INH on the HOME page of the function menu is set to ON. However, if you need to save the clip list, set write inhibit tab and REC INH to enable recording before you create or edit the clip list.

## To add sub clips

You can add sub clips to clip lists from the clip thumbnail screen or the clip list thumbnail screen. However, you must use the clip list thumbnail screen to edit clip lists.

### Adding sub clips from the clip thumbnail screen

The following procedure explains operations in the clip thumbnail screen. You can proceed in the same way in the expand thumbnail screen and the chapter thumbnail screen. Expanded blocks are added as sub clips in the expand thumbnail screen, and chapters are added as sub clips in the chapter thumbnail screen.

See page 71 for more information about thumbnail screen operations.

- 1** In the clip thumbnail screen, select the clip that you want to add as a sub clip (multiple selections possible).
- 2** Display the Thumbnail Menu.
- 3** Select Add Sub Clips, and then press the PUSH SET knob or the S.SEL button.

The Add Sub Clip screen appears.

The clip(s) selected in step **1** appear in the upper part of this screen, and the clip list appears in the lower Scene Selection window. The I cursor in the Scene Selection window indicates the location where the currently selected sub clip(s) will be inserted.



**To display the total duration after addition of the selected clip**

Press the SHIFT button.

**4** In the Scene Selection window, move the I cursor to the location where you want to insert the clip. (The existing thumbnails arrange themselves to the left and right of the I cursor.)

**5** Press the PUSH SET knob.

The selected clip is inserted as a sub clip and a “+” mark appears on the thumbnail in the Scene Selection window.

**To check the addition results**

Move the cursor.

**6** Press the RETURN button.

This returns you to the Clip thumbnail screen.

**7** Repeat steps **1** to **6** as required to add more clips.

**8** Save the clip list (*see page 88*).

In step **1**, you can press the S.SEL button. This is a shortcut that displays the Add Sub Clip screen immediately. You can also save the clip list immediately in step **5** by executing the Save Clip List command in the Disc Menu.

**Adding sub clips from the clip list thumbnail screen**

*See page 71 for more information about thumbnail screen operations.*

**1** Display the Thumbnail Menu.

**2** Select Add Sub Clips, and then press the PUSH SET knob.

The Clip List (Add) screen appears.

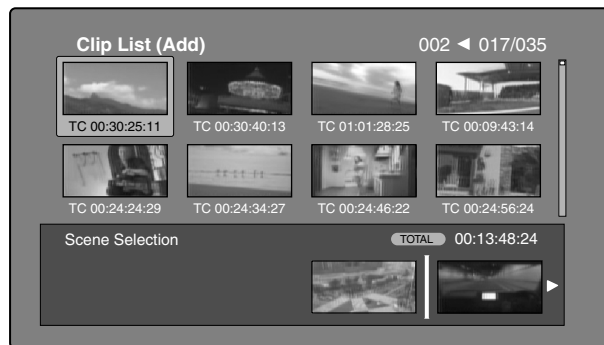

**3** Select the sub clips that you want to add from the upper part of the screen (the part where 8 thumbnails are displayed, multiple selections possible).

**To select from expanded thumbnails**

Press the EXPAND button to display the expand thumbnail screen.

**To select from chapter thumbnails**

Press the CHAPTER button to display the chapter thumbnail screen.

**4** Press the PUSH SET knob.

The thumbnail selection is confirmed, and an I cursor appears at the bottom of the Clip List (Add) screen (in the Scene Selection window). The I cursor indicates the location where the currently selected sub clips will be inserted.

**To display the total duration after addition of the selected clips**

Press the SHIFT button.

**5** In the Scene Selection window, move the I cursor to the location where you want to insert the clip. (The existing thumbnails arrange themselves to the left and right of the I cursor.)

**6** Press the PUSH SET knob.

The sub clips are added at the I cursor position, and you return to the clip list thumbnail screen.

You can check the results of the addition in that screen.

**7** Repeat steps **1** to **6** as required to add more clips.

**8** Save the clip list (*see page 88*).

In step **1**, you can also perform a shortcut operation by pressing the S.SEL button.

### To add clips from the clip playback screen (quick insertion)

This method allows you to decide the range to use and add that range as a sub clip while viewing the video in the clip playback screen. It does not use GUI screens. You can do this during recording, playback (including pauses), and searches.

- 1 Find the point that you want to make the start point of the sub clip, and then press the ENTRY button with the ◀ button held down.

An In point is set and the IN button lights.

- 2 Find the point that you want to make the end point of the sub clip, and then press the ENTRY button knob with the ▶ button held down.

An Out point is set and the OUT button lights. (This determines the range of the sub clip to be added.)

**To check the timecode of the In point or Out point**  
Press the ◀ button or the ▶ button.

#### To cue up the In point or Out point

Press the GOTO button with the ◀ button or ▶ button held down.

**To check the duration (time from In point to Out point)**

Press the ◀ and ▶ buttons at the same time.

#### To delete the In point or Out point

Press the DELETE button with the ◀ or ▶ button held down.

#### To recall a deleted In point or Out point

Press the RECALL button with the IN button or OUT button held down.

- 3 Press the S.SEL button.

A sub clip with the range specified in steps 1 and 2 is added to the end of the clip list.

**When you specify a range that spans several clips**  
Sub clips are generated for each of the clips in the range.

#### To check the newly added sub clips

You can check the newly added sub clips by displaying the clip list thumbnail screen.

- 4 Repeat steps 1 to 3 as required to add more sub clips.
- 5 Save the clip list (*see page 88*).

### To reorder sub clips

*See page 71 for more information about thumbnail screen operations.*

- 1 In the clip list thumbnail screen, select the thumbnails of the sub clips that you want to move (multiple selections possible).
- 2 Display the Thumbnail Menu.
- 3 Select Move Sub Clips, and then press the PUSH SET knob or the SET button.

The Clip List (Move) screen appears.

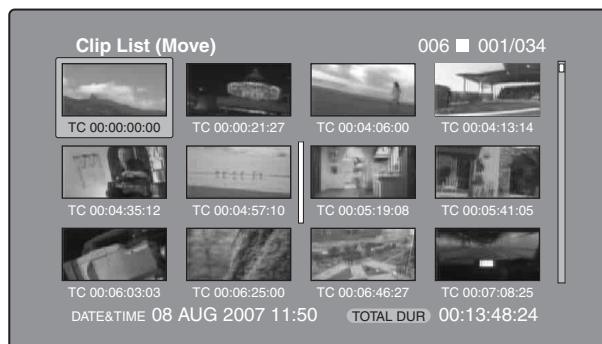

- 4 Move the I cursor to the point where you want to move the selected thumbnails.
- 5 Press the PUSH SET knob or the SET button.  
The sub clips are moved to the I cursor position.
- 6 Repeat steps 1 to 5 as required.
- 7 Save the clip list (*see page 88*).

### To adjust the In and Out points of sub clips (trim)

Proceed as follows to define the range of a scene by changing the positions of the In and Out points.

*See page 71 for more information about thumbnail screen operations.*

- 1 In the clip list thumbnail screen, select a thumbnail.
- 2 Display the Thumbnail Menu.
- 3 Select Trim Sub Clip, and then press the PUSH SET knob.

The Clip List (Trim) screen appears.

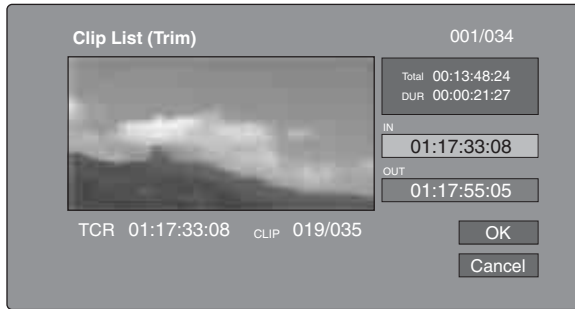

Like the clip playback screen, this screen allows you to play and search all clips on the disc.

### To display a list of In and Out point operations that you can perform

Press the MENU button.

- 4 When you find the point that you want to make the start point, select “IN” and then press the PUSH SET knob.

The timecode of the new In point appears in the timecode display, and the Total (total duration) and DUR (clip duration) displays are updated.

- 5 When you find the point that you want to make the end point, select “OUT” and then press the PUSH SET knob.

The timecode of the new Out point appears in the timecode display, and the Total (total duration) and DUR (clip duration) displays are updated.

### To cue up the In point or Out point

Display the Thumbnail Menu, select Cue up Inpoint or Cue up Outpoint, and then press the PUSH SET knob.

### To cancel the In point or Out point setting

Display the Thumbnail Menu, select Reset Inpoint or Reset Outpoint, and then press the PUSH SET knob.

The In point or Out point setting returns to the previous value.

- 6 Select OK, and then press the PUSH SET knob.
- 7 Repeat steps 1 to 6 as required.
- 8 Save the clip list (*see page 88*).

## To delete sub clips

*See page 71 for more information about thumbnail screen operations.*

- 1 Select the clips to delete in the clip list thumbnail screen (multiple selections possible).

- 2 Display the Thumbnail Menu.
- 3 Select Delete Sub Clips, and then press the PUSH SET knob.  
A message appears asking you to confirm the deletion.
- 4 Select OK, and then press the PUSH SET knob.
- 5 Repeat steps 1 to 4 as required.
- 6 Save the clip list (*see page 88*).

## To play the clip list

*See page 71 for more information about GUI screen operations.*

### To play using GUI screens

- 1 In the clip list thumbnail screen, select the thumbnail of the sub clip where you want to start play.

#### To start play from the start of the clip list

Select the thumbnail of the first sub clip.

- 2 Press the PLAY button.

### To play using the clip list playback screen

- 1 Display the clip list playback screen.
- 2 Press the PREV button or the NEXT button to display the sub clip that you want to play.

#### To start play from the first sub clip

Press the SHIFT + PREV buttons to move to the first sub clip.

- 3 Press the PLAY button.

## To change the starting timecode of clip lists

The timecode of clip lists is continuous timecode, unrelated to the timecode of the original clips. By default the timecode (LTC) of the start of the clip list is 00:00:00:00, but it can be set to any value.

*See page 71 for more information about thumbnail screen operations.*

- 1 In the clip list thumbnail screen, display the Thumbnail Menu.
- 2 Select Set Start Time Code, and then press the PUSH SET knob.

The Set Start Time Code screen appears.

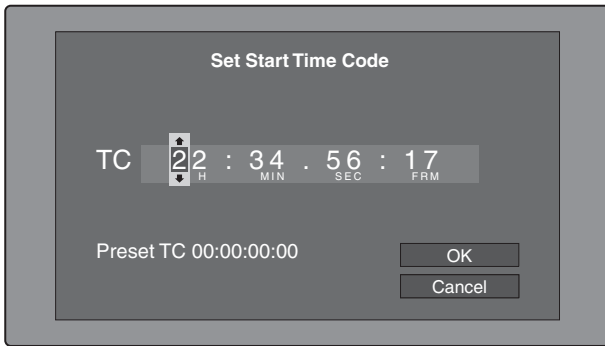

- 3 Press the ◀ or ▶ button to select the digit that you want to change.
- 4 Turn the PUSH SET knob or the shuttle/jog dial to change the value of the digit.
- 5 Repeat steps 3 and 4 as required.

#### To reset the timecode to 00:00:00:00

Select Reset to Zero in the Thumbnail Menu, and then press the PUSH SET knob.

#### To preset the frequently used timecode

Select Save Preset TC in the Thumbnail Menu, and then press the PUSH SET knob.

The timecode set in steps 4 and 5 is saved as a preset value.

#### To recall the preset timecode

Select Recall Preset TC in the Thumbnail Menu, and then press the PUSH SET knob.

- 6 Press the PUSH SET knob.  
OK is selected.
- 7 Press the PUSH SET knob again.
- 8 Save the clip list (*see page 88*).

### To save clip lists

#### To save under a specified name

*See page 71 for more information about thumbnail screen operations.*

- 1 In the clip list thumbnail screen, display the Disc Menu.
- 2 Select Save Clip List as..., and then press the PUSH SET knob.

A list of clip lists appears.

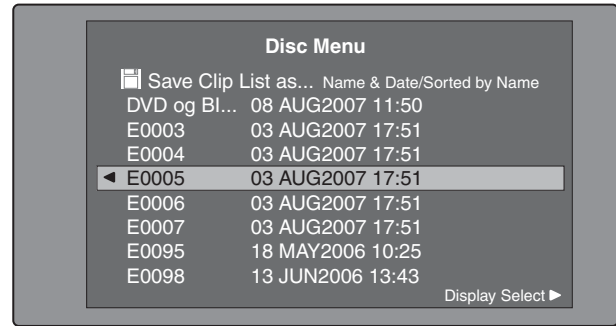

#### To switch the information displayed for clip lists

Press the ▶ button.

With each press, the display changes in the order: “Name & Date” > “Name & Title” > “Name & Sort Date” >...

#### To sort clip lists

Select one of the following orders by selecting Settings > Sort Clip List by... in the Disc Menu.

**Name(A-Z):** Sort in ascending order by clip list name.

**Date(Newest First):** Sort by date and time of clip list creation, newest first.

- 3 Select the desired clip list name, and then press the PUSH SET knob.

#### To save under the same name

The following procedure saves the current clip list under its current name (the name that appears in the clip list thumbnail screen).

*See page 71 for more information about thumbnail screen operations.*

- 1 In the clip list thumbnail screen, display the Disc Menu (*see page 70*).
- 2 Select Save Clip List, and then press the PUSH SET knob.

The clip list is saved. However, Save Clip List as... is executed when the name displayed in the clip list thumbnail screen is “no name”.

#### Note

If you press the EJECT button or move the on/standby switch to the ⏻ position before saving a new or edited clip list, a message appears asking if you want to discard your changes and continue. Follow the instructions in the message to continue or cancel the operation.



## Managing clip lists

### To load clip lists

The following procedure loads a clip list stored on the disc into the unit's internal memory as the current clip list.

See page 71 for more information about thumbnail screen operations.

- 1 In the clip list thumbnail screen, display the Disc Menu.
- 2 Select Load Clip List, and then press the PUSH SET knob.

A list of clip lists stored on the disc appears.

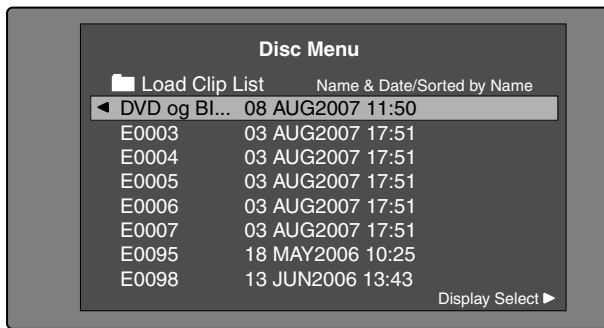

- 3 Select the desired clip list, and then press the PUSH SET knob.

The name of the clip list selected here appears in the clip list thumbnail screen. When you execute the Save Clip List command in the Disc Menu, the clip list will be saved under that name.

### To create a new clip list

Select New File and then press the PUSH SET knob.

### To clear clip lists

The following procedure clears the current clip list from the unit's internal memory.

See page 71 for more information about thumbnail screen operations.

- 1 In the clip list thumbnail screen, display the Disc Menu.
- 2 Select Clear Clip List, and then press the PUSH SET knob.

A message appears asking you to confirm that you want to clear the clip list.

- 3 Select OK, and then press the PUSH SET knob.

The current clip list returns to the unnamed state "(no name)".

### To delete clip lists

The following procedure deletes a clip list from the disc.

See page 71 for more information about thumbnail screen operations.

- 1 In the clip list thumbnail screen, display the Disc Menu.
- 2 Select Delete Clip List, and then press the PUSH SET knob.  
A list of clip lists appears.
- 3 Select the clip list that you want to delete, and then press the PUSH SET knob.

A message appears asking you to confirm the deletion.

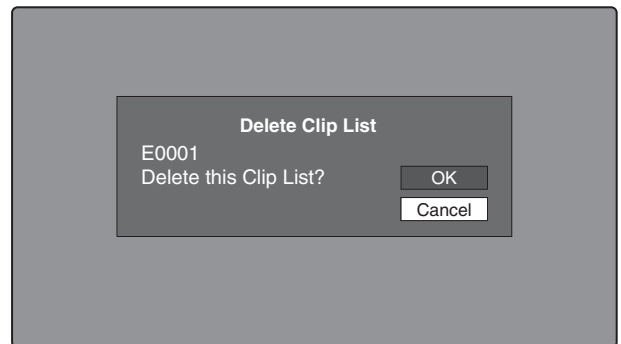

- 4 Select OK, and then press the PUSH SET knob.

### To sort clip lists

See page 71 for more information about thumbnail screen operations.

- 1 In the clip list thumbnail screen, display the Disc Menu.
- 2 Select Settings, and then press the PUSH SET knob.
- 3 Select Sort Clip List by..., and then press the PUSH SET knob.
- 4 Select one of the following sort methods, and then press the PUSH SET knob.

**Name(A-Z):** Sort in ascending order by clip list name.  
**Date(Newest First):** Sort by date and time of clip list creation, newest first.

Clip lists will be displayed in the specified order the next time that you carry out an operation such as loading a clip list.

# Disc Operations

## Checking disc properties

See page 71 for more information about GUI screen operations.

- 1 Display the Disc Menu.
- 2 Select Disc Properties, and then press the PUSH SET knob.

The Disc Properties screen appears.

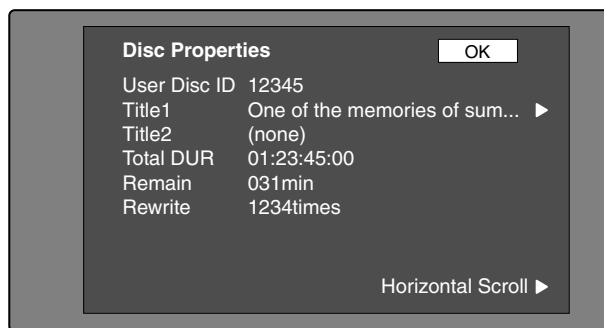

**User Disc ID:** User disc ID <sup>1), 2)</sup>

**Title1:** Title1

**Title2:** Title2 <sup>1)</sup>

**Total DUR:** Total recording time

**Remain:** Remaining recording time

**Rewrite:** Number of times rewritten

1) When the unit's area of use (UC/J MODEL SELECT) (see page 35) is set to "UC", titles can be displayed in European languages.

2) You can use planning metadata to set it (see page 166).

### To scroll hidden parts of the string into view

When a ◀ or ▶ mark is displayed for an item, you can press the ◀ or ▶ button to scroll the display by one character for each press.

The ▲/MARK1 and ▼/MARK2 buttons scroll the beginning and end of the string into view.

### To return to the previous screen

Press the PUSH SET knob.

### To edit disc information

You can edit the user disc ID, title <sup>1)</sup>, and title2 by using a software keyboard.

1) Only ASCII characters can be used for the title.

See "To edit clip information" (page 78) for more information about operations.

## Using planning metadata

Planning metadata is a file that contains metadata about the clips to be shot and recorded.

To use planning metadata, you will need to save a file in advance in the specified location of a media, and insert the media into this unit.

See “Setting clip names by using planning metadata” (page 164) for details.

### To load planning metadata files

See page 71 for more information about GUI screen operations.

- 1 Display the Disc Menu.
- 2 Select Load Planning Metadata/Select Drive, and then press the PUSH SET knob.

A media selection screen appears.

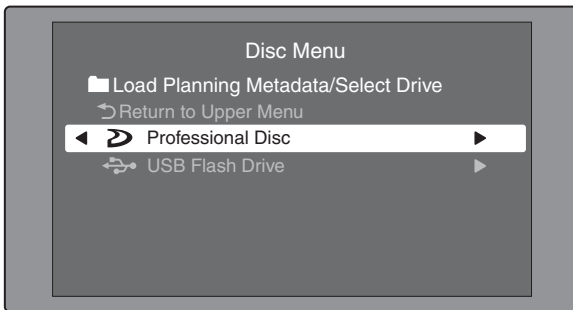

- 3 Select the media where your planning metadata file is stored, and then press the PUSH SET knob.

A list of the planning metadata files stored on the media appears.

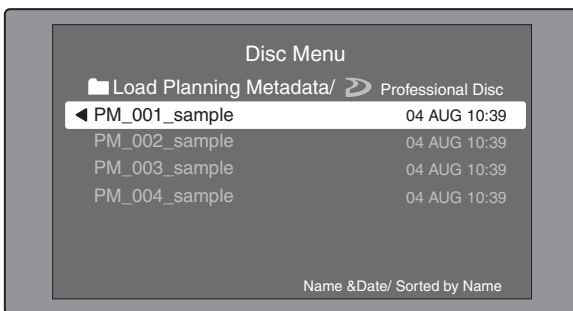

#### Note

Depending on the type of USB flash drive, data may not appear if you attempt to read planning metadata immediately after connecting the USB flash drive. In this case, connect the USB flash drive again, or exit the menu and try again. The data will then appear correctly.

- 4 Select the desired planning metadata file, and then press the PUSH SET knob.

The selected planning metadata file is loaded into the unit’s memory, and the Planning Metadata Properties screen appears.

- 5 Check the information that appears, and press the PUSH SET knob.

### To sort planning metadata

You can sort planning metadata by operating in the same way as in “To sort clip lists” (page 89). However, in step 3, select Sort Planning Metadata by....

The planning metadata will be displayed in the specified order the next time you load planning metadata.

### To check planning metadata properties

You can check the properties of the planning metadata that is loaded into this unit’s memory, including the date and time of creation and the clip titles.

See page 71 for more information about GUI screen operations.

- 1 Display the Disc Menu.
- 2 Select Planning Metadata Properties, and then press the PUSH SET knob.

The Planning Metadata Properties screen appears.

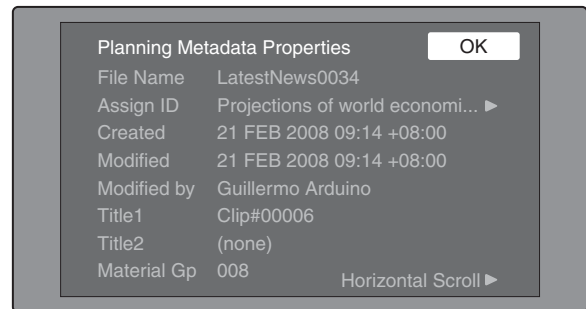

**File Name:** Planning metadata file name

**Assign ID:** Assign ID

**Created:** Date and time of creation

**Modified:** Date and time of most recent modification

**Modified by:** Name of person who modified the file

**Title1:** Title1 <sup>1)</sup>

**Title2:** Title2

**Material Gp:** Number of clips recorded with this planning metadata

1) This can be set as the clip name (see page 164).

### To scroll hidden parts of the string into view

When a ◀ or ▶ mark is displayed for an item, you can press the ◀ or ▶ button to scroll the display by one character for each press.

The ▲/MARK1 and ▼/MARK2 buttons scroll the beginning and end of the string into view.

#### To return to the previous screen

Press the PUSH SET knob.

### To clear planning metadata

See page 71 for more information about GUI screen operations.

- 1 Display the Disc Menu.
- 2 Select Clear Planning Metadata, and then press the PUSH SET knob.

A message appears asking if you are sure that you want to clear the planning metadata.

- 3 Select OK, and then press the PUSH SET knob.

The planning metadata is cleared from this unit's memory.

### To switch the title display in the display screen

When planning metadata is loaded into this unit, you can select the format of the title to display in the display screen.

See page 71 for more information about GUI information.

- 1 Display the Disc Menu.
- 2 Select Settings, and then press the PUSH SET knob.
- 3 Select Planning Clip Name in Clip Info. Area and then press the PUSH SET knob.

See page 25 for more information about the clip information area.

- 4 Select one of the following, and then press the PUSH SET knob.

**Off:** Do not display a title.

**ASCII Clip Name:** Display the ASCII format title (see page 164)

**Clip Name:** Display the UTF-8 format title (see page 164)

## Checking user-defined essence marks

You can display the names of user-defined Shot Mark0 to Shot Mark9 essence marks in planning metadata (UTF-8 format, maximum 32 bytes).

- 1 Display the Planning Metadata Properties screen (see page 91) for the planning metadata loaded into this unit.

The ➡ button is enabled when the planning metadata contains user-defined essence marks (see page 165).

- 2 Press ➡, and then turn the PUSH SET(S.SEL) knob.

The User Defined Essence Marks screen appears.

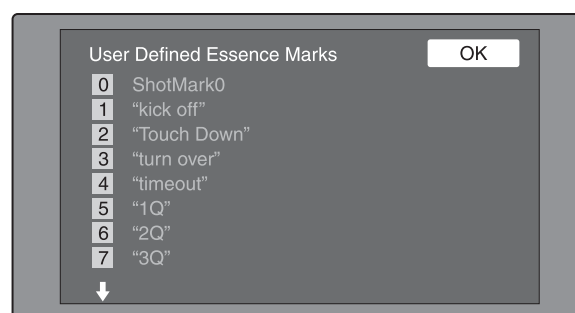

## Formatting discs

See page 71 for more information about GUI screen operations.

- 1 Display the Disc Menu.
- 2 Select Format Disc, and then press the PUSH SET knob.

A message appears asking you to confirm the format.

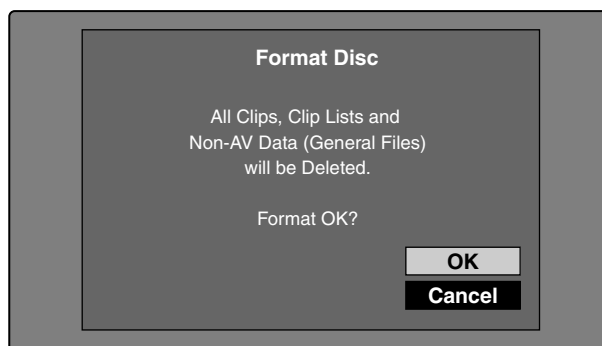

- 3 Select OK, and then press the PUSH SET knob.

#### To cancel the format

Select Cancel, and then press the PUSH SET knob.

**To continue by formatting another disc**  
Exchange the disc, select OK, and then press the PUSH SET knob.

**To exit the formatting screen**  
Press the PUSH SET knob with Exit selected.

## To disable the Format Disc command

To prevent inadvertent disc formatting, resulting in the loss of recorded data, you can disable the Format Disc command.

See page 71 for more information about GUI information.

- 1 Display the Disc Menu.
- 2 Select Settings, and then press the PUSH SET knob.
- 3 Select Setting Format Disc, and then press the PUSH SET knob.
- 4 Select Disable, and then press the PUSH SET knob.

## Displaying disc and clip properties in a web browser

By connecting this unit and a computer over a network, you can display disc properties and clip properties in a web browser installed on the computer (Web Thumbnail function).

The Clip Properties page also allows you to download high-resolution clip data, proxy AV data, and metadata from this unit and to save that data on your computer.

## Recommended browsers

The following browsers are recommended.

- Internet Explorer 7 <sup>1)</sup>
- Internet Explorer 8 <sup>1)</sup>

1) This function may not work properly in 32-bit versions of Internet Explorer if you are using a 64-bit version of Microsoft Windows. You should use a 64-bit version of Internet Explorer with 64-bit versions of Windows.

## To display the unit's XDCAM web pages

- 1 Connect this unit and a computer to a network (see page 162).
- 2 Start the browser on the computer, and enter "http://" + IP\_address\_of\_this\_unit + "/" in the address bar of the browser, and then press the Enter key.

For example, if the IP address of this unit is "192.168.001.010", enter "http://192.168.1.10/".

If the connection succeeds, you will be prompted to enter a user name and a password.

- 3 Enter your user name and password, and then press the Enter key.

The user name and password are set to the following when the unit is shipped from the factory.

- User name: admin
- Password: Model name ("pdw-hr1")

After the user name and password are verified, an XDCAM web page appears.

## To display disc and clip properties

- 1 Insert a disc into this unit, and put this unit into the following state.
  - Recording, playback, search and other disc operations: Stopped
  - THUMBNAIL button: Off
  - Disc access by Lock or Delete All Clips, Format Disc, and so on in the Disc Menu: Stopped
  - FAM or FTP connection for file operations: Disconnected, or logged out
- 2 Display the XDCAM web pages in the browser of your computer (see the previous section).

### To display disc properties

Click "Disc Properties" in the Disc menu. The disc properties of this unit appear in the Disc Properties page.

See "Checking disc properties" (page 90) for more information about the various properties.

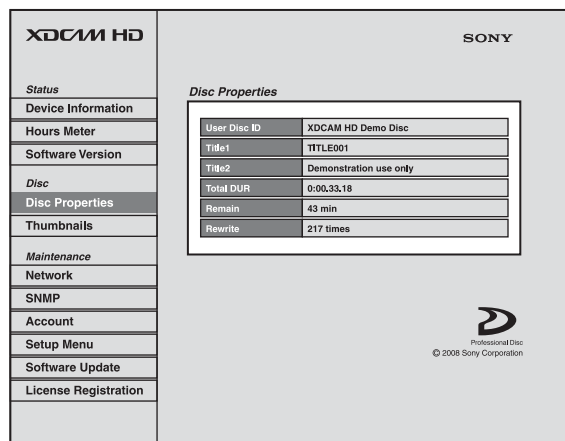

### To display clip thumbnails

Click "Thumbnails" in the Disc menu. A page of thumbnails of clips on the disc appears. Each thumbnail page displays up to 12 thumbnails. Like the thumbnails in the unit's GUI screens (see page 66), the thumbnails display several information

items, including index picture changed marks, S marks, clip flag icons, and lock icons.

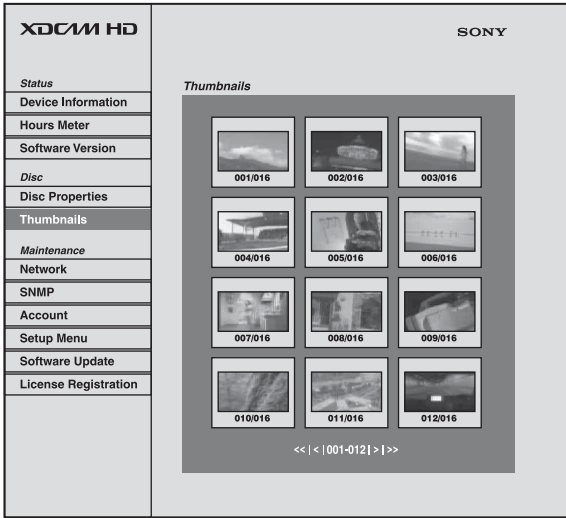

When multiple pages exist, you can switch pages by clicking << (back five pages), < (back one page), > (forward one page), or >> (forward five pages).

### To display clip properties

In the Thumbnails page, select a clip by clicking its thumbnail.

The properties of that clip appear in the Clip Properties page.

See “Checking clip properties” (page 78) for more information about the various properties.

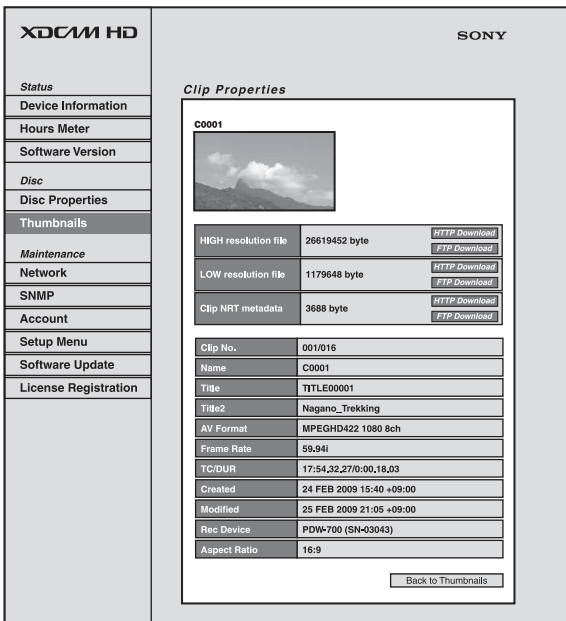

To download high-resolution clip data (HIGH resolution file), proxy AV data (LOW resolution file), or metadata (Clip NRT metadata), click the FTP Download or HTTP Download button to the right of

the item that you want. Then click “Save” in the dialog that appears and specify the save destination. The specified data is downloaded to the specified location in your computer.

### FTP download limitations

The following limitations apply to FTP download operations. They do not apply to HTTP download operations.

- The characters that can be used in the names of clip-related data files are single-byte letters, numbers, and symbols. However, the following symbols cannot be used.  
" # \* / : < > ? \ |
- If you click “Cancel” in the download dialog, or if the download is cancelled in some other way with the browser still connected to the unit by FTP, click “Back to Thumbnails” to return to the thumbnails screen, or exit the web browser.

# Transferring clips (Direct FTP function)

You can transfer clips (MXF files) between this unit and external devices over a network. This unit has an Direct FTP function, which allows you to connect to any XDCAM device or computer with an FTP server function and transfer files with a few simple operations in the GUI screen.

The following table lists the types of file transfers that this unit can execute.

Transfer direction	Transfer target	Function
Upload	One or more clips	put
	Multiple clips with clip list	
	Part of one clip	partial put

Transfer direction	Transfer target	Function
Download	One clip	get

### Note

File transfers with this function are limited to clips (high-resolution data) and clip list files. To transfer files of other types (proxy AV data, files in the General and User Data directories, and so on), operate after establishing a FAM or FTP connection (see page 116).

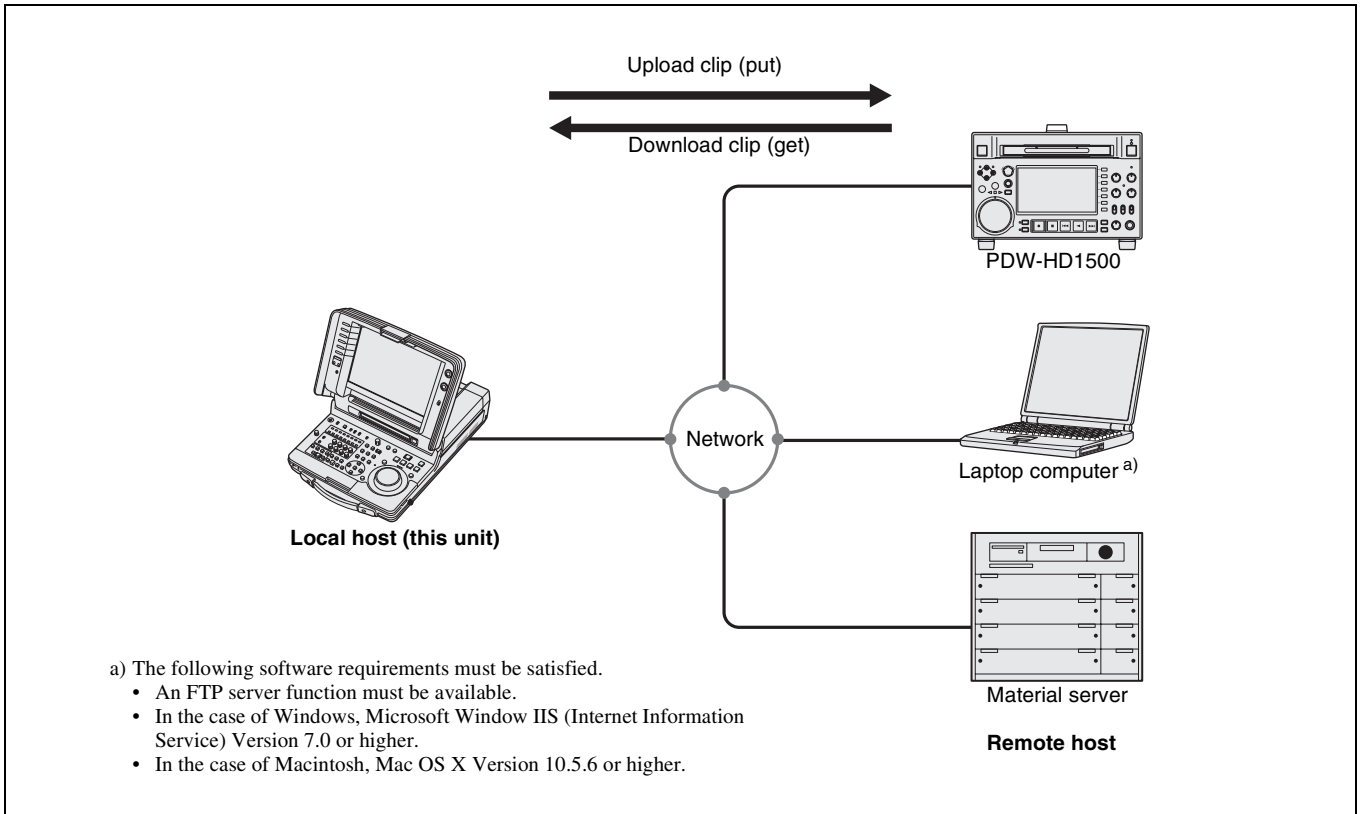

## Preparations for clip transfers

Check the following points.

- This unit must be connected over a network to the transfer target device (XDCAM device or computer).
- The transfer target device (XDCAM device or computer) must be supplied with stable power, and the power must not be turned off during the transfer. For battery powered devices, the batteries must have sufficient remaining capacity.

- The settings under maintenance menu item M5: NETWORK must be set to values that allow network connections.
- The remote control switch must be set to NETWORK.
- For XDCAM devices that support UPnP (universal plug and play), the UPnP function must be enabled (the setting may vary).

### To enable the UPnP function

The UPnP (universal plug and play) function allows devices to be easily connected to networks. The following XDCAM devices support UPnP.

- PDW-F1600
- PDW-HD1500
- PDW-HR1
- PDW-F800
- PDW-700

To enable the UPnP function on this unit, set maintenance menu item M59: UPnP to ENABLE, and then power the unit off and on again.

*For the settings on other XDCAM devices, refer to the operation manuals supplied with the devices.*

## Uploading clips

### To upload entire clips

Proceed as follows to upload selected clips or all clips and clip lists on the disc.

*See page 71 for more information about GUI screen operations.*

- 1 In the clip thumbnail screen, select the clip to upload (multiple selections possible).

To upload all clips and clip lists on the disc, start from step 2.

- 2 Display the Thumbnail Menu.
- 3 Select Upload Clips via Direct FTP, and then press the PUSH SET knob.

The Select Transfer Type screen of the Upload Clips via Direct FTP command appears.

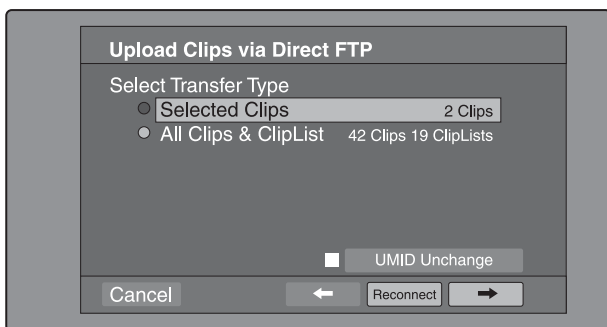

- 4 Select the type of clip transfer.

**Selected Clips:** Clips selected in step 1.

**All Clips & ClipList:** All clips and clip lists on the disc.<sup>1)</sup>

1) Immediately after execution of a clip filtering operation, this item changes to “All Filtered Clips” (all clips selected by the filtering operation).

### To transfer while preserving the UMID of the transfer source clips

Check the “UMID Unchanged” option.

#### Note

If the remote host is a computer, clips are transferred with the UMID unchanged regardless of this setting.

### To reconnect to a remote host

The Reconnect button is enabled if the most recent operation successfully established a connection to a remote host.

You can select “Reconnect” and press the PUSH SET knob to reconnect to that host. The host is selected automatically and the screen changes directly to the Connecting Status screen (*see step 9 in the procedure*).

#### Note

The Reconnect button is not enabled if the most recent operation failed to connect to a remote host.

- 5 Select  $\rightarrow$ , and then press the PUSH SET knob.

The Select Remote Host screen appears.

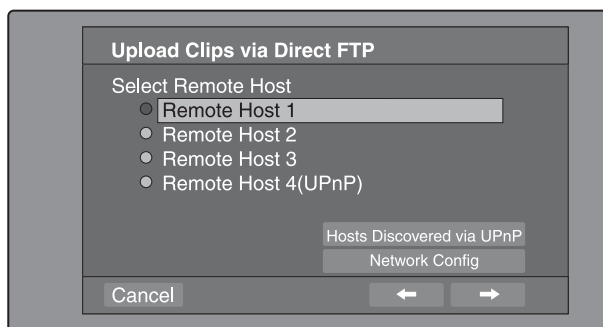

- 6 Select the remote host (the target device to which you want to transfer the clips).

You can register up to four remote hosts.

**Remote Host 1 to 3:** Register these in the settings screen.

**Remote Host 4(UPnP):** A remote host that supports UPnP (universal plug and play) is detected and registered automatically (*see “To enable the UPnP function” (page 96)*).

### To check remote hosts discovered by the UPnP function

Select “Hosts Discovered via UPnP”, and then press the PUSH SET knob. (If the UPnP function of this unit is disabled, a confirmation screen appears prompting you to enable it. Select “OK” and then press the PUSH



SET knob. The UPnP function will be enabled when you power the unit off and then on again.)

The Select Host Discovered via UPnP screen appears. (Some time may be required before the search for remote hosts finishes.)

Select the name of a remote host from the list, and press the PUSH SET knob. A network settings screen appears (*see step 7*). If you establish a connection with the selected remote host, the network settings are saved in Remote Host 4. From the next time that you select “Remote Host 4(UPnP)”, the remote host that you select here will be connected.

### To check the network settings of this unit

Select “Network Config”, and then press the PUSH SET knob. The following network settings appear.

Item	Setting
Host Name	Host name
IP Address	IP address <sup>a)</sup>
Subnet Mask	Subnet mask
DHCP	Setting that specifies whether to acquire the IP address automatically from a DHCP server <b>Enabled:</b> Acquire automatically <b>Disabled:</b> Do not acquire automatically
Address Status	Method used to set IP address <b>Manual Set:</b> Manually <b>DHCP:</b> DHCP function <b>AutoIP:</b> Auto IP addressing function <b>Undefined:</b> Nothing specified
Default Gateway	Default gateway

a) An IP address determined by a DHCP server appears instantly in this field.

Select OK and press the PUSH SET knob to return to the previous screen.

## 7 Select →, and then press the PUSH SET knob.

A network settings screen for the remote host appears.

Item	Setting
Host Name	Host name or IP address. (If this is a host name, a DNS server must be available on the connected network. Specification of an IP address is recommended.)
Port	Port used by the FTP server (normally “21”).
Device Type	The type of the remote host <ul style="list-style-type: none"> <li>If the remote host is an XDCAM device, select the model name or “Other XDCAM model” (if the model name is not in the list) from the list of model names. <sup>a)</sup></li> <li>If the remote host is a computer, select “Others(PC Server)” from the list of model names.</li> </ul>
Description	Comment about the remote host. (UTF-8 encoding, up to 127 bytes. This setting has no effect on the connection.) The setting that you make here appears as the remote host name in the Select Remote Host screen ( <i>see step 5 of the procedure</i> ).
Path	If the remote host is a computer, path to the transfer destination directory. (This is not needed if the remote host is an XDCAM device.)
User Name	User name for FTP login. (If the remote host is an XDCAM device, the default is “admin”.)
Password	Password for FTP login. (If the remote host is an XDCAM device, the default is the model name, such as “pdw-hr1”.)

a) If an XDCAM device is selected as the Device Type, then the User Name and Password are set automatically to the default, and you do not need to make the Port and Path settings. Simply selecting the Host Name (or as appropriate the Description) is enough to fulfill the requirements for connection.

If the User Name or Password of the device that you want to connect to changes, set them here.

## 8 Set the various items.

### To select an item

Turn the PUSH SET knob to move the cursor, and then push the PUSH SET knob.

A software keyboard appears so that you can enter a setting.

## 9 Select “Connect”, and then press the PUSH SET knob.

The settings are saved and the Connecting Status screen appears.

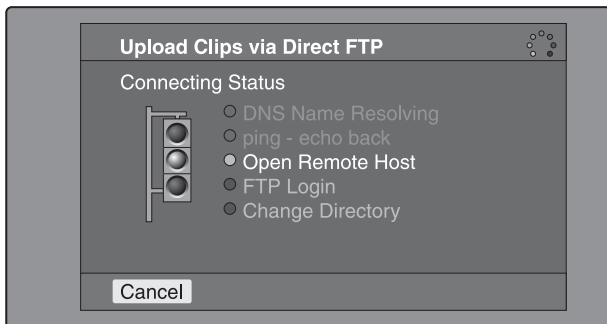

The following table lists the various stages that appear in the connection status screen and describes the corresponding processing.

Item	Description
DNS Name Resolving	When host was specified by a host name instead of an IP address, the unit is querying a DNS server for the host's IP address.
ping - echo back	The unit has issued a ping (communications established) command and is waiting for a response.
Open Remote Host	The unit is connecting to the remote host over the specified port.
FTP Login	The unit is logging in to the remote host with specified user name and password.
Change Directory	When a path was specified, the unit is changing to the specified directory.

The status indicated beside each item lights in yellow during processing for that item, and lights in green when the processing finishes.

#### If an error occurs

The status indicator changes to red. Correct the condition that caused the error and repeat the operation.

#### If you cannot connect

Check the following points.

- Make sure that this unit and the remote host are correctly connected to the network.
- If the remote host is an XDCAM device, make sure that it is not displaying a GUI screen.
- If the remote host is an XDCAM device, make sure that a disc is inserted.

When the connection is complete (the indicators of all items have turned green), the Upload Clips via Direct FTP screen appears.

#### To check the connection on the remote host side

If the remote host is an XDCAM device, check that the “NETWORK!” has appeared in the display or other status display location.

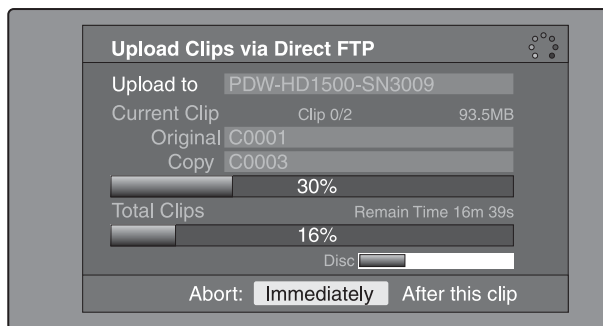

The progress bars show the progress of the transfer. If multiple clips are being transferred, a count of the clips that have been successfully transferred appears. If the remote host is an XDCAM device, the disc usage also appears. (It does not appear if the remote host is a computer).

#### If a file of the same name already exists at the transfer destination

The file name is changed so that it does not conflict with the file at the destination.

The name of the file on the transfer source (this unit) appears in the “Original” field, and the name of the file on the transfer destination appears in the “Copy” field.<sup>1)</sup>

1) If the clip name is a standard name, it is changed to the unused clip name with the smallest number. (Example: If names C0001 to C0020 are in use, the name “C0021”.)  
If the clip name is a user-defined name, a serial number is appended to the clip name. (Example: If the name is “EveningNews”, “EveningNews(1)”.)

#### To cancel the processing

Do one of the following.

- Select “Abort: Immediately”, and then press the PUSH SET knob.
- If you are transferring multiple clips, select “Abort: After this clip”, and then press the PUSH SET knob. (The transfer of subsequent clips will be cancelled after transfer of the current clip finishes.)
- Set the remote control switch of the unit to LOCAL.

#### Note

When several files are to be transferred, the entire transfer task is cancelled when the first transfer failure occurs. Subsequent clips are not transferred.

When the transfer of all files has finished, the Uploading Result Report screen appears. Press the PUSH SET knob. This returns you to the clip thumbnail screen.

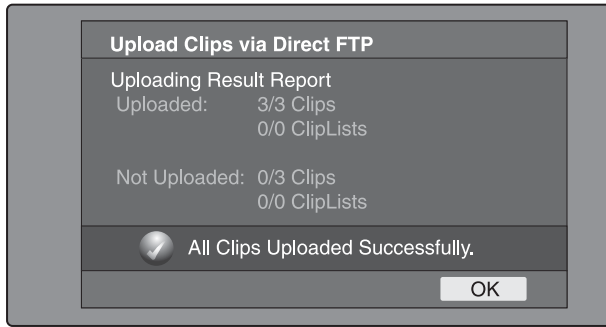

## To upload part of a clip

You can select part of a clip in the expand thumbnail screen or the chapter thumbnail screen and upload that part.

**Expand thumbnail screen:** The clip is divided arbitrarily into parts of equal length, regardless of content. Use this method if you do not need to specify the transfer range precisely.

**Chapter thumbnail screen:** Use this method if you want to transfer a specific range. (By setting essence marks at the start point and end point of the transfer range, you can specify the range with a precision of one frame.)

- 1 In the clip thumbnail screen, select a clip and press the EXPAND or CHAPTER button.

The expand thumbnail screen or the chapter thumbnail screen appears.

- 2 Select the transfer range.

### To select multiple thumbnails

While holding the SHIFT key down, turn the PUSH SET knob, or press the ◀/IN or ▶/OUT button.

The duration of the transfer range appears in the lower right of the screen.

#### Note

When the selected range (duration) in the expand thumbnail screen is less than two seconds, it is expanded automatically to two seconds.

- 3 Execute step 2 to 9 of the previous section “To upload entire clips”.

## Downloading clips

Proceed as follows to download clips from a remote host (such as other XDCAM device devices or a material server).

See page 71 for more information about GUI screen operations.

- 1 Display the Disc Menu.
- 2 Select Download Clip via Direct FTP, and then press the PUSH SET knob.

The Select Remote Host screen of the Download Clip via Direct FTP command appears.

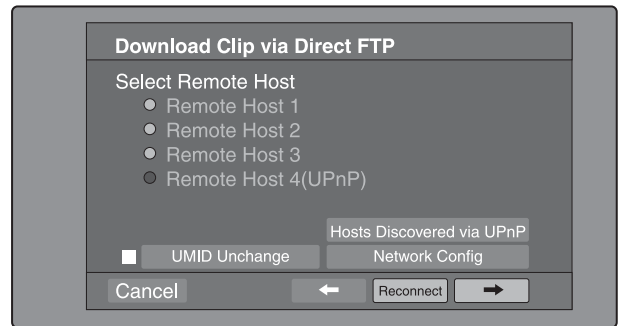

- 3 Execute steps 6 to 9 of “To upload entire clips” (page 96).

If the connection succeeds, the Select Clip to Download screen appears.

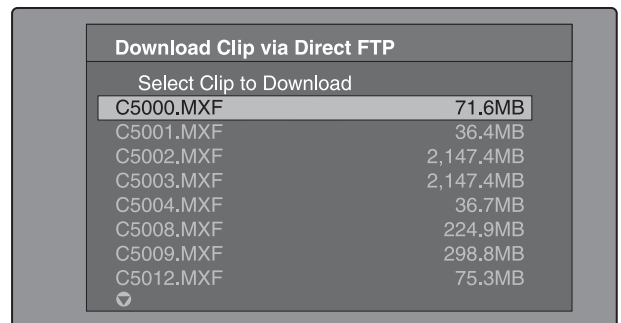

#### Notes

- If the remote host is a computer, only the MXF files in the specified directory appear.
- When 301 or more clips are stored on a remote host, the denominator indicating the clip total at the upper right is shown as “- - -”, and the names of the 301st and following clips are not displayed.
- File names containing other than ASCII characters (kanji and so on) are not displayed.

- 4 Select a clip to download, and then press the PUSH SET knob.

The download starts.

When the download finishes, the Downloading Result Report screen appears.

Select “OK”, and then press the PUSH SET knob. This returns you to the clip thumbnail screen.

## Copying clips directly between XDCAM devices

In the field or another environment where the devices are not connected to a network, you can copy (upload) clips between XDCAM devices by connecting them directly. The example in the following procedure shows how to copy a clip from this unit to a PDW-HD1500. Insert discs into both units and proceed as follows.

- 1 Connect this unit and the PDW-HD1500 by a network cable.  
The cable can be either a cross cable or a straight cable.

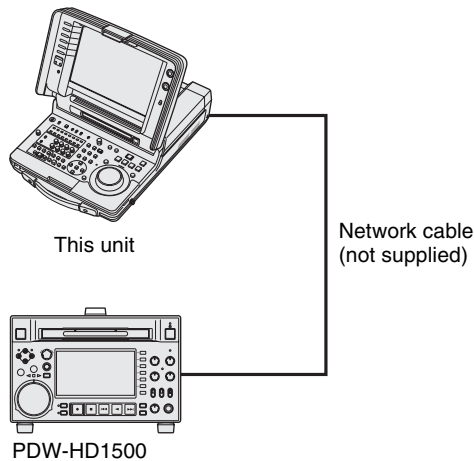

- 2 Set up the two units as follows.

Item	Setting
Item M50 in the Maintenance menu: DHCP	ENABLE
Item M59 in the Maintenance menu: UPnP	ENABLE

- 3 Power both units off and on again, and wait for about three minutes.
- 4 Check that the IP addresses of the two units have been set as follows by the Auto-IP function.

Item	Setting
Item M51 in the Maintenance menu: IP ADDRESS PRESET	169.254.XXX.XXX (X: any number)

- 5 In the clip list thumbnail screen of this unit, select the clip to copy (upload).
- 6 Display the Thumbnail Menu.
- 7 Select Upload Clips via Direct FTP, and then press the PUSH SET knob.

With **➡** selected, the Select Transfer Type screen of the Upload Clips via Direct FTP command appears.

- 8 Press the PUSH SET knob.

The Select Remote Host screen appears.

- 9 Select “Hosts Discovered via UPnP”, and then press the PUSH SET knob.

The detected connection destination device (the PDW-HD1500) appears in the Select Host Discovered via UPnP screen.

- 10 Press the PUSH SET knob.

Detailed information about the connection destination device (the PDW-HD1500) appears.

- 11 With “Connect” selected, press the PUSH SET knob.

Transfer of the clip begins as soon as the connection is established.

During transfer of the clip, “NETWORK!” appears in the display of the connection destination device (the PDW-HD1500).

When transfer of the clip completes, an Uploading Result Report appears on the screen.  
Press the PUSH SET knob to return to the clip thumbnail screen.

- 12 Check the copied clip in the clip thumbnail screen of the connection destination device (the PDW-HD1500).

# Shortcut List

You can access many functions from the buttons, without displaying a menu (shortcut operations).

Shortcuts are available for the following functions. The plus sign (+) indicates that one button is held down while another is pressed, for example “SHIFT + STOP”.

## Note

The same shortcut may access different functions, depending on the screen that is active when it is executed.

Function	Operation
Clip List Thumbnail (display the clip list thumbnail screen)	SUB CLIP
Expand Thumbnail (display expand thumbnail screen)	EXPAND
Chapter Thumbnail (display chapter thumbnail screen)	CHAPTER
Essence Mark Thumbnail (display essence mark thumbnail screen)	SHIFT + THUMBNAIL
Add Sub Clip (add sub clip)	S.SEL
Delete Clip (delete clip)	DELETE
Lock/Unlock Clip (lock or unlock clip)	SHIFT + STOP
Set Inpoint (set In point)	IN + ENTRY
Set Outpoint (set Out point)	OUT + ENTRY
Cue up Inpoint (cue up In point)	IN + GOTO
Cue up Outpoint (cue up Out point)	OUT + GOTO
Reset Inpoint (reset In point)	IN + DELETE
Reset Outpoint (reset Out point)	OUT + DELETE
Recall Inpoint (Recall a deleted In point)	IN + RECALL
Recall Outpoint (Recall a deleted Out point)	OUT + RECALL
Cue up (cue up)	PUSH SET knob <sup>a)</sup>
Cue up & Play (cue up and play)	PLAY <sup>b)</sup>
Page Down (switch to next page)	SHIFT + ↓/MARK2
Page Up (switch to previous page)	SHIFT + ↑/MARK1
Go To End (go to the last item)	SHIFT + NEXT
Go To Top (go to the first item)	SHIFT + PREV
Select Multi Clip (select multiple clips)	SHIFT + → or SHIFT + ←
Exit (exit the current thumbnail screen)	THUMBNAIL

a) If Settings >SET Key on Thumbnail in the Disc Menu is set to “Cue up & Play”, then playback starts as soon as cueup is ready.

b) If Settings >SET Key on Thumbnail in the Disc Menu is set to “Cue up & Play”, then pressing the PUSH SET knob has the same effect.

## Overview

Edit list editing is non-destructive editing in which your edits are performed on edit lists, without changing the original clip data. Unlike scene selection (clip list editing), which is cut editing in units of clips, edit list editing allows you to set edit points inside clips and to perform insert and overlay editing. Editing results are handled in clip list units. Editing with the function described in this chapter, which is more advanced than the scene selection function, is called “edit list editing”, to distinguish it from the clip list editing of the scene selection function. (Up to 99 lists can be saved on one disc, including both edit lists and clip lists.) The editing screen has a timeline that allows you to check your editing results visually, like the user interface of a nonlinear editor.

You can do all of your editing on this unit, or you can configure an editing system with this unit used as the recorder and an external unit used as the player (or use this unit as the player) (see page 41).

## Switching to the editing screens

There are three editing screens.

**EDIT LIST screen:** This is the initial screen for edit list editing. It displays a list of the sub clips on the specified editing device.

**PLAYER mode screen:** This screen allows you to select the material clip and set edit points.

**RECORDER mode screen:** This screen allows you to edit material sub clips and record them.

As in the scene selection function, clips in the editing screens are handled as sub clips.

### Notes

- Edit list editing is not supported for mixed format discs.
- The scene selection function is not available in the edit list editing screens.

- When an edit list editing screen is displayed, signals are not output from the SDDS OUT and COMPOSITE OUT connectors.
- When V INPUT on page P1 VIDEO of the function menu is set to “i.LINK” and PLAYER SEL in the Edit Menu is set to “external”, editing cannot be performed.
- The maximum number of clips that can be recorded on one disc is 300, including voice data. Discs containing 300 recorded clips cannot be used as editing discs. (“REC INH.!” appears in the time data display area.)

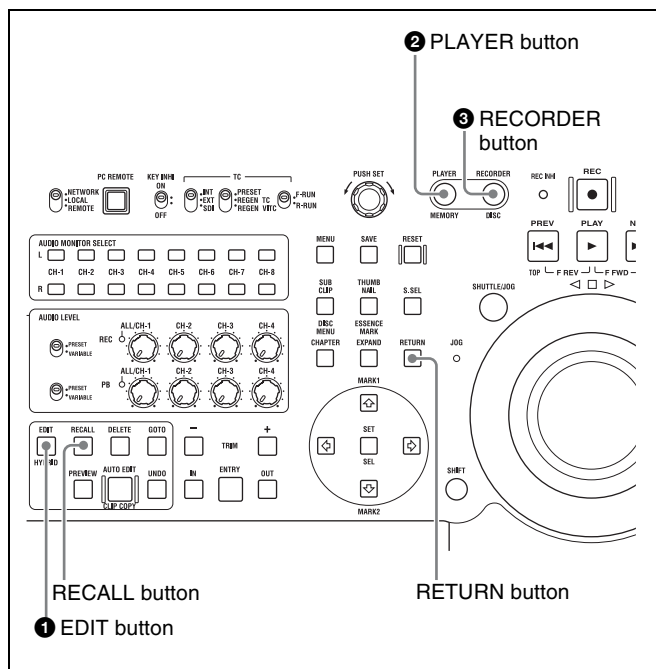

To switch from the clip playback screen to these three screens, use the **1** EDIT, **2** PLAYER, and **3** RECORDER buttons. As shown in the following figure, the unit switches to the corresponding screen each time a button is pressed.

When a sub clip is selected in the EDIT LIST screen, you can switch to the Clip List (Trim) screen by pressing the RECALL button. (To return to the EDIT LIST screen, press the RETURN button.)

**Note**

Each editing screen shows the display when the PDBZ-UPG03 Software Upgrade Key or PDBK-MK1 option board is installed.

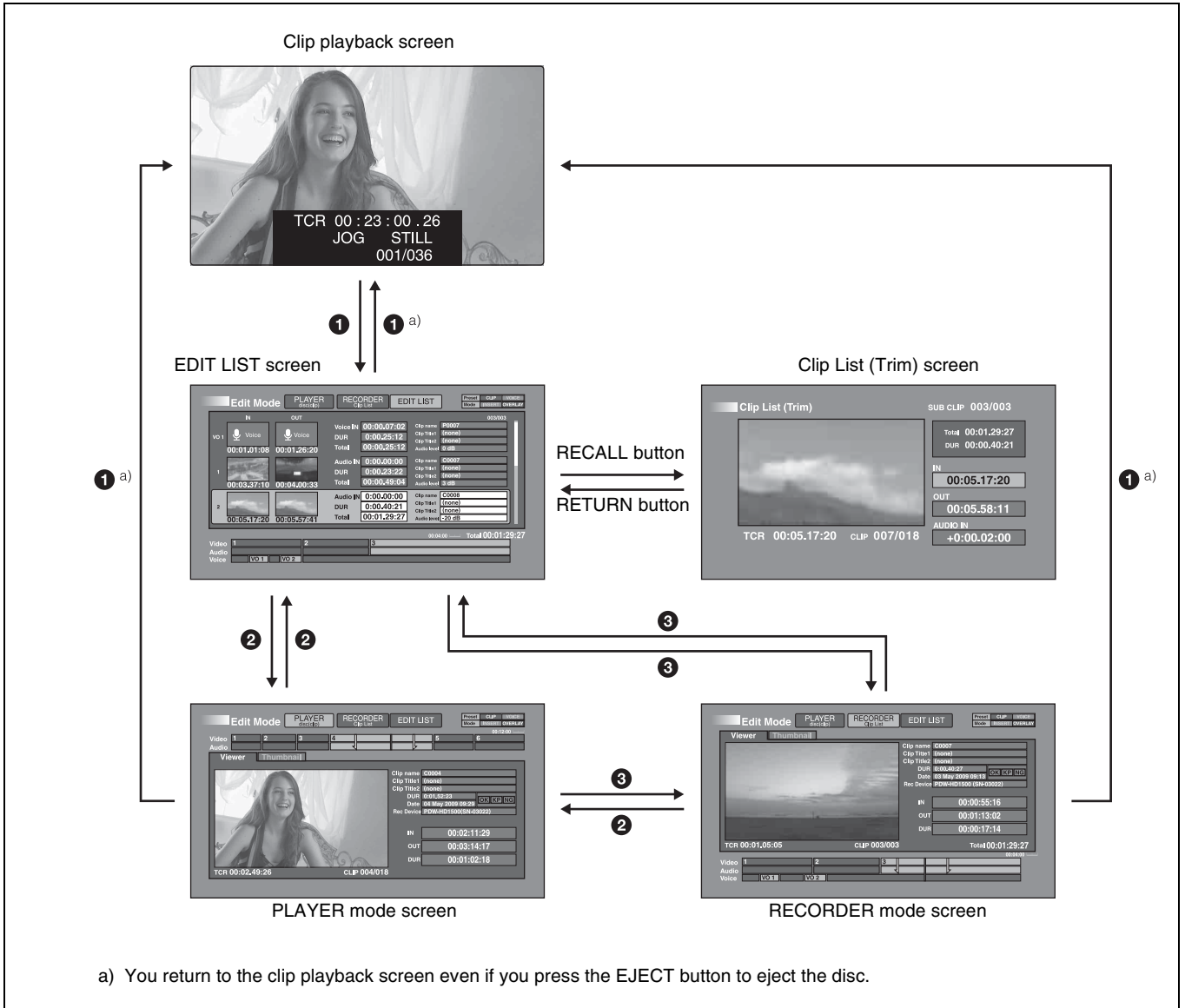

## Parts of the editing screens

### EDIT LIST screen

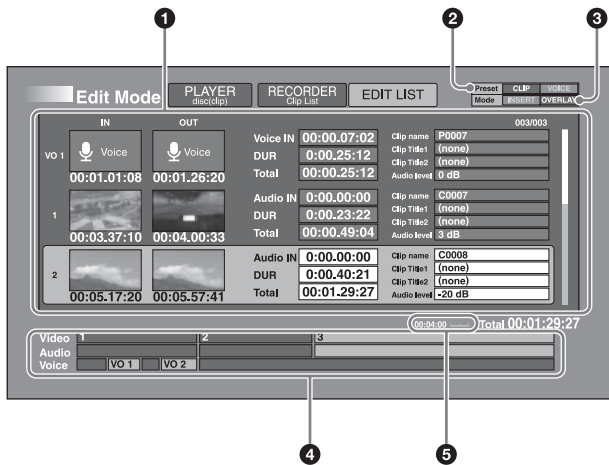

#### 1 Clip list

Displays a list of the sub clips on the specified editing device. The selected sub clip is highlighted.

The following clip properties are shown for each sub clip.

**IN:** In point

**OUT:** Out point

**Audio IN/Voice IN:** Audio or voice In point

**DUR:** Duration (from In to Out point)

**Total:** Total duration of all sub clips on the timeline.

**Clip name:** Clip name

**Clip Title1:** Clip title 1

**Clip Title2:** Clip title 2

**Audio level:** Audio level

#### 2 Target of player editing

Displays the target of player editing selected with EDIT PRESET in the Edit Menu.

**CLIP:** Clip (video and audio data)

**VOICE:** Audio (audio data, independent of any clip)

#### 3 Editing mode

Displays the editing mode selected with EDIT MODE in the Edit Menu.

**INSERT:** Insert mode

**OVERLAY:** Overlay mode

#### 4 Timeline

Displays sub clips along the temporal axis. The total duration of all sub clips is displayed in the Total field. The sub clip that is selected in the clip list is highlighted.

You can enlarge or reduce the time scale of the timeline by pressing the + TRIM or – TRIM button.

#### 5 Timeline reduced scale display

### PLAYER mode screen (When PLAYER SEL is set to “disc(clip)” 1)

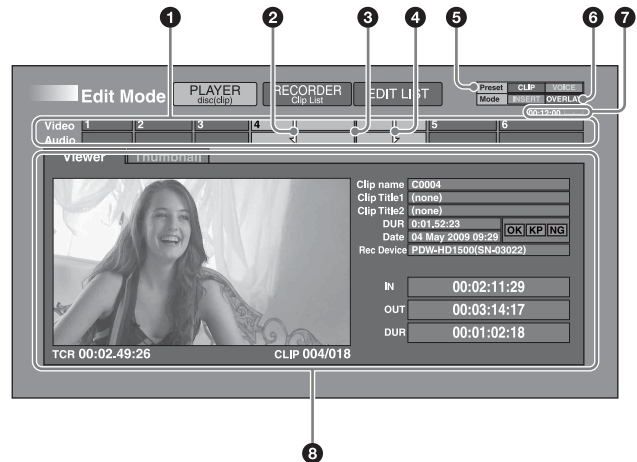

1) When PLAYER SEL in the Edit Menu is set to “external”, the PLAYER mode screen is always full-screen display.

#### 1 Timeline

Displays along a temporal axis the clips on a disc. The currently selected clip is highlighted.

You can enlarge or reduce the time scale of the timeline by pressing the + TRIM or – TRIM button.

#### 2 In point mark

Displays on the timeline the position of the In point of the currently selected clip.

#### 3 Playline

Displays on the timeline the current position of the frame in the viewer.

#### 4 Out point mark

Displays on the timeline the position of the Out point of the currently selected clip.

#### 5 Target of player editing

Displays the target of player editing selected with EDIT PRESET in the Edit Menu.

**CLIP:** Clip (video and audio data)

**VOICE:** Audio (audio data, independent of any clip)

#### 6 Editing mode

Displays the editing mode selected with EDIT MODE in the Edit Menu.

**INSERT:** Insert mode

**OVERLAY:** Overlay mode

#### 7 Timeline reduced scale display

#### 8 Viewer/thumbnail display

Displays a thumbnail list of clips on a disc. You can use the expand and chapter functions to expand or search inside the thumbnails in the thumbnail list.



The following clip properties are displayed for the currently selected clip.

**Clip name:** Clip name

**Clip Title1:** Clip title 1

**Clip Title2:** Clip title 2

**DUR:** Duration (from the start point to the end point)

**Date:** Date and time of recording

**Rec Device:** Device that recorded the clip

**OK/NG/KP (KEEP):** Clip flag (if set, the corresponding indicator lights)

**IN:** In point

**OUT:** Out point

**DUR:** Duration (from In point to Out point)

**DUR:** Duration (from the start point to the end point)

**Date:** Date and time of recording

**Rec Device:** Device that recorded the clip

**OK/NG/KP (KEEP):** Clip flag (if set, the corresponding indicator lights)

**IN:** In point

**OUT:** Out point

**DUR:** Duration (from In point to Out point)

## 2 Target of player editing

Displays the target of player editing selected with EDIT PRESET in the Edit Menu.

**CLIP:** Clip (video and audio data)

**VOICE:** Audio (audio data, independent of any clip)

## 3 Editing mode

Displays the editing mode selected with EDIT MODE in the Edit Menu.

**INSERT:** Insert mode

**OVERLAY:** Overlay mode

## 4 Timeline

Displays along a temporal axis the editing target sub clips. The currently selected sub clip is highlighted.

You can enlarge or reduce the time scale of the timeline by pressing the + TRIM or – TRIM button.

## 5 In point mark

Displays on the timeline the position of the In point of the currently selected sub clip.

## 6 Playline

Displays on the timeline the current position of the frame in the viewer.

## 7 Out point mark

Displays on the timeline the position of the Out point of the currently selected sub clip.

## 8 Timeline reduced scale display

## RECORDER mode screen

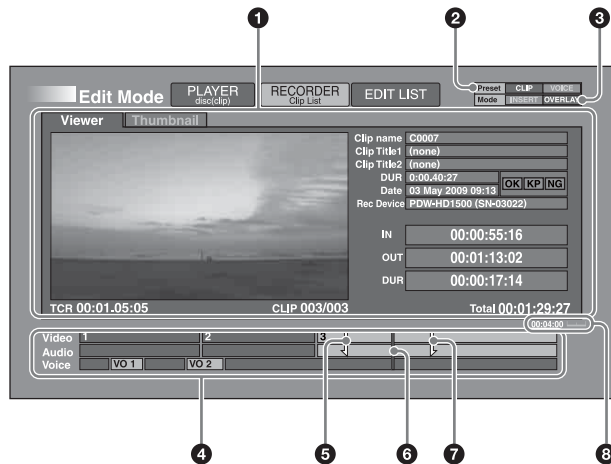

### 1 Viewer/thumbnail display

Displays the video of the currently selected sub clip, or a thumbnail list of the sub clips on the specified editing media or device. You can use the expand function to expand inside the thumbnails in the thumbnail list. The following clip properties are displayed for the currently selected clip.

**Clip name:** Clip name

**Clip Title1:** Clip title 1

**Clip Title2:** Clip title 2

## Displaying the Edit Menu

With one of the editing screens displayed, press the MENU button.

To return to the original screen, press the RETURN button.

## Edit Menu

The Edit Menu enables the following operations and settings. (The factory default setting is underlined in the Operation/setting column.)

Item	Operation/setting
Load Clip List	Loads an edit list into the unit's memory.
Save Clip List as...	Saves an edit list to the disc under a specified name.
Clear Clip List	Delete the current clip list.

Item	Operation/setting
PLAYER SEL	<p>Selects the source of the clips to be used as material.</p> <p><b>disc(clip):</b> Clips (video and audio data) on a disc inserted into the recorder</p> <p><b>external:</b> External device</p> <p><b>disc(voice):</b> Audio (audio data, distinct from clips) on a disc inserted into the recorder</p> <p><b>SxS:</b> Clips (video and audio data) on an SxS memory card inserted into the recorder</p> <p>You can display this item without displaying the menu (shortcut operation). To do so, press the PLAYER button with the SHIFT button held down in the EDIT LIST or RECORDER screen.</p> <p><b>Note</b> The settings “disc(voice)” and “SxS” appear when the PDBZ-UPG03 Software Upgrade Key or PDBK-MK1 option board is installed.</p>
EDIT PRESET	<p>Selects the target of player editing.</p> <p><b>Clip:</b> Clip (video and audio data)</p> <p><b>Voice:</b> Audio (audio data, independent of any clip)</p> <p>You can display this item without displaying the menu (shortcut operation). To do so, press the RECORDER button with the SHIFT button held down in an editing screen.</p> <p><b>Notes</b></p> <ul style="list-style-type: none"> <li>• This appears when the PDBZ-UPG03 Software Upgrade Key or PDBK-MK1 option board is installed.</li> <li>• This item is always reset to “Clip” when this unit is powered on. A “Voice” setting is not saved.</li> </ul>
INPUT VOICE CH	<p>Selects the audio input channel.</p> <p><b>CH 1 to CH 8</b></p> <p><b>Note</b> This appears when the PDBZ-UPG03 Software Upgrade Key or PDBK-MK1 option board is installed.</p>
OUTPUT VOICE CH	<p>Selects the output channel for a voice track.</p> <p><b>CH 1 to CH 8</b></p> <p><b>Notes</b></p> <ul style="list-style-type: none"> <li>• This appears when the PDBZ-UPG03 Software Upgrade Key or PDBK-MK1 option board is installed.</li> <li>• The current setting of this item at the start of editing is applied across the entire edit list. It is not possible to change this setting for different voice data segments.</li> </ul>
EDIT MODE	<p>Selects the edit mode. When EDIT PRESET is set to “Voice”, this is fixed as “overlay”.</p> <p><b>insert:</b> Insert mode</p> <p><b>overlay:</b> Overlay mode</p>
EDIT POINT	<p>Selects the handling of audio playback at edit points. (The options are the same as those of setup menu item 320.)</p> <p><b>cut:</b> Carry out a cut edit (possibly resulting in audio discontinuities at the edit point).</p> <p><b>fade:</b> Fade out and fade in.</p>
Set Start Time Code	<p>Sets the start timecode.</p>
P-ROLL TIME	<p>Sets the preroll time. (The options are the same as those of setup menu item 001.)</p> <p><b>0 Sec to 5 Sec to 30 Sec:</b> Set the preroll time within the range from 0 and 30 seconds in steps of 1 second. (A preroll time of at least 5 seconds is recommended.)</p>
Audio Level	<p>Sets the audio level for audio data and voice-over data.</p> <p><b>–∞, –80 dB to 0 dB to 12 dB:</b> Can be set in units of 1 dB across the range from –∞ to 12 dB.</p> <p><b>Note</b> This appears when the PDBZ-UPG03 Software Upgrade Key or PDBK-MK1 option board is installed.</p>

---

## Editing screen operations

### To select a clip or sub clip in the EDIT LIST screen

Do one of the following.

- Turn the PUSH SET knob.
- Press the ▲/MARK1 or ▼/MARK2 button.

### To switch between the viewer and thumbnail display in the PLAYER and RECORDER mode screens

Press the THUMBNAIL/ESSENCE MARK button. With each press, the screen switches between the viewer and thumbnail display.

*See page 71 for more information about screen operations when thumbnails are displayed.*

#### Note

When PLAYER SEL in the Edit Menu is set to “external”, the PLAYER mode screen is always full-screen display.

### To enlarge or reduce the time scale of the timeline

To enlarge the scale, press the + TRIM button. To reduce it, press the – TRIM button.

# Editing Operations

## Editing modes

This section explains how player materials are added to the recorder timeline, which is editing target, in the various editing modes.

### Insert mode editing

In insert mode editing, player material is added as sub clips at specified positions on the recorder timeline. Sub clips (or parts of sub clips) at and after the insertion position are pushed back toward the end of the timeline.

The following figure shows a typical example of 3-point editing.

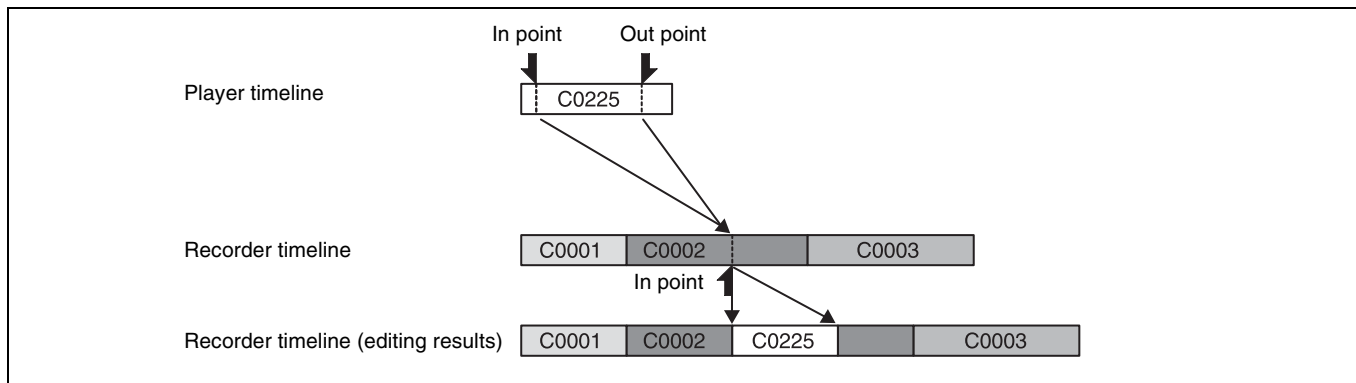

### Overlay mode editing

In overlay mode editing, player material is added as sub clips at specified positions on the recorder timeline, overwriting the material already there.

The following figure shows a typical example of 3-point editing.

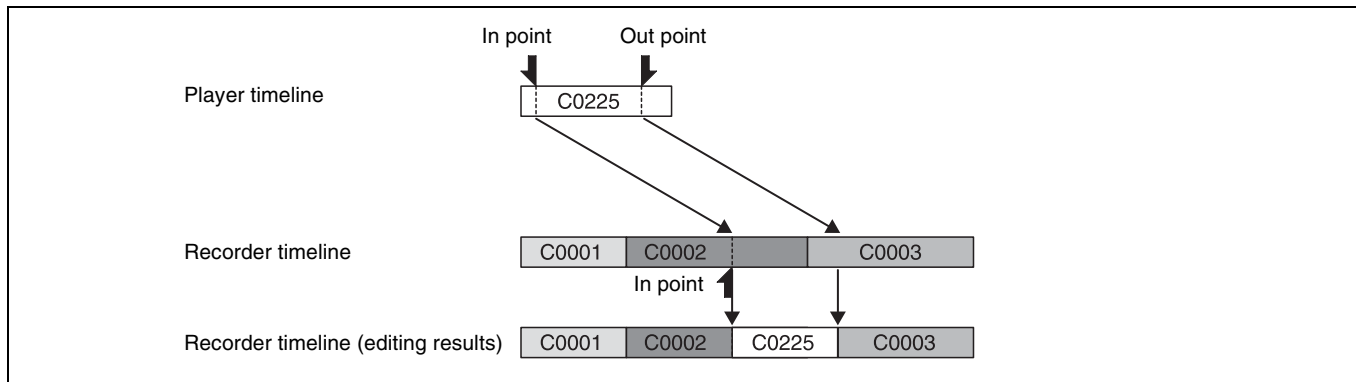

### Replace editing

In insert editing, if you specify all four of the edit points, then the specified range on the recorder timeline is replaced with the player material.

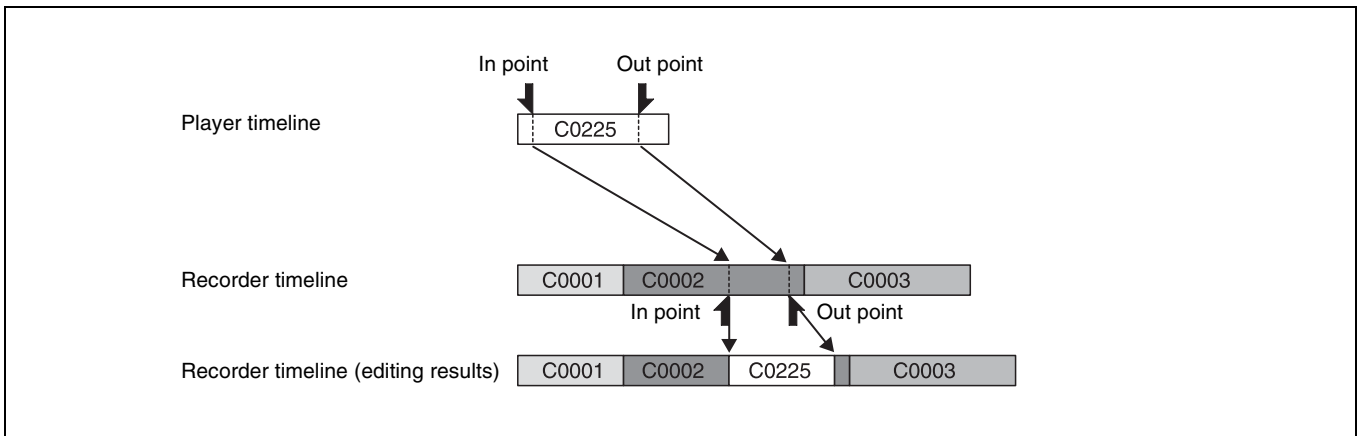

## Executing edits

Before starting, insert a writable disc containing recorded clips into this unit. If you will be using a two-unit system with an external player, insert a tape or disc containing the recorded material into the player.

See page 41 for information about connections in a two-unit editing system.

- 1 In the clip playback screen, press the EDIT button.  
The screen changes to the EDIT LIST screen.
- 2 Select Load Clip List in the Edit Menu, and then load the editing target edit list by selecting it from the list that appears.  
If you continue editing without loading an edit list here, then later (when you executed the AUTO EDIT operation in step 10) save an editing result.
- 3 Select PLAYER SEL in the Edit Menu, and select the media or device that contains the editing target material by selecting one of the following.
  - disc(clip)
  - external (only in a two-unit editing system configuration)
  - disc(voice)
  - SxS
- 4 Press the PLAYER button.  
The screen changes to the PLAYER mode screen and a list of the clips appears, showing the clips in the media or device selected in step 3.

### To select clips from a thumbnail list

You can select clips from a thumbnail list when you have set PLAYER SEL in the Edit Menu to “disc(clip)” or “disc(voice)”.

Switch to thumbnail display by pressing the THUMBNAIL button, and then select a clip. Next, press the PUSH SET knob or the SET button to return to the viewer display.

- 5 Use the PLAY, PAUSE, and STOP buttons and the shuttle/jog dial to play the clip, and set edit points in the clip.

### To enlarge or reduce the scale of the timeline

Press the + TRIM or – TRIM button.

### To set In or Out points

With the IN or OUT button held down, press the ENTRY button.

### To jump to In or Out points

With the IN or OUT button held down, press the GOTO button.

### To adjust the positions of In or Out points

With the IN or OUT button held down, press the – TRIM or + TRIM button.

### To delete In or Out points

With the IN or OUT button held down, press the DELETE button.

### To recall a deleted In point or Out point

Press the RECALL button with the IN button or OUT button held down.

- 6 Press the RECORDER button.

The screen changes to the RECORDER mode screen, and sub clips in the edit list that was loaded in step 2 appear.

### When there are no sub clips

Sub clips are not displayed when a new edit list is loaded and when no edit list is loaded.

- 7 Select EDIT MODE in the Edit Menu to select the editing mode (see page 108).
- 8 Use the PLAY, PAUSE, and STOP buttons and the shuttle/jog dial to play the edit list, and set edit points in the edit list (see step 5).

#### When there are no sub clips

This operation is not needed, because edit points cannot be set.

#### If you skip setting edit points

The material is added at the playline position.

#### To enlarge or reduce the scale of the timeline

Press the + TRIM or – TRIM button.

#### To modify audio transitions at edit points

Select EDIT POINT in the Edit Menu, and then select “cut” or “fade” (fade out and fade in).

#### Note

Depending on the combination of edit mode and edit point settings, it may not be possible to execute the edit. In this case, the DELETE button flashes. Delete one of the edit points, and check that the DELETE button is not lit.

- 9 Press the PREVIEW button.

The editing screen changes to a full-screen viewer, which plays the edit section, including the preroll and postroll sections.

To reset edit points, repeat steps 5 to 9.

#### Preview execution range

The following figure shows the preview execution range for an example in which In and Out points were set in material C0225, and then material C0225 was inserted into sub clip C0002.

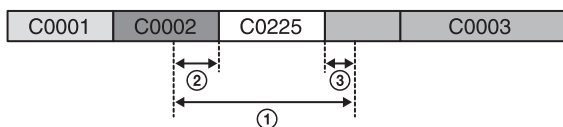

- ① Preview execution range
- ② Preroll time <sup>1)</sup>
- ③ Postroll time

- 1) When PLAYER SEL in the Edit Menu is set to “disc(clip)”, “disc(voice)” or “SxS”: 3 seconds  
When PLAYER SEL in the Edit Menu is set to “external”: The time specified by P-ROLL TIME in the Edit Menu.

#### Note

When PLAYER SEL in the Edit Menu is set to “external” and EDIT MODE is set to “insert”, the postroll section is not played.

- 10 Press the AUTO EDIT button.

The clip range specified in step 5 is added to the edit list in the edit mode specified in step 7, and the updated edit list is saved automatically.

If you did not load an edit list in step 2, use the Save Clip List as... command in the Edit Menu to save the edit list (see page 88).

When two edit points or less have been set, the editing screen changes into full-screen playback of a section until the edit section is confirmed, including the preroll and postroll sections.

#### Note

The preroll and postroll sections are not played when PLAYER SEL in the Edit Menu is set to “external”.

#### If you started an open-end edit

If you started an open-end edit (by setting the material and edit list In points only), then view the playback on the video monitor, watching for a frame to use as the end of the material. When the frame appears, press the ENTRY button while holding down the OUT button, or press the STOP button.

- 11 To add more material, repeat steps 3 to 10.

#### To review editing results

To review the editing results after an auto edit, press the PREVIEW button while holding the SHIFT button down. The editing screen changes to a full-screen viewer, which plays the edit section, including the preroll and postroll sections.

#### Review execution range

The following figure shows the review execution range for an example in which In and Out points were set in material C0225, and then material C0225 was inserted into sub clip C0002.

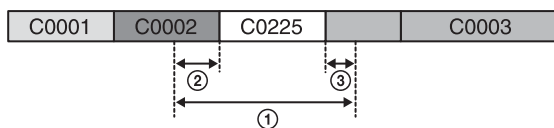

- ① Review execution range
- ② Preroll time: 3 seconds
- ③ Postroll time: 2 seconds

#### Recording range when PLAYER SEL is set to “external”

The range from 2 seconds before the In point to 2 seconds after the Out point is recorded to the disc.

**Note**

The editing operation does not end if a timecode break exists in the range described above.

## To adjust the In and Out points of sub clips (trim)

- 1 In the EDIT LIST screen, select a sub clip.
- 2 Press the RECALL button.

The Clip List (Trim) screen appears.

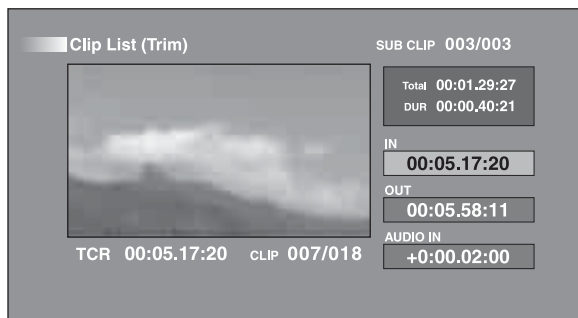

### To display a list of In and Out point operations that you can perform

Press the MENU button.

- 3 When you find the point that you want to make the start point, select “IN” and then press the PUSH SET knob.

The timecode of the new In point appears in the timecode display, and the Total (total duration) and DUR (clip duration) displays are updated.

- 4 When you find the point that you want to make the end point, select “OUT” and then press the PUSH SET knob.

The timecode of the new Out point appears in the timecode display, and the Total (total duration) and DUR (clip duration) displays are updated.

### To cue up the In point or Out point

Display the Edit Menu, select Cue up Inpoint or Cue up Outpoint, and then press the PUSH SET knob.

### To cancel the In point or Out point setting

Display the Edit Menu, select Reset Inpoint or Reset Outpoint, and then press the PUSH SET knob. The In point or Out point setting returns to the previous value.

- 5 Press the AUTO EDIT button.

The original sub clip is replaced with the range specified in steps 3 and 4, and the updated edit list is saved automatically.

If an edit list has not been loaded, use the Save Clip List as... command in the Edit Menu to save the edit list (*see page 88*).

- 6 Repeat steps 1 to 5 as required.

# Performing voice-over editing

## Conditions for use of voice-over editing functions

To use voice-over editing functions, the PDBZ-UPG03 Sony Software Upgrade Key for PDW-HR1 or PDBK-MK1 option board must be installed.

## Voice-over editing functions supported by the PDBZ-UPG03 Software Upgrade Key or PDBK-MK1 option board

The following functions are supported.

- Voice-over video first function
- Voice-over audio first function
- Audio level adjustment function
- Audio split editing function
- Voice move edit function
- Audio/voice data output signal mixing function

## Compatibility of voice-over editing discs

The following table shows the compatibility of voice-over editing discs used on various XDCAM devices.

Model name	Supported operations
PDW-HR1 (version 1.66 or higher) <sup>a)</sup>	<ul style="list-style-type: none"> <li>• Clip recording and playback</li> <li>• Playback of edit lists containing voice data</li> <li>• Creation and playback of edit lists not containing voice data</li> <li>• Reading and writing of files by FAM and FTP connections</li> </ul>
PDW-F1600/HD1500 (version 1.63 or higher) <sup>a)</sup>	
PDW-F800/700 (version 1.63 or higher) <sup>a)</sup>	
PDW-U1 (version 2.3.0 or higher) <sup>a)</sup>	Reading and writing of files by VFAM connection
PDW-510/510P	—
PDW-530/530P	<p><b>Note</b></p> <p>If you insert a disc containing voice-over data and then change a file name, the message “DIFF. INDEX” may appear. In this case, it may be impossible for XDCAM devices which support voice-over editing discs to read or write files on that disc. Do not use voice-over editing discs on these devices.</p>
PDW-539P	
PDW-1500	
PDW-V1	
PDW-R1	
PDW-D1	
PDW-F350/F355	
PDW-F330/F335	<p><b>Note</b></p> <p>If you insert a disc containing voice-over data, “NO SUPPORT” or “ILL INDEX” appears, and playback is impossible. Do not use voice-over editing discs on these devices.</p>
PDW-F70/F75	
PDW-F30	
PDW-70MD/75MD	

a) Upgrade to the latest version.

Contact a Sony sales representative for more information about support for voice-over editing functions by XDCAM devices and about XDCAM software application versions.

## Overview

You can add narration and other voice content by overlapping it with the audio of previously edited sub clips (voice-over editing).

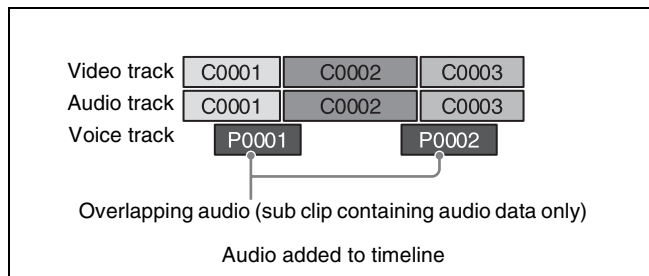

The following operations are possible in voice-over editing.

**Voice Over Video First:** After editing a sub clip (video and audio data), add overlapping voice-over audio.

**Voice Over Audio First:** After recording the voice-over audio (voice data), edit the sub clip.

**Audio level adjustment:** Adjust the levels of audio and voice data for the whole clip.

**Audio split editing:** Trim the audio In point with respect to the video In point, for effects in which the audio begins sooner or later than the video edit point.

**Voice move editing:** Move the position of voice data with respect to a video and audio sub clip.

## Preparations

**1** Connect the equipment that you plan to use to input the overlapping voice data (for example, a microphone) to a connector, such as the ANALOG AUDIO INPUT 1 or 2 connector.

**2** If you connect a microphone to the ANALOG AUDIO INPUT 1 or 2 connector, set the following items as required.

- MIC POWER (+48V) 1 or 2 switch
- Maintenance menu item M37: AUDIO CONFIG
- Setup menu items 834, 839, 840, and 841

## To add voice-over audio to a clip

**1** Do one of the following to prepare an edit target edit list.

- Select Load Clip List in the Edit Menu, and load the target edit list from the list that appears.
- Create a new edit list (see page 109).



**2** Set the following items in the Edit Menu.

**PLAYER SEL:** external

**EDIT PRESET:** Voice

**INPUT VOICE CH:** The channel to which you have connected the microphone or other input device (for example, CH 1)

**OUTPUT VOICE CH:** The channel on which you will record the voice data (for example, CH 8)

**3** Press the RECORDER button to switch to the RECORDER mode screen.

**4** Set In and Out points (*see page 109*), and specify the range across which you will add the voice-over (duration of the voice data).

**Note**

When you want to use the Voice Over Video First function, set the duration of the voice data to three minutes or less. The duration cannot be set to longer than three minutes.

The AUTO EDIT button begins to flash.

**5** Press the AUTO EDIT button, and input the voice-over from the microphone or other device.

The editing screen changes to full-screen display, and the editing segment is played back. The following text data is superimposed over the display in the video monitor.



Indicator showing that edit is being executed

Preroll time/edit execution time

When the auto edit finishes, the screen switches from full-screen display to the RECORDER mode screen.

**6** Check to make sure that a sub clip VO n (n: 1, 2, 3, ...) has been added to the voice track on the timeline.



Newly added sub clip (voice data)

**7** Repeat steps **3** to **6** as required.

**Note**

The maximum number of voice data sub clips that can be registered in a single edit list is 99.

**8** Play the edit segment and check the audio.

You can monitor voice data audio at  $\pm 1$  time normal speed.

**To add a clip to voice-over audio**

**1** Select Load Clip List from the Edit Menu, and select “New File” (new edit list) from the list that appears.

**2** Set the following items in the Edit Menu.

**PLAYER SEL:** external

**EDIT PRESET:** Voice

**INPUT VOICE CH:** The channel to which you have connected the microphone or other input device (for example, CH 1)

**OUTPUT VOICE CH:** The channel on which you will record the voice data (for example, CH 8)

**3** Press the RECORDER button to switch to the RECORDER mode screen.

The AUTO EDIT button begins to flash.

**4** Press the AUTO EDIT button, and input the voice-over from the microphone or other device.

If you are editing with the Voice Over Video First function, you can record three minutes or more of voice data.

**To stop the recording**

Do one of the following.

- With the OUT button held down, press the ENTRY button.
- Press the STOP button.

**5** Check to make sure that a sub clip VO 1 and an empty video and audio data sub clip have been added to the timeline.

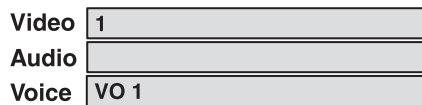

**6** Edit sub clip 1 (*see page 109*).

**To adjust the audio levels**

The following figure shows voice data adjusted to a relatively high level, and audio data that overlaps with the voice data set to a relatively low level. You can adjust the

relative levels of audio data and voice data in this way for the whole clip.

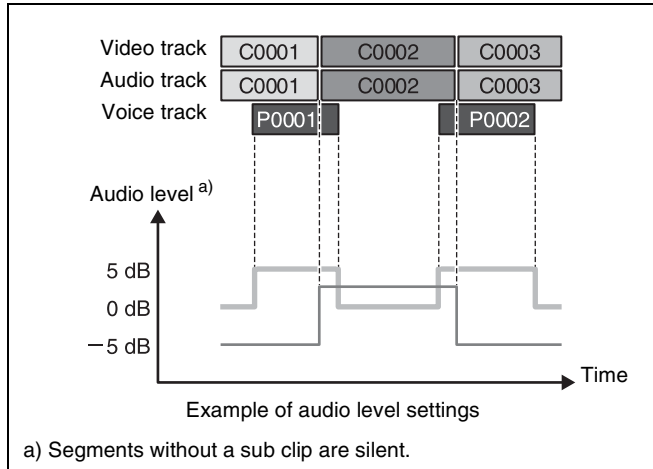

- 1 In the EDIT LIST screen, select the sub clip whose audio level you want to adjust (multiple selections possible).
- 2 In the Edit Menu, select Audio Level, and then press the PUSH SET knob.

A spin box for adjusting the audio level appears. The original audio level of the sub clip is displayed as “0dB”.

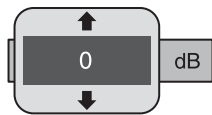

- 3 Do one of the following to change the audio level.
  - Press the PUSH SET knob.
  - Press the ▲/MARK1 button or ▼/MARK2 button.
  - Put the shuttle/jog dial into jog mode (JOG indicator: lit), and then turn the dial.

You can adjust the level in units of 1 dB over the range  $-\infty$  (silent),  $-80\text{dB}$  to  $0\text{dB}$  to  $12\text{dB}$ .

- 4 Press the PUSH SET knob.
- 5 With “OK” selected, press the PUSH SET knob.  
The AUTO EDIT button begins to flash.
- 6 Press the AUTO EDIT button.  
This confirms the change in the audio level.
- 7 Press the PREVIEW button to play the edit segment and check the audio level.

## To perform audio split editing

The following figure shows an example of a sub clip C0002 with the audio In point trimmed to +2 seconds after the video In point. In this kind of audio split editing, you can obtain effects in which the audio begins up to  $\pm 2$  seconds sooner or later than the video.

### Note

When EDIT PRESET in the Edit Menu is set to “Clip”, it is not possible to perform other editing operations in segments that have been audio split edited.

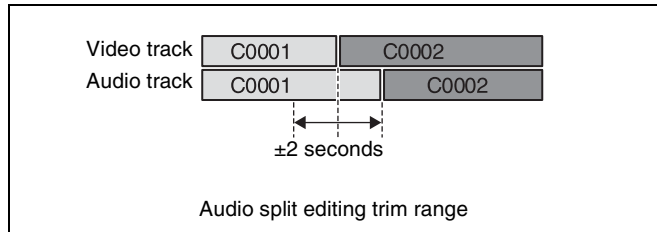

- 1 In the EDIT LIST screen, select the sub clip for which you want to perform audio split editing.

### To operate in the Clip List (Trim) screen

After performing step 1, press the RECALL button to switch to the Clip List (Trim) screen.

### Note

When multiple sub clips are selected, only the sub clip at the cursor position is the target of the editing. (The sub clips that are not targeted are deselected.)

- 2 With the GOTO button held down, press the + TRIM button or the – TRIM button. Or, with the GOTO button held down, turn the PUSH SET knob.

The audio In point is trimmed by one frame, and the AUTO EDIT button begins to flash.

### Note

In the Clip List (Trim) screen, it is not possible to change the In point of a sub clip that has a voice-over specification.

- 3 Press the AUTO EDIT button.

The results of the audio split editing are confirmed.

## To move the position of voice data

Use the following procedure to move the In point of the voice data of a sub clip. You can move the data to any position from the first frame to the last frame +1 of the sub clip.

## Notes

- Voice data movement is done in overlay mode. If voice data already exists at the position you move to, it is overwritten.
- If the sub clip contains an empty section with no recorded video, audio, or voice data, the empty section is deleted when you move voice data.

- 1 In the EDIT LIST screen, select the sub clip that contains the voice data that you want to move.

### To operate in the Clip List (Trim) screen

After step 1, press the RECALL button to switch to the Clip List (Trim) screen.

- 2 With the GOTO button held down, press the + TRIM button or the – TRIM button. Or, with the GOTO button held down, turn the PUSH SET knob.

The voice In point moves by one frame.

- 3 Press the AUDIO EDIT button.

The voice data move is confirmed.

## To set up mixing of audio/voice data output signals

By setup menu settings, you can mix voice and audio data output signals into the output signals of specified channels (1 to 8).

- 1 Set MIX/SWAP on the P2 AUDIO page of the function menu to “ON”.
- 2 Display setup menu item 843 AUDIO OUTPUT ARRANGE.

See page 138 for more information about setup menu operations.

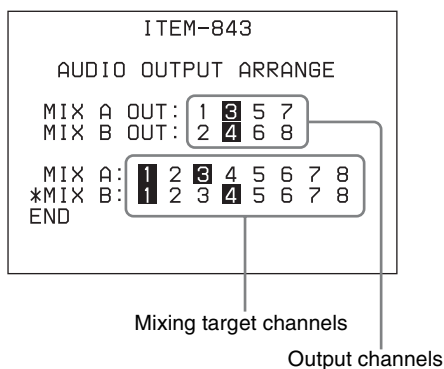

- 3 Turn the PUSH SET knob to move “\*” to MIX A OUT or MIX B OUT, and then press the PUSH SET knob.

- 4 Turn the PUSH SET knob to move “→” to the channel that you want to designate for mixing, and then press the PUSH SET knob.

You can now turn the selected output channel on and off.

### To toggle the output channel on (highlighted) or off

Do one of the following.

- Turn the PUSH SET knob.
- Press the – or + function button (F3 or F4).

### To confirm the settings

Press the PUSH SET knob.

- 5 Repeat steps 3 and 4 to set the required output channels.

You can select multiple channels for both MIX A OUT and MIX B OUT.

- 6 Turn the PUSH SET knob to move “\*” to MIX A OUT or MIX B OUT, and then press the PUSH SET knob.

- 7 Turn the PUSH SET knob to move “→” to the audio/voice data output channel that you want to designate for mixing, and then press the PUSH SET knob.

You can now turn the make an on or off setting for the selected channel.

- 8 Repeat steps 6 and 7 to set the channels that you want to mix.

You can select multiple channels for both MIX A and MIX B.

- 9 Press the SAVE function button (F5).

The settings are saved and the unit exits settings mode. Audio and voice signals are mixed into the specified output channels.

## To display voice clips

Insert a disc with recorded voice clips into the unit, and then press the DISPLAY button in the clip thumbnail screen. This switches the screen to the voice clip screen. You can check the voice clips recorded with the voice-over editing functions.

## Overview

A remote computer can be connected to this unit and used to operate on recorded data which has been saved in data files, such as video and audio data files.

There are two ways to connect a remote computer.

- FAM connection  
Connect the **i** (i.LINK) S400 FAM connector on this unit to the i.LINK (IEEE1394) connector on the remote computer, using an i.LINK cable (*see page 37*).
- FTP connection  
Connect the network connectors on this unit and the remote computer, using a network cable (*see page 37*).

## Directory structure

The following figure shows the directory structure of discs visible to a remote computer.

### Note

This structure is not the same as the actual structure recorded on the disc.

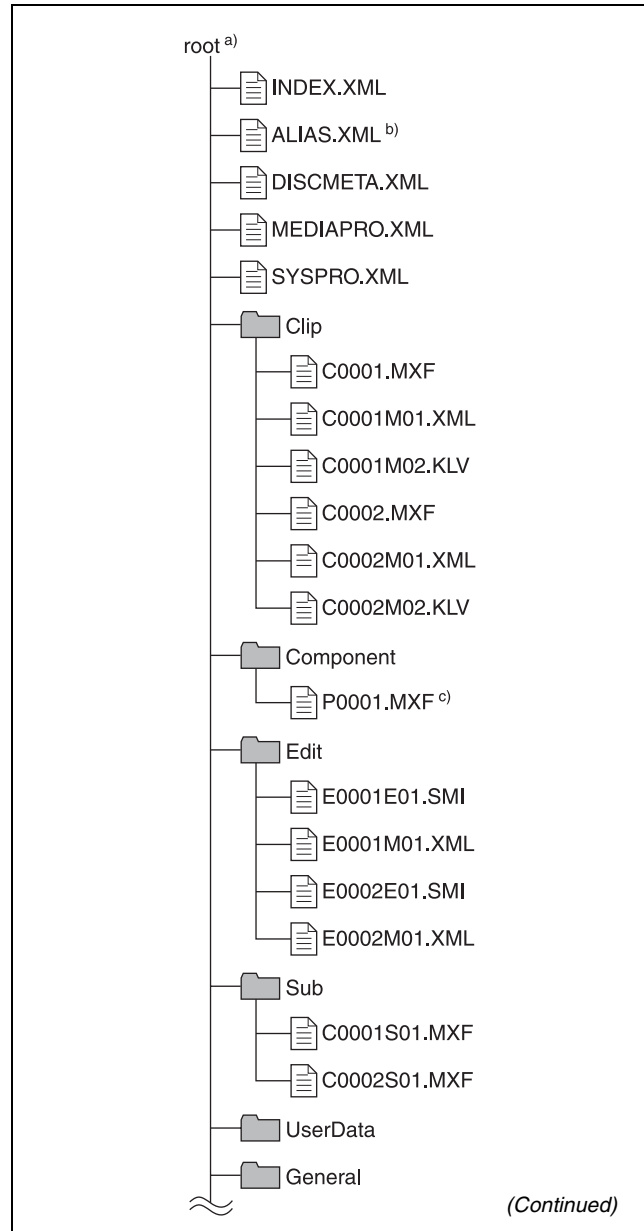

(Continued)

a) Root directory

b) Only when sub item NAMING FORM of setup menu item 036 is set to "free"

c) Files generated when voice over editing is executed.

**Note**

Voice-over editing function is enabled when the PDBZ-UPG03 Software Upgrade Key or PDBK-MK1 option board is installed.

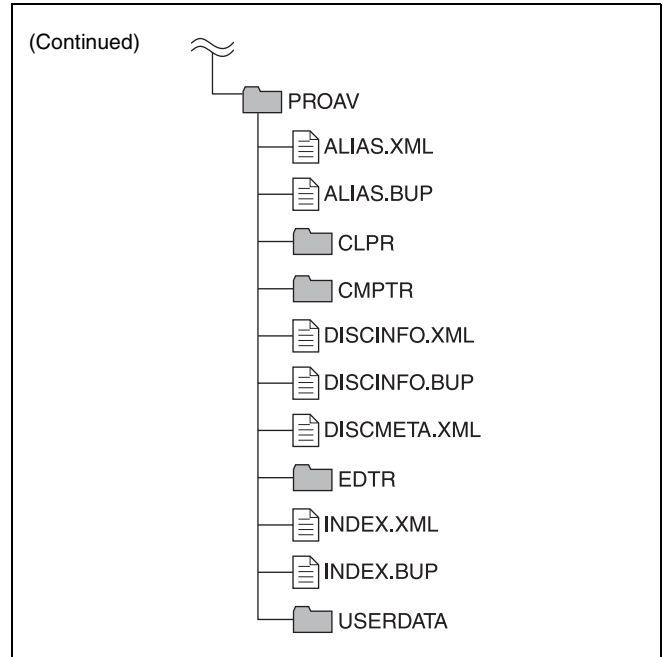

## File operation restrictions

This section explains which operations are possible on files stored in each directory.

When required, the following operation tables distinguish reading and writing from partial reading and writing.

**Read:** Read data sequentially from the start to the end of the file.

**Partial read:** Read only a part of the data in the file.

**Write:** Write data sequentially from the start to the end of the file.

**Partial write:** Write data to a part of the file only.

**Note**

Operations other than Read and Partial read are possible only when the Write Inhibit tab of the disc is set to recording enabled and REC INH on HOME page of the function menu is set to “OFF”.

## Root directory

File name	Content	Operations				
		Read/Partial read	Write/Partial write	Rename	Create	Delete
INDEX.XML	Contains data for management of the material on the disc.	Yes	No	No	No	No
ALIAS.XML <sup>a)</sup>	Contains conversion tables for assigning user-defined names to clips and clip lists.	Yes	No	No	No	No
DISCMETA.XML	Contains metadata to indicate the disc properties.	Yes	Yes <sup>b)</sup>	No	No	No
MEDIAPRO.XML	Contains a list of material on the disc, basic properties, related information, and information about access methods.	Yes	No	No	No	No
SYSPRO.XML	Contains information about device system settings and menu settings.	Yes	No	No	No	No
Other files	Files other than the above	–	No	–	No	–

a) Only when sub item NAMING FORM of setup menu item 036 is set to “free”

b) Only files which can be written by XDCAM

**Notes**

- Directories cannot be created in the root directory.

- The directories in the root directory (Clip, Edit, Sub, UserData, General, and PROAV) cannot be deleted or renamed.

**Clip directory**

File name	Content	Operations				
		Read/Partial read	Write/Partial write	Rename	Create	Delete
C*.MXF <sup>a)</sup>	Clip file created by recording (MXF file) *: 0001 to 9999	Yes	Yes <sup>b), c)</sup>	Yes <sup>d)</sup>	Yes <sup>b)</sup>	Yes <sup>e)</sup>
C*M01.XML <sup>a)</sup>	Metadata file generated automatically when C*.MXF file is created. *: 0001 to 9999	Yes	Yes <sup>f)</sup>	No <sup>g)</sup>	No <sup>h)</sup>	No <sup>i)</sup>
C*M02.KLV <sup>a)</sup>	User metadata file. This type of file is generated automatically during recording via an FTP or FAM connection when the unit recognizes that an MXF file contains metadata that was generated by a non-XDCAM device. *: 0001 to 9999	Yes	Yes <sup>e)</sup>	No <sup>g)</sup>	Yes <sup>f)</sup>	Yes <sup>i)</sup>
Other files	Files other than the above	–	No	–	No	–

- a) The unit can handle files with user-defined names in the “C\*” part.
- b) Only files which are 2 seconds or longer in length, in a format matching the format (system frequency) and recording format (MPEG HD and number of audio channels) of the recorded sections of the disc, and which can be overwritten by XDCAM.
- c) Overwriting is not possible.
- d) Only when sub item NAMING FORM of setup menu item 036 is set to “free”.
- e) Any clip may be selected and deleted.
- f) Only files which can be written by XDCAM

- g) When the “C\*” part of a C\*.MXF file name is changed, a C\*M01.XML file and a C\*M02.KLV file with the same name in the “C\*” part is also changed automatically.
- h) When a C\*.MXF file is created, a C\*M01.XML file with the same name in the “C\*” part is created automatically.
- i) When a C\*.MXF file is deleted, a C\*M01.XML file and a C\*M02.KLV file with the same name in the “C\*” part is also deleted automatically.

**Note**

Directories cannot be created in the Clip directory.

**Component directory**

File name	Content	Operations				
		Read/Partial read	Write/Partial write	Rename	Create	Delete
P*.MXF <sup>a)</sup>	Audio clip files (MXF files) generated when you execute voice over editing on the PDW-HR1 *: 0001 to 0099	Yes	Yes <sup>b), c)</sup>	Yes <sup>e)</sup>	Yes <sup>b), d)</sup>	Yes <sup>f)</sup>
Other files	Files other than the above	–	No	–	No	–

- a) The “P\*” part can be handled like a file with a user-defined name.
- b) Only files which are 2 seconds or longer in length and which can be written by XDCAM.
- c) Overwriting is not possible.
- d) Multiple files cannot be opened at the same time.
- e) Only when sub item NAMING FORM of setup menu item 036 is set to “free”.
- f) Selection and deletion of any specified clip is possible.

- Voice-over editing function is enabled when the PDBZ-UPG03 Software Upgrade Key or PDBK-MK1 option board is installed.

**Notes**

- Directories cannot be created in the Component directory.

## Edit directory

File name	Content	Operations				
		Read/Partial read	Write/Partial write	Rename	Create	Delete
E*E01.SMI <sup>a)</sup>	Clip list file *: 0001 to 0099	Yes	Yes <sup>b)</sup>	Yes <sup>c)</sup>	Yes <sup>d)</sup>	Yes
E*M01.XML <sup>a)</sup>	Metadata file generated automatically when E*E01.SMI file is created. *: 0001 to 0099	Yes	Yes <sup>b)</sup>	No <sup>e)</sup>	No <sup>f)</sup>	No <sup>g)</sup>
Other files	Files other than the above	–	No	–	No	–

- a) The “E\*” part can be changed to a user-defined name.  
 b) Only files which can be written by XDCAM. Partial writing is not possible.  
 c) Only when sub item NAMING FORM of setup menu item 036 is set to “free”.  
 d) Only files which can be written by XDCAM  
 e) When the “E\*” part of an “E\*01.SMI” file name is changed, an E\*M01.XML file with the same name in the “E\*” part is also changed automatically.

- f) When an E\*E01.SMI file is created, an E\*M01.XML file with the same name in the “E\*” part is also generated automatically.  
 g) When an E\*E01.SMI file is deleted, an E\*M01.XML file with the same name in the “E\*” part is also deleted automatically.

### Note

Directories cannot be created in the Edit directory.

## Sub directory

File name	Content	Operations				
		Read/Partial read	Write/Partial write	Rename	Create	Delete
C*S01.MXF <sup>a)</sup>	Proxy AV data (MXF) file generated automatically when a C*.MXF file is created. *: 0001 to 9999	Yes	No	No <sup>b)</sup>	No <sup>c)</sup>	No <sup>d)</sup>
Other files	Files other than the above	–	No	–	No	–

- a) The “C\*” part can be changed to a user-defined name.  
 b) When the “C\*” part of a C\*.MXF file name is changed, a C\*S01.MXF file with the same name in the “C\*” part is generated automatically.  
 c) When a C\*.MXF file is created, a C\*S01.XML file with the same name in the “C\*” part is generated automatically.  
 d) When a C\*.MXF file is deleted, the C\*S01.XML file with the same name in the “C\*” part is also deleted automatically.

### Note

Directories cannot be created in the Sub directory.

## UserData directory

File name	Content	Operations				
		Read/Partial read	Write/Partial write	Rename	Create	Delete
Any file		Yes	Yes	Yes <sup>a)</sup>	Yes	Yes

- a) UTF-8 file names can be up to 63 bytes in length. (Depending on the character type, file names (including extension) may be limited to 21 characters.)

The following directory operations are possible in the UserData directory.

- Directory creation (up to 62 levels, including the UserData directory)
- Deletion and renaming of directories

## General directory

File name	Content	Operations				
		Read/Partial read	Write/Partial write	Rename	Create	Delete
Any file		Yes	Yes	Yes <sup>a)</sup>	Yes	Yes

a) UTF-8 file names can be up to 63 bytes in length. (Depending on the character type, file names (including extension) may be limited to 21 characters.)

The following directory operations are possible in the General directory.

- Directory creation (up to 63 levels, including the General directory)
- Deletion and renaming of directories

**Notes**

- The maximum number of files that can be created on a disc is 5,000 for single-layer discs and 6,000 for dual-layer discs (both including directories).
- File names and directory names can use letters, numbers, and symbols from the Unicode 2.0 (UTF-8) character set.

However, the following control characters and symbols <sup>1)</sup> cannot be used.

- Control characters: U+0000 to U+001F, U+007F
- Symbols: ", \*, /, :, <, >, ?, \, |

1) The following character codes cannot be used by FAM connections.  
 U+010000, U+020000, U+030000, U+040000, U+050000, U+060000,  
 U+070000, U+080000, U+090000, U+0A0000, U+0B0000, U+0C0000,  
 U+0D0000, U+0E0000, U+0F0000, U+100000

**PROAV directory**

This directory contains individual files recorded on the disc.

To display the PROAV directory, set maintenance menu item M33: FILE I/F CONFIG > PROAV DISPLAY to “ENABLE”.

**Assigning user-defined clip titles**

By default, clips on each disc are assigned names in the range C0001.MXF to C9999.MXF. For this reason, two discs can contain clips with the same names. The automatic title generation function allows you to assign titles to all of the clips on several discs, which facilitates clip management. For example, if the titles TITLE00001 to TITLE00020 are assigned to clips C0001.MXF to C0020.MXF on disc 1, then the titles TITLE00021 to TITLE00037 are assigned to clips C0001.MXF to C0017.MXF on disc 2.

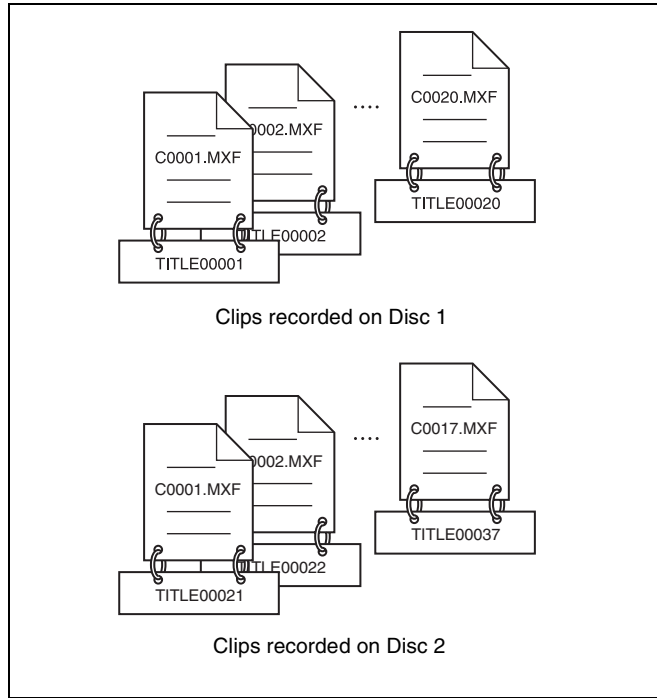

Proceed as follows to specify a title and assign it to recorded clips.

- 1 Press the MENU button.
- 2 Turn the PUSH SET knob to select setup menu item 035, and press the knob.
- 3 Turn the PUSH SET knob to select “on”, and press the knob.

The clip title naming screen appears.

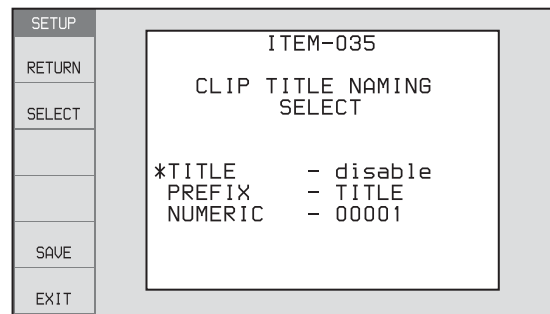

- 4 Turn the PUSH SET knob to move the asterisk (\*) on the left of the menu items to “TITLE”, and press the knob.

The asterisk indicates the selected item.

- 5 Turn the PUSH SET knob to select “enable”, and press the knob.

The automatic title generation function is enabled.



- 6** Turn the PUSH SET knob to move the asterisk (\*) on the left of the menu items to the item you want to select, and press the knob.

**PREFIX:** A string of up to 10 characters. The allowable characters are alphanumeric characters, symbols (! # \$ % & ' ( ) + , - . ; = @ [ ] ^ \_ { } ~), and the space character.

**NUMERIC:** A five-digit number (00001 to 99999) to serve as the initial value of the serial number.

- 7** Turn the PUSH SET knob to select the character position to set, and press the knob.
- 8** Turn the PUSH SET knob to select the character to set.
- 9** Repeat steps **7** and **8** as required.

When you are setting the “NUMERIC” item, you can press the RESET button to return the initial value of the serial number to 00001 (factory default setting).

- 10** Carry out steps **7** to **9** to set the other item.

- 11** Press the SAVE function (F5) button.

The title is saved.

### To check the titles of recorded clips

Press the THUMBNAIL/ESSENCE MARK button to display the thumbnail screen, and select the clip whose title you want to check.

The title of the selected clip appears at the upper left of the screen.

See “Thumbnail Operations” (page 72) for more information about the thumbnail screen.

### Notes

- The value of the serial number is incremented by 1 every time a title is generated. When the value reaches 99999, the next number restarts from 00001.
- Duplicate clip titles can be generated if you reset the serial number after recording several clips or the same is true depending on the value setting. Care should be taken when setting the serial number.
- The “PREFIX” setting is saved in memory banks, but the “NUMERIC” setting is not saved (see page 137).

## Assigning user-defined clip and clip list names

The following standard format names are assigned automatically to clips and clip lists that are created or recorded by XDCAM devices.

Clips: C0001.MXF to C9999.MXF

Clip lists: E0001E01.SMI to E0099E01.SMI

This unit can handle clips and clip lists with user-defined names as well as names in the standard format.

### Limitations

- Letters, numbers and symbols from the Unicode 2.0 character set can be used. However, the following control characters and symbols cannot be used.
  - Control characters: U+0000 to U+001F, U+007F
  - Symbols: ", \*, /, :, <, >, ?, \, |
- Depending on the character type, the length of user-defined names (the “C\*” or “E\*E01” part) may be limited to 14 characters. (The limit for ASCII characters is 56 characters.)
- All file name extensions are converted automatically to uppercase.
- Titles are used as user-defined clip names on this unit. Therefore, the available characters are limited to those supported by the title function.
- Files generated along with clips and clip lists use the same names (the “C\*” or “E\*” part of the following file names).
  - Clips: Metadata files (C\*M01.XML), user metadata files (C\*M02.KLV), proxy AV data files (C\*S01.MXF)
  - Clip lists: Metadata files (E\*M01.XML)
- The following names cannot be assigned.
  - Clips: C0000.MXF
  - Clip lists: E0000E01.SMI, E0100E01.SMI to E9999E01.SMI, E0000.SMI, E0100.SMI to E9999.SMI
- The following names should be avoided.
  - Clips: C5000.MXF to C9999.MXF
  - Clip lists: E0001.SMI to E0099.SMI

### To assign clip names on this unit

The title assigned to clip becomes its clip name (file name).

### Notes

- When the first letter of the title setting with setup menu item 035 CLIP TITLE NAMING SELECT is a space or period (.), the clip name is the title string minus the first letter.
- An FTP client that supports UTF-8 is required to use Unicode characters other than ASCII characters. Command prompt FTP commands do not support UTF-8.

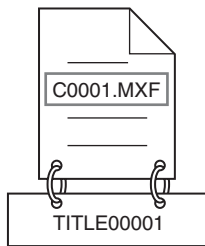

When the “AUTO NAMING” sub item of setup menu item 036 is set to “C\*\*\*\*”

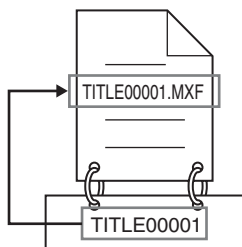

When the “AUTO NAMING” sub item of basic menu item 036 is set to “title”

- 1 Before you start, set the “TITLE” sub item of setup menu item 035 CLIP TITLE NAMING SELECT to “enable”, and set a title (see the previous section).
- 2 Press the MENU button.
- 3 Turn the PUSH SET knob to select setup menu item 036.
- 4 Turn the PUSH SET knob to move the “\*” to the left of the item names to “NAMING FORM”.

The “\*” indicates the selected item.

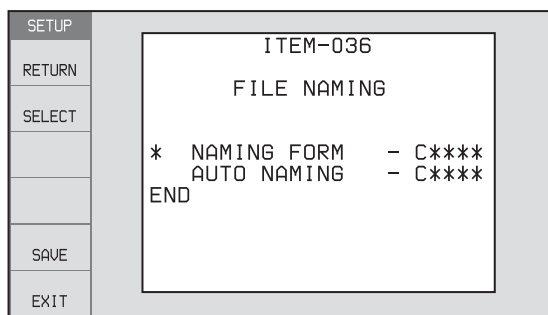

- 5 Turn the PUSH SET knob to select “free”, and press the knob.  
You are now able to use clips and clip lists with user-defined names.
- 6 Turn the PUSH SET knob to move the “\*” to the left of “AUTO NAMING”, and press the knob.

7 Turn the PUSH SET knob to select “title”, and press the knob.

8 Press the SAVE function (F5) button.

The same name will now be given to newly recorded clips.

### To use clips and clip lists with user-defined names over FAM and FTP connections

Carry out steps 2 to 5 of “To assign clip names on this unit”, and then press the SAVE function (F5) button. It is now possible to write, transfer, and rename clips and clip lists with user-defined names over file access mode (FAM) connections (page 123) and FTP connections (page 126).



Able to use clips with user-defined names over FAM and FTP connections



Able to use clip lists with user-defined names over FAM and FTP connections

### To check clip names

Press the THUMBNAIL/ESSENCE MARK button to display the thumbnail screen, and select the clip whose name you want to check.

The name of the selected clip appears at the upper left of the screen.

See “Thumbnail Operations” (page 72) for more information about the thumbnail screen.

### Note

The item at the upper left of the screen is displayed according to the following order of priority.  
Title > User-defined clip name > Standard format clip name  
Therefore, the display of this item changes as following, depending on whether there is a title.

- When a title has been set as a clip name on this unit, for clips recorded on this unit, the title is displayed.
- The user-defined name or standard format name is displayed for clips without a title.

# File Operations in File Access Mode (for Windows)

## File access mode operating environment

Operating system requirements for file operations by file access mode (called FAM below) are as follows.

- Computer operating system: Microsoft Windows XP Professional SP3 or higher, Microsoft Windows Vista Business/Ultimate (32 bit/64 bit) SP2 or higher, or Microsoft Windows 7 Professional/Ultimate (32 bit/64 bit)

## Preparations

Install the FAM driver on the remote computer (*see the next section*).

### To install the FAM driver

Insert the supplied CD-ROM (Utility Software for XDCAM) into the CD-ROM drive of your computer, navigate to the FAM Driver directory, and run the installer in the directory for your operating system, then follow the installation instructions.

*For details, refer to the ReadMe file contained on the CD-ROM disc.*

### Note

Use Version 2.10 or higher of the FAM driver. The FAM driver on the supplied CD-ROM is Version 2.10 or higher. If a FAM driver is already installed on your computer, check the version.

### To check the version

#### For Windows XP:

Select “ProDisc” from “Add or Remove Programs” in the control panel, and then click “Click here for support information”.

#### For Windows Vista:

- (1) Open “Programs” > “Programs and Functions” in the control panel, and then right click the header (where “Name” and “Supplier” are displayed) and select “Other...”.
- (2) In the Advanced Settings dialog, check “Version” and click “OK”. The version column appears. Check the version of “ProDisc”.



#### For Windows 7:

Open “Programs and Features” in the control panel, and then check the version of “ProDisc”.

## Making FAM connections

- 1 If there is a disc loaded in this unit, put the unit into the following state.
  - Recording, playback, search and other disc operations (*see page 55*): Stopped
  - THUMBNAIL/ESSENCE MARK button (*see page 17*): Off
  - Disc access by Lock or Delete All Clips, Format Disc, and so on in the Disc Menu (*see page 70*): Stopped
  - Unsaved current clip list: Save or clear
- 2 If this unit is connected to a remote computer by FTP, log out from the FTP session (*see page 127*).
- 3 Connect the  (i.LINK) S400 FAM connector on this unit to the i.LINK (IEEE1394) connector on the remote computer, using an i.LINK cable (*see connections illustration on page 37*).
- 4 Press the PC REMOTE button, lighting it. (This enables remote access (*see page 16*)).

Windows recognizes this unit as a removable disc, and displays one of the following icons on the remote computer’s task bar:

- Windows XP: 
- Windows Vista or Windows 7: 

The remote computer is now able to perform file operations when a disc is inserted into this unit.

### Note

You will not be able to log in if you put the unit into the state described in step 1 after connecting the cable. To log in, press the PC REMOTE button, turning it off, put the unit into the state described in step 1, and connect it again.

### When you make your first FAM connection

The Found New Hardware Wizard dialog appears when you connect this unit to your computer. Select “Install the software automatically (Recommended)”, and then click the Next button. Click the Finish button when the software installation finishes.

### Operation limitations during FAM connections

- Control panel operations are disabled, except for operations with the EJECT button.
- This unit cannot be controlled from devices connected to the REMOTE(9P) connector (D-sub 9-pin) and  (i.LINK) S400 FAM connector.
- Signal input to this unit and signal output from this unit are stopped.

---

## Operating on files

### 1 Start Explorer.

Check that a drive letter has been assigned to this unit. (The drive letter will differ depending on the number of other peripherals connected to the remote computer.)

### 2 Use Explorer to perform file operations on the disc loaded in this unit.

You can operate in the same way that you operate on local drives and files on network computers.

#### Notes

- If you power this unit off during an FAM connection, the data transferred thus far is discarded.
- All file operations are not possible for some types of files.

For details, see “File operation restrictions” (page 117).

### To eject discs from a remote computer

Right click the icon representing this unit in Explorer, and select “Eject” from the menu which appears.

---

## Exiting file operations

### For Windows XP or Windows Vista

#### Note

Do not disconnect the cable before performing steps 1 to 3.

### 1 Do one of the following on the or icon displayed in the remote computer’s taskbar.

- Double click.
- Right click, and select the “Safely Remove Hardware”.

The “Safely Remove Hardware” dialog appears.

### 2 Select “Sony XDCAM PDW-HR1 IEEE 1394 SBP2 Device” and click “Stop”.

The “Stop a Hardware device” dialog appears.

### 3 Select “Sony XDCAM PDW-HR1 IEEE 1394 SBP2 Device” and click “OK”.

- **Windows XP:** “Sony XDCAM PDW-HR1 IEEE 1394 SBP2 Device” is deleted from the “Hardware devices” list.

- **Windows Vista:** A message appears to inform you that you can now safely remove the device from your computer.

This unit can now resume normal operations. (The limitations described in “Operation limitations during FAM connections” no longer apply.)

### 4 Press the PC REMOTE button, turning it off. (This disables remote access (see page 16).)

## For Windows 7

#### Note

Do not disconnect the cable before performing step 1.

### 1 Click the icon displayed in the remote computer’s taskbar, and then click “Eject Solid state disk”.

“The ‘Sony XDCAM PDW-HR1 IEEE 1394 SBP2 Device’ device can now be safely removed from the computer” appears.

This unit can now resume normal operations. (The limitations described in “Operation limitations during FAM connections” no longer apply.)

### 2 Disconnect the i.LINK cable as required.

## To reconnect

Press the PC REMOTE button, lighting it. This makes it possible to access this unit from a computer.

---

# File Operations in File Access Mode (for Macintosh)

## File access mode operating environment

Operating system requirements for file operations by file access mode are as follows.

- Computer operating system: Mac OS X 10.4.11 or higher

## Preparations

Do the following on the remote computer and this unit.

- Install the FAM driver on the remote computer (*see the next item*).

### To install the FAM driver

Insert the supplied CD-ROM (Utility Software for XDCAM) into the CD-ROM drive of your computer, and execute the dmg file in FAM Driver >Mac >FAM Driver, then follow the installation instructions.

*For details, refer to the ReadMe file contained on the CD-ROM disc.*

### To check the FAM driver version

Connect this unit to your computer with an i.LINK cable, and then, with a disc loaded, start the system profiler utility of the application. The version appears to the right of “prodisk\_fs” when you select “Advanced Functions” under “Software”.

---

## Making FAM connections

- 1 If there is a disc loaded in this unit, put the unit into the following state.

- Recording, playback, search and other disc operations (*see page 55*): Stopped
- THUMBNAIL/ESSENCE MARK button (*see page 17*): Off
- Disc access by clip deletion, disc formatting, etc.: Stopped
- MENU button (*see page 17*): Off
- Unsaved current clip list: Save or clear

- 2 Connect the **i** (i.LINK) S400 FAM connector on this unit to the i.LINK (IEEE1394) connector on the remote computer, using an i.LINK cable (*see page 37*).

- 3 Press the PC REMOTE button, lighting it. (This enables remote access (*see page 16*).

When a disc is inserted into this unit, the remote computer recognizes this unit as a removable disc. The following icon appears in the Finder on the remote computer, indicating that the computer is now able to perform file operations.



Untitled

## Operation limitations during FAM connections

- With the exception of the EJECT button, recording buttons and playback control buttons are disabled.
- Do not use the EJECT button to eject discs. Always eject discs from the computer.
- Do not disconnect the i.LINK cable during a FAM connection. Doing so may result in unstable operation. Always eject any loaded disc before disconnecting the i.LINK cable.

---

## Operating on files

Proceed as follows.

- 1 Start the Finder.

Check to be sure that a drive has been assigned to this unit.

- 2 Operate from the Finder on the files on the disc in this unit.

You can operate in the same way that you operate on local drives and files on network computers.

### Notes

- If you power this unit off during a FAM connection, the data transferred thus far is discarded.
- All file operations are not possible for some types of files.

*For details, see “File operation restrictions” (page 117).*

## To eject discs from a remote computer

Click the eject button to the right of the icon for this unit in the Finder, or drag the icon for this unit from the Finder to the Trash.

---

## Exiting file operations

Proceed as follows.

### Note

Do not disconnect the cable before performing steps **1** and **2**.

- 1** Eject the disc by clicking the eject button to the right of the icon for this unit in the Finder, or by dragging the icon for this unit from the Finder to the Trash.
- 2** Press the PC REMOTE button, turning it off. (This disables remote access (*see page 16*).)

### To make a reconnection

Press the PC REMOTE button, lighting it.  
This makes it possible to access this unit from a computer.

---

## FTP File Operations

File operations between this unit and a remote computer can be carried out by the File Transfer Protocol (called FTP below).

### Preparations

- 1** Connect the network connectors of this unit and a remote computer with a network cable (*see connections illustration on page 37*). Or connect this unit to the network to which the remote computer is connected (*see connections illustration on page 37*).
- 2** Set the IP address and other network setting items for this unit.<sup>1)</sup>

*For details, see “To change network settings” (page 162).*

**If network settings have already been made**  
Check the IP address of this unit.

*For details, see “To check the assigned IP address” (page 162).*

1) This unit is able to acquire an IP address automatically from a DHCP server. It also supports an Auto-IP function to assign an IP address automatically when access from this unit to the DHCP server times out. You can check DHCP settings and the assigned IP address on page M5:NETWORK of the maintenance menu.

### Note

If this unit is directly connected to a computer running Windows Vista with a network cable, change the setting as follows:

(1) Open “Network and Sharing Center” > “Manage network connections” > “Local Area Connection” in the control panel. (2) In the “Local Area Connection Properties”, uncheck the “Internet Protocol Version 6 (TCP/IPv6)”, and then click the OK button.

- 3** Set the remote control switch to “NET” (*see page 16*).

---

## Making FTP connections

FTP connections between this unit and a remote computer can be made with either of the following.

- The command prompt
- FTP client software

This section explains how to use the command prompt. For more information about using FTP client software, refer to the documentation of the FTP client software on your system.

## Note

An FTP client that supports UTF-8 is required to use Unicode characters other than ASCII characters. Command prompt FTP commands do not support UTF-8.

## To log in

If this unit is connected to a remote computer with a FAM connection, first exit file operations on the FAM connection (*see page 124*).

- 1 Load a disc into this unit and put the unit into the following state.
  - Recording, playback, search and other disc operations (*see page 55*): Stopped
  - THUMBNAIL/ESSENCE MARK button (*see page 17*): Off
  - Disc access by Lock or Delete All Clips, Format Disc, and so on in the Disc Menu (*see page 70*): Stopped

## Note

Login is not possible unless a disc is loaded and the unit is in the state described above.

- 2 Start the command prompt.
- 3 Enter “ftp <SP> <IP address>”, and press the Enter key. (<SP> refers to a space.)

For example, if the IP address of this unit is set to “192.168.001.010”, enter “ftp 192.168.1.10”.

*Refer to the Windows help for more information about the FTP command.*

If the connection succeeds, you are prompted to enter a user name.
- 4 Enter the user name “admin” and press the Enter key.

When the user name is verified, you are prompted to enter a password.
- 5 Enter the password and press the Enter key.

The password is set to “pdw-hr1” when the unit is shipped from the factory. The login is complete when the password is verified.

*See page 127 for the FTP protocol commands supported by this unit.*

### If the connection times out

This unit terminates FTP connections if no command is received within 90 seconds of the last command. If this occurs, log out (see the next section) and repeat steps 2 to 4.

## Note

If you power this unit off during an FTP connection, the data transferred thus far is discarded.

## To log out

To log out after finishing file operations, enter “QUIT” at the command prompt and press the Enter key.

## Command list

The FTP protocol commands supported by this unit include standard commands (see the next section) and extended commands (*see page 130*).

## Notes

- To execute FTP commands, you must install application software with FTP function on your computer.
- The commands supported by application software vary.
- In the command syntax, <SP> means a space, entered by pressing the space bar, and <CRLF> means a new line, entered by pressing the Enter key.

## Standard commands

### USER

Send this command to begin the login process.

**Command syntax:** USER <SP> <user name> <CRLF>

**Input example:** USER admin

### PASS

After sending the USER command, send this command to complete the login process.

**Command syntax:** PASS <SP> <password> <CRLF>

**Input example:** PASS pdw-hr1

### QUIT

Terminates the FTP connection. If a file is being transferred, terminates after completion of the transfer.

**Command syntax:** QUIT <CRLF>

### PORT

Specifies the IP address and port to which this unit should connect for the next file transfer (for data transfer from this unit).

**Command syntax:** PORT <SP> <h1,h2,h3,h4,p1,p2> <CRLF>

- h1 (most significant byte) to h4 (least significant byte): IP address

- p1 (most significant byte), p2 (least significant byte): Port address

**Input example:** PORT 10,0,0,1,242,48  
(IP address: 10.0.0.1, Port number: 62000)

---

## PASV

This command requests this unit to “listen” on a data port (which is not its default data port). (It puts this unit into passive mode, waiting for the remote computer to make a data connection.)

**Command syntax:** PASV <CRLF>

---

## TYPE

Specifies the type of data to be transferred.

**Command syntax:** TYPE <SP> <type-code (options delimited by <SP>)> <CRLF>

<type-code> can be any of the following. However, for XDCAM, data is always transferred as “I”, regardless of the type-code specification.

- A: ASCII
  - N: Non-print
  - T: Telnet format
  - C: ASA Carriage Control
- E: EBCDIC
  - N: Non-print
  - T: Telnet format
  - C: ASA Carriage Control
- I: IMAGE (Binary) (default)
- L: LOCAL BYTE
  - SIZE: byte size

**Input example:** TYPE I

---

## STRU

Specifies the data structure.

**Command syntax:** STRU <SP> <structure-code> <CRLF>

<structure-code> can be any of the following. However, for XDCAM, the structure is always “F”, regardless of the structure-code specification.

- F: File structure (default)
- R: Record structure
- P: Page structure

**Input example:** STRU F

---

## MODE

Specifies the transfer mode.

**Command syntax:** MODE <SP> <mode-code> <CRLF>

<mode-code> can be any of the following. However, for XDCAM, the mode is always “S”, regardless of the mode-code specification.

- S: Stream mode (default)
- B: Block mode
- C: Compressed mode

**Input example:** MODE S

---

## LIST

Sends a list of files from this unit to the remote computer.

**Command syntax:** LIST <SP> <options> <SP> <path-name> <CRLF>

<options> can be any of the following.

- -a: Also display file names that begin with “.”
- -F: Append “/” to directory names.

The following data is transferred, depending on whether <path-name> specifies a directory or file.

- Directory specified: A list of the files in the specified directory
- File specified: Information about the specified file
- No specification: A list of the files in the current directory

The wildcard characters “\*” (any string) and “?” (any character) may be used in <path-name>.

**Input example 1:** LIST-a Clip

**Input example 2:** LIST Clip/\*.MXF

---

## NLST

Sends a list of file names from this unit to the remote computer, with no other information.

**Command syntax:** NLST <SP> <options or path-name> <CRLF>

The following options may be specified when no path-name is specified.

- -a: Also display file names that begin with “.”
- -l: Display information other than file name (gives the same result as the LIST command).
- -F: Append “/” to directory names.

The following data is transferred, depending on whether <path-name> specifies a directory or file.

- Directory specified: A list of the file names only in the specified directory
- No specification: A list of the file names only in the current directory.

The wildcard characters “\*” (any string) and “?” (any character) may be used in <path-name>.

**Input example 1:** NLST-l

**Input example 2:** NLST Clip/\*.MXF



---

**RETR**

Begins transfer of a copy of a file in the specified path on this unit to the current directory on the remote computer.

**Command syntax:** RETR <SP> <path-name> <CRLF>

**Input example:** RETR Clip/C0001.MXF

---

**STOR**

Begins transfer of a copy of a file in the specified path on the remote computer to the current directory on this unit. Depending on the type of file transferred, the following files are created.

- C\*.MXF file <sup>1)</sup>
  - C\*M01.XML file (metadata)
  - C\*M02.KLV file (user metadata)
  - C\*S01.MXF file (proxy AV data)
- E\*E01.SMI file <sup>2)</sup>
  - E\*M01.XML file (metadata)

1) \*: 0001 to 9999

2) \*: 0001 to 0099

**Notes**

- For C\*.MXF files, the UMID of the copy source file is not saved. However, it is saved if an immediately preceding SITE UMMD extended command has been issued.
- For C\*.MXF files, some data, such as file header metadata, may be missing.
- Depending on the transfer destination directory and the file type, transfer may not be possible.

*For details, see “File operation restrictions” (page 117).*

**Command syntax:** STOR <SP> <path-name> <CRLF>

**Input example:** STOR Edit/E0001E01.SMI

---

**RNFR****RNTO**

Rename a file.

Specify the file to be renamed with the RNFR command, and specify the new name with the RNTO command. (Always follow a RNFR command with a RNTO command.)

*For details, see “File operation restrictions” (page 117).*

**Command syntax:** RNFR <SP> <path-name (before change)> <CRLF>  
RNTO <SP> <path-name (after change)> <CRLF>

**Input example:** RNFR General/info.txt  
RNTO General/clip\_info.txt

---

**DELE**

Deletes the specified file on this unit.

**Note**

Depending on the directory and file type, deletion may not be possible.

*For details, see “File operation restrictions” (page 117).*

**Command syntax:** DELE <SP> <path-name> <CRLF>

**Input example:** DELE Clip/C0099.MXF

---

**STAT**

Sends information about properties of the specified file, or about data transfer status, from this unit to the remote computer.

The following property information is sent, depending on the file type.

- MXF file
  - File name
  - File type
  - CODEC type
  - Frame rate
  - Number of audio channels
  - Duration
  - UMID
- non-MXF file
  - File name

**Command syntax:** STAT <SP> <path-name> <CRLF>

The following data is transferred, depending on whether a file is specified with <path-name>.

- File specified: The properties of the specified file
- No specification: The size of the data transferred thus far (unit: bytes)

**Input example:** STAT Clip/C0001.MXF

---

**ABOR**

Requests this unit to abort a file transfer currently in progress.

**Command syntax:** ABOR <CRLF>

---

**SYST**

Displays the system name of this unit.

**Command syntax:** SYST <CRLF>

---

**HELP**

Displays a list of the commands supported by this unit, or an explanation of the specified command.

**Command syntax:** HELP <SP> <command-name>  
<CRLF>

The following data is transferred, depending on whether a command name is specified with <command-name>.

- Command name specified: Explanation of the specified command.
- No specification: Command list

**Input example:** HELP RETR

---

## NOOP

Does nothing except return a response. (Used to check whether this unit is running.)

**Command syntax:** NOOP <CRLF>

---

## PWD

Displays the current directory (“/” if the directory is the root directory).

**Command syntax:** PWD <CRLF>

---

## CWD

Changes the current directory (moves from the current directory to another directory).

**Command syntax:** CWD <SP> <path-name> <CRLF>

Moves to a directory as follows, depending on whether a directory is specified with <path-name>.

- Directory specified: To the specified directory
- No specification: To the root directory

**Input example:** CWD General

---

## CDUP

Moves one level up in the directory structure (makes the parent of the current directory be the current directory).

**Command syntax:** CDUP <CRLF>

---

## MKD

Creates a new directory.

### Note

Directories can be created only in the General directory.

*For details, see “File operation restrictions” (page 117).*

**Command syntax:** MKD <SP> <path-name> <CRLF>

---

## RMD

Deletes a directory.

### Note

Directories can be deleted only in the General directory.

*For details, see “File operation restrictions” (page 117).*

**Command syntax:** RMD <SP> <path-name> <CRLF>

## Extended commands

The following table shows the extended FTP commands supported by this unit.

### Note

In the Command syntax, <SP> means a space, entered by pressing the space bar, and <CRLF> means a new line, entered by pressing the Enter key.

---

## SITE REPF

Sends an MXF file from the specified path on this unit to the remote computer. This command allows you to specify a segment in the body of the MXF file (composed of video and audio data), for transfer of the required segment only.

### Notes

- A segment greater than the file size cannot be specified.
- This command cannot be used when the path names contains a space. Use the SITE REPFL command instead.

**Command syntax:** SITE REPF <SP> <path-name> <SP> <start-frame> <SP> <transfer-size> <CRLF>

<start-frame> specifies an offset from the start of the file. Data is transferred from the video frame at the offset (the first frame is 0).

<transfer-size> specifies the number of video frames to transfer (specify 0 to transfer to the end of the file).

**Input example:** SITE REPF Clip/C0001.MXF 5 150

(Transfer C0001.MXF. Body data is transferred only from frame 6 to frame 150.)

---

## SITE REPFL

Sends an MXF file from the specified path on this unit to the remote computer. This command allows you to specify a segment in the body of the MXF file (composed of video and audio data), for transfer of the required segment only.

### Note

A segment greater than the file size cannot be specified.

**Command syntax:** SITE REPFL <SP> "<path-name>" <SP> <start-frame> <SP> <transfer-size> <CRLF>

<path-name> specifies the path name of the file to transfer. Enclose the path name in double quotation marks.

<start-frame> specifies an offset from the start of the file. Data is transferred from the video frame at the offset (the first frame is 0).

<transfer-size> specifies the number of video frames to transfer (specify 0 to transfer to the end of the file).

**Input example:** SITE REPFL "Clip/sakura 0001.MXF" 5 150  
(Transfer sakura 0001.MXF. Body data is transferred only from frame 6 to frame 150.)

---

### SITE FSTS

Acquires the system status of this unit.  
One of the following status codes is sent.

- 0: Initial state, or no disc is loaded.
- 1: File system mount is OK.
- 3: File system mount is not OK.

**Command syntax:** SITE FSTS <CRLF>

---

### SITE MEID

Acquires the media ID of the disc loaded in this unit.

**Command syntax:** SITE MEID <CRLF>

---

### SITE FUNC

Acquires the function and version of the extended commands.

Information is sent in the following format.

<main function> <SP> <branch function> <SP> <branch function version>

For XDCAM, sent in a format like "200 MXF DISK 1"  
("200" is a response code).

**Command syntax:** SITE FUNC <CRLF>

---

### SITE UMMD

When a C\*.MXF file is sent with the STOR command, the copy source UMID is saved if this command is invoked immediately before the STOR command.

**Command syntax:** SITE UMMD <CRLF>

---

### SITE DF

Acquires the amount of free disc space.

**Command syntax:** SITE DF <CRLF>

---

### SITE CHMOD

Locks and unlocks clips. Also sets permissions for directories and files in the General directory.

**Command syntax:** SITE CHMOD <SP> <flag> <SP>  
<path-name> <CRLF>

Specify one of the following values in <flag>, according to the specification in <path-name>.

- When a clip is specified in <path-name>
  - 444: Lock.
  - 666: Unlock.
- When a directory in the General directory is specified in <path-name>
  - 555: Forbid writing to the directory.
  - 777: Allow writing to the directory.

- When a file in the General directory is specified in <path-name>
  - 444: Forbid writing to and execution of the file.
  - 555: Forbid writing to the file, but allow execution.
  - 666: Allow writing to the file, but forbid execution.
  - 777: Allow writing to and execution of the file.

**Input example:** SITE CHMOD 444 Clip/C0001.MXF  
(Lock clip C0001.MXF)

---

# Recording Continuous Timecode with FAM and FTP Connections

When you are connected to the unit by FAM or FTP, you can create new clips with timecode that is continuous with the timecode of the last frame of the last clip on the disc. To record continuous timecode, set the INT/EXT/SDI switch to “INT”, and set the PRESET/REGEN switch to “REGEN TC”. Then proceed as follows.

## Note

Continuous timecode cannot be recorded if the PRESET/REGEN switch to “REGEN VITC”.

*See page 138 for more information about setup menu operations.*

## FAM connection

Write clip files to the unit from the computer or other device that is connected to this unit.

## FTP connection

Use the “STOR” command to transfer clip files from the computer that is connected to this unit.

If you issue the “SITE UMMD” command immediately before the “STOR” command, the original timecode of the transferred file is recorded, regardless of the setting of the INT/EXT/SDI switch.

## Menu System Configuration

The settings for this unit use the following menus.

### Setup menu

The setup menu system of this unit comprises the basic setup menu and extended setup menu.

### Maintenance menu

This provides audio control, and network and setup menu settings, and also shows version information.

*For details, see “Maintenance Menu” (page 157).*

### Function menu

*For details, see “Basic Function Menu Operations” (page 49).*

### Disc Menu

*For details, see “Disc Operations” (page 90).*

## Setup Menu

The setup menu system of this unit comprises the basic setup menu and extended setup menu.

### Basic menu

This menu is used to make settings relating, for example, to the following.

- the digital hours meter
- the preroll time
- the text information superimposed on the video output to the monitor
- the menu banks for retaining menu settings

### Extended menu

This menu is used to make a wide range of settings relating to the functions of this unit, for example, the control panel functions, video and audio control, and digital data processing.

### Configuration of the basic menu

The basic menu comprises the following groups of items.

Item group	Function	Refer to
Items H01 to H17	Display of the total number of hours the unit has been powered on, and other information collected by the digital hours meter	<i>page 168</i>
Items 001 to 099	Settings relating to the preroll time, superimposed text information, switching between 59.94i/59.94P/29.97P and 50i/50P/25P/23.98P modes, etc.	<i>page 134</i>
Items B01 to B20	Settings relating to the menu banks for saving menu settings	<i>page 137</i>

### Configuration of the extended menu

The extended menu comprises the following groups of items.

Item group	Function	Refer to
Items 100 to 199	Settings relating to control panels	<i>page 141</i>
Items 200 to 299	Settings relating to the remote control interface	<i>page 143</i>
Items 300 to 399	Settings relating to editing operations	<i>page 143</i>
Items 400 to 499	Settings relating to preroll	<i>page 144</i>
Items 500 to 599	Settings relating to disc protection	<i>page 145</i>

Item group	Function	Refer to
Items 600 to 650	Settings relating to the timecode generator	<i>page 145</i>
Items 651 to 699	Settings relating to the metadata and UMID	<i>page 146</i>
Items 700 to 799	Settings relating to video control	<i>page 148</i>
Items 800 to 899	Settings relating to audio control	<i>page 151</i>
Items 900 to 999	Settings relating to digital processing	<i>page 153</i>

## Items in the basic menu

The basic menu items (excluding the items related to the digital hours meter) are listed in the following table.

- Item names are the names which appear on the video monitor screen of this unit and an external monitor, when the input signals to the monitor are the video signals output from the COMPOSITE OUT connector,

the SDDSI OUTPUT connector, or the HSDSI OUTPUT 2 (SUPER) connector.

- The values in the Settings column are the values which appear in the time data display area. (The values may appear in a different format on an external monitor. In this case, the external monitor values are shown in parentheses.) Underlined values are the factory defaults.

Item number	Item name	Settings
001	PREROLL TIME	<b>0 s (0 sec) to <u>5 s (5 sec)</u> to 30 s (30 sec)</b> : Set the preroll time to between 0 and 30 seconds in steps of 1 second. A preroll time of at least 5 seconds is recommended when using this unit for editing.
002	CHARACTER H-POSITION	Adjust the horizontal screen position (as a hexadecimal value) of the text information output from the COMPOSITE OUT connector, the SDDSI OUTPUT connector, or the HSDSI OUTPUT 2 (SUPER) connector for superimposed display on the monitor. <b>00 to <u>0C</u> to 28</b> : The hexadecimal value 00 is for the far left of the screen. Increasing the value moves the position of the characters to the right. Set this item by adjusting to the required position while viewing the monitor.
003	CHARACTER V-POSITION	Adjust the vertical screen position (as a hexadecimal value) of the text information output from the COMPOSITE OUT connector, the SDDSI OUTPUT connector, or the HSDSI OUTPUT 2 (SUPER) connector for superimposed display on the monitor. <b>00 to <u>2A</u> to 32</b> : The hexadecimal value 00 is for the top of the screen. Increasing the value lowers the position of the characters. Set this item by adjusting to the required position while viewing the monitor.

Item number	Item name	Settings
005	DISPLAY INFORMATION SELECT	<p>Determine the kind of text information to be output from the COMPOSITE OUT connector, the SDDSI OUTPUT connector, or the HDSDI OUTPUT 2 (SUPER) connector.</p> <p><b>T&amp;sta (time data &amp; status):</b> Time data and the units status.</p> <p><b>T&amp;UB (time data &amp; UB):</b> Time data and user bits data. (When UB (user bits data) is selected with CNTR SEL on the HOME page of the function menu, the user bits data and time data arranged in that order are displayed.)</p> <p><b>T&amp;CNT (time data &amp; CNT):</b> Time data and counter count. (When COUNTER is selected with CNTR SEL on the HOME page of the function menu, the counter count and time data arranged in that order are displayed.)</p> <p><b>T&amp;T (time data &amp; timecode):</b> Time data and timecode (TC or VITC)</p> <p><b>T&amp;clp (time data &amp; clip no):</b> Time data and clip number</p> <p><b>time (time data only):</b> Time data only</p>
006	LOCAL FUNCTION ENABLE	<p>Determine which recording and playback control buttons on the control panel are enabled when this unit is controlled from external equipment.</p> <p><b>dis (all disable):</b> All buttons and switches are disabled.</p> <p><b>st&amp;ej (stop &amp; eject):</b> Only the STOP button and EJECT button are enabled.</p> <p><b>ena (all enable):</b> All buttons and switches are enabled.</p>
007	DISC TIMER DISPLAY	<p>Determine whether to display the counter in 12-hour mode or 24-hour mode.</p> <p><b>±-12H (+/-12H):</b> 12-hour mode</p> <p><b>24H:</b> 24-hour mode</p>
009	CHARACTER TYPE	<p>Determine the type of characters such as timecode output from the COMPOSITE OUT connector, the SDDSI OUTPUT connector, or the HDSDI OUTPUT 2 (SUPER) connector for superimposed display on the monitor.</p> <p><b>white:</b> White letters on a black background</p> <p><b>black:</b> Black letters on a white background</p> <p><b>W/out:</b> White letters with black outline</p> <p><b>B/out:</b> Black letters with white outline</p> <p>Set this item by selecting the required type while viewing the monitor.</p>
011	CHARACTER V-SIZE	<p>Determine the vertical size of characters such as timecode output from the COMPOSITE OUT connector, the SDDSI OUTPUT connector, or the HDSDI OUTPUT 2 (SUPER) connector for superimposed display on the monitor.</p> <p><b>×1:</b> Standard size</p> <p><b>×2:</b> 2 times standard size</p> <p>Set this item by selecting the required size while viewing the monitor.</p>
012	CONDITION DISPLAY ON VIDEO MONITOR	<p>Select whether to display playback condition marks in external monitor output (output from the COMPOSITE OUT connector, the SDDSI OUTPUT connector, or the HDSDI OUTPUT 2 (SUPER) connector).</p> <p><b>dis (disable):</b> Do not display.</p> <p><b>ena (enable):</b> Display.</p>



Item number	Item name	Settings
013	SYSTEM FREQUENCY SELECT MENU	<p>Specify whether to enable switching the system frequencies (59.94i, 59.94P, 29.97P, 50i, 50P, 25P, 23.98P).</p> <p><b>off:</b> Do not enable switching the system frequencies. <b>on:</b> Enable switching the system frequencies.</p> <p><i>For details about switching the system frequencies, see page 44.</i></p> <p><b>Note</b> Settings for both basic and extended menu items are saved separately for different system frequencies.</p> <ul style="list-style-type: none"><li>• 1080 59.94i/29.97P</li><li>• 1080 50i/25P</li><li>• 1080 23.98P</li><li>• 720 59.94P</li><li>• 720 50P</li></ul> <p>Therefore, when you switch system frequencies, all menu items are reset to the current settings for the new mode. (They are different from the setting for the previous mode.)</p>
016	ALARM DISPLAY	<p>Select whether to display alarm messages.</p> <p><b>off:</b> Do not display alarm messages. (However, certain important alarms are displayed.)</p> <p><b>limit (on (limited)):</b> Display only a minimum number of alarm messages.</p> <p><b>on:</b> Display all alarm messages.</p> <p><i>For details about alarm message display conditions, see “Alarms” (page 170).</i></p>
017	SUB STATUS DISPLAY SELECT	<p>Determine the kind of sub status information to be output from the COMPOSITE OUT connector, the SDDSI OUTPUT connector, or the HSDSI OUTPUT 2 (SUPER) connector.</p> <p><b>off:</b> Do not output sub status information.</p> <p><b>rmain (disc remain):</b> Available disc space (unit: minute)</p> <p><b>clip (clip no):</b> Order of playback of the selected clip/total number of clips</p> <p><b>pbr (playback remain):</b> The remaining playback time of the selected clip from the current playback position (hours:minutes:seconds:frames).</p> <p><b>Note</b> When menu item 005 is set to “off”, sub status information is not displayed when this item is set to anything other than “off”.</p>
024	MENU CHARACTER TYPE	<p>Determine the type of characters in menu text output from the COMPOSITE OUT connector, the SDDSI OUTPUT connector, or the HSDSI OUTPUT 2 (SUPER) connector for superimposed display on the monitor.</p> <p><b>white:</b> White letters on a black background. <b>black:</b> Black letters on a white background. <b>W/out:</b> White letters with black outline. <b>B/out:</b> Black letters with white outline.</p> <p>Set this item by selecting the required type while viewing the monitor.</p>
027	SD CHARACTER <sup>a)</sup>	<p>Specifies whether to superimpose text information on the video signals output from the COMPOSITE OUT and SDDSI OUTPUT connectors.</p> <p><b>off:</b> Do not superimpose.</p> <p><b>all:</b> Superimpose on the output of both the COMPOSITE OUT and SDDSI OUTPUT connectors.</p> <p><b>comp (composite):</b> Superimpose on the output of the COMPOSITE OUT connector.</p> <p><b>sdi:</b> Superimpose on the output of the SDDSI OUTPUT connector.</p>
028	HD CHARACTER <sup>a)</sup>	<p>Specify whether to superimpose text information on the video signal output from the HSDSI OUTPUT 2 (SUPER) connector.</p> <p><b>off:</b> Do not superimpose.</p> <p><b>sdi2 (hd-sdi2):</b> Superimpose.</p>



Item number	Item name	Settings	
029	STORED OWNERSHIP	Specify whether to enable changing UMID ownership information settings (COUNTRY, ORGANIZATION and USER). <b>off:</b> Do not enable. <b>on:</b> Enable.  <i>See “Using UMID Data” (page 184) for more information about UMID.</i>	
031	RECORDING FORMAT	Set the recording format. <b>HD422:</b> HD422 <b>420HQ (HD420 HQ):</b> HD420HQ <b>420SP (HD420 SP):</b> HD420SP <b>IMX50 (IMX 50Mbps):</b> MPEG IMX 50 Mbps <b>IMX40 (IMX 40Mbps):</b> MPEG IMX 40 Mbps <b>IMX30 (IMX 30Mbps):</b> MPEG IMX 30 Mbps <b>DVCAM:</b> DVCAM	
034	MENU STATUS DISPLAY ON VIDEO MONITOR <sup>a)</sup>	Specify whether to display the setup menu status at the left edge of the status display line when setup menu item 005 “DISPLAY INFORMATION SELECT” is set to “T&sta”. <b>dis (disable):</b> Do not display. <b>ena (enable):</b> Display. (The display is visible only when no disc is loaded, and during insertion and ejection of a disc.)	
035	CLIP TITLE NAMING SELECT	Specify whether to allow user definition of the titles assigned to clips. <b>off:</b> Do not allow assignment. <b>on:</b> Allow assignment.  <i>See “Assigning user-defined clip titles” (page 120) for more information about assigning titles.</i>	
	Sub-item		
	1	TITLE	Specify whether to assign titles to recorded clips. <b>disable:</b> Do not assign titles to clips. <b>enable:</b> Assign titles to clips.
	2	PREFIX	Set the prefix of the title (up to 10 characters). The allowable characters are alphanumeric characters, symbols (! # \$ % & ' ( ) + , - . ; = @ [ ] ^ _ { } ~), and the space character. <b>TITLE</b>
3	NUMERIC	Set the initial value of the numeric part of the title (00001 to 99999, five-digit number). <b>00001</b>	
036	FILE NAMING	Specify whether to allow use of clip and clip list files with user-defined names.  <i>See “Assigning user-defined clip and clip list names” (page 121) for details about how to make the settings.</i>	
	Sub-item		
	1	NAMING FORM	Specify the clip and clip list naming format. (Specify whether to allow use of files with user-defined names.) <b>C****:</b> Standard format (Do not allow use of files with user-defined names) <b>free:</b> Free format (Allow use of files with user-defined names)
2	AUTO NAMING	When “free” is selected under the sub-item “NAMING FORM”, specify the format of the names of clips recorded on this unit. Specify the standard name format, or the same name as the title listed below, or the name specified in planning metadata. <b>C****:</b> Use the standard format for clip names. <b>title:</b> Use the title set in setup menu item 035 “CLIP TITLE NAMING SELECT” for clip names. <b>plan:</b> Use the name specified in planning metadata.	
B01	RECALL SETUP BANK-1	Set to “on” to recall menu settings from menu bank 1.	
B02	RECALL SETUP BANK-2	Set to “on” to recall menu settings from menu bank 2.	
B03	RECALL SETUP BANK-3	Set to “on” to recall menu settings from menu bank 3.	
B11	SAVE SETUP BANK-1	Set to “on” to save current menu settings to menu bank 1.	
B12	SAVE SETUP BANK-2	Set to “on” to save current menu settings to menu bank 2.	
B13	SAVE SETUP BANK-3	Set to “on” to save current menu settings to menu bank 3.	

Item number	Item name	Settings
B20	RESET SETUP MENU	Set to "on" to return the settings of the current menu to the factory default settings. Set to "bank-4" to set the current menu to the settings saved in menu bank 4. <b>off</b> <b>on:</b> Return the current menu to the factory default settings. <b>bank-4:</b> Set the current menu to the settings saved in menu bank 4.

a) The setting of this item is enabled only when CHAR SEL on the HOME page of the function menu is set to "ON".  
The setting of CHAR SEL determines whether or not to superimpose character information on the output from the HDMI OUT connector.

## Basic menu operations

The setup menu is displayed in the time data display area of the basic operation display and in the video monitor display. If you have connected an external monitor, it is also superimposed over the picture shown on the external monitor.

### To display the setup menu

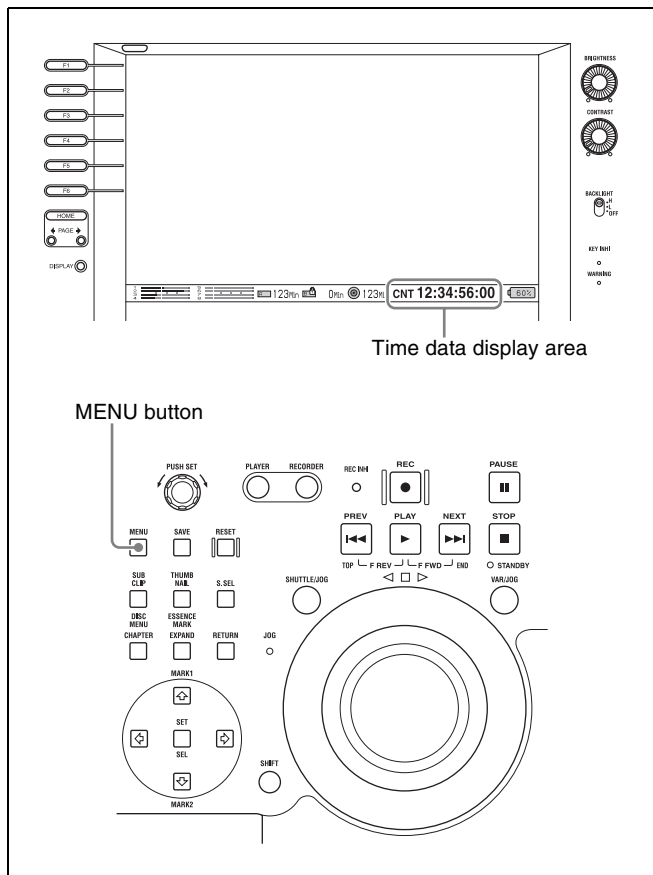

Press the MENU button.  
The setup menu appears on the video monitor display, with a cursor "\*" indicating the currently selected menu item. (If you are in the basic operation display, the display switches to the video monitor display.)

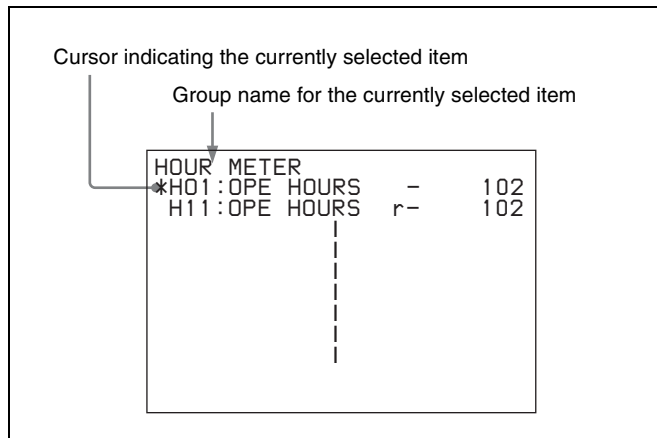

The number and setting of the currently selected menu item also appear in the time data display area.

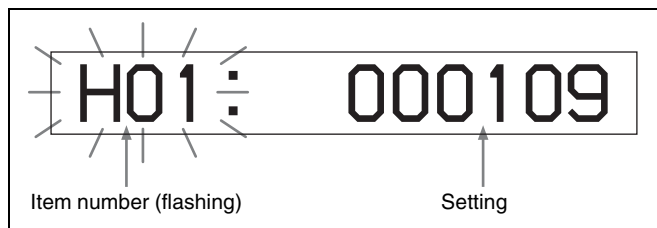

### To display menus on an external monitor

Connect the monitor to the COMPOSITE OUT connector, SDDS DI OUTPUT connector, or HDS DI OUTPUT 2 (SUPER) connector on this unit, and press the MENU button.

### Buttons used to change settings

Use the following buttons to change setup menu settings.

Menu control buttons	Functions
MENU button	<ul style="list-style-type: none"> <li>Displays and hides the setup and user interface menus.</li> <li>Returns to the menu from a setting screen.</li> </ul>
PUSH SET knob	<ul style="list-style-type: none"> <li>When turned clockwise or counterclockwise, moves the "*" mark up or down in the list of menu items to select the item to change.</li> <li>When turned clockwise or counterclockwise, changes a menu item setting.</li> <li>When pressed, answers "Yes" to a question.</li> </ul>

Menu control buttons	Functions
Function buttons F1 to F6 (The function to be displayed varies depending on the situations.)	<b>RETURN:</b> Goes up one level. <b>SELECT:</b> Selects an item. <b>UP:</b> Skips back 100 or 50 items in the list of menu items. <b>DOWN:</b> Skips forward 100 or 50 items in the list of menu items. <b>SAVE:</b> Saves a new setting to memory. <b>EXIT:</b> Exits the current menu. <b>-:</b> Changes a setting. <b>+:</b> Changes a setting.
RESET button	<ul style="list-style-type: none"> <li>Returns the current setting to the factory default.</li> <li>Answers "No" to a question.</li> </ul>

## To change the settings of menu items

Proceed as follows to change the settings of menu items.

- Use the PUSH SET knob to select the required item.

**Example:** Screen display when item 005 DISPLAY INFORMATION SELECT is selected

KEY PARAMETER	Current setting
001:P-ROLL TIME	- 5 s
002:CHARA H-POS	- 0A
003:CHARA V-POS	- 2E
*005:DISPLAY SEL	- T&CNT
006:LOCAL ENA	- st&ej
007:DISC TIMER	- +-12H
009:CHARA TYPE	- white
011:CHARA SIZE	- xl
012:COND DISPLY	- dis
013:SYSTEM FREQ	- off
016:ALARM	- on

- Press the PUSH SET knob or the SELECT function button (F2).

This displays the setting screen 2 for the menu item selected in step 1.

**Example:** Setting screen display when item 005 DISPLAY INFORMATION SELECT is selected

ITEM-005
DISPLAY INFORMATION SELECT
time data & CNT
Current setting

- Use the PUSH SET knob or the +/- function button (F3 or F4) to change the setting.

- To change other settings, press the PUSH SET knob or the SELECT function button (F2) to return to the previous screen, then repeat steps 1 to 3.

- When you have completed the settings, press the SAVE function button (F5).

The message "NOW SAVING..." appears on the video monitor display, and "Saving..." appears in the time data display area, while the new settings are saved in memory. When the saving operation is completed, the video monitor display and the time data display area return to their normal indications.

### Notes

- If you power off the unit before a save operation is completed, settings may be lost. Wait until the save is completed before powering off the unit.
- If, instead of pressing the SAVE function button (F5), you press the MENU button, the new settings are not saved. The message "ABORT !" appears on the video monitor display and "Abort !" in the time data display area for about 0.5 seconds, and the system exits the menus. To change more than one setting, be sure to press the SAVE function button (F5) after making the settings.

## To return menu settings to their factory default settings

After changing menu settings, use the following procedure to return the settings to their factory default settings (setting initialization).

### To return all settings to their factory default settings

- Press the MENU button to display the setup menu.

- Press the RESET button.

A message appears, to confirm whether you wish to return all settings to their factory default settings.

Message on the video monitor display	Initialize all items to factory preset values?
Message in the time data display area	Init setup?

- Press the SAVE function button (F5).

The message "NOW SAVING..." appears on the video monitor display, and "Saving..." appears in the time data display area, while the settings of all items are returned to their factory default settings. These factory default settings are saved in memory.

## Note

If you power off the unit while settings are being saved, settings may not be correctly returned to their factory default settings. Wait until the saving is completed before powering off the unit.

### To abandon the resetting operation

Instead of pressing the SAVE function button (F5), press the RESET button. The display returns to the top level of the setup menu, leaving the settings unchanged.

## To customize the display of setup menu items

You can select the menu items displayed in the setup menu.

- 1 Set maintenance menu item M41: CUSTOMIZE to “ENABLE”.

*See page 161 for information about how to use the maintenance menu.*

- 2 Hold down the MENU button for about three seconds.

The SETUP CUSTOMIZE screen appears.

SETUP	SETUP CUSTOMIZE
ON	*H01:OPE HOURS - on
	H02:LASER0 - on
OFF	H03:LASER1 - on
	H11:OPE HOURS r- on
UP	H13:SEEK HOURS0r- off
	H14:SPDL HOURS r- off
DOWN	H15:LOAD COUNT r- off
	H17:SEEK HOURS1r- off
SAVE	001:P-ROLL TIME - off
	002:CHARA H-POS - off
EXIT	003:CHARA V-POS - off

- 3 Turn the PUSH SET knob so that the “\*” mark appears next to the item you want to hide or display in the setup menu.

SETUP	SETUP CUSTOMIZE
ON	H01:OPE HOURS - on
	H02:LASER0 - on
OFF	H03:LASER1 - on
	H11:OPE HOURS r- on
UP	*H13:SEEK HOURS0r- off
	H14:SPDL HOURS r- off
DOWN	H15:LOAD COUNT r- off
	H17:SEEK HOURS1r- off
SAVE	001:P-ROLL TIME - off
	002:CHARA H-POS - off
EXIT	003:CHARA V-POS - off

You can press the  $\uparrow$ /MARK1 button or the  $\downarrow$ /MARK2 button to move the “\*” mark by 100 menu items.

- 4 Press the PUSH SET knob.

A setting screen for the currently selected item appears.

SETUP	CUSTOM ITEM-H13
RETURN	SEEK RUNNING HOURS 0
	(resettable)
	on
-	
+	
SAVE	
EXIT	

- 5 Turn the PUSH SET knob to select “on” or “off”.

**on:** Display the item in the setup menu.

**off:** Do not display the item in the setup menu.

- 6 Press the PUSH SET knob.

### To continue selecting items

Repeat steps 3 to 6.

### To set items more quickly

In step 3, turn the PUSH SET knob to move the “\*” mark, and then press the ON function button (F1) or OFF function button (F2) to set items continuously.

- 7 Press the SAVE function button (F5).

### Customization indication in the setup menu

When you open the setup menu after customizing the displayed menu item, a “[C]” mark appears at the upper right of the screen to indicate that the menu has been customized.

## Items in the extended menu

The following tables show the items in the extended menu.

- Item names are the names which appear on an external monitor to which the output of the COMPOSITE OUT connector, the SDSDI OUTPUT connector, or the HDSDI OUTPUT 2 (SUPER) connector is input.
- The values in the Settings columns are the values which appear in the time data display area. (The values may appear in a different format on an external monitor. In this case, the external monitor values are shown in parentheses.) Underlined values are the factory defaults.

**Menu items in the 100s, relating to the control panels (OPERATIONAL PARAMETER)**

Item number	Item name	Settings
101	SELECTION FOR SEARCH DIAL ENABLE	Select how the unit enters shuttle, jog, or variable speed mode. <b>dial (dial direct)</b> : Press the SHUTTLE/JOG or VAR/JOG button or, except during recording/editing, turn the shuttle/jog dial. <b>key (via search key)</b> : Press the SHUTTLE/JOG or VAR/JOG button.
105	REFERENCE SYSTEM ALARM	Select whether to display a warning when the reference video signal is not being supplied, or when it differs from this unit's system frequency. <b>off</b> : No warning. <b>on</b> : Flash the STOP button as a warning.
107	REC INHIBIT LAMP FLASHING	Select whether to flash the REC INHI indicator when recording is prevented (see "REC INHI (recording inhibit) indicator" (page 18)). <b>off</b> : Light the REC INHI indicator. <b>on</b> : Flash the REC INHI indicator.
108	AUTO EE SELECT	When a disc is inserted and PB/EE on the HOME page of the function menu is set to "EE", select the operation modes in which input video and audio signals are automatically handled in E-E mode. <b>S/F/R (stop/f.fwd/f.rev)</b> : In stop/fast-forward/fast-reverse modes <b>stop</b> : In stop mode
109	FORCED EE WHEN DISC UNLOAD	During disc loading/unloading and when no disc is inserted, select whether to control the output signal PB/EE setting. <b>on</b> : Do not control (the signal is always an E-E signal). <b>off</b> : Control.
114	AUDIO MONITOR OUTPUT LEVEL	Select whether to control the level of the audio signal output from the AUDIO MONITOR R, L connectors with the LEVEL knob for the PHONES jack. <b>var (variable)</b> : Control. <b>fixed</b> : Do not control.
118	KEY INHIBIT	Select which buttons can be operated when the KEY INHI switch is set to "ON". The following sub-items control different sets of buttons independently.
	Sub-item	
	1    AUDIO/F-KEY	Select whether function buttons on the display panel are enabled. <b>dis</b> : Disabled. <b>ena</b> : Enabled.
2    CONTROL PANEL	Select whether operation buttons on the control panel are enabled. <b>dis</b> : Disabled. <b>ena</b> : Enabled.	
119	VARIABLE SPEED LIMIT IN KEY PANEL CONTROL	Select the playback speed range when carrying out playback in variable speed mode from the control panel of this unit. <b>off (off (-1 to +1))</b> : -1 to +1 times normal speed. <b>on (on ( 0 to +1))</b> : 0 to +1 times normal speed.
121	FRAME PB MODE	Select the variable playback field/frame mode. <b>auto</b> : Field playback <b>frame</b> : Frame playback. Compared to field playback, frame playback gives more detail during playback of still pictures.

Menu items in the 100s, relating to the control panels (OPERATIONAL PARAMETER)

Item number	Item name	Settings	
131	AUDIO VOLUME	Select whether each of the ALL/CH-1 and CH-2 to CH-4 adjustment knobs on the control panel is enabled, allowing you to adjust the audio recording and playback levels of each channel individually, or whether the ALL/CH-1 adjustment knob alone functions as a master control to control the audio levels of all channels at once.	
	Sub-item		
	1	REC	Make settings for the recording ALL/CH-1 and CH-2 to CH-4 adjustment knobs. <b>each:</b> Each of the ALL/CH-1 and CH-2 to CH-4 adjustment knobs is enabled, allowing you to adjust each channel individually. <b>all:</b> The ALL/CH-1 adjustment knob alone functions as a master control. When you select "all", the ALL indicator to the left of the ALL/CH-1 adjustment knob lights.
	2	PB	Make settings for the playback ALL/CH-1 and CH-2 to CH-4 adjustment knobs. <b>each:</b> Each of the ALL/CH-1 and CH-2 to CH-4 adjustment knobs is enabled, allowing you to adjust each channel individually. <b>all:</b> The ALL/CH-1 adjustment knob alone functions as a master control. When you select "all", the ALL indicator to the left of the ALL/CH-1 adjustment knob lights.
140	AREA MARKER	Select whether to display the display area of SD output on the color LCD. <b>off:</b> Do not display. <b>on:</b> Display.	
142	REPEAT MODE	Put the unit into repeat playback mode, or exit from repeat playback mode. <b>off:</b> Exits from repeat playback mode. <b>play:</b> Puts the unit into repeat playback mode.	
143	INDEX PICTURE POSITION	Select the frame of the clip to use as the thumbnail image (index picture) when recording. <b>0sec to 10sec:</b> Can be set in the range from 0 seconds (first frame of the clip) to 10 seconds, in units of 1 second.	
145	MODE KEY ENABLE DURING RECORDING	Select whether the STOP button and PAUSE button are the only buttons that stop recording. <b>ena (all enable):</b> Recording stops when the EJECT button <sup>a)</sup> , PLAY button, STOP button, PAUSE button, SHUTTLE/JOG button, and VAR/JOG button <sup>b)</sup> are pressed. <b>s&amp;p (stop &amp; pause):</b> Recording stops only when the STOP button or PAUSE button is pressed.	
146	POWER SAVE MODE	Select whether to put the unit into power saving mode when it enters stop mode, by turning power supply on or off for each of the components in the sub-items.	
	Sub-item		
	1	DRIVE	Select whether to supply power to the drive. <b>stby:</b> Supply power (do not put this unit into power saving mode). <b>save:</b> Do not supply power (put this unit into power saving mode).
150	REC MODE	Set the recording functions of sub-items.	
	Sub-item		
	1	DISC EXCHANGE	<b>off:</b> Disable the disc exchange cache function. <b>on:</b> Enable the disc exchange cache function.
	2	CLIP CONTINUOUS	<b>off:</b> Disable the Clip Continuous Rec function. <b>on:</b> Enable the Clip Continuous Rec function.
151	GUI OPERATION	Select whether to disable the display of the Thumbnail Menu and Disc Menu when this unit is in any mode other than stop mode. <b>ena (enable):</b> Do not disable. <b>stop (via stop):</b> Enable the display of menus in the stop mode. <b>dis (disable):</b> Disable.	



### Menu items in the 100s, relating to the control panels (OPERATIONAL PARAMETER)

Item number	Item name	Settings
153	FIND MODE	Specify the frame to be cued up when the PREV or NEXT button is pressed. <b>clip:</b> The first frame of the clip <b>R.ST (clip &amp; rec start mark):</b> The frame where a Rec Start essence mark is set (if no essence mark is set, the first frame of the clip)
154	SINGLE CLIP PLAY MODE	Put the unit into single clip playback mode, or exit from single clip playback mode. <b>off:</b> Exits from single clip playback mode. (Puts the unit into continuous playback mode.) <b>on:</b> Puts the unit into single clip playback mode.

a) The disc is ejected after recording stops.

b) The unit enters stop mode when the PLAY button is pressed. It enters freeze picture mode (jog, shuttle, or variable mode) when the SHUTTLE/JOG button or VAR/JOG button is pressed.

### Menu items in the 200s, relating to the remote control interface (REMOTE INTERFACE)

Item number	Item name	Settings
201	PARA RUN	Select whether to use synchronized operation for two or more VTRs. <b>dis (disable):</b> No synchronized operation <b>ena (enable):</b> Use synchronized operation <b>Note</b> To use synchronized operation for two or more VTRs, set item 201 to ena on all of the VTRs.
214	REMOTE INTERFACE	When the remote control switch is set to REMOTE, select the device from which to remote-control this unit. <b>9PIN:</b> Device connected to the REMOTE(9P) connector. <b>SDI:</b> Device connected to the SD/HDSDI INPUT connector. <b>i.LINK:</b> Device connected to the  (i.LINK) HDV TS connector. a)
257	NETWORK ENABLE	Select the remote control switch positions which enable network connections. <b>net (network):</b> Only when the switch is set to "NET". <b>n&amp;9P (network &amp; remote(9PIN)):</b> When the switch is set to "NET", and when the switch is set to "REMOTE" and setup menu item 214 is set to "9PIN". b)

a) When the PDBK-202 option board is installed

b) FTP connections can be made only when the device connected to the REMOTE(9P) connector (D-sub 9 pin) is in stop mode. During FTP connections, the device connected to the REMOTE(9P) connector cannot be used to control this unit.

### Menu items in the 300s, relating to editing operations (EDITING)

Item number	Item name	Settings
301	VAR SPEED RANGE FOR SYNCHRONIZATION	Select the playback speed range when carrying out playback in variable speed mode from a remote control unit connected to the REMOTE(9P) connector. <b>-1~+1:</b> -1 to +1 times normal speed. <b>wide:</b> -1.20 to +1.20 times normal speed.
307	AUTO-DELETION FOR INCONSISTENT DATA	Select what to do when an inconsistent edit point has been set. <b>manu (manual):</b> Flash the DELETE button on the control panel and display a warning. <b>neg&amp;E (neg &amp; excess):</b> Delete the inconsistent edit point automatically when an Out point is set before an In point, and when more edit points than necessary have been set. <b>neg:</b> Delete the inconsistent edit point automatically when an Out point is set before an In point. Flash the DELETE button on the control panel and display a warning when more edit points than necessary have been set.

### Menu items in the 300s, relating to editing operations (EDITING)

Item number	Item name	Settings
308	SELECTION OF STD/NON-STD FOR COMPOSITE VIDEO IN	<p>Select the STD or NON-STD mode in accordance with a composite video input.</p> <p><b>STD (forced STD):</b> The STD mode is always used (forced STD mode).</p> <p><b>N-STD (forced non-STD):</b> Use this setting when the input video signal is unstable (forced NON-STD mode).</p> <p><b>Notes</b></p> <ul style="list-style-type: none"> <li>• When using a VCR with no built-in time base corrector (e.g. a home-use VHS-system VCR), select “N-STD”.</li> <li>• When this item is set to “N-STD”, the following limitations apply, because this unit’s sync reference signal generator always synchronizes to an internal sync reference signal (<i>see page 43</i>). <ul style="list-style-type: none"> <li>- It is not possible to record VITC, wide picture information, or closed captions, which is multiplexed into the vertical blanking interval of composite video signals.</li> <li>- Lip-sync delays (delays in the synchronization of video and audio) may occur.</li> </ul> </li> </ul>
320	DIGITAL AUDIO PB PROCESS ON EDIT POINT	<p>Select the treatment of audio playback at edit points.</p> <p><b>cut:</b> Carry out a cut (possibly resulting in audio discontinuities at the edit point).</p> <p><b>fade:</b> Fade out and fade in.</p>
345	EDITING MODE	<p>Selects the edit mode in edit list editing.</p> <p><b>ovl (overlay):</b> Overlay mode</p> <p><b>ins (insert):</b> Insert mode</p>
346	PLAYER SELECT	<p>Selects the source of the clips to be used as material.</p> <p><b>clip (disc(clip)):</b> Clips (video and audio data) on a disc inserted into the recorder</p> <p><b>ext (external):</b> External device</p> <p><b>voice (disc(voice)):</b> Audio (audio data, distinct from clips) on a disc inserted into the recorder</p> <p><b>sxs (SxS):</b> Clips (video and audio data) on an SxS memory card inserted into the recorder</p> <p><b>Note</b></p> <p>The settings “voice (disc(voice))” and “sxs (SxS)” appear when the PDBZ-UPG03 Software Upgrade Key or PDBK-MK1 option board is installed.</p>
347	INPUT VOICE CH	<p>Selects the audio input channel.</p> <p><b>CH 1 to CH 8</b></p> <p><b>Note</b></p> <p>This appears when the PDBZ-UPG03 Software Upgrade Key or PDBK-MK1 option board is installed.</p>
348	OUTPUT VOICE CH	<p>Selects the output channel for a voice track.</p> <p><b>CH 1 to CH 8</b></p> <p><b>Notes</b></p> <ul style="list-style-type: none"> <li>• This appears when the PDBZ-UPG03 Software Upgrade Key or PDBK-MK1 option board is installed.</li> <li>• The current setting of this item at the start of editing is applied across the entire edit list. It is not possible to change this setting for different voice data segments.</li> </ul>

### Menu items in the 400s, relating to preroll (PREROLL)

Item number	Item name	Settings
401	FUNCTION MODE AFTER CUE-UP	<p>Select the state that the unit goes into after a cuing-up operation.</p> <p><b>stop:</b> Stops (the stop mode).</p> <p><b>still:</b> Still playback (in jog and shuttle mode).</p>





**Menu items in the 500s, relating to disc protection (DISC PROTECTION)**

Item number	Item name	Settings
501	STILL TIMER	To protect the disc against shock and vibrations, and to lengthen the life of the laser diodes, the unit automatically enters standby off mode whenever a specified time elapses in a disc stop mode (stop mode or the still picture mode of search mode). This allows you to set the time after which the unit exits a disc stop mode and enters standby off mode. <b>0.5 s (0.5 sec) to 8 m (8 min) to 30 m (30 min):</b> Can be set in the range from 0.5 seconds to 30 minutes. <b>off:</b> Do not put into standby off mode.

**Menu items in the 600s, relating to the timecode, metadata, and UMID (TIME CODE GENERATOR/META DATA)**

Item number	Item name	Settings
601	VITC POSITION SEL-1	In 59.94i/59.94P/29.97P mode Select the line into which to insert VITC signals (SD output) <b>12H (12 line) to 16H (16 line) to 20H (20 line):</b> Any line from line 12 through line 20.  <b>Notes</b> <ul style="list-style-type: none"> <li>You can insert VITC signals in two places. To insert in two places, set both item 601 and item 602.</li> <li>In 59.94i/59.94P/29.97P mode (J), output of wide picture information is given priority if OUTPUT in setup menu item 731 is set to "auto" and the VITC insertion line is set to line 16.</li> <li>In 59.94i/59.94P/29.97P mode (UC), output of wide picture information is given priority if OUTPUT in setup menu item 731 is set to "auto" and the VITC insertion line is set to line 20.</li> </ul>
		In 50i/50P/25P mode Select the line into which to insert VITC signals (SD output) <b>9H (9 line) to 19H (19 line) to 22H (22 line):</b> Any line from line 9 through line 22.  <b>Note</b> You can insert VITC signals in two places. To insert in two places, set both item 601 and item 602.
602	VITC POSITION SEL-2	In 59.94i/59.94P/29.97P mode Select the line into which to insert VITC signals (SD output) <b>12H (12 line) to 18H (18 line) to 20H (20 line):</b> Any line from line 12 through line 20.  <b>Notes</b> <ul style="list-style-type: none"> <li>You can insert VITC signals in two places. To insert in two places, set both item 601 and item 602.</li> <li>In 59.94i/59.94P/29.97P mode (J), output of wide picture information is given priority if OUTPUT in setup menu item 731 is set to "auto" and the VITC insertion line is set to line 16.</li> <li>In 59.94i/59.94P/29.97P mode (UC), output of wide picture information is given priority if OUTPUT in setup menu item 731 is set to "auto" and the VITC insertion line is set to line 20.</li> </ul>
		In 50i/50P/25P mode Select the line into which to insert VITC signals (SD output) <b>9H to 21H to 22H:</b> Any line from line 9 through line 22.  <b>Note</b> You can insert VITC signals in two places. To insert in two places, set both item 601 and item 602.
605	TCG REGEN MODE	Select the signal to be regenerated when the timecode generator is in the regeneration mode. <b>TC&amp;UB:</b> Both the timecode and user bits are regenerated. <b>TC:</b> Only the timecode is regenerated. <b>UB:</b> Only the user bits are regenerated.

Menu items in the 600s, relating to the timecode, metadata, and UMID (TIME CODE GENERATOR/META DATA)

Item number	Item name	Settings
607	U-BIT BINARY GROUP FLAG	Select the user bits to be used in the timecode generated by the timecode generator. <b>000 (000:not specified):</b> Character set not specified. <b>001 (001:iso character):</b> 8-bit characters compliant with ISO 646 and ISO 2022. <b>010 (010:unassigned-1):</b> Undefined. <b>011 (011:unassigned-2):</b> Undefined. <b>100 (100:unassigned-3):</b> Undefined. <b>101 (101:page / line):</b> SMPTE-262M page/line multiplex system. <b>110 (110:unassigned-4):</b> Undefined. <b>111 (111:unassigned-5):</b> Undefined.
611	TC OUTPUT PHASE IN EE MODE	Select the timecode output mode for output from the TIME CODE OUT connector in E-E mode. <b>thru (through):</b> Output the timecode input to the TIME CODE IN connector as it is. <b>v-in (video input phase):</b> Output the timecode with the same phase as the input video signal phase. <b>v-out (video output phase):</b> Output the timecode with the same phase as the output video signal phase.
612	TC OUTPUT MUTING IN SEARCH MODE	Select whether to suppress the output from the TIME CODE OUT connector in jog/shuttle mode. <b>on:</b> Suppress. <b>off:</b> Do not suppress.
618	UPCONV EMBEDDED VITC	Select the source of the VITC embedded into output HDSDI when up converting during playback of SD discs. <b>VITC:</b> Select the VITC of the SD disc. <b>LTC:</b> Select the LTC of the SD disc.
619	VITC	Select whether to record VITC signals generated by the internal timecode generator. This setting applies when the recording format is SD and a VITC signal is present in the input video signal and the line of that VITC signal is set to “thru” in setup menu item 723. <b>off:</b> Record the detected VITC on the lowest numbered line that has been set to “thru”. <b>on:</b> When VITC is detected on a line that has been set to “thru”, and the number of that line is lower than the numbers of the lines selected with setup menu items 601 and 602, record the VITC of that line. When VITC is detected on a line that has been set to “thru”, and the number of that line is higher than the numbers of the lines selected with setup menu items 601 and 602, record internally generated VITC.
634	WATCH AUTO ADJUST	Select whether to adjust the unit’s internal clock to time data embedded in user bits, when time data is embedded in the LTC user bits input to the TIME CODE IN connector. <b>off:</b> Do not adjust the time. <b>on:</b> Adjust the time.
651	UMID SDI OUTPUT	Select whether to output UMID in the VANC of the SDI output. <b>off:</b> Do not output. <b>on:</b> Output.  <i>See “Using UMID Data” (page 184) for more information about UMID.</i>
652	UMID SD VANC LINE	Select the line in which UMID is output when menu item 651 is set to “on”. <b>12 H (12 line), 13 H (13 line), 15 H (15 line), 16 H (16 line), 17 H (17 line), 18 H (18 line), 19 H (19 line) (59.94i/59.94P/29.97P mode)</b> <b>9 H (9 line), 10 H (10 line), 12 H (12 line), 13 H (13 line), 14 H (14 line), 15 H (15 line), 16 H (16 line), 17 H (17 line), 18 H (18 line) (50i/50P/25P mode)</b>  <i>See “Using UMID Data” (page 184) for more information about UMID.</i>

Menu items in the 600s, relating to the timecode, metadata, and UMID (TIME CODE GENERATOR/META DATA)

Item number	Item name	Settings
653	UMID HD VANC LINE	Select the line in which UMID is output when menu item 651 is set to "on". <b>9H (9 line) to 17H (17 line) to 20H (20 line) (59.94i, 50i, 29.97P, 25P, 23.98P mode)</b> <b>9H (9 line) to 17H (17 line) to 25H (25 line) (59.94P, 50P mode)</b> <b>Note</b> The output VANC line during playback follows the setting for recording.  <i>See "Using UMID Data" (page 184) for more information about UMID.</i>
657	ESSENCE MARK SDI OUTPUT	Select whether to output essence marks in the SDI output VANC. <b>off:</b> Do not output. <b>on:</b> Output.
660	ESSENCE MARK SD VANC LINE	When menu item 657 is set to "on", select the line to which to output essence marks. <b>12 H (12 line), 13 H (13 line), 15 H (15 line), 16 H (16 line), 17 H (17 line), 18 H (18 line), 19 H (19 line) (59.94i/59.94P/29.97P mode)</b> <b>9 H (9 line), 10 H (10 line), 12 H (12 line), 13 H (13 line), 14 H (14 line), 15 H (15 line), 16 H (16 line), 17 H (17 line), 18 H (18 line) (50i/50P/25P mode)</b>
665	ESSENCE MARK HD VANC LINE	When item 657 is set to "on", select the line to which to output essence marks. <b>9H (9 line) to 17H (17 line) to 20H (20 line) (59.94i, 50i, 29.97P, 25P, 23.98P mode)</b> <b>9H (9 line) to 17H (17 line) to 25H (25 line) (59.94P, 50P mode)</b> <b>Note</b> The output VANC line during playback follows the setting for recording.
666	META DATA ITEM OUT	Specify whether to include the information from recorded VANC packets in data items in the DATA ITEM section of MXF files. <b>off:</b> Do not include VANC packet information in data items. <b>on:</b> Include VANC packet information in data items.
668	USER META DATA OUTPUT IN MXF	Select whether to output user metadata to MXF files. <b>off:</b> Do not output. <b>on:</b> Output.

Menu items in the 700s, relating to video control (VIDEO CONTROL)

Item number	Item name	Settings	
703	BLANK LINE SELECT	Switch blanking of the video output signal on or off for individual lines in the vertical blanking interval.	
	Sub-item	The Y/C signal and odd/even fields are blanked simultaneously.	
	ALL LINE	<b>--</b> : Specify the blanking for each line separately. <b>blnk</b> : Regardless of the setting of other sub-items, blank all lines which can be specified in this menu item. <b>thru</b> : Regardless of the setting of other sub-items, switch off blanking for all lines which can be specified in this menu item.	
	In 59.94i/ 59.94P/29.97P mode (UC)	LINE 12 ... LINE 19	Specify blanking for lines 12 to 19. <b>blnk</b> : Carry out blanking. <b>thru</b> : Switch off blanking.
		LINE 20	Specify blanking for line 20. <b>blnk</b> : Carry out blanking. <b>half</b> : Carry out half-blanking. <b>thru</b> : Switch off blanking.
	In 59.94i/ 59.94P/29.97P mode (J)	LINE 12 ... LINE 20	Specify blanking for lines 12 to 20. <b>blnk</b> : Carry out blanking. <b>thru</b> : Switch off blanking.
		LINE 21	Specify blanking for line 21. <b>blnk</b> : Carry out blanking. <b>half</b> : Carry out half-blanking. <b>thru</b> : Switch off blanking.
	In 50i/50P/25P mode	LINE 9 ... LINE 22	Specify blanking for lines 9 to 22. <b>blnk</b> : Carry out blanking. <b>thru</b> : Switch off blanking.
LINE 23		Specify blanking for line 23. <b>half</b> : Carry out half-blanking. <b>thru</b> : Switch off blanking.	
705	EDGE SUBCARRIER REDUCER MODE	Select whether to enable the edge subcarrier reducer (ESR). <b>on</b> : Enable. <b>off</b> : Do not enable. When playing back a composite signal, set this to "on".	
707	FORCED VERTICAL INTERPOLATION OFF	The "Y-add" function is normally switched on automatically during jog or variable speed playback. This item selects whether to force the "Y-add" function off. <sup>a)</sup> <b>auto</b> : Automatically switch the "Y-add" function on. <b>off (forced YADD off)</b> : Force the "Y-add" function off. The "Y-add" function is off while a disc image is displayed in stop mode (menu item 108 AUTO EE SELECT is "off").	
710	INTERNAL VIDEO SIGNAL GENERATOR	Select the test signal to be output from the internal test signal generator. When V INPUT on the P1 VIDEO page of the function menu is set to "SG", the internal test signal generator operates to output the selected test signal. This signal can also be recorded. <b>off</b> : Prevent "SG" from being selected for V INPUT on the P1 VIDEO page of the function menu. <b>CB75 (75% Color Bars)</b> : 75% color bar signal <b>CB100 (100% Color Bars)</b> : 100% color bar signal <b>MLTBS (Multi Burst)</b> : Multi-burst signal <b>10STP (10 steps)</b> : 10-step signal <b>PLSBR (Pulse and Bar)</b> : Pulse and bar signal <b>RAMP (Ramp)</b> : Ramp signal <b>BLACK (Black)</b> : Black signal <b>ARIBCB (ARIB Color Bars)</b> : ARIB color bar signal, modify width, 100%  <b>Note</b> ARIB CB cannot be specified when SD recording is selected. If ARIB CB is selected, the selection is changed to CB75 (75% Color Bars).	



Menu items in the 700s, relating to video control (VIDEO CONTROL)

Item number	Item name	Settings	
713	VIDEO SETUP REFERENCE	Set the video setup amount to be added to the composite input and output signal (in 59.94i/59.94P/29.97P mode only).	
	Sub-item		
	INPUT LEVEL	59.94i/59.94P/29.97P mode (UC)	Remove the setup level selected by this item from the input signal. <b>0.0%, 7.5%</b>
		59.94i/59.94P/29.97P mode (J)	Remove the setup level selected by this item from the input signal. <b>0.0%, 7.5%</b>
	OUTPUT LEVEL	In 59.94i/59.94P/29.97P mode (UC)	Add the setup level selected by this item to the output signal. <b>0.0%, 7.5%</b>
In 59.94i/59.94P/29.97P mode (J)		Add the setup level selected by this item to the output signal. <b>0.0%, 7.5%</b>	
715	VIDEO GAIN CONTROL	Adjust the video output level. <b>-2048 (-2048 (DEC)) to 0 (0 (DEC)) to 848 (848 (DEC))</b>	
716	CHROMA GAIN CONTROL	Adjust the chroma output level. <b>-2048 (-2048 (DEC)) to 0 (0 (DEC)) to 848 (848 (DEC))</b>	
717	CHROMA PHASE CONTROL	Adjust the chroma phase. <b>-128 (-128 (DEC)) to 0 (0 (DEC)) to 127 (127 (DEC))</b>	
718	SETUP LEVEL (59.94i/59.94P/29.97P mode)/BLACK LEVEL (50i/50P/25P mode)	Adjust the setup level (black level). <b>-272 (-272 (DEC)) to 0 (0 (DEC)) to 272 (272 (DEC))</b>	
719	SYSTEM PHASE SYNC	Adjust the output signal sync phase. <b>-128 (-128 (DEC)) to 0 (0 (DEC)) to 127 (127 (DEC))</b>	
720	SYSTEM PHASE SC	Adjust the output signal subcarrier phase. <b>0 (0 (DEC)) to 511 (511 (DEC))</b>	
723	INPUT VIDEO BLANK	Switch blanking on or off for lines in the vertical blanking interval of input video signals. Lines can be specified individually. Y/C signals and odd/even fields are blanked simultaneously.	
	Sub-item		
	1	ALL LINE	- - -: Specify the blanking for each line separately. <b>blink:</b> Regardless of the settings of other sub-items, blank all lines which can be specified in this menu item. <b>thru:</b> Regardless of the settings of other sub-items, switch blanking off for all lines which can be specified in this menu item.
	2...10	LINE 12 ... LINE 20	In 59.94i/59.94P/29.97P mode Specify blanking for lines 12 to 20. <b>blink:</b> Switch blanking on. <b>thru:</b> Switch blanking off.
	2...15	LINE 9 ... LINE 22	In 50i/50P/25P mode Specify blanking for lines 9, 322 to 22, and 335. <b>blink:</b> Switch blanking on. <b>thru:</b> Switch blanking off.
726	H BLANKING WIDTH	Select the horizontal blanking width of the output analog video signal. <b>narrow (narrow):</b> Digital blanking (narrow) <b>wide:</b> Analog blanking (wide) When "wide" is selected, the horizontal blanking width complies with SMPTE-170M, and normally the blanking is widened and the image becomes narrower. It is recommended to select "narrow" at the editing stage, then later, for broadcast transmission to select "wide", to output a signal conforming to the standard. Note, however, that "narrow" has to be always selected for SDI signals.	
728	OUTPUT SCH PHASE	Set the subcarrier H phase. <b>-512 (-512 (DEC)) to 0 (0 (DEC)) to 511 (511 (DEC))</b>	

Menu items in the 700s, relating to video control (VIDEO CONTROL)

Item number	Item name	Settings
731	WIDE MODE	Specify whether to record and play back with the addition of wide picture information.
	Sub-item	
	1 INPUT	Select whether to save wide picture information to the disc when recording. <b>auto:</b> Automatically save wide picture information when it is detected in the selected input video signal. <b>on:</b> Always save wide picture information. <b>off:</b> Never save wide picture information.
2 OUTPUT	Select whether to add wide picture information to the signal output. <b>thru:</b> Do not add, as specified below. <ul style="list-style-type: none"> <li>Do not add wide picture information to video output signals. Output with no change.</li> <li>Do not add wide picture information to down-converted output.</li> </ul> <b>auto:</b> Add under the conditions specified below. <ul style="list-style-type: none"> <li>Add wide picture information to video output signals automatically when wide picture information is detected.</li> <li>Add wide picture information to video output signals when down-converter output is set to squeeze mode.</li> </ul> <p><b>Notes</b></p> <ul style="list-style-type: none"> <li>To add wide picture information to the output signal, another setting is required in addition to this item. In setup menu item 703, set line 16 (59.94i/59.94P/29.97P mode (J)), line 20 (59.94i/59.94P/29.97P mode (UC)), or line 23(50i/50P/25P mode) to “thru”.</li> <li>In 59.94i/59.94P/29.97P mode (J), output of wide picture information is given priority if the VITC insertion line is set to line 16 in setup menu item 601 or 602.</li> <li>In 59.94i/59.94P/29.97P mode (UC), output of wide picture information is given priority if the VITC insertion line is set to line 20 in setup menu item 601 or 602.</li> </ul>	
740	MASTER LEVEL (HD)	Adjust the high-definition video signal output from the HDSDI OUTPUT 1, 2 (SUPER) connectors. This adjusts the Y, PB, and PR levels simultaneously. <b>-2048 (-2048 (DEC)) to 0 (0 (DEC)) to 846 (846 (DEC))</b>
741	Y LEVEL (HD)	Adjust the Y level of the high-definition video signal output from the HDSDI OUTPUT 1, 2 (SUPER) connectors. <b>-2048 (-2048 (DEC)) to 0 (0 (DEC)) to 846 (846 (DEC))</b>
742	PB LEVEL (HD)	Adjust the PB level of the high-definition video signal output from the HDSDI OUTPUT 1, 2 (SUPER) connectors. <b>-2048 (-2048 (DEC)) to 0 (0 (DEC)) to 846 (846 (DEC))</b>
743	PR LEVEL (HD)	Adjust the PR level of the high-definition video signal output from the HDSDI OUTPUT 1, 2 (SUPER) connectors. <b>-2048 (-2048 (DEC)) to 0 (0 (DEC)) to 846 (846 (DEC))</b>
745	SETUP LEVEL (HD)	Adjust the setup level of the high-definition video signal output from the HDSDI OUTPUT 1, 2 (SUPER) connectors. <b>-272 (-272 (DEC)) to 0 (0 (DEC)) to 272 (272 (DEC))</b>
746	SYNC PHASE (HD)	Control the H sync phase of the high-definition video signal output from the HDSDI OUTPUT 1, 2 (SUPER) connectors. <b>-128 (-128 (DEC)) to 0 (0 (DEC)) to 127 (127 (DEC))</b>
747	FINE (HD)	Fine control the H sync phase of the high-definition video signal output from the HDSDI OUTPUT 1, 2 (SUPER) connectors. <b>0 (0 (DEC)) to 1023 (1023 (DEC))</b>

a) The “Y-add” function is a circuit operation to interpolate the video signal vertically during jog or variable speed playback for the purpose of reducing the vertical movement of the playback picture.



**Menu items in the 800s, relating to audio control (AUDIO CONTROL)**

Item number	Item name	Settings	
802	DIGITAL AUDIO MUTING IN SHUTTLE MODE	Set the audio muting conditions during shuttle playback. <b>off:</b> Not muted. <b>on:</b> Muted.	
807	AUDIO OUTPUT PHASE	Set the output timing of digital audio playback signals (HDS/SDI, SDI only), with 80H as a reference position. Output timing is earlier for values smaller than 80H and later for values greater than 80H. (80H, 128 samples = approx. 2.7 ms, 80H, 1 sample = approx. 20 μs) <b>0 (0 (HEX)) to 80 (80 (HEX)) to FF (FF (HEX)):</b> Values can be set in this range.	
808	INTERNAL AUDIO SIGNAL GENERATOR	Select the operation of the internal audio test signal generator. <b>off:</b> Prevent "SG" from being selected for sub-item AU INPUT of items A1 INPUT to A8 INPUT on the P2 AUDIO page of the function menu. <b>silnc (silence):</b> Silent signal. <b>1kHz (1kHz sine):</b> 1 kHz, -20 dB FS sine wave signal. When you set the AU INPUT item on page P2 AUDIO of the function menu to "SG", the internal signal generator operates and outputs simultaneous test signals to channels 1 to 8 ( <i>see page 51</i> ).	
820	AUDIO OUTPUT CH3/CH4 SELECT	Select the signals output from the ANALOG AUDIO OUTPUT 3 and 4 connectors. <b>line (line out):</b> Output the signals of the audio channels selected with item 824 from the ANALOG AUDIO OUTPUT 3 and 4 connectors. <b>moni (monitor out):</b> Output the left channel of the monitor audio (CH-1) from the ANALOG AUDIO OUTPUT 3 connector, and output the right channel (CH-2) from the ANALOG AUDIO OUTPUT 4 connector.	
823	NON-AUDIO FLAG PB	Control non-audio flags in digital audio output.	
	Sub-item		
	1	CH1/CH2	During playback (except E-E mode), set non-audio flags in digital audio output to the following states. <b>on:</b> Set to on (data is non-audio.) <b>auto:</b> Set as follows. <ul style="list-style-type: none"> <li>• When data is read from disc and confirmed: Follow the data.</li> <li>• When data from disc is not confirmed: Maintain current state.</li> </ul>
	2	CH3/CH4	
	3	CH5/CH6	
4	CH7/CH8		
824	ANALOG LINE OUTPUT SELECT	Select the analog audio signals (tracks 1 to 8) to be assigned to audio output channels.	
	Sub-item		
	1	CH1/CH2	<b>tr1/2:</b> Tracks 1 and 2 assigned to audio output channels 1 and 2. <b>tr3/4:</b> Tracks 3 and 4 assigned to audio output channels 1 and 2. <b>tr5/6:</b> Tracks 5 and 6 assigned to audio output channels 1 and 2. <b>tr7/8:</b> Tracks 7 and 8 assigned to audio output channels 1 and 2.
2	CH3/CH4	<b>tr1/2:</b> Tracks 1 and 2 assigned to audio output channels 3 and 4. <b>tr3/4:</b> Tracks 3 and 4 assigned to audio output channels 3 and 4. <b>tr5/6:</b> Tracks 5 and 6 assigned to audio output channels 3 and 4. <b>tr7/8:</b> Tracks 7 and 8 assigned to audio output channels 3 and 4.	
828	SDI AUDIO OUTPUT SELECT	Select the audio signals to assign to SDI audio output channels.	
	Sub-item		
	1	CH1/CH2	<b>tr1/2:</b> Tracks 1 and 2 assigned to audio output channels 1 and 2. <b>tr3/4:</b> Tracks 3 and 4 assigned to audio output channels 1 and 2. <b>tr5/6:</b> Tracks 5 and 6 assigned to audio output channels 1 and 2. <b>tr7/8:</b> Tracks 7 and 8 assigned to audio output channels 1 and 2.
2	CH3/CH4	<b>tr1/2:</b> Tracks 1 and 2 assigned to audio output channels 3 and 4. <b>tr3/4:</b> Tracks 3 and 4 assigned to audio output channels 3 and 4. <b>tr5/6:</b> Tracks 5 and 6 assigned to audio output channels 3 and 4. <b>tr7/8:</b> Tracks 7 and 8 assigned to audio output channels 3 and 4.	

Menu items in the 800s, relating to audio control (AUDIO CONTROL)

Item number	Item name	Settings
834	AUDIO INPUT LEVEL	Select the analog audio input source.
	Sub-item	
	1   CH1	<b>line:</b> Line input <b>mic:</b> Microphone input
	2   CH2	<b>line:</b> Line input <b>mic:</b> Microphone input
	4   CH4	<b>line:</b> Line input <b>mic:</b> Microphone input
839	AUDIO AGC/LIMITER MODE	Select whether to adjust channels 1 and 2, or 3 and 4, independently or in stereo mode. These settings apply to automatic adjustments of the input levels of analog audio signals recorded on channels 1 and 2, or 3 and 4.
	Sub-item	
	1   CH1/CH2	<b>mono:</b> Automatically adjust channels 1 and 2 independently. <b>stereo:</b> Automatically adjust in stereo mode.
840	AUDIO AGC SELECT	Set the AGC saturation level property. <b>Note</b> This setting affects only channels with “mic” (microphone input) selected in setup menu item 834. Regardless of this setting, it is handled as “off” for channels with “line” (line input) selected.
	Sub-item	
	1   CH1/CH2	<b>off:</b> Do not activate AGC for CH1/CH2. <b>on:</b> Activate AGC for CH1/CH2.
	2   CH3/CH4	<b>off:</b> Do not activate AGC for CH3/CH4. <b>on:</b> Activate AGC for CH3/CH4.
	3   AGC SPEC	<b>-6dB, -9dB, -12dB, -15dB, -17dB:</b> Select the AGC settings of CH1/CH2 and CH3/CH4, to be applied when the VARIABLE/PRESET switch is set to “PRESET”.
841	AUDIO LIMITER SELECT	Set the limiter saturation level property, which limits large input signals during manual adjustment of audio input levels. <b>Note</b> This setting affects only channels with “mic” (microphone input) selected in setup menu item 834. Regardless of this setting, it is handled as “off” for channels with “line” (line input) selected.
	Sub-item	
	1   CH1/CH2	<b>off:</b> Do not activate the limiter for CH1/CH2. <b>on:</b> Activate the limiter for CH1/CH2.
	2   CH3/CH4	<b>off:</b> Do not activate the limiter for CH3/CH4. <b>on:</b> Activate the limiter for CH3/CH4.
842	MIC REFERENCE SELECT	Select the microphone input reference level.
	Sub-item	
	1   CH1/CH2	<b>-60dB, -50dB, -40dB</b>
	2   CH3/CH4	<b>-60dB, -50dB, -40dB</b>





**Menu items in the 800s, relating to audio control (AUDIO CONTROL)**

Item number	Item name	Settings
843	AUDIO OUTPUT ARRANGE	Specify the mixing of audio/voice data output signals. <b>Note</b> This appears when the PDBZ-UPG03 Software Upgrade Key or PDBK-MK1 option board is installed.  <i>See “To set up mixing of audio/voice data output signals” (page 115) for more information about how to set up mixing.</i>

**Menu items in the 900s, relating to digital process (DIGITAL PROCESS)**

Item number	Item name	Settings
920	SD-SDI H-ANC CONTROL	Select whether to add information to the SDI output.
	Sub-item	
	1 AUDIO 5CH-8CH	<b>off:</b> Do not add digital audio data channels 5 to 8. <b>on:</b> Add digital audio data channels 5 to 8.
	2 RP188 ATC	<b>off:</b> Do not add RP188 timecode data. <b>on:</b> Add RP188 timecode data.
923	AUTO SQUEEZE	Select whether to use auto squeeze mode. <b>off:</b> Do not use. <b>on:</b> Use.
925	HDMI OUTPUT SELECT	Select the resolution of the video output from the HDMI OUT connector. <b>hd (1080i/720P)</b> <b>sd-l (480i (576i))</b> <b>sd-p (480P (576P))</b>
930	DOWN CONVERTER MODE	Select the down-converter mode. <b>CROP (EDGE CROP):</b> Select the edge-crop mode. <b>L-BOX (LETTER BOX):</b> Select the letter box mode. <b>SQUEZ (SQUEEZE):</b> Select the squeeze mode.
931	DOWN CONVERTER LETTER BOX MODE	Select the aspect ratio of the down-converter output when menu item 930 is set to “l-box”. <b>16:9:</b> Set the aspect ratio of the HD-SD converter output to 16:9. <b>14:9:</b> Set the aspect ratio of the HD-SD converter output to 14:9. <b>13:9:</b> Set the aspect ratio of the HD-SD converter output to 13:9.
932	H CROP POSITION (DC)	Adjust the H-crop (the horizontal position when cropping in the edge crop mode) of the down converter output when menu item 930 is set to “crop”. <b>-120 (-120 (DEC)) to 0 (0 (DEC)) to 120 (120 (DEC))</b>
934	CROSS COLOR (DC)	Adjust the down-converter cross color. <b>0 (0 (DEC)) to 8 (8 (DEC)) to 15 (15 (DEC))</b>
935	DETAIL GAIN (DC)	Adjust the down-converter image enhancer, the sharpness of edge enhancement. <b>0 (0 (HEX)) to 7F (7F (HEX))</b>
936	LIMITER (DC)	Adjust the down-converter image enhancer, the maximum detail level added to emphasize the original signal. <b>0 (0 (HEX)) to 20 (20 (HEX)) to 3F (3F (HEX))</b>
937	CRISP (DC)	Adjust the down-converter image enhancer, the threshold amplitude at which low amplitude signals are not emphasized. <b>0 (0 (HEX)) to F (F (HEX))</b>
938	LEVEL DEPEND THRESHOLD (DC)	Adjust the down-converter image enhancer. Set the luminance range for edge enhancement. <b>0 (0 (HEX)) to 8 (8 (HEX)) to F (F (HEX))</b>
939	H DETAIL FREQUENCY (DC)	Adjust the down-converter image enhancer. Set the central frequency for edge enhancement. <b>2.6M (2.6 (MHz)), 3.4M (3.4 (MHz)), 3.9M (3.9 (MHz)), 4.6M (4.6 (MHz))</b>
940	H/V RATIO (DC)	Adjust the down-converter image enhancer. Set the horizontal/vertical ratio for edge enhancement. <b>0 (0 (DEC)) to 3 (3 (DEC)) to 7 (7 (DEC))</b>

Menu items in the 900s, relating to digital process (DIGITAL PROCESS)

Item number	Item name	Settings
942	V-FILTER SELECT (DC)	Set the vertical interpolation filter coefficient for down-converter output (in 1080 mode only). If the setting value is large, the vertical resolution is high. <b>1 (1 (DEC)) to 3 (3 (DEC))</b>
943	CROSS COLOR CRISP (DC)	Set the cross color crisp level for down-converter output. <b>0 (0 (HEX)) to 4 (4 (HEX)) to F (F (HEX))</b>
944	LEGALIZE(DC)	For down converter output, selects whether to suppress signals with levels that are lower than the pedestal level. <b>off:</b> Do not suppress signals lower than the pedestal level. <b>on:</b> Suppress signals lower than the pedestal level.
950	UP CONVERTER MODE	Select the up-converter mode. <b>CROP (EDGE CROP):</b> Select the edge-crop mode. <b>L-BOX (LETTER BOX):</b> Select the letter box mode. <b>SQUEZ (SQUEEZE):</b> Select the squeeze mode.
951	H CROP POSITION (UC)	Adjust the H-crop (the horizontal position when cropping in the edge crop mode) of the up converter output when menu item 950 is set to "crop". <b>-120 (-120 (DEC)) to 0 (0 (DEC)) to 120 (120 (DEC))</b>
952	LETTER BOX POSITION (UC)	When menu item 950 is set to "l-box", adjust the vertical location of the position where the picture is cut out for up converter output in letter box mode. <b>-120 (-120 (DEC)) to 0 (0 (DEC)) to 120 (120 (DEC))</b>
953	UP CONVERTER PROCESS	Select the source picture to use in converting SD to HD. <b>FIELD:</b> Use field pictures. <b>ADAPT (ADAPTIVE):</b> Frame or field is selected automatically.
954	DETAIL GAIN (UC)	Adjust the up-converter image enhancer, the sharpness of edge enhancement. <b>0 (0 (HEX)) to 40 (40 (HEX)) to 7F (7F (HEX))</b>
955	LIMITER (UC)	Adjust the up-converter image enhancer, the maximum detail level added to emphasize the original signal. <b>0 (0 (HEX)) to 20 (20 (HEX)) to 3F (3F (HEX))</b>
956	CRISP THRESHOLD (UC)	Adjust the up-converter image enhancer, the threshold amplitude at which low amplitude signals are not emphasized. <b>0 (0 (HEX)) to 8 (8 (HEX)) to F (F (HEX))</b>
957	LEVEL DEPEND THRESHOLD (UC)	Adjust the up-converter image enhancer. Set the luminance range for edge enhancement. <b>0 (0 (HEX)) to 8 (8 (HEX)) to F (F (HEX))</b>
958	H DETAIL FREQUENCY (UC)	Adjust the up converter image enhancer. Set the center frequency and frequency properties for edge enhancement. <b>3.2M (3.2 (MHz)):</b> 3.2 MHz ±1.1 MHz <b>4.5M (4.5 (MHz)):</b> 4.5 MHz ±1.4 MHz <b>5.0M (5.0 (MHz)):</b> 5.0 MHz ±0.7 MHz <b>4.0M (4.0 (MHz)):</b> 4.0 MHz ±2.0 MHz
959	H/V RATIO (UC)	Adjust the up-converter image enhancer. Set the horizontal/vertical ratio for edge enhancement. <b>0 (0 (DEC)) to 3 (3 (DEC)) to 7 (7 (DEC))</b>



## Menu items in the 900s, relating to digital process (DIGITAL PROCESS)

Item number	Item name	Settings	
965	IMAGE ENHANCER (INPUT UP CONVERTER)	Set up the operation of the up converter image enhancer for SD input, separately from the settings for playback (menu items 950 to 959).	
	Sub-item		
	1	ENH SETTING	<b>pb:</b> While SD signals are input, make the behavior of the image enhancer of the up-converter follow the settings for playback (menu items 950 to 959) (Settings for sub-items 2 to 11 under menu item 965 become invalid). <b>input:</b> While SD signals are input, make the behavior of the image enhancer of the up-converter follow the settings for sub-items 2 to 11 under menu item 965 (separate settings during input of SD signals from those during playback).
	2	CONVERT	Select the up-converter mode. <b>CROP:</b> Select the edge-crop mode. <b>L-BOX:</b> Select the letter box mode. <b>SQUE (SQUEZ):</b> Select the squeeze mode.
	3	H CROP P	When sub-item UP CONVERTER MODE of menu item 965 is set to “crop”, adjust the H-crop (horizontal crop) position for up converter output in edge crop mode. <b>-120 to 0 to 120</b>
	4	L BOX P	When sub-item UP CONVERTER MODE of menu item 965 is set to “l-box”, adjust the vertical location of the position where the picture is cut out for up converter output in letter box mode. <b>-120 to 0 to 120</b>
	5	CNV PROC	Select the source picture to use in converting SD to HD. <b>FIEL (FIELD):</b> Use field pictures. <b>ADAP (ADAPT):</b> Frame or field is selected automatically.
	6	DETAIL	Adjust the up-converter image enhancer. Set the sharpness of edge enhancement. <b>0 to 40 to 7F</b>
	7	LIMITER	Adjust the up-converter image enhancer. Set the maximum detail level added to emphasize the original signal. <b>0 to 20 to 3F</b>
	8	CRISP	Adjust the up-converter image enhancer. Set the threshold amplitude at which low amplitude signals are not emphasized. <b>0 to 8 to F</b>
	9	DEPEND	Adjust the up-converter image enhancer. Set the luminance range for edge enhancement. <b>0 to 8 to F</b>
	10	H DETL F	Adjust the up converter image enhancer. Set the center frequency and frequency properties for edge enhancement. <b>3.2M:</b> 3.2 MHz ±1.1 MHz <b>4.5M:</b> 4.5 MHz ±1.4 MHz <b>5.0M:</b> 5.0 MHz ±0.7 MHz <b>4.0M:</b> 4.0 MHz ±2.0 MHz
11	HV RATIO	Adjust the up-converter image enhancer. Set the horizontal/vertical ratio for edge enhancement. <b>0 to 3 to 7</b>	

### Extended menu operations

Operations in the extended menu are similar to operations in the basic menu.

When the unit is shipped from the factory, it is set up to display the extended menu. If you wish, you can hide the extended menu by changing a setting in the maintenance menu.

### To hide the extended menu

Proceed as follows to use the maintenance menu.

- 1 Holding down the HOME button, press the MENU button.

The maintenance menu appears on the video monitor display.

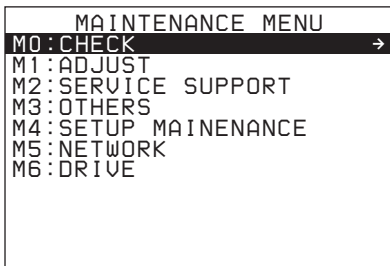

- Turn the PUSH SET knob to select “M4 SETUP MAINTENANCE”, then press the PUSH SET knob or the SELECT function button (F2).

The sub-items of M4: SETUP MAINTENANCE appears.

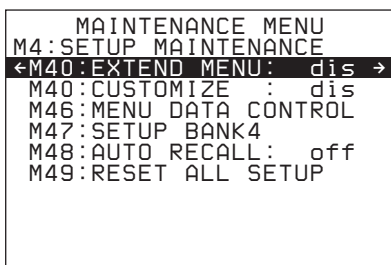

- Turn the PUSH SET knob to select “M40: EXTEND MENU”, then press the PUSH SET knob or the SELECT function button (F2).

The setting screen for M40: EXTEND MENU appears.



- Turn the PUSH SET knob to select “DISABLE”, and press the SAVE function button (F5).

The message “NOW SAVING...” appears on the video monitor display, and “Saving...” appears in the time data display area, while the new settings are saved in memory. When the saving operation is completed, the video monitor display and the time data display area return to their normal indications.

When you next display the menu and change the item display, only the basic menu will appear.



# Maintenance Menu

## Items in the maintenance menu

The following tables show the items in the maintenance menu.

- Item names are the names which appear on the video monitor of this unit and an external monitor to which the output of the COMPOSITE OUT connector, the SDDSI OUTPUT connector, or the HSDSI OUTPUT 2 (SUPER) connector is input.
- The values in the Settings columns are the values which appear in the time data display area. (The values may

appear in a different format on an external monitor. In this case, the external monitor values are shown in parentheses.) Underlined values are the factory defaults.

*This manual does not explain the menu items in M0: CHECK, M1: ADJUST, M2: SERVICE SUPPORT, and M6: DRIVE. Refer to the Maintenance Manual for an explanation of these items.*

### M3: OTHERS: Other setting items

Item	Setting
M30: SOFTWARE VERSION	Display of the software version of this unit
M31: SERIAL NUMBER	Display of the serial number of this unit
M32: FAN MODE	<p>Selects the control method for the cooling fan.  <b>auto</b>: Control the rotation of the fan automatically according to the temperature inside the unit.  <b>R-off (Rec-off)</b>: Stop the fan in recording mode.  <b>off</b>: Leave the fan stopped always.</p> <p><b>Note</b>            Even when "R-off" or "off" is selected, the fan does not stop when temperatures inside the unit are high.</p>
M33: FILE I/F CONFIG	PROAV DISPLAY Selects whether or not to display PROAV directory. <b>DISABLE</b> : Do not display PROAV directory. <b>ENABLE</b> : Display PROAV directory.
	PC REMOTE Disables or enables a FAM connection. <b>ENABLE</b> : Enable a FAM connection. <b>KEY SELECT</b> : Enable or disable a FAM connection using the PC REMOTE button on the control panel.
M36: HOUR METER RESET	Display and reset of the hours meter and the thread counter

### M3: OTHERS: Other setting items

Item	Setting
M37: AUDIO CONFIG	M370: HEAD ROOM Select the audio reference level (headroom). <b>-20dB, -18dB, -16dB, -12dB, EBUL</b>  <b>Note</b> EBUL can be selected only when the system frequency is 50i/50P/25P.
	M371: DATA LEN Select the audio channel configuration for IMX recording. <b>16bit x 8ch:</b> 16-bit, 8-channel configuration <b>24bit x 4ch:</b> 24-bit, 4-channel configuration
	M372: NON-AUDIO INPUT Select whether to handle digital audio signals as non-audio signals during recording. <b>Audio (audio):</b> Handle as linear PCM audio signals. <b>data:</b> Handle as non-audio signals.
	Sub-item
	1   tr1/tr2
	2   tr3/tr4
	3   tr5/tr6
	4   tr7/tr8
	M373: IN LEVEL Set the upper limit for the signal level input to audio channels 1/3 or 2/4. <b>+4dB, 0dB, -3dB, -6dB, EBUL</b>  <b>Note</b> EBUL can be selected only when the system frequency is 50i/50P/25P.
	Sub-item
1   CH1	
2   CH2	
3   CH3	
4   CH4	
M377: OUT LEVEL Set the reference level for audio output signals. <b>+4dB, 0dB, -3dB, -6dB, EBUL</b>  <b>Note</b> EBUL can be selected only when the system frequency is 50i/50P/25P.	
M38: F-KEY CONFIG	<i>For details, refer to the Maintenance Manual.</i>
	M380: HOME2 Assign a function menu item to page HOME2 of the function menu as a user setting.
	M381: PAGE5 ASSIGN Assign a setup menu item to page P5 of the function menu as a user setting.
	M382: PAGE5 NAME Specify the name of a setup menu item assigned with M381: PAGE5 ASSIGN.
	M38F: NV-RAM CONTROL Save the settings of M380 to M382.
M39: OTHER CONFIG	M390: MIXED REC Select whether to enable mixed format recording mode. <b>DISABLE:</b> Do not enable. <b>ENABLE:</b> Enable.
	M391: VITC REC Select whether to record the VITC of the input HDS DI signal in the LTC user bits area, and whether to play that VITC. <b>DISABLE:</b> Do not record or play. <b>ENABLE:</b> Record and play.



### M3: OTHERS: Other setting items

Item		Setting	
M3B: VANC RX PARAMETER	M3B0: VANC RX PACKET	For setting HDSDI VANC data input parameters  <b>Notes</b> <ul style="list-style-type: none"> <li>In 59.94i, 50i, 29.97P or 25P mode, selecting the line also selects the corresponding line in the second field (for example, if line 9 is selected, line 572 is also selected for VANC packet reception).</li> <li>Menu item M3B0 enables recording of one VANC packet when the selected line contains any packets whose DID/SDID matches the value set with this menu item.</li> <li>Up to four packets are recorded per each line regardless of the DID and SDID for the VANC set with menu item M3B1 or M3B2.</li> <li>It is not possible to set the same line with menu items M3B0, M3B1, and M3B2. If the same line is specified, priority is given in the order of M3B0, M3B1, and M3B2 (for example, if the same line is specified with M3B0 and M3B1, the setting with M3B1 is ignored).</li> <li>When VANC data is output to HDSDI playback signals, the number of the output VANC line is the same as that of the input VANC line.</li> <li>When a UMID or essence mark line is selected with M3B1 or M3B2, UMID or essence mark output takes priority. To disable UMID or essence mark output, set setup menu item 651 or 657 to "off".</li> </ul>	
	<b>Sub-item</b>		
	1	LINE	Selects the lines for the VANC to be received. <b>OFF, 9LINE to 20LINE</b> (59.94i/50i/29.97P/25P/23.98P mode) <b>OFF, 9LINE to 25LINE</b> (59.94P/50P mode)
	2	DID	Specification of the DID of the VANC to receive <b>00-FF</b>
	3	SDID	Specification of the SDID of the VANC to receive <b>00-FF</b>
		M3B1: LINE1 SEL	Selects the lines to be received for the HDSDI VANC data. <b>OFF, 9LINE to 20LINE</b> (59.94i/50i/29.97P/25P/23.98P mode) <b>OFF, 9LINE to 25LINE</b> (59.94P/50P mode)
		M3B2: LINE2 SEL	Selects the lines to be received for the HDSDI VANC data. <b>OFF, 9LINE to 20LINE</b> (59.94i/50i/29.97P/25P/23.98P mode) <b>OFF, 9LINE to 25LINE</b> (59.94P/50P mode)
M3C: BATTERY CONFIG	M3C0: SETUP BATTERY END	<i>For details, refer to the Maintenance Manual.</i>	
	M3C1: STATUS DISPLAY		
	M3C2: INFORMATION		
M3D: DATE/TIME PRESET		Specifies the year, month, day, time, and time zone.	
M3E: USB MEMORY UTIL		For installation of software upgrade  <i>For details, refer to the Maintenance Manual.</i>	
M3F: FACTORY SETUP		<i>For details, refer to the Maintenance Manual.</i>	

### M4: SETUP MAINTENANCE: Items relating to the setup menu

Item	Setting
M40: EXTEND MENU	Select whether to display the extended menu. <b>DISABLE:</b> Do not display. <b>ENABLE:</b> Display.
M41: CUSTOMIZE	Select whether to enable the customization function of the setup menu. <b>DISABLE:</b> Do not display. <b>ENABLE:</b> Display.

#### M4: SETUP MAINTENANCE: Items relating to the setup menu

Item		Setting
M46: MENU DATA CONTROL	M461: MENU STATUS DISP	Displays the status of the menu bank where the current menu settings are stored.
	M462: SAVE MENU DATA	Select whether to temporarily back up (save) setup menu settings before operations such as software upgrades. <b>PUSH SET knob:</b> Back up (save) the settings. <b>MENU button:</b> Return to next highest menu level without backing up.
	M463: LOAD MENU DATA	Select whether to restore (load) setting that were backed up (saved) with the "SAVE MENU DATA" item. <b>PUSH SET knob:</b> Restore (load) the settings. <b>MENU button:</b> Return to the next highest menu level without restoring.
M47: SETUP BANK4		Select the bank to be stored in menu bank 4, or reset menu bank 4. <b>CURRENT TO BANK4:</b> Store the current menu settings in menu bank 4. <b>BANK1 TO BANK4:</b> Store the menu bank 1 settings in menu bank 4. <b>BANK2 TO BANK4:</b> Store the menu bank 2 settings in menu bank 4. <b>BANK3 TO BANK4:</b> Store the menu bank 3 settings in menu bank 4. <b>RESET BANK4:</b> Reset menu bank 4.
M48: AUTO RECALL		Select whether to recall settings automatically from a menu bank when the system is powered on, and if so which menu bank to recall from. <b>off:</b> Do not recall settings from a menu bank. <b>from BANK1:</b> Recall settings from menu bank 1. <b>from BANK2:</b> Recall settings from menu bank 2. <b>from BANK3:</b> Recall settings from menu bank 3. <b>from BANK4:</b> Recall settings from menu bank 4.
M49: RESET ALL SETUP		Reset the current menu settings to the factory settings. <b>PUSH SET knob:</b> Reset. <b>MENU button:</b> Return to the next highest menu level without resetting.  <b>Notes</b> <ul style="list-style-type: none"> <li>The system frequency setting is also cleared. If you execute this item, reset the system frequency (<i>see page 35</i>).</li> <li>Date and time settings are not cleared, but the time zone setting is cleared. After executing this item, reset the time zone (<i>see page 35</i>).</li> </ul>

#### M5: NETWORK: Items relating to network settings

Item		Setting
M50: DHCP		Set whether to assign an IP address automatically with the DHCP server. <b>DISABLE:</b> Do not assign automatically. <b>ENABLE:</b> Assign automatically.
M51: IP ADDRESS PRESET		Set IP address. <b>192.168.001.010</b>  <b>Note</b> When DHCP is set to "ENABLE", it is not possible to set the IP address.
M52: SUBNET MASK PRESET		Set the subnet mask. <b>255.255.255.000</b>  <b>Note</b> When DHCP is set to "ENABLE", it is not possible to set the subnet mask.
M53: DEFAULT GATEWAY PRESET		Set the default gateway. <b>000.000.000.000</b>  <b>Note</b> When DHCP is set to "ENABLE", it is not possible to set the default gateway.
M54: LINK SPEED		Set the communications speed. <b>AUTO, 10Mbps, 100Mbps, 1000Mbps</b>





## M5: NETWORK: Items relating to network settings

Item	Setting
M55: DUPLEX	Set the communications method. <b>AUTO, Full Duplex, Half Duplex</b>  <i>For how to set the communication method, see “To change network settings” (page 162).</i>
M56: JUMBO FRAME <sup>a)</sup>	Set the size of jumbo frames. <b>9014, 4088, OFF(1514)</b>  <b>Note</b> This value does not include the 4 bytes of the FCS (Frame Check Sequence).
M57: DNS1	Set the address of DNS server 1. <b>000.000.000.000</b>  <b>Notes</b> <ul style="list-style-type: none"> <li>• The address of DNS server 1 cannot be set when DHCP is set to “ENABLE”.</li> <li>• To check the automatically acquired address of DNS server 1, close the maintenance menu and then open it again.</li> </ul>
M58: DNS2	Set the address of DNS server 2. <b>000.000.000.000</b>  <b>Notes</b> <ul style="list-style-type: none"> <li>• The address of DNS server 2 cannot be set when DHCP is set to “ENABLE”.</li> <li>• To check the automatically acquired address of DNS server 2, close the maintenance menu and then open it again.</li> </ul>
M59: UPnP	Select whether to enable the UPnP (universal plug and play) function. <b>DISABLE:</b> Disable the UPnP function. <b>ENABLE:</b> Enable the UPnP function.
M5F: RESET NET CONFIG	Reset network settings to the factory defaults. <b>SAVE function button (F5):</b> Reset. <b>MENU button:</b> Return to the next highest menu level without executing the reset.

a) A jumbo frame is a frame larger than the maximum 1514 bytes (not including FCS) of the standard Ethernet frame. Jumbo frames make it possible to deliver larger payloads per packet. Since fewer packets need to be routed, packet processing overhead is lower and network throughput is potentially improved. (Note that this item is enabled only when LINK SPEED is set to “1000Mbps”. For it to work, all other devices that handle packets on the network must also support jumbo frames.)

## Maintenance menu operations

This section describes the indications in the maintenance menu and how to change the settings.

### To display the maintenance menu

Holding down the HOME button, press the MENU button. The maintenance menu appears on the video monitor display and the currently-set menu item is displayed in reverse video.

### Meanings of indications on the menu screen

On-screen indication	Meaning
Right-pointing arrow (→) at the right of a menu item	Pressing the PUSH SET knob or the ► button switches to the next lower menu level or to a setting selection screen.

On-screen indication	Meaning
Left-pointing arrow (←) at the left of a menu item	Pressing the PUSH SET knob or the ◀ button switches to the previous (higher) menu level.
Character string at the right of a menu item	Current setting of the menu item <b>When shown with a colon (:):</b> the current setting is the same as the factory default setting. <b>When shown with a raised dot (·):</b> the current setting is different from the factory default setting.
An * (asterisk) in a complete list of settings	Factory default setting

### To change a menu item setting

Carry out the following operations to change the setting.

*For information about how to change network settings see next section “To change network settings”.*

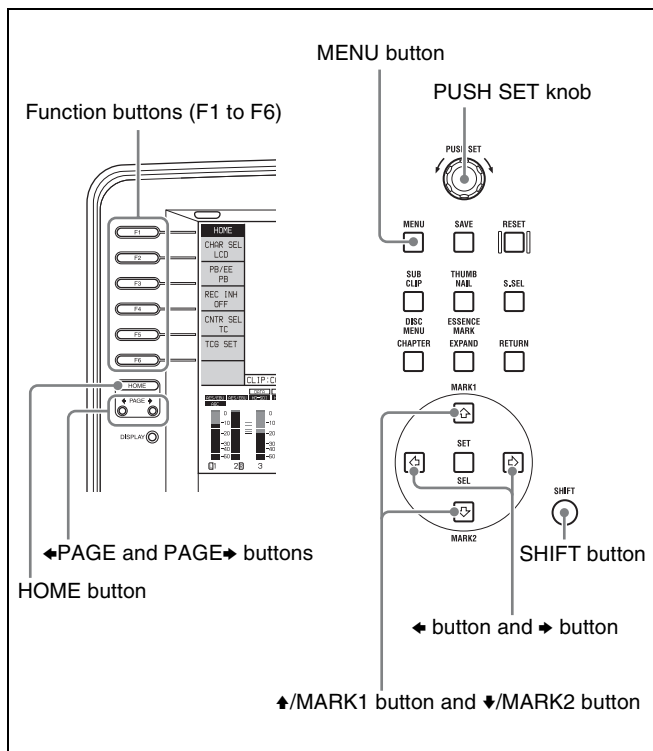

**1** Use the PUSH SET knob or the **▲**/MARK1 and **▼**/MARK2 buttons to select the required item, then press the PUSH SET knob or the SELECT function button (F2).

The sub-items of the selected item appears.

**2** Select a sub-item with the same operation as step 1, and use the PUSH SET knob or the **▲**/MARK1 and **▼**/MARK2 buttons to change the setting.

**3** Press the PUSH SET knob or the SELECT function button (F2) to confirm the setting change.

**4** Press the SAVE function button (F5).

The message “NOW SAVING...” appears on the video monitor display, and “Saving...” appears in the time data display area, while the new settings are saved in memory. When the saving operation is completed, the video monitor display and the time data display area return to their normal indications.

### To cancel changing a setting

Before pressing the SAVE function button (F5), press the MENU button.

The menu disappears from the video monitor display, without saving the new setting.

### To change network settings

To change network settings, carry out the procedure described in the previous section, “To display the

maintenance menu”, to display the NETWORK menu item, then carry out the following operations.

*For details of the settings, consult your network administrator.*

### When the IP address is assigned automatically

#### Note

Check that the network cable is connected to this unit before carrying out the operation.

Follow the procedure as shown in previous section “To change a menu item setting” to set maintenance menu item M5: NETWORK >M50: DHCP to “ENABLE”.

### To check the assigned IP address

Select maintenance menu item M5: NETWORK >M51: IP ADDRESS PRESET.

#### Note

If the IP address cannot be assigned, this is shown as “000.000.000.000.” In this case, consult the network administrator.

### To set the IP address

First set DHCP to “DISABLE” (*see the previous section, “When the IP address is assigned automatically”*).

**1** Select maintenance menu item M5: NETWORK >M51: IP ADDRESS PRESET.

**2** Press the PUSH SET knob.

The IP address appears, and the digit that can be changed flashes.

**3** Set the IP address.

#### To select a different digit to be changed

Use the **◀** and **▶** buttons.

#### To change the value of a digit

Turn the PUSH SET knob.

Turning clockwise increases the value, and turning counterclockwise decreases the value.

The **▲**/MARK1 and **▼**/MARK2 buttons can be used.

#### To return to the factory default setting

Press the RESET button.

**4** When all digits are set, press the SAVE function button (F5).

This returns to the NETWORK menu.

- 5** Repeat steps **1** to **4** as required, to set the subnet mask and default gateway.
- 6** In the NETWORK menu, press the SAVE function button (F5).
- 7** When the “NOW SAVING...” message vanishes, power the unit off and then on again with the on/standby switch.

- To return to the factory default setting**  
Press the RESET button.
- 4** Press the SAVE function button (F5).  
This returns to the NETWORK menu.

## To set the communications speed and protocol

Set the communications speed (LINK SPEED) and communications method (DUPLEX) to match the network environment.

To set the communications speed and communications protocol, proceed as explained in the previous section “To display the maintenance menu” to display the NETWORK menu and then proceed as follows.

*Contact your network administrator if you have any questions about the proper settings for these items.*

### To set the communications speed

- 1** Select maintenance menu item M5: NETWORK >M54: LINK SPEED.
- 2** Press the PUSH SET knob.  
The communications speeds (AUTO, 10Mbps, 100Mbps, and 1000Mbps) appear, and the arrow flashes.
- 3** Press the PUSH SET knob or use the ↓/MARK1 or ↑/MARK2 button to select a communications speed.

**To return to the factory default setting**  
Press the RESET button.

- 4** Press the SAVE function button (F5).  
This returns to the NETWORK menu.

### To set the communications protocol

- 1** Select maintenance menu item M5: NETWORK >M55: DUPLEX.
- 2** Press the PUSH SET knob.  
The communications protocols (AUTO, Full Duplex, Half Duplex) appear, and the arrow flashes.
- 3** Press the PUSH SET knob or use the ↑/MARK1 or ↓/MARK2 button to select a communications protocol.

## Overview

Planning metadata is a file that contains metadata about the clips to be shot and recorded.

To use planning metadata, you will need to save a file in advance in one of the locations shown below, and insert the media into this unit. (Up to 99 planning metadata files can be saved on one Professional Disc or USB flash drive.)

**Professional Disc:** General/Sony/Planning directory <sup>1)</sup>

**USB flash drive:** General/Sony/Planning directory

1) Created automatically when a disc is formatted.

## Manipulating planning metadata

This unit allows you to perform the following operations on planning metadata using the GUI screen.

- To load planning metadata files
- To sort planning metadata
- To check planning metadata properties
- To clear planning metadata
- To switch the title display in the video monitor screen

See “Using planning metadata” (page 91) for details.

## Setting clip names by using planning metadata

The following two types of clip name strings can be written in a planning metadata file.

- The ASCII format name that appears in the video monitor screen <sup>1)</sup>
- The UTF-8 format name that is actually registered as the clip name <sup>2)</sup>

1) It is also possible to display the UTF-8 format name, or no name (see page 92).

2) When no UTF-8 format name string is specified, the ASCII format name string is registered as the actual clip name.

By loading a file from one of the following locations into the unit’s memory before starting to record, you can register the names in the file as clip names.

There are two ways to load files.

- Automatically load a file that has been written to the following directory on a Professional Disc via an FTP or FAM connection.
- Use a GUI screen to load a file that has been written to the following directories on a Professional Disc or a USB flash drive (see page 91).

## File creation rules

File location	File name
<b>Professional Disc:</b> General/Sony/Planning directory <sup>a)</sup>	<ul style="list-style-type: none"><li>• Format that can be used in the General directory (see page 119)</li><li>• Extension: XML</li></ul>
<b>USB memory:</b> General/Sony/Planning directory	<ul style="list-style-type: none"><li>• ASCII characters (up to 63 characters including the extension)</li><li>• Extension: XML</li></ul>

a) General/Sony/Planning directory is created automatically when a disc is formatted. Automatically when a disc is formatted.

### Note

Do not save more than 100 planning metadata files in the above save locations. The unit may fail to load the files correctly if more than 100 are saved.

## Clip name string format

In a text editor, modify the two fields in the <Title> tag that contain the clip name strings (the shaded fields in the example below).

Enter a name in the first field in ASCII format (up to 13 characters), and enter another name in the second field in UTF-8 format (up to 52 characters).

## Clip name string example

```
<?xml_sp version="1.0" encoding="UTF-8"?><←
```

```

<PlanningMetadata_sp xmlns="http://
  xmlns.sony.net/pro/metadata/
  planningmetadata" _sp_assignId="
  P0001" _sp_creationDate="
  2008-01-20T17:00:00+09:00" _sp_lastUpdate="
  2008-03-28T10:30:00+09:00" _sp_load="
  false" _sp_version="1.00">↵
  <Properties_sp propertyId="
  assignment" _sp_update="2008-01-20T09:00:
  00+09:00" _sp_modifiedBy="Chris">↵
    <Title_sp usAscii="Typhoon" _sp_xml:lang="
    en">Typhoon_Strikes_Tokyo </Title>↵
  </Properties>↵
</PlanningMetadata>↵

```

In the above example, `_sp` indicates a space and `↵` indicates a carriage return.

### Notes

- When creating a file, write each line as a single statement, inserting carriage returns only at the indicated carriage return locations, and inserting no unspecified spaces.
- If the UTF-8 format string is longer than 52 characters, the ASCII format string is used as the clip name string.

## To set clip names

- 1 Load a planning metadata file containing clip names into the unit's memory (see page 91).
- 2 Carry out steps 2 to 5 of to set the "To assign clip names on this unit" (page 121).
- 3 Turn the PUSH SET knob to display "PLAN", and then press the PUSH SET knob.

Each time that you start recording, the unit automatically creates clip names using the names specified in the planning metadata file. An underscore ( \_ ) and a three-digit serial number (001 to 999) is appended to each clip name.

### Examples of automatically generated clip names

- Clip names displayed in the video monitor screen: Typhoon\_001, Typhoon\_002, ...
- The actually recorded clip names: Typhoon\_Strikes\_Tokyo\_001, Typhoon\_Strikes\_Tokyo\_002, ... <sup>1)</sup>

1) When display of the ASCII format clip name has been selected (see page 92).

### Notes

- The serial numbers return to 001 on the next recording operation if you reach number 999.

- Serial numbers are not reset when you power the unit off or exchange discs (newly generated numbers are continuous on the old ones).
- If the ASCII format clip name string is longer than 14 characters, it is displayed in the viewfinder as the first 8 characters + ■ (abbreviated) + the last 4 characters, for a total of 13 characters.

## Setting essence mark names by using planning metadata

You can use planning metadata to specify user-defined names for the Shot Mark0 to Shot Mark9 essence marks that correspond to the 0 to 9 keys on a USB keyboard. When planning metadata that contains user-defined essence mark name strings is loaded into this unit's memory, the unit displays those names for the essence marks that correspond to the keys and that are recorded when the keys are pressed.

See page 56 for more information about recording essence marks, and see page 164 for more information about how to load files.

## Essence mark name string format

Use a text editor to enter essence mark names in the sections indicated by shading in "Essence mark name string example". Names can be either in ASCII format (up to 32 characters) or UTF-8 format (up to 16 characters).

### Note

If a name string contains even one non-ASCII character, the maximum length of that string is 16 characters.

## Essence mark name string example

```

<?xml_sp version="1.0" _sp_encoding="UTF-8"?>↵
<PlanningMetadata
  xmlns="http://xmlns.sony.net/pro/
  metadata/planningmetadata" _sp_assignId="H00123" _sp_
  creationDate="2009-04-15T08:00:00Z" _sp_lastUpdate="
  2009-04-15T15:00:00Z" _sp_version="1.00">↵
  <Properties propertyId="assignment" _sp_class="
  original" _sp_update="2009-04-15T15:00:00Z" _sp_
  modifiedBy="Chris">↵
    <Title usAscii="Football Game" _sp_xml:lang="
    en">Football Game 15/04/2009</Title>↵
    <Meta name="_ShotMark1" _sp_content="
    Goal"/>↵
    <Meta name="_ShotMark2" _sp_content="
    Shoot"/>↵
    <Meta name="_ShotMark3" _sp_content="
    Corner Kick"/>↵
  </Properties>↵
</PlanningMetadata>↵

```

```

<Meta name="_ShotMark4" sp content=
  "Free Kick" />↵
<Meta name="_ShotMark5" sp content=
  "Goal Kick" />↵
<Meta name="_ShotMark6" sp content=
  "Foul" />↵
<Meta name="_ShotMark7" sp content=
  "PK" />↵
<Meta name="_ShotMark8" sp content=
  "1st Half" />↵
<Meta name="_ShotMark9" sp content=
  "2nd Half" />↵
<Meta name="_ShotMark0" sp content=
  "Kick Off" />↵
</Properties>↵
</PlanningMetadata>↵

```

In the above example, `sp` indicates a space and `↵` indicates a carriage return.

You can check user-defined essence mark name strings in the User Defined Essence Marks screen (*see page 92*).

#### Note

When you create a definition file, enter each statement as a single line with a CRLF only after the last character in the statement line, and do not enter spaces except where specified, except within essence mark name strings.

## Setting volume labels by using planning metadata

If you read planning metadata that contains a volume label into the unit's memory, the volume label is set in UserDiscID in DISCMETA.XML when recording of the first clip finishes. <sup>1)</sup>

1) If recording of the first clip does not end normally, the volume label is set in UserDiscID if you restore the clip by using the salvage function.

*See page 164 for more information about how to load files.*

#### Note

Volume labels cannot be set in UserDiscID in the following cases.

- When a clip has been written by a FAM or FTP connection
- When another volume label is already set in UserDiscID in DISCMETA.XML, delete the user disc ID before starting the following operation.

### How to specify volume labels

Using a text editor, enter an ASCII or UTF-8 format string (up to 127 bytes in length) in the shaded field in "Example volume label specification".

#### Note

The volume label is not set in UserDiscID if it is 128 bytes or longer.

### Example volume label specification

```

<?xml sp version="1.0" sp encoding="UTF-8"?>↵
<PlanningMetadata xmlns="http://xmlns.sony.net/pro/
  metadata/planningmetadata" sp assignId="H00123" sp
  creationDate="2010-01-27T08:00:00Z" sp lastUpdate=
  "2010-01-27T15:00:00Z" sp version="1.00">↵
  <Properties propertyId="assignment" sp class=
    "original" sp update="2010-01-27T15:00:00Z" sp
    modifiedBy="Chris">↵
    <Title usAscii="Tennis
      Tournament" sp xml:lang="en">Tennis
      Tournament 27/01/
      2010</Title>↵
    <Meta name="MediaName" sp content=
      "Australian Open 2010" />↵
  </Properties>↵
</PlanningMetadata>↵

```

In the above example, `sp` indicates a space, and `↵` indicates a newline.

The specified volume name can be checked as the User Disc ID in the Disc Properties screen (*see page 90*).

#### Note

If you create your own file, take care to enter it as a single statement, with newlines only at the newline positions and no spaces except at the indicated positions and in the volume label.

# Appendix

---

## Important Notes on Operation

### Use and storage

#### Do not subject the unit to severe shocks

The internal mechanism may be damaged or the body warped.

#### Do not cover the unit while operating

Doing so will cause temperatures to rise inside the unit, possibly resulting in failure.

#### After use

Turn off the on/standby switch.

If you plan not to use the unit for a long time, turn off the POWER switch on the connector panel as well.

#### Shipping

- Remove the disc before transporting the unit.
- If sending the unit by truck, ship, air or other transportation service, pack it in the shipping carton of the unit.

#### Care of the unit

If the body of the unit is dirty, clean it with a soft, dry cloth. In extreme cases, use a cloth steeped in a little neutral detergent, then wipe dry. Do not use organic solvents such as alcohol or thinners, as these may cause discoloration or other damage to the finish of the unit.

#### In the event of operating problems

If you should experience problems with the unit, contact a Sony service representative.

### Use and storage locations

Store in a level, ventilated place. Avoid using or storing the unit in the following places.

- In excessive heat or cold (operating temperature range: 5°C to 40°C (41°F to 104°F))  
Remember that in summer or in warm climates the

temperature inside a car with the windows closed can easily exceed 50°C (122°F).

- In damp or dusty locations
- Locations where the unit may be exposed to rain
- Locations subject to violent vibration
- Near strong magnetic fields
- Close to radio or TV transmitters producing strong electromagnetic fields.
- In direct sunlight or close to heaters for extended periods

#### To prevent electromagnetic interference from portable communications devices

The use of portable telephones and other communications devices near this unit can result in malfunctions and interference with audio and video signals.

It is recommended that the portable communications devices near this unit be powered off.

---

## Condensation

If you move the unit from a very cold place to a warm place, or use it in a damp location, condensation may form on the optical pickup. Then, if the unit is operated in this state, recording and playback may not be performed properly.

Do the following to prevent this from happening.

- When you move or operate the unit in an environment where condensation may form, be sure to insert a disc in advance.
- Whenever you turn on the on/standby switch, check that the HUMID indicator does not appear on the color LCD. If it appears, wait until it disappears before inserting a disc.

---

## About the LCD panel

LCD panels are manufactured with extremely high precision technology that yields effective pixel rates of 99.99% or higher. However, very rarely, one or more pixels may be permanently dark or permanently lit in white, red, blue, or green.

This phenomenon is not a malfunction. Such pixels have no effect on the recorded data, and the unit may be used with confidence even if they are present.

---

# Periodic Maintenance

---

## Digital hours meter

The digital hours meter can provide six items of information about the operational history of the unit. The information can be displayed in the time data display area and also, by text superimposition, on the monitor connected to the unit. Use the information as a guide in scheduling periodic maintenance.

For periodic maintenance, consult a Sony service representative.

## Display modes of the digital hours meter

### H01: OPERATION mode

Displays the total number of hours the unit has been powered on in units of 1 hour.

### H02: LASER PARAMETER mode (not resettable)

This shows a counter of the cumulative light output time by the optical head in units of hours.<sup>1)</sup>

This can be used as a guide in determining when to replace the optical head.

1) The counter advances at different rates during recording and playback. It is also affected by the ambient temperature.

### H11: OPERATION mode (resettable)

Same as H01 except that the count is resettable.

This can be used as a guide in determining when to replace parts.

### H13: SEEK RUNNING mode (resettable)

This shows the cumulative seek operation time for the optical head in units of hours. The count is resettable.

This can be used as a guide in determining when to replace the seek motor.

### H14: SPINDLE RUNNING mode (resettable)

This shows the cumulative spindle rotation time, in units of hours. The count is resettable.

This can be used as a guide in determining when to replace the spindle motor.

### H15: LOADING COUNTER mode (resettable)

Displays the total number of times disc has been loaded in the unit. The count is resettable.

## To display the digital hours meter

Press the MENU button to display the setup menu, then turn the PUSH SET knob to display the required item in the time data display area and on the monitor connected to the unit.





## **To exit from the digital hours meter**

Press the RETURN function button (F1) to return to the setup menu.

Press the EXIT function button (F5) to return to the screen that was displayed before you entered the setup menu.

---

## **Note about the battery terminal**

The battery terminal of this unit (the connector for battery packs and AC adaptors) is a consumable part.

Power may not be supplied to the unit properly if the pins of the battery terminal are bent or deformed by shock or vibrations, or if they become corroded due to prolonged outdoor use.

Periodic inspections are recommended to keep the unit working properly and to prolong its usable lifetime.

Contact a Sony service or sales representative for more information about inspections.



# Troubleshooting

## Alarms

An alarm (warning message) appears in the time data display area when an operation is attempted which is inappropriate for the settings on this unit or the state of the disc. Both the alarm message and the action to take to resolve the problem appear in the video monitor screen and on the screen of the external video monitor connected to the unit.

**REMOTE!**

Example alarm in time data display area

ALARM

REMOTE MODE IS SELECTED.

SET REMOTE/LOCAL/NETWORK  
SWITCH TO LOCAL.

Example alarm in video monitor screen

When an alarm is displayed, remove the alarm cause by following the action to take. If the alarm display does not disappear, contact a Sony service representative. Please note that there are some alarms which do not appear depending on the setting of setup menu item 016 ALARM DISPLAY (see page 136).

See "Setup Menu" (page 133) for more information about setup menu operations.

## When the unit is powered on

Alarm message in time data display area	Alarm message in video monitor screen	Description/action
ADJ. Mode!	THE UNIT IS IN ADJUSTMENT MODE. CHECK THE SWITCHES OF S2200 ON THE HPR-31 BOARD AND S500 ON THE NET-5 BOARD.	This appears when the unit is in adjustment mode. Contact a Sony service representative.
MENU Ver.UP	THE SETUP MENU SOFTWARE HAS BEEN UPGRADED. SET THE SETUP MENU ITEMS TO THE DESIRED SETTINGS.	Reset the settings in the setup menu (see page 139).
ILL. SETUP!	INVALID SETTINGS SELECTED IN SETUP MENU. SET ITEMS IN THE SETUP MENU TO THE APPROPRIATE VALUES. CONTACT SERVICE IF THIS ALARM APPEARS AGAIN AFTER ABOVE PROCEDURE.	Reset the settings in the setup menu (see page 139). If the same message appears after you reset the settings, contact a Sony service representative.
Exchg batt!	BATTERY NEEDS REPLACING. PLEASE CONTACT SERVICE.	The NVRAM battery is exhausted. Contact a Sony service representative.
Update Err!	RUN SOFTWARE UPDATE PROGRAM.	The software version is not properly updated. Update the software version again. If the same message appears after you update the software version, contact a Sony service representative.

## When a disc is inserted

Alarm message in time data display area	Alarm message in video monitor screen	Description/action
Unknown FS!	UNKNOWN FILE SYSTEM. PLEASE FORMAT DISC OR EJECT.	Format the disc, or eject it ( <i>see page 92</i> ).
No FS!	NO FILE SYSTEM.PLEASE EJECT DISC.	Eject the disc.
ILL. Disc!	IRREGULAR DISC IS USED. USE PROFESSIONAL DISC.	Use a Professional Disc.
	IRREGULAR DISC IS USED. PLEASE EJECT DISC.	
Salvage NG!	CLIP SALVAGE WAS NOT COMPLETED.	<i>See "Handling of discs when recording does not end normally (salvage functions)" (page 58).</i>
Salvage XXXX	DISC CANNOT BE RECORDED. FORMAT DISC OR CONTACT SERVICE TO RUN CLIP SALVAGE PROGRAM. (XXXX)	
Over DUR!	EXCESSIVE DURATION IS IN DISC. RECORDING AND PLAYBACK IS NOT POSSIBLE.	Data in excess of the rated capacity is recorded on the disc.
No Support!	FORMAT NOT SUPPORTED. RECORDING AND PLAYBACK IS NOT POSSIBLE.	A disc in an unsupported recording format is loaded. Use a disc formatted in the MPEG HD422 format.
ILL. Index!	INDEX FILE ERROR. PLEASE FORMAT DISC OR EJECT.	Format the disc, or eject it ( <i>see page 92</i> ).
Formatting!	AUTO FORMATTING IS EXECUTING.	Wait until the format has been completed and try again.
FORMAT NG!	AUTO FORMATTING WAS NOT COMPLETED.	Eject the disc and insert it again, or insert another disc.
DI read err	CANNOT READ DISC INFORMATION. PLEASE EJECT DISC.	
Read err		
DRV ADJ err	CANNOT PERFORM AUTO DRIVE ADJUSTMENT.	

## During control panel operations

Alarm message in time data display area	Alarm message in video monitor screen	Description/action
KEY INHI.! <sup>a)</sup>	KEY INHIBIT MODE IS SELECTED. SET KEY INHIBIT SWITCH TO OFF.	This appears when the KEY INHI switch is "on". Set the KEY INHI switch to "off".
REMOTE! <sup>a)</sup>	REMOTE MODE IS SELECTED. SET REMOTE/LOCAL/NETWORK SWITCH TO LOCAL.	Set the remote control switch to "LOCAL".
No Disc! <sup>a)</sup>	NO DISC.	Insert a disc and try again.

Alarm message in time data display area	Alarm message in video monitor screen	Description/action
REC INHI.!	AUTO FORMATTING WAS NOT COMPLETED. THE DISC WRITE PROTECT TAB IS SET TO SAVE. PLEASE EJECT DISC.	Set the disc's Write Inhibit tab to enable recording (see page 54).
	THE DISC WRITE PROTECT TAB IS SET TO SAVE.	
	AUTO FORMATTING WAS NOT COMPLETED. REC INHIBIT MODE IS SELECTED. CHECK FUNCTION MENU. PLEASE EJECT DISC.	This appears when REC INH on the HOME page of the function menu is set to "ON". Set REC INH to "OFF" (see page 50).
	REC INHIBIT.	This appears if you press the REC button when a disc error has occurred. Correct the disc error and try again.
No Clip! <sup>b)</sup>	NO CLIP.	This appears when a playback, search or delete operation is attempted on a disc with no clips recorded on it. Insert a disc with clips recorded on it.
Disc Top! <sup>a)</sup>	DISC TOP.	This appears if you press the PREV button or conduct a high-speed reverse search when the unit is stopped at the start of the disc. Use forward search or playback instead.
Disc End! <sup>a)</sup>	DISC END.	This appears if you press the NEXT button or conduct a forward high-speed search when the unit is stopped at the end of the disc. Use reverse search or playback instead.
MAX # Clips	DISC CANNOT BE RECORDED TO. FOR MORE RECORDING, DELETE SOME CLIPS.	Delete unneeded clips, or insert a disc with enough free space.
MAX # Files	DISC CANNOT BE RECORDED TO. FOR MORE RECORDING SPACE, DELETE CLIPS OR NON-AV DATA. (GENERAL FILES)	Delete clips or GENERAL files.
Disc Full!	DISC FULL.FOR MORE RECORDING, DELETE SOME CLIPS.	Delete unneeded clips, or insert a disc with enough free space.
MAX# SB CLP <sup>b)</sup>	NO MORE SUB CLIPS CAN BE ADDED TO CLIP LIST.	This appears when an attempt is made to add sub clips when 300 sub clips have already been registered. Limit the creation of sub clips to 300 or fewer.
CL OVER DUR <sup>b)</sup>	DURATION OF ONE CLIP LIST MUST BE LESS THAN 24 HOURS.	This appears when you try to add a sub clip when the total duration of sub clips in a clip list has already reached 24 hours. Create clip lists so that the total duration is within 24 hours.
Run Salvage	EXECUTE SALVAGE PROGRAM.	This appears when recording, E-E display, essence mark recording, or sub clip addition for quick scene selection is attempted on a disc that needs to be salvaged. Try again after salvaging the clips on the disc (see page 58).
CNT mode! <sup>a)</sup>	COUNTER MODE IS SELECTED. SET COUNTER SELECT MENU TO TC OR UB.	This appears when CNTR SEL on the HOME page of the function menu is set to "COUNTER", and you try to preset timecode or user bits. To use timecode or user bits, set CNTR SEL to "TC" or "UB" (see page 50).

Alarm message in time data display area	Alarm message in video monitor screen	Description/action
TC EXT! <sup>b)</sup>	TC EXTERNAL IS SELECTED. SET TC INTERNAL MODE IN TIME DATA SETTING AREA.	This appears when the INT/EXT/SDI switch is set to "EXT", and you try to preset timecode or user bits by setting the PRESET/REGEN switch to "PRESET". Set the INT/EXT/SDI switch to "INT" (see page 16).
REGEN mode! <sup>a)</sup>	TCG REGEN MODE IS SELECTED. SET TC PRESET MODE IN TIME DATA SETTING AREA.	This appears when the PRESET/REGEN switch is set to "REGEN TC" or "REGEN VITC", and you try to preset timecode or user bits. Set the PRESET/REGEN switch to "PRESET" (see page 16).
REC RUN! <sup>a)</sup>	TCG RUN MODE IS SET TO REC RUN. SET TC FREE RUN MODE IN TIME DATA SETTING AREA.	This appears when the F-RUN/R-RUN switch is set to "R-RUN", and you try to preset timecode or user bits. Set the F-RUN/R-RUN switch to "F-RUN" (see page 16).
REC mode! <sup>b)</sup>	THUMBNAIL(S) CANNOT BE DISPLAYED DURING RECORDING. CANNOT EXECUTE IN REC MODE. DRIVE MAINTENANCE MENU CANNOT BE EXECUTED WHILE IN REC MODE. INPUT SELECTION CANNOT BE CHANGED DURING RECORDING. AUDIO REC MODE CANNOT BE CHANGED DURING RECORDING.	Stop recording and try again.
REC-PAUSE!	TC/UB CANNOT BE PRESET IN REC-PAUSE MODE.	Stop recording and try again.
No SEL List <sup>b)</sup>	CLIP LIST IS NOT SELECTED.	This appears when you press the SUB CLIP/DISC MENU button while the clip list on the disc is not loaded into the current clip list. Load the clip list (see page 84) and try again.
SB CLP mode <sup>b)</sup>	TO ADD AN ESSENCE MARK, EXIT FROM SUB CLIP MODE FIRST.	This appears when an attempt is made to manipulate the essence mark while the SUB CLIP/DISC MENU button is lit or to set a clip flag while the clip list is being played back (SUB CLIP indicator is lit). Perform the operation after pressing the SUB CLIP/DISC MENU button to turn it off.
SUB CLIP NG <sup>b)</sup>	SUB CLIP IS INVALID. SET APPROPRIATE IN/OUT POINTS.	Set the In and Out points again.
No List! <sup>b)</sup>	NO CLIP LIST.	This appears when you try to delete a clip list when there is no clip list saved on the disc. Load the disc that contains the clip list you want to delete.
Loading List!	LOADING CLIP LIST.	This appears if the SUB CLIP/DISC MENU button is pressed while a clip list is loading. Wait for the clip list to finish loading and try again.
STOP ONCE! <sup>b)</sup>	STOP ONCE, THEN EXECUTE.	This appears when the SUB CLIP/DISC MENU button is pressed while the clip list is being played back or when an attempt is made to open the GUI screen with setup menu item 151 GUI OPERATION set to "stop". Perform the operation after stopping playback.
No EM space	ESSENCE MARK NOT RECORDED. NO SPACE AVAILABLE TO RECORD ESSENCE MARK.	Delete unneeded shot marks in the chapter thumbnail screen.
EM Full!	NO MORE ESSENCE MARKS CAN BE RECORDED.	
Disc Damage	DISC CANNOT BE RECORDED TO. USE ANOTHER DISC FOR RECORDING.	Use another disc.

Alarm message in time data display area	Alarm message in video monitor screen	Description/action
NON-AV Full	DISC CANNOT BE RECORDED TO. FOR MORE RECORDING SPACE, DELETE NON-AV DATA. (GENERAL FILES)	Delete unneeded GENERAL files.
Index File!	UNSUPPORT INDEX FILE. DISC CANNOT BE RECORDED TO.	Use another disc.
File System	CURRENT VERSION OF THE SOFTWARE SETS THE DISC WRITE PROTECTED.	This appears when you insert a disc that can be played back but not recorded. Exchange the disc for one with a file system supported by this unit. Or format the disc (see page 92).
	FILE SYSTEM ON THE DISC INHIBITS WRITING.	
Loading! <sup>a)</sup>	LOADING.	This appears if you press a button while a disc is loading. Wait until the disc has finished loading and try again.
Unloading! <sup>a)</sup>	UNLOADING.	This appears if you press a button while a disc is unloading. Wait until the disc has finished unloading and try again.
Clip lock!	CLIP IS LOCKED. UNLOCK CLIP IN THUMBNAIL MENU.	This appears when an operation is attempted on a locked clip. Use the Thumbnail Menu to unlock the clip (see page 81) and try again.
File Access	CANNOT CHANGE SETTINGS DURING FILE ACCESS.	This appears if you try to press the PC REMOTE button, to turn it off, during PC REMOTE file access or command processing (see page 16).
Inhibit!	PC REMOTE IS DISABLED. CHECK MAINTENANCE MENU M33.	This appears if you try to press the PC REMOTE button, to turn it off, when maintenance menu item M33: FILE I/F CONFIG >PC REMOTE is set to "ENABLE" (see page 16).
GUI Inhibit	GUI OPERATION IS INHIBITED. CHECK SETUP MENU.	This appears when the THUMBNAIL/ESSENCE MARK button or the DISC MENU (SHIFT+SUB CLIP) button is pressed while setup menu item 151 GUI OPERATION is set to "dis".

a) Displayed only when setup menu item 016 ALARM DISPLAY is set to "on".

b) Displayed only when setup menu item 016 ALARM DISPLAY is set to "on" or "limit".

## During recording and editing operations

Alarm message in time data display area	Alarm message in video monitor screen	Description/action
Input Sig! <sup>a)</sup>	VIDEO INPUT SIGNAL DOES NOT MATCH SYSTEM SETUP.	This appears when the signal that does not correspond to the system frequency or the number of lines set in this unit is being input, or when HDS DI or i.LINK TS is selected as a video input signal while setting the SD signal recording. Input a signal that matches the system frequency, or change this unit's system frequency setting (see page 44).
ILL. REC! <sup>a)</sup>	ENCODING DOES NOT SYNCHRONIZE WITH REF VIDEO.	Check the signals being input to this unit.
ILL. REF! <sup>a)</sup>	INPUT VIDEO SIGNAL DOES NOT SYNCHRONIZE WITH REF VIDEO SIGNAL. USE COMMON REFERENCE SIGNAL OR CONNECT RECORDER REF OUT TO PLAYER REF IN.	Input a reference signal synchronized with this unit's system frequency.
MEM. Full! <sup>a)</sup>	MEMORY FULL !!	Check the disc being recorded by this unit.

Alarm message in time data display area	Alarm message in video monitor screen	Description/action
Verify ERR!	DISC ERROR DETECTED.	This appears when an error is found in the signal recorded on the disc while performing the recording verification function. Change the disc.
Recording	NOW RECORDING ...	Wait for recording to finish.

a) Displayed only when setup menu item 016 ALARM DISPLAY is set to "on" or "limit".

## During playback

Alarm message in time data display area	Alarm message in video monitor screen	Description/action
ILL. PLAY! <sup>a)</sup>	ILLEGAL PLAYBACK.	Check the disc being played by this unit.
MEM. Empty! <sup>a)</sup>	MEMORY EMPTY !!	Check the disc being played by this unit.
Disc Error!	DISC ERROR DETECTED.	Use another disc.

a) Displayed only when setup menu item 016 ALARM DISPLAY is set to "on" or "limit".

## During thumbnail search, scene selection, and clip list operations

Alarm message in GUI screen	Description/action
CANNOT EXPAND CLIP ANY FURTHER.	The clip cannot be expanded into more blocks. This appears when the EXPAND button is pressed when the number of block is maximum, or when the duration of an expanded thumbnail is 1 frame.
SELECTED ESSENCE MARK DOES NOT EXIST.	The selected essence mark does not exist. This appears in the essence mark selection screen when the specified essence mark does not exist on the disc.
SUB CLIP IS INVALID.SET APPROPRIATE IN/OUT POINTS.	The temporal relationship between the specified In and Out points in sub clip trimming is not correct. Reset so that the value of the Out point timecode is larger than the value of the In point timecode.
DURATION OF ONE CLIP LIST MUST BE LESS THAN 24 HOURS.	The total duration of the current clip list is greater than 24 hours. This appears when the total duration of the current clip list exceeds the upper limit of 24 hours as the result of adding or trimming sub clips.
NO MORE SUB CLIPS CAN BE ADDED TO THE CLIP LIST.	The upper limit of sub clips in the current clip list has been reached. This appears when the upper limit of 300 clips in a clip list has been reached as the result of adding or trimming sub clips.
SUB CLIP DOES NOT EXIST.	There are no sub clips in the current clip list. This appears when an attempt is made to move, trim or delete sub clips or preset timecode.
CLIP LIST DOES NOT EXIST.	There are no clip lists on the disc. This appears when an attempt is made to execute a Delete Clip List operation when there are no clip lists on the disc.
MOVE IS INVALID.	The sub clip cannot be moved. This appear when an attempt is made to execute a Move Sub Clips operation when there are no sub clip in the current clip list, or when there is only one sub clip.
CHAPTER DOES NOT EXIST.	The specified chapter has not been recorded. This appears when an attempt is made to display a chapter when a chapter has not been recorded for that clip.
SOME ESSENCE MARK CANNOT BE DELETED.	The Rec Start essence mark cannot be deleted. This appears when an attempt is made to delete a Rec Start with a Delete Shot Mark operation. Delete Shot Mark can delete only Shot Mark1 and Shot Mark2 marks.
SOME ESSENCE MARK CANNOT BE MOVED.	Rec Start essence mark cannot be moved. This appears when an attempt is made to move a Rec Start with a Move Shot Mark operation. Move Shot Mark can move only Shot Mark1 and Shot Mark2 marks.

Alarm message in GUI screen	Description/action
CLIP IS LOCKED.	The clip is locked. This appears when an attempt is made to delete a clip, set the clip thumbnail, or delete a shot mark when the clip is locked.
ALL CLIPS ARE LOCKED.	All clips are locked. This appears when an attempt is made to execute a Lock All Clips operation when all clips are already locked.
ALL CLIPS ARE UNLOCKED.	All clips are unlocked. This appears when an attempt is made to execute an Unlock All Clips operation when all clips are already unlocked.
COMMAND DISABLED.	This appears when an attempt is made to perform Format Disc operation while Setting Format Disc is set to "Disable".
A FILE WITH THE NAME YOU SPECIFIED ALREADY EXISTS. SPECIFY A DIFFERENT NAME.	This appears when an attempt is made to set an existing clip name while changing the clip name using Set Clip Name.
SET NAMING FORM TO "FREE"	This appears when an attempt is made to change the clip name using Set Clip Name even though NAMING FORM is not set to "free" (see page 121).
"NO FLASH DRIVE"	This appears when an attempt is made to select "USB Flash Drive" in the media selection screen under Load Planning Metadata/Select Drive even though the USB memory is not connected.
NO CLIP IS RECORDED.	There are no clips on the disc. This appears when an attempt is made to execute a Lock or Delete All Clips operation when there are no clips on the disc.
NO VOICE IS RECORDED.	There are no voice data on the disc. This appears when an attempt is made to execute a Delete All Voice operation when there are no voice data on the disc.

## During edit list editing operations

### Note

Some alarms are not displayed when the PDBZ-UPG03 Software Upgrade Key or PDBK-MK1 option board is not installed.

Alarm message in GUI screen	Description/action
EDIT POINT IS INVALID.	A preview or auto edit failed because of an invalid edit point setting. This appears when, for example, an Out point is set before an In point. Reset the edit point.
SYNCHRONIZE WAS NOT COMPLETED.	A preview or auto edit failed because of a synchronization error. This appears when synchronization fails because, for example, the preroll time was too short or timecode breaks were encountered. Check the preroll time setting, and check for timecode breaks.
PREROLL WAS NOT COMPLETED.	A preroll or auto edit failed. This appears when the unit attempts to preroll to timecode that does not exist. Check the preroll time setting and the timecode.
AUTOEDIT WAS NOT COMPLETED.	An auto edit failed for a reason other than those described above. This appears when the specifications of this unit are exceeded. For example, the specifications do not allow more than 300 clips to be recorded on one disc, and do not allow the total duration of sub clips to exceed 24 hours. Check these items to make sure that you are within the specified limits, and try the editing operation again.



Alarm message in GUI screen	Description/action
PREVIEW WAS NOT COMPLETED.	A preview failed for a reason other than those described above. This appears when the specifications of this unit are exceeded. For example, the specifications do not allow more than 300 clips to be recorded on one disc, and do not allow the total duration of sub clips to exceed 24 hours. Check these items to make sure that you are within the specified limits, and try the editing operation again.
UNDO CAN NOT BE EXECUTED.	The operation that you attempted to undo cannot be undone. This appears when you press the UNDO button after an operation that cannot be undone, or when you press the UNDO button twice in succession.
UNDO WAS NOT COMPLETED.	An undo operation failed. This appears when you press the UNDO button to undo an operation, and the undo fails.
CLIPLIST CANNOT BE RE-EDITED WITH S.SEL MODE. USE EDIT MODE.	An attempt was made to execute scene selection on a clip list after executing an audio voice-over or audio split edit on that clip list. To edit that clip list, switch to EDIT LIST screen and perform edit list editing.
CLIP CANNOT BE EDITED.	An attempt was made to edit a sub clip that consists of voice data only, without video and audio data. That sub clip cannot be edited.
	An attempt was made to edit a clip that cannot be edited. That clip cannot be edited.
CAN NOT EDIT WITH DOWNCONVERT MODE.	An attempt was made to perform editing when the unit is in the down-converter mode.
CLIP WITH OVERLAPPING VOICE CANNOT BE EDITED.	In the Clip List (Trim) screen, an attempt was made to change the In point of a sub clip with overlapping voice-over. Use the EDIT LIST screen to change the In point of that clip.
EXPAND IS INVALID.	An attempt was made to expand the display of a sub clip containing only voice data, without video and audio data. The display of that sub clip cannot be expanded.
VOICE EDIT IS INVALID FOR MIXED FORMAT CLIPLIST.	An attempt was made to perform voice-over editing on a clip list that contained sub clips with different recording formats, or on a clip list that contained non-audio signals. Voice-over editing cannot be performed on that clip list.
SPLIT EDIT IS INVALID FOR MIXED FORMAT CLIPLIST.	An attempt was made to perform audio split editing on a mixed format clip list, containing sub clips with different recording formats. Audio split editing cannot be performed on that clip list.
VOICE DURATION IS MORE THAN 3 MINUTES.	In a Voice Over Video First editing operation, an attempt was made to set the duration of voice data to longer than three minutes. In Voice Over Video First editing operations, set the duration of the voice data to three minutes or less.
MORE THAN 100 VOICE CLIPS CANNOT BE REGISTERED IN ONE CLIPLIST.	An attempt was made to execute voice-over editing on a clip list that already contains the maximum 99 voice-over sub clips (specifications of this unit). No further voice-over editing is possible for that clip list.
VOICE CLIP CANNOT BE RECORDED ANY MORE.	As a result of editing operations, the number of voice-over sub clips exceeded the maximum of 99 (specifications of this unit). Redo the edit so that the number of voice-over sub clips falls within the range allowed by the specifications.
VIDEO RESOLUTION DIFFER FROM IT ON CLIP LIST.	An attempt was made to perform editing on an edit list with a video resolution and a recording format that differ from those of this unit.
SET SAME AUDIO RECORDING FORMAT AS CLIPLIST.	An attempt was made to perform voice-over editing on an edit list that contained audio in a different recording format, or on an edit list that contained non-audio signals. Change the audio recording format to match the audio format of the edit list ( <i>see page 158</i> ).
NO OPTION INSTALLED.	An editing operation was attempted with no option installed. To edit, install the PDBZ-UPG03 Software Upgrade Key, or install the PDBK-MK1 option board.
FUNCTION IS NOT AVAILABLE IN VOICE MODE.	An attempt was made to expand the display of voice data, or a menu item that cannot be used to edit voice data was selected.

Alarm message in GUI screen	Description/action
AUDIO FORMATS ARE DIFFERENT.	An edit point was set in a clip with an audio format that differs from that of this unit, on the player or the recorder. Or, the audio formats of the player and recorder are different. Set the edit point in a clip with the same audio format. Or, select the same audio format settings on the player and recorder.
SYSTEM FREQUENCIES ARE DIFFERENT.	An edit point was set in a clip with a system frequency that differs from that of this unit. Set the edit point in a clip with the same system frequency.
VOICE IS NOT SET ON RIGHT CH.	An attempt was made to execute voice over editing on a channel that is not present in the material. Execute the edit on a channel that is present in the material (channels 1 to 4 in the case of 4-channel material).
CANNOT BE EXECUTED DURING PULL DOWN MODE.	An attempt was made to edit a clip during playback in pull down mode. Pull down clips cannot be edited.
REVIEW CAN NOT BE EXECUTED.	An attempt was made to conduct a review before execution of an AUTO EDIT. Wait until the AUTO EDIT finishes, and then press the PREVIEW button while holding down the SHIFT button.
REVIEW WAS NOT COMPLETED.	A review failed. This appears when a review could not be executed.

## Alarms relating to audio and video signals

Alarm message in time data display area	Alarm message in video monitor screen	Action
No INPUT! <sup>a)</sup>	INPUT VIDEO IS NOT DETECTED. CHECK THE VIDEO INPUT MODE AND SUPPLY A VIDEO SIGNAL TO VIDEO INPUT.	<ul style="list-style-type: none"> <li>Check the setting of V INPUT on Page P1 VIDEO of the function menu (<i>see page 50</i>).</li> <li>Input the signal selected in V INPUT on page P1 VIDEO of the function menu.</li> </ul>
EMPHASIS! <sup>a)</sup>	INPUT AUDIO EMPHASIS IS NOT SUPPORTED. CHECK THE EMPHASIS OF THE AUDIO INPUT SIGNAL.	Check the emphasis of the audio input signal.
REF NON-STD	A NON-STANDARD REF SIGNAL IS BEING USED FOR REF VIDEO. USE A STANDARD SIGNAL.	Input a standard signal.

a) Displayed only when setup menu item 016 ALARM DISPLAY is set to "on".

## Alarms relating to sensors and drives

Alarm message in time data display area	Alarm message in video monitor screen	Action
FAN Stopped	FAN MOTOR STOPPED.	Contact a Sony service representative.
DR-FAN Stop	DRIVE FAN MOTOR STOPPED.	<b>Note</b> The unit will not stop operating, but if you continue to use it in this state temperatures inside the unit or the drive will rise, possibly resulting in failure or fire.
High TEMP!	HIGH TEMPERATURE. HIGH TEMPERATURE IN DRIVE.	
HUMID!	MOISTURE HAS BEEN DETECTED.	Stop recording or playback, power the unit off and on again, and wait until the HUMID display disappears.
BATT EMPTY!	BATTERY EMPTY!	Change the battery.
Unknown USB	UNKNOWN USB DEVICE.	The USB connector of this unit is for maintenance purposes and connection of USB devices. Connect a compatible USB device.

## Alarms related to system frequency and recording format

The following alarms are displayed only when setup menu item 016 ALARM DISPLAY is set to "on" or "limit".

Alarm message in time data display area	Alarm message in video monitor screen	Action
1080/59.94i 1080/29.97P 1080/50i 1080/25P 1080/23.98P 720/59.94P 720/50P 525/59.94i 625/50i	RECORDING AND PLAYBACK IS NOT POSSIBLE. SYSTEM FREQUENCY SELECTION DIFFER FROM IT ON DISC.	This appears when the system frequency selection of the unit differs from that of the loaded disc. Insert a disc with the same system frequency as the unit, or change the unit's system frequency.
1080/59.94i 1080/50i 1080/29.97P 1080/25P 1080/23.98P 720/59.94P 720/50P	DISC CANNOT BE RECORDED. VIDEO RESOLUTION DIFFER FROM IT ON DISC.	This appears when the number of system lines set in this unit does not correspond to the resolution for the inserted disc. Change the disc to the one corresponding to the number of system lines set in this unit or change the number of system lines of this unit.
HD422 1080 HD422 720 HD420 1080 HD420 720 IMX50 Clip IMX40 Clip IMX30 Clip	DISC CANNOT BE RECORDED. VIDEO REC MODE SELECTION DIFFERENT FROM VIDEO ON DISC.	This appears when the video recording format of this unit does not correspond to that of the inserted disc. Change the disc to the one corresponding to the video recording format of this unit or change the video recording format of this unit.
8CH×16 Clip 4CH×24 Clip 2CH×16 Clip	DISC CANNOT BE RECORDED. AUDIO REC MODE SELECTION DIFFERENT FROM AUDIO ON DISC.	This appears when the audio recording format of this unit does not correspond to that of the inserted disc. Change the disc to the one corresponding to the audio recording format of this unit or change the audio recording format of this unit.

## Error messages

Error codes appear in the time data display when an error (usually a hardware problem) occurs. In addition, both error messages and error codes appear in the video monitor screen and on the video monitor connected to the unit. When an error message appears, follow the instructions in the error message to resolve the problem.

Error code

Error50-010

Error code in time data display area

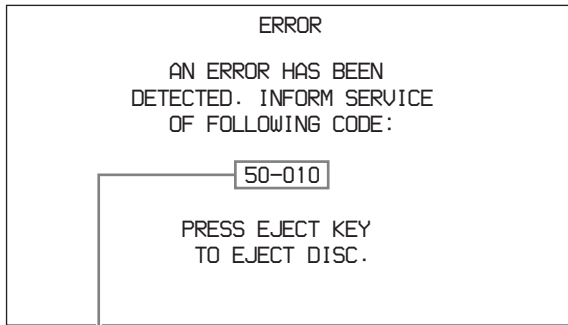

Error code

Example error in video monitor screen

## To eject discs with the unit powered off

As an emergency measure, disc cartridges can be removed with the unit powered off. This operation should always be done by a trained service technician.

# Specifications

## General

External dimensions (w/h/d, including projections)

300×146.5×420 mm  
(11 7/8×5 7/8×16 5/8 inches)

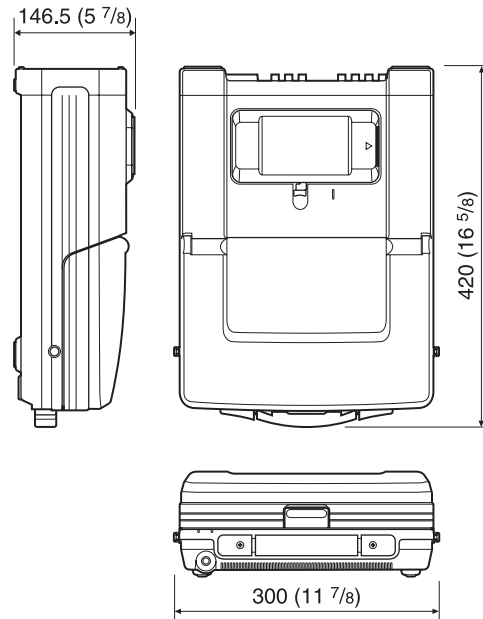

in mm (inches)

Mass 7.4 kg (16 lb. 5.0 oz.)

Power requirements

100 V to 240 V AC, 50/60 Hz

12 V DC

Power consumption

AC operation: 80 W

DC operation: 5.7 A

Peak inrush current

(1) Power ON, current probe method:  
48 A (240 V), 18 A (100 V)

(2) Hot switching inrush current,  
measured in accordance with  
European standard EN55103-1: 11 A  
(230 V)

Operating temperature

0°C to +40°C (32°F to +104°F)

Storage temperature

-20°C to +60°C (-4°F to +140°F)

Operating relative humidity

20 to 90%

## System

**Recording/playback format**

**MPEG HD422**

Video MPEG HD 422: 50 Mbps

Proxy video MPEG-4  
 Audio 24 bits, 48 kHz, 8 channels  
 Proxy audio A-law 8 bits, 8 kHz, 8 channels

### MPEG HD

Video MPEG HD: HQ35/SP25/LP18 Mbps <sup>1)</sup>  
 Proxy video MPEG-4  
 Audio 16 bits, 48 kHz, 4/2 channels  
 Proxy audio A-law 8 bits, 8 kHz, 4/2 channels

### MPEG IMX

Video MPEG HD: 50/40/30 Mbps  
 Proxy video MPEG-4  
 Audio 24/16 bits, 48 kHz, 4/8 channels  
 Proxy audio A-law 8 bits, 8 kHz, 4/8 channels

### DVCAM

Video DVCAM: 25 Mbps  
 Proxy video MPEG-4  
 Audio 16 bits, 48 kHz, 4 channels  
 Proxy audio A-law 8 bits, 8 kHz, 4 channels

1) Playback only supported for MPEG HD 18 Mbps.

## Recording/playback times

Format	Number of audio channels	Disc	
		PFD23A	PFD50DLA
MPEG HD422	8 channels	Approx. 43 minutes	Approx. 95 minutes
MPEG HQ35	4 channels	65 minutes or more	145 minutes or more
	2 channels	68 minutes or more	150 minutes or more
MPEG SP25	4 channels	Approx. 85 minutes	Approx. 190 minutes
	2 channels	Approx. 90 minutes	Approx. 200 minutes
MPEG LP18 <sup>a)</sup>	4 channels	112 minutes or more	248 minutes or more
	2 channels	122 minutes or more	265 minutes or more
MPEG IMX 50	4/8 channels	Approx. 45 minutes	Approx. 100 minutes
MPEG IMX 40		Approx. 55 minutes	Approx. 120 minutes
MPEG IMX 30		Approx. 68 minutes	Approx. 150 minutes
DVCAM	4 channels	Approx. 85 minutes	Approx. 185 minutes

a) Playback only

### Note

The recording and playback times listed above are approximate. Maximum recording times may vary depending on recording conditions.

## Search speed

Jog mode -1 to +1 times normal speed  
 Variable-speed mode -1 to +1 times normal speed  
 Shuttle mode -20 to +20 times normal speed  
 Fast forward mode +20 times normal speed  
 Fast reverse mode -20 times normal speed

## Video performance

Sampling frequency Y: 74.25 MHz, R-Y/B-Y: 37.125 MHz  
 Quantization 8 bits/sample  
 Compression MPEG-2 422P@HL

## COMPOSITE OUT

Frequency response 0.5 to 5.75 MHz+0.5/-2.0 dB  
 S/N (Y) 53 dB or more  
 Y/C delay ±20 ns or less  
 K-factor (K2T) 1.0% or less

## Processor adjustment range

Video level -∞ to +3 dB  
 Chroma level -∞ to +3 dB  
 Set up/black level ±30 IRE/±210 mV  
 Chroma phase ±30°  
 System phase SYNC: ±15 μs  
 SC: 0 to +400 ns

## Audio performance

Sampling frequency 48 kHz  
 Quantization 24 bits  
 Headroom -20/-18/-16/-12 dB (selectable)  
 Frequency response 20 Hz to 20 kHz +0.5/-1.0 dB (0 dB at 1 kHz)  
 Dynamic range 90 dB or more  
 Distortion 0.05% or less (at 1 kHz)

## Input connectors

### Digital video inputs

SD/HDSI INPUT  
 BNC type (×1), complying with SMPTE-259M (SD)/SMPTE-292M (HD)  
 (i.LINK) S400 FAM  
 6-pin type (×1), complying with IEEE1394  
 (i.LINK) HDV TS  
 6-pin type (×1), complying with IEEE1394

## Analog video inputs

### REF.VIDEO IN

BNC type (×1),  
HD Tri-level sync (0.6 Vp-p/75 Ω/  
sync negative), SD black burst, or SD  
composite sync (0.286 Vp-p/75 Ω/  
sync negative)

### COMPOSITE IN

BNC type (×1), 1.0 Vp-p, 75 Ω, sync  
negative, complying with SMPTE-  
170M

## Analog audio inputs

### ANALOG AUDIO INPUT 1 to 4

XLR 3-pin, female (×4), +4 dBu, high  
impedance, balanced

## Timecode input

### TIME CODE IN

BNC type (×1), SMPTE timecode, 0.5 to  
18 Vp-p, 10 kΩ, unbalanced

## Output connectors

### Digital video outputs

#### HDSDI OUTPUT 1, 2(SUPER)

BNC type (×2), complying with SMPTE-  
292M

#### SDSDI OUTPUT

BNC type (×1), complying with SMPTE-  
259M

#### DVB-ASI OUTPUT

BNC type (×1)

#### HDMI OUT

Type A 19-pin  
Video: 1080i, 720P, 480i, 480P, 576i,  
576P  
Audio: Linear PCM, 48 kHz/16-bit,  
2 channels

## Analog video outputs

### REF. VIDEO OUT

BNC type (×1, active loop-through with  
the REF VIDEO IN connector), HD  
Tri-level sync (0.6 Vp-p/75 Ω/sync  
negative), SD black burst, or SD  
composite sync (0.286 Vp-p/75 Ω/sync  
negative)

### COMPOSITE OUT

BNC type (×1), 1.0 Vp-p, 75 Ω, sync  
negative, complying with SMPTE-  
170M

## Analog audio outputs

### ANALOG AUDIO OUTPUT 1 to 4

XLR 3-pin, male (×4), +4 dBu, 600 Ω,  
low impedance, balanced

### AUDIO MONITOR R, L (also function as the ANALOG

AUDIO OUTPUT 3, 4 connectors, as  
selected by setup menu item 820)

XLR 3-pin, male (×2), +4 dBu, 600 Ω,  
low impedance, balanced

### PHONES

Stereo phone jack (×1),  $-\infty$  to  $-14$  dBu,  
8 Ω, unbalanced

## Timecode output

### TIME CODE OUT

BNC type (×1), SMPTE timecode,  
1.0 Vp-p, 75 Ω, unbalanced

## Remote control connectors

REMOTE(9P) D-sub 9-pin, female (×1), complying  
with RS-422A

REMOTE 4-pin, female (×1)  
12 V DC, 7.5 W

 Network RJ-45 type (×1)  
1000BASE-T: complying with  
IEEE802.3ab

100BASE-TX: complying with  
IEEE802.3u

10BASE-T: complying with IEEE802.3

## Other

### DC IN 12V connector

XLR 4-pin, male (×1), 11 V to 17 V DC

### MAINTENANCE connectors

High Speed USB (USB 2.0) Type-A (×2)

## Accessories supplied

### Operation manuals

English version (1)  
Japanese version (1)  
CD-ROM manual (1)

### Installation manual (1)

### Utility Software for XDCAM (1)

### Connector caps

## Accessories not supplied

### AC power cord

- For the customers in the U.S.A and Canada  
Part number 1-551-812-41 (125 V, 10 A, about 2.4 m)
- For the customers in the United Kingdom  
Part number 1-777-823-12 (250 V, 10 A, about 2.0 m)
- For the customers in European countries other than the  
United Kingdom  
Part number 1-551-631-61 (250 V, 10 A, about 2.0 m)

### RCC-G5 9-pin Remote Control Cable

### RM-280 Remote Edit Controller

### PFD23A Professional Disc

### PFD50DLA Dual-layer Professional Disc

BP-L80S Battery Pack  
BP-GL95 Battery Pack  
PDBK-202 MPEG TS Board  
PDBK-MK1 SxS Memory Card Adaptor for PDW-HR1

Design and specifications are subject to change without notice.

**Notes**

- Always make a test recording, and verify that it was recorded successfully. SONY WILL NOT BE LIABLE FOR DAMAGES OF ANY KIND INCLUDING, BUT NOT LIMITED TO, COMPENSATION OR REIMBURSEMENT ON ACCOUNT OF FAILURE OF THIS UNIT OR ITS RECORDING MEDIA, EXTERNAL STORAGE SYSTEMS OR ANY OTHER MEDIA OR STORAGE SYSTEMS TO RECORD CONTENT OF ANY TYPE.
- Always verify that the unit is operating properly before use. SONY WILL NOT BE LIABLE FOR DAMAGES OF ANY KIND INCLUDING, BUT NOT LIMITED TO, COMPENSATION OR REIMBURSEMENT ON ACCOUNT OF THE LOSS OF PRESENT OR PROSPECTIVE PROFITS DUE TO FAILURE OF THIS UNIT, EITHER DURING THE WARRANTY PERIOD OR AFTER EXPIRATION OF THE WARRANTY, OR FOR ANY OTHER REASON WHATSOEVER.

# Using UMID Data

Metadata is additional information recorded on discs along with audio-visual data. It is used to bring greater efficiency to the flow of operations from material acquisition through editing, and to make it easier to find and reuse material. As one of application of metadata, the UMID has been internationally standardized.

## What is a UMID?

A UMID (Unique Material Identifier) is a unique identifier for audio-visual material defined by the SMPTE-330M-2003 standard.

A UMID may be either as a 32-byte Basic UMID or an Extended UMID, which includes an additional 32 bytes of Source Pack to make a total 64 bytes.

*For details, refer to SMPTE-330M.*

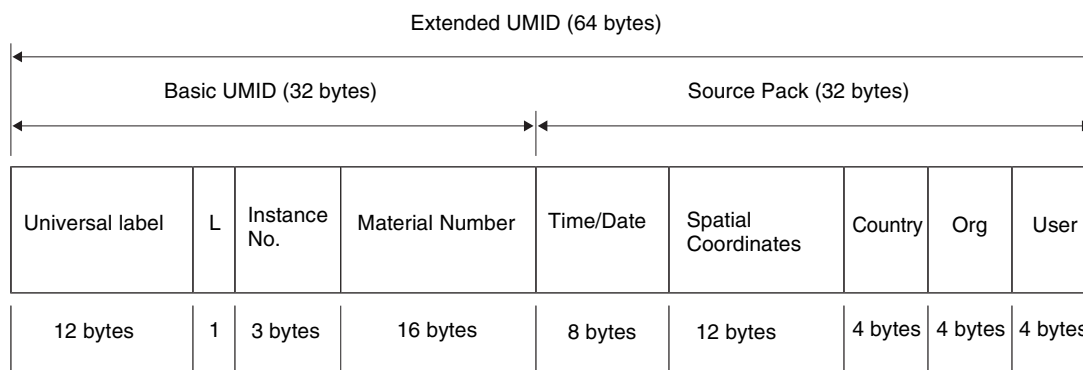

A globally unique ID is automatically recorded for every clip.

The Extended UMID is metadata that provides additional information such as location, time/date, company ID and so on.

The UMID is applied as follows.

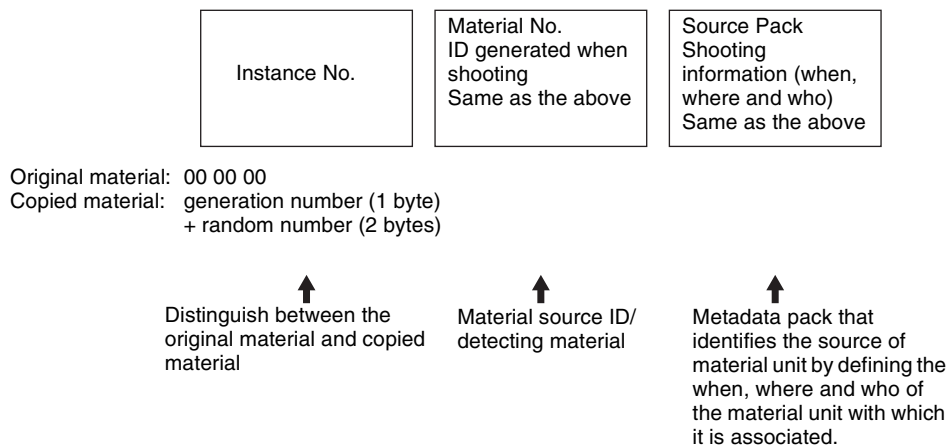

## Using the Extended UMID

You have to enter a country code, organization code and user code. Set the country code referring to the table in ISO 3166, and set the organization code and user code according to the guidelines of your organization.

*For details, see “Setting UMID ownership information” (page 185).*

## Functions of UMID data

UMID data enables the following:

- Addition of a globally unique ID to every clip of audio-visual material. The unique ID is used to detect the material source and to link it with the original source material.
- Distinguishing between original material and copied material. 00 is added to the Instance Number for original material.



- Recording with UTC time. UTC (coordinated universal time) is used when recording the UMID. Use of a universal time system enables uniform management of source material recorded all over the world.
- Calculation of date differences. Source material is recorded using modified Julian dates (MJD), which enables easy calculation of date differences between different source material items.

## Setting UMID ownership information

Proceed as follows.

- 1 Set setup menu item 029 STORE OWNER to “on” (see page 137).

The STORED OWNERSHIP (UMID ownership information setting) screen appears.

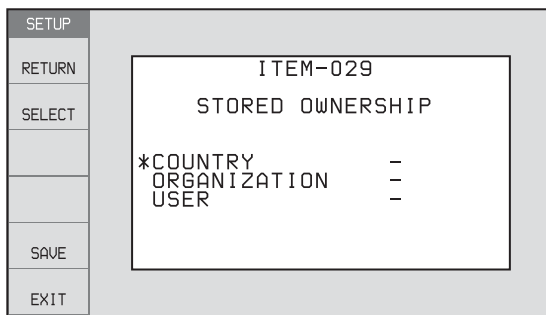

**COUNTRY:** Sets the country code.

**ORGANIZATION:** Sets the organization code.

**USER:** Sets the user code.

See the next item “About the UMID ownership information” for more information about these codes.

- 2 Use the PUSH SET knob to select the item to set and the character input location, then press the knob.
- 3 Use the PUSH SET knob, – or + function button (F3 or F4) to select characters to input at the selected location.

### To delete all input data

Press the RETURN button.

- 4 Press SAVE function button (F5).

The message “NOW SAVING...” appears, and the ownership information is saved.

See “Setup Menu” (page 133) for more information about setup menu operations.

## About the UMID ownership information

### COUNTRY (country code)

Set the country code by entering an abbreviated alphanumeric string (4-byte alphanumeric string) according to the values defined in ISO 3166-1.

There are about 240 country codes.

Find your own country code on the following web page.

Refer to ISO 3166-1:

[http://www.iso.org/iso/country-codes/iso\\_3166\\_code\\_lists.htm](http://www.iso.org/iso/country-codes/iso_3166_code_lists.htm)

When the country code is less than 4 bytes, the active part of the code occupies the first part of the 4 bytes and the remainder must be filled with the space character (20h).

### Example: Japan

For Japan, the country code is JP, which is 2 bytes, or JPN, which is 3 bytes.

Thus, enter the following:

JP \_ \_

or

JPN \_

where \_ represents a space.

### ORGANIZATION (organization code)

Enter a 4-byte alphanumeric string for the organization code.

### Notes

- There are no problems in recording or playing back audio-video signals, even if the ORGANIZATION is not set.
- Organization codes must be acquired by applying to the SMPTE registration office. When no organization code has been acquired, it is forbidden to enter an arbitrary string. As a rule, the code “00” must be entered. Freelance operators who do not belong to an origination should enter “~”.

### USER (user code)

Enter a 4-byte alphanumeric string to identify the user.

The user code is registered with each organization locally. It is usually not centrally registered.

When the user code is less than 4 bytes, enter the user code at the beginning of the 4 bytes and fill the remainder of the string with the space character (20h).

This user code is determined by the organization. The methods used depend on the organization.

### Note

User code cannot be entered when no organization code has been entered.

---

# Ancillary Data

This unit can play and record ancillary data multiplexed into HDSDI signals. It can also input and output ancillary data in MXF files when transferring files via FAM or FTP connections. Transferable auxiliary data includes text data (captions and metadata) and control signals.

---

## Ancillary data in HDSDI/SDSDI signals

This unit can record and play back closed captions conforming to the EIA-708-B <sup>1)</sup> standard and EIA-608-B <sup>1)</sup> standard, and text data conforming to the ARIB TRB23 <sup>2)</sup> which comprise the VANC (Vertical ancillary data) packets.

1) EIA: Electronic Industries Alliance

2) ARIB: Association of Radio Industries and Businesses

### To record ancillary data

In maintenance menu item M3B: VANC RX PARAMETER, set the lines where ancillary data is inserted, the DID (Data Identifier word), and the SDID (Secondary Data Identifier word) (*see page 159*).

### To record and playback EIA-708-B standard closed caption data in HDSDI signals

Set the following items.

- Sub items of maintenance menu item M3B0: VANC RX PACKET
  - LINE (line for the VANC to be received): 9LINE (example)
  - DID (data identification word): 61h
  - SDID (secondary data identification word): 01h

### To record EIA-608-B standard closed caption data in HDSDI signals

Set the following items.

- Sub items of maintenance menu item M3B0: VANC RX PACKET
  - LINE (line for the VANC to be received): 9LINE (example)
  - DID (data identification word): 61h
  - SDID (secondary data identification word): 02h

### To record EIA-608-B standard closed caption data in SDSDI (line 21) or composite (line 21) signals after conversion to the EIA-708-B standard

Set the following items.

- Sub items of maintenance menu item M3B0: VANC RX PACKET

- LINE (line for the VANC to be received): 9LINE (example)
- DID (data identification word): 61h
- SDID (secondary data identification word): 01h
- V INPUT on function menu page P1 VIDEO: SDSDI
- Setup menu item 031 RECORDING FORMAT: HD422, 420HQ, or 420SP

## VANC packets

- The Japanese ARIB TR-B23 standard limits the number of packets that can be multiplexed into HDSDI to 4 packets per line.
- The number of VANC packets that can be recorded that is set using maintenance menu item M3B is limited to 9 packets per frame for 50P or 59.94P mode and 18 packets per frame for other modes.
- When VANC packets are not continuous from word 0, and there is unused area on the line, then information about the packet position is not recorded. Packets are output flush left.
- During input, if a parity error is detected in a VANC packet, the packet is discarded and recorded flush left.

---

## Ancillary data in MXF files

VANC ancillary data recorded from a HDSDI signal can be inserted to an MXF file as an ANC Frame Element (conforming to the SMPTE-436M-2006) and can be output. This data can also be input and recorded on the disc.

### To insert ancillary data into MXF files to output

In setup menu item 666 METADATA ITEM OUT, select “on” (*see page 147*).

## HANC/VANC packets

### Detection of HANC/VANC packets

HANC/VANC packets are recorded on the disc only when the DATA ITEM of the head frame is identified as ANC Frame Elements conforming to the SMPTE-436M-2006 when an MXF file is input.

---

## General MXF metadata

This unit examines the data contained in the header metadata area <sup>1)</sup> when an MXF file is input. If the data is identified as the data created by the device other than XDCAM at this time, one file (KLVE file) is created.

1) The header metadata area contains the metadata information about the entire file. *See SMPTE-377M for details.*

For details, see “Directory structure” (page 116) and “Clip directory” (page 118).

## Closed caption data

This section explains the closed caption data that can be recorded, played back, and output during EE output.

### Normal EIA-708/608 recording and playback

In response to closed caption input data that complies with the EIA-708/608 standards, record, play, and output that data with no changes.

However, settings are required for recording of closed caption data in HDSDI signals.

For details, see “To record and playback EIA-708-B standard closed caption data in HDSDI signals” (page 186) or “To record EIA-608-B standard closed caption data in HDSDI signals” (page 186).

EIA-708/608 standard closed caption data recorded in HD video is output as HDSDI signals, regardless of menu settings.

EIA-608 standard closed caption data in SDDS (line 21) signals are recorded and played back (output as SDDS or composite signals <sup>1)</sup>), regardless of menu settings.

1) To output closed caption data as SDDS or composite signals when the area of use is set to “J” (for Japan), set line 21 in setup menu item 703 to “thru”.

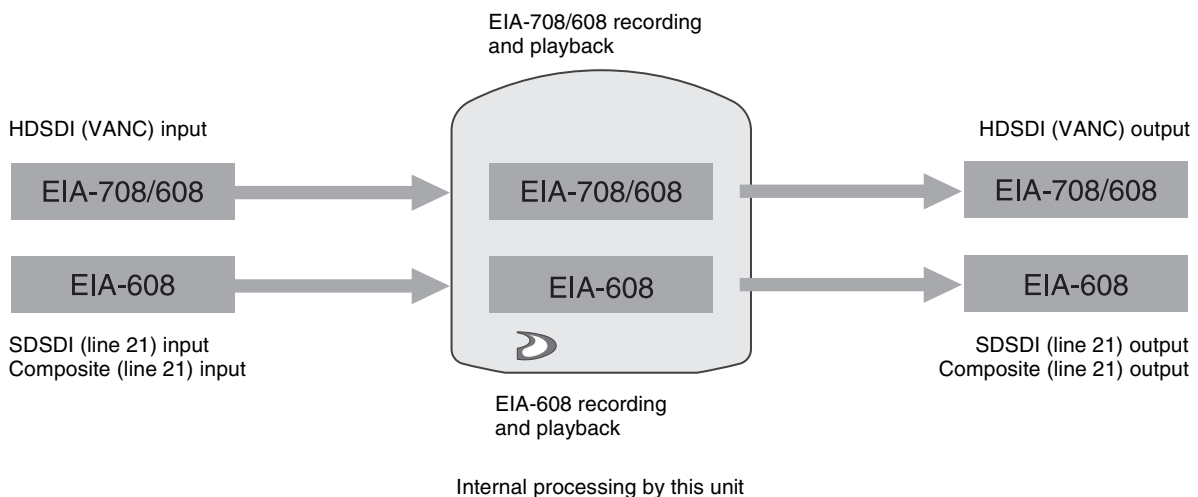

### Recording and playback after EIA-608→708 conversion

In response to closed caption input data that complies with the EIA-608 standard, record, play and output that data after conversion to EIA-708 format.

However, settings are required for recording of EIA-608 standard closed caption data.

For details, see “To record EIA-608-B standard closed caption data in SDDS (line 21) or composite (line 21) signals after conversion to the EIA-708-B standard” (page 186).

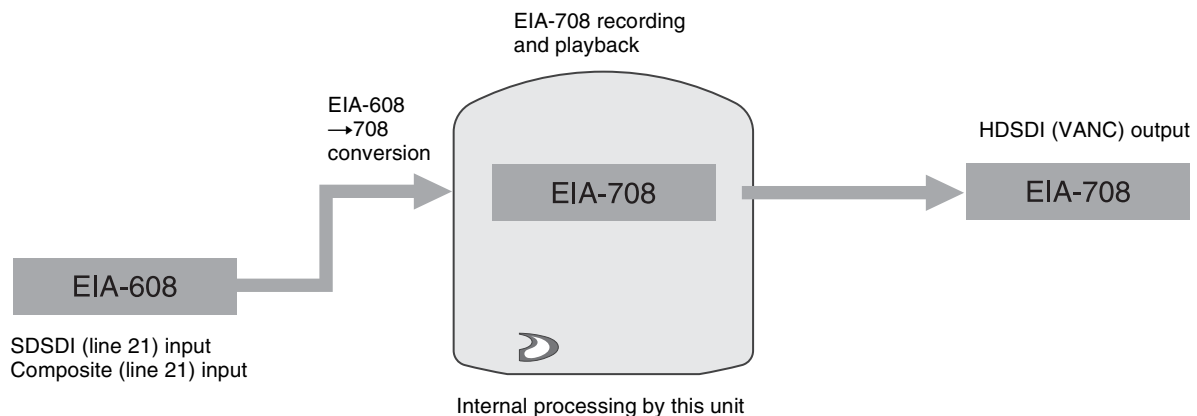

### EIA-708/608 EE output

In response to closed caption input data that complies with the EIA-708/608 standard, output to EE. However, settings are required for EE output of closed caption data in HDSDI signals.

*For details, see “To record and playback EIA-708-B standard closed caption data in HDSDI signals” (page 186) or “To record EIA-608-B standard closed caption data in HDSDI signals” (page 186).*

Closed caption data in SDDS line 21 signals are output to EE (output as SDDS or composite signals), regardless of menu settings.

**Note**

EE output of closed caption data in HDSDI signals is delayed by 1 frame with respect to EE output of the video signals.

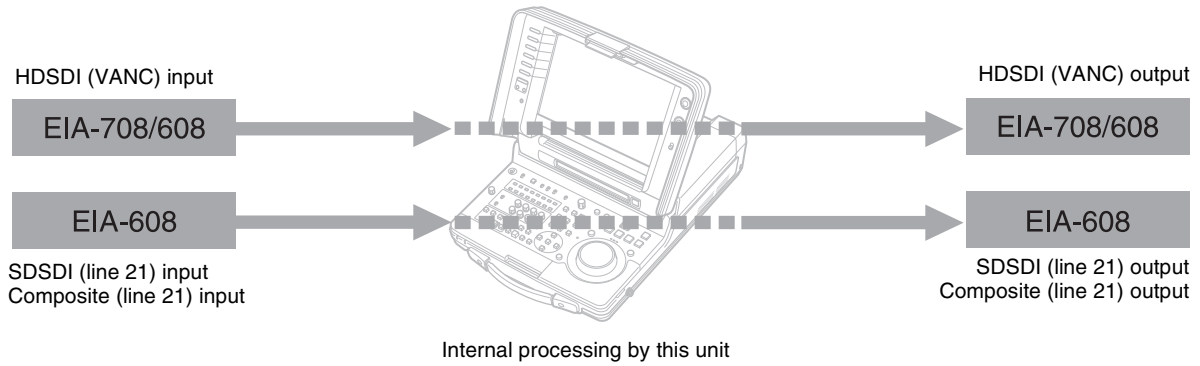

# List of Supported USB Keyboards

## When the area of use is set to “UC” and the font setting is “European Alphabet” 1)

On this unit, you can enter any of the characters and symbols supported by the keyboards listed below.

Select the corresponding language by selecting Settings > Select USB Keyboard Language in the Disc Menu (see page 79).

1) When the font setting is “Simplified Chinese” or “Traditional Chinese”, a keyboard with the same layout as the English [United States] keyboard is selected automatically.

### English [United Kingdom]

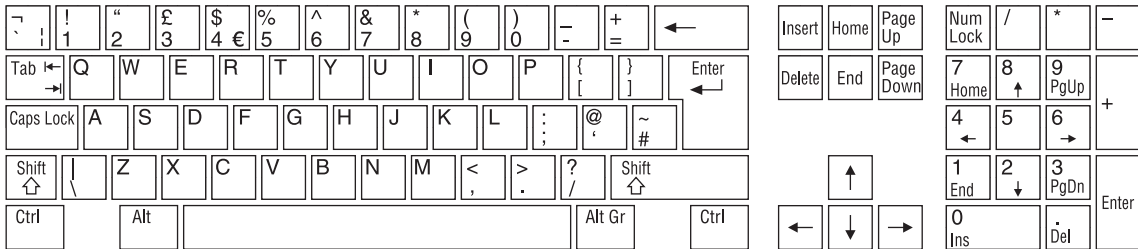

### English [United States]

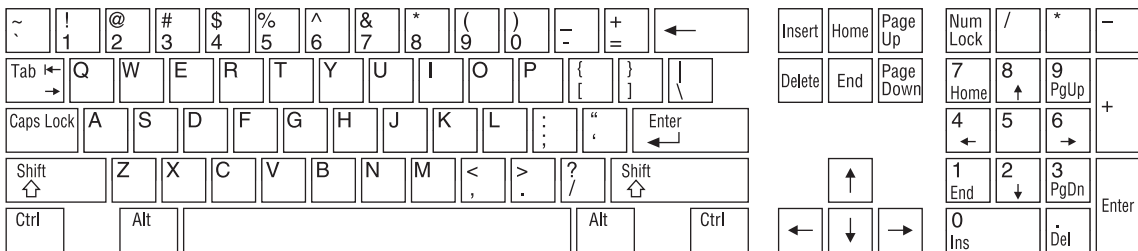

### French [France]

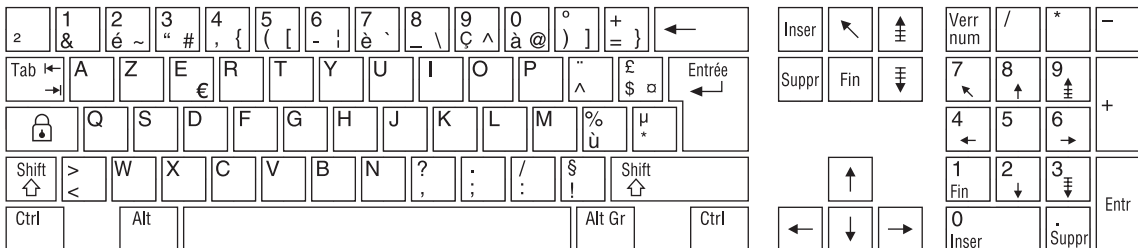

### German [Germany]

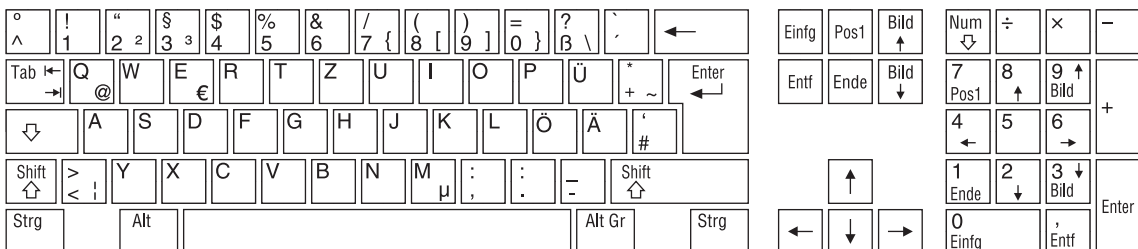

## Italian [Italy]

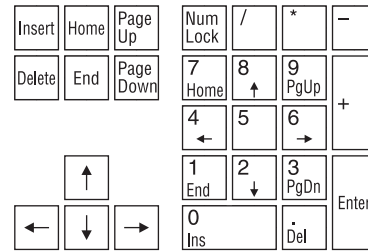
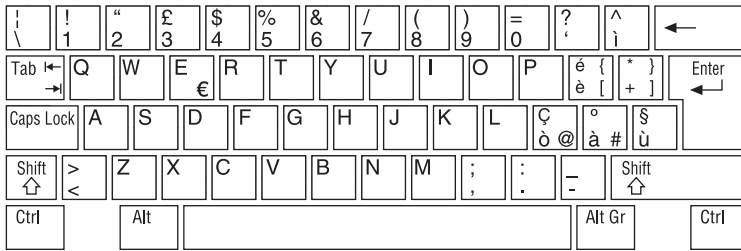

## Polish (Programmers) [Poland]

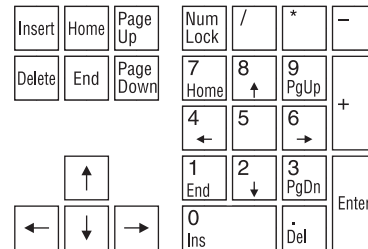
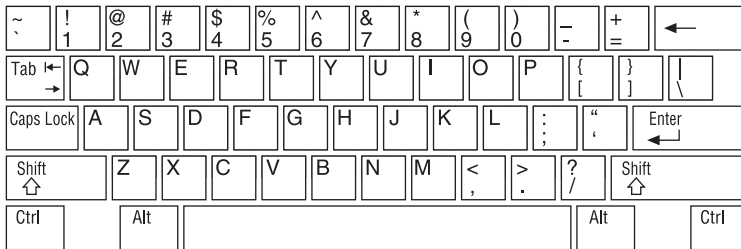

## Russian [Russia]

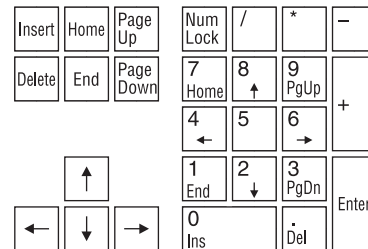

## Spanish [Spain]

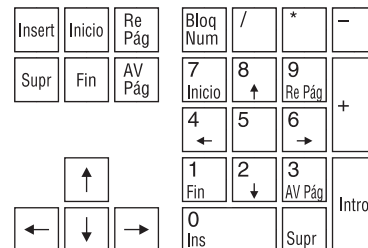
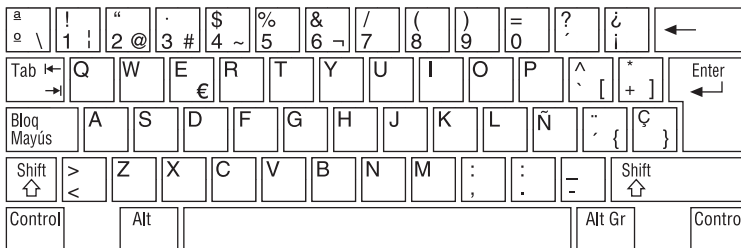

### When the area of use is set to “UC” and the font setting is “Korean”

The keyboard is fixed as the Korean keyboard, and you can enter Hangul characters.

**Note**

The keyboard language cannot be changed.

~	!	@	#	\$	%	^	&	*	(	)	-	+	←
Tab	Q	W	E	R	T	Y	U	I	O	P	{	}	
Caps Lock	A	S	D	F	G	H	J	K	L	:	"	Enter	
Shift	Z	X	C	V	B	N	M	<	>	?	Shift		
Ctrl	Alt	한자					한/영	Alt	Ctrl				

Insert	Home	Page Up	Num Lock	/	*	-
Delete	End	Page Down	7 Home	8 ↑	9 PgUp	+
			4 ←	5	6 →	
			1 End	2 ↓	3 PgDn	Enter
←	↑	→	0 Ins	.	Del	

## When the area of use is set to “J” (for Japan)

The keyboard is fixed as the Japanese keyboard.

### Notes

- The keyboard language cannot be changed.
- It is not possible to enter Japanese hiragana, katakana, and kanji.

半角/全角漢字	!	“	# あ	\$ う	% え	& お	' や	( ゆ )	) よ	を	=	^		Back space
Tab	Q	W	E	R	T	Y	U	I	O	P	,	{	}	Enter
Caps Lock	A	S	D	F	G	H	J	K	L	;	*	]	]	Enter
Shift	Z	X	C	V	B	N	M	<	>	?	.	/	Shift	
Ctrl	Alt	無変換				変換	カタカナひらがな	Alt	Ctrl					

Insert	Home	Page Up	Num Lock	/	*	-
Delete	End	Page Down	7 Home	8 ↑	9 PgUp	+
			4 ←	5	6 →	
			1 End	2 ↓	3 PgDn	Enter
←	↑	→	0 Ins	.	Del	

---

# Trademarks and Licenses

---

## MPEG-4 visual patent portfolio license

THIS PRODUCT IS LICENSED UNDER THE MPEG-4 VISUAL PATENT PORTFOLIO LICENSE FOR THE PERSONAL AND NON-COMMERCIAL USE OF A CONSUMER FOR

- (i) ENCODING VIDEO IN COMPLIANCE WITH THE MPEG-4 VISUAL STANDARD (“MPEG-4 VIDEO”) AND/OR
- (ii) DECODING MPEG-4 VIDEO THAT WAS ENCODED BY A CONSUMER ENGAGED IN A PERSONAL AND NON-COMMERCIAL ACTIVITY AND/OR WAS OBTAINED FROM A VIDEO PROVIDER LICENSED BY MPEG LA TO PROVIDE MPEG-4 VIDEO.

NO LICENSE IS GRANTED OR SHALL BE IMPLIED FOR ANY OTHER USE. ADDITIONAL INFORMATION INCLUDING THAT RELATING TO PROMOTIONAL, INTERNAL AND COMMERCIAL USES AND LICENSING MAY BE OBTAINED FROM MPEG LA, LLC. SEE [HTTP://WWW.MPEGLA.COM](http://www.mpegla.com)

MPEG LA is offering licenses for (i) manufacturing/sales of any storage media storing MPEG-4 Visual video information (ii) distribution/broadcasting of MPEG-4 Visual video information in any manner (such as online video distribution service, internet broadcasting, TV broadcasting). Other usage of this product may be required to obtain license from MPEG LA. Please contact MPEG LA for any further information. MPEG LA, L.L.C., 250 STEELE STREET, SUITE 300, DENVER, COLORADO 80206, <http://www.mpegla.com>

---

## MPEG-2 video patent portfolio license

ANY USE OF THIS PRODUCT OTHER THAN CONSUMER PERSONAL USE IN ANY MANNER THAT COMPLIES WITH THE MPEG-2 STANDARD FOR ENCODING VIDEO INFORMATION FOR PACKAGED MEDIA IS EXPRESSLY PROHIBITED WITHOUT A LICENSE UNDER APPLICABLE PATENTS IN THE MPEG-2 PATENT PORTFOLIO, WHICH LICENSE IS AVAILABLE FROM MPEG LA, L.L.C., 250 STEELE STREET, SUITE 300, DENVER, COLORADO 80206.

“PACKAGED MEDIA” means any storage media storing MPEG-2 video information such as DVD movie which are sold/distributed to general consumers. Disc replicators or sellers of the PACKAGED MEDIA need to obtain licenses for their own business from MPEG LA. Please contact MPEG LA for any further information. MPEG LA, L.L.C., 250 STEELE STREET, SUITE 300, DENVER, COLORADO 80206 <http://www.mpegla.com>

---

## About IJG (Independent JPEG Group)

This software is based in part on the work of the Independent JPEG.

---

## Character display software “iType”

This product includes technology from Monotype Imaging Inc., including iType<sup>®</sup> and certain fonts.



---

# Glossary

## Clip

A recording unit. Clips are created every time recording starts and stops.

## Clip list

A list of locations in the material recorded on the disc, arranged in any order. Clip lists can be created with the scene selection function of this unit.

## Composite video signal

A video signal in which luminance and chrominance are combined along with timing reference “sync” information to make composite video.

## Drop-frame mode

SMPTE timecode runs at 30 frames/second, while the NTSC color television system runs at about 29.97 frames/second. Drop-frame mode adjusts the running of timecode to eliminate the discrepancy between timecode value and actual time by dropping two frames from the timecode value at the beginning of each minute except every tenth minute.

## E-E mode

Electric-to-Electric mode. When you operate a VDR in E-E mode, input video and/or audio signals pass through electric circuits only and then come out from the output connectors, without passing through electromagnetic conversion circuits such as recording heads.

## Essence mark

A type of metadata that may be set for a specified frame. For more efficient searches, XDCAM equipment records essence marks as part of Non-RealTime metadata, and uses them to display thumbnails.

## HD tri-level sync

An HDTV analog reference signal that applies to 59.94/50Hz systems.

A sync signal defined in SMPTE-274M with positive, negative, and zero values.

## HDSDI signal

Abbreviation of HD Serial Digital Interface.

A signal in the HDTV serial interface defined by SMPTE-292M.

## Metadata

Information about the properties of video and audio content. XDCAM records metadata such as UMIDs and essence marks, titles, and comments.

## MXF

Material eXchange Format. A file exchange format developed by the Pro-MPEG Forum. Equipment from different manufacturers can exchange files in this format.

## Non-audio

General term for audio signals other than linear PCM, such as Dolby E<sup>1)</sup> and Dolby Digital (AC-3).<sup>1)</sup> XDCAM can record non-audio as an input signal.

1) Dolby is a trademark of Dolby Laboratories.

## Non-drop-frame mode

A mode of advancing timecode which ignores the difference in frame values between real time and the timecode. Using this mode produces a difference of approximately 86 seconds per day between real time and timecode, which causes problems when editing programs in units of seconds using the number of frames as a reference.

## Proxy AV data

Low-resolution data with a video bandwidth of 1.5 Mbps and an audio bandwidth of 64 kbps per channel. This unit records proxy AV data automatically whenever high-resolution MPEG HD data is recorded.

## Reference video signal

A video signal that contains a sync signal or sync and burst signals, used as a reference for synchronization of video equipment.

## SDSDI signal

SD Serial Digital Interface. An interface standardized as SMPTE-259M which enables the transmission of an uncompressed digital component stream.

## S/N

Signal-to-Noise ratio. The relation of the strength of the desired signal to the accompanying electronic interference, the noise. If S/N is high, sounds are reproduced with less noise and pictures are reproduced clearly without snow.

## Sub clip

One of the sections which make up a clip list. A sub clip may be part of a clip or an entire clip.

## Thumbnail image

A reduced still picture of video for display on a GUI screen. XDCAM creates thumbnail images from proxy video, and displays them as index pictures on GUI screens.

## Timecode

A digitally encoded signal which is recorded with video data to identify each frame of the video by hour, minute, second and frame number. SMPTE timecode is applied to NTSC system, and EBU timecode to PAL and SECAM systems.

## UMID

Unique Material Identifier. A standard (SMPTE-330M) for video and audio metadata. The Basic section of a UMID contains a globally unique number and a material number for the identification of recorded material. An optional section called the “Source Pack” contains information such as the time and location of recording. A UMID with the Basic section only is called a Basic UMID. A UMID with the Source Pack is called an Extended UMID.

## User bits

A total of 32 bits are provided in the timecode which the user can use to record such information as date, reel number, or scene number on video tape or disc. Also called user’s bits.

**VBID (Video Blanking ID)**

This is a video ID signal, defined in the EIAJ CPR-1204 standard, which is inserted into VBS video output to enable the aspect ratio to be detected. The ID signal is inserted into line 20, VBI 283.



# Index

## A

AC IN connector 31  
 ACCESS indicator 15, 21  
 Accessories  
   not supplied 182  
   supplied 182  
 Add Sub Clip screen 84, 85  
 AGC/limiter display 27  
 Alarms 170  
 ALL/CH-1 and CH-2 to CH-4  
   adjustment knobs 20  
 ANALOG AUDIO  
   INPUT 1 to 4 connectors 32  
   OUTPUT 1 to 4 connectors 32  
 Ancillary data 186  
 Appendix 167  
 Area of use setting 35  
 Audio channel 27  
 Audio input display 27  
 Audio level  
   adjusting 113  
 Audio level adjustment section 19  
 Audio level meters 27, 30  
 AUDIO MONITOR SELECT buttons  
   19  
 Audio split editing 114  
 AUTO EDIT button 20

## B

BACKLIGHT switch 24  
 Basic menu 133  
   changing settings 139  
   items 134  
   operations 138  
 Battery  
   attaching a battery pack 34  
   checking the remaining power 35  
 Battery pack shoe 14  
 BRIGHTNESS adjustment knob 23  
 Built-in speakers (stereo) 14

## C

Carrying handle 14  
 Chapter  
   function 74  
   thumbnail screen 67  
 CHAPTER button 18  
 CHROMA switch and adjustment knob  
   22  
 Clip 83  
   changing index picture 77

  continuous playback mode 60  
   deleting 81  
   duration 66  
   finding 73  
   locking 81  
   playback screen 64  
   properties 78  
   selecting by type 75  
   single clip playback mode 60  
   thumbnail screen 64, 66  
   transferring 95  
   unlocking 81  
   user-defined name 121  
 Clip Continuous Rec function 58  
   indication 25  
 Clip information 25  
 Clip List  
   (Move) screen 86  
   (Trim) screen 86  
   user-defined name 121  
 Clip list 83  
   changing start timecode 87  
   clearing 89  
   creating and editing 84  
   current clip list 84  
   deleting 89  
   loading 89  
   managing 89  
   playback screen 64  
   previewing 84  
   saving 88  
   sorting 89  
   thumbnail screen 64, 67  
 Clip Properties screen 78  
 Closed caption data 187  
 Command list 127  
 Communications speed 163  
 COMPOSITE IN/OUT connectors 33  
 Connections 37  
   cut editing system 38  
   edit list editing system 41  
   editing control unit settings 40  
   FAM connection 37  
   for pool coverage 42  
   for using application software 37  
   FTP connection 37  
 Connector panel 31  
 CONTRAST adjustment knob 23  
 Control panel 15  
 Control panel illumination LED 23  
 Current clip list 84

## D

Data indication 27  
 Date and time 25  
 Date/time setting 36  
 DC IN 12V connector 32

DELETE button 20  
 Delete Clip 82  
 Delete Clip & Clip List 82  
 Digital hours meter 168  
   display modes 168  
   displaying 168  
   exiting 169  
 Direct FTP function 95  
 Disc exchange cache function 57  
   indication 26  
 Disc loaded indication 29  
 Disc Menu 69  
 Disc slot 14  
 Discs 90  
   ejecting with the unit powered off  
     180  
   formatting 54, 92  
   handling 53  
   loading/unloading 54  
   properties 90  
   reconstructing 58  
   salvage functions 58  
   usable discs 53  
   write-protecting 54  
 Display 23  
 DISPLAY button 24  
 Display panel 23  
 Display screen 24  
   basic operation display 24  
   video monitor display 30  
 DVB-ASI OUTPUT connector 33

## E

EDIT button 20  
 Edit list editing 102  
   operations 108  
 EDIT LIST screen 104  
 Edit Menu 105  
 Editing  
   control unit 38  
   controller 40  
 Editing modes 108  
 Editing operation section 20  
 Editing screens 104  
   operations 107  
   switching 102  
 EJECT button 14  
 Ejecting a disc manually 180  
 ENTRY button 21  
 Error messages 179  
 Essence mark  
   search 74  
   setting 56, 61  
   thumbnail screen 68  
 Expand  
   function 11, 73  
   thumbnail screen 67

EXPAND button 18  
 Extended menu 133  
   items 140  
   operations 155  
 External synchronization 43  
 EXT-LOCK 29

## F

Features 10  
 File operations 116  
   Clip directory 118  
   Component directory 118  
   directory structure 116  
   Edit directory 119  
   General directory 119  
   root directory 117  
   Sub directory 119  
   UserData directory 119  
 File Operations in File Access Mode  
 (for Macintosh) 125  
   exiting file operations 126  
   making FAM connections 125  
   operating on files 125  
   reconnecting 126  
 File Operations in File Access Mode  
 (for Windows) 123  
   exiting file operations 124  
   making connections 123  
   operating on files 124  
   preparations 123  
   reconnecting 124  
   recording continuous timecode  
     132  
 Filter Clips function 75  
 Format conversion display 28  
 Formatting discs 92  
 F-RUN/R-RUN switch 16  
 FTP file operations 126  
   command list 127  
   logging in 127  
   logging out 127  
   making connections 126  
   preparations 126  
   recording continuous timecode  
     132  
 Function buttons (F1 to F6) 23  
 Function menu 24, 49  
   HOME page 50  
   P1 VIDEO page 50  
   P2 AUDIO page 51  
   P3 TC page 52  
   P4 OTHER page 52

## G

Gigabit Ethernet 12  
 Glossary 193

GOTO button 20  
 GUI screens 64  
   operations 71

## H

HDMI OUT connector 33  
 HDMI output display 28  
 HDSDI OUTPUT 1, 2 (SUPER)  
   connectors 32  
 HDSDI output conversion display 28  
 HDSDI remote control function 57  
 HOME button 23  
 HUE/CHROMA-PHASE switch and  
   adjustment knob 22

## I

i.LINK HDV TS connector 32  
 i.LINK S400 FAM connector 32  
 IN and OUT buttons 21  
 Index picture  
   changing 77  
 Initial setup 35  
 Input signal 28  
 Input signal display 27  
 Insert mode editing 108  
 INT/EXT/SDI switch 16

## J

JOG indicator 22  
 Jog mode 62  
 Jog/shuttle direction indicators 22

## K

KEY INHI indicator 24  
 KEY INHI switch 16

## L

Left-/right-arrow buttons 18  
 LEVEL adjustment knob 19  
 Level bars 28  
 Loading/unloading disc 54

## M

Maintenance  
   periodic 168  
 MAINTENANCE connectors 33  
 Maintenance menu 157  
   communications speed 163  
   items 157  
   network settings 162  
   operations 161  
 MARK1/MARK2 buttons 18  
 Menu  
   bank setting 137

  changing settings 139  
   configuration 133  
   disc menu 69  
   edit menu 105  
   function menu 49  
   maintenance menu 157  
   returning to default settings 139  
   setup menu 133

MENU button 17

Menu operation section 17

Menu setting status 25

Metadata 184

Meter display mode 28

MIC POWER (+48 V) 1 and 2 switches  
 32

Microphone settings 32

Mixed format recording mode 55

Monitor channel 27

Move Shot Mark screen 74

## N

Names and functions of parts 14

NDF 29

Network

  assigning IP address automatically  
     162

  connector 33

  setting IP address 162

  settings 162

NEXT button 19

Normal speed playback 61

## O

On/standby switch 16

OPERATION indicator 21

Overlay mode editing 108

## P

PAGE buttons 23

PAUSE button 18

PC REMOTE button 16

PHONES jack 21

Planning Metadata 91

PLAY button 19

Playback 60

  clip list 84

  jog mode 62

  normal speed 61

  settings 60

  shot mark settings 61

  shuttle mode 62

  start position 60

  variable-speed mode 63

Playback condition

  display 48

  mark 48

- PLAYER and RECORDER buttons 16
  - PLAYER mode screen 104
  - Power status 25, 30
  - POWER switch 31
  - Preparation
    - initial setup 35
  - PRESET/REGEN switch 16
  - PREV button 19
  - PREVIEW button 20
  - Professional Disc 53
  - Proxy AV data 11
  - Pulldown playback 60
  - PUSH SET knob 17
- R**
- REC button 18
  - REC INHI indicator 18
  - RECALL button 20
  - RECORDER mode screen 105
  - Recording 55
    - HDSDI remote control function 57
    - level adjustment 56
    - salvage 58
    - settings 55
    - shot mark settings 56
    - time 34, 90
  - Recording and playback control section 18
  - Recording format 25
  - REF.VIDEO IN connector 33
  - REF.VIDEO OUT connector 33
  - Reference level 27
  - Reference signal 28
  - Remaining memory capacity 25
  - Remaining recording capacity 29
  - REMOTE connector 32
  - Remote control switch 16
  - Remote interface 25
  - REMOTE(9P) connector 33
  - Repeat playback mode indication 29
  - Replace editing 108
  - RESET button 17
  - RETURN button 18
- S**
- S.SEL button 17
  - Salvage function 58
  - SAVE button 17
  - Scene
    - finding 73, 74
  - Scene selection 83
  - Scrollbar 66
  - SD/HDSDI INPUT connector 32
  - SDSDI OUTPUT connector 33
  - SDSDI output conversion display 28
  - Security slot 14
  - Select Essence Mark screen 74
  - Select Index screen 77
  - SET button 18
  - Set Start Time Code screen 88
  - Setup menu
    - basic menu 134
    - extended menu 140
  - SETUP/BLACK switch and adjustment knob 22
  - SHIFT button 18
  - Shortcut 101
  - Shoulder belt posts 14
  - Shuttle mode 62
  - SHUTTLE/JOG button 22
  - Shuttle/jog dial 22
  - Shuttle/jog/variable operation section 22
  - Single clip playback indication 26
  - Skip Scroll 72
  - Source selection 28
  - Specifications 180
  - STANDBY indicator 19
  - STOP button 19
  - Sub clip 83
    - adding 84
    - deleting 87
    - reordering 86
    - trimming 86
  - SUB CLIP/DISC MENU button 17
  - Superimposed text information 47
  - Supplying power 34
    - AC power supply 34
    - Battery power supply 34
    - DC power supply 34
  - Synchronization reference signals 43
  - System frequency setting 36
  - System information 25
- T**
- Text information 47
  - Thumbnail
    - display items 66
    - operations 72
    - selecting 72
    - selecting information displayed 77
    - selecting multiple thumbnails 73
  - Thumbnail Menu 68
  - Thumbnail search 73
    - using chapter function 74
    - using essence marks 74
    - using expand function 73
    - using thumbnails 73
  - THUMBNAIL/ESSENCE MARK button 17
  - TIME CODE IN/OUT connectors 33
  - Time data 29
  - Time data display area 29, 30
  - Time data settings section 16
  - Time data type 29
  - Timecode 44
    - after setting initial value 44
    - recording external timecode directly 46
    - recording sequentially upon the last recorded timecode 45
    - recording with the internal timecode generator synchronized 45
    - setting to current time 45
  - Title 120
  - TRIM buttons 20
  - Troubleshooting 170
- U**
- UMID data 184
  - UNDO button 21
  - Up-/down-arrow buttons 18
  - USB connector 33
  - User bits
    - setting 45
- V**
- VAR/JOG button 22
  - VARIABLE/PRESET switches 19
  - Variable-speed mode 63
  - Vectorscope 30
  - VIDEO PROCESS CONTROL switch 21
  - Video processing settings section 21
  - VIDEO switch and adjustment knob 21
  - VITC 29
  - Voice-over editing 112
- W**
- WARNING indicator 24
  - Waveform monitor 30
  - Web Thumbnail function 93
  - Write-protecting discs 54

The material contained in this manual consists of information that is the property of Sony Corporation and is intended solely for use by the purchasers of the equipment described in this manual.

Sony Corporation expressly prohibits the duplication of any portion of this manual or the use thereof for any purpose other than the operation or maintenance of the equipment described in this manual without the express written permission of Sony Corporation.

