

IC Recorder

| | | |
|----------------------------|-------|------------|
| Getting Started | _____ | ██████████ |
| Basic Operations | _____ | ██████████ |
| Other Recording Operations | _____ | ██████████ |
| Other Playback Operations | _____ | ██████████ |
| Editing Messages | _____ | ██████████ |
| Listening to the FM Radio | _____ | ██████████ |
| About the Menu Function | _____ | ██████████ |
| Utilizing Your Computer | _____ | ██████████ |
| Additional Information | _____ | ██████████ |
| Troubleshooting | _____ | ██████████ |

Operating Instructions

IC RECORDER

ICD-UX200/UX300/UX200F/UX300F

Owner's Record

The model number is located at the rear panel and the serial number is located inside the battery compartment. Record these numbers in the space provided below. Refer to these numbers whenever you call upon your Sony dealer regarding this product.

Model No. _____
Serial No. _____

**FOR UNITED STATES
CUSTOMERS. NOT APPLICABLE
IN CANADA, INCLUDING IN THE
PROVINCE OF QUEBEC.
POUR LES CONSOMMATEURS
AUX ÉTATS-UNIS. NON
APPLICABLE AU CANADA, Y
COMPRIS LA PROVINCE DE
QUÉBEC.**

For the customers in the United States

The following FCC statement applies only to the version of this model manufactured for sale in the USA. Other versions may not comply with FCC technical regulations.

INFORMATION

This equipment has been tested and found to comply with the limits for a Class B digital device, pursuant to Part 15 of the FCC Rules. These limits are designed to provide reasonable protection against harmful interference in a residential installation. This equipment generates, uses and can radiate radio frequency energy and, if not installed and used in

accordance with the instructions, may cause harmful interference to radio communications.

However, there is no guarantee that interference will not occur in a particular installation. If this equipment does cause harmful interference to radio or television reception, which can be determined by turning the equipment off and on, the user is encouraged to try to correct the interference by one or more of the following measures:

- Reorient or relocate the receiving antenna.
- Increase the separation between the equipment and receiver.
- Connect the equipment into an outlet on a circuit different from that to which the receiver is connected.
- Consult the dealer or an experienced radio/TV technician for help.

You are cautioned that any changes or modifications not expressly approved in this manual could void your authority to operate this equipment.

If you have any questions about this product, you may call: Sony Customer Information Service Center 1-800-222-7669 or <http://www.sony.com/>

Declaration of Conformity

Trade Name : SONY
Model : ICD-UX200/UX300
Responsible Party : Sony Electronics Inc.
Address : 16530 Via Esprillo,
San Diego, CA 92127 USA
Telephone Number : 858-942-2230

This device complies with part 15 of the FCC Rules. Operation is subject to the following two conditions: (1) This device may not cause harmful interference, and (2) this device must accept any interference received, including interference that may cause undesired operation.

- The recorded music is limited to private use only. Use of the music beyond this limit requires permission of the copyright holders.
- Sony is not responsible for incomplete recording/downloaded or damaged data due to problems of the IC recorder or computer.
- Depending on the types of the text and characters, the text shown on the IC recorder may not be displayed properly on device. This is due to:
 - The capacity of the connected IC recorder.
 - The IC recorder is not functioning normally.
 - Content information is written in the language or the character that is not supported by the IC recorder.

Notice for the customers in Canada

This class B digital apparatus complies with Canadian ICES-003.

For the customers in the USA and Canada

RECYCLING NICKEL METAL HYDRIDE BATTERIES

Nickel metal hydride batteries are recyclable.

You can help preserve our environment by returning your used rechargeable batteries to the collection and recycling location nearest you.

For more information regarding recycling of rechargeable batteries, call toll free 1-800-822-8837, or visit <http://www.rbrc.org/>.

Caution: Do not handle damaged or leaking nickel metal hydride batteries.



Table of Contents

Getting Started

| | |
|---|----|
| Step 1: Checking the Contents of the Package | 7 |
| Index to parts and controls | 8 |
| Step 2: Recharging the Battery | 9 |
| When to charge/replace the battery | 11 |
| Step 3: Turning the IC Recorder On | 12 |
| Turning the power on | 12 |
| Turning the power off | 12 |
| Step 4: Setting the Clock | 13 |
| Setting the clock after recharging the battery | 13 |
| Setting the clock using the menu | 13 |
| Step 5: Setting the Language to Be Used in the Display Window | 15 |
| Preventing Accidental Operation (HOLD) | 17 |
| Locking the buttons | 17 |
| Unlocking the buttons | 17 |

Basic Operations

| | |
|-----------------|----|
| Recording | 18 |
| Listening | 22 |
| Erasing | 26 |

Other Recording Operations

| | |
|---|----|
| Changing the Recording Settings | 28 |
| Selecting the recording mode | 28 |
| Setting the microphone sensitivity | 29 |
| Cutting out low frequency | |
| – the LCF function | 31 |
| Starting to record automatically in response to sound | |
| – the VOR function | 32 |
| Operating during Recording | 34 |
| Monitoring the recording | 34 |
| Dividing a message during recording | 34 |
| Recording via Other Devices | 36 |
| Recording with an external microphone | 36 |
| Recording from other equipment | 37 |

Other Playback Operations

| | |
|--------------------------------------|----|
| Changing the Playback Method | 42 |
| Convenient playback methods | 42 |
| Adjusting the playback speed | |
| – the DPC function | 43 |
| Changing the Playback Settings | 45 |
| Selecting the playback mode | 45 |
| Making the human voice clearer | |
| – the noise cut function | 47 |
| Selecting the sound effect | 48 |

| | |
|--|----|
| Playing Back a Message at a Desired Time with an Alarm | 50 |
| Playback via Other Devices | 53 |
| Recording with other equipment | 53 |

Editing Messages

| | |
|--|----|
| Erasing All Messages in a Folder | 55 |
| Moving a Message to a Different Folder | 56 |
| Dividing a Message into Two | 58 |

Listening to the FM Radio

| | |
|--|----|
| Tuning in an FM Radio Station | 60 |
| Switching the FM radio output between speaker and headphones | 61 |
| Switching the receiver sensitivity of the FM radio | 62 |
| Recording FM broadcasts | 63 |
| Presetting FM Radio Stations Automatically | 64 |
| Switching the scanning sensitivity | 65 |
| Presetting FM Radio Stations Manually | 67 |
| Listening to a Preset Radio Station | 68 |
| Erasing Preset FM Radio Stations | 69 |

About the Menu Function

| | |
|------------------------------------|----|
| Making Settings for the Menu | 71 |
| Menu Settings | 72 |

Utilizing Your Computer

| | |
|---|----|
| Using the IC Recorder with Your Computer | 83 |
| System requirements for your computer | 83 |
| Connecting the IC recorder to your computer | 84 |
| Construction of folders and files | 85 |
| Copying Messages from the IC Recorder to Your Computer to Save Them | 87 |
| Copying Music Files from Your Computer to the IC Recorder and Playing Them Back | 88 |
| Copying a music file from your computer to the IC recorder (drag and drop) | 88 |
| Enjoying the music files more | 90 |
| Using the IC Recorder as USB Memory – Data Storage Function | 91 |
| Using Voice Recognition Software | 92 |
| Introducing the voice recognition software | 92 |
| Creating a user file adapted to your recorded speech (Training) | 92 |
| Disconnecting the IC Recorder from Your Computer | 94 |

Additional Information

| | |
|---|----|
| Using a USB AC Adaptor (not supplied) | 95 |
|---|----|

| | |
|---|-----|
| Disconnecting the IC recorder from the AC outlet | 96 |
| Precautions | 97 |
| Specifications | 99 |
| System requirements | 99 |
| Design and specifications | 100 |
| Battery life | 103 |

Troubleshooting

| | |
|----------------------------|-----|
| Troubleshooting | 105 |
| Error Messages | 112 |
| System Limitations | 115 |
| Display Window Guide | 116 |
| Index | 119 |
| Trademarks | 122 |

Step 1: Checking the Contents of the Package

IC Recorder (1)

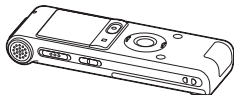

Remove the film on the display window before you use the IC recorder.

NH-AAA (size AAA) rechargeable battery (1)



Stereo headphones (1)



USB connection support cable (1)

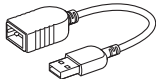

If the IC recorder cannot be connected to a computer directly, use the supplied USB connection support cable.

Battery case (1)

Operating Instructions

You are cautioned that any changes or modifications not expressly approved in this manual could void your authority to operate this equipment.

Index to parts and controls

Front

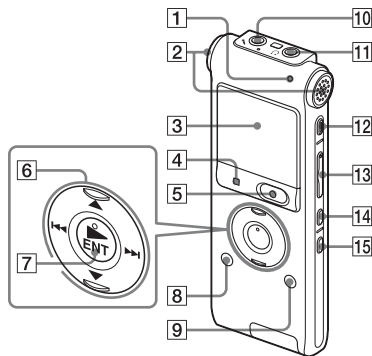

- 1** Operation indicator
- 2** Built-in microphones (stereo)
- 3** Display window
- 4** ■ STOP button
- 5** ● REC (record)/PAUSE button
- 6** Control button (▲, ▼ / ◀▶ (review/fast backward), ▶▶ (cue/fast forward))
- 7** ▶ (play)/ENT (enter) button*
- 8** 📁 (folder) button
- 9** MENU button
- 10** 🎧 (microphone) jack*
- 11** 🎧 (headphone) jack

- 12** ERASE button
- 13** VOL (volume) +*/- button
- 14** ↺ (repeat) A-B button
- 15** DIVIDE button

Rear

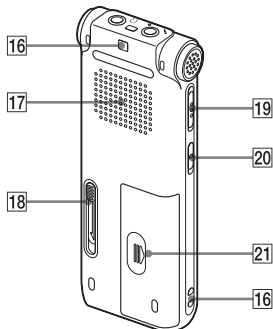

- 16** Strap hole (A strap is not supplied.)
- 17** Speaker
- 18** USB slide lever
- 19** HOLD/POWER switch
- 20** DPC (SPEED CTRL) switch
- 21** Battery compartment

* These buttons and the jack have a tactile dot. Use it as a reference point for operations, or to identify each terminal.

Step 2: Recharging the Battery

Remove the film on the display window before you use the IC recorder.

Connect the IC recorder to a running computer, and charge the battery until the battery indicator indicates “**FULL**.” When you use the IC recorder for the first time, or after you have not used the IC recorder for a certain period of time, charge the battery continuously until “**FULL**” is displayed.

It takes about 3 hours and 30 minutes to fully charge exhausted battery.*1

You can also charge the battery by using an AC-U50A USB AC adaptor (not supplied), etc.

1 Insert a rechargeable battery.

Slide and lift the battery compartment lid, insert one NH-AAA rechargeable battery with correct polarity, and close the lid.

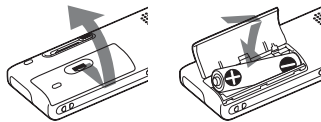

2 Insert the USB connector of the IC recorder into the USB port of a computer.

Slide the USB lever on the back of the IC recorder in the direction of the arrow, and insert the USB connector into the USB port of a running computer.*2

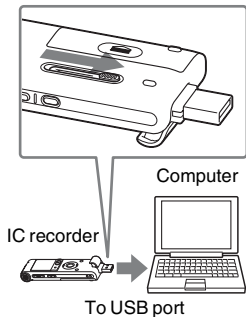

While the battery is charging, “Connecting” and the battery indicator are displayed in an animation.

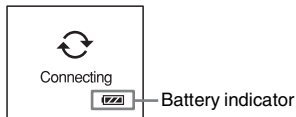

3 Disconnect the IC recorder from your computer.

Follow the procedures below; otherwise, when the IC recorder contains data files, the files may be damaged or become unplayable.

- 1 Perform the following operation on your computer.
On the Windows screen, left-click the icon at the bottom of the desktop of the computer.



→ Left-click “Safely remove USB Mass Storage Device.”
The icon can be different on different operating systems.
On the Macintosh screen, drag the “IC RECORDER” on the desktop to “Trash” and drop it there.

For details on disconnecting the IC recorder from your computer, refer to the operating instructions supplied with your computer.

- 2 Make sure that the display of the IC recorder turns off.
- 3 Disconnect the IC recorder from the USB port of the computer, and slide the USB lever in the direction of the arrow to retract the USB connector.

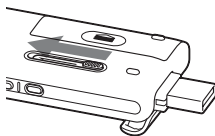

- *1 This is an approximation for the time it takes to charge from no remaining battery power to full battery power at room temperature. It varies depending on the remaining power and the condition of the battery. It also takes more time if the temperature of the battery is low, or if the battery is charged while you are transferring data to the IC recorder.
- *2 If the IC recorder cannot be connected to a computer directly, use the supplied USB connection support cable.

Note

If the battery indicator is not displayed in an animation, charging has not been done properly. See “Troubleshooting” on page 108.

When using a fully charged battery or an LR03 (size AAA) alkaline battery

Follow the step 1.

Tips

- Do not use manganese battery for this IC recorder.
- When replacing the battery, messages recorded or alarm settings are not erased even when you remove the battery.
- When replacing the battery, the clock continues moving for about 3 minutes after you remove the battery.

When to charge/replace the battery

The battery indicator on the display shows the battery condition.

Battery remain indication

 : Charge the rechargeable battery or replace the old battery with a new one.



 : “Low Battery” appears and the IC recorder will stop operation.

Step 3: Turning the IC Recorder On

Turning the power on

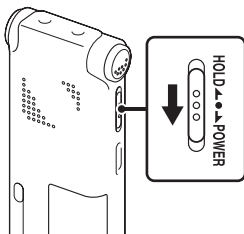

- When you leave the IC recorder without attempting an operation for a certain length of time, the auto power off function will take effect. (The length of time before auto power off is set to “10min” when you purchase the IC recorder.) You can select the length of time before auto power off in the menu (page 81).

Slide the HOLD/POWER switch in the direction of “POWER” for more than 1 second. The IC recorder is turned on, and “Accessing...” is displayed.

Turning the power off

Slide the HOLD/POWER switch in the direction of “POWER” for more than 2 seconds, and “Power Off” is displayed.

Tips

- When you are not going to use the IC recorder for a long time, we recommend to turn off the IC recorder.

Step 4: Setting the Clock

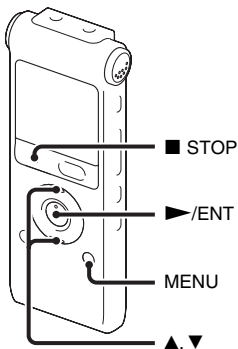

You need to set the clock to use the alarm function or record the date and time. Clock setting display appears when you insert battery for the first time, or when you insert a battery after the IC recorder has been without battery for more than 3 minutes, “Set Date&Time” appears, and then the year section flashes in the display window.

Setting the clock after recharging the battery

- 1 Press ▲ or ▼ on the control button to set the year, month, day, hour, and minute in sequence, and then press ►/ENT.

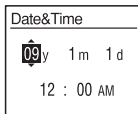

- 2 Press ■ STOP to return to the stop mode display.

Setting the clock using the menu

While the IC recorder is in the stop mode, you can set the clock using the menu.

- 1 Select “Date&Time” in the menu.
 - ① Press MENU to enter the menu mode.

The menu mode window will be displayed.

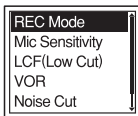

- Press ▲ or ▼ on the control button to select "Detail Menu," and then press ►/ENT.
- Press ▲ or ▼ on the control button to select "Date&Time," and then press ►/ENT.

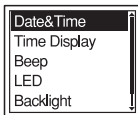

- Press ▲ or ▼ on the control button to select "09y1m1d," and then press ►/ENT.

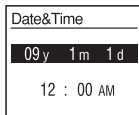

- Press ▲ or ▼ on the control button to set the year, month, day, hour, and minute in sequence, and then press ►/ENT.

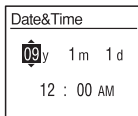

- Press ■ STOP to return to the stop mode display.

Note

If you do not press ►/ENT within 1 minute of entering the clock setting data, the clock setting mode is cancelled and the window will return to the display of the stop mode.

To display the current date and time

Press ■ STOP to display the current date and time.

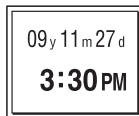

Step 5: Setting the Language to Be Used in the Display Window

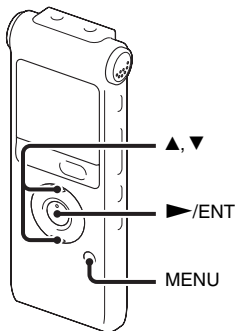

You can select the language to be used for messages, menus, folder names, file names, etc. from 3 languages.

- 1 Press MENU to enter the menu mode. The menu mode window will be displayed.

- 2 Press ▲ or ▼ on the control button to select “Detail Menu,” and then press ►/ENT.

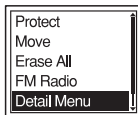

- 3 Press ▲ or ▼ on the control button to select “Language,” and then press ►/ENT.

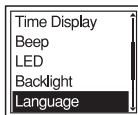

- 4 Press ▲ or ▼ on the control button to select the language that you want to use, and then press ►/ENT.

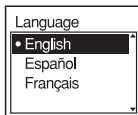

You can select the following languages.

English, Español (Spanish), Français

(French)

Preventing Accidental Operation (HOLD)

Locking the buttons

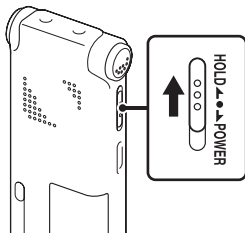

Slide the HOLD/POWER switch in the direction of “HOLD.”
 “HOLD” will appear indicating for approx. 3 seconds that all the functions of the buttons are locked.

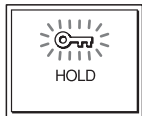

Unlocking the buttons

Slide the HOLD/POWER switch towards the center so that all buttons will be unlocked.

Note

When the HOLD function is activated during recording, all the functions of the buttons are locked to prevent accidental operation. To stop recording, cancel the HOLD function first.

Tip

Even if the HOLD function is activated, you can stop the alarm playback by pressing any button. (You cannot stop normal playback.)

Recording



Note

- Before making a recording, exit HOLD mode and turn on the power.

Selecting a folder

- 1 Press  to display the folder selection window.



- 2 Press  or  on the control button to select the folder in which you want to record messages ( FOLDER01-10).

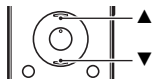

There are 10 folders already available when you purchase the IC recorder.

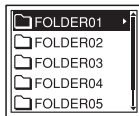

- 3 Press /ENT.

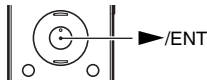

Starting to record

- 1 Press ● REC/PAUSE in the stop mode.
The operation indicator lights in red.
You do not need to press and hold ● REC/PAUSE while recording.
The new message will be automatically recorded after the last recorded message.

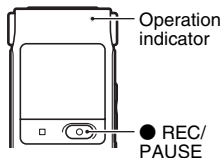

- 2 Turn the built-in microphones in the direction of the source to be recorded.

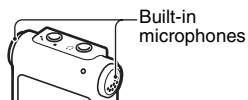

To stop recording

- 1 Press ■ STOP.
“Accessing...” appears on the display and the IC recorder stops at the beginning of the current recording.



Note while accessing

The IC recorder is recording data and saving it in memory when “Accessing...” appears on the display. While the IC recorder is accessing data, do not remove the battery or connect or disconnect the USB AC adaptor (not supplied). Doing so may damage the data.

Other operations

| | |
|--|--|
| pause recording* | Press ● REC/PAUSE. During recording pause, the operation indicator flashes in red and “● II” flashes in the display window. |
| release pause and resume recording | Press ● REC/PAUSE again. Recording resumes from that point. (To stop recording after pausing recording, press ■ STOP.) |
| review the current recording instantly | Press ►/ENT. Recording stops and playback starts from the beginning of the message just recorded. |
| review during recording | Press and hold ◀◀ on the control button during recording or recording pause. Recording stops and you can search backwards while listening to fast playback sound. After you release ◀◀ on the control button, playback starts from that point. |

* 1 hour after you pause recording, recording pause is automatically released and the IC recorder enters the stop mode.

Tips

- Messages recorded using this IC recorder will be recorded as MP3 files.
- You can record up to 99 messages in each folder.
- Before you start recording, we recommend you make a trial recording first, or monitor the recording (page 34).

Notes

- Noise may be recorded if an object, such as your finger, etc., accidentally rubs or scratches the IC recorder during recording.
- Before making a recording, be sure to check the battery indicator (page 11).

Listening

■ Note

- Before playback starts, exit HOLD mode and turn on the power.

To start playback

1 Press .

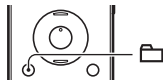

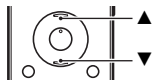

2 Press  or  on the control button to select the folder.



3 Press  on the control button.



4 Press  or  on the control button to select the message you want to play.

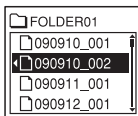
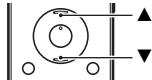

5 Press ►/ENT.

Playback will start soon, and the operation indicator will light in green. (When “LED” is set to “OFF” in the menu (page 80), the operation indicator does not light.)

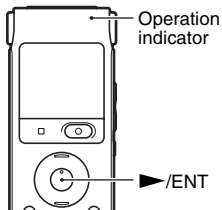

6 Press VOL +/- to adjust the volume.

To stop playback**1** Press ■ STOP.

Other operations

stop at the current position (Playback Pause function) Press ►/ENT. To resume playback from that point, press ►/ENT again.

go back to the beginning of the current message Press ◀◀ on the control button once.*

go back to previous messages Press ◀◀ on the control button repeatedly. (During the stop mode, keep the button pressed to go back the messages continuously.)

skip to the next message Press ▶▶ on the control button once.*

skip to the succeeding messages Press ▶▶ on the control button repeatedly. (During the stop mode, keep the button pressed to skip the messages continuously.)

* These operations are for when “Easy Search” is set to “OFF” (page 76).

Display when playing back the messages

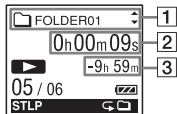

1 File information

Press ▲ or ▼ on the control button to check the file information during playback. A message recorded using the IC recorder is displayed as follows.

📁: Folder name: FOLDER01-FOLDER10

🎵: Title: Date_file number (e.g. 090101_001 or FM_090101_001)

👤: Artist name: My Recording

📄: File name: Date_file number (e.g. 090101_001 or FM_090101_001)

You can change the folder name, title, artist name, and/or file name using a computer.

2 Counter information

You can select the display mode in the menu (page 77).

Elapsed time: Elapsed playback time of one message

Remaining time: The remaining time of the message

Recording date: Date recorded

Recording time: Time recorded

3 Remaining recording time

Displays the remaining recording time in hours, minutes, and seconds.

If there is more than 10 hours time remaining, the time is displayed in hours.

If there is more than 10 minutes and less than 10 hours time remaining, the time is displayed in hours and minutes.

If there is less than 10 minutes time remaining, the time is displayed in minutes and seconds.

Erasing

■ Notes

- Once a recording has been erased, you cannot retrieve it.
- Before erasing a message, exit HOLD mode and turn on the power.

Selecting a message and erasing it

1 Select the message you want to erase when the IC recorder is in the stop or playback mode.

2 Press ERASE.
“Erase?” appears with the message title.

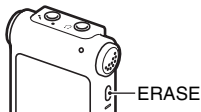

3 Press ▲ or ▼ on the control button to select “Execute.”

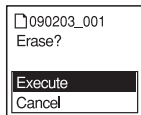

4 Press ►/ENT.

“Erasing...” appears in the display window and the selected message will be erased.

When a message is erased, the remaining messages will advance and be renumbered so that there will be no space between messages.

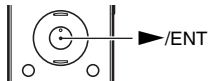

To cancel erasing

- 1** Select “Cancel” in step 3 of “Selecting a message and erasing it,” and then press ►/ENT.

**Erasing another message**

Proceed with the same steps again from the beginning.

Erasing a part of one message

Divide the message into two messages first (page 58), and then proceed with the same steps from the beginning.

Changing the Recording Settings

Selecting the recording mode

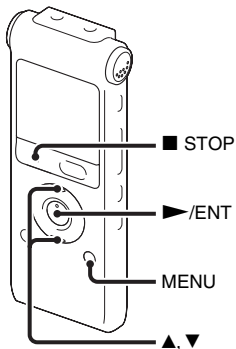

You can select the recording mode in the menu when the IC recorder is in the stop mode or the FM radio mode.

- 1 Press **MENU** to enter the menu mode.
The menu mode window will be displayed.

- 2 Press **▲** or **▼** on the control button to select “REC Mode,” and then press **▶/ENT**.

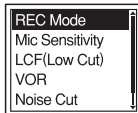

- 3 Press **▲** or **▼** on the control button to select “ST,” “STSP,” “STLP,” “SP,” or “LP,” and then press **▶/ENT**.

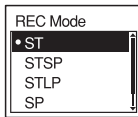

- 4 Press **■ STOP** to exit the menu mode.

| | |
|------|--|
| ST | High-quality stereo recording mode (44.1 kHz/192 kbps) You can record with stereo high-quality sound. |
| STSP | Standard play stereo recording mode (44.1 kHz/128 kbps) You can record with stereo sound. |
| STLP | Long play stereo recording mode (22.05 kHz/48 kbps) You can record for a longer time with stereo sound. |
| SP | Standard play monaural recording mode (44.1 kHz/32 kbps) You can record with standard quality sound. |
| LP | Long play monaural recording mode (11.025 kHz/8 kbps) You can record for a longer time with monaural sound. |

To record with better sound quality, select the ST or STSP mode.

The recording mode is set to “ST” when you purchase the IC recorder.

Note

You cannot set the recording mode while recording.

Setting the microphone sensitivity

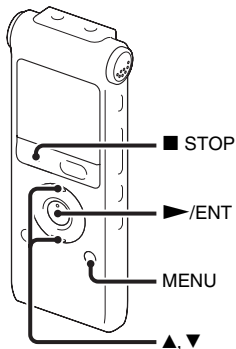





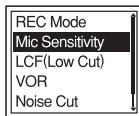

You can set the microphone sensitivity in the menu when the IC recorder is stopped or is recording.

1 Press MENU to enter the menu mode.

The menu mode window will be displayed.

- 2 Press ▲ or ▼ on the control button to select “Mic Sensitivity,” and then press ►/ENT.





- 3 Press ▲ or ▼ on the control button to select “S-High ,” “High A screenshot of a menu titled "Mic Sensitivity". The menu items are "S-High ", "High ", and "Low ". "S-High" is highlighted with a black bar.

- 4 Press ■ STOP to exit the menu mode.

S-High  To record a sound far away from the IC recorder or a low sound, such as a recording made in a spacious room.

High  To record the sound of a normal conversation or meeting, such as a recording made in a conference room or during interviews.

Low  To record dictation with a microphone in front of your mouth, a sound near the IC recorder, or a loud sound.

The microphone sensitivity is set to “High 

30^{GB}

Cutting out low frequency – the LCF function

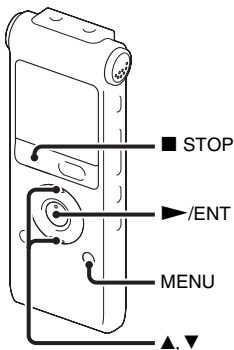

When you set the LCF (Low Cut Filter) function to “ON” in the stop or recording mode, you cut out a low frequency to reduce the roaring noise from wind, etc.; therefore you can record a message more clearly.

- 1 Press MENU to enter the menu mode.
The menu mode window will be displayed.

- 2 Press ▲ or ▼ on the control button to select “LCF(Low Cut),” and then press ►/ENT.

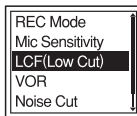

- 3 Press ▲ or ▼ on the control button to select “ON,” and then press ►/ENT.

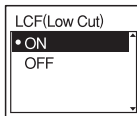

The LCF function is set to “OFF” when you purchase the IC recorder.

- 4 Press ■ STOP to exit the menu mode.

To cancel the LCF function

Set “LCF(Low Cut)” to “OFF” in step 3.

Starting to record automatically in response to sound – the VOR function

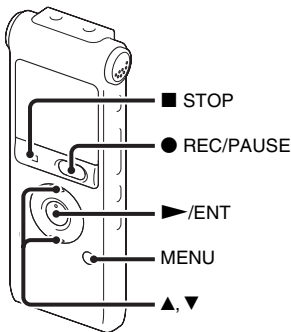

You can set the VOR (Voice Operated Recording) function to “ON” when the IC recorder is stopped or is recording, to make the IC recorder start recording when the IC recorder detects sound, and pause when no sound is heard, eliminating recording during soundless periods.

- 1 Press MENU to enter the menu mode.
The menu mode window will be displayed.

- 2 Press ▲ or ▼ on the control button to select “VOR,” and then press ►/ENT.

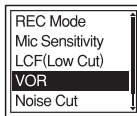

- 3 Press ▲ or ▼ on the control button to select “ON,” and then press ►/ENT.

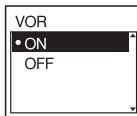

The VOR function is set to “OFF” when you purchase the IC recorder.

- 4 Press ■ STOP to exit the menu mode.
- 5 Press ● REC/PAUSE.
“REC” and “VOR” appear in the display window.

The recording pauses when no sound is detected and “VOR” and “● ||” flash. When the IC recorder detects sound again, the recording starts again.

To cancel the VOR function

Set “VOR” to “OFF” in step 3.

Note

The VOR function is affected by the sound around you. Set “Mic Sensitivity” in the menu according to the recording conditions. If recording is not satisfactory after you have changed the microphone sensitivity, or for an important recording, set “VOR” to “OFF” in the menu.

Operating during Recording

Monitoring the recording

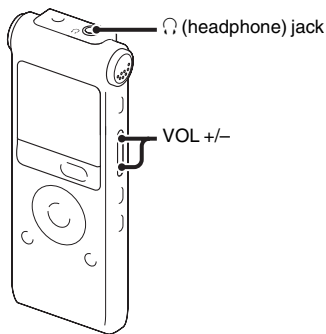

If you connect the supplied stereo headphones to the (headphone) jack before you start, you can monitor the recording. You can adjust the monitoring volume by pressing VOL +/-, but the recording level is fixed.

Dividing a message during recording

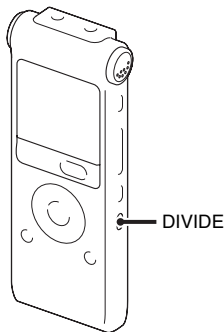

You can divide a message during recording so that the message is divided into two parts, and a new message number is added to the newer part of the divided message. Once a message is divided, you cannot re-combine the divided messages.

- 1 Press DIVIDE during recording.
“Dividing...” appears on the display and the new message number is added at the point you pressed the button. The message will be recorded as two messages, however recording continues without stopping.

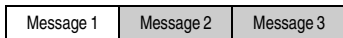

Message is divided.

Message 2 and Message 3 are recorded without stopping.

Tip

You can divide the currently recorded message during recording pause.

Note

When you divide a message into two, at the point of division, the end of the first message and the beginning of the second message may be interrupted.

Recording via Other Devices

Recording with an external microphone

Stereo microphone

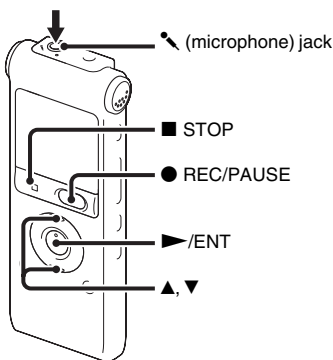

- 1 Connect an external microphone to the (microphone) jack when the IC recorder is in the stop mode.
“Select Input” appears in the display window.
If “Select Input” is not displayed, set it in the menu (page 82).

- 2 Press ▲ or ▼ on the control button to select “MIC IN,” and then press ►/ENT.

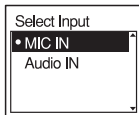

- 3 Press ■ STOP to exit the menu mode.
- 4 Press ● REC/PAUSE to start recording.

The built-in microphones are automatically cut off.

If the input level is not strong enough, adjust the microphone sensitivity on the IC recorder.

When a plug in power type microphone is connected, power is automatically supplied to the microphone from the IC recorder.

Recommended microphones

You can use the Sony ECM-CS10, ECM-CZ10, ECM-DS70P, ECM-DS30P electret condenser microphone (not supplied).

Recording sound from a telephone or a cell phone

You can use the ECM-TL1 headphone-type electret condenser microphone (not supplied) to record sound from a telephone or a cell phone.

For details on how to make the connection, refer to the operating instructions supplied with the ECM-TL1 microphone.

Notes

- After you have made the connection, check the sound quality of the conversation and the recording level before you start recording.
- If the beep of the telephone or a dial tone is recorded, the conversation may be recorded with lower level of sound. In this case, start recording after the conversation has started.
- The VOR function may not work, depending on the kind of telephone or the line condition.
- We assume no responsibility whatsoever for any inconvenience, even if you cannot record a conversation using the IC recorder.

Recording from other equipment

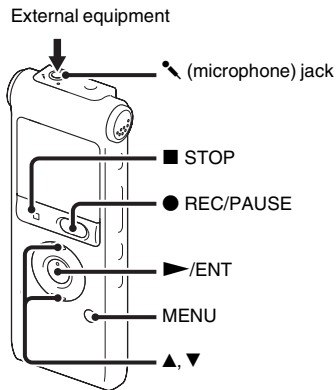

You can make music files without using the computer by recording the sound from other equipment connected to the IC recorder.

Tips

- Before you start recording, we recommend you make a trial recording first.
- If the input level is not strong enough, connect the headphone jack (minijack, stereo) of other equipment to the

 (microphone) jack of the IC recorder and adjust the volume level on the piece of equipment connected to the IC recorder.

To record using the synchronized recording function

- 1** Press MENU to enter the menu mode.

The menu mode window will be displayed.

- 2** Press ▲ or ▼ on the control button to select “Detail Menu,” and then press ►/ENT.

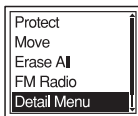

- 3** Press ▲ or ▼ on the control button to select “SYNC REC,” and then press ►/ENT.

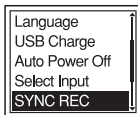

- 4** Press ▲ or ▼ on the control button to select “ON,” and then press ►/ENT.

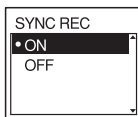

- 5** Press ■ STOP to exit the menu mode.

- 6** Connect other equipment to the IC recorder when the IC recorder is in the stop mode.

Connect the audio output connector (stereo mini-plug) of other equipment to the  (microphone) jack of the IC recorder using an audio connecting cable (page 41)*.

“Select Input” appears in the display window.

If “Select Input” is not displayed, set it in the menu (page 82).

- 7** Press ▲ or ▼ on the control button to select “Audio IN,” and then press ►/ENT.

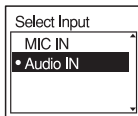

- 8** Press **■** STOP to exit the menu mode.
- 9** Press **●** REC/PAUSE to start recording. “**● II SYNC**” flashes and the IC recorder enters the recording pause mode.
- 10** Start playback on the piece of equipment connected to the IC recorder. “**REC SYNC**” appears on the display and synchronized recording starts.

The synchronized recording pauses when no sound is detected for more than 2 seconds, and “**● II SYNC**” flashes.

The IC recorder starts recording again as a new message when sound is detected.

I Notes

- During synchronized recording, you cannot divide a message (page 34) and you cannot pause recording (page 20).
- Depending on the piece of equipment connected to the IC recorder, the synchronized recording function may not operate properly due to a difference in the audio input level.

To record without using the synchronized recording function

- 1** Press MENU to enter the menu mode. The menu mode window will be displayed.
- 2** Press **▲** or **▼** on the control button to select “Detail Menu,” and then press **▶**/ENT.

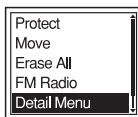

- 3** Press **▲** or **▼** on the control button to select “SYNC REC,” and then press **▶**/ENT.

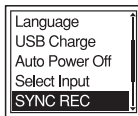

- 4** Press ▲ or ▼ on the control button to select “OFF,” and then press ►/ENT.

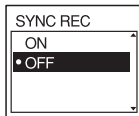

- 5** Press ■ STOP to exit the menu mode.

- 6** Connect other equipment to the IC recorder when the IC recorder is in the stop mode.

Connect the audio output connector (stereo mini-plug) of other equipment to the  (microphone) jack of the IC recorder using an audio connecting cable (page 41)*.

“Select Input” appears in the display window.

If “Select Input” is not displayed, set it in the menu (page 82).

- 7** Press ▲ or ▼ on the control button to select “Audio IN,” and then press ►/ENT.

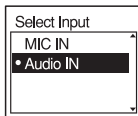

- 8** Press ■ STOP to exit the menu mode.

- 9** Press ● REC/PAUSE to start recording.

The built-in microphones are automatically cut off and the sound from the connected equipment is recorded.

- 10** Start playback on the piece of equipment connected to the IC recorder.

*** Optional audio connecting cables
(not supplied)**

| | To the IC recorder | To the other equipment |
|---------|--|--|
| RK-G139 | Stereo mini-plug (without resistor) | Mini-plug (monaural) (without resistor) |
| RK-G136 | Stereo mini-plug (without resistor) | Stereo mini-plug (without resistor) |



Note

When recording from other equipment, the microphone sensitivity cannot be adjusted.





Changing the Playback Method

Convenient playback methods



Listening with better sound quality

- To listen with the headphones:
Connect the supplied headphones to the  (headphone) jack. The built-in speaker will be automatically disconnected.
- To listen from an external speaker:
Connect an active or passive speaker (not supplied) to the  (headphone) jack.

Quickly locating the point you wish to start playback (Easy Search)

When “Easy Search” is set to “ON” (page 76) in the menu, you can quickly locate the point at which you wish to start playback by pressing  or  on the control button repeatedly during playback. You can go back approx. 3 seconds by pressing  on the control button once, or advance approx. 10 seconds by pressing  on the control button once. This function is useful for locating a desired point in a long recording.

Searching forward/backward during playback (Cue/Review)

- To search forward (Cue):
Press and hold  on the control button during playback and release it at the point you wish to resume playback.
- To search backward (Review):
Press and hold  on the control button during playback and release it at the point you wish to resume playback.

The IC recorder searches at slow speed with playback sound. This is useful to check one word forward or back. Then, if you press and hold the button, the IC recorder starts to search at higher speed.

When messages are played back to the end of the last message

- When you play back or fast play back to the end of the last message, “MESSAGE END” lights up for approx. 5 seconds.
- When “MESSAGE END” and the operation indicator go off, the IC recorder will stop at the beginning of the last message.
- If you press and hold  on the control button while “MESSAGE END” is lit, the messages are played back rapidly, and

normal playback will start at the point you release the button.

- If the last message is long and you wish to start playback at a later part of the message, press and hold ►► on the control button to go to the end of the message, and then press ◀◀ on the control button while “MESSAGE END” is lit to go back to the desired point.
- For messages other than the last one, go to the beginning of the next message and play backward to the desired point.

Playing back a message repeatedly

During playback, press and hold ►/ENT until “1” appears. The selected message will be played back repeatedly.

To resume normal playback, press ►/ENT again.

Adjusting the playback speed – the DPC function

Rear

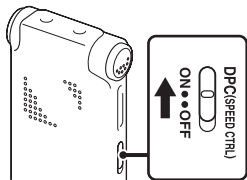

Front



When you set the DPC (Digital Pitch Control) function to “ON,” you can adjust the playback speed between +100% and -50% of normal speed in the menu. The message is played back in natural tones thanks to the digital processing function.

1 Slide the DPC (SPEED CTRL) switch to “ON.”

2 If you wish to increase the playback speed, press ▲ on the control button when the IC recorder is in the playback mode.

Every time the button is pressed, you can increase the speed by 5% for + from -50% to 0%, and 10% for + between 0% and 100%.

3 If you wish to decrease the playback speed, press ▼ on the control button when the IC recorder is in the playback mode.

Every time the button is pressed, you can decrease the speed by 5% for - from 0% to -50%, and 10% for - between 100% and 0%.

To resume normal playback

Slide the DPC (SPEED CTRL) switch to “OFF.”

Notes

- You can only adjust the playback speed between 0% and -50% when messages are recorded as WMA/AAC-LC files.
- When any one message is played back repeatedly by pressing and holding ►/ENT

during playback (page 43), or when the specified A-B section is played back repeatedly (page 46), you cannot adjust the playback speed.

Changing the Playback Settings

Selecting the playback mode

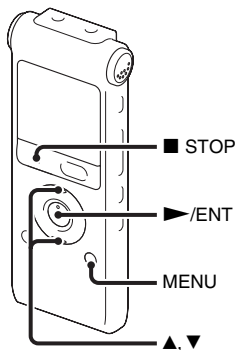

You can select the playback mode in the menu.

- 1 Press **MENU** to enter the menu mode when the IC recorder is in the stop or playback mode.

The menu mode window will be displayed.



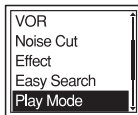

- 2 Press **▲** or **▼** on the control button to select "Play Mode," and then press **▶/ENT**.

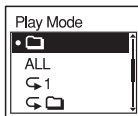



- 3 Press **▲** or **▼** on the control button to select "1," "📁," "ALL," "⏪ 1," "⏪ 📁," or "⏪ ALL," and then press **▶/ENT**.





- 4 Press **■ STOP** to exit the menu mode.

| | |
|--|--|
| 1 | A message is played back. |
|  | Messages in one folder are played back continuously. |
| ALL | All the messages are played back continuously. |
|  1 | One message is played back repeatedly. |
|   | Messages in one folder are played back repeatedly. |
|  ALL | All the messages are played back repeatedly. |

Playing back a specified section repeatedly – A-B Repeat

- 1 During playback, press  (repeat) A-B to specify the starting point A.
“A-B B?” is displayed.
- 2 Press  (repeat) A-B again to specify the finishing point B.
“ A-B” is displayed and the specified section is played back repeatedly.

To resume normal playback:
Press /ENT.

To stop A-B Repeat playback:
Press  STOP.

To change the segment specified for A-B Repeat playback:
During A-B Repeat playback, press  (repeat) A-B again to specify a new starting point A. Then specify a new finishing point B, as in step 2.

Note

You cannot specify the finishing point B before the starting point A that has been set.

Making the human voice clearer – the noise cut function

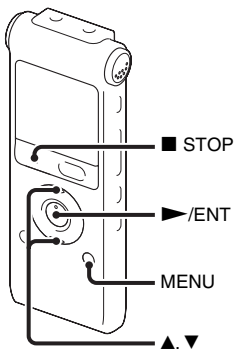

When the noise cut function is set to “ON” in the menu, the distortion of very low and high frequencies which are outside the human voice range is reduced, therefore you can hear the human voice more clearly.

1 Press MENU to enter the menu mode when the IC recorder is in the stop or playback mode.

The menu mode window will be displayed.

2 Press ▲ or ▼ on the control button to select “Noise Cut,” and then press ►/ENT.

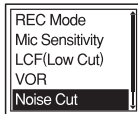

3 Press ▲ or ▼ on the control button to select “ON,” and then press ►/ENT.

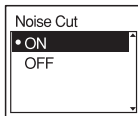

4 Press ■ STOP to exit the menu mode.

■ Notes

- The effect of the noise cut function may be different depending on the condition of the recorded voice.
- When you are using the built-in speaker or listening to the FM radio, the noise cut function does not work.

To cancel the noise cut function

Set “Noise Cut” to “OFF” in step 3.

Selecting the sound effect

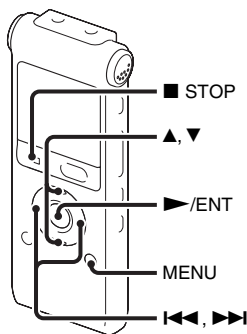

You can set the effect you want for the playback in the menu.

- 1 Press MENU to enter the menu mode when the IC recorder is in the stop or playback mode.

The menu mode window will be displayed.

- 2 Press ▲ or ▼ on the control button to select “Effect,” and then press ►/ENT.

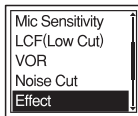

- 3 Press ▲ or ▼ on the control button to select effect you want for the playback, and then press ►/ENT.

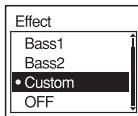

- 4 If you select “Custom,” you can press ▲ or ▼ on the control button to adjust the sound level for each band.

Press ◀◀ or ▶▶ on the control button to move to the band on the left or right.

- 5 Press ►/ENT to close the custom setting window.

- 6 Press ■ STOP to exit the menu mode.

| | |
|-----|---|
| Pop | Stresses middle ranges, ideal for vocals. |
|-----|---|

| | |
|------|--|
| Rock | Emphasizes high and low ranges for a powerful sound. |
|------|--|

| | |
|------|--|
| Jazz | Emphasizes high ranges for lively sound. |
|------|--|

| | |
|-------|----------------------------|
| Bass1 | Emphasizes the bass sound. |
|-------|----------------------------|

| | |
|-------|--------------------------------------|
| Bass2 | Emphasizes the bass sound even more. |
|-------|--------------------------------------|

| | |
|--------|---|
| Custom | You can design your own custom sound level for 5 bands of EQ. |
|--------|---|

| | |
|-----|------------------------------------|
| OFF | The Effect function does not work. |
|-----|------------------------------------|

■ Notes

- When you are using the built-in speaker or listening to the FM radio, this setting is invalid.
- When the noise cut function is set to “ON” in the menu, this setting is invalid.

Playing Back a Message at a Desired Time with an Alarm

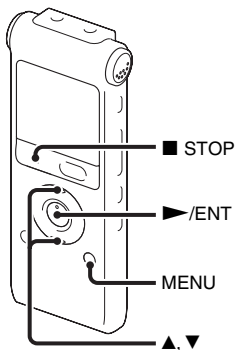

You can sound an alarm and start playback of a selected message at a desired time. You can have the message played back on a specified date, once every week, or at the same time every day. You can set a maximum of 30 alarms.

- 1 Select the message you want to play back with an alarm.

2 Enter the alarm setting mode.

- ① Press MENU to enter the menu mode when the IC recorder is in the stop mode. The menu mode window will be displayed.
- ② Press ▲ or ▼ on the control button to select “Alarm,” and then press ►/ENT.

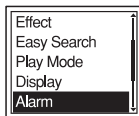

- ③ Press ▲ or ▼ on the control button to select “New,” and then press ►/ENT.

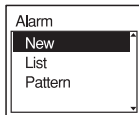

- 3** Set the alarm date and time.
- 1 Press ▲ or ▼ on the control button to select “Date,” a day of the week, or “Daily,” and then press ►/ENT.
 - 2 **When you select “Date”:**
Set the year, month, day, hour, and minute in sequence, as described in “Step 4: Setting the Clock” on page 13.
“Executing...,” then your settings are displayed.
When you select a day of the week or “Daily”:
Press ▲ or ▼ on the control button to set the hour, and then press ►/ENT, press ▲ or ▼ on the control button to set the minute, and then press ►/ENT.

- 4** Press ■ STOP to exit the menu mode.
The setting process is finished and “(●)” (alarm indicator) appears in the display window.

To change the alarm setting

- 1 Select “Alarm” - “List” in the menu, then press ►/ENT.
The alarm list is displayed.

- 2 Press ▲ or ▼ on the control button to select the item you want to change, then press ►/ENT.

- 3 Press ▲ or ▼ on the control button to select “Edit,” then press ►/ENT.

- 4 Select “Date,” a day of the week, or “Daily,” then press ►/ENT.

- 5 Set the date and time and press ►/ENT.
“Executing...,” then your settings are displayed.

- 6 Press ■ STOP to exit the menu mode.

To cancel the alarm setting

Follow steps 1 and 2 of “To change the alarm setting.” In step 3, select “Cancel” and press ►/ENT. “Cancel Alarm?” is displayed. Press ▲ or ▼ on the control button to select “Execute,” then press ►/ENT. The alarm will be cancelled and the alarm indicator will disappear from the display window.

To set the alarm pattern

- 1 Select “Alarm” - “Pattern” in the menu, then press ►/ENT.

2 Press ▲ or ▼ on the control button to select “Beep&Play,” “Beep” or “Play,” then press ►/ENT.

3 Press ■ STOP to exit the menu mode.

When the set date and time comes

At the set time, “Alarm” is displayed in the display window and the alarm and the selected message will be played back using the selected alarm pattern.

When the playback ends, the IC recorder will stop automatically. (When the alarm pattern is set to “Beep&Play” or “Play,” the IC recorder will stop at the beginning of the selected message.)

To listen to the same message again

Press ►/ENT, and the same message will be played back from the beginning.

To stop the alarm playback

Press any button other than VOL +/- while the alarm sound is heard. If the HOLD function is activated, you can stop the alarm playback by pressing any button.

■ Notes

- You can set only one alarm each one message.

- When the clock has not been set or no messages are recorded, you cannot set the alarm.
- The alarm sounds even if you set “Beep” to “OFF” in the menu (page 80).
- If the alarm time comes during recording, the alarm will sound after the recording is finished. “(●)” will flash when the alarm time comes.
- If the alarm time comes while you are updating data, the alarm will be cancelled automatically.
- If more than one alarm time comes, only the first message will be played back with an alarm.
- Once the alarm is set, the alarm will not be cancelled, even after the message is played back.
- If the alarm time comes while another message is being played back with an alarm, the playback stops and the new message will be played back.
- If you divide a message you have set an alarm for, the alarm setting remains on only the first part of the divided message.
- If you delete a message on which you have set an alarm, that alarm will be also cancelled.

Playback via Other Devices

Recording with other equipment

Tape recorder, etc.

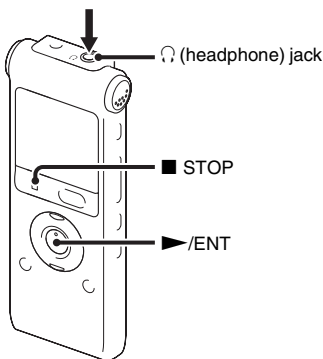

You can record the sound of the IC recorder with other equipment.

Before you start recording, we recommend you to make trial recording first.

- 1 Connect the (headphone) jack of the IC recorder to the audio input connector

(stereo minijack) of other equipment using an audio connecting cable*.

- 2 Press ►/ENT to start playback and at the same time set the connected equipment to the recording mode. A message from the IC recorder will be recorded on the piece of equipment connected.
- 3 Press ■ STOP on the IC recorder and the connected equipment at the same time to stop recording.

* Optional audio connecting cables (not supplied)

| | To the IC recorder | To the other equipment |
|---------|-------------------------------------|---|
| RK-G139 | Stereo mini-plug (without resistor) | Mini-plug (monaural) (without resistor) |
| RK-G136 | Stereo mini-plug (without resistor) | Stereo mini-plug (without resistor) |

Note

Your dealer may not handle some of the above listed optional accessories. Please ask the dealer for detailed information.

Erasing All Messages in a Folder

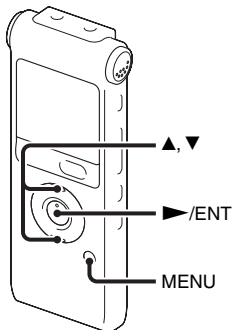

Note

If the selected folder contains a protected message, you cannot erase the message.

- 1 Select the folder containing the messages you want to erase when the IC recorder is in the stop mode.
- 2 Press MENU to enter the menu mode. The menu mode window will be displayed.

- 3 Press ▲ or ▼ on the control button to select “Erase All,” and then press ►/ENT.

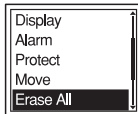

- 4 Press ▲ or ▼ on the control button to select “Execute,” and then press ►/ENT.

“Erasing...” appears in the display window and all messages in the selected folder will be erased.

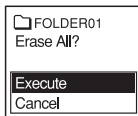

- 5 Press ■ STOP to exit the menu mode.



To cancel erasing

Select “Cancel” in step 4, and then press ►/ENT.

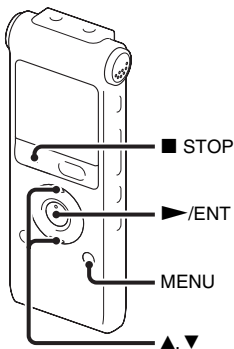
Moving a Message to a Different Folder





Notes



- When “” is displayed for the folder indicator, you cannot move a message (page 85).
- You cannot move a message to a  folder.

- 1 Select the message you want to move.
- 2 Press MENU to enter the menu mode when the IC recorder is in the stop or playback mode.

The menu mode window will be displayed.

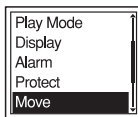
- 3 Press  or  on the control button to select “Move,” and then press /ENT. The message to be moved will be played back.



- 4 Press  or  on the control button to select the folder that you want to move the message into, and then press /ENT. “Executing...” is displayed and the message is moved to the last position in the destination folder.

When you move a message to another folder, the original message in the previous folder will be deleted.

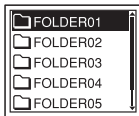

5 Press ■ STOP to exit the menu mode.

To cancel moving the message

Press ■ STOP before step 4.

Dividing a Message into Two

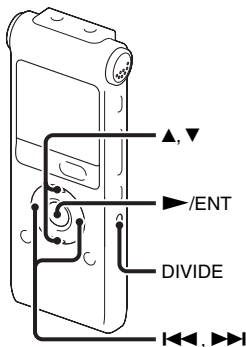

You can divide a message during playback, so that the message is divided into two parts and a new message number is added to the newer part of the divided message. By dividing a message, you can easily find the point from which you want to play back when you make a long recording such as at a meeting. You can divide a message until the total number of messages in the folder reaches the maximum number allowed.

1 Press **DIVIDE** while you are playing back the message you want to divide. “Divide?” appears with the message title.

2 Press **▲** or **▼** on the control button to select “Execute,” and then press **▶** / **ENT**.

“Dividing...” appears, a new number is added to the newer part of the divided message, and the message numbers of the following messages will be incremented by one.

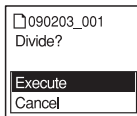

| Message 1 | Message 2 | Message 3 | |
|-----------|------------------------------|-----------|-----------|
| | ↓ ▲ A Message is divided. | | |
| Message 1 | Message 2 | Message 3 | Message 4 |

The message numbers are incremented.

■ Notes

- You need a certain amount of free space in the memory to divide a message.
- When you divide a message with a title and artist name, the newer part has the same title, artist name, and file name.
- You cannot divide a message other than the one recorded using the IC recorder (MP3/WMA/AAC-LC file transferred from a computer).
- Once a message is divided, you cannot combine divided messages using the IC recorder.
- If you divide a message with an alarm setting, the same alarm setting remains only with the former message divided.
- You may not be able to divide a message at the beginning or at the end of the message because of system limitations.

To play the divided message

Press **◀◀** or **▶▶** on the control button to display the message number, as the divided messages now each have message numbers.

Tuning in an FM Radio Station

(for ICD-UX200F/UX300F only)

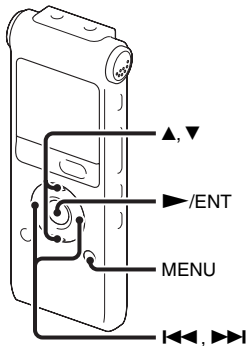

The headphone cord is an FM antenna, therefore, connect the headphone when listening to the radio.

Note

During FM reception you cannot charge the battery.

1 Press MENU to enter the menu mode. The menu mode window will be displayed.

2 Press ▲ or ▼ on the control button to select “FM Radio,” and then press ►/ENT.

The IC recorder enters the FM radio mode.

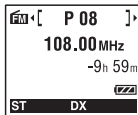

3 Press ▲ or ▼ on the control button to select frequency.

- 4 Press ◀◀ or ▶▶ on the control button repeatedly to tune in a station or press and hold ◀◀ or ▶▶ on the control button until the frequency digits begin to change on the display.

The IC recorder automatically scans the radio frequencies and stops when it finds a clear station.

If you cannot tune in a station, press ◀◀ or ▶▶ on the control button repeatedly to change the frequency step by step.

Display when listening to the FM radio

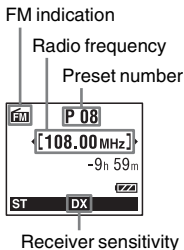

Switching the FM radio output between speaker and headphones

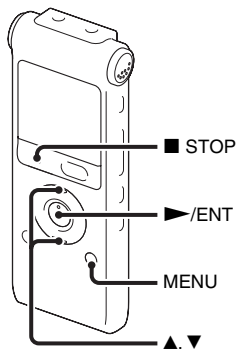

During FM reception or FM recording, you can switch between the sound from the speaker and the sound from the headphones using the menu.

- 1 During FM reception or FM recording, press MENU to enter the menu mode when listening to the FM radio. The menu mode window will be displayed.

- 2** Press ▲ or ▼ on the control button to select “Audio Output,” and then press ►/ENT.

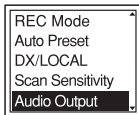

- 3** Press ▲ or ▼ on the control button to select “Headphones” or “Speaker,” and then press ►/ENT.

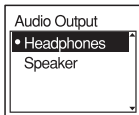

The FM radio output is set to “Headphones” when you purchase the IC recorder.

- 4** Press ■ STOP to exit the menu mode.

Switching the receiver sensitivity of the FM radio

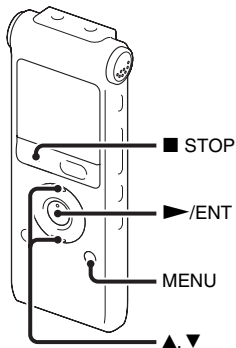

You can set the receiver sensitivity when listening to the FM radio.

- 1** Press MENU to enter the menu mode when listening to the FM radio.

The menu mode window will be displayed.

- 2 Press ▲ or ▼ on the control button to select “DX/LOCAL,” and then press ►/ENT.

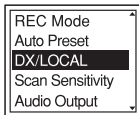

- 3 Press ▲ or ▼ on the control button to select “DX” or “LOCAL,” and then press ►/ENT.

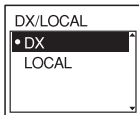

- 4 Press ■ STOP to exit the menu mode.

| | |
|-------|---|
| DX | Normally, select this setting. |
| LOCAL | When there is interference or collapsing caused by a intense electric field around the transmitting antenna of the broadcasting station, etc., select this setting. |

Note

Select “DX” when the IC recorder reception status is not good due to a weak signal.

Recording FM broadcasts

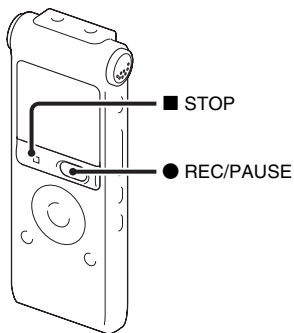

- 1 Tune in the station you want to record.
- 2 Press ● REC/PAUSE to start recording.
- 3 Press ■ STOP to stop recording.

Presetting FM Radio Stations Automatically

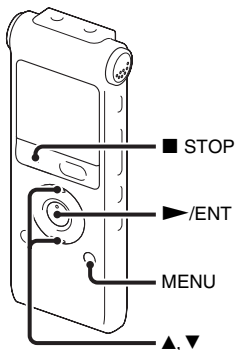

You can preset up to 30 FM radio stations automatically using the preset menu.

- 1 Press MENU to enter the menu mode when listening to the FM radio. The menu mode window will be displayed.

- 2 Press ▲ or ▼ on the control button to select “Auto Preset,” and then press ►/ENT.

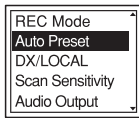

- 3 Press ▲ or ▼ on the control button to select “Execute,” and then press ►/ENT.

The IC recorder automatically scans for available radio frequencies and the stations will be stored in memory from the lower frequencies to the higher ones. While presetting FM radio stations automatically, the preset number ready to be assigned flashes.

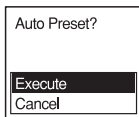

To stop the automatic presetting

Press ■ STOP. The preset numbers stored until you press the ■ STOP button remain in memory.

Switching the scanning sensitivity

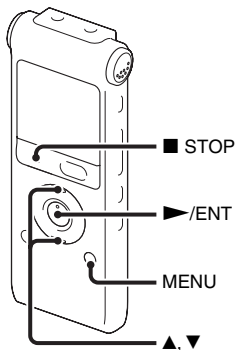

You can set the scanning sensitivity when presetting FM radio stations.

- 1** Press MENU to enter the menu mode when listening to the FM radio. The menu mode window will be displayed.

- 2** Press ▲ or ▼ on the control button to select “Scan Sensitivity,” and then press ►/ENT.

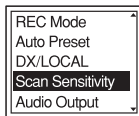

- 3** Press ▲ or ▼ on the control button to select “High(SCAN H)” or “Low(SCAN L),” and then press ►/ENT.

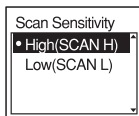

The scanning sensitivity is set to “High(SCAN H)” when you purchase the IC recorder.

- 4** Press ■ STOP to exit the menu mode.

Presetting FM Radio Stations Manually

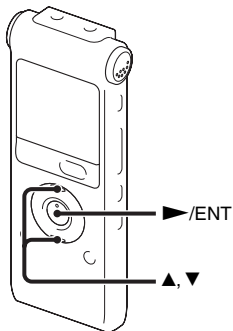

You can preset up to 30 FM radio stations in the IC recorder's memory.

- 1** Tune in the station you want to preset and store on the preset number.
When the station you want to tune in is not a preset station, "P - -" is displayed. In this case, you can register it with the new preset number.

- 2** Press ►/ENT.

The preset number, frequency and "Set?" will be displayed on the display.

- 3** Press ▲ or ▼ on the control button to select "Execute," and then press ►/ENT.

The station will be stored in memory.

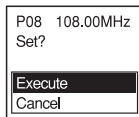

Listening to a Preset Radio Station

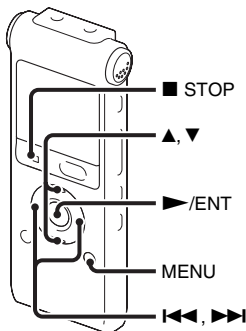

- 1 Press MENU to enter the menu mode when the IC recorder is stopped. The menu mode window will be displayed.
- 2 Press ▲ or ▼ on the control button to select “FM Radio,” and then press ►/ENT.

The IC recorder enters the FM radio mode.

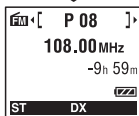
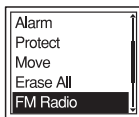

- 3 Press ▲ or ▼ on the control button to select preset number.
- 4 Press ◀◀ or ▶▶ on the control button repeatedly until the preset number you want is displayed. When you press and hold ◀◀ or ▶▶ on the control button, the preset numbers change rapidly.
- 5 Press ■ STOP to turn the FM radio off.

Erasing Preset FM Radio Stations

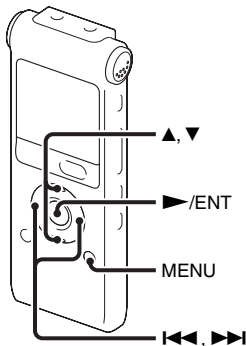

The display in the display window may be different from the actual one in some regions.

- 1** Press MENU to enter the menu mode.
The menu mode window will be displayed.
- 2** Press ▲ or ▼ on the control button to select “FM Radio,” and then press ►/ENT.

The IC recorder enters the FM radio mode.

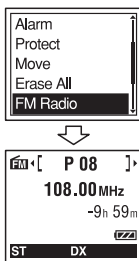

- 3** To tune in a station, press ◀◀ or ▶▶ on the control button repeatedly until the preset number you want to erase is displayed.
- 4** Press ►/ENT.
The preset number, frequency and “Erase?” will be displayed on the display.
- 5** Press ▲ or ▼ on the control button repeatedly to select “Execute,” and then press ►/ENT.

The preset number will be changed to
“P - -.”

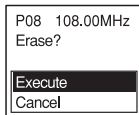

Making Settings for the Menu

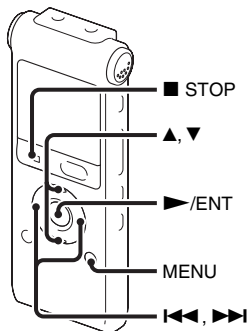

- 1 Press MENU to enter the menu mode.
The menu mode window will be displayed.

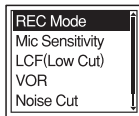

- 2 Press ▲ or ▼ on the control button to select the menu item for which you want to make setting, and then press ►/ENT.

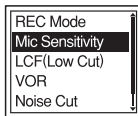

- 3 Press ▲ or ▼ on the control button to select the setting that you want to set, and then press ►/ENT.

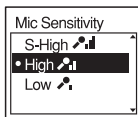

- 4 Press ■ STOP to exit the menu mode.

Note

If you do not press any button for 1 minute, the menu mode is automatically cancelled and the window will return to the normal display.









To return to the previous window

Press ◀◀ on the control button during menu mode.

To exit the menu mode

Press ■ STOP or MENU.



Menu Settings

| Menu items | Settings | Operation mode (○ : the setting can be made/ — : the setting cannot be made) | | | | |
|-----------------|--|--|---------------|----------------|---------------|-------------------------|
| | | Stop mode | Playback mode | Recording mode | FM radio mode | FM radio recording mode |
| REC Mode | ST, STSP, STLP, SP, LP | ○ | — | — | ○ | — |
| Mic Sensitivity | S-High  , High  , Low  | ○ | — | ○ | — | — |
| LCF(Low Cut) | ON, OFF | ○ | — | ○ | — | — |
| VOR | ON, OFF | ○ | — | ○ | — | — |
| Noise Cut | ON, OFF | ○ | ○ | — | — | — |
| Effect | Pop, Rock, Jazz, Bass1, Bass2, Custom, OFF | ○ | ○ | — | — | — |
| Easy Search | ON, OFF | ○ | ○ | — | — | — |
| Play Mode | 1,  , ALL,  1,   ,  ALL | ○ | ○ | — | — | — |
| Display | Elapsed Time, Remain Time, REC Date, REC Time | ○ | ○ | ○ | — | ○ |
| Alarm | New, List, Pattern | ○ | — | — | — | — |
| Protect | Execute, Cancel | ○ | — | — | — | — |
| Move | (Folder to be moved) | ○ | ○ | — | — | — |
| Erase All | Execute, Cancel | ○ | — | — | — | — |
| FM Radio* | | ○ | — | — | — | — |
| Auto Preset* | Execute, Cancel | — | — | — | ○ | — |
| DX/LOCAL* | DX, LOCAL | — | — | — | ○ | ○ |

* for ICD-UX200F/UX300F only



| Menu items | Settings | Operation mode (○ : the setting can be made/ — : the setting cannot be made) | | | | |
|-------------------|--|--|---------------|----------------|---------------|-------------------------|
| | | Stop mode | Playback mode | Recording mode | FM radio mode | FM radio recording mode |
| Scan Sensitivity* | High(SCAN H), Low(SCAN L) | — | — | — | ○ | — |
| Audio Output* | Headphones, Speaker | — | — | — | ○ | ○ |
| Detail Menu | | ○ | — | — | — | — |
| Date&Time | __y__m__d__ : __ | ○ | — | — | — | — |
| Time Display | 12-Hour, 24-Hour | ○ | — | — | — | — |
| Beep | ON, OFF | ○ | — | — | — | — |
| LED | ON, OFF | ○ | — | — | — | — |
| Backlight | ON, OFF | ○ | — | — | — | — |
| Language | English, Español (Spanish), Français (French) | ○ | — | — | — | — |
| USB Charge | ON, OFF | ○ | — | — | — | — |
| Auto Power Off | 5min, 10min, 30min, 60min | ○ | — | — | — | — |
| Select Input | MIC IN, Audio IN | ○ | — | — | — | — |
| SYNC REC | ON, OFF | ○ | — | — | — | — |
| Format | Execute, Cancel | ○ | — | — | — | — |

* for ICD-UX200F/UX300F only

| Menu items | Settings (*: Initial setting) | See page |
|------------------------|---|----------|
| REC Mode | Sets the recording mode. ST*: Stereo high-quality recording mode STSP: Stereo standard recording mode STL P: Stereo long play recording mode SP: Monaural standard play recording mode LP: Monaural long play recording mode | 28 |
| Mic Sensitivity | Sets the microphone sensitivity. S-High  : To record a sound far away from the IC recorder or a low sound, such as a recording made in a spacious room. High  *: To record the sound of a normal conversation or meeting, such as a recording made in a conference room or during interviews. Low  : To record dictation with a microphone in front of your mouth, a sound near the IC recorder, or a loud sound. | 29 |
| LCF(Low Cut) | Sets the LCF (Low Cut Filter) function to cut a low frequency to reduce the roaring noise from wind; therefore you can record a message more clearly. ON: The LCF function is activated. OFF*: The LCF function is cancelled. | 31 |

| Menu items | Settings (*: Initial setting) | See page |
|-------------------|--|-----------------|
| VOR | <p>Sets the VOR (Voice Operated Recording) function.</p> <p>ON: Recording starts when the IC recorder detects sound and pauses when no sound is heard, eliminating recording during soundless periods. The VOR function is activated when ● REC/PAUSE is pressed.</p> <p>OFF*: The VOR function does not work.</p> | 32 |
| Noise Cut | <p>Sets the noise cut function.</p> <p>ON: The distortion of very low and high frequencies which are outside the human voice range is reduced, therefore you can hear the human voice more clearly.</p> <p>OFF*: The noise cut function does not work.</p> | 47 |

| Menu items | Settings (*: Initial setting) | See page |
|-------------|--|----------|
| Effect | <p>Sets the effect you want for the playback in the menu.</p> <p>Pop: Stresses middle ranges, ideal for vocals.</p> <p>Rock: Emphasizes high and low ranges for a powerful sound.</p> <p>Jazz: Emphasizes high ranges for a lively sound.</p> <p>Bass1: The bass sound is emphasized.</p> <p>Bass2: The bass sound is emphasized even more.</p> <p>Custom: You can design your own custom sound level for 5 bands of EQ.</p> <p>OFF*: The Effect function does not work.</p> <p>Note</p> <p>When playing back messages using the built-in speaker, listening to the FM radio, or when the noise cut function is set to “ON” in the menu, the Effect function does not work.</p> | 48 |
| Easy Search | <p>Sets the easy search function.</p> <p>ON: You can go forward for about 10 seconds by pressing ▶▶ on the control button and go back for about 3 seconds by pressing ◀◀ on the control button. This function is useful when attempting to locate desired point in a long recording.</p> <p>OFF*: The easy search function does not work. When you press ◀◀ or ▶▶ on the control button, a message will be moved forward or backward.</p> | 42 |

| Menu items | Settings (*: Initial setting) | See page |
|------------------|---|----------|
| Play Mode | Sets the playback mode. 1: A message is played back.  *: Messages in one folder are played back continuously. ALL: All the messages are played back continuously. ↶ 1: One message is played back repeatedly. ↶  : Messages in one folder are played back repeatedly. ↶ ALL: All the messages are played back repeatedly. | 45 |
| Display | Changes the display mode. Elapsed Time*: Elapsed playback time of one message Remain Time: During stop or playback, the remaining time of the message During recording, the available recording time REC Date: Date recorded REC Time: Time recorded | — |

| Menu items | Settings (*: Initial setting) | See page |
|-------------------|--|-----------------|
| Alarm | <p>Sets the alarm.</p> <p>New*: To set the alarm, select “New” and set the date, time or day of the week or choose daily for playback.</p> <p>List: A list of dates or the days of the week, and times at which the alarm has already been set will be displayed. Edit: You can change the selected date or day of the week and time. Cancel: You can cancel the alarm setting on the selected date or on a day of the week.</p> <p>Pattern: Sets the alarm sound pattern for all alarm settings. Beep&Play*: The selected message is played back after the alarm sounds. Beep: Only the alarm sounds. Play: Only the selected message is played back.</p> | 50 |
| Protect | <p>Protect the selected message to prevent the message from being erased, divided, or being moved.</p> <p>Execute: Protect the selected message. If you specify a message that has already been protected, cancel the protection.</p> <p>Cancel*: “Set Protection?” or “Erase Protection?” is not executed.</p> | – |
| Move | <p>The selected message will be moved to the selected folder.</p> <p>Before attempting to move a message, select the message to be moved, and then go to the menu window.</p> | 56 |
| Erase All | <p>All messages in the selected folder will be erased.</p> <p>Press  to return to the folder window before erasing the messages and select a folder from which all messages are to be erased, and then go to the menu window and select “Execute.”</p> | 55 |

| Menu items | Settings (*: Initial setting) | See page |
|---|--|----------|
| FM Radio** | The IC recorder enters the FM radio mode. | 60 |
| Auto Preset** | Scans automatically for available frequencies. The stations will be stored in memory. Execute: The automatic presetting is activated. Cancel*: The automatic presetting is cancelled. | 64 |
| DX/LOCAL** | Sets the receiver sensitivity when listening to the FM radio. DX*: Normally, select this setting. LOCAL: When there is interference or collapsing caused by a intense electric field around the transmitting antenna of the broadcasting station, etc., select this setting. | 62 |
| Note | | |
| Select "DX" when the IC recorder reception status is not good due to a weak signal. | | |
| Scan Sensitivity** | Sets the scanning sensitivity when presetting FM radio stations. High(SCAN H)*: The scanning sensitivity is set to high. Low(SCAN L): The scanning sensitivity is set to low. | 65 |
| Audio Output** | During FM reception or FM recording, you can switch between the sound from the speaker and the sound from the headphones. Headphones*: The sound comes out from the headphones. Speaker: The sound comes out from the speaker(s). | 61 |

** for ICD-UX200F/UX300F only

| Menu items | Settings (*: Initial setting) | See page |
|----------------------|--|----------|
| Detail Menu | | |
| Date&Time | Sets the clock by setting year, month, day, hour, and minute in sequence. | 13 |
| Time Display | Sets the clock display. 12-Hour*: 12:00AM = midnight, 12:00PM = noon 24-Hour: 0:00 = midnight, 12:00 = noon | – |
| Beep | Sets whether a beep will be heard or not. ON*: A beep will sound to indicate that an operation has been accepted or an error has occurred. OFF: No beep sound will be heard. Note The alarm sounds even if you set “Beep” to “OFF” in the menu. | – |
| LED | Turns the operation indicator on or off during operation. ON*: During recording or playback, the operation indicator lights or flashes. OFF: The operation indicator does not light or flash, even during operation. Note When the IC recorder is connected to a computer, the operation indicator lights or flashes even if “LED” is set to “OFF.” | – |

| Menu items | Settings (*: Initial setting) | See page |
|---|--|----------|
| Backlight | Turns the backlight in the display window on or off. ON*: The backlight in the display window lights up for approx. 10 seconds. OFF: The backlight in the display window does not light, even during operation. | – |
| Language | Sets the language to be used for messages, menus, folder names, file names, etc. English, Español (Spanish), Français (French) | 15 |
| USB Charge | Sets whether battery will be charged using a USB connection or not. ON*: The battery will be charged. OFF: The battery will not be charged. | 9 |
| <p>Note</p> <p>If you use a USB AC adaptor (not supplied) to connect the IC recorder to the AC outlet, you can charge battery regardless this setting.</p> | | |
| Auto Power Off | If the IC recorder is on and left for the period you have set, the IC recorder turns off automatically. 5min: The IC recorder will be turned off after approx. 5 minutes. 10min*: The IC recorder will be turned off after approx. 10 minutes. 30min: The IC recorder will be turned off after approx. 30 minutes. 60min: The IC recorder will be turned off after approx. 60 minutes. | – |

| Menu items | Settings (*: Initial setting) | See page |
|--|---|----------|
| Select Input | <p>Selects the external input to be recorded that is connected to the  (microphone) jack.</p> <p>MIC IN*: Select when you record messages using an external microphone.</p> <p>Audio IN: Select when you record using other equipment.</p> | 36, 37 |
| SYNC REC | <p>When set to “ON,” the IC recorder enters the recording pause mode when no sound is detected for more than 2 seconds, and the IC recorder starts recording again as a new message when any sound is detected.</p> <p>ON: The synchronized recording function is activated.</p> <p>OFF*: The synchronized recording function is cancelled.</p> | 37 |
| Format | <p>Sets the formatting of the drive.</p> <p>Execute: “Formatting...” appears and the drive will be formatted.</p> <p>Cancel*: The drive will not be formatted.</p> | – |
| <p>■ Notes</p> <ul style="list-style-type: none"> • Use the IC recorder formatting function to format the memory. • When the memory is formatted, all the data stored in the IC recorder will be erased. Once the memory has been erased, you cannot retrieve the data that was erased. | | |

Using the IC Recorder with Your Computer

When the IC recorder is connected to your computer, the IC recorder is recognized by the computer, and you can transfer data between them.

Copying messages from the IC recorder to your computer to save them (page 87)

You can copy the messages recorded on the IC recorder to save them.

Copying music files from your computer to the IC recorder to play them back (page 88)

You can copy MP3/WMA/AAC-LC files saved on your computer by a simple drag & drop operation when you connect the IC recorder to your computer. You can also play back the copied files.

Using the IC recorder as USB memory – data storage function (page 91)

You can store image data or text data saved on the computer temporarily in the IC recorder.

System requirements for your computer

See “System requirements” on page 99.

Connecting the IC recorder to your computer

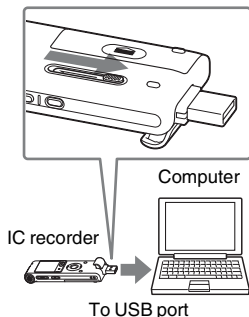

1 Slide the USB lever on the back of the IC recorder in the direction of the arrow, and insert the USB connector into the USB port of a running computer.

2 Make sure the IC recorder has been recognized properly.
On the Windows screen; open “My Computer” or “Computer,” and make sure that “IC RECORDER” has been recognized.

On the Macintosh screen; make sure that an “IC RECORDER” drive is displayed on the desktop.

The IC recorder is recognized by the computer as soon as the connection is made. While the IC recorder is connected to the computer, “Connecting” is displayed in the display window of the IC recorder.

If you cannot insert the USB connector of the IC recorder into the USB port of a computer directly, use the supplied USB connection support cable.

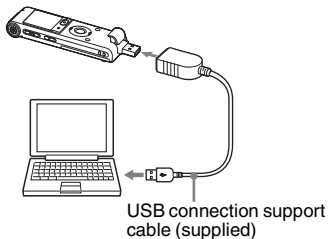

■ Notes

- If you connect more than two USB devices to your computer, normal operation will not be guaranteed.
- Use of this IC recorder with a USB hub or a USB connection support cable other than the supplied cable is not guaranteed.
- A malfunction may occur depending on the USB devices connected at the same time.

- Before connecting the IC recorder to the computer, make sure that the battery is inserted in the IC recorder.
- It is recommended that you disconnect the IC recorder from the computer when you are not using the IC recorder connected to the computer.

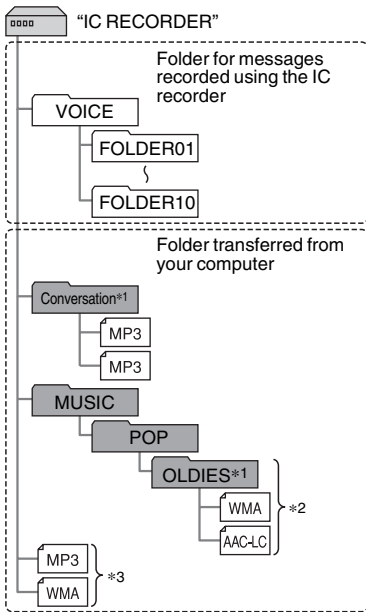

Construction of folders and files

If you connect the IC recorder to your computer, you can see the structure of folders and files on the computer screen.



The folders and files are displayed on the computer screen as shown.

The folder indicators in the display window of the IC recorder are as follows:

-  Folder for messages recorded using the IC recorder (They have been already made when you purchase the IC recorder.)
-  Folder transferred from a computer (They are displayed when music files have been transferred from a computer.)

Note

You can record messages in up to 10 folders (FOLDER01-10) using the IC recorder.

*1 The name of a folder in which music files are stored will be displayed on the IC recorder as it is, so it is convenient if you put an easy-to-remember name on the folder in advance.

Folders shown in the illustration are examples of folder names.

*2 The IC recorder can recognize up to 8 levels of folders copied to the IC recorder.

*3 If you copy music files separately, they are classified as being in “No Folder.”

Tips

- You can change the folder name, title, artist name, and/or file name using a computer.
- The title or artist name, etc., registered in the music files, can be displayed on the IC recorder. It is useful if you input the ID3 tag information using the software you use to make the music files on your computer.
- You can display the information in sequence by pressing ▲ or ▼ on the control button (page 89).

Notes

- You cannot copy 511 or more folders (except VOICE folders) or files to the root directory that is located immediately below “IC RECORDER” on the computer. This is due to system limitations (for ICD-UX200/UX200F only).
- If no title, or artist name has been registered “Unknown” will be displayed.

Copying Messages from the IC Recorder to Your Computer to Save Them

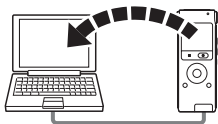

You can save messages or folders by copying them from the IC recorder to your computer.

- 1** Connect the IC recorder to your computer (page 84).
- 2** Copy messages or folders you want to save to your computer.
Drag and drop the messages or folders you want from “IC RECORDER” to the local disc on your computer.

 **To copy a message or a folder (Drag and drop)**

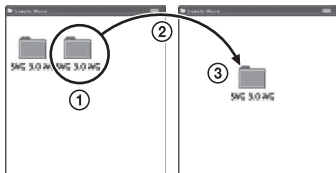

- 1** Click and hold,
- 2** drag,
- 3** and then drop.

- 3** Disconnect the IC recorder from your computer (page 94).

If you wish to create a CD, use a commercially available CD burner software application, a CD burner software application installed on your computer, or Windows Media Player.

For details about operations for the CD burner software application or Windows Media Player, refer to the operating instructions supplied with the software application, or contact the respective manufacturers.

Copying Music Files from Your Computer to the IC Recorder and Playing Them Back







You can copy music or other audio files (MP3/WMA/AAC-LC*) from your computer to the IC recorder by dragging and dropping them, and you can then play them back on the IC recorder.

You can make an MP3/WMA/AAC-LC file using a software application, etc., installed on your computer.

* For the file formats that can be played back using the IC recorder, see “Specifications” (page 99).

Copying a music file from your computer to the IC recorder (drag and drop)

- 1 Connect the IC recorder to your computer (page 84).
- 2 Copy the folder in which the music files are stored to the IC recorder.
On the Windows screen using Explorer, and on the Macintosh screen using Finder, drag and drop the folder onto the IC recorder.
The IC recorder can recognize up to 500 folders. You can copy up to 999 files to one folder and up to 5,000 files in total.
- 3 Disconnect the IC recorder from your computer (page 94).
- 4 Press .
- 5 Press  or  on the control button to select the folder () in which music files are stored, and then press  on the control button.

6 Press ▲ or ▼ on the control button to select the music file you want to play.

7 Press ►/ENT to start playback.

8 Press ■ STOP to stop playback.

The maximum playback time (tracks*), when playing music files using the IC recorder, is as follows.

| | 48 kbps | 128 kbps | 256 kbps |
|------------------|--------------------------------------|-----------------------------------|-----------------------------------|
| ICD-UX200/UX200F | 89 hr. 15 min. (1,338 tracks) | 33 hr. 25 min. (501 tracks) | 16 hr. 40 min. (250 tracks) |
| ICD-UX300/UX300F | 178 hr. 40 min. (2,680 tracks) | 67 hr. (1,005 tracks) | 33 hr. 25 min. (501 tracks) |

* In the case where MP3 files of 4 minutes each are transferred to the IC recorder.

Note

If you have transferred music files using your computer, those files may not be copied in order of transfer because of system limitations. If you copy music files from your computer to the IC recorder one by one, you can display and play back the music files in copied order.

Display when playing back a music file

Press ▲ or ▼ on the control button to check the music file information during playback.

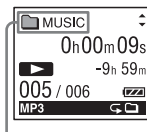

: Folder name

: Title

: Artist name

: File name

Tip

You can change the folder name, title, artist name, and/or file name using a computer.

Enjoying the music files more

Selecting the playback mode

You can select the playback mode, such as playback of one music file, continuous playback of music files in one folder, continuous playback of all music files, repeat playback of one music file, repeat playback of music files in one folder and repeat playback of all music files, in the menu.

For details, see page 45.

Adjusting the playback speed – the DPC (Digital Pitch Control) function

You can adjust a playback speed between +100% and -50% of normal speed in the menu. You can only adjust the playback speed between 0% and -50% when messages are recorded as WMA/AAC-LC files.

For details, see page 43.

Selecting a sound effect

You can cut the noise or set a effect such as “Pop,” “Rock,” “Jazz,” “Bass1,” “Bass2,” or “Custom” for the playback item in the menu.

For details, see page 47 and 48.

Playing back a message at a desired time with an alarm

You can start playback of a selected message at a desired time.

For details, see page 50.

Using the IC Recorder as USB Memory – Data Storage Function

When the IC recorder is connected to your computer directly or using a USB connection support cable, image data or text data on the computer, as well as messages or files recorded using the IC recorder can be temporarily stored in the IC recorder. Your computer must meet the specified system requirements to use the IC recorder as USB memory. For details on the system requirements, see page 99.

Using Voice Recognition Software

When voice recognition software (not supplied) is installed on your computer, you can transcribe a message into a text file.

Introducing the voice recognition software

Dragon NaturallySpeaking is a speech-recognition software application that allows you to recognize and transcribe your recorded voice in a message and convert it into a text file.

For details on Dragon NaturallySpeaking, refer to the operating instructions supplied with Dragon NaturallySpeaking.

For information on using Dragon NaturallySpeaking, refer to the documentation supplied with the software.

For the latest version and information on the availability of Dragon NaturallySpeaking in each region, please refer to the following home page: <http://www.nuance.com>

■ Notes

- You can use the transcribing feature only when you have installed Dragon NaturallySpeaking Select or Professional

Edition (not supplied) on your computer. To install Dragon NaturallySpeaking, your computer should meet the specified system requirements.

- You can transcribe the following messages saved in your IC recorder or on your computer:
 - ST, STSP, STLP or SP recording mode messages (MP3 files)
 - 44.1/16/11 kHz 16-bit WAV/AAC-LC files saved on your computer
- You cannot transcribe a message recording the voices of more than one person.

Creating a user file adapted to your recorded speech (Training)

What is “Training”?

Before you can transcribe recorded messages using Dragon NaturallySpeaking, you must create a user file specifically adapted to the sound of your recorded speech. This procedure is called “training.” When training is complete, Dragon NaturallySpeaking creates a user speech file containing information about your recorded speech.

- Refer to the operating instructions or the help supplied with Dragon NaturallySpeaking, as some parts of training are the same as those required for dictating directly to the computer using a headset microphone.
- Even if you have already created a user speech file with a headset microphone, you should create a separate speech file for the IC recorder to get better recognition accuracy.

Tips on using the IC recorder

When transcribing messages recorded using the IC recorder, the following tips will help you obtain maximum recognition accuracy.

- **Set “REC Mode” to “ST,” “STSP,” “STLP” or “SP” in the menu.**

When creating a user speech file (training), set “REC Mode” to the mode you normally use for voice recognition software.

- **Set “Mic Sensitivity” to “Low ” in the menu.**
- **Hold the IC recorder firmly and start recording.**
Hold the IC recorder so that the microphone is about an inch (2 cm - 3 cm) from the corner of your mouth, not directly in front of it. This minimizes the

sound of your breath in the recordings, enabling maximum recognition accuracy.

Note

Avoid recording in a noisy place, such as on a subway platform, in order to obtain maximum recognition accuracy.

Disconnecting the IC Recorder from Your Computer

Follow the procedures below; otherwise, data may be damaged.

- 1** Make sure that the operation indicator does not light.
- 2** Perform the following operation on your computer.

On the Windows screen, left-click the icon at the bottom of the desktop of the computer.



→ Left-click “Safely remove USB Mass Storage Device.”

The icon can be different on different operating systems.

On the Macintosh screen, drag the “IC RECORDER” on the desktop to “Trash” and drop it there.

For details on disconnecting the IC recorder from your computer, refer to the operating instructions supplied with your computer.

- 3** Make sure that the display of the IC recorder turns off.
- 4** Disconnect the IC recorder from the USB port of the computer, and slide the USB lever in the direction of the arrow to retract the USB connector.

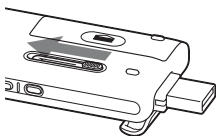

Using a USB AC Adaptor (not supplied)

USB connector of the IC recorder

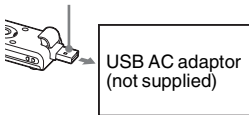

You can charge the rechargeable battery by connecting the IC recorder to an AC outlet using an AC-U50AD (U.S.A. and Canada only) or an AC-U50A (Latin America only) USB AC adaptor (not supplied).

You can charge the battery while you are using the IC recorder, so that it is useful when you want to record for a long time. When you use the IC recorder for the first time, or after you have not used the IC recorder for a certain time, it is recommended that you charge the battery repeatedly until “**Full**” is displayed. It takes about 3 hours and 30 minutes to fully charge exhausted battery.*

Note

Your dealer may not handle some of the optional accessories. Please ask the dealer for detailed information.

- 1 Connect the USB AC adaptor (not supplied) to an AC outlet.
- 2 Slide the USB lever of the IC recorder and connect the IC recorder to a USB AC adaptor.

While the battery is charging, the remaining battery indicator are displayed in an animation.

Now you can use the IC recorder while changing the battery.



- * This is an approximation for the time it takes to charge from no remaining battery power to full battery power at room temperature. It varies depending on the remaining power and the condition of the battery. It also takes more time if the temperature of the battery is low, or if the battery is charged while you are transferring data to the IC recorder.

Disconnecting the IC recorder from the AC outlet

Follow the procedures below; otherwise, when the IC recorder contains data files, the files may be damaged or become unplayable.

- 1 If you are recording or playing back a message, press **■ STOP** to put the IC recorder into the stop mode.
- 2 Make sure that the operation indicator does not light.
- 3 Disconnect the IC recorder from the USB AC adaptor, and then disconnect the USB AC adaptor from the AC outlet.

■ Notes

- During recording (the operation indicator lights or flashes in red) or accessing data (the operation indicator flashes in orange),
 - the IC recorder should not be connected to or disconnected from the USB AC adaptor connected to the AC outlet.
 - the USB AC adaptor connected to the IC recorder should not be connected to or disconnected from the AC outlet.
- Doing so may damage the data. If the IC recorder is required to process a large amount of data, the start-up window may be

displayed for an extended period of time. This is not a malfunction of the IC recorder. Wait until the start-up display disappears from the display window.

- While a USB AC adaptor (not supplied) is being used, the remaining battery indicator does not appear in the display window.

Precautions

On power

Operate the unit only on 1.5 V or 1.2 V DC. Use one NH-AAA rechargeable battery or one LR03 (size AAA) alkaline battery.

On safety

Do not operate the unit while driving, cycling or operating any motorized vehicle.

On handling

- Do not leave the unit in a location near heat sources, or in a place subject to direct sunlight, excessive dust or mechanical shock.
- Should any solid object or liquid fall into the unit, remove the battery and have the unit checked by qualified personnel before operating it any further.
- Be careful not to allow water to splash on the unit. The unit is not water-proof. In particular, be careful in the following situations.
 - When you have the unit in your pocket and go to the bathroom, etc.
When you bend down, the unit may drop into the water and may get wet.

- When you use the unit in an environment where the unit is exposed to rain, snow, or humidity.
- In circumstances where you get sweaty. If you touch the unit with wet hands or if you put the unit in the pocket of sweaty clothes, the unit may get wet.
- You may feel pain in your ears if you use the headphones when the ambient air is very dry. This is not because of a malfunction of the headphones, but because of static electricity accumulated in your body. You can reduce static electricity by wearing non-synthetic clothes that prevent the emergence of static electricity.

On noise

- Noise may be heard when the unit is placed near an AC power source, a fluorescent lamp or a mobile phone during recording or playback.
- Noise may be recorded when an object, such as your finger, etc., rubs or scratches the unit during recording.

On maintenance

To clean the exterior, use a soft cloth slightly moistened in water. Do not use alcohol, benzine or thinner.

If you have any questions or problems concerning your unit, please consult your nearest Sony dealer.

Backup recommendations

To avoid potential risk of data loss caused by accidental operation or malfunction of the IC recorder, we recommend that you save a backup copy of your recorded messages on a tape recorder or to a computer, etc.

Specifications

System requirements

Operating systems:

- Windows Vista® Ultimate Service Pack 1 or higher
- Windows Vista® Business Service Pack 1 or higher
- Windows Vista® Home Premium Service Pack 1 or higher
- Windows Vista® Home Basic Service Pack 1 or higher
- Windows® XP Media Center Edition 2005 Service Pack 3 or higher
- Windows® XP Media Center Edition 2004 Service Pack 3 or higher
- Windows® XP Media Center Edition Service Pack 3 or higher
- Windows® XP Professional Service Pack 3 or higher
- Windows® XP Home Edition Service Pack 3 or higher
- Windows® 2000 Professional Service Pack 4 or higher
- Mac OS X (v10.2.8-v10.5)
- Pre-Installed

■ Notes

- Operation is not guaranteed if any operating system other than those indicated on the left (Windows® 98 or Linux, etc.) is used.
- 64 bit versions of Windows® XP are not supported.
- For the latest version information and compatibility with your operating system, please access the support home page for the IC recorder:
U.S.A.:
<http://www.sony.com/recordersupport>
Canada:
<http://www.sony.ca/ElectronicsSupport/>
<http://fr.sony.ca/ElectronicsSupport/>
Latin American areas:
<http://www.sony-latin.com/index.crp>

Hardware environment:

- Port: USB port
- Sound board: Sound cards compatible with any of the supported Microsoft® Windows® operating systems

■ Note

- The following systems are not supported:
 - Operating systems other than the ones indicated on the left
 - Personally constructed computers or operating systems
 - Upgraded operating systems
 - Multi-boot environment
 - Multi-monitor environment

When you are using Windows® 2000 Professional

Install the driver using
“SonyRecorder_Driver.exe” in the IC
recorder.

Design and specifications

IC recorder section

Capacity (User available capacity)

ICD-UX200/UX200F: 2 GB

(approx. 1.79 GB = 1,928,822,784 Byte)

ICD-UX300/UX300F: 4 GB

(approx. 3.59 GB = 3,860,922,368 Byte)

A part of the memory capacity is used as a
management area.

Frequency range

- ST: 40 Hz - 20,000 Hz
- STSP: 40 Hz - 15,000 Hz
- STLP: 60 Hz - 7,500 Hz
- SP: 60 Hz - 10,000 Hz
- LP: 60 Hz - 3,400 Hz

Bit rate and sampling frequencies for
MP3 files*1

Bit rate: 32 kbps - 320 kbps, VBR

Sampling frequencies:

16/22.05/24/32/44.1/48 kHz

*1 The playback of MP3 files recorded using
the IC recorder is also supported. Not all
encoders are supported.

Bit rate and sampling frequencies*2 for
WMA files

Bit rate: 32 kbps - 192 kbps*3, VBR

Sampling frequencies: 44.1 kHz

*2 WMA Ver. 8 Class2A is compatible,
however, MBR (Multi Bit Rate), Lossless,
Professional, and Voice are not supported.
This IC recorder cannot play back DRM
protected contents. Not all encoders are
supported.

*3 The NoiseSubstitution function is not
supported, therefore, playback becomes
simple playback with 32 kbps bit rate.

Bit rate and sampling frequencies for
AAC-LC files*4

Bit rate: 16 kbps - 320 kbps, VBR

Sampling frequencies:

11.025/12/16/22.05/24/32/44.1/48 kHz

*4 Not all encoders are supported.

FM radio section

Frequency range

87.50 MHz - 108.00 MHz

IF 150 kHz

Antenna

Stereo headphones cord antenna

General

Speaker

Approx. 16 mm (21/32 in.) dia.

Input/Output

- Microphone jack (minijack, stereo)
 - input for plug in power, minimum input level 0.9 mV, 3 kilohms or lower impedance microphone
- Headphone jack (minijack, stereo)
 - output for 8 ohms - 300 ohms headphones
- USB connector
 - High-Speed USB compatible

Playback speed control (DPC)

+100% to -50% (MP3)

0% to -50% (WMA/AAC-LC)

Power output

90 mW

Power requirements

One NH-AAA rechargeable battery (supplied):

1.2 V DC

One LR03 (size AAA) alkaline battery (not supplied): 1.5 V DC

Operating temperature

5°C - 35°C (41°F - 95°F)

Dimensions (w/h/d) (not incl. projecting parts and controls) (JEITA)*5

36.6 mm × 98.5 mm × 14.6 mm

(1 1/2 in. × 4 in. × 19/32 in.)

Mass (JEITA)*5

Approx. 58 g (2 oz) including NH-AAA rechargeable battery

*5 Measured value by the standard of JEITA (Japan Electronics and Information Technology Industries Association)

Supplied accessories

See page 7.

Optional accessories

Active speaker SRS-M50

Electret condenser microphone ECM-CS10, ECM-CZ10, ECM-DS70P, ECM-DS30P, ECM-TL1

Audio connecting cable RK-G136, RK-G139

Rechargeable battery NH-AAA-B2K

USB AC adaptor AC-U50AD (U.S.A. and

Canada only), AC-U50A (Latin America only)

Battery charger BCG-34HS2KA (U.S.A. and Canada only), BCG-34HLD22K (Latin America only)

Your dealer may not handle some of the above listed optional accessories. Please ask the dealer for detailed information.

Design and specifications are subject to change without notice.

Maximum recording time*6*7

The maximum recording time of all the folders is as follows.

| | ST mode | STSP mode | STLP mode | SP mode | LP mode |
|----------------------|-------------------|-------------------|--------------------|--------------------|----------------------|
| ICD-UX200/ UX200F | 22 hr. 15 min. | 33 hr. 25 min. | 89 hr. 15 min. | 133 hr. 55 min. | 535 hr. 45 min. |
| ICD-UX300/ UX300F | 44 hr. 40 min. | 67 hr. | 178 hr. 40 min. | 268 hr. 5 min. | 1,072 hr. 25 min. |

(hr.: hours/min.: minutes)

*6 When you are going to record continuously for a long time, you may have to replace the battery with a new one in the midst of recording. For details on the battery life, see page 103.

*7 The maximum recording time varies if you record messages in mixed recording mode.

Battery life*1

When using Sony NH-AAA rechargeable battery

| Recording mode | ST*2 | STSP*3 | STLP*4 | SP*5 | LP*6 | Music file (128 kbps/44.1 kHz) |
|-------------------------------|--------------------------|---------------------------|---------------------------|---------------------------|---------------------------|--------------------------------|
| Recording | Approx. 11 hr. | Approx. 11 hr. 30 min. | Approx. 14 hr. | Approx. 12 hr. | Approx. 14 hr. 30 min. | – |
| Playback*7 through speaker | Approx. 20 hr. | Approx. 20 hr. 30 min. | Approx. 22 hr. | Approx. 21 hr. 30 min. | Approx. 21 hr. | Approx. 20 hr. 30 min. |
| Playback using the headphones | Approx. 42 hr. | Approx. 43 hr. 30 min. | Approx. 49 hr. 30 min. | Approx. 50 hr. | Approx. 53 hr. 30 min. | Approx. 43 hr. 30 min. |
| FM recording | Approx. 3 hr. 30 min. | Approx. 4 hr. 30 min. | Approx. 4 hr. | Approx. 4 hr. | Approx. 5 hr. | – |
| FM reception: | Approx. 6 hr. | | | | | |

(hr.: hours/min.: minutes)

When using Sony LR03 (SG) (size AAA) alkaline battery

| Recording mode | ST*2 | STSP*3 | STLP*4 | SP*5 | LP*6 | Music file (128 kbps/44.1 kHz) |
|----------------------------|---------------------------|---------------------------|----------------|---------------------------|----------------|--------------------------------|
| Recording | Approx. 11 hr. | Approx. 12 hr. | Approx. 15 hr. | Approx. 12 hr. 30 min. | Approx. 15 hr. | – |
| Playback*7 through speaker | Approx. 26 hr. 30 min. | Approx. 27 hr. 30 min. | Approx. 29 hr. | Approx. 28 hr. 30 min. | Approx. 30 hr. | Approx. 27 hr. 30 min. |

| Recording mode | ST*2 | STSP*3 | STLP*4 | SP*5 | LP*6 | Music file (128 kbps/44.1 kHz) |
|-------------------------------|--------------------------|--------------------------|---------------------------|----------------|----------------|---------------------------------------|
| Playback using the headphones | Approx. 63 hr. | Approx. 67 hr. | Approx. 75 hr. 30 min. | Approx. 75 hr. | Approx. 83 hr. | Approx. 67 hr. |
| FM recording | Approx. 3 hr. 30 min. | Approx. 4 hr. 30 min. | Approx. 4 hr. | Approx. 4 hr. | Approx. 5 hr. | – |

FM reception: Approx. 7 hr. 30 min.

(hr.: hours/min.: minutes)

*1 The battery life is measured in testing using methods proprietary to Sony. The battery life may shorten depending on how you operate the IC recorder.

*2 ST: Stereo high quality recording mode

*3 STSP: Stereo standard recording mode

*4 STLP: Stereo long play recording mode

*5 SP: Monaural standard play recording mode

*6 LP: Monaural long play recording mode





*7 When playing back music through the internal speaker with the volume level set to 15





Troubleshooting

Before taking the IC recorder for repair, check the following sections. Should any problem persist after you have made these checks, consult your nearest Sony dealer.

Please note that recorded messages may be erased during service or repair work.

| Symptom | Remedy |
|--|--|
| The IC recorder cannot be turned off. | <ul style="list-style-type: none"> Slide the HOLD/POWER switch in the direction of "POWER" for more than 2 seconds when the IC recorder is stopped (page 12). |
| The IC recorder cannot be turned on. | <ul style="list-style-type: none"> The power to the IC recorder is off. Slide the HOLD/POWER switch in the direction of "POWER" for more than 1 second (page 12). |
| The IC recorder is powered off automatically. | <ul style="list-style-type: none"> When you leave the IC recorder without attempting an operation for a certain length of time, the auto power off function will take effect. (The length of time before auto power off is set to "10min" when you purchase the IC recorder.) You can select the length of time before auto power off in the menu (page 81). |
| Display does not disappear. Display appears blurred. | <ul style="list-style-type: none"> Remove the protective film on the display window before you use the IC recorder. |
| The IC recorder does not operate. | <ul style="list-style-type: none"> The battery has been inserted with incorrect polarity (page 9). The battery is weak (page 11). The power to the IC recorder is off. Slide the HOLD/POWER switch in the direction of "POWER" for more than 1 second (page 12). The HOLD function is activated. Slide the HOLD/POWER switch towards the center (page 17). |
| No sound comes from the speaker. | <ul style="list-style-type: none"> The volume is turned down completely (page 22). Headphones are plugged in (page 42). When you are listening to the FM radio, "Audio Output" is set to "Headphones." Set it to "Speaker" (page 61). |

| Symptom | Remedy |
|---|--|
| Sound comes from the speaker even when the headphones are plugged in. | <ul style="list-style-type: none"> • If you plug in the headphones not securely during playback, the sound may come from the speaker. Unplug the headphones, and then insert them securely. • When you are listening to the FM radio, “Audio Output” is set to “Speaker.” Set it to “Headphones” (page 61). |
| The operation indicator does not light. | <ul style="list-style-type: none"> • “LED” is set to “OFF.” Display the menu and set “LED” to “ON” (page 80). |
| “Memory Full” is displayed and you cannot start recording. | <ul style="list-style-type: none"> • The memory is full. Erase some of the messages (page 26) or erase all the messages after you store them on your computer. |
| “File Full” is displayed and you cannot operate the IC recorder. | <ul style="list-style-type: none"> • 99 messages have been recorded in the selected  folder or 990 messages (when there are 10 folders) in total have been recorded. Therefore you cannot record another message, or move a message. Erase some of the messages (page 26) or erase all the messages after you store them on your computer. |
| Recording is interrupted. | <ul style="list-style-type: none"> • The VOR function is activated. Set “VOR” to “OFF” in the menu (page 32). |
| Noise is heard. | <ul style="list-style-type: none"> • An object, such as your finger, etc., accidentally rubbed or scratched the IC recorder during recording so that noise was recorded. • The IC recorder was placed near an AC power source, a fluorescent lamp or a mobile phone during recording or playback. • Plug of the connected microphone was dirty when recording. Clean the plug. • The  (headphones) plug is dirty. Clean the plug. |
| Recording level is low. | <ul style="list-style-type: none"> • “Mic Sensitivity” (microphone sensitivity) is set to “Low . • Display the menu and set “Mic Sensitivity” to “High ” or “S-High ” (page 29). |

| Symptom | Remedy |
|--|--|
| The VOR function does not work. | <ul style="list-style-type: none"> The synchronized recording function is activated (page 37). Set "SYNC REC" to "OFF" in the menu (page 82). During FM recording, the VOR function does not work. |
| You cannot divide a message. | <ul style="list-style-type: none"> You need a certain amount of free space in the memory to divide a message. If 99 messages have been recorded in a folder, you cannot divide a message in that folder. 99 messages have been recorded in the selected  folder. Erase some of the messages (page 26) or erase all the messages after you store them on your computer. The synchronized recording function is activated (page 37). Set "SYNC REC" to "OFF" in the menu (page 82). You may not be able to divide a message at the beginning or at the end of the message because of system limitations. You cannot divide or move a message other than the one recorded using the IC recorder (MP3/WMA/AAC-LC file transferred from a computer). If you divide a message frequently, the unit may become unable to divide the message further. |
| When recording from other equipment, the input level is too strong or not strong enough. | <ul style="list-style-type: none"> Connect the headphone jack of other equipment to the  (microphone) jack of the IC recorder and adjust the volume level on the piece of equipment connected to the IC recorder. |
| Playback speed is too fast or too slow. | <ul style="list-style-type: none"> The playback speed is adjusted in DPC. Slide the DPC (SPEED CTRL) switch to "OFF" or press  or  on the control button to adjust the speed in DPC again (page 43). |
| "--:--" is displayed. | <ul style="list-style-type: none"> You have not set the clock (page 13). |
| "--y--m--d" or "--:--" is displayed on the REC Date display. | <ul style="list-style-type: none"> The date of recording will not be displayed if you recorded the message when the clock was not set. |

| Symptom | Remedy |
|---|--|
| There are fewer menu items displayed in the menu mode. | <ul style="list-style-type: none"> • The menu items displayed are different depending on the operation modes (stop mode, playback mode, recording mode, and FM radio reception mode) (page 72). |
| The battery life is short. | <ul style="list-style-type: none"> • The battery life on page 103 is based on playback with the volume level set to 15. The battery life may shorten depending on the operation of the IC recorder. |
| There is no battery power remaining after you have left the battery inserted for long time without using the IC recorder. | <ul style="list-style-type: none"> • Even if you do not use the IC recorder, the battery is consumed slightly. The battery life in this case varies depending on humidity or other environmental conditions. If you do not intend to use the IC recorder for an extended period of time, it is recommended that you turn the power off (page 12) or remove the battery. Moreover, if you set “Auto Power Off” to a short span in the menu (page 81), you can prevent the battery from being consumed due to forgetting to turn the IC recorder off. |
| There is no battery power remaining when you disconnect the IC recorder from the USB AC adaptor after you have left the IC recorder connected for long time, fully charged. | <ul style="list-style-type: none"> • Once the battery is full charged, it is not recharged automatically, even if you leave the IC recorder connected to the USB AC adaptor. You can use the IC recorder while it is connected to the USB AC adaptor, but charge it again after disconnecting it. |
| The charging indicator is not displayed. | <ul style="list-style-type: none"> • You are not using a rechargeable battery or are using a battery other than a rechargeable battery (alkaline battery, manganese battery, etc.) • Rechargeable battery has been inserted with incorrect polarity. • “USB Charge” of “Detail Menu” is set to “OFF” in the menu. To charge the battery using your computer, set it to “ON.” • When playing back messages using the built-in speaker, or when listening to the FM radio, you cannot charge the battery. |

| Symptom | Remedy |
|---|--|
| The charging indicator disappears in the middle of charging. | <ul style="list-style-type: none"> • A rechargeable battery other than an NH-AAA model or a battery other than a rechargeable battery (alkaline battery, manganese battery, etc.) has been inserted. • The rechargeable battery has deteriorated. • When playing back messages using the built-in speaker, or when listening to the FM radio, you cannot charge the battery. |
| “ COLD ” or “ HOT ” is flashing instead of the remaining battery indicator. | <ul style="list-style-type: none"> • The environmental temperature is out of the range for charging. Charge the battery in an environment with a temperature of 5 °C - 35 °C. |
| The battery life of the rechargeable battery is short. | <ul style="list-style-type: none"> • You are using the rechargeable battery in an environment with a temperature of under 5 °C. Charge the battery in an environment with a temperature of 5 °C - 35 °C. • The IC recorder has not been used for a certain time. Charge and discharge the rechargeable battery using the IC recorder several times. • Replace the old one with new rechargeable battery. • The remaining battery indicator is displayed only for a short time, however, the rechargeable battery is not charged completely. It takes about 3 hours and 30 minutes to fully charge exhausted battery. |
| The changed menu setting does not function. | <ul style="list-style-type: none"> • If the battery is removed just after the menu setting is changed, the menu setting may not function. |

| Symptom | Remedy |
|---|---|
| You cannot charge the battery by connecting the IC recorder to your computer. | <ul style="list-style-type: none"> • When you connect the IC recorder to a computer which is not running, the battery will not be charged. • Even if the computer is on, and the computer is in a mode of reduced operation (standby or sleep), you cannot charge the battery. • “USB Charge” of “Detail Menu” is set to “OFF” in the menu. To charge the battery using your computer, set it to “ON.” • Disconnect the IC recorder from your computer and reconnect it. • Operation is not guaranteed if you use any system requirements other than those described on page 99. • When you are listening to the FM radio, you cannot charge the battery. |
| The audio is weak or has poor quality when listening to the radio. | <ul style="list-style-type: none"> • The battery is weak. Replace the battery with new one (page 9). • Move the unit away from the TV. |
| The picture of your TV becomes unstable. | <ul style="list-style-type: none"> • If you are listening to an FM program near the TV with an indoor antenna, move the IC recorder away from the TV. |
| You cannot receive FM radio stations, or a lot of static is heard. | <ul style="list-style-type: none"> • The headphones are not connected (the headphone cord is the FM antenna). • Connect the headphones to the  (headphone) jack and extend the headphone cord. • “DX/LOCAL” has been set to “LOCAL.” Set it to “DX” (page 79). |
| You cannot preset an FM radio station. | <ul style="list-style-type: none"> • You have already preset 30 FM radio stations. Erase unwanted preset stations (page 69). • “Scan Sensitivity” has been set to “Low(SCAN L).” Set it to “High(SCAN H)” (page 79). |
| It takes a long time for the IC recorder to start. | <ul style="list-style-type: none"> • If the IC recorder is required to process a large amount of data, it may take longer for the IC recorder to start. This is not a malfunction of the IC recorder. Wait until the start-up display disappears. |

| Symptom | Remedy |
|--|---|
| The IC recorder does not operate correctly. | <ul style="list-style-type: none">• Take out the battery and insert it again (page 9). |
| The IC recorder does not operate. | <ul style="list-style-type: none">• You may have formatted the memory of the IC recorder using the computer. Use the IC recorder formatting function to format the memory (page 82). |
| The IC recorder is not recognized by your computer. A folder/file cannot be transferred from your computer. | <ul style="list-style-type: none">• Disconnect the IC recorder from your computer and reconnect it.• Do not use a USB hub or USB extension cable other than the supplied USB connection support cable. Connect the IC recorder directly to your computer or use the supplied USB connection support cable.• Operation is not guaranteed if you use any system requirements other than those described on page 99.• Depending on the USB port position, the IC recorder may not be recognized. If this happens, try another port. |
| The file transferred from your computer cannot be played back. | <ul style="list-style-type: none">• The file format may differ from those that can be played back using the IC recorder (MP3/WMA/AAC-LC). |
| The computer cannot start. | <ul style="list-style-type: none">• If you reboot the computer with the unit connected to the computer, the computer may freeze or may not start properly. Disconnect the unit from the computer and reboot the computer again. |

Error Messages

| Error message | Cause/Remedy |
|----------------------|---|
| Low Battery Level | <ul style="list-style-type: none">• You cannot format the memory or erase all the files in a folder because of insufficient battery power. Prepare a new battery to replace the current one. |
| Low Battery | <ul style="list-style-type: none">• Battery is exhausted. Replace the old battery with a new one. Or charge the rechargeable battery or replace the old rechargeable battery with a new one. |
| Memory Full | <ul style="list-style-type: none">• The remaining memory capacity of the IC recorder is insufficient. Erase some messages before recording. |
| File Full | <ul style="list-style-type: none">• When there are already 99 messages in the selected folder or the total number of the file stored in the IC recorder becomes maximum, you cannot record a new message. Erase some messages before recording a message. |
| File Damaged | <ul style="list-style-type: none">• You cannot play or edit messages, because the data of the selected file is damaged. |
| Format Error | <ul style="list-style-type: none">• The IC recorder cannot be turned on using the computer because there is no copy of the control file required for operation. Format the IC recorder using the formatting function in the menu. |
| Process Error | <ul style="list-style-type: none">• The IC recorder failed in memory access. Remove and then re-insert the battery.• Save a backup copy of your data and format the IC recorder using the menu. |
| Set Date&Time | <ul style="list-style-type: none">• Set the clock; otherwise, you cannot set the alarm. |
| No File | <ul style="list-style-type: none">• The selected folder does not have any messages. You cannot move a message or set the alarm, etc., because of this. |

| Error message | Cause/Remedy |
|----------------------|---|
| Already Set | <ul style="list-style-type: none">• The selected message has already been set for alarm playback. Select the other message.• You set the alarm to play back a message at a date and time previously set on another message. Change the alarm setting. |
| Past Date/Time | <ul style="list-style-type: none">• You set the alarm when the time has already passed. Check it and set the appropriate date and time. |
| No Setting | <ul style="list-style-type: none">• If you have not set the alarm, the alarm list will not be displayed. Make the alarm setting for “New.” |
| Settings are Full | <ul style="list-style-type: none">• You can set up to 30 alarms. Cancel unwanted alarms.• When 30 FM stations have already been stored in the IC recorder’s memory, you cannot preset a new FM station. |
| File Protected | <ul style="list-style-type: none">• The selected message is protected and is now a “Reading only” file. You cannot erase it. Cancel the protection on the IC recorder or cancel “Read only” on your computer to edit the message using the IC recorder. |
| Unknown Data | <ul style="list-style-type: none">• This data is not in a file format that is supported by the IC recorder. The IC recorder supports MP3 files (.mp3), WMA files (.wma), and AAC-LC files (.m4a). See “Design and specifications” on page 100.• You cannot play back copyright protected files. |
| Invalid Operation | <ul style="list-style-type: none">• You cannot move a message or divide a message, because there is more than one folder that has files with same name. Change the file names.• A message in the  folder cannot be moved or divided.• You cannot divide messages not recorded using the IC recorder. |
| New Message | <ul style="list-style-type: none">• The maximum recording message/music file size is 1 GB. When the recording message/music file size exceeds the maximum size limit, exceeded recording is recorded as a new message. |

| Error message | Cause/Remedy |
|------------------------------|---|
| Change Folder | <ul style="list-style-type: none">• If there are no MP3 files in the  folder, no folders are displayed in the display window, therefore, the folder setting will be changed. |
| System Error | <ul style="list-style-type: none">• A system error other than the above has occurred. Remove the battery and re-insert it. |
| Invalid when Noise Cut is ON | <ul style="list-style-type: none">• When the “Noise Cut” is set to “ON” in the menu, the setting of the “Effect” menu does not work. Cancel the noise cut setting. |

System Limitations

There are some system limitations of the IC recorder. Troubles as mentioned below are not malfunctions of the IC recorder.

| Symptom | Cause/Remedy |
|---|---|
| You cannot record messages up to the maximum recording time. | <ul style="list-style-type: none">• If you record messages in a mixture of ST, STSP, STLP, SP and LP modes, the recordable time varies from the maximum ST mode recording time to the maximum LP mode recording time.• The sum of the number on the counter (elapsed recording time) and the remaining recording time may be less than the IC recorder's maximum recording time. |
| You cannot display or play back music files in order. | <ul style="list-style-type: none">• If you have transferred music files using your computer, those files may not be copied in order of transfer because of system limitations. If you copy music files from your computer to the IC recorder one by one, you can display and play back the music files in copied order. |
| A message/music file is automatically divided. | <ul style="list-style-type: none">• The message/music file has reached the maximum size limit (1 GB), therefore it is automatically divided. |
| You cannot enter lower-case characters. | <ul style="list-style-type: none">• Depending on the combination of the characters used for the folder name that was made on your computer, those characters may change to all capitals. |
| “□” is displayed in place of a folder name, title, artist name, or file name. | <ul style="list-style-type: none">• A character which cannot be displayed on the IC recorder has been used. Using your computer, replace it with one which can be displayed on the IC recorder. |
| You cannot specify the finishing point B. | <ul style="list-style-type: none">• You cannot specify the finishing point B before the starting point A that has been set. |
| When you set A-B Repeat playback, the set positions move a little. | <ul style="list-style-type: none">• Depending on the files, the set positions may move. |

Display Window Guide

Display when stopped or recording

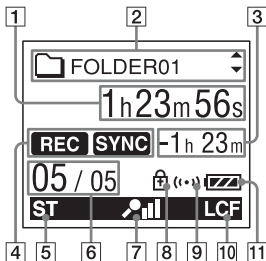

- 1 Elapsed time/Remaining time/
Recording date and time indication
 - 2 () Folder name/ Message
title name/ Artist name/ File
name indication
- Press ▲ or ▼ of the control button to display a folder name, message title, artist name, and file name in sequence.

- 3 Remaining recording time indication
Displays the remaining recording time
in hours, minutes, and seconds.
If there is more than 10 hours time
remaining, the time is displayed in
hours.
If there is more than 10 minutes and
less than 10 hours time remaining, the
time is displayed in hours and minutes.
If there is less than 10 minutes time
remaining, the time is displayed in
minutes and seconds.
- 4 Operation mode indicator
Displays the following, depending on
the current operation mode
 : stop
 : playback
 : recording
 : recording standby/recording
pause
 : recording with the VOR
function
 : recording pause with the
VOR function (flashing)
If you press ● REC/PAUSE to pause
recording when “VOR” is set to “ON”
in the menu, only “ ” flashes.

REC SYNC : Synchronized recording

● || SYNC : Flashes while synchronized recording is set to pause.

◀▶ ▶▶ : review/fast backward, cue/fast forward

◀▶ ▶▶ : going backward/forward continuously

5 Recording mode indicator

Displays the recording mode set using the menu when the IC recorder is in the stop mode, and displays the current recording mode when the IC recorder is in the playback or recording mode.

ST : Standard play stereo recording mode with high quality sound

STSP : Standard play stereo recording mode

STLP : Long play stereo recording mode

SP : Standard play monaural recording mode

LP : Long play monaural recording mode

Displays the following when a file is transferred from the computer.

MP3 : MP3 files transferred

WMA : WMA files transferred

AAC : AAC-LC files transferred

Displays the following when the IC recorder cannot get the recording mode information.

--- : Unknown

6 Selected message number/Total number of messages in the folder

7 Microphone sensitivity indicator

Displays the microphone sensitivity.

🔊 : Recorded with the further high recording level.

🔊 : Recorded with the high recording level.

🔊 : Recorded with the low recording level.

8 Protect indicator

Appears when protection is set for a message.

9 Alarm indicator

Appears when the alarm is set for a message.

10 LCF (Low Cut Filter) indicator

Appears when “LCF(Low Cut)” is set to “ON” in the menu.

11 Battery indicator

When a dry battery is used, the indicator shows the remaining battery power.

While charging the rechargeable battery an animation appears.

Display during playback

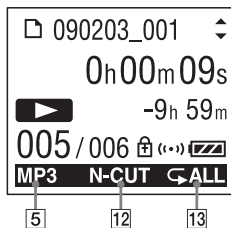

12 Noise cut/Effect

Displays the “Noise Cut” or “Effect” setting in the menu.

N-CUT : Noise Cut

HP : Pop

HR : Rock

HJ : Jazz

BA1 : Bass 1

BA2 : Bass 2

HC : Custom

13 Repeat playback

1 : Appears when one message is played back repeatedly.

☞ : Appears when messages in one folder are played back repeatedly.

☞ ALL : Appears when all the messages are played back repeatedly.

Display when listening to the FM radio

(for ICD-UX200F/UX300F only)

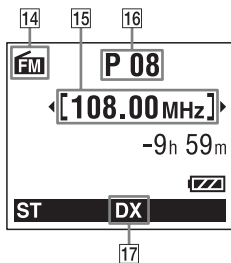

14 FM indicator

15 Radio frequency

16 Preset number

17 Receiver sensitivity

LOCAL : LOCAL

DX : DX

Index

A

- AAC-LC files 100
- A-B Repeat 46
- Adjusting the volume 23, 34
- Alarm 50, 72, 78
- Alkaline battery 103

B

- Battery life 103
- Built-in microphones 19

C

- Connecting the IC recorder to your
computer 84
- Copying messages 87
- Copying music files 88
- Cue/Review 42

D

- Dividing a message 34, 58
- DPC (Digital Pitch Control) 43

E

- Easy Search 42, 72, 76
- Editing messages 55

- Erase all 55
- Erasing 26
- Error messages 112

F

- FM Radio
 - Audio Output 61, 73, 79
 - Auto Preset 64, 72, 79
 - DX/LOCAL 62, 72, 79
 - Listening to the FM Radio 60, 72, 79
 - Scan Sensitivity 65, 73, 79
- Folder 18, 22, 56, 85

H

- HOLD 17
- HOLD/POWER switch 12, 17

I

- Index to parts and controls
 - Display window 116
 - Front 8
 - Rear 8

L

| | |
|----------------------------|----------------------|
| LCF (Low Cut Filter) | 31, 72, 74 |
| LP | 29, 72, 74, 102, 103 |

M

| | |
|-------------------|----|
| Maintenance | 98 |
|-------------------|----|

Menu

| | |
|-----------------------|--------|
| Alarm | 72, 78 |
| Audio Output | 73, 79 |
| Auto Power Off | 73, 81 |
| Auto Preset | 72, 79 |
| Backlight | 73, 81 |
| Beep | 73, 80 |
| Date&Time | 73, 80 |
| Detail Menu | 73, 80 |
| Display | 72, 77 |
| DX/LOCAL | 72, 79 |
| Easy Search | 72, 76 |
| Effect | 72, 76 |
| Erase All | 72, 78 |
| FM Radio | 72, 79 |
| Format | 73, 82 |
| Language | 73, 81 |
| LCF(Low Cut) | 72, 74 |
| LED | 73, 80 |
| Making settings | 71 |
| Menu settings | 72 |

| | |
|------------------------|--------|
| Mic Sensitivity | 72, 74 |
| Move | 72, 78 |
| Noise Cut | 72, 75 |
| Play Mode | 72, 77 |
| Protect | 72, 78 |
| REC Mode | 72, 74 |
| Scan Sensitivity | 73, 79 |
| Select Input | 73, 82 |
| SYNC REC | 73, 82 |
| Time Display | 73, 80 |
| USB Charge | 73, 81 |
| VOR | 72, 75 |

| | |
|--------------------------------|------------|
| Microphone sensitivity | 29, 72, 74 |
| Monitoring the recording | 34 |
| Moving a message | 56, 72, 78 |
| MP3 files | 100 |

N

| | |
|-----------------|------------|
| Noise | 97 |
| Noise Cut | 47, 72, 75 |

P

| | |
|-----------------------|------------|
| Pause recording | 20 |
| Playback | 22, 42 |
| Playback modes | 45, 72, 77 |
| Precautions | 97 |

R

| | |
|--|------------|
| Rechargeable battery | 9, 103 |
| Recharging the battery | 9 |
| Recording | 18, 28 |
| Recording from a telephone | 37 |
| Recording from other equipment | 37 |
| Recording mode | 28, 72, 74 |
| Recording time | 102 |
| Recording with an external microphone | 36 |
| Recording with other equipment | 53 |
| Remaining battery indicator | 11 |
| Review | 20 |

S

| | |
|----------------------------------|----------------------|
| Selecting the sound effect | 48, 72, 76 |
| Setting the clock | 13 |
| Setting the language | 15, 73, 81 |
| SP | 29, 72, 74, 102, 103 |
| Specifications | 99 |
| ST | 29, 72, 74, 102, 103 |
| STLP | 29, 72, 74, 102, 103 |
| STSP | 29, 72, 74, 102, 103 |
| Synchronized recording | 38, 73, 82 |
| System Limitations | 115 |

T

| | |
|-----------------------|-----|
| Troubleshooting | 105 |
|-----------------------|-----|

U

| | |
|----------------------|----|
| USB AC adaptor | 95 |
| USB Memory | 91 |

V

| | |
|---|------------|
| Voice recognition software | 92 |
| VOR (Voice Operated Recording) | 32, 72, 75 |

W

| | |
|-----------------|-----|
| WMA files | 100 |
|-----------------|-----|

Trademarks

- Microsoft, Windows, Windows Vista and Windows Media are registered trademarks or trademarks of Microsoft Corporation in the United States and/or other countries.
- Apple, Macintosh and Mac OS are trademarks of Apple Inc., registered in the USA and other countries.
- Nuance, the Nuance logo, Dragon, Dragon NaturallySpeaking, and RealSpeak are trademarks and/or registered trademarks of Nuance Communications Inc., and/or its affiliates in the United States and/or other countries.
- MPEG Layer-3 audio coding technology and patents licensed from Fraunhofer IIS and Thomson.

All other trademarks and registered trademarks are trademarks or registered trademarks of their respective holders. Furthermore, “™” and “®” are not mentioned in each case in this manual.

<http://www.sony.net/>



* 4 1 5 6 5 4 6 7 1 * (2)