



**EM 2000**  
**EM 2050**

# Contents

<b>Important safety instructions</b> .....	2
<b>The EM 2000 and EM 2050 rack-mount receivers</b> .....	4
Areas of application .....	4
The frequency bank system .....	4
<b>Delivery includes</b> .....	5
<b>Product overview</b> .....	6
Overview of the EM 2000/EM 2050 receiver .....	6
Overview of the displays .....	7
<b>Putting the receiver into operation</b> .....	9
Setting up the receiver on a flat surface .....	9
Mounting the receiver into a 19" rack .....	9
Connecting the antennas .....	9
Daisy-chaining receivers .....	12
Connecting an amplifier/mixing console .....	12
Connecting receivers in a network .....	12
Connecting the mains cable .....	13
<b>Using the receiver</b> .....	14
Switching the receiver on/off .....	14
Monitoring the audio signal via headphones .....	14
Synchronizing a transmitter with the receiver .....	15
Deactivating the lock mode temporarily .....	15
Muting the audio signal .....	16
Selecting a standard display .....	16
<b>Using the operating menu</b> .....	17
The buttons .....	17
Overview of the operating menu .....	17
Working with the operating menu .....	19
<b>Adjustment tips and functions</b> .....	21
Standard displays with additional functions .....	21
The main menu "Menu" .....	22
The extended menu "Advanced Menu" .....	26
The "Sync Settings" submenu .....	29
Activating/deactivating warning messages – "Warnings" .....	30
<b>Synchronizing transmitters with receivers</b> .....	31
Synchronizing a transmitter with the receiver – individual operation .....	31
Synchronizing transmitters with receivers – multi-channel operation .....	31
<b>Cleaning the receiver</b> .....	33
<b>Recommendations and tips</b> .....	34
<b>If a problem occurs ...</b> .....	35
<b>Accessories</b> .....	37
<b>Specifications</b> .....	38
<b>Manufacturer Declarations</b> .....	40
<b>Index</b> .....	41



For further information, visit the EM 2000 product page on our website at [www.sennheiser.com](http://www.sennheiser.com).

## Important safety instructions

1. Read these instructions.
2. Keep these instructions. Always include these instructions when passing the receiver on to third parties.
3. Heed all warnings.
4. Follow all instructions.
5. Do not use this apparatus near water.
6. Clean only with a dry cloth.
7. Do not block any ventilation openings. Install in accordance with the manufacturer's instructions.
8. Do not install near any heat sources such as radiators, heat registers, stoves, or other apparatus (including amplifiers) that produce heat.
9. Do not defeat the safety purpose of the polarized or grounding-type plug. A polarized plug has two blades with one wider than the other. A grounding type plug has two blades and a third grounding prong. The wide blade or the third prong are provided for your safety. If the provided plug does not fit into your outlet, consult an electrician for replacement of the obsolete outlet.
10. Protect the power cord from being walked on or pinched, particularly at plugs, convenience receptacles, and the point where they exit from the apparatus.
11. Only use attachments/accessories specified by the manufacturer.
12. Use only with the cart, stand, tripod, bracket, or table specified by the manufacturer, or sold with the apparatus. When a cart is used, use caution when moving the cart/apparatus combination to avoid injury from tip-over.
13. Unplug this apparatus during lightning storms or when unused for long periods of time.
14. Refer all servicing to qualified service personnel.  
Servicing is required when the apparatus has been damaged in any way, such as power supply cord or plug is damaged, liquid has been spilled or objects have fallen into the apparatus, when the apparatus has been exposed to rain or moisture, does not operate normally, or has been dropped.
15. To completely disconnect this apparatus from the AC mains, disconnect the power supply cord plug from the AC receptacle.
16. **WARNING:** To reduce the risk of fire or electric shock, do not expose this apparatus to rain or moisture.
17. Do not expose this equipment to dripping or splashing and ensure that no objects filled with liquids, such as vases, are placed on the equipment.
18. The mains plug of the power supply cord shall remain readily operable.



### Hazard warnings on the rear of the receiver



The label shown on the left is attached to the rear of the receiver. The symbols on this label have the following meaning:



This symbol is intended to alert the user to the presence of uninsulated dangerous voltage within the receiver's enclosure that may be of sufficient magnitude to constitute risk of fire or electric shock.



This symbol is intended to alert the user to the risk of electric shock if the receiver is opened. There are no user serviceable parts inside. Refer servicing to qualified personnel only.



This symbol is intended to alert the user to the presence of important operating and maintenance instructions in the literature accompanying this receiver.

### Overloading

Do not overload wall outlets and extension cables as this may result in fire and electric shock.

### Replacement parts

When replacement parts are required, be sure the service technician uses replacement parts specified by Sennheiser or those having the same characteristics as the original part. Unauthorized substitutions may result in fire, electric shock, or other hazards.

### Safety check

Upon completion of any service or repairs to this device, ask the service technician to perform safety checks to determine that the device is in safe operating order.

### Danger of hearing damage due to high volumes

This is a professional receiver. Commercial use is subject to the rules and regulations of the trade association responsible. Sennheiser, as the manufacturer, is therefore obliged to expressly point out possible health risks arising from use.

This receiver is capable of producing sound pressure exceeding 85 dB(A). 85 dB(A) is the sound pressure corresponding to the maximum permissible volume which is by law (in some countries) allowed to affect your hearing for the duration of a working day. It is used as a basis according to the specifications of industrial medicine. Higher volumes or longer durations can damage your hearing. At higher volumes, the duration must be shortened in order to prevent hearing damage. The following are sure signs that you have been subjected to excessive noise for too long a time:

- You can hear ringing or whistling sounds in your ears.
- You have the impression (even for a short time only) that you can no longer hear high notes.

### Intended use

Intended use of the EM 2000 receiver includes:

- having read these instructions, especially the chapter "Important safety instructions",
- using the device within the operating conditions and limitations described in this instruction manual.

"Improper use" means using the device other than as described in these instructions, or under operating conditions which differ from those described herein.

## The EM 2000 and EM 2050 rack-mount receivers

This receiver is part of the 2000 series. With this series, Sennheiser offers high-quality state-of-the-art RF transmission systems with a high level of operational reliability and ease of use. Transmitters and receivers permit wireless transmission with studio-quality sound.

Features of the 2000 series:

- Optimized PLL synthesizer and microprocessor technology
- HDX noise reduction system
- Pilot tone squelch control
- True diversity technology
- Switching bandwidth of up to 75 MHz
- Safe configuration of a multi-channel system via a network
- Scan function (Easy Setup) for scanning the frequency banks for unused channels

### Areas of application

The receiver can be combined with the following transmitters of the 2000 series:

Transmitter	Type
SK 2000	Bodypack transmitter
SKM 2000	Radio microphone
SKP 2000	Plug-on transmitter

The transmitters are available in the same UHF frequency ranges and are equipped with the same frequency bank system with factory-preset frequencies. An advantage of the factory-preset frequencies is that

- a transmission system is ready for immediate use after switch-on,
- several transmission systems can be operated simultaneously on the preset frequencies without causing intermodulation interference.

### The frequency bank system

The receivers are available in 5 UHF frequency ranges with up to 3,000 receiving frequencies per frequency range:

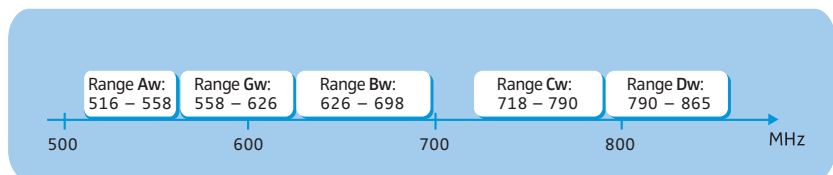

Each frequency range (Aw–Dw, Gw) offers 26 frequency banks with up to 64 channels each:

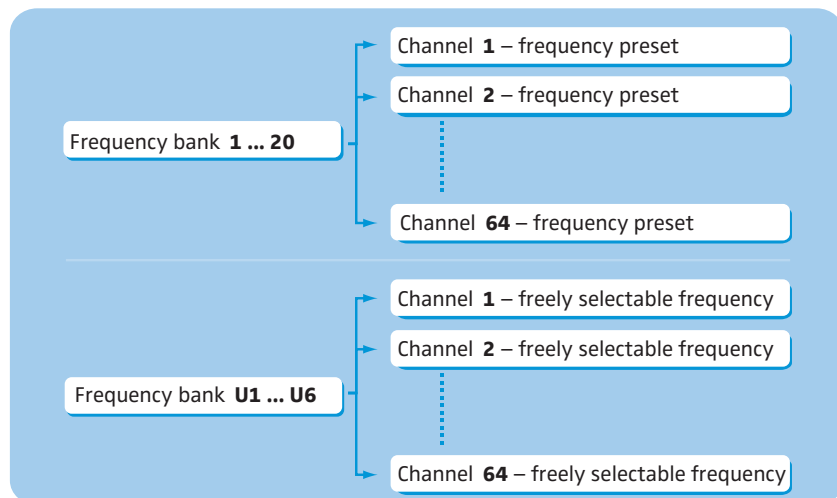

Each of the channels in the frequency banks “1” to “20” has been factory-preset to a fixed frequency (frequency preset). The factory-preset frequencies within one frequency bank are intermodulation-free. These frequencies cannot be changed.

For an overview of the frequency presets, please refer to the supplied frequency information sheet. Updated versions of the frequency information sheet can be downloaded from the EM 2000 product page on our website at [www.sennheiser.com](http://www.sennheiser.com).

The frequency banks “U1” to “U6” allow you to freely select and store frequencies. It might be that these frequencies are **not** intermodulation-free (see page 32).

## Delivery includes

The packaging contains the following items:

- 1 EM 2000 rack-mount receiver
- or
- 1 EM 2050 rack-mount twin receiver
- 3 mains cables (with EU, UK and US plug)
- 2 rod antennas
- 4 self-adhesive device feet
- 1 instruction manual
- 1 frequency information sheet

# Product overview

## Overview of the EM 2000/EM 2050 receiver



The EM 2050 twin receiver has the same operating elements as the EM 2000 receiver. All information contained in this instruction manual refers to both receivers.

### EM 2050

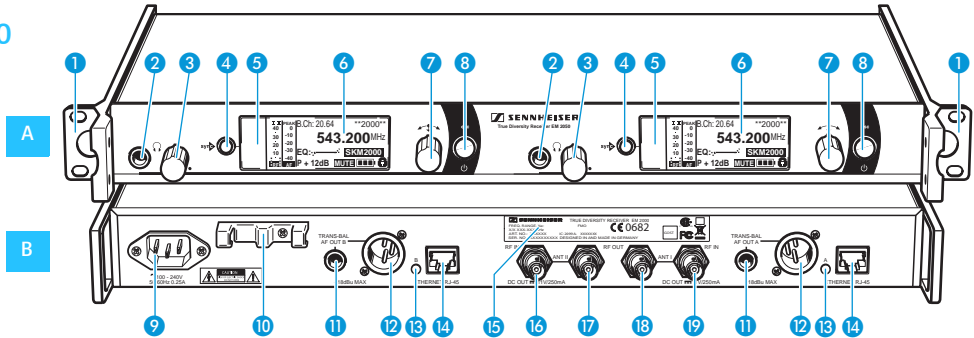

### EM 2000

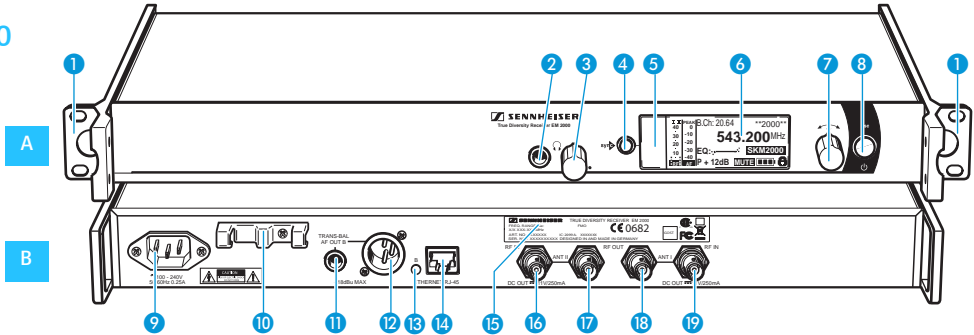

#### A Operating elements – front panel

- 1 Rack mount "ear"
- 2 Headphone output, 1/4" (6.3 mm) jack socket (🎧)
- 3 Headphone volume control
- 4 **syn** button, backlit
- 5 Infra-red interface
- 6 Display panel, backlit in orange
- 7 Jog dial
- 8 **STANDBY** button: operation indication (red backlighting), ESC function (cancel)

#### B Operating elements – rear panel

- 9 3-pin mains socket
- 10 Cable grip for mains cable
- 11 Audio output (**TRANS BAL AF OUT**), 1/4" (6.3 mm) jack socket, transformer balanced
- 12 Audio output (**TRANS BAL AF OUT**), XLR-3M socket, transformer balanced
- 13 LED (yellow) for network activity indication
- 14 LAN socket (**ETHERNET RJ 45**)
- 15 Type plate
- 16 Antenna input II (**ANT II RF IN**) with booster supply voltage, cannot be switched off, short-circuit proof, BNC socket
- 17 Antenna output II (**ANT II RF OUT**), BNC socket
- 18 Antenna output I (**ANT I RF OUT**) BNC socket
- 19 Antenna input I (**ANT I RF IN**) with booster supply voltage, cannot be switched off, short-circuit proof, BNC socket

## Overview of the displays



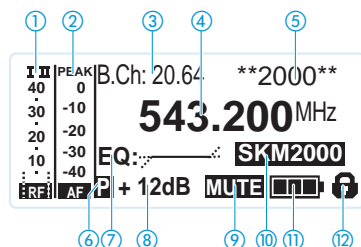

After switch-on, the receiver displays the “Receiver Parameters” standard display. For further illustrations and examples of the different standard displays, please refer to page 16.

This standard display displays the operating states of the receiver and provides the most important information on the received transmitter – provided the transmitter supports this function.



Display	Transmitter/ Receiver	Meaning
① RF level “RF” (Radio Frequency)	Receiver	<p><b>I II</b> Diversity display:  <b>40</b> <b>I II</b> Antenna input I is active  <b>30</b> <b>I II</b> Antenna input II is active  <b>20</b> RF signal level:  <b>10</b> Field strength of the received signal  <b>RF</b> Squelch threshold level</p>
② Audio level “AF” (Audio Frequency, see page 25)	Transmitter	<p><b>PEAK</b> Modulation of the transmitter  <b>0</b> with peak hold function  <b>-10</b> When the display shows full  <b>-20</b> deflection, the audio input level is  <b>-30</b> excessively high. When the trans-  <b>-40</b> mitter is overmodulated frequently  <b>AF</b> or for extended periods of time, the  “PEAK” display is shown inverted.</p>
③ Frequency bank and channel (see page 24)	Receiver	Current frequency bank and channel number
④ Frequency (see page 24)	Receiver	Current receiving frequency
⑤ Name (see page 24)	Receiver	Freely selectable name of the receiver
⑥ Pilot tone “P” (see page 27)	Receiver	Activated pilot tone evaluation
⑦ Equalizer setting (see page 25)	Receiver	Current equalizer setting
⑧ Output gain (see page 25)	Receiver	Current output gain of the audio signal available at the ¼” (6.3 mm) jack socket ① / XLR-3M socket ⑫



Display	Transmitter/ Receiver	Meaning
⑨ Muting function "MUTE" (see page 16)	Receiver/ transmitter	Audio signal is muted (see also page 35)
⑩ Transmitter type	Transmitter	Product name of the linked 2000 series transmitter The product name is displayed only if the linked transmitter supports this function.
⑪ Battery status	Transmitter	Charge status:  approx. 100%  approx. 70%  approx. 30%  battery icon is flashing; charge status is critical  When the charge status is critical, "Low Battery" appears on the standard display.
⑫ Lock mode icon (see page 25)	Receiver	Lock mode is activated

## Putting the receiver into operation

### Setting up the receiver on a flat surface



Do not fit the device feet when mounting the receiver into a 19" rack.

- ▶ Clean the base of the receiver where you want to fix the device feet.
- ▶ Fit the device feet to the four corners of the receiver.
- ▶ Place the receiver on a flat, horizontal surface. Please note that the device feet can leave stains on delicate surfaces.
- ▶ Connect the antennas (see page 9).

### Mounting the receiver into a 19" rack

#### CAUTION!



#### Risks when rack mounting the receiver!

When installing the device in a closed or multi-rack assembly, please consider that, during operation, the ambient temperature, the mechanical loading and the electrical potentials will be different from those of devices which are not mounted into a rack.

- ▶ Make sure that the ambient temperature within the rack does not exceed the permissible temperature limit specified in the specifications.
- ▶ Ensure sufficient ventilation; if necessary, provide additional ventilation.
- ▶ Make sure that the mechanical loading of the rack is even.
- ▶ When connecting to the power supply, observe the information indicated on the type plate. Avoid circuit overloading. If necessary, provide overcurrent protection.
- ▶ When rack mounting, please note that intrinsically harmless leakage currents of the individual mains units may accumulate, thereby exceeding the allowable limit value. As a remedy, ground the rack via an additional ground connection.

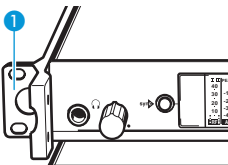

- ▶ Slide the receiver into the 19" rack.
- ▶ Secure the rack mount "ears" ❶ to the rack using four screws (not included in the delivery).
- ▶ Connect the antennas (see next chapter).

### Connecting the antennas

#### CAUTION!

#### Danger of damage to the antennas

To supply an active directional antenna (e.g. A 3700 for the UHF range) or an antenna booster (e.g. AB 3700), a direct voltage (which cannot be switched off) is output via the antenna sockets of the receiver. If you use antennas from other manufacturers, take into account that these must be installed with direct voltage decoupling. The output voltage supply is short circuit-proof, but an active antenna connected to this supply increases the current consumption of the overall device.

**CAUTION!**

**Danger of short-circuit due to uninsulated antennas!**

An 11 V voltage is applied to the antennas – **even when you switch the receiver off!** If uninsulated antennas come into contact with objects which conduct electricity, this voltage can produce sparking and audio interference.

- ▶ Use insulated antennas.

OR

- ▶ Always mount uninsulated antennas so that they cannot come into contact with objects which conduct electricity.

You have the following options:

- For professional use, we recommend connecting remote antennas and, if necessary, using Sennheiser antenna accessories (see next section).
- If the receiver is to be put into operation without a large amount of installation work, you can:
  - connect the supplied rod antennas to the rear of the receiver (see page 10) or
  - use the optional GA 3030 AM antenna front mount kit (see page 11).

**Connecting remote antennas (optional accessories)**

- ▶ Connect two remote antennas to the BNC sockets 16 and 19.

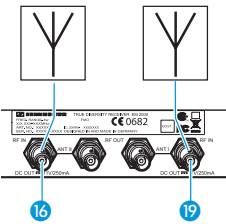

**Positioning the remote antennas**

- ▶ Position antennas in the same room in which the transmission takes place.
- ▶ Keep the distance between the receiving antennas as large as possible.
- ▶ There should be a “free line of sight” between transmitter and receiving antennas.

**Connecting the rod antennas to the rear of the receiver**

- ▶ Connect the rod antennas 25 to the BNC sockets 16 and 19.
- ▶ Align the rod antennas in a V-shape.

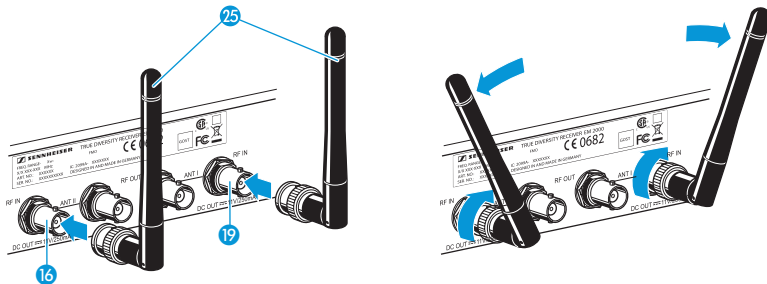

## Mounting the antennas to the front of the rack

To mount the antenna connections to the front of the rack when rack mounting the receiver, you require the GA 3030 AM antenna front mount kit (optional accessory). The GA 3030 AM consists of:

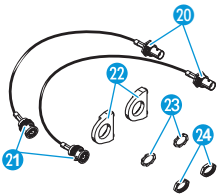

- 2 BNC extension cables (screw-in BNC socket 20 to BNC connector 21),
- 2 antenna holders 22,
- 4 screws,
- 2 washers 23,
- 2 nuts 24.

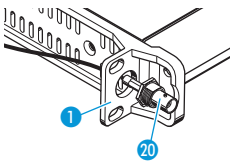
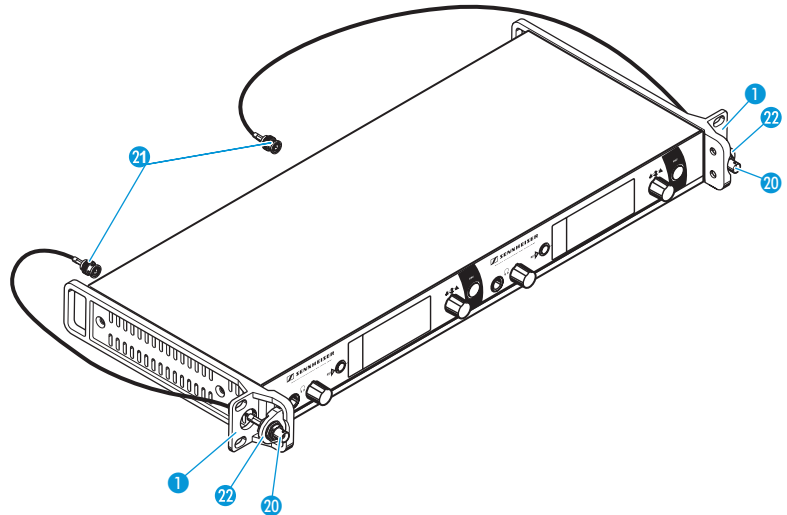

- ▶ Guide the two BNC connectors 21 through the holes in the rack mount "ears" 1.
- ▶ Connect the two BNC connectors 21 to the two BNC sockets 16 and 19.

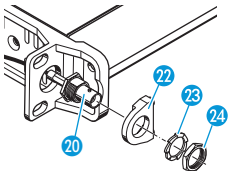

- ▶ Screw the antenna holders 22 to the BNC sockets 20 using the supplied washers 23 and nuts 24.

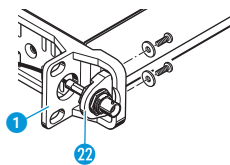

- ▶ Secure the antenna holders 22 to the rack mount "ears" 1 of the receiver using two of the supplied screws respectively.
- ▶ Slide the receiver into the 19" rack.

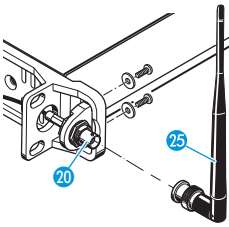

- ▶ Connect the rod antennas 25 to the BNC sockets 20.

### Daisy-chaining receivers

The receivers feature an integrated antenna splitter so that up to 10 receivers can be daisy-chained without any additional antenna splitters being required. Only daisy-chain receivers from the same frequency range (see page 4).

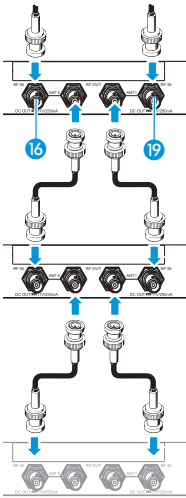

- ▶ Connect the two supplied rod antennas or two remote antennas (optional accessories) to the BNC sockets 16 and 19 of the first receiver.
- ▶ Use BNC cables to daisy-chain the receivers as shown in the diagram on the left.



- To supply an active directional antenna, a direct voltage (which cannot be switched off) is output via the antenna sockets 16 and 19 of the receivers.
- In order to obtain a good reception quality, we recommend not to daisy-chain more than 10 receivers.
- If you set a daisy-chained receiver to **standby mode** (see “Switching the receiver on/off” on page 14), the integrated antenna splitter remains active.

### Connecting an amplifier/mixing console

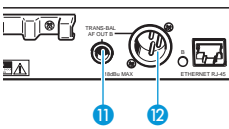

The receiver's XLR-3M socket 12 and the 1/4" (6.3 mm) jack socket 11 are connected in parallel.

- ▶ Use a suitable cable to connect the amplifier and/or the mixing console to the XLR-3M socket 12 and/or the 1/4" (6.3 mm) jack socket 11 (see also page 39).
- ▶ Via the operating menu of the receiver, adjust the audio output level to the input of the amplifier or mixing console (see page 18). The adjusted audio output level is common for both sockets.

### Connecting receivers in a network

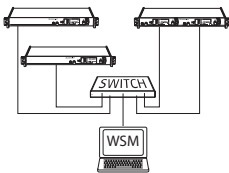

You can connect several receivers in a network. The receivers are remote controlled via a PC running the “Wireless Systems Manager” (WSM) software. This software will assist in the quick and safe configuration of multi-channel systems (see page 31).

- ▶ Use standard network cables (at least Cat 5) to connect the receivers via the LAN socket 14 to an Ethernet switch. Then connect the Ethernet switch to a PC (see diagram). When a receiver is properly connected to the Ethernet switch or the PC, the yellow LED 13 at the rear of the receiver lights up.



The EM 2050 twin receiver has a separate LAN socket 14 for each receiver.

## Connecting the mains cable

### CAUTION!

#### Damage due to electric current!

If you connect the receiver to an unsuitable power supply, this can cause damage to the device.

- ▶ Use the supplied mains cable to connect the receiver to the mains (100 to 240 V AC, 50 or 60 Hz).
- ▶ Ensure a reliable mains ground connection of the receiver – especially when you are using multi-outlet power strips or extension cables.

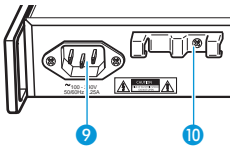

- ▶ Pass the mains cable through the cable grip 10.
- ▶ Connect the mains cable to the mains socket 9.
- ▶ Plug the mains plug into the wall socket.  
The **STANDBY** button 8 is backlit in red.

## Using the receiver

To establish a transmission link, proceed as follows:

1. Switch the receiver on (see next section).
2. Switch the transmitter on (see the instruction manual of the transmitter).  
The transmission link is established and the display backlighting of the receiver changes from red to orange.



It is vital to observe the notes on frequency selection on page 31.

If you cannot establish a transmission link between transmitter and receiver, read the chapter “Synchronizing transmitters with receivers” on page 31.

## Switching the receiver on/off

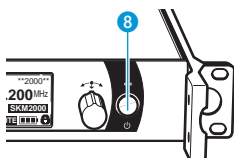

To switch the receiver **on**:



- ▶ Briefly press the **STANDBY** button **8**.  
The receiver switches on and the “Receiver Parameters” standard display appears.

To switch the receiver to **standby mode**:



- ▶ Keep the **STANDBY** button **8** pressed until “OFF” appears on the display panel.  
The receiver switches to standby mode. The integrated antenna splitter and the booster supply voltage remain active so that the antenna signals are still looped through to daisy-chained receivers.



- When in the operating menu, pressing the **STANDBY** button **8** will cancel your entry (ESC function) and return you to the current standard display.
- The **STANDBY** button **8** is backlit in red both during operation and in standby mode.

To **completely** switch the receiver **off**:

- ▶ If necessary, deactivate the lock mode (see page 15).
- ▶ Disconnect the receiver from the mains by unplugging the mains cable plug from the wall socket.  
The backlighting of the **STANDBY** button **8** goes off.

## Monitoring the audio signal via headphones

### CAUTION!



### Danger of hearing damage!

Listening at high volume levels for long periods can lead to permanent hearing defects.

- ▶ Set the headphone volume control **3** to the minimum position.
- ▶ Connect headphones with a 1/4" (6.3 mm) stereo jack plug to the headphone output **2**.
- ▶ Gradually increase the volume and monitor the audio signal with the lowest possible volume.

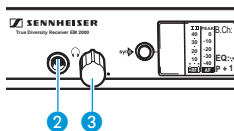

## sync Synchronizing a transmitter with the receiver

You can synchronize a suitable transmitter of the 2000 series with the receiver. By default, the following parameters are transferred to the transmitter during synchronization:

Setting	Transferred parameter
"Frequency Preset"	Currently set frequency
"Name"	Freely selectable name currently set on the receiver
"Pilot Tone"	Current pilot tone setting of the receiver ("Inactive"/"Active")



Via the "Sync Settings" submenu, you can adjust additional parameters to be transferred to the transmitters (see page 29). It is vital to observe the notes on frequency selection on page 31.

To transfer the parameters:

- ▶ Switch the transmitter and the receiver on.
- ▶ Press the **sync** button **4** on the receiver. "Sync" appears on the display panel of the receiver.
- ▶ Place the infra-red interface of the transmitter (see the instruction manual of the transmitter) in front of the infra-red interface **5** of the receiver. The parameters are transferred to the transmitter. When the transfer is completed, "✓" appears on the receiver's display panel. The receiver then switches back to the current standard display.

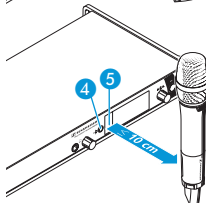
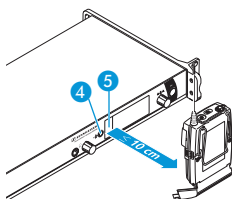

To cancel the transfer:

- ▶ Press the **STANDBY** button **8** on the receiver. "X" appears on the display panel of the receiver. "X" also appears if no suitable transmitter was found.

## Deactivating the lock mode temporarily

You can activate or deactivate the automatic lock mode via the "Auto Lock" menu item (see page 25).

If the lock mode is activated, you have to temporarily deactivate it in order to be able to operate the receiver:

- ▶ Press the jog dial or the **STANDBY** button. "Locked" appears on the standard display.
- ▶ Turn the jog dial. "Unlock?" appears on the display panel.
- ▶ Press the jog dial. The lock mode is temporarily deactivated.
  - When you are in the operating menu, the lock mode remains deactivated until you exit the operating menu.
  - When one of the standard displays is shown, the lock mode is automatically activated after 10 seconds.

The lock mode icon **12** flashes prior to the lock mode being activated again.

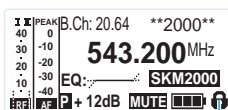



**12**





## Muting the audio signal

To **mute** the audio signal:

-  ▶ When one of the standard displays is shown on the display panel, press the **STANDBY** button.  
"RX Mute On?" appears on the display panel.
-  ▶ Press the jog dial.  
The audio signal is muted. "RX Mute" flashes in alternation with the current standard display. The display panel is backlit in red.

To **unmute** the audio signal:



-  ▶ Press the **STANDBY** button.  
"RX Mute Off?" appears on the display panel.
-  ▶ Press the jog dial.  
The muting is canceled and the display backlighting changes from red to orange again.

If "RX Mute On?" or "RX Mute Off?" appears on the display panel but you do not wish to change the status of the muting function:

-  ▶ Press the **STANDBY** button.  
The status of the muting function remains unchanged and the current standard display appears.

## Selecting a standard display

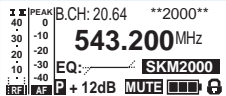
-  ▶ Turn the jog dial to select a standard display:

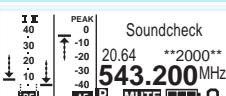
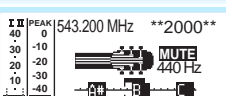
Contents of the display	Selectable standard display
	"Receiver Parameters" appears after switch-on of the receiver and displays the receiver parameters (see page 7)
	"Transmitter Parameters"* (transmitter type/microphone, inverted display) displays the microphone head (SKM only) and the transmitter type
	"Soundcheck" (display with additional function) displays the signal quality within the transmission area (see page 21)
	"Guitar Tuner"* (display with additional function) displays the guitar tuner (see page 21)



\* The reading of the transmitter parameters can take up to 2 minutes. If you synchronize your transmitter with the receiver (see page 15), the parameters are read out without delay.

\*\* The "Guitar Tuner" standard display is deactivated upon delivery. To show this standard display, you have to activate it (see page 27).

## Using the operating menu

A special feature of the Sennheiser 2000 series is the consistent, intuitive menu structure of transmitters and receivers. As a result, adjustments to the settings can be made quickly – even in stressful situations, for example on stage or during a live show or presentation.

### The buttons

Button	Function of the button
Press the <b>STANDBY</b> button 	<ul style="list-style-type: none"> <li>Switches the receiver on and off</li> <li>Cancels the entry and returns to the current standard display (ESC function)</li> <li>Mutes the receiver (special function, see page 16)</li> </ul>
Press the jog dial 	<ul style="list-style-type: none"> <li>Changes from the current standard display to the operating menu</li> <li>Calls up a menu item</li> <li>Enters a submenu</li> <li>Stores the settings and returns to the operating menu</li> </ul>
Turn the jog dial 	<ul style="list-style-type: none"> <li>Selects a standard display (see page 16)</li> <li>Changes to the next/previous menu item</li> <li>Changes the setting of a menu item</li> </ul>

### Overview of the operating menu

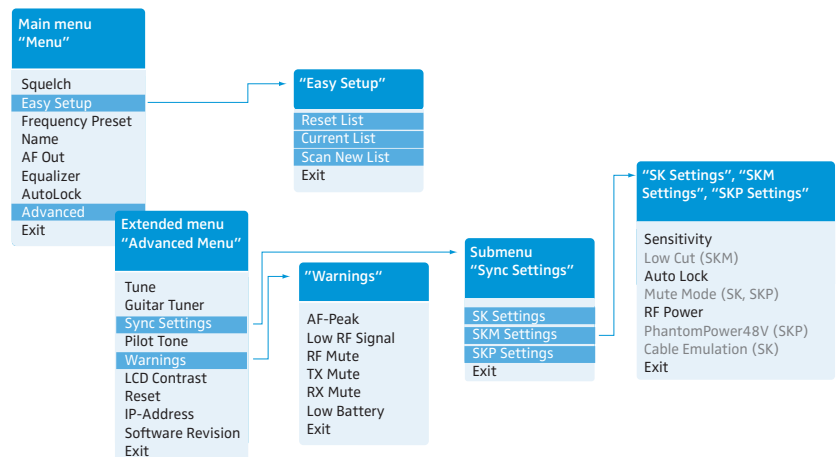

Display	Function of the menu item	Page
<b>Main menu "Menu"</b>		
Squelch	Adjusts the squelch threshold	22
Easy Setup	Scans for unused frequency presets, releases and selects frequency presets	23
Frequency Preset	Sets the frequency bank and the channel	24
Name	Enters a freely selectable name	24
AF Out	Adjusts the audio output level	25
Equalizer	Changes the frequency response of the output signal	25
Auto Lock	Activates/deactivates the automatic lock mode	25
Advanced	Calls up the extended menu "Advanced Menu"	25
Exit	Exits the operating menu and returns to the current standard display	-
<b>"Easy Setup"</b>		
Reset List	Releases all locked frequency presets	
Current List	Selects an unused frequency preset	23
Scan New List	Scans for unused receiving frequencies (frequency preset scan)	
Exit	Exits "Easy Setup" and returns to the main menu	-
<b>Extended menu "Advanced Menu"</b>		
Tune	Sets the receiving frequencies for the frequency banks "U1" to "U6"	26
	Sets the frequency bank, the channel and the receiving frequency (frequency banks "U1" to "U6")	26
Guitar Tuner	Selects the mode of the guitar tuner function	27
Sync Settings	Calls up the "Sync Settings" submenu: Adjusts the parameters to be transferred to the transmitters and activates/ deactivates the transfer (see below)	27
Pilot Tone	Activates/deactivates the pilot tone evaluation	27
Warnings	Calls up "Warnings"	30
LCD Contrast	Adjusts the contrast of the display panel	28
Reset	Resets the settings made in the operating menu	28
IP-Address	Adjusts the IP address of the receiver	28
Software Revision	Displays the current software revision	29
Exit	Exits the extended menu "Advanced Menu" and returns to the main menu	-
<b>"Sync Settings" submenu</b>		
SK Settings	Adjusts the parameters to be transferred to SK transmitters and activates/deactivates the transfer	29
SKM Settings	Adjusts the parameters to be transferred to SKM radio microphone and activates/ deactivates the transfer	
SKP Settings	Adjusts the parameters to be transferred to SKP plug-on transmitter and activates/ deactivates the transfer	
Exit	Exits the "Sync Settings" submenu and returns to the extended menu "Advanced Menu"	

Display	Function of the menu item	Page
---------	---------------------------	------

### “SK Settings” / “SKM Settings” / “SKP Settings”

Sensitivity	Adjusts the input sensitivity	29
Low Cut	Activates/deactivates the low cut filter (“SKM Settings” only)	
Auto Lock	Activates/deactivates the automatic lock mode	
Mute Mode	Sets the mode for the MUTE switch (“SK Settings” and “SKP Settings” only)	
RF Power	Adjusts the transmission power	
PhantomPower48V	Activates/deactivates the phantom powering (“SKP Settings” only)	
Cable Emulation	Emulates guitar cable capacities (“SK Settings” only)	
Exit	Exits the menu item and returns to the “Sync Settings” submenu	

### “Warnings”

Activates/deactivates warnings (color change and warning messages):

AF-Peak	Audio overmodulation	30
Low RF Signal	RF signal is weak	
RF Mute	RF signal is too weak or no RF signal	
TX Mute	<ul style="list-style-type: none"> <li>Transmitter is muted or</li> <li>no pilot tone</li> </ul>	
RX Mute	Receiver is muted	
Low Battery	Charge status of the transmitter battery/the BA 2015 accupack is critical	
Exit	Exits “Warnings” and returns to the extended menu “Advanced Menu”	

## Working with the operating menu



If the lock mode is activated, you have to deactivate it In order to be able to work with the operating menu (see page 15).

By way of example of the “Frequency Preset” menu, this section describes how to use the operating menu.

Menu
Squelch
Easy Setup
Frequency Preset
Name
AF Out
Equalizer
Auto Lock
Advanced
Exit

### Changing from a standard display to the operating menu



- ▶ Press the jog dial.  
The current standard display is replaced by the main menu. The last selected menu item is displayed.

### Selecting a menu item





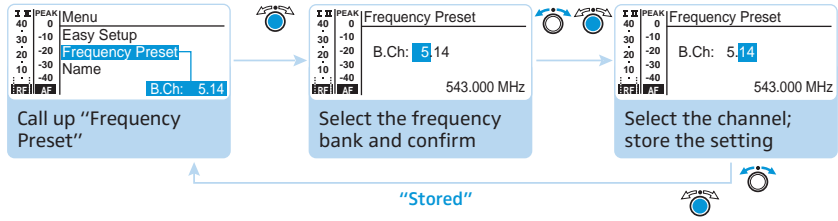

- ▶ Turn the jog dial to change to the “Frequency Preset” menu item.  
The current setting of the selected menu item is displayed:

40	PEAK	Menu
0		Easy Setup
-10		Frequency Preset
-20		Name
-30		B.Ch: 1. 1
-40		
RF	AF	

### Changing and storing settings



-  ▶ Press the jog dial to call up the menu item.
-  ▶ Turn the jog dial to set the frequency bank.
-  ▶ Press the jog dial to confirm your selection.
-  ▶ Turn the jog dial to set the channel.
-  ▶ Press the jog dial to store the setting.



By briefly turning the jog dial to the left or right, the display jumps either forwards or backwards to the next menu item or setting.  
If you turn the jog dial to the left or right and hold it in this position, the display cycles continuously ("fast search" function).

### Canceling an entry



-  ▶ Press the **STANDBY** button to cancel the entry.  
The current standard display appears on the display panel.

To subsequently return to the last edited menu item:

-  ▶ Press the jog dial repeatedly until the last edited menu item appears.

Menu
Squelch
Easy Setup
Frequency Preset
Name
AF Out
Equalizer
Auto Lock
Advanced
Exit

### Exiting a menu item

-  ▶ Change to the "Exit" menu item.
-  ▶ Confirm your selection.  
You return to the next higher menu level.

To directly return to the current standard display:

-  ▶ Press the **STANDBY** button.

## Adjustment tips and functions

The operating menu allows you to make settings for your receiver and your transmitters. The “Guitar Tuner” and “Soundcheck” standard displays provide additional functions and can be called up by turning the jog dial, without having to get into the operating menu.

### Standard displays with additional functions

#### Tuning a guitar (for SK transmitters only)

- ▶ Activate the “Guitar Tuner” standard display via the operating menu (see page 27).
- ▶ Connect a guitar to your SK transmitter.
- ▶ On the receiver, change to the “Guitar Tuner” standard display (see page 16).

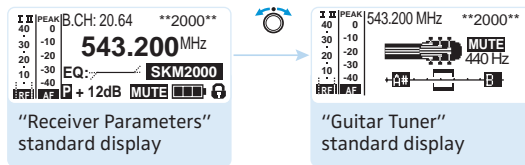

- ▶ Tune your guitar.  
The receiver automatically recognizes the pitch of the plucked string.

#### Doing a soundcheck

By doing a soundcheck, you can check the reception area for field strength gaps (“dropouts”) which cannot be compensated for by the receiver’s diversity circuitry.



The “Soundcheck” standard display must not be activated until later because otherwise the recording will give wrong results.

- ▶ If necessary, change from the “Soundcheck” standard display to one of the other standard displays of your receiver.
- ▶ Position the transmitter in the area in which it is to be used and switch it on.
- ▶ Leave the transmitter switched on and go to your receiver.
- ▶ On the receiver, change to the “Soundcheck” standard display.

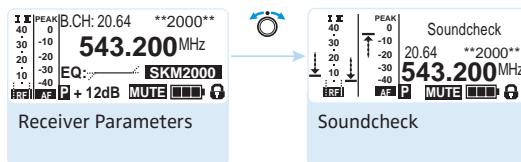

If no transmitter is being received or if the signal is below the squelch threshold level, “MUTE” appears on the display panel (see “If a problem occurs ...” on page 35).

- ▶ Go to your transmitter.
- ▶ With the transmitter, walk up and down the area in which it is to be used.
- ▶ Then leave the transmitter there and do **not** switch it off.

During the soundcheck, the receiver records the RF level and the AF level. The recording result is displayed on the "Soundcheck" standard display:

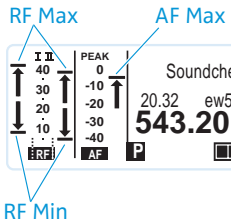

Display	Meaning	What to do ...
RF Min	Min. RF signal level: must be well above the squelch threshold level for one of the two antennas	<ul style="list-style-type: none"> <li>▶ Check if the antennas and the antenna cables are correctly connected.</li> <li>▶ Improve the position of the antennas.</li> </ul>
RF Max	Max. RF signal level: both antennas should reach 40 dB $\mu$ V	<ul style="list-style-type: none"> <li>▶ If necessary, use antenna boosters.</li> </ul>
AF Max	Max. audio level	<ul style="list-style-type: none"> <li>▶ On your transmitter, adjust the audio level as high as possible (max. 0 dB) without the level display for audio level showing full deflection (AF Max is at a level with the PEAK display). For more information, refer to the instruction manual of the transmitter.</li> </ul>

## The main menu "Menu"

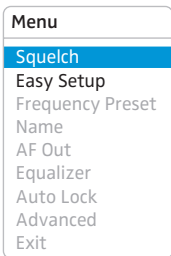

### Adjusting the squelch threshold

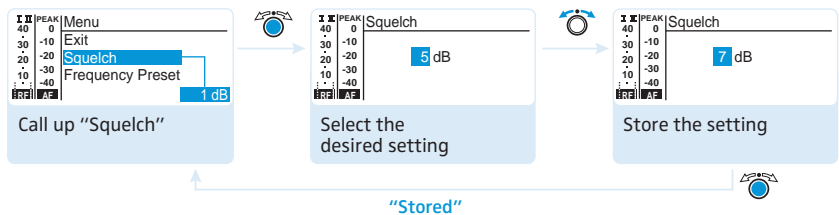

Adjustment range: 5 to 25 dB $\mu$ V, adjustable in 2-dB steps, can be switched off

The squelch eliminates annoying noise when the transmitter is switched off or when there is no longer sufficient transmitter power received by the receiver.

#### CAUTION!



#### Danger of hearing damage and material damage!

If you switch the squelch off or adjust the squelch threshold to a very low value, loud hissing noise can occur in the receiver. The hissing noise can be loud enough to cause hearing damage or overload the loudspeakers of your system!

- ▶ Always make sure that the squelch is switched on.
- ▶ Before adjusting the squelch threshold, set the volume of the headphone output (see page 14) and the audio output level to the minimum ("AF Out", see page 25).
- ▶ Never change the squelch threshold during a live transmission.
- ▶ Adjust the squelch threshold – with the transmitter switched off – to the lowest possible setting that suppresses hissing noise.



If you adjust the squelch threshold to a high value, the transmission range will be reduced under adverse RF reception conditions.

The squelch should only be switched off for servicing purposes. With the squelch threshold set to "5 dB", you switch the squelch off by turning the jog dial to the left and keeping it in this position for 3 seconds.

Display	Squelch is ...
	... switched on The dotted line displays the squelch threshold.
	... switched off. The dotted line goes off and the audio level display "AF" shows full deflection (hissing noise).

If you have accidentally switched off the squelch:

- ▶ Turn the jog dial to the right to switch the squelch on.

Menu
Squelch
<b>Easy Setup</b>
Frequency Preset
Name
AF Out
Equalizer
Auto Lock
Advanced
Exit

### Scanning for, releasing and selecting frequency presets

Menu item	Function of the menu item
Reset List	Releases all locked frequency presets
Current List	Selects an unused frequency preset
Scan New List	Automatically scans for unused receiving frequencies (frequency preset scan)
	If receiving frequencies are used, they will be locked; if receiving frequencies are unused, they will be released. After the frequency preset scan, you can select an unused frequency preset.

If you call up the "Scan New List" menu item, your receiver scans for unused frequency presets. After the scan, the receiver displays a list of the frequency banks and their unused channels. The frequency bank with the largest number of unused channels is automatically selected.

To perform a frequency preset scan:

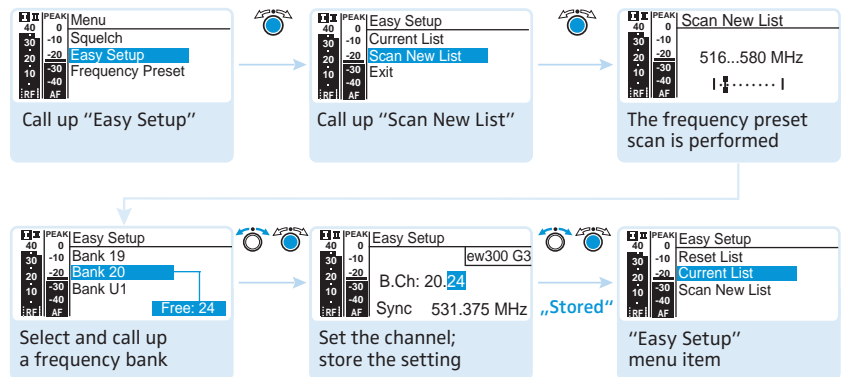

You can call up the list containing the frequency banks again by selecting the "Current List" menu item.



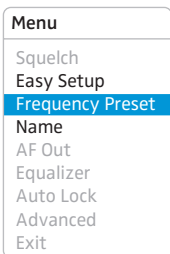

### Selecting the frequency bank and the channel manually

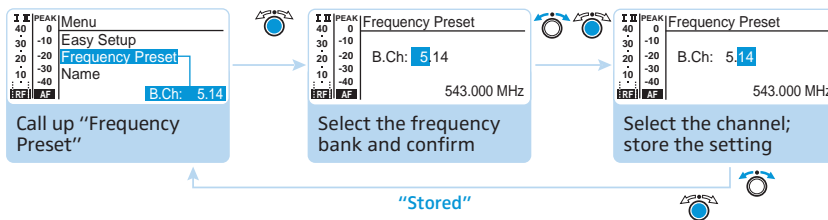

When setting up multi-channel systems, please observe the following:

Only the factory-preset frequencies within one frequency bank ("1" to "20") are intermodulation-free. It is vital to observe the notes on frequency selection on page 31.

Overview of the frequency banks and channels:

Frequency bank	Channels	Type
"1" to "20"	up to 64 per frequency bank	System bank: frequencies are factory-preset
"U1" to "U6"	up to 64 per frequency bank	User bank: frequencies are freely selectable

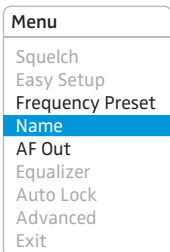

### Entering a name

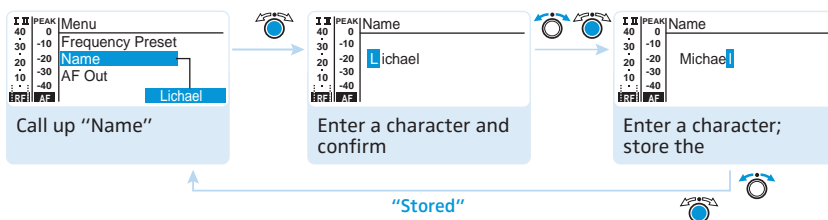

Via the "Name" menu item, you can enter a freely selectable name (e.g. the name of the performer) for the receiver. The name is displayed on the "Receiver Parameters" standard display (see page 16) and can consist of up to eight characters such as:

- letters (without pronunciation marks),
- numbers from 0 to 9,
- special characters and spaces.

To enter a name, proceed as follows:



▶ Turn the jog dial to select a character.



▶ Press the jog dial to change to the next segment/character or to store the complete entry.

Menu
Squelch
Easy Setup
Frequency Preset
Name
<b>AF Out</b>
Equalizer
Auto Lock
Advanced
Exit

## Adjusting the audio output level

Adjustment range:  $-25$  dB to  $+24$  dB, adjustable in 1-dB steps.

Via the “AF Out” menu item, you can adjust the level of the audio output **TRANS BAL AF OUT** from the receiver to the input of the connected device. The following figures are a guide to the best settings:

Connection to ...	Guide values for “AF Out”
... line input	0 to $+18$ dB ( $+24$ dB)
... microphone input	$-25$ dB to $-6$ dB

Gain values greater than  $+18$  dB should only be used when the audio modulation from the transmitter is at a low level, otherwise the audio output of the receiver may become clipped and distorted.





To adjust a gain greater than  $+18$  dB (gain reserve):

- ▶ Adjust a level of  $+18$  dB.
- ▶ Turn the jog dial to the right and keep it in this position for 3 seconds.  
The next higher value ( $+19$  dB) appears.  
The audio output level is increased. Using this gain reserve also increases the headphone output level.

Menu
Squelch
Easy Setup
Frequency Preset
Name
AF Out
<b>Equalizer</b>
Auto Lock
Advanced
Exit

## Using the equalizer

Via the “Equalizer” menu item, you can change the treble and bass of the audio output signal:

“Flat” (output signal remains unchanged)	“Low cut” (cuts the bass)	“Low Cut + High Boost” (cuts the bass and boosts the treble)	“High Boost” (boosts the treble)
			

Menu
Squelch
Easy Setup
Frequency Preset
Name
AF Out
Equalizer
<b>Auto Lock</b>
Advanced
Exit

## Activating/deactivating the automatic lock mode

The lock mode prevents that the receiver is accidentally switched off or programmed during operation.

The lock mode icon  on the current standard display indicates that the lock mode is activated. For information on how to use the lock mode, refer to page 15.

Menu
Squelch
Easy Setup
Frequency Preset
Name
AF Out
Equalizer
Auto Lock
<b>Advanced</b>
Exit

## Calling up the extended menu “Advanced Menu”

To call up the extended menu “Advanced Menu”:

- ▶ From the main menu, select “Advanced”.

## The extended menu "Advanced Menu"

Advanced Menu
Tune
Guitar Tuner
Sync Settings
Pilot Tone
Warnings
LCD Contrast
Factory Reset
IP-Address
Software Revision
Exit

### Setting the receiving frequencies and the frequency banks "U1" to "U6"



When you have selected one of the system banks and then select the "Tune" menu, the receiver automatically switches to channel 1 of the frequency bank "U1". In this case, "U1.1" briefly appears on the display panel.

Upon delivery, the channels of the frequency banks "U1" to "U6" are not assigned a receiving frequency.

Via the "Tune" menu item, you can:

1. set a receiving frequency to be stored in the current channel of the frequency bank ("U1" to "U6")
2. or select a frequency bank ("U1" to "U6") and a channel and assign this channel a receiving frequency.

#### Setting a receiving frequency for the current channel



▶ Turn the jog dial until the "Tune" menu item appears.



▶ Briefly press the jog dial. The frequency selection appears.

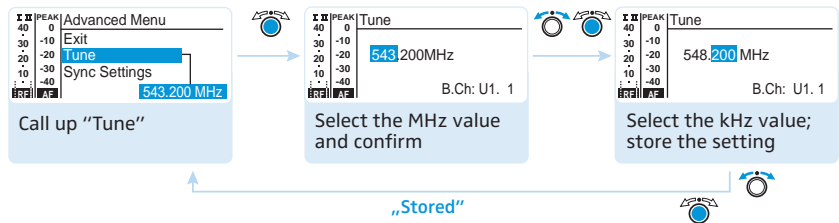

It is vital to observe the notes on frequency selection on page 31.

▶ Set the desired frequency.



▶ Press the jog dial. Your settings are stored. The "Tune" menu item appears.

#### Selecting a frequency bank and a channel and assigning this channel a receiving frequency



▶ Turn the jog dial until the "Tune" menu item appears.



▶ Keep the jog dial pressed until the frequency bank selection appears.

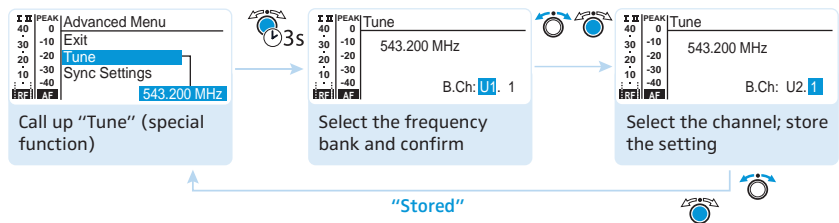

- ▶ Set the desired frequency bank.
- ▶ Set the desired channel.
- ▶ Set the desired frequency.

### Changing the settings of the guitar tuner

Advanced Menu
Tune
<b>Guitar Tuner</b>
Sync Settings
Pilot Tone
Warnings
LCD Contrast
Reset
IP-Address
Software Revision
Exit

The following settings are available:

Setting	Meaning
"Inactive"	The "Guitar Tuner" standard display is deactivated.
"Active"	When selecting the "Guitar Tuner" standard display (see page 16), the receiver is <b>not</b> muted.
"Audio Mute"	When selecting the "Guitar Tuner" standard display (see page 16), the receiver is muted.

Advanced Menu
Tune
Guitar Tuner
<b>Sync Settings</b>
Pilot Tone
Warnings
LCD Contrast
Reset
IP-Address
Software Revision
Exit

### Calling up the "Sync Settings" submenu

To call up the "Sync Settings" submenu (see page 29):

- ▶ From the extended menu "Advanced Menu", select "Sync Settings".

Advanced Menu
Tune
Guitar Tuner
Sync Settings
<b>Pilot Tone</b>
Warnings
LCD Contrast
Reset
IP-Address
Software Revision
Exit

### Activating/deactivating the pilot tone evaluation

The transmitter adds an inaudible signal, known as the pilot tone, to the transmitted signal. The receiver detects and evaluates the pilot tone. The pilot tone supports the receiver's squelch function, thus protecting against interference due to RF signals from other devices.

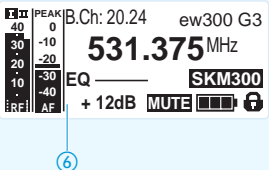
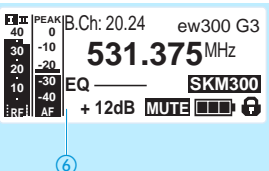
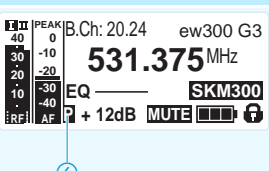
Receiver display	Meaning
	The pilot tone evaluation ⑥ is deactivated.
	The pilot tone evaluation ⑥ is activated.
	The pilot tone evaluation ⑥ is activated and the receiver receives a pilot tone from a transmitter.

**Advanced Menu**

- Tune
- Guitar Tuner
- Sync Settings
- Pilot Tone
- Warnings**
- LCD Contrast
- Reset
- IP-Address
- Software Revision
- Exit

### Calling up "Warnings"

To call up "Warnings" (see page 30):

- ▶ From the extended menu "Advanced Menu", select "Warnings".

**Advanced Menu**

- Tune
- Guitar Tuner
- Sync Settings
- Pilot Tone
- Warnings
- LCD Contrast**
- Reset
- IP-Address
- Software Revision
- Exit

### Adjusting the contrast of the display panel

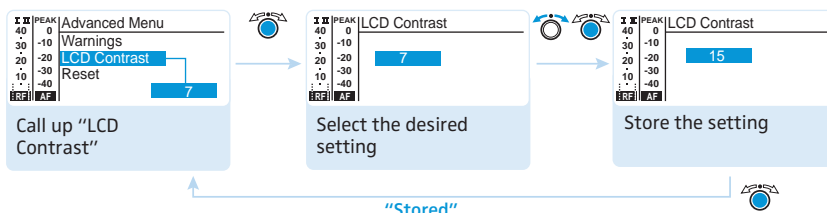

You can adjust the contrast of the display panel in 16 steps.

**Advanced Menu**

- Tune
- Guitar Tuner
- Sync Settings
- Pilot Tone
- Warnings
- LCD Contrast
- Reset**
- IP-Address
- Software Revision
- Exit

### Resetting the settings made in the operating menu

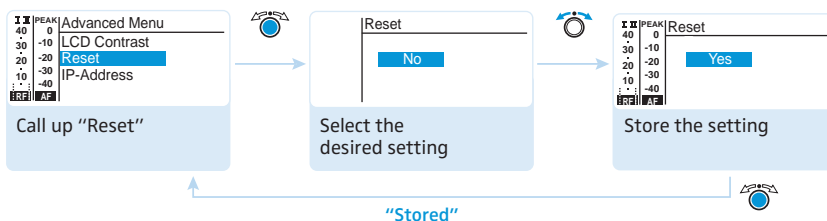

When resetting the settings made in the operating menu, only the selected settings for the pilot tone and for the frequency banks "U1" to "U6" remain unchanged. For an overview of the factory-preset default settings, refer to the enclosed frequency information sheet.

**Advanced Menu**

- Tune
- Guitar Tuner
- Sync Settings
- Pilot Tone
- Warnings
- LCD Contrast
- Reset
- IP-Address**
- Software Revision
- Exit

### Adjusting the network configuration

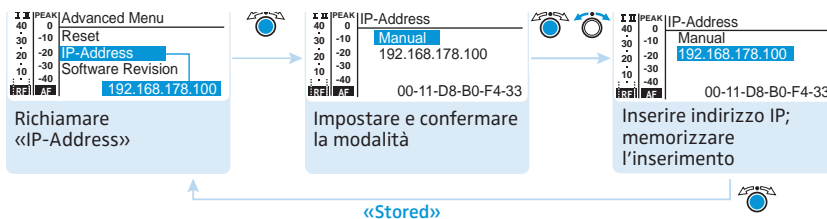

You can either automatically allocate or manually enter an IP address. This menu item also shows the receiver's unique and unchangeable MAC address. In order to ensure safe communication between receivers in multi-channel systems (see page 31), we recommend using automatic allocation of IP addresses.

## Advanced Menu

Tune  
Guitar Tuner  
Sync Settings  
Pilot Tone  
Warnings  
LCD Contrast  
Reset  
IP-Address  
**Software Revision**  
Exit

## Displaying the software revision

You can display the current software revision of the receiver.

- For information on software updates, visit the EM 2000 product page on our website at [www.sennheiser.com](http://www.sennheiser.com).

## The “Sync Settings” submenu

Display	Function
SK Settings	Calls up “SK Settings”
SKM Settings	Calls up “SKM Settings”
SKP Settings	Calls up “SKP Settings”
Exit	Exits the “Sync Settings” submenu and returns to the extended menu “Advanced Menu”

## Sync Settings

SK Settings  
SKM Settings  
**SKP Settings**  
Exit

Via the “SK Settings”, “SKM Settings” and “SKP Settings” menu items, you can set the transmitter parameters directly on the receiver and activate or deactivate the transfer of these parameters to the transmitter:

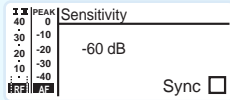
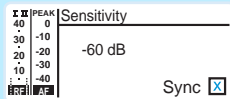
Setting	Transfer is ...
	... activated
	... deactivated







By pressing the **sync** button , you can transfer the parameters to the transmitters via the infra-red interface (see page 15).

Display	Function	Settings
Sensitivity	Adjusts the input sensitivity:	
	SK	-60 dB to 0 dB, adjustable in steps of 3 dB
	SKM and SKP	-48 dB to 0 dB, adjustable in steps of 6 dB
Low Cut (SKM only)	Low cut filter	
Auto Lock	Lock mode	Inactive, Active
Mute Mode (SK, SKP only)	Mute mode	Disabled, RF On/Off, AF On/Off
RF Power	Transmission power	Low, Standard, High
PhantomPower48V (SKP only)	Phantom powering	Inactive, Active
Cable Emulation (SK only)	Emulates guitar cable capacities	Minimum, Low, Medium, High

## Activating/deactivating warning messages – “Warnings”

Warnings
AF Peak
Low RF Signal
RF Mute
TX Mute
<b>RX Mute</b>
Low Battery
Exit

Via the “Warnings” menu item, you can activate or deactivate different warning messages.

Setting	Warning message with color change on the current standard display	Trigger
“AF PEAK”		Audio overmodulation
“Low RF Signal”		RF signal is weak
“RF Mute”		RF signal is too weak or no RF signal
“TX Mute”		Transmitter is muted or no pilot tone
“RX Mute”		Receiver is muted
“Low Battery”		Charge status of the transmitter battery/ the BA 2015 accupack is critical

## Synchronizing transmitters with receivers

When synchronizing a transmitter with a receiver, please observe the following:



- ▶ Only use a transmitter and a receiver from the same frequency range (see the type plates on the transmitter and the receiver).
- ▶ Make sure that the desired frequencies are listed in the enclosed frequency information sheet.
- ▶ Make sure that the desired frequencies are approved and legal in your country and, if necessary, apply for an operating license.

### Synchronizing a transmitter with the receiver – individual operation

Upon delivery, transmitter and receiver are synchronized with each other. If, however, you cannot establish a transmission link between transmitter and receiver, you have to synchronize the channels of the devices:

- ▶ With the receiver, perform a frequency preset scan to scan the frequency banks for unused channels (“Scan New List”, see page 23).

Then “Sync” appears on the display panel of the receiver.

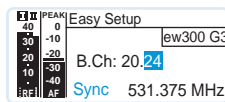

- ▶ Synchronize a transmitter with the receiver via the infra-red interface (see page 15). This establishes a transmission link between the transmitter and the receiver.

Alternatively, you can set the channel on the transmitter manually:

- ▶ Make sure that you set the transmitter to the same frequency bank and the same channel as the receiver.

### Synchronizing transmitters with receivers – multi-channel operation



In order to ensure an intermodulation-free transmission, use the same frequency bank for all transmission links.

#### Network operation

Combined with 2000 series transmitters, 2000 series receivers can form transmission links that can be used in multi-channel systems. In multi-channel operation, the receivers are remote controlled via a PC running the “Wireless Systems Manager” (WSM) software. For further information on downloading the software, visit the ew G3 product page on our website at [www.sennheiser.com](http://www.sennheiser.com).

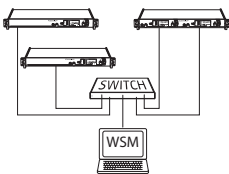

Advantages of controlling the receivers via the “Wireless Systems Manager” (WSM) software:

- Detailed overview of all receiving channels
- Remote control of all receivers in the network
- Combination of receivers of different frequency ranges (see page 4).

- ▶ Connect the receivers in a network (see page 12).



- ▶ Launch the “Wireless Systems Manager” (WSM) software.
- ▶ To scan for unused receiving frequencies and to configure the receivers, proceed as described in the instruction manual of the “Wireless Systems Manager” (WSM) software.
- ▶ Set the corresponding transmitter to the selected frequency bank and to the selected channel either by synchronizing the transmitter with the receiver (see page 15) or by setting the frequency bank and the channel manually (see the instruction manual of the transmitter).  
Your multi-channel system is now set up.

Operation without network

- If you want to set up a multi-channel system without using the WSM, proceed as follows:
- ▶ Switch off all transmitters of your system that are to be automatically configured. Channels used by switched-on transmitters are displayed as “used”.
  - ▶ With one of the receivers, perform a frequency preset scan to scan the frequency banks for unused channels (“Scan New List”, see page 23). Then “Sync” appears on the display panel of the receiver.

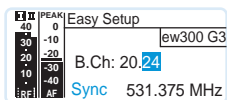

- ▶ Switch one of the transmitters on.
- ▶ Synchronize a transmitter with the receiver via the infra-red interface (see page 15). This establishes a transmission link between the transmitter and the receiver.
- ▶ Repeat for the remaining transmitter and receiver pairs as described above. Leave those transmitters switched on that are already linked to a receiver.  
Your multi-channel system is now set up.

Alternatively, you can set the channel on the transmitter manually:

- ▶ Make sure that you set the transmitter to the same frequency bank and the same channel as the receiver.  
For information on the setting options of the transmitter, refer to the instruction manual of the transmitter.

You can also freely select the receiving frequencies and store these frequencies in the frequency banks “U1” to “U6”.



If you are using frequencies from the frequency banks “U1” to “U6”, it might be that the receiving frequencies are not intermodulation-free.

To ensure that the desired frequencies are intermodulation-free:

- ▶ Contact your Sennheiser partner (see [www.sennheiser.com](http://www.sennheiser.com)).

If you want to use the frequency banks “U1” to “U6”:

- ▶ Set each receiver to the same frequency bank (see page 24).
- ▶ On one of the receivers, select a channel within this frequency bank (see page 24).
- ▶ Assign this channel one of the receiving frequencies (see page 24).
- ▶ Synchronize a transmitter with the receiver (see page 15),  
OR:
- ▶ Manually set the transmitter to the same frequency bank, channel and frequency that you set on the receiver.
- ▶ Repeat for the remaining transmitters and receivers as described above.

## Cleaning the receiver

---

**CAUTION!**

**Liquids can damage the electronics of the receiver!**

Liquids entering the housing of the device can cause a short-circuit and damage the electronics.

- ▶ Keep all liquids away from the receiver.
  - ▶ Do not use any solvents or cleansing agents.
- 
- ▶ Before cleaning, disconnect the receiver from the mains.
  - ▶ Use a cloth to clean the receiver from time to time.

## Recommendations and tips

### ... for optimum reception

- Transmission range depends to a large extent on location and can vary from about 10 m to about 150 m. There should be a "free line of sight" between transmitting and receiving antennas.
- If, with the EM 2000 receiver, reception conditions are unfavourable, you should use two remote antennas which are connected via antenna cable.
- To avoid overloading the receiver, observe a minimum distance of 5 m between transmitting and receiving antennas.
- Observe a minimum distance of 50 cm between receiving antennas and metal objects (such as cross members or reinforced-concrete walls). Align the antennas upwards in a V-shape.

### ... for multi-channel operation

- Each of the frequency banks "1" to "20" accommodates factory-preset receiving frequencies which are intermodulation-free. For possible frequency combinations, please refer to the supplied frequency information sheet.
- The channels in the frequency banks "U1" to "U6" can be assigned freely selectable frequencies (see page 26).
- When using several transmitters simultaneously, interference can be avoided by maintaining a minimum distance of 20 cm between two transmitters.
- Use accessories recommended by Sennheiser for multi-channel applications (see page 37).

## If a problem occurs ...

Problem	Possible cause	Possible solution
Receiver cannot be operated, "Locked" appears on the display panel	Lock mode is activated	Deactivate the lock mode (see page 15).
No operation indication	No mains connection	Check the connections of the mains cable.
No RF signal	Transmitter and receiver are not on the same channel	Set the transmitter and receiver to the same channel. To do so, use the synchronization function (see page 15).
	Transmission range is exceeded	Check the squelch threshold setting (see page 18). Reduce the distance between transmitter and receiving antennas.
RF signal available, no audio signal, "MUTE" appears on the display panel	If "RX Mute" additionally appears on the display panel: receiver is muted	Cancel the muting on the receiver (see page 16).
	If "TX Mute" additionally appears on the display panel: transmitter is muted ("MUTE") or transmitter doesn't transmit a pilot tone	Cancel the muting on the transmitter (see the instruction manual of the transmitter).
		Activate the pilot tone transmission on the transmitter (see the instruction manual of the transmitter).
	Receiver's squelch threshold is adjusted too high	Deactivate the pilot tone evaluation on the receiver (see page 27).
Audio signal has a high level of background noise	Transmitter sensitivity is adjusted too low	Reduce the squelch threshold (see page 18).
		Reposition the antennas.
Audio signal is distorted	Transmitter sensitivity is adjusted too high	Adjust the transmitter sensitivity correctly (see the instruction manual of the transmitter).
	Receiver's audio output level is adjusted too high	Reduce the audio output level (see page 25).
No access to a certain channel	During scanning, an RF signal has been detected on this channel and the channel has been locked	Set the transmitter operating on this channel to a different channel and redo the frequency preset scan (see page 18).
	During scanning, a transmitter of your system operating on this channel has not been switched off	Switch the transmitter off and redo the frequency preset scan (see page 18).

If a problem occurs ...

Problem	Possible cause	Possible solution
None of the diversity displays I or II appears on the display panel	Receiver's squelch threshold is adjusted too high	Reduce the squelch threshold (see page 17).
	Transmitter's RF signal is too weak	Increase the transmission power of the transmitter. Reduce the distance between transmitter and receiving antennas.
During the soundcheck, only one diversity display (I or II) appears on the display panel	One of the antennas is not correctly connected	Check the antenna cables or the antennas.
	Antennas are not optimally positioned	Reposition the antennas.

If a problem occurs that is not listed in the above table or if the problem cannot be solved with the proposed solutions, please contact your local Sennheiser partner for assistance.

To find a Sennheiser partner in your country, search at [www.sennheiser.com](http://www.sennheiser.com) under "Service & Support".

## Accessories

### Cat. No. Accessories

004368 GA 3030 AM antenna front mount kit

### Antennas

502195 A 3700 antenna, active broadband antenna, omni-directional

502197 AD 3700 antenna, active broadband antenna, directional

### Antenna booster

502196 AB 3700 antenna booster

### Cables

087969 Antenna daisy-chain cable, 50  $\Omega$ , BNC, 0.25 m

002324 GZL 1019-A1 coaxial cable, type RG 58, BNC to BNC, 1 m

002325 GZL 1019-A5 coaxial cable, type RG 58, BNC to BNC, 5 m

002326 GZL 1019-A10 coaxial cable, type RG 58, BNC to BNC, 10 m

## Specifications

### RF characteristics

Modulation	wideband FM
Receiving frequency ranges	516–558, 558–626, 626–698, 718–790, 790–865 MHz (Aw to Dw, Gw, see page 4)
Receiving frequencies	up to 3,000 frequencies, tuneable in steps of 25 kHz 20 frequency banks, each with up to 64 factory-preset channels, intermodulation-free 6 frequency banks, each with up to 64 user programmable channels
Switching bandwidth	up to 75 MHz
Nominal/peak deviation	$\pm 24$ kHz/ $\pm 48$ kHz
Receiver principle	true diversity
Sensitivity (with HDX, peak deviation)	$\leq 2$ $\mu$ V for 52 dBA <sub>rms S/N</sub>
Adjacent channel rejection	typ. $\geq 80$ dB
Intermodulation attenuation	typ. $\geq 75$ dB
Blocking	$\geq 80$ dB
Squelch	Off, 5 to 25 dB $\mu$ V in steps of 2 dB
Pilot tone squelch	can be switched off
Antenna inputs	2 BNC sockets with booster supply voltage (11 VdB, 200 mA, cannot be switched off)
Antenna outputs	2 BNC sockets



### AF characteristics

Compander system	Sennheiser HDX
EQ presets	(switchable, affect the line and monitor outputs)
Preset 1: "Flat"	–
Preset 2: "Low Cut"	–3 dB at 200 Hz
Preset 3: "Low Cut/High Boost"	–3 dB at 200 Hz + 5.5 dB at 10 kHz
Preset 4: "High Boost"	+ 5.5 dB at 10 kHz
S/N ratio (1 mV, peak deviation)	$\geq 120$ dBA
THD	$\leq 0.9\%$
AF output voltage (at peak deviation, 1 kHz AF)	¼" (6.3 mm) jack socket (transformer balanced): +12 dBu XLR-3M socket (transformer balanced): +18 dBu
Adjustment range of audio output level	48 dB (in steps of 1 dB), +6 dB gain reserve

### Overall device

Temperature range	–10°C to +55°C
Power supply	100–240 V~
Current consumption	EM 2000: 0.2 A EM 2050: 0.25 A
Dimensions	approx. 217 x 483 x 43 mm
Weight	EM 2000: approx. 2,600 g EM 2050: approx. 2,900 g

### In compliance with

Europe		EMC	EN 301489-1/-9
		Radio	EN 300422-1/-2
		Safety	EN 60065
USA		47 CFR 15 subpart B	

### Approved by

Canada	Industry Canada	RSS 210, IC: 2099A-EM20X0
--------	-----------------	------------------------------

### Connector assignment

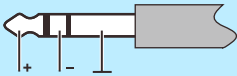
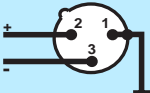
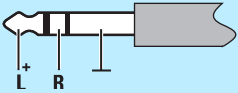
Audio		
1/4" (6.3 mm) stereo jack plug, transformer balanced	XLR-3F connector, transformer balanced	1/4" (6.3 mm) stereo jack plug for headphone output
		



# Manufacturer Declarations

## Warranty

Sennheiser electronic GmbH & Co. KG gives a warranty of 24 months on this product.

For the current warranty conditions, please visit our web site at [www.sennheiser.com](http://www.sennheiser.com) or contact your Sennheiser partner.

## In compliance with the following requirements

- RoHS Directive (2002/95/EC)
- WEEE Directive (2002/96/EC)



Please dispose of the receiver at the end of its operational lifetime by taking it to your local collection point or recycling center for such equipment.

## CE Declaration of Conformity

- CE0682
- R&TTE Directive (1999/5/EC)

The declarations are available at [www.sennheiser.com](http://www.sennheiser.com).

Before putting the device into operation, please observe the respective country-specific regulations.

## Statements regarding FCC and Industry Canada

This device complies with Part 15 of the FCC Rules and with RSS-210 of Industry Canada. Operation is subject to the following two conditions: (1) this device may not cause harmful interference, and (2) this device must accept any interference received, including interference that may cause undesired operation.

This equipment has been tested and found to comply with the limits for a Class B digital device, pursuant to Part 15 of the FCC Rules. These limits are designed to provide reasonable protection against harmful interference in a residential installation. This equipment generates, uses and can radiate radio frequency energy and, if not installed and used in accordance with the instructions, may cause harmful interference to radio communications. However, there is no guarantee that interference will not occur in a particular installation. If this equipment does cause harmful interference to radio or television reception, which can be determined by turning the equipment off and on, the user is encouraged to try to correct the interference by one or more of the following measures:

- Reorient or relocate the receiving antenna.
- Increase the separation between the equipment and receiver.
- Connect the equipment into an outlet on a circuit different from that to which the receiver is connected.
- Consult the dealer or an experienced radio/TV technician for help.

This class B digital device complies with the Canadian ICES-003.

Changes or modifications made to this equipment not expressly approved by Sennheiser electronic Corp. may void the FCC authorization to operate this equipment.

Before putting the device into operation, please observe the respective country-specific regulations!



# Index

## Activating/deactivating

- lock mode (Auto Lock) 25
- pilot tone evaluation (Pilot Tone) 27
- warnings (Warnings) 30

## Adjusting

- audio output level (AF Out) 25
- contrast (LCD Contrast) 28
- network configuration (IP-Address) 28
- squelch threshold (Squelch) 22
- transmitter parameters (Sync Settings) 29

## Advanced Menu (extended menu)

- overview 18
- settings 26

## AF Out (adjusting the audio output level) 25

## AF PEAK (warning message) 30

## Amplifier/mixing console, connecting 12

## Antennas

- connecting 9
- mounting 11

## Audio signal

- monitoring via headphones 14
- muting (Mute) 16

## Auto Lock (activating/deactivating the lock mode) 25

## Buttons (function of the ~) 17

## Channel

- overview 4
- selecting (Easy Setup) 23, 31
- selecting (Frequency Preset) 24
- selecting (Tune) 26

## Cleaning (receiver) 33

## Connecting

- amplifier/mixing console 12
- antennas 9
- headphones 14
- mains cable 13

## Current List (selecting an unused frequency preset) 23

## Daisy-chaining (receiver) 12

## Deactivating (lock mode temporarily) 15

## Displays

- adjusting the contrast (LCD Contrast) 28
- overview 7
- standard displays 16

## Easy Setup

- overview 18
- settings 23

## Equalizer (modifying the frequency response) 25

## Frequency

- preset frequencies 4
- ~ ranges 4
- selecting (Frequency Preset) 24
- selecting ~ presets 24
- setting a Receiving frequency 26

## Frequency bank

- overview 4
- selecting (Easy Setup) 23, 31
- selecting (Frequency Preset) 24
- selecting (Tune) 26
- ~ system 4

## Frequency Preset (selecting a frequency bank/channel) 24

## Frequency presets

- releasing (Reset List) 23
- searching for unused ~ (Scan New List) 23, 31
- selecting (Current List) 23

## Guitar Tuner

- changing the settings 27
- tuning a guitar 21

## Headphones, connecting 14

## Infra-red transmission 15

## IP-Address (adjusting the network configuration) 28

## LCD Contrast (contrast of the display panel) 28

## Lock mode

- activating/deactivating (Auto Lock) 25
- deactivating temporarily 15

## Locked (lock mode activated) 15

## Low Battery (warning message) 30

## Low RF Signal (warning message) 30

## Menu (main menu)

- overview 18
- settings 22

## Mixing console/amplifier, connecting 12

## Mounting

- antennas 11
- receiver 9

## Multi-channel operation 31

- Mute (muting the audio signal) 16
- Muting (audio signal) 16
- Name (entering a name) 24
- Network (connecting receivers in a network) 12, 31
- Network configuration, adjusting 28
- Operating menu, using 19
- Pilot tone (activating/deactivating the pilot tone evaluation) 27
- Receiver
  - cleaning 33
  - connecting ~s in a network 12, 31
  - daisy-chaining 12
  - mounting into a rack 9
  - ~ parameters (standard display) 7
  - placing onto a flat surface 9
  - switching on/off 14
  - synchronizing with transmitter 15, 31
- Receiving frequency
  - selecting (Frequency Preset) 23, 26
  - setting (Tune) 26
- Reception, optimizing 34
- Reset (resetting the settings made in the operating menu) 28
- Reset List (releasing all locked frequency presets) 23
- RF (Radio Frequency) 7
- RF Mute (warning message) 30
- RX Mute (warning message) 30
- RX Mute On/Off (muting the audio signal) 16
- Scan New List (frequency preset scan) 23, 31
- Setting up
  - multi-channel system 31
  - transmission link 31
- Settings
  - equalizer 25
  - guitar Tuner 27
- Software Revision (displaying the software revision) 29
- Squelch (adjusting the squelch) 22
- Switching on/off (receiver) 14
- Sync Settings (submenu)
  - overview 18
  - settings 29
- Synchronizing (transmitter with receiver) 15, 31
- Transmission link, setting up 31
- Transmitter
  - adjusting the transmitter parameters (Sync Settings) 29
  - synchronizing with receiver 15, 31
- Troubleshooting 35
- Tune (setting the receiving frequencies and frequency banks) 26
- TX Mute (warning message) 30
- Unlock (deactivating the lock mode) 15
- Using
  - guitar Tuner 21
  - operating menu 19
  - receiver 14
- Warnings (Warnings)
  - activating/deactivating 30
  - overview of warning messages 30
- WSM (Wireless Systems Manager) 12, 31

Sennheiser electronic GmbH & Co. KG  
Am Labor 1, 30900 Wedemark, Germany  
[www.sennheiser.com](http://www.sennheiser.com)

Printed in Germany  
Publ. 01/09  
529666/A01