

## Colette Modular System

## Colette Modular System

### *MK --*

*Microphone Capsules*

### *CMC --*

*Microphone Amplifiers*

#### *Table of Contents*

	<i>page</i>
<i>System Overview</i>	2
<i>CMC -- Microphone Amplifiers</i>	3
<i>Phantom Powering</i>	5
<i>Technical Specifications</i>	7
<i>Notes on Electromagnetic Compatibility</i>	7
<i>Block Diagram</i>	8
<i>MK -- Microphone Capsules</i>	9
<i>Capsule Selection</i>	9
<i>Attaching a Capsule</i>	9
<i>Basic Characteristics of Transducers</i>	10
<i>Suggested Capsules for Specific Applications</i>	11
<i>Pressure Transducers</i>	12
<i>Boundary Layer Microphones</i>	13
<i>Pressure Gradient Transducers</i>	14
<i>Specifications for Complete Microphones</i>	21
<i>Care and Maintenance</i>	22
<i>Possible Problems</i>	22
<i>Warranty</i>	24

## *User Guide*

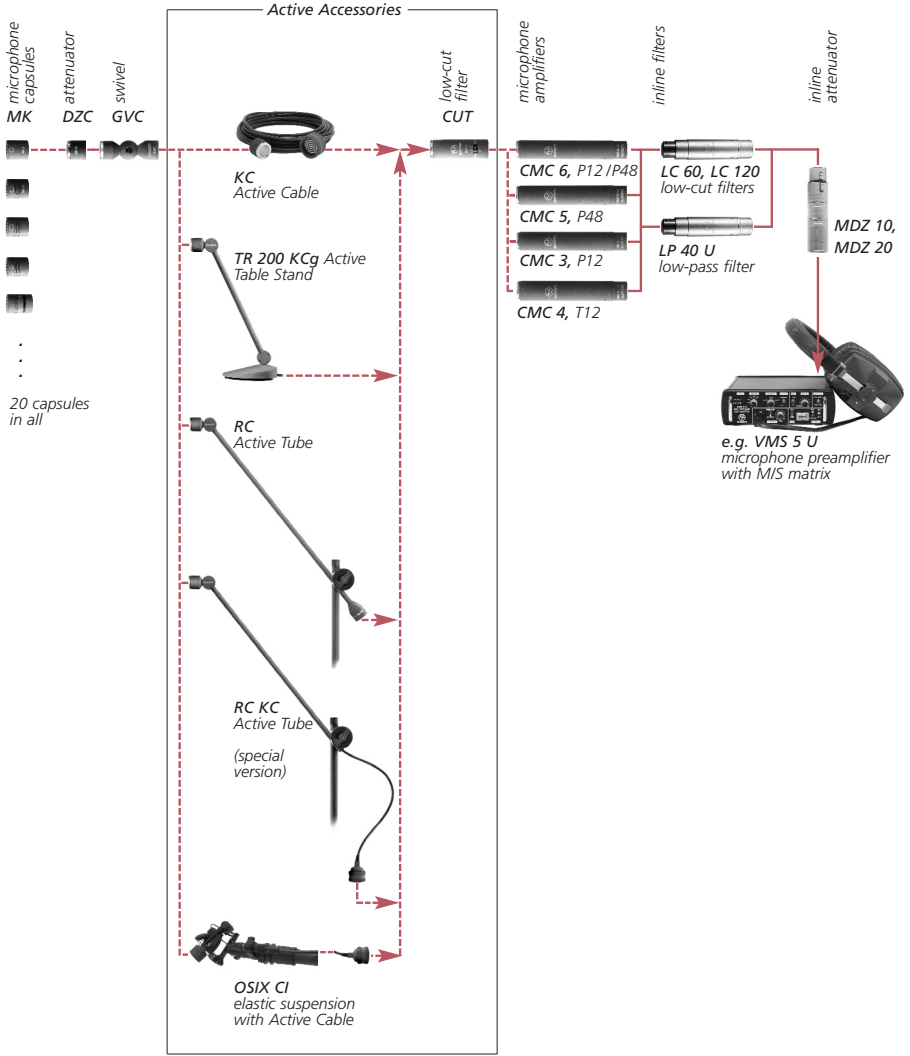

**Signal:**  
balanced —————  
unbalanced - - - - -

*Dear customer:*

Thank you for choosing SCHOEPS CMC ("Colette") Series microphones. This is the most extensive and diverse modular microphone system in the world, offering the highest possible professional sound quality in an extremely wide range of practical configurations. A system overview is shown on page 2.

*Colette Modular System*

A condenser microphone is formed by the combination of two main components: a capsule and a microphone amplifier:



The capsule is the component which converts sound waves into a varying electrical voltage. It determines the directionality and, for the most part, the sound quality of the microphone. The amplifier is the other main component, with the circuitry needed to accept external powering, polarize (charge) the capacitive capsule, obtain the audio signal from it, and convert that signal to one which is balanced and low-impedance.

Microphones of the Colette Series are modular: Any type of CMC microphone amplifier can be used with any type of Colette capsule. Approximately 20 different capsule types (MK --) are available for wide-ranging applications, and several types of amplifier (CMC --) are available for various powering and connection schemes.

In addition, the practical value of a Colette Series microphone is greatly enhanced by Colette "Active Accessories" – special goose-necks, ultra-thin cables or narrow extension tubes which allow the capsule to be separated some distance from its amplifier and placed unobtrusively, as if it were a miniature microphone. Colette Active Cables are often used to help conceal microphones for film and video production, while Colette Active Extension Tubes have become a mainstay of concert

amplification, recording and broadcasting. The active circuitry in these accessories converts the audio signal to lower impedance directly at the capsule, so that there is no loss of sound quality:



In the following pages you will find technical information, application hints and advice concerning the care and maintenance of these microphones. We begin by considering the CMC amplifier and how to power and connect SCHOEPS condenser microphones; the second part of this manual concerns the capsules of the Colette Series. For information on accessories (including Active Accessories), please see our main catalog or visit [www.schoeps.de](http://www.schoeps.de).

*CMC -- Microphone Amplifiers*

...are distinguished by:

- flat frequency response
- low noise and distortion
- balanced, symmetrical, very low-impedance output
- ability to be used with very long cables (e.g. several hundred meters)
- versions for various powering schemes

Several standard versions are available. All feature a symmetrical, class-A output stage which uses neither coupling condensers nor an output transformer. This leads to a low output impedance, insensitivity to electrical interference, low distortion and light weight.

CMC amplifiers are electrically active components which require operating current. This will most often be supplied by the inputs of a mixer, preamplifier (such as the SCHOEPS VMS 5U shown on page 2) or recorder that has suitable microphone powering built in. Otherwise, a stand-alone microphone power supply of proper type can be used.

*Standard Versions*

Four standard models of CMC amplifier are offered to fit the specific type(s) of microphone

powering which the user expects to encounter. Variants of these types are also available, offering different output levels and/or extended frequency range. Each amplifier works only with the specific type and voltage(s) of powering for which it is designed.

**Please note:** The two amplifiers in a stereo pair of CMC microphones should be of the same type. For critical applications, pairs of capsules can be selected at the factory for precisely matched sensitivity and frequency response. (A small extra fee is charged for this service.)

Most modern, solid-state professional microphones use a standardized powering scheme known as "phantom powering," and most recording equipment offers a 48-Volt supply for such microphones. Some equipment, however, provides a 12-Volt supply for phantom powering, or can be readily modified to provide such a supply. The SCHOEPS CMC 6 amplifier series can work with either voltage, switching its circuitry automatically to the corresponding mode of operation. It maintains the same level of performance in either mode, while drawing only the necessary amount of current from the phantom supply.

Note that the CMC 6 is designed to work with standard 12-Volt or standard 48-Volt phantom powering, but it is not a "12-to-48 Volt" microphone. Any input to which it is connected must implement one of those two standard phantom powering methods. Not only must the supply voltage meet the standard; the resistors must be correct as well.

For applications in which it is certain that only 48-Volt or only 12-Volt phantom powering will be used, the CMC 5 and CMC 3 (respectively) remain available at slightly lower cost. The CMC 6 offers greater flexibility in powering as well as superior immunity to radio-frequency interference; it is also the only amplifier model which can be delivered in the special "xt" version (see description under "Special Versions" below).

From an audio standpoint, the most significant difference between the CMC 6 and the CMC 3 or 5 is the response at the very lowest audio frequencies: The standard version of the

CMC 6 has a 12 dB/octave rolloff below 20 Hz as a protection against infrasonics, while the standard version of the CMC 3 or 5 has a 6 dB/octave rolloff below 30 Hz. Any CMC amplifier can be specially ordered, or modified after delivery, for any desired rolloff frequency within reason; please see the description of the CMC "linear" version for further details.

In general if a 48-Volt microphone is connected to 12-Volt phantom powering, no damage will occur but the microphone will not work properly. On the other hand a CMC 3 could be powered safely and effectively by a 48-Volt phantom supply if it can provide 11 mA per microphone. But that current exceeds what is required for standard 48-Volt phantom powering, and unfortunately many existing supplies do not even meet the standard. Therefore this mode of operation should not normally be relied upon.

In the realm of film and video sound an older system called "parallel powering" or "T" powering ("Tonaderspeisung") at  $12 \pm 1$  Volts is sometimes still used, particularly with Nagra tape recorders; the CMC 4 amplifier model works with that system. See Fig. 3, p. 6 for a schematic diagram; since this method of powering has been in decline for some time now, it is not described in detail in this manual. Please contact your SCHOEPS dealer or SCHOEPS GmbH with any questions concerning its use.

### Special Versions

#### CMC 6 U"xt" – the 40 kHz version

This variant is indicated by the letters "xt" engraved on the output socket. When an "xt" amplifier is used with any axially-addressed Colette capsule, the response range of the microphone will extend beyond 40 kHz. The response above 10 kHz will also be elevated slightly. Specific frequency response curves can be seen in our main catalog or on our Web site, [www.schoeps.de](http://www.schoeps.de).

#### CMC "+5 dB"

The sensitivity of a microphone with this amplifier variant is 5 dB above the normal type, while the equivalent noise level is somewhat

greater. The increased output levels can help to raise a microphone's signal above the input noise level of the equipment to which it is connected, especially when sound levels are low to moderate. However, the overload limit of that equipment, and of the microphone itself, will also be reached 5 dB sooner.

#### CMC "linear"

CMC microphone amplifiers normally have a rolloff in response below 30 Hz (20 Hz in the CMC 6) to guard against infrasonic disturbances from various sources such as vibration and air motion. However, when using pressure (omnidirectional) transducers, particularly with digital recording, it can be desirable to pick up frequencies even lower than 20 - 30 Hz. The special technology of the CMC microphone amplifiers makes this possible; on request we can deliver microphone amplifiers with response extending as low as 3 Hz.

For live recording, however, some caution is advised with respect to infrasonics. Since pressure transducers can pick up very low frequencies, ventilation systems in large spaces (churches, concert halls) or traffic rumble can create a problem. With pressure gradient transducers the risk is even greater. They are far less sensitive to very low frequency sound, but respond much more strongly to low-frequency mechanical stimuli such as air currents and solid-borne noise. Such signals may be below the audible range, but they can overload pre-amp inputs, particularly those that have undersized input transformers.

#### Phantom Powering (DIN EN 61938)

(formerly DIN 45 596)

"Phantom" powering is a standard method of providing the operating current for a microphone's circuitry through ordinary two-conductor shielded cable. Precisely equal DC flows in both modulation leads, making it "invisible" and harmless to most balanced microphones that don't require such powering (e.g. most dynamic microphones, including ribbons). Exceptions are quite rare. The only likely cases in which standard phantom powering will en-

danger a balanced microphone (e.g. a ribbon) are if a microphone cable, connector or adapter is defective or wired in a non-standard way, such that one modulation lead of the microphone is shorted to ground at DC while the powering is on. If a microphone is connected to such a cable with the powering turned on, impulse current will flow through its coil or ribbon, possibly causing damage.

Fig. 1 shows the only valid 48 V and 12 V phantom powering circuit (abbreviations: P48 and P12) that can be realized with resistors as opposed to a center-tapped input transformer. This illustration is based on the international standard document EN 61938, ratified in 1997. Our microphones are developed and tested with power supplies that conform to the requirements of this standard. Proper operation with non-standard power supplies cannot be guaranteed. Circuit arrangements that deviate from the standard can cause operational problems (i.e. distortion or even gaps in the signal), particularly at high sound pressure levels or in the presence of strong wind noise. Such problems may often seem to defy analysis until their real cause is discovered.

The permissible tolerance of the feed resistor values as such is  $\pm 20\%$ . However, the difference between the resistors of any one pair should be less than 0.4% (i.e. 27 Ohms for 48-Volt phantom powering with 6.8 kOhm). This close matching is necessary to maintain adequate common mode rejection. It will also prevent significant DC from flowing through the primary of the input transformer (if one is present) and causing distortion or reduced dynamic range.

A microphone designed for 48-Volt phantom powering could draw as much as 10 mA according to the standard. A SCHOEPS CMC 5 or CMC 6 will draw about 4 mA even when Active Accessories are used; this falls well within the limit set by the prevailing standard. There are certain commercially available power supplies, preamplifiers, and mixing desks – mostly older, but some more recent – which fail to meet this standard and hence may not be able to power SCHOEPS microphones adequately. Where doubt exists, equipment should

**Fig. 1**  
Input with transformer  
(or balanced, floating transformerless input)

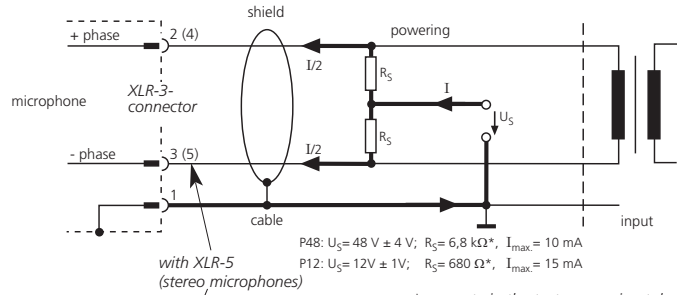

\* see note in the text concerning tolerances

**Fig. 2**  
To add phantom powering to a balanced, grounded, transformerless input, capacitors must be inserted into the signal lines and polarization resistors provided as shown.

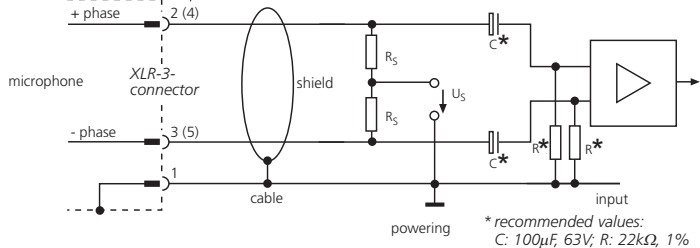

\* recommended values:  
C: 100µF, 63V; R: 22kΩ, 1%

**Fig. 3**  
Parallel powering;  
with parallel powering there is low-impedance DC across pins 2 and 3. This can damage dynamic microphones, especially ribbons.

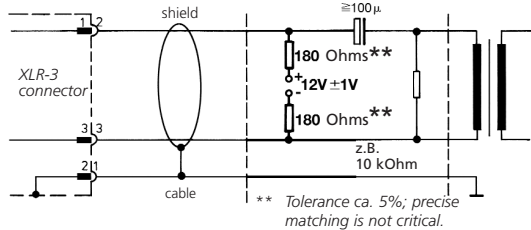

\*\* Tolerance ca. 5%; precise matching is not critical.

be checked to verify its suitability for professional work with SCHOEPS microphones. On page 8 a method is described for checking a phantom supply quickly and easily.

For P12 the standard allows a current of 15 mA. A SCHOEPS CMC 3 will draw 11 mA while a CMC 6 needs 8 mA at 12 Volts.

Fig. 2 shows a balanced but grounded amplifier input. In this case either a transformer (see fig. 1) or additional capacitors have to be inserted in the audio line.

**Unbalanced Operation**

Unbalanced operation of CMC microphone amplifiers is not recommended; both noise and vulnerability to interference will be increased.

If possible, an unbalanced input should be balanced with a high-quality microphone input transformer. That will also allow the signal leads from the microphone to be balanced, for best rejection of interference.

If such an arrangement is not possible, however, a CMC microphone may be operated in unbalanced mode by taking the signal from pin 2 via a coupling condenser with a value as shown in Figure 2 above. The signal from pin 3 must be left unconnected; do not short it to ground. This "unbalancing act" must occur between the power supply and the preamplifier input, however, since naturally all three pins of the microphone must still connect to its phantom or parallel power supply.

Amplifier type	Powering	Current consumption	Impedance	Low-cut frequency (-3 dB)
CMC 6U / 6Uxt:	12 V phantom	8 mA	25 Ohms	20 Hz
	48 V phantom (automatic switchover)	4 mA	35 Ohms	20 Hz
CMC 5U:	48 V phantom	4 mA	35 Ohms	30 Hz
CMC 3U:	12 V phantom	11 mA	20 Ohms	30 Hz
CMC 4U:	12 V parallel	9 mA	13 Ohms	30 Hz

Polarity: Increasing sound pressure on the microphone's 0° axis produces a positive-going voltage at pin 2.

Maximum output voltage: 1 V (at 1 kHz and 1 kOhm load resistance)

Minimum recommended load resistance: 600 Ohms (A load resistance below this value will particularly reduce the maximum output level.)

The other technical specifications depend on the choice of capsule – see page 12 ff.

Length: 116 mm (incl. 3 mm capsule thread)

Diameter: 20 mm

Weight: 65 – 68 g, depending on type

Surface finish: matte gray (g) or nickel (ni)

#### *Simultaneous Connection to Multiple Inputs*

If one microphone must be connected to multiple inputs simultaneously, an active microphone splitter should be used in order to preserve the loading and powering conditions for the microphone, and to prevent interference.

#### *Maximum Cable Length*

Cable lengths of several hundred meters are possible; Colette Series microphones are sometimes used with cables as long as 500 m (over 1/4 mile!). But the practical limit depends on the electrical capacitance of the cable, which is sometimes an unknown quantity. The lower this capacitance is per unit length, the longer the cable can be. All SCHOEPS cables have very low capacitance (100 pF/m between the conductors).

The main risks with excessively long microphone cables are losses at high frequencies due to cable capacitance, reduced ability to handle very high sound pressure levels, and increased likelihood of picking up interference.

#### *Notes on Electromagnetic Compatibility*

SCHOEPS CMC microphone amplifiers are virtually immune to magnetic, electric and

electromagnetic fields. This is particularly true for CMC 6 amplifiers made since 2004; they can be recognized by the gold-colored shield plate in their output connector.

Due to the wide dynamic range of studio microphones, the smallest signal amplitudes are in the microvolt (1/1,000,000 Volt) range. Cable shielding and the grounding scheme of the preamp or mixer input are also crucial. Thus no microphone can ever be immune to all possible disturbances under all circumstances. But the following suggestions can help to reduce the likelihood of picking up noise:

- 1) Keep both the microphone and the cable away from sources of interference such as monitors, digital equipment (computers), RF emitters (mobile phones), power transformers, power lines, SCR dimmers, switching power supplies etc.
- 2) Use only high-quality cables with a high degree of shield coverage.
- 3) Keep all cables as short as possible.
- 4) Dress audio cables away from power cables. If they must cross, it should be at right angles.
- 5) At the preamp or mixer input, the shield of the microphone cable should connect to chassis ground in the shortest way possible. If necessary, this coupling can be capacitive.

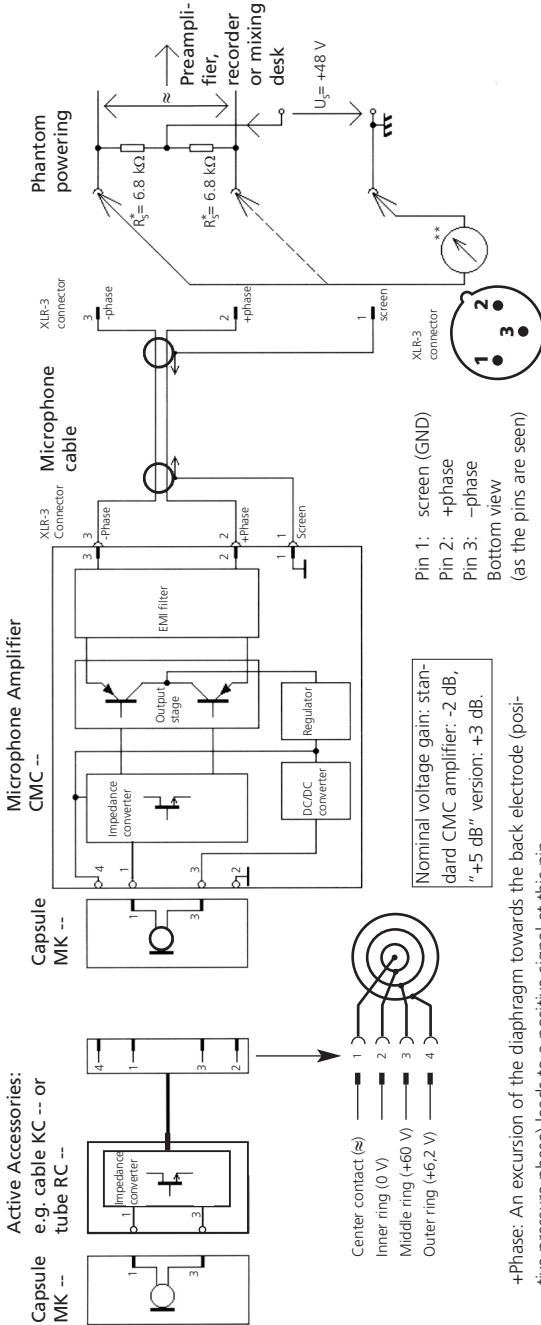

+Phase: An excursion of the diaphragm towards the back electrode (positive pressure phase) leads to a positive signal at this pin.

\*matched pair, see page 5

\*\* Here are three simple methods for verifying correct phantom powering. These measurements should be made at an unused input. Reduce the channel gain to protect loudspeakers, etc. If microphones are connected to other inputs at the same time, no substantial difference should occur in the results.

1. Measure the open-circuit voltage between ground (pin 1) and either pin 2 or pin 3 of the XLR input. Given the permitted tolerances, this voltage should be between 44 and 52 VDC for P48, and between 11 and 13 VDC for P12. Then, measure the short-circuit current between ground (pin 1) and either pin 2 or pin 3 of the XLR input. Given the permitted tolerances, this current should be between 5.9 and 8.5 mA DC for P48, and between 15 and 21 mA DC for P12.

Note: Well-designed phantom power supplies must tolerate at least a temporary short circuit without damage; an unbalanced connection (which is occasionally necessary) would cause the same current to be drawn. To be safe, however, don't leave the short circuit in place longer than necessary.

- 2) Measure the DC voltages on the modulation leads with a microphone connected, e.g. by opening the connector shell of the cable. The two voltages (from pin 2 and pin 3 to pin 1) must be identical. With a CMC 5 or CMC 6 and a 48-Volt supply, they should be about 34 Volts (minimum = 30 Volts). For P12 this is 8.3 Volts (minimum 7.3 Volts) with a CMC 3, and 9 Volts (minimum 8 Volts) with a CMC 6.
- 3) For P48, use a SCHOEPS PHS 48 tester. Plug it in to the XLR input socket; if the LED glows and stays lit, all is well.



**MK -- Microphone Capsules**

**Which is the Best Capsule for ... ?**

Only in rare cases can "the" correct microphone be chosen unequivocally. The recording location, the positions of sound sources and the microphone, the atmosphere of the music or other program material and the desired effect must all be considered. Any absolute prescriptions would thus be of limited value at best. However, we would like to offer some ideas to guide the choice that must be made.

**Our Recommendations**

The most commonly used pattern for medium-distance pickup is the cardioid (MK 4 or MK 4V). However, there may be good reasons to make a different choice. Some examples:

- Greater directivity may be required, either for the sake of a "drier" recording or to suppress sound from adjacent instruments. In this case we recommend the supercardioid MK 41 (as long as no nearby sound source or P.A. loudspeaker is directly behind the microphone's rear lobe).
- For a broader pickup pattern, with very natural sound quality for sound arriving at the sides of the microphone and more extended low-frequency response, we recommend the MK 21 wide cardioid.
- For essentially perfect pickup of low-frequency information and room sound, we recommend the omnidirectional MK 2H or MK 2S (for moderate miking distances).
- When using directional microphones with very close placement, proximity effect must be compensated with a bass rolloff. This is especially true when miking instruments. For voice, try the MK 4S or MK 4VXS. For instruments the omnidirectional MK 2 may be of interest (no proximity effect, low sensitivity to "popping" or solid-borne noise); for grand piano, the BLM 03 C.
- For very distant miking and/or as an "ambience" microphone, with essentially perfect bass response: omni MK 3.

- For outdoor recording if directivity is not required (e.g. close miking), the omni MK 2S with windscreen W 5 or W 5 D will offer low sensitivity to wind, "popping" and handling noise.  
If high directivity is required outdoors, the MK 41 can be used with the W 5 D, W 20 R1 or WSR MS "basket"-type windscreens with built-in elastic suspension for mono or stereo.

**Attaching a Capsule or An Active Accessory**

MK -- capsules are interchangeable and can be screwed onto any CMC -- amplifier or Active Accessory (see System Overview, page 2). To avoid damaging the threads, please proceed as follows:

Place the capsule against the front end of the microphone amplifier.



Now turn the capsule first counter-clockwise (not pressing the parts together) until you feel a gentle "click":



You are then at the beginning of the thread, and can attach the capsule or accessory to the microphone amplifier with normal clockwise rotation:



(The engraved markings on the capsule may not always line up as shown with those on the amplifier.)

If you are using an Active Accessory, attach it to the microphone amplifier in a similar manner.

All the wide variety of SCHOEPS capsules, without exception, are single-diaphragm electrostatic transducers. They fall into two general categories: pressure transducers and pressure gradient transducers. Many of our capsules combine the two principles of operation in various proportions, yielding patterns from wide cardioid through supercardioid; these capsules are classed as pressure gradient transducers by convention.

Unlike dual-membrane capsules, our switchable capsule offers flat low-frequency response, low sensitivity to wind and solid-borne noise, and no proximity effect in its omnidirectional setting. In its cardioid setting it maintains its directional pattern to the lowest frequencies, which dual-diaphragm capsules do not do.

The following table lists the basic characteristics of these two general types.

### Characteristics of the Two Basic Transducer Types

	<b>Pressure Transducers (omnis)</b> MK 2, 2H, 2S, 3, BLM 3, BLM 03C MK 5 in the "omni" position	<b>Pressure Gradient Transducers</b> MK 21, 21H, 22, 4, 4V, 41, 41V, 8 MK 5 in the "cardioid" position, MK 4S, 40, 4A, 4VXS, 41S
<b>Frequency response:</b>	Essentially flat, with perfect reproduction of low frequencies. The on-axis response of the free-field capsule does not have a high-frequency emphasis but the capsule meant for the reverberant sound field does.	Reduced sensitivity (rolloff) at lower frequencies, which can be compensated by close placement to the sound source (proximity effect)
<b>Directional pattern:</b>	Omnidirectional pattern in its ideal form at low and middle frequencies. At very high frequencies there is increasing directivity. For this reason even omnidirectional microphones are aimed toward the sound source.	Types: wide cardioid, Open Cardioid, cardioid, supercardioid (hypercardioid), bidirectional (figure-8). The frequency response of our figure-8 is nearly the same in all directions; the wide cardioid capsule has this advantage also.
<b>Near field behavior:</b>	No proximity effect	Proximity effect: Elevation of the low and low-mid frequencies as working distance decreases (quite noticeable at less than 50 cm)
<b>Sensitivity to vibration, wind and popping:</b>	Very little; simple foam-type wind-screens are usually sufficient.	Possibly considerable; shock mounts and more elaborate windscreens may be necessary.

SCHOEPS "Colette" Series capsules (MK --) can be used interchangeably on all CMC-series amplifiers. They can also be used with three special-purpose amplifier types: the CMBI (powered by internal battery, with unbalanced output), the VST 62 IU (two-channel, balanced, phantom-powered) and the M 222 (modern, transformerless vacuum-tube circuitry). The operating requirements and range of accessories for these amplifiers vary; for detailed information please see the main catalog or [www.schoeps.de](http://www.schoeps.de).

	Applications:	Recommendations:
Speech / Speakers	On a lectern	MK 4 (cardioid) with close-speech guard B 5 D
	Conference recording	MK 4 (cardioid) with close-speech guard B 5 D
	TV speaker's table	MK 4 (cardioid), no popscreen required at distances greater than 0.5 m
	Radio announcer	MK 4V (cardioid with lateral pickup) with pop filter PR 120 SV
	Noisy environments	(super-)cardioid for close pickup (10 – 20 cm) with bass rolloff: MK 4S, MK 40, MK 41S
	TV "round table" discussion Church	MK 4 (cardioid) or boundary layer capsule BLM 03 Cg (hemisphere) MK 40 (cardioid) (perhaps as boundary layer microphone with BLC), or BLM 03 C
Vocals	Stage	radio microphone type HXiR (AUDIO Ltd.) with MK 4 (cardioid) and B 5 D popscreen or MK 2S (omni)
	News reporting	MK 5 (omni / cardioid, switchable) with windscreen B 5 D or W 5 D or W 20 R1 (use the omni setting if there is strong wind)
	Stage (movable)	radio microphone HXiR (AUDIO Ltd.) with MK 4 (cardioid) or MK 2S (omni) and popscreen B 5 D
Instruments	Stage (fixed)	MK 4 (cardioid) on RC Active Tube with windscreen B 5 D, vocalist microphone CMH 64 (cardioid)
	Studio	MK 4, MK 4V (cardioids), MK 22 (Open Cardioid) with pop filter PR 120 S, PR 120 SV
	All instr. incl. percussion: especially for organ:	MK 4 (cardioid); to pick up room sound as well: MK 2S (omni); especially when the room's character is less than optimal or if the bass is too strong: MK 21 (wide cardioid) or MK 4 (cardioid)
Stereo	Tympani, bass drum, etc.	pressure transducers, e.g. MK 2
	Instruments with adapters	flute: MK 8 (figure-8), violin: MK 4V (cardioid), saxophone: MK 4 or MK 4V (cardioids)
	Accent miking (spot mike)	in the orchestra: MK 4 (cardioid), MK 41 (supercardioid), but also MK 21 (wide cardioid) or MK 22 (Open Cardioid)
Surround	Orchestra, chorus	ORTF microphone MSTC 64; for best low-frequency reproduction, A/B recording e.g. with MK 2S or with BLM 3g or BLM 03 Cg; Decca Tree with 3x MK 2S, perhaps using KA 50 accessory spheres
	Small orchestra / ensemble	M/S with RCY Active Tube, boundary layer microphone or modular microphones, X/Y
	Film and video dialog/effects	M/S with MK 41 (supercardioid) in the M-channel or X/Y on a boom, boundary layer with BLM 03 Cg e.g. under a thin tablecloth or in a car under the top
Surround	Orchestra	OCT surround; Decca Tree with 3x MK 2S, perhaps using KA 50 accessory spheres
	Film and video dialog/effects	Double M/S on a boom and possibly a Hamasaki Square for increased envelopment



MK 2

MK 2H



MK 2S

MK 3

- MK 2 for free-field placement (close to the sound source)
- MK 2H for use at moderate distance (at or near the reverberation radius\*)
- MK 2S all-purpose capsule for music and speech, also for use at moderate distance (at or near the reverberation radius\*)
- MK 3 for diffuse-field placement (distinctly beyond the reverberation radius\*)

Actual miking distances will depend greatly on characteristics of the recording environment – especially size and reverberance – and on personal preference.

Each of these capsules, when used at appropriate distance, will have a well-balanced overall response given the mixture of direct and reflected sound energy typical of that distance.

Note: Since the capsules have some directionality at high frequencies, it is still necessary to aim them with respect to the sound source, even though they are "omnidirectional." With the microphone amplifier CMC 6xt, the frequency range of these capsules can be extended to 40 kHz.

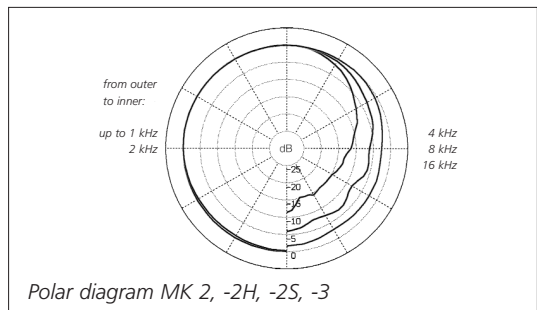
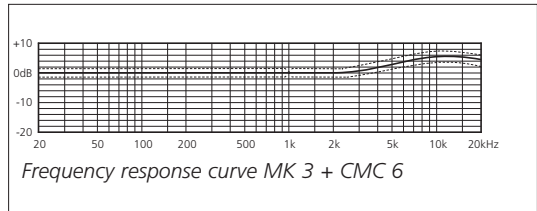
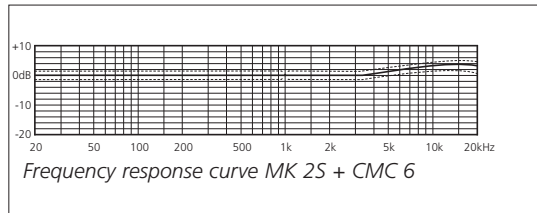
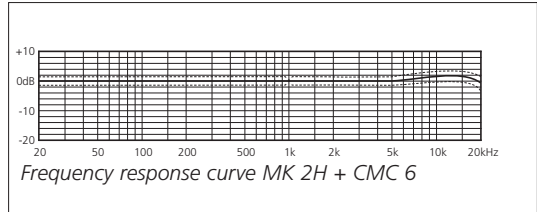
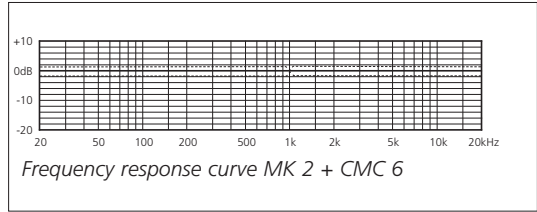

\*reverberation radius: the "critical distance" from the sound source at which the levels of direct and diffuse sound are equal in a given space.



BLM 3g



BLM 03Cg

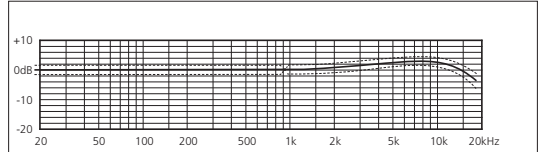

Frequency response curve BLM 3g, BLM 03Cg + CMC 6

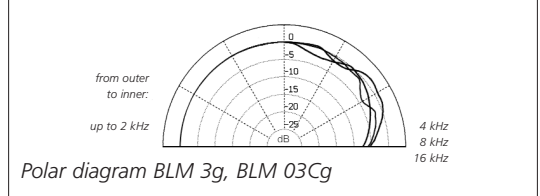

Polar diagram BLM 3g, BLM 03Cg

- boundary layer capsules
- hemispheric directional pattern
- no coloration of off-axis sound

Suggested applications:

Music (orchestra, including pit orchestra); on-stage; speech.

BLM 03C: Round-table discussions

Note:

The BLM capsules rely on the boundary layer ("pressure zone") effect. They will have the frequency response shown here only when placed on a floor or another large, flat, rigid surface which is not covered by thick carpeting or other sound-absorbent material. For speech applications such as conference recording, a table top may suffice.



MK 21

MK 21 H

- wide cardioids
- polar pattern very well maintained throughout the frequency range
- a favorable compromise between omni (good low-frequency response) and cardioid (consistent directional pattern at all frequencies)

Suggested applications:

MK 21: music (orchestras), spot microphone; vocals; speech

MK 21H: wherever a high-frequency elevation is desired, esp. non-classical music

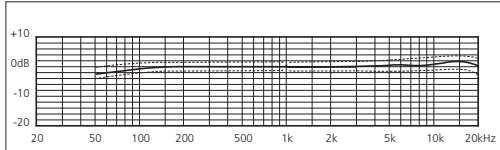

Frequency response curve MK 21 + CMC 6

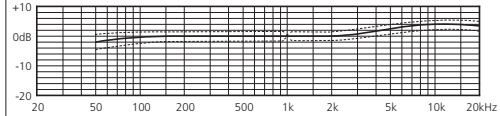

Frequency response curve MK 21H + CMC 6

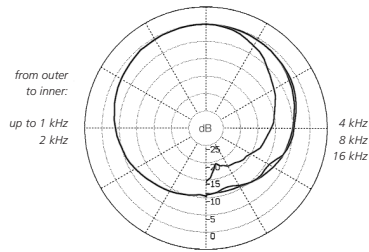

Polar diagram MK 21, -21H



### MK 22

- new kind of directional pattern: "Open Cardioid"
- optimal combination of classic cardioid directionality (MK 4) with the sonic character of the wide cardioid (MK 21)
- directional pattern largely constant throughout the frequency range

Suggested applications:

as spot / soloist's microphone

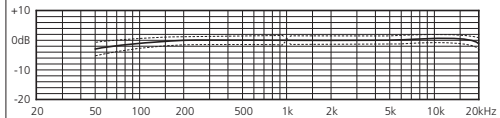

Frequency response curve MK 22 + CMC 6

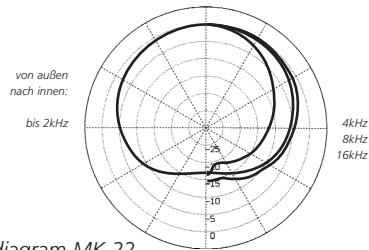

Polar diagram MK 22



**MK 4**

- standard cardioid with clear sound quality, free of coloration
- all-purpose capsule for music and speech
- our best-selling capsule type
- 0° axis is at the tip of the capsule

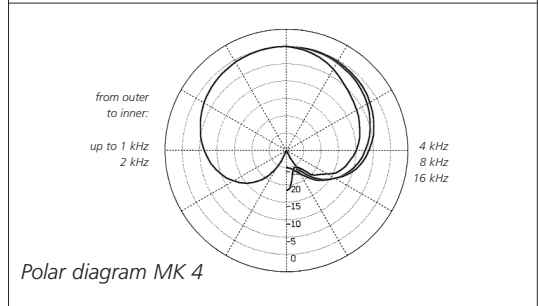
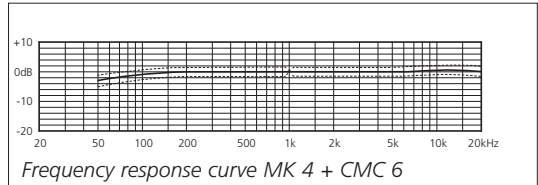

**MK 4V**

- cardioid with mild high-frequency boost
- all-purpose capsule for music and speech
- highly consistent polar response
- 0° axis is at the side of the capsule marked by a red dot

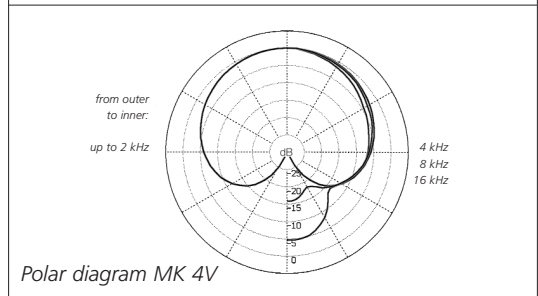
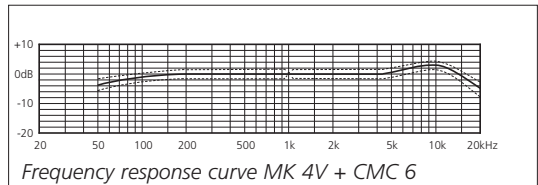

Note:  
Though not specifically designed for such use, the MK 4V capsule can also be used on the RC Active Tube or the variable angle joint GVC; when fully tightened it will rarely be aimed where you intend. On request we will supply an elastic ring which can be slipped over the threads of the RC or GVC so that the final turn of the capsule will place it at the desired angle of rotation. This ring must be kept out of the capsule threads, however.



**MK 41**

- all-purpose capsule for speech and music recording of all kinds
- well suited for use as the main microphones for stereo pickup and/or as "spot" microphones
- extended, smooth, well-balanced frequency response
- often used for film and video sound
- has distinct sonic and practical advantages over most shotgun microphones
- highly consistent polar response
- 0° axis is at the tip of the capsule

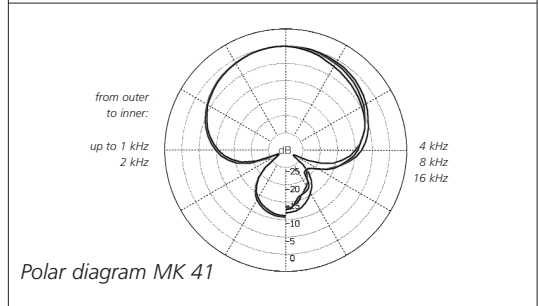
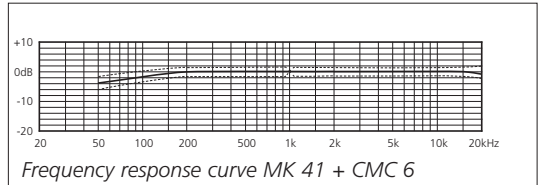

**MK 41V**

- all-purpose capsule for music and speech; same uses and advantages as the MK 41
- 0° axis is at the side of the capsule marked by a red dot

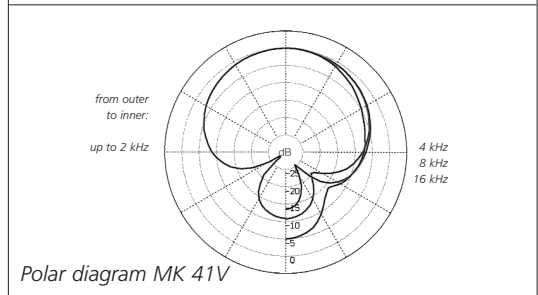
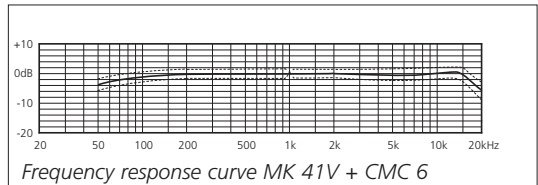

Note:  
Though not specifically designed for such use, the MK 41V capsule can also be used on the RC Active Tube or the variable angle joint GVC; when fully tightened it will rarely be aimed where you intend. On request we will supply an elastic ring which can be slipped over the threads of the RC or GVC so that the final turn of the capsule will place it at the desired angle of rotation. This ring must be kept out of the capsule threads, however.





### MK 8

- figure-8 (“bidirectional”) pattern
- clear sound quality, free of coloration
- for M/S and Blumlein stereo
- highly consistent frequency and polar response
- response essentially free of off-axis peaks like a good ribbon microphone (but not as delicate physically)
- lateral pickup

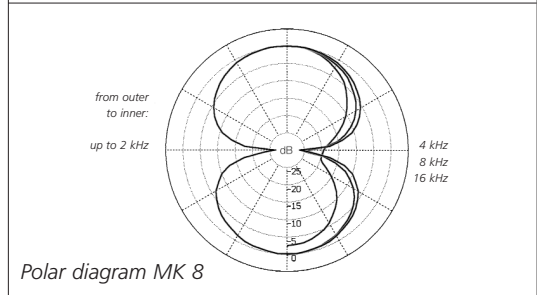
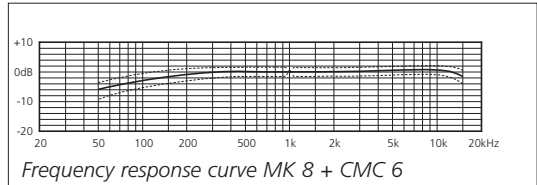

### MK 5

- mechanically switchable single-diaphragm capsule (omni / cardioid)
- smoother, more extended high-frequency response than most other multi-pattern microphones (e.g. dual-diaphragm capsules of other manufacturers)
- a pure pressure transducer when in the “omni” setting (flat, extended low-frequency response without proximity effect or undue sensitivity to wind or solid-borne sound)
- slightly brighter than the MK 2H (omni) or MK 4 (cardioid)

Intermediate switch positions are mechanically possible, but are not reproducible or recommended.

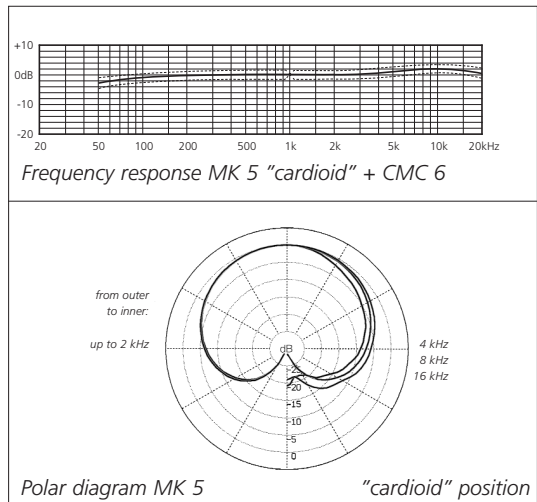
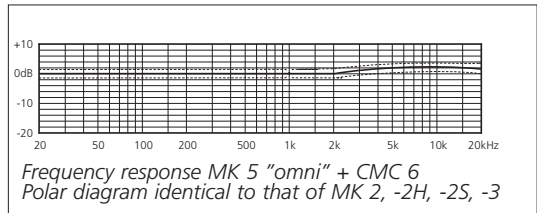



MK 4S

MK 40



MK 4VXS

When a directional microphone is used close to a sound source, its low-frequency response increases greatly. This "proximity effect" gives voices an artificial "boomy" quality which is sometimes useful as a special effect, but it reduces intelligibility and causes listener fatigue.

To avoid this problem and to reduce the effects of breath noise and popping on consonants, low-frequency filtering can be applied (e.g. the CUT 1 Active Filter) or special speech capsules with reduced low-frequency sensitivity can be used. These same measures also help to suppress low-frequency environmental noise.

**MK 4S**

– for close pickup (ca. 50 cm = 20")

**MK 40**

– for close pickup (ca. 50 cm = 20")  
– high-frequency emphasis for better speech intelligibility in reverberant venues (e.g. churches)

**MK 4VXS**

– for extremely close pickup (under 10 cm = less than 4")  
– lateral pickup

Low-frequency attenuation of cardioids for close pickup

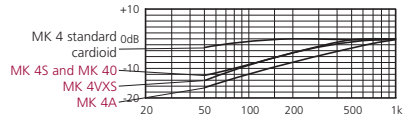

The frequency response curves shown on these pages were obtained at the usual one-meter equivalent measuring distance. They show low-frequency rolloffs which will suppress low-frequency environmental noise. When these capsules are used at the indicated working distances, proximity effect and the low-frequency rolloff will balance each other out, creating a natural-sounding pickup of the voice.

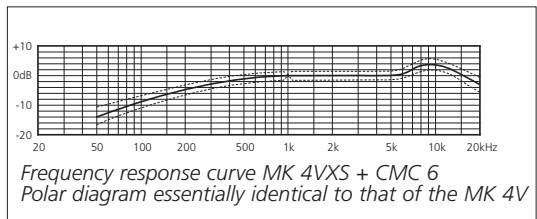
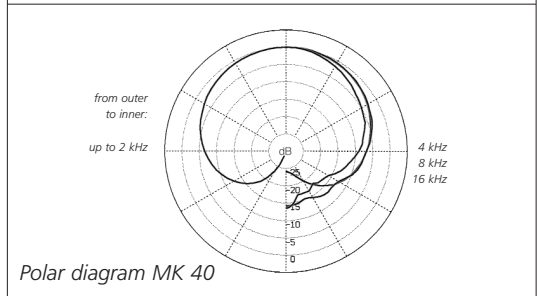
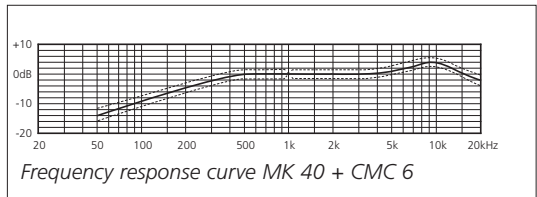
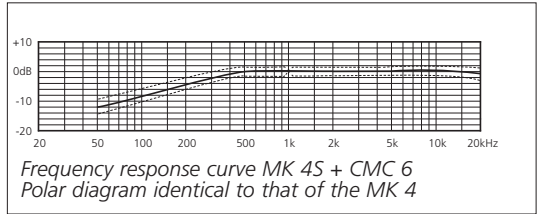



### MK 4A

- for extremely close pickup (under 10 cm = less than 4")
- deliberate 10 dB reduction in sensitivity
- especially well suited for hand-held radio microphones made by AUDIO Ltd. (England)

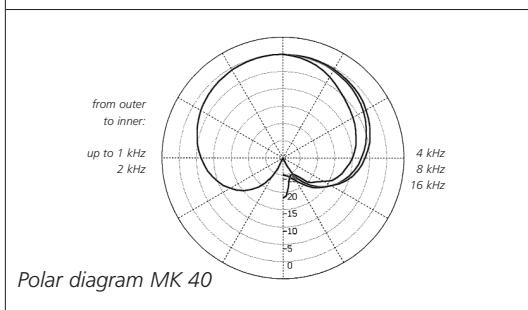
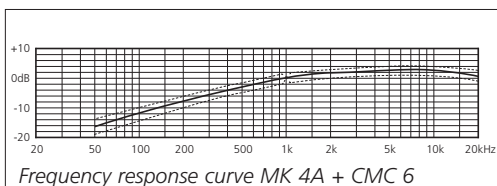

### MK 41S

- supercardioid for close pickup (under 50 cm)
- considerable low-frequency attenuation
- compensates for proximity effect
- suggested application: speech in a loud environment

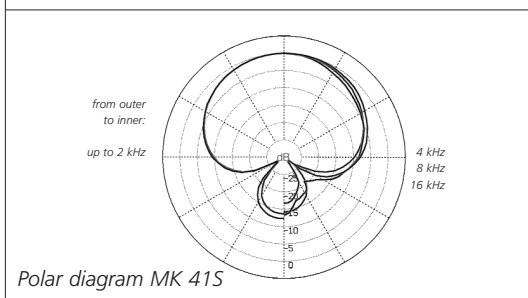
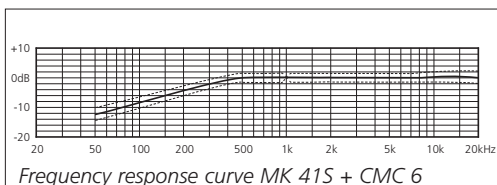

Specifications for Complete Microphones: MK -- Capsules with CMC 6 Microphone Amplifier

Capsule Type	Polar Pattern	Frequency Range	Sensitivity	Equivalent Noise Level CCIR	A-weighted	Signal-to-Noise Ratio A-weighted	Max. SPL (0.5% THD)
MK 2	omni	20 Hz – 20 kHz*	15 mV/Pa	23 dB	11 dB	83 dB	130 dB
MK 2H	omni	20 Hz – 20 kHz*	15 mV/Pa	23 dB	12 dB	82 dB	130 dB
MK 2S	omni	20 Hz – 20 kHz*	12 mV/Pa	24 dB	12 dB	82 dB	132 dB
MK 3	omni	20 Hz – 20 kHz*	10 mV/Pa	26 dB	14 dB	80 dB	134 dB
BLM 3g	hemisphere	20 Hz – 20 kHz	19 mV/Pa	23 dB	12 dB	82 dB	128 dB
BLM 03 Cg	hemisphere	20 Hz – 20 kHz	19 mV/Pa	23 dB	12 dB	82 dB	128 dB
MK 21	wide cardioid	30 Hz – 20 kHz*	13 mV/Pa	25 dB	15 dB	79 dB	132 dB
MK 21H	wide cardioid	30 Hz – 20 kHz*	10 mV/Pa	26 dB	16 dB	78 dB	134 dB
MK 22	Open Cardioid	40 Hz – 20 kHz*	14mV/Pa	23 dB	14 dB	80 dB	131 dB
MK 4	cardioid	40 Hz – 20 kHz*	13 mV/Pa	24 dB	15 dB	79 dB	132 dB
MK 4V	cardioid	40 Hz – 20 kHz	13 mV/Pa	24 dB	14 dB	80 dB	132 dB
MK 41	supercardioid	40 Hz – 20 kHz*	13 mV/Pa	24 dB	16 dB	78 dB	132 dB
MK 41V	supercardioid	40 Hz – 20 kHz	13 mV/Pa	24 dB	15 dB	79 dB	132 dB
MK 8	figure-8	40 Hz – 16 kHz	10 mV/Pa	26 dB	18 dB	76 dB	134 dB
MK 5	omni	20 Hz – 20 kHz*	11 mV/Pa	26 dB	14 dB	80 dB	133 dB
	cardioid	40 Hz – 20 kHz	13 mV/Pa	25 dB	16 dB	78 dB	132 dB
MK 4S	cardioid	80 Hz – 20 kHz	13 mV/Pa	24 dB	15 dB	79 dB	132 dB
MK 40	cardioid	80 Hz – 20 kHz	18 mV/Pa	22 dB	13 dB	81 dB	129 dB
MK 4A	cardioid	close pickup	3 mV/Pa	29 dB	18 dB	76 dB	144 dB
MK 4VXS	cardioid	close pickup	10 mV/Pa	24 dB	14 dB	80 dB	134 dB
MK 41S	supercardioid	80 Hz – 20 kHz	13 mV/Pa	24 dB	15 dB	79 dB	132 dB

\* When the CMC 6 xt microphone amplifier is used with axially addressed capsules, the frequency response extends beyond 40 kHz.

A word about signal-to-noise specifications for studio microphones: The standard method, which we follow, is really just an alternate way of stating a microphone's equivalent noise level. It is designed to allow comparison of noise floor levels for different microphones. Unlike the signal-to-noise specifications for other types of audio equipment, which give the ratio of a component's clipping point to its noise floor, these values do not indicate a microphone's entire available dynamic range. Instead, the values are measured with reference to a standard sound pressure level of 1 Pascal (1 Pa = 94 dB SPL). But the actual maximum SPL capability of any usable microphone

exceeds that reference level substantially. The signal-to-noise specifications of our microphones would be 35 to 40 dB (!) greater if the "hi-fi" approach were used.

The use of "A" weighting when specifying the equivalent noise level of microphones is another often-misunderstood aspect of the standards. "A" weighting yields a distinctly lower noise specification – often by 10 dB or thereabouts – and this figure, of course, becomes the one most often cited in advertising. But the CCIR weighted noise level may well be a more accurate indicator of a microphone's perceived noise level in practice.

### Care of Colette Series Condenser Microphone Capsules

Please be careful to avoid placing capsules in a dusty environment. Keep them in their cases (or in the wood case of the microphone amplifier) when not in use, since any dust that gets inside the capsules can adversely affect their functioning. In combination with humidity it can lead to condensation and thus popping and crackling noises (often described as "frying sounds").

#### *What to do if...*

*the microphone is noisy (clicks and pops) in high humidity?*

- If the microphone is brought from the cold outdoors into a warm environment, snapping or clicking noises can result from the condensation of moisture. In such a case the microphone should be given time to reach room temperature, and as a rule it will then perform flawlessly.
- Sometimes dirt can get into the contacts at the end of the microphone amplifier or of an Active Accessory where the capsule is attached; this, too, can cause impulse noise. You can clean the contacts yourself by using compressed air (without lubricant) from an aerosol can. If that doesn't help, you can scrub them with a new, clean toothbrush dipped in isopropyl alcohol, holding the microphone amplifier or Active Accessory so that the contacts face downward. Shake off any extra fluid; under no circumstances can it be allowed to flow into the amplifier! Be careful to wipe the contacts dry.

If this treatment does not eliminate the noise, it is possible that dirt has gotten inside the capsule itself – in which case the capsule must be sent back to the factory for cleaning. We strongly urge customers not to open a capsule or attempt to clean it themselves. Doing so would also void all warranties. Neither should the contact rings of a capsule be cleaned with any kind of liquid. Windscreens are recommended when microphones have to

be used in dirty or dusty environments in order to avoid problems of the kind described above.

### Possible Problems

#### *Wind Noise and Polar Pattern*

Noise problems may be a consideration when choosing a microphone pattern (directional characteristic) for a given set of recording conditions. Pressure transducers are considerably less prone than pressure gradient transducers (such as cardioids or supercardioids) to pick up noise from air currents or mechanical vibration. SCHOEPS omnidirectional capsules are pressure transducers, as are our switchable-pattern capsules in their omnidirectional settings. If strong wind is anticipated, or physical vibration of the microphone, perhaps a pressure transducer such as the MK 2 S should be used instead of a cardioid or supercardioid. The distance between the microphone and the sound source should then be reduced by about half if possible.

#### *Wind Noise and Windscreens*

Air motion (wind, vocal "popping" on sung or spoken consonants, motion of the microphone on a boom arm, or air currents due to heating or air conditioning systems) can cause noise that should always be dealt with. Even if it doesn't cause overload, it will detract from the clarity of sound. A wind or pop screen should be used, but should be chosen carefully to avoid changing the microphone's characteristics too much. Many screen types which are effective at reducing wind noise also have a tendency to reduce a microphone's directionality and/or its high-frequency response. Basket-type windscreens are generally more effective than foam-type windscreens when directional capsules are being used, and their main side effect is to create some unevenness in frequency response (see our main catalog for details).

#### *Vibration*

If noise from mechanical vibration enters a stand- or boom-mounted microphone, a shock mount (elastic suspension) should be used, and

a loop of slack cable should be isolated and tied off so that it does not become another way for vibrations to reach the microphone. Unlike a wind screen, a shock mount will not affect the characteristics of a microphone. In many kinds of work it is just justified to use a shock mount "by default."

### *Overload*

When dealing with problems of overload, it is useful to think of your recording equipment as a series of circuit stages. The goal is to find the first stage that is being overloaded, and to attenuate the signal at the input to that stage. Reducing the gain at any earlier stage would add unnecessary noise, while reducing it at a later stage would not solve the problem.

A condenser microphone represents two circuit stages: the capsule and the amplifier. In practice, capsules are rarely overloaded except by explosions or very strong wind; the only sound pressure levels that could overload a SCHOEPS capsule are so extreme – ca. 150 dB SPL – that they would quickly damage human hearing. Properly powered SCHOEPS CMC amplifiers can normally handle 130+ dB sound pressure levels, depending on the capsule type. Such levels rarely occur in unamplified sound, though their equivalents can be caused by wind when directional capsules are used. In addition, proper powering should not be taken for granted; insufficient or incorrect microphone powering has proved to be the cause of many otherwise mysterious "overload" problems.

If wind and powering can be excluded as possible issues, however, overload is far more likely to occur in the input circuitry of mixers, preamps or recorders than in SCHOEPS CMC-series microphones. This is true particularly with consumer audio equipment, though even today some professional equipment is still designed primarily for use with dynamic microphones or with earlier, less sensitive condenser microphones. If an input sensitivity control is available, it should be set low enough to avoid input overload, but not so low as to cause excess noise – though a few dB of extra hiss is preferable to the risk of hard clipping. Level meters and overload indicators don't generally

detect input overload even in fully professional equipment; they operate only at later stages of the circuitry.

If overload occurs where powering, high sound pressure levels and wind are not the problem and an input sensitivity control cannot be turned down, the next logical step is to plug in a balanced resistive "pad" (attenuator) such as the SCHOEPS MDZ 10 or MDZ 20 at the preamp input. If the sound quality improves, leave the pad in place; as long as a microphone isn't being overloaded, it is always better to pad the preamp input than the microphone. Only if there are extreme sound pressure levels should a capacitive attenuator (SCHOEPS DZC 10 or DZC 20) be used.

Low-frequency disturbances such as wind and solid-borne vibration may not be directly audible as such, but infrasonic noise can still cause overload in some stage of the signal chain. A windscreen then becomes the first line of defense. But low-frequency noise can also be effectively suppressed in SCHOEPS Colette microphones with the Active Filters CUT 1 or CUT 2, inserted between the capsule and amplifier. These filters have the side effect of raising a CMC amplifier's gain to that of the +5 dB option (see pages 4 and 5), but given the enormous levels of noise which can be generated by wind, they are helpful far more often than not. Alternatively, the simpler low-cut filters LC 60 or LC 120 can be placed at the input of a phantom-powered preamp.

Overload which does not otherwise seem to make sense may actually be a symptom of incorrect or inadequate microphone powering. Powering systems and their requirements are discussed near the beginning of this manual on page 5.

The least expensive, most helpful troubleshooting tools are:

- a known good microphone cable
- a simple pop screen such as the SCHOEPS B 5 (or for outdoor recording, a wind screen such as the SCHOEPS W 5)
- a balanced, in-line resistive attenuator ("pad") such as the SCHOEPS MDZ 10 or MDZ 20
- an ordinary multimeter or the SCHOEPS PHS 48 phantom power tester

## Warranty

We guarantee our products for a period of twenty-four months, except for batteries. The guarantee period begins on the date of purchase.

Please provide your bill of sale in all cases as proof of guarantee; without it, repairs will be undertaken only at the owner's expense. We reserve the right to satisfy all warranty requirements regarding defects of workmanship or materials by means of repair or partial or complete replacement of the product, at our sole discretion.

Excluded from this guarantee are defects due to misuse (e.g. incorrect operation; mechanical damage), abuse or "Acts of God." This guarantee is nullified in the event of tampering by unauthorized persons or agencies.

To secure your rights under this guarantee, send the product with proof of purchase and a precise description of the malfunction, at your expense, either to SCHOEPS (if you are a customer in Germany), or to our representative (if you are a customer outside of Germany).

Prior to sending your defective product for repair, please contact your local dealer or distributor for instructions. In exceptional cases you can, by prior arrangement with SCHOEPS, send the product directly to us from a foreign country. However any return shipment must then be prepaid; this tends to cause delays, especially for non-warranty service. Full payment must be made before a repaired item can be returned to the customer.

This guarantee does not affect any contractual agreements which may exist between the buyer and seller of the equipment.

This guarantee is world-wide.

## Declaration of Conformity – CE-Mark

The CE-mark guarantees that all products conform to relevant standards approved by the European Community. The products described in this User Guide comply with current, relevant standards when used with cables from SCHOEPS.

Relevant directives:  
EMC Directive: 89/336/EEC, amended by 92/31/EEC and 93/68/EEC

Relevant standards:  
EN 55 103-1, -2 and those which are referred to by them.

Subject to change without notice.  
Not responsible for errors or omissions.

091102

**SCHOEPS** GmbH  
Spitalstrasse 20  
D-76227 Karlsruhe (Durlach)  
Germany

Tel: +49 721 943 20-0

Fax: +49 721 943 2050

[www.schoeps.de](http://www.schoeps.de)  
[mailbox@schoeps.de](mailto:mailbox@schoeps.de)

Schall



Technik

