



ColorBlaze

Rugged, full-color linear LED fixture for far-reaching wash lighting and effects

PHILIPS

ColorBlaze

Rugged, full-color linear LED fixture for far-reaching wash lighting and effects

ColorBlaze® is a robust, high-performance linear LED fixture for washing large areas with far-reaching, rich, saturated colors. With a rugged, extruded aluminum housing, ColorBlaze is designed to withstand the rigors of the touring and rental market. Integrated power supplies eliminate the need for additional equipment, pushbutton addressing capabilities simplify configuration and installation, and locking mounting brackets allow for flexible mounting to pipes or surfaces, making ColorBlaze an easy-to-use yet powerful solution for theaters, TV studios, concerts, events, casinos, and exhibits. To support dynamic, color-changing effects, each ColorBlaze fixture is sequentially controllable in 6 in (152 mm) segments by a Philips or third-party DMX controller.

- Two fixture lengths — Available in two fixture lengths, ColorBlaze 72 (6 ft, 1.8 m) and ColorBlaze 48 (4 ft, 1.2 m), each controllable in 6 in (152 mm) segments.
- Universal, integrated power supply — Auto-switching power supply accepts power input of 110 – 240 VAC, eliminating the need for additional equipment and enabling consistent use around the world.
- Pushbutton addressing and configuration — Onboard addressing capabilities offer easy configuration without external addressing tools.
- Industry-leading controls — ColorBlaze works with the complete Philips line of controllers, including iPlayer 3 and Light System Manager, as well as third-party DMX controllers. Fixtures can be connected in series of up to 1,000 ft (300 m) using any combination of RJ45, Ethercon, or XLR-5 data cables.
- High-intensity, saturated color output — RGB additive color mixing provides 16.7 million colors with variable intensity. Each 6 in (152 mm) segment has an output of over 300 lumens.
- Simple light positioning — Mounting brackets and locking knobs enable 180° rotation, adjustment, and locking without special tools.
- Versatile mounting options and accessories — Clamp-mount ColorBlaze to pipes or trusses, or mount directly to a surface. An optional T-handle mounting bracket is available for special mounting situations. Accessory holders, spread lenses, and other custom accessories specifically designed for ColorBlaze are available from City Theatrical Inc.
- Additional stage-friendly features — Onboard cooling fan and thermal sensor prevent overheating. A full range of replacement parts is available to keep ColorBlaze fixtures in service for the long haul.



Flexible Configuration

ColorBlaze fixtures can be configured to work in unison or independently to display dynamic, color-changing effects.

Each fixture can be set to have one or more individually controllable segments — up to 8 for ColorBlaze 48, and up to 12 for ColorBlaze 72.

Vibrant, Far-Reaching Color — Anywhere

ColorBlaze efficiently casts far-reaching colored light and effects with superior output in both theatrical and architectural applications. On-board power and addressing, streamlined design, rugged aluminum housing, and an extensive component replacement program make ColorBlaze ideal for touring and rental environments, where fixtures must withstand repeated setup, reconfiguration, and teardown. The durability, low maintenance, and intelligent control afforded by industry-leading LED technology also makes ColorBlaze ideal for permanent architectural installations.



Photography: Nadine Froger

The Orange County Performing Arts Center Celebratory Gala

While best known for large-area scenery and wash lighting, ColorBlaze can be easily configured to display spectacular video effects on multiple individually controllable segments. Such was the approach of the designers hired in 2006 to create a lighting scheme for the gala celebrating the 20th anniversary season of the Orange County Performing Arts Center and the opening of its world-class Segerstrom Concert Hall.

The lighting scheme incorporated both direct-view video elements and complementary wall-washing effects. The direct video lighting display, mounted in vertical arrays against the venue's back wall, included cascading waterfall imagery and a spectacular sunset effect, streamed to ColorBlaze fixtures via Video System Manager (VSM).

The design also called for more than 45 ColorBlaze 72 fixtures along the walls of the tent in which the gala was held. Not only were these ColorBlaze fixtures used to project bold, saturated colors against the white interior surfaces of the tent, they were also used to project digital video content, streamed from the VSM, that suggested flowing movements to coincide with the direct-view display.

The entire project required only 30 days from concept to completion. Because of the fixtures' ease of configuration and installation, the lighting setup itself was done virtually overnight.

The DeVos Performance Hall Renovation

The summer 2004 renovation of DeVos Performance Hall — a 2,400-seat performing arts theatre in Grand Rapids, Michigan — showcases ColorBlaze in a landmark architectural setting.

The extensive internal renovations of this popular theatre, home to the Grand Rapids Symphony, the Grand Rapids Ballet Company, Broadway Theatre Guild, and many touring concerts and family shows, called for colorful accent lighting to enliven the theatre's side walls.

The lighting scheme was intended to give new life to the previously gray perimeter walls, which reach a height of 60 ft (18 m). The owners desired a new look that would not simply accentuate the walls, but that would actually change the perception of the audience space. The new treatment had to be large-scale, ready to build, easy to maintain, and cost-effective. The renovations had to be completed within 90 days so as not to interfere with the existing production and performance schedule.

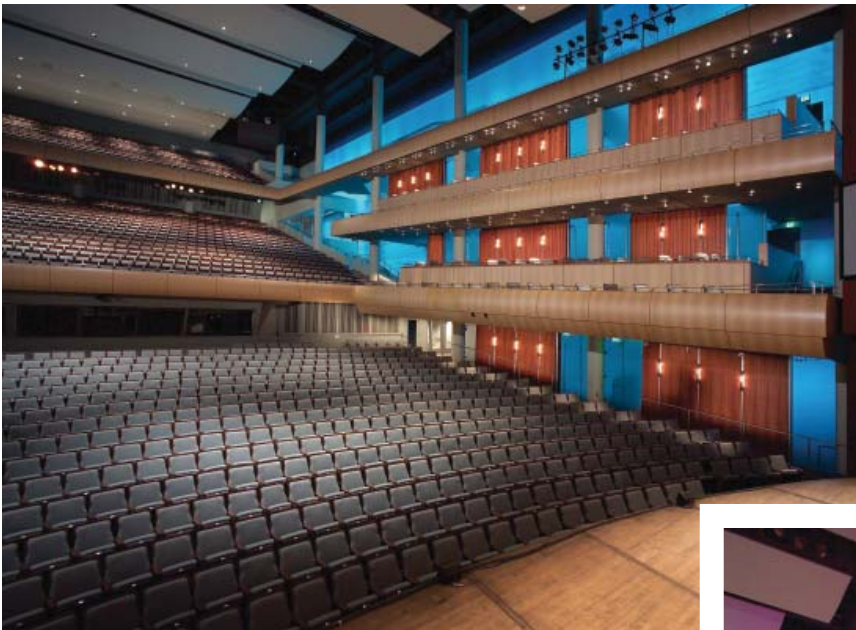

Photography: Mark Thomas Productions, Ltd.

Approximately 44 ColorBlaze 72 fixtures were mounted to the ceiling in linear runs along each perimeter wall to uniformly wash their surfaces with saturated static color and subtle, dynamic sequences. The owners placed a high value on color-changing lighting, because the hall is used for many different types of productions, from opera and ballet to pop / rock acts. The dynamic sequences include subtle two-color fades — orange to amber and blue to violet, for example — and rolling rainbows

The effects are easily triggered by a simple preset recall panel in the control room. Lighting board operators can also drive the ColorBlaze fixtures through the theatre's DMX control console.



Photometrics

Photometric data is based on test results from an independent NIST traceable testing lab. IES data is available at www.colorkinetics.com/support/ies.

ColorBlaze 48

LED	Lumens	Watts	Efficacy
RGB	3708	280	13.2

Polar Candela Distribution

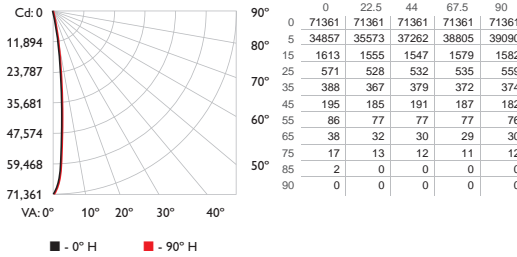

Illuminance at Distance

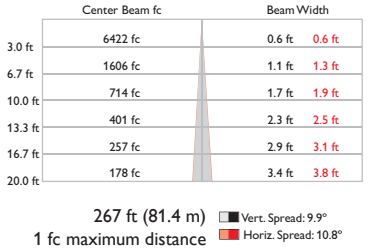

Zonal Lumen

Zone	Lumens	% Lamp	% Luminaire
0-30	3,203.9	86.4%	86.5%
0-40	3,438.2	92.7%	92.9%
0-60	3,655.2	98.6%	98.7%
60-90	47.8	1.3%	1.3%
0-90	3,703.0	99.9%	100%
90-180	0	0%	0%
0-180	3,703.0	99.9%	100%

Total Efficiency: 99.9%

Coefficients Of Utilization - Zonal Cavity Method

Effective Floor Cavity Reflectance: 20%

RCC %:	80	70	50	30	10	0
RW %:	70	50	30	0	50	30
RCR:	0	1.19	1.19	1.19	1.16	1.16
	1.16	1.16	1.16	1.10	1.13	1.11
	1.09	.97	1.07	1.06	1.05	1.03
	1.02	1.01	1.00	.99	.97	.98
	.97	.95	.94	.94	.94	.94
	.94	.93	.91	.89	.88	.87
	.87	.85	.84	.83	.82	.81
	.81	.80	.78	.77	.76	.75
	.74	.73	.72	.71	.70	.69
	.68	.67	.66	.65	.64	.63
	.62	.61	.60	.59	.58	.57
	.56	.55	.54	.53	.52	.51
	.50	.49	.48	.47	.46	.45
	.44	.43	.42	.41	.40	.39
	.38	.37	.36	.35	.34	.33
	.32	.31	.30	.29	.28	.27
	.26	.25	.24	.23	.22	.21
	.20	.19	.18	.17	.16	.15
	.14	.13	.12	.11	.10	.09
	.08	.07	.06	.05	.04	.03
	.02	.01	.01	.00	.00	.00
	.00	.00	.00	.00	.00	.00

RCC %: Ceiling reflectance percentage, RW %: Wall reflectance percentage, RCR: Room cavity ratio

ColorBlaze 72

LED	Lumens	Watts	Efficacy
RGB	5562	420	13.2

These figures are scaled based on the ColorBlaze 48 photometrics to approximate the light output of ColorBlaze 72.

Polar Candela Distribution

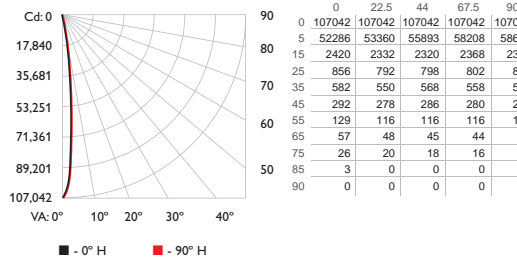

Illuminance at Distance

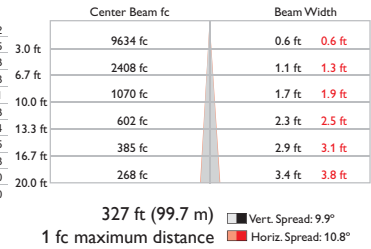

Zonal Lumen

Zone	Lumens	% Lamp	% Luminaire
0-30	4,805.8	86.4%	86.5%
0-40	5,157.3	92.7%	92.9%
0-60	5,482.8	98.6%	98.7%
60-90	71.7	1.3%	1.3%
0-90	5,554.5	99.9%	100%
90-180	0	0%	0%
0-180	5,554.5	99.9%	100%

Total Efficiency: 99.9%

Coefficients Of Utilization - Zonal Cavity Method

Effective Floor Cavity Reflectance: 20%

RCC %:	80	70	50	30	10	0
RW %:	70	50	30	0	50	30
RCR:	0	1.19	1.19	1.19	1.16	1.16
	1.16	1.16	1.16	1.10	1.13	1.11
	1.09	.97	1.07	1.06	1.05	1.03
	1.02	1.01	1.00	.99	.97	.98
	.97	.95	.94	.94	.94	.94
	.94	.93	.91	.89	.88	.87
	.87	.85	.84	.83	.82	.81
	.81	.80	.78	.77	.76	.75
	.74	.73	.72	.71	.70	.69
	.68	.67	.66	.65	.64	.63
	.62	.61	.60	.59	.58	.57
	.56	.55	.54	.53	.52	.51
	.50	.49	.48	.47	.46	.45
	.44	.43	.42	.41	.40	.39
	.38	.37	.36	.35	.34	.33
	.32	.31	.30	.29	.28	.27
	.26	.25	.24	.23	.22	.21
	.20	.19	.18	.17	.16	.15
	.14	.13	.12	.11	.10	.09
	.08	.07	.06	.05	.04	.03
	.02	.01	.01	.00	.00	.00
	.00	.00	.00	.00	.00	.00

RCC %: Ceiling reflectance percentage, RW %: Wall reflectance percentage, RCR: Room cavity ratio

For lux multiply fc by 10.7

Specifications

Due to continuous improvements and innovations, specifications may change without notice.

Item	Specification	ColorBlaze 48	ColorBlaze 72
Output	Beam Angle	10°	10°
	Lumens†	3708	5562
	Color Range	16.7 million additive RGB colors; continuously variable intensity	
	Mixing Distance	6 in (152 mm) to uniform light	
	Lumen Maintenance‡	50,000+ hours L50 @ 50° C (full output)	
Electrical	Input Voltage	100 – 240 VAC, auto-switching, 50 / 60 Hz	
	Power Consumption	280 W maximum at full output, steady state	420 W maximum at full output, steady state
Control	Interface	DMX	
	Control System	Philips full range of controllers, including Light System Manager and iPlayer 3, or third-party DMX controllers	
Physical	Dimensions (Height x Width x Depth)	7.5 x 45.3 x 6.5 in (191 x 1150 x 165 mm)	7.5 x 68.7 x 6.5 in (191 x 1746 x 165 mm)
	Weight	40 lb (18.1 kg)	60 lb (27.2 kg)
	Housing	Extruded aluminium, black finish	
	Lens	Clear polycarbonate	
	Fixture Connections	IEC power cable, RJ45, Ethercon, or XLR-5 data connections	
	Temperature	-40° – 122° F (-40° – 50° C) Operating -4° – 122° F (-20° – 50° C) Startup	
	Humidity	0 – 95%, non-condensing	
Certification and Safety	Certification	UL / cUL, FCC Class A, CE, PSE	
	LED Class	Class 2 LED product	
	Environment	Dry Location, IP20	



† Lumen measurement complies with IES LM-79-08

‡ Philips Color Kinetics follows IESNA LM-80-08 in using L50 (lumen depreciation to 50% of original light output) to define useful life of RGB LED fixtures. At maximum operating temperature (typically 50° C) and displaying white (full output), the useful life exceeds 50,000 hours. At room temperature and displaying a color wash effect, the useful life ranges from 80,000 to 100,000 hours or more.

CHROMACORE[®] | OPTIBIN[®]
CK TECHNOLOGY | CK TECHNOLOGY

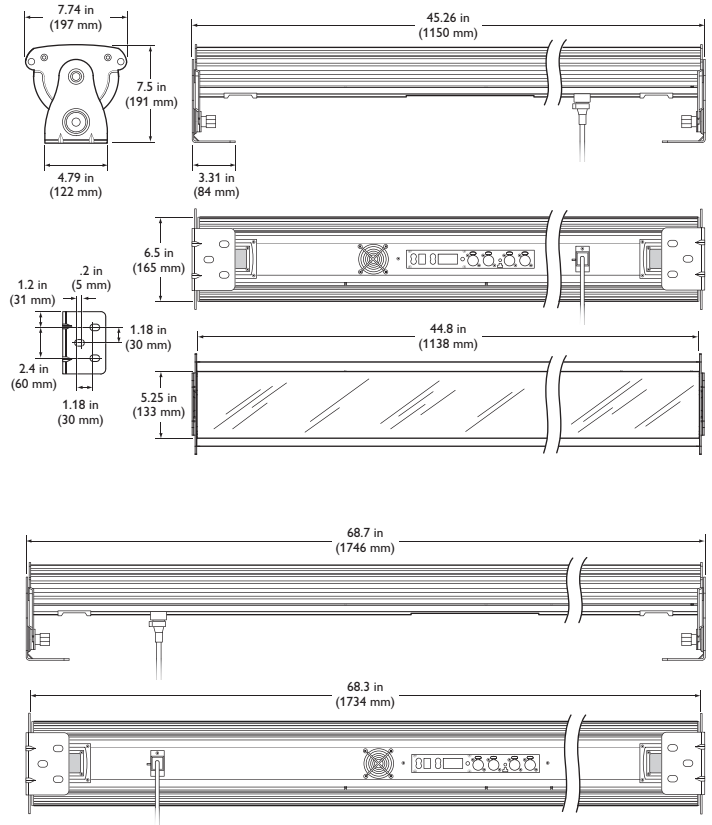

Included in the box

ColorBlaze fixture
(2) mounting brackets and knobs
UL-rated 6 ft (1.8 m) IEC power cable (600 V 90 C rated jacket)
Installation Instructions

Fixtures, Data Enablers, and Controllers

ColorBlaze fixtures are part of a complete system which includes any Philips controller, including Light System Manager and iPlayer 3, or a third-party DMX controller; and RJ45, Ethercon, or XLR-5 data cables for connecting fixtures together in series, or to controllers.

Item	Type	Item Number	Philips 12NC
ColorBlaze	72	116-000021-00	910503700614
	48	116-000022-00	910503700613
Power Supply	Without Thermal Sensor	120-000041-00	910503700131
	With Thermal Sensor	120-000042-00	910503700132
Fan		120-000043-00	910503700133
Air Inlet Filter		120-000044-00	910503700134
Controller Panel	72	120-000045-00	910503700135
	48	120-000045-01	910503700136
LED Board	Cree 7090	120-000046-01	910503700137
	Cree 7090 XR-E	120-000073-00	910503700615
	Luxeon	120-000046-00	—
IEC Connector		120-000053-00	910503700144
Clear Lens	72	120-000048-00	910503700139
	48	120-000047-00	910503700138
Mounting Bracket	Brackets and Handles	120-000049-01	910503700140
	Handles Only	120-000050-00	910503700141
T-Handle Style Mounting Bracket	Brackets and Handles	120-000051-00	910503700142
	Handles Only	120-000052-00	910503700143
Light System Manager		103-000015-00	910503700221
iPlayer 3	NA Power Cord	103-000019-00	910403327101
	EU Power Cord	103-000019-01	910503700392
ColorDial		103-000014-00	910403326901
Synchronizer		103-000001-00	—
Multi Synchronizer		103-000002-00	—

You can use any Philips controller or third-party DMX controller.

Use Item Number when ordering in North America.

Accessories

Designed specifically for ColorBlaze, Accessory Holders screw to pre-tapped holes on the sides of the ColorBlaze housing. Accessory Holders hold Glass Spread Lenses and additional accessories available by special order from City Theatrical Inc. Pro Series Accessory Holders feature a spring clip to protect accessories from vibrations and rough handling. Black or white Accessory Holders can be used to match finishes when ColorBlaze fixtures are recessed in ceilings or walls.

In addition to Accessory Holders and Glass Spread Lenses, City Theatrical Inc. offers a line of accessories for ColorBlaze, such as top hats and egg crate louvers, available by special order. Visit www.citytheatrical.com for details.

Item	Type	Item Number	Philips 12NC		
Accessory Holders	ColorBlaze 72	Standard	White	120-000001-00	—
			Black	120-000001-01	—
		Pro Series	White	120-000001-02	—
			Black	120-000001-03	—
	ColorBlaze 48	Standard	White	120-000002-00	—
			Black	120-000002-01	—
Pro Series		White	120-000002-02	—	
		Black	120-000002-03	—	
Glass Spread Lenses	ColorBlaze 72 (3) 2 ft (610 mm) sections	36° / 50° horiz. spread	120-000023-00	—	
		40° / 40° horiz. / vert. spread	120-000023-01	—	
	ColorBlaze 48 (2) 2 ft (610 mm) sections	36° / 50° horiz. spread	120-000024-00	—	
		40° / 40° horiz. / vert. spread	120-000024-01	—	

Installation

ColorBlaze fixtures have integrated power supplies and pushbutton addressing controls located on the back of the fixture housing. For theatrical installations where fixtures are readily accessible, you typically mount ColorBlaze fixtures first, then address and configure them as necessary. For permanent installations with dynamic effects, you may find it convenient to configure and address your fixtures first, in a staging area where the fixtures are easily accessible. For example, we recommend configuring and addressing ColorBlaze fixtures before installing them in architectural applications where the fixtures will be mounted permanently against flat surfaces, in niches, or in other areas that may be difficult to access.

Refer to the ColorBlaze Installation Instructions for specific warning and caution statements.

Owner / User Responsibilities

It is the responsibility of the contractor, installer, purchaser, owner, and user to install, maintain, and operate ColorBlaze fixtures in such a manner as to comply with all applicable codes, state and local laws, ordinances, and regulations. Consult with the appropriate electrical inspector to ensure compliance.

Create a Lighting Design Plan

Regardless of the details of your installation, it's good practice to create a lighting design plan that identifies your fixtures, records the DMX addresses assigned to them, and identifies their locations in relation to other required hardware. For complex installations displaying light shows with dynamic effects, such a lighting design plan is essential.

To create a lighting design plan, determine the appropriate location of each ColorBlaze fixture in relation to power sources and controllers. On an architectural diagram or other diagram that shows the physical layout of the installation, identify the locations of all controllers, fixtures, power sources, and cables. To streamline installation and aid in light show programming, you can affix a label identifying the order or placement in the installation to an inconspicuous location on each ColorBlaze fixture's housing.

Keep the following considerations in mind when planning your installation:

- The integrated, auto-switching power supply automatically adjusts to any 50 / 60 Hz power source from 110 – 240 V. Each ColorBlaze fixture includes a 6 ft (1.8 m) detachable cable with a standard IEC connector and flying leads. You must connect the cable's flying leads to a 3-wire plug appropriate for your geographic location.
- You can connect ColorBlaze fixtures in series using any combination of RJ45, Ethercon, and XLR-5 data cables.
- ColorBlaze fixtures can work as a single unit, or you can set fixtures to have multiple segments that display different colors simultaneously for dynamic effects. Segment lengths differ depending on fixture length and configuration. When installing fixtures end-to-end, you can create virtual segments that span multiple fixtures.
- You can mix ColorBlaze 48 and ColorBlaze 72 fixtures in a single run. A mixture of fixture lengths can offer flexibility in architectural applications where you need to install fixtures around corners or in confined areas.
- You can mount ColorBlaze fixtures end-to-end, or you can space them however you wish, so long as the maximum distance from a controller to the last fixture in a series does not exceed 1000 ft (300 m) without a DMX repeater.
- Each series of fixtures can use up to 512 unique DMX addresses. Since each fixture segment requires three addresses, you can have up to 170 uniquely addressed segments within a single series. For example, you could create a series

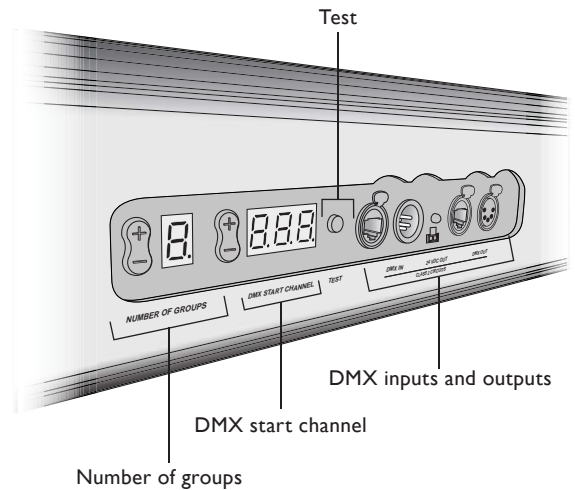

Connecting ColorBlaze to an Ethernet Controller

Ethernet controllers from Philips, such as Light System Manager or Video System Manager Pro, use KiNET™, the standard Ethernet lighting protocol from Philips Color Kinetics. To control ColorBlaze fixtures with a Philips Color Kinetics Ethernet controller, you must use a KiNET-to-DMX converter, such as the PDS-150e. Visit www.colorkinetics.com/lspds/pds150e/ for more information.



Included in the box

ColorBlaze fixture
(2) mounting brackets and knobs
US UL-rated 6 ft (1.8 m) IEC power cable (600 V 90 C rated jacket)
Installation Instructions

If you use a cable other than the included IEC power cable, make sure that the cable is equivalent in size and rating, and that it meets local standards. Ensure that the plug on the power cable can be held securely in place by the IEC inlet locking mechanism, which is designed for a C13 plug.

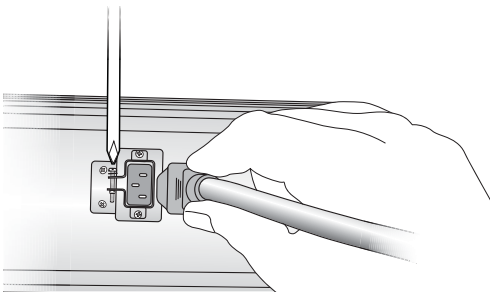

You can test a ColorBlaze fixture by pressing and holding the TEST button. If the fixture is working properly, each group of LEDs (8 for ColorBlaze 48, 12 for ColorBlaze 72) will briefly illuminate in sequence.

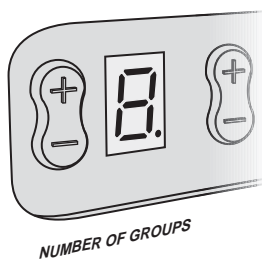
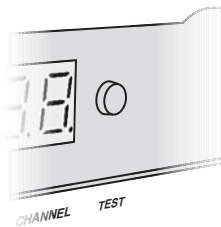

of 14 ColorBlaze 72 fixtures, each with 12 segments (14 fixtures x 12 segments x 3 = 504 addresses), or a series of 85 ColorBlaze 48 fixtures, each with 2 segments (85 fixtures x 2 segments x 3 = 510 addresses).

Connect the Power Cable Plug

ColorBlaze has integrated, auto-switching power supplies that automatically adjust to any 50 / 60 Hz power source from 110 – 240 V. ColorBlaze fixtures are connected directly to line power using the included 6 ft (1.8 m) detachable power cable. You must connect the cable's flying leads to an appropriate 3-wire plug.

1. Unpack the fixture, and place it in a staging area or other location where the controls on the back of the fixture housing are easily accessible.
2. Install a 2-pole, 3-wire, grounded, 15 A plug to the included power cable. Following the plug manufacturer's instructions, connect the green and yellow wire to ground (earth), the black wire to live, and the white wire to neutral.

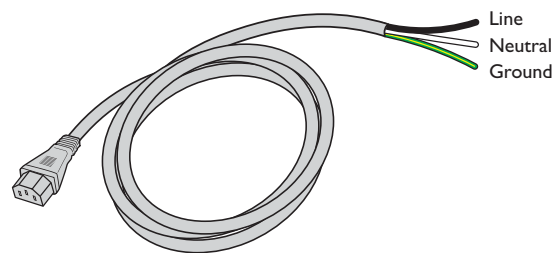

3. Connect the power cable to the IEC inlet on the back of the ColorBlaze housing.
4. Tighten the screw on the IEC inlet to hold the power cable in place.

Set Fixture Segments

Make sure the power is ON before addressing and configuring fixtures by plugging in the fixture's power cable.

To allow a fine level of control for light shows with dynamic effects, ColorBlaze fixtures can be configured to have multiple individually addressable groups of fixture segments: 1, 2, 4, or 8 for ColorBlaze 48, or 1, 2, 3, 4, 6, or 12 for ColorBlaze 72. You set the fixture's start DMX channel (address), and the onboard controls automatically assign unique DMX addresses to each segment.

Each ColorBlaze fixture is factory-addressed to have 4 groups and a starting DMX channel of 1. For light show designs displaying static effects, no changes to the factory-default settings are necessary. However, if fixtures were previously configured for use in other installations, you may have to reset them. For light show designs with dynamic effects, you may need to set the number of groups each fixture will have.

To set the number of groups for a ColorBlaze fixture:

1. In the NUMBER OF GROUPS section on the back of the fixture housing, press the + and - buttons to scroll through the options: 1, 2, 4, or A (8) for ColorBlaze 48, or 1, 2, 3, 4, 6, or A (12) for ColorBlaze 72.
2. For complex installations where you set different numbers of groups on different fixtures, it's good practice to notate each fixture's group setting on the lighting design plan.

Keep the following considerations in mind when setting the number of fixture groups:

- The number of groups effectively determines segment length. For example, setting a ColorBlaze 48 to 4 groups results in 4 segments of roughly 1 foot each. Setting a ColorBlaze 72 to 3 groups results in 3 segments of roughly 2 feet each. The following table gives the segment lengths for the different settings available on ColorBlaze 48 and ColorBlaze 72.

Number of Groups Settings

Segment Length	ColorBlaze 72	ColorBlaze 48
6 ft	1	—
4 ft	—	1
3 ft	2	—
2 ft	3	2
1.5 ft	4	—
1 ft	6	4
.5 ft	A (12)	A (8)

- As the table shows, you can mix ColorBlaze 48 and ColorBlaze 72 fixtures in the same series while maintaining consistent segment lengths of 2 feet, 1 foot, or .5 feet.

2 ft (610 mm)
segments

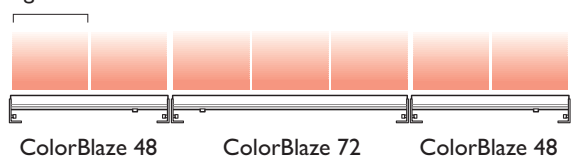

- If you install fixtures of the same length end to end, you can create virtual segments that span multiple fixtures. For example, you can create virtual 9 ft segments with ColorBlaze 72 fixtures by alternating 1-segment and 2-segment fixtures.

9 ft (2.74 m) segments



Set the DMX Start Channel

ColorBlaze fixtures communicate directly with Philips or third-party DMX controllers by means of DMX addresses, or channels. Each ColorBlaze fixture is factory-addressed to a starting DMX channel of 1. For light show designs displaying static effects, no changes to the factory-default settings are necessary. However, if fixtures were previously readdressed for use in other installations, you may have to reset them to the same starting DMX channel. For light show designs displaying dynamic effects, you must set different starting channel for each fixture in a series to ensure that all fixture segments are uniquely addressed.

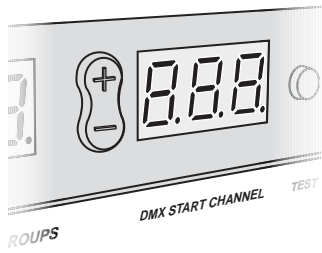

To set a fixture's DMX start channel:

1. In the DMX START CHANNEL section on the back of the fixture housing, press the + and - buttons to scroll through all available DMX addresses (1 – 512).
2. If you're enabling dynamic effects by setting different DMX starting channels for each fixture in a series, you can streamline configuration and light show programming by notating the DMX starting channel of each fixture segment on the lighting design plan.

Keep the following considerations in mind when addressing your fixtures:

- ColorBlaze onboard addressing automatically assigns consecutive DMX addresses to the fixture's segments, starting with the channel you set. Each segment receives three DMX addresses, one for red, one for blue, and one for green. The following example shows the starting DMX addresses for all fixture segments when the starting DMX address is set to 1.

ColorBlaze 48 / DMX Start Channel = 1

		DMX Start Channel Per Segment							
1 group		Segment 1 001							
2 groups		Segment 1 001				Segment 2 004			
4 groups		Segment 1 001		Segment 2 004		Segment 3 007		Segment 4 010	
A (8) groups		Segment 1 001	Segment 2 004	Segment 3 007	Segment 4 010	Segment 5 013	Segment 6 016	Segment 7 019	Segment 8 022

ColorBlaze 72 / DMX Start Channel = 1

		DMX Start Channel Per Segment											
1 group		Segment 1 001											
2 groups		Segment 1 001						Segment 2 004					
3 groups		Segment 1 001				Segment 2 004				Segment 3 007			
4 groups		Segment 1 001			Segment 2 004			Segment 3 007			Segment 4 010		
6 groups		Segment 1 001		Segment 2 004		Segment 3 007		Segment 4 010		Segment 5 013		Segment 6 016	
A (12) groups		Seg 1 001	Seg 2 004	Seg 3 007	Seg 4 010	Seg 5 013	Seg 6 016	Seg 7 019	Seg 8 022	Seg 9 025	Seg 10 028	Seg 11 031	Seg 12 034

- With the back of the fixture housing toward you, segments extend in sequence from the left of the fixture to the right.
- Make sure that the DMX start channel allows enough DMX addresses for all of the fixture's segments, or the fixture will not function properly. For example, a fixture with 4 groups requires 12 DMX addresses, 3 per segment. Therefore, the DMX start channel should be 501 or lower.
- For light shows with dynamic effects, set start channels so that each fixture in a series receives a unique set of DMX addresses. For example, in a series of 3 fixtures, each with 4 groups, you can ensure that each fixture is uniquely addressed by setting the start channel of the first fixture to 1, the start channel of the second fixture to 13 (1 + 12), and the start channel of the third fixture to 25 (13 + 12).

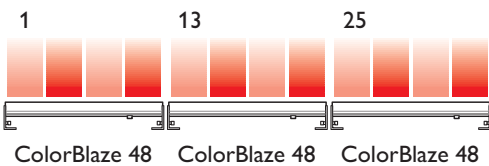

Mount the Fixtures

ColorBlaze fixtures come with attached mounting brackets designed for .5 in mounting hardware. Fixtures can be mounted to a surface or to a pipe or truss with standard pipe clamps or Cheeseborough clamps. If your installation calls for special mounting, you can replace the included mounting brackets with separately available T-handle mounting brackets.

1. Verify that all supporting equipment (controllers, connections to power sources) is in place. ColorBlaze fixtures are intended to plug into line power using the included 6 ft (1.8 m) detachable IEC power cable.
2. Mount fixtures as dictated by local, state, or national codes. Consult a structural engineer or safety professional to ensure proper mounting.

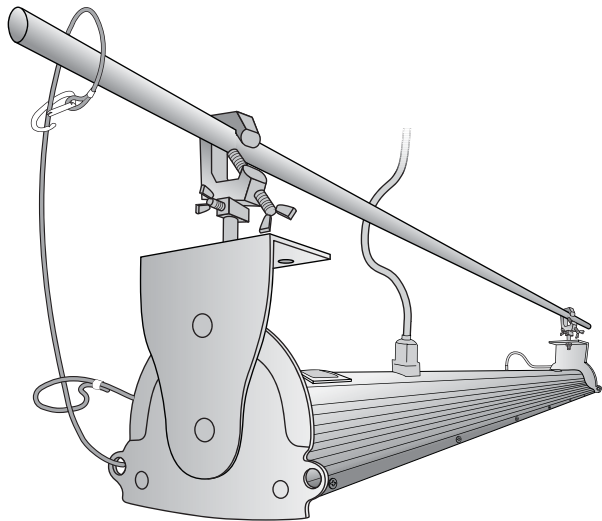

Make sure to install fixtures with the same orientation. This is especially important in installations with light shows that display dynamic effects.

Safety cable minimum requirements

Material	Determined by installer / owner
Break Load	Minimum break load for cable and all cable anchoring construction is 600 lb (272 kg) total.
Construction	7 x 7 (49 wires) preformed stranded

3. Each ColorBlaze fixture is designed for use with one or more safety cables to tether the fixture to a secure anchor point. When suspending or installing ColorBlaze fixtures overhead, or when dictated by local or state code or advised by a structural engineer, loop safety cables through one or both of the restraining holes located at the either end of the ColorBlaze housing. Securely anchor the safety cables using a method that follows code or engineer's requirements.

Connect Data and Power

1. Supply power to each ColorBlaze fixture by plugging them in.
2. Using a standard RJ45, Ethercon, or XLR-5 data cable, connect data directly from a DMX controller's data output port to a DMX IN port on the first ColorBlaze fixture in a series.

To connect data from a Philips Color Kinetics Ethernet controller, such as Light System Manager or Video System Manager Pro, you must use a converter, such as the PDS-150e. Visit www.colorkinetics.com/ls/pds/pds150e/ for details.

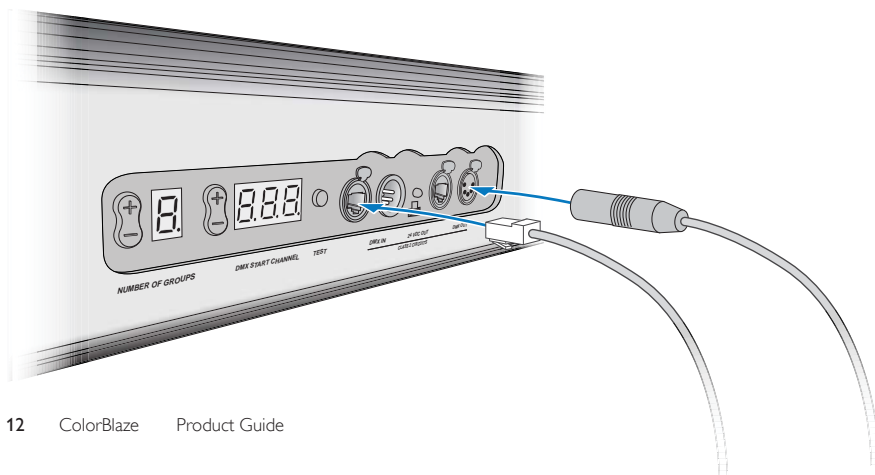

Connections between ColorBlaze fixtures are not connector-specific. You can use any combination of XLR-5, Ethercon, and RJ45 inputs and outputs.

3. Create a series by connecting a DMX OUT port on the first fixture to a DMX IN port on the next fixture in sequence, using a standard RJ45, Ethercon, or XLR-5 data cable.

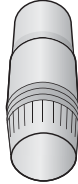
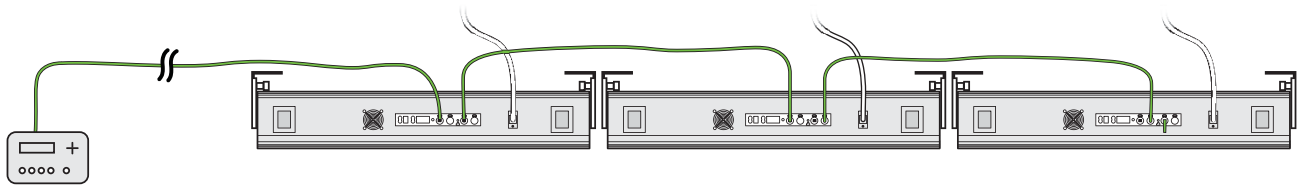

4. Repeat step 3 for each ColorBlaze fixture in the series.
5. Insert a standard data terminator in a DMX OUT port on the last fixture in the series.

Aim and Lock the Fixtures

1. Loosen the locking knobs at each end of a ColorBlaze fixture to allow the fixture to rotate freely through 180°.
2. Rotate the fixture to the desired position.
3. Hand-tighten the locking knobs.

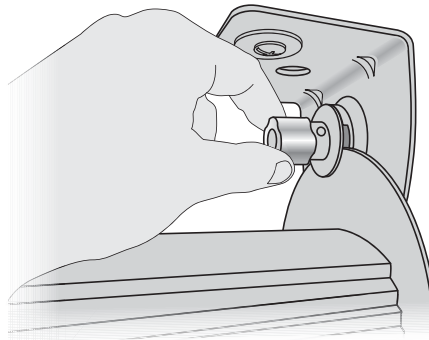

4. (Optional) You can use an M10 hex key wrench to lock the fixture securely in position.

Cleaning the ColorBlaze Housing and Air Intake Filter

ColorBlaze has a temperature monitoring feature that protects the fixture from extreme temperatures. If the operating temperature rises to an unsafe level, the lights dim to a dull red. After 30 minutes, the lights automatically return to full intensity and resume normal operation.

For additional heat protection, ColorBlaze features an onboard fan. At elevated ambient temperatures, the fan engages at half speed. If the ambient temperature continues to rise, the fan runs at full speed.

To help prevent overheating, we recommend that you inspect and clean the ColorBlaze housing and air intake filter regularly.

1. Disconnect power to the fixture. Never attempt to clean or service ColorBlaze with the power connected.

2. Rotate the fixture to access the sides of the fixture housing. Inspect the heat fins, and make sure they are free of debris and heavy dust.
3. Rotate the fixture to access the back of the housing, and locate the air filter intakes on either end.
4. Remove the four screws that hold the filter in place. Remove the filter, taking care to prevent the screws or washers from falling into the air intake.
5. Clean the filter with water, and dry it thoroughly.
6. Replace the filter, ensuring that the gasket and washers are positioned properly.

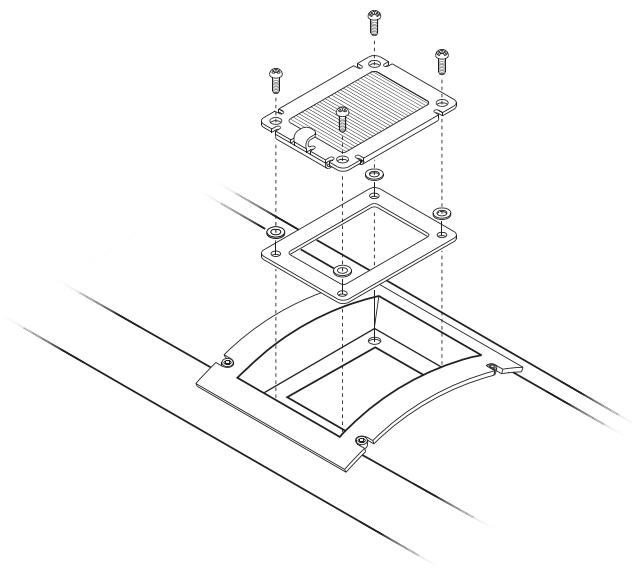
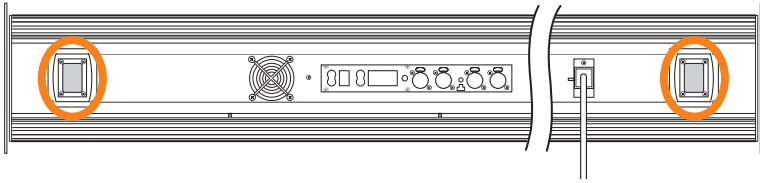

Cleaning ColorBlaze Lenses

You can remove and clean ColorBlaze lenses without removing the mounting handles or opening the fixture's housing.

1. Remove the retaining screws along top edge of housing. ColorBlaze 48 has five screws, and ColorBlaze 72 has six.
2. Tip lens out

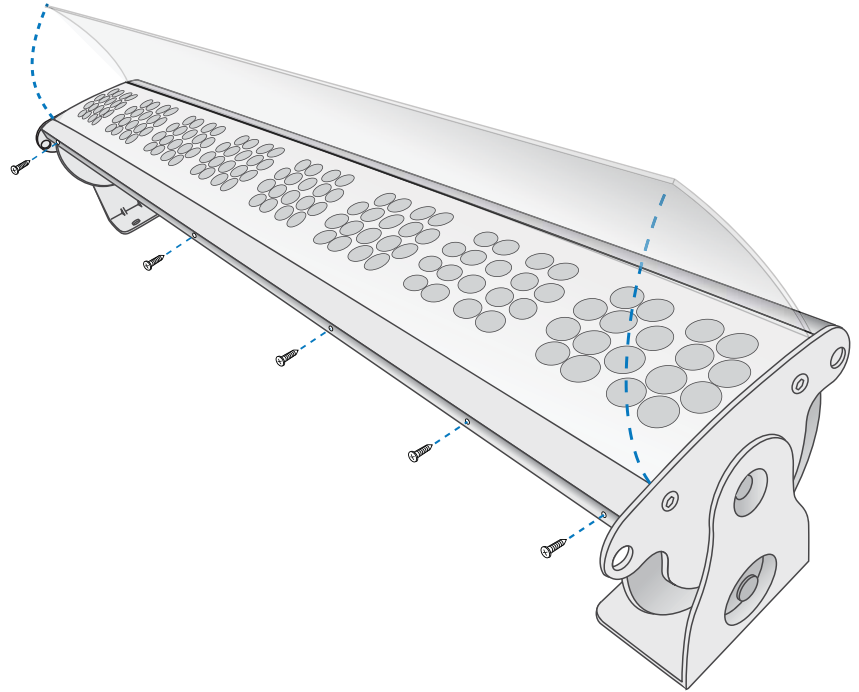

3. Clean the lens with water and mild detergent using a soft cleaning cloth. Wipe the lens dry.

Do not use paper towels, abrasive cleaning products, or window cleaners. Abrasive cleaning products will scratch the lens, and window cleaners will soften and mar the polycarbonate. Do not use solvents such as ammonia or isopropyl alcohol, which can scratch, pit, haze, yellow, or crack the lens.

4. Replace the lens, and secure it by replacing the removed screws.

Installing ColorBlaze Replacement Parts

A full range of replacement parts is available to keep ColorBlaze fixtures in service for the long haul. Replacement parts include power supplies, fans, air inlet filters, controller panels, LED boards, IEC connectors, lenses, and mounting brackets. For detailed installation instructions, download the ColorBlaze Replacement Parts Reference Guide from www.colorkinetics.com/ls/rgb/colorblaze/.



Philips Color Kinetics
3 Burlington Woods Drive
Burlington, Massachusetts 01803 USA
Tel 888.385.5742
Tel 617.423.9999
Fax 617.423.9998
www.colorkinetics.com

Copyright © 2009 Philips Solid-State Lighting Solutions, Inc. All rights reserved.
Chromacore, Chromasic, CK, the CK logo, Color Kinetics, the Color Kinetics logo, ColorBlast, ColorBlaze, ColorBurst, ColorGraze, ColorPlay, ColorReach, DIMand, EssentialWhite, eV, iColor, iColor Cove, IntelliWhite, iW, iPlayer; Light Without Limits, Optibin, and Powercore are either registered trademarks or trademarks of Philips Solid-State Lighting Solutions, Inc. in the United States and / or other countries. All other brand or product names are trademarks or registered trademarks of their respective owners. Due to continuous improvements and innovations, specifications may change without notice.

Cover Photo: Courtesy of Mark Thomas Productions, Ltd.

DAS-000014-00 R00 08-09