

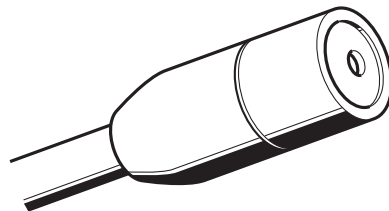

 **SENNHEISER**

MKE 2 GOLD

Bedienungsanleitung
Instructions for use
Notice d'emploi
Istruzioni per l'uso
Instrucciones para el uso
Gebruiksaanwijzing





Instructions for use

MKE 2 Gold

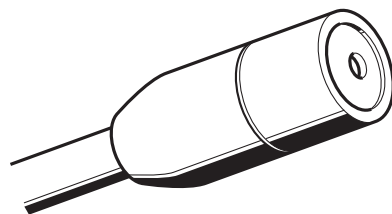

11





MKE 2 GOLD

Condenser clip-on microphone with omnidirectional characteristic for top sound-quality and robustness requirements. Suitable for vocal transmission, close-up miking, and miking of instruments in all fields of live sound transmission.

Characteristics

- ▶ Extremely small size, i.e. unobtrusive attachment to articles of clothing or the body.
- ▶ Insensitive to structure-borne noise.
- ▶ Linear frequency response.
- ▶ Largely insensitive to penetration of sweat due to the patented tandem diaphragm. This design comprises two individual diaphragms installed on both sides of the diaphragm ring. The bottom diaphragm is electrically active and forms the capacitive electroacoustic transducer together with the back plate. The top diaphragm is passive and seals the microphone against sweat. Robust sealing of the housing is ensured by a silicone ring. Since the diaphragms are extremely small and thin (less than $1\ \mu\text{m}$), the fact that they are made of different materials does not influence their acoustic properties – over a wide frequency range, these diaphragms oscillate like a tandem.

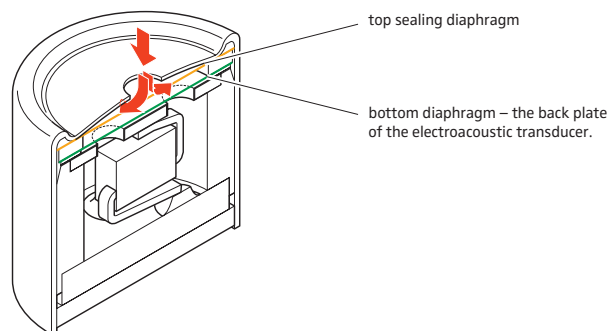

12





High note emphasis

Your microphone is delivered with two slip-on caps of different lengths. You may use these caps for high-note emphasis. Slip the cap on the head of the microphone until it locks into place. Please refer to the frequency diagrams on the pages 50 and 51.

- ▶ Short slip-on cap: MZC2-1 Cat. no. 076612
- ▶ Long slip-on cap: MZC2-2 Cat. no. 076645



Makeup protection

Please protect your MKE 2 GOLD by means of the makeup protection, if you attach your MKE 2 GOLD to your body and want to put on makeup. The makeup protection is easy to install: just slip it on the microphone (with or without slip-on cap). The makeup protection prevents makeup from penetrating into the gauze. Remove the makeup protection shortly before you enter the stage.

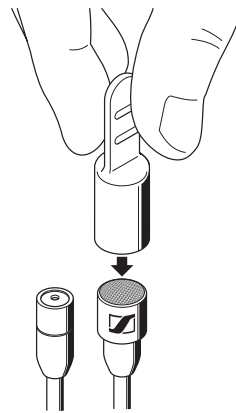

The makeup protection is available as accessory.

top sealing diaphragm

bottom diaphragm – the back plate of the electroacoustic transducer.





Attachment of the microphone

Depending on the field of application, you may attach the MKE 2 GOLD in different ways to either articles of clothing or your body.

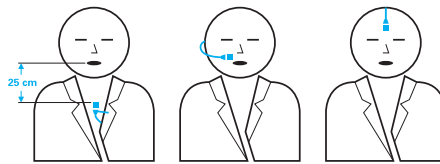

Attachment to articles of clothing

You may use the MZQ 2 GOLD clip to attach the microphone to your lapel, tie, collar, a button hole, etc. You may rotate the microphone holder in the clip in steps of 90°.

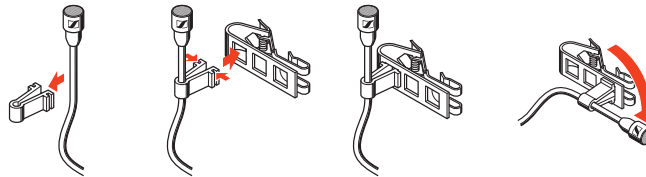

For thin clothes (e.g. silk), please use the outer hole where the clip's contact pressure is the highest.

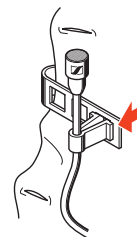



You may also use the MZS 2 pin to attach the microphone to articles of clothing made of fabric that will not be damaged by the pin. The pin attachment withstands high mechanical loads and is also a very convenient solution, if the articles of clothing do not have collars or edges to which the MZQ 2 clip can be attached.



The MZM 10 and MZM 2 magnetic clips can be used for unobtrusive attachment of the microphone to articles of clothing. The frictional force between the microphone and the fabric is often sufficient to ensure that the microphone is not displaced. For smooth and soft clothes, the neckstrap (included) ensures that the microphone is not displaced from its proper position.



Examples of use

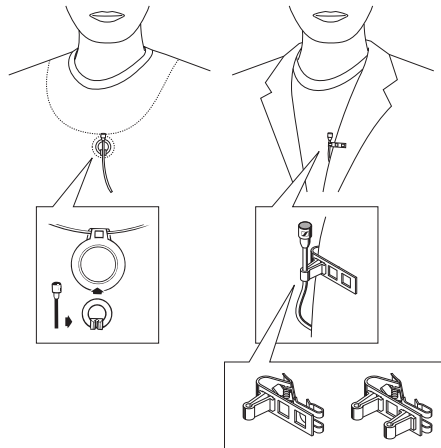



Wind-shields

Wind noise impairs the quality of outdoor recording and close-up miking. The MZW 2 and MZW 02 wind-shields considerably reduce the wind noise.

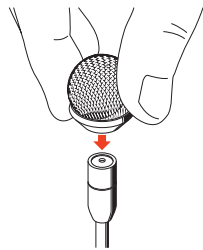

Please install the MZW 2 wind-shield, first. This wind-shield reduces the wind noise by a maximum of 20 dB.

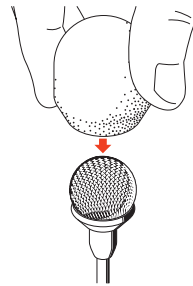

You may further reduce the wind noise by 10 dB by means of the additional MZW 02 foam-net wind-shield.

MZW 2 and MZW 02 are available as accessories.



Freefield frequency response

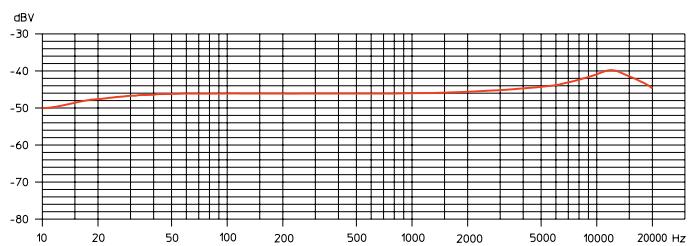

16



MKE 2 - Technical data in comparison

MKE 2...	-2R GOLD	-2R-3 GOLD	-4 GOLD	-4-3 GOLD	-60 GOLD	-5 GOLD	-5-3 GOLD
Directional characteristic	omni-directional omni-directional omni-directional omni-directional omni-directional omni-directional omni-directional						
Transmission range	20-20000 Hz ±3 dB	20-20000 Hz ±3 dB	20-20000 Hz ±3 dB	20-20000 Hz ±3 dB	20-20000 Hz ±3 dB	20-20000 Hz ±3 dB	20-20000 Hz ±3 dB
Free-field open-circuit sensitivity (1kHz)	5 mV / Pa ±2.5 dB	5 mV / Pa ±2.5 dB	5 mV / Pa ±2.5 dB	5 mV / Pa ±2.5 dB	5 mV / Pa ±2.5 dB	5 mV / Pa ±2.5 dB	5 mV / Pa ±2.5 dB
Rated impedance	1000 Ω	1000 Ω	1000 Ω	1000 Ω	200 Ω	1000 Ω	1000 Ω
Min. terminating impedance	4.7 KΩ	4.7 KΩ	4.7 KΩ	4.7 KΩ	1 KΩ	4.7 KΩ	4.7 KΩ
Equivalent noise level A-weighted (DIN IEC 651) CCIR-weighted (CCIR 468-1)	26 dB 39 dB	26 dB 39 dB	26 dB 39 dB	26 dB 39 dB	27 dB 40 dB	26 dB 39 dB	26 dB 39 dB
Sound pressure level limit	142 dB	142 dB	142 dB	142 dB	142 dB	142 dB	142 dB
Feed	via SK 2012 transmitter Microdot	via SK 2012 transmitter Microdot	via SK 3063-U transmitter special connector 4-pin	via SK 3063-U transmitter special connector 4-pin	via SK 3063-U transmitter special connector 4-pin	via K6/K6P powering modular cable	open-ended cable
Plug	Microdot	Microdot	special connector 4-pin	special connector 4-pin	special connector for system K6	special connector	open-ended cable
Colour	anthracite	beige	anthracite	beige	anthracite	anthracite	beige
Cable length	1.6 m	1.6 m	1.6 m	1.6 m	3 m	4 m	4 m
Diameter of the microphone	4.8 mm	4.8 mm	4.8 mm	4.8 mm	4.8 mm	4.8 mm	4.8 mm
Weight (without plug+cable)	1 g	1 g	1 g	1 g	1 g	1 g	1 g
Delivery includes:							
MZC 2-1 slip-on cap	1	1	1	1	1	1	1
MZC 2-2 slip-on cap	1	1	1	1	1	1	1
Operating instructions	1	1	1	1	1	1	1

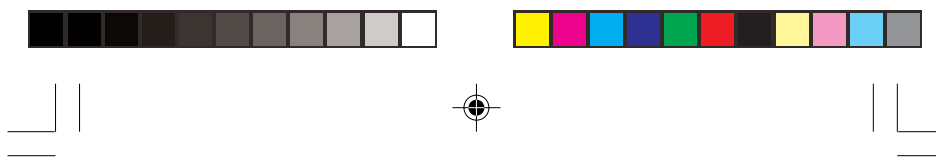



18



MKE 2 gold 10/05

18

31.10.2005, 12:15 Uhr

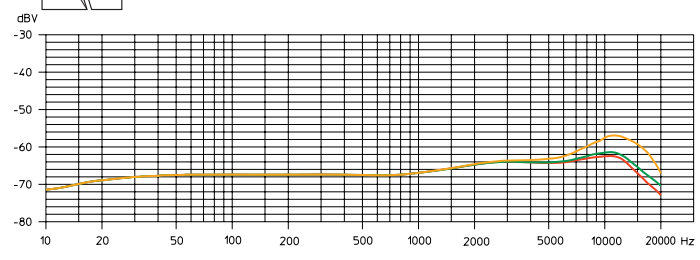

Microphone placed in the middle of the forehead
 — capsule only — with MZC2-1 — with MZC2-2

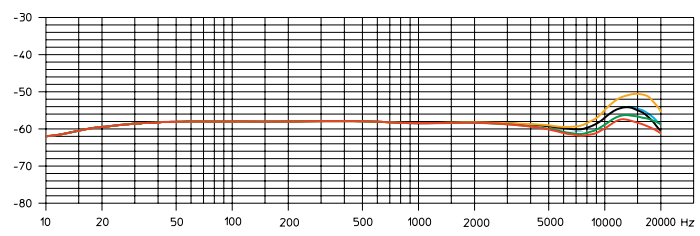

Microphone placed in the corner of the mouth, distance to the mouth 3cm
 — capsule only — with MZC2-1 — with MZC2-2
 — with MZW2 — with MZW2 and MZW02

50



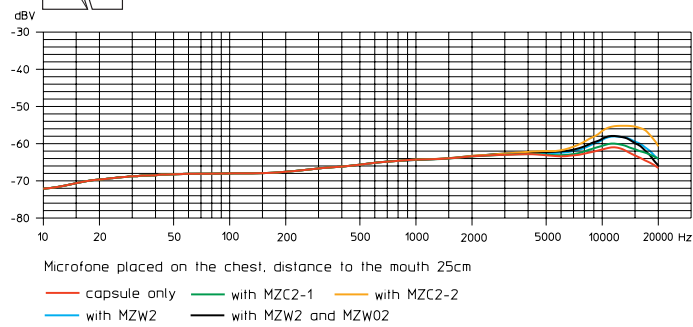

Konformitätserklärung

Dieses Gerät erfüllt die anwendbaren CE-Normen und Vorschriften.

Approval

This device is in compliance with the applicable CE standards and regulations.

Certification

Cet appareil est en conformité avec les normes CE.

Certificazione

Questo apparecchio risponde alle normative e alle prescrizioni CE applicabili.

Autorización

Este aparato cumple las normas y directrices de la CE aplicables.

Vergunning

Dit toestel voldoet aan de toepasselijke CE-normen en voorschriften.





Änderungen vorbehalten
Subject to alterations
Sous réserve de modification
Con riserva di modifiche
Reservado el derecho a introducir modificaciones
Wijzigingen voorbehouden



Sennheiser electronic GmbH & Co. KG
30900 Wedemark, Germany
Phone +49 (05130) 600 0
Fax +49 (05130) 600 300
www.sennheiser.com

Printed in Germany

Publ. 10/05

077490/ A04

