



DS Series Digital Snake

Thank you for purchasing a Whirlwind DS series digital snake. The DS series offers exceptional performance, ease of use, and extreme flexibility. There are 2 models, the DS168 with 16 inputs and 8 returns and the DS328 with 32 inputs and 8 returns. CobraNet is the digital transport used, making DS series products excellent I/O devices for any CobraNet network. This manual will help you get the most from your system so please read it, keep it handy, and refer to it if you have problems. Technical support is available at 800-733-9473 or techsupport@whirlwindusa.com.

Unpacking: Each DS series snake includes the unit, an AC power cord, a quick start manual, and a disc with an expanded manual and CobraNet Discovery software on it. Keep the packaging, in the unlikely event you need to return the unit for service, using the original packaging will help insure a safe trip.

TABLE OF CONTENTS

Front Panel: connections and controls.	Page 2
Rear Panel: connections and controls.	Page 3
Using your digital snake as a basic system.	Page 3
Using your digital snake as a high channel count system.	Page 4
Advanced Settings: Cobranet Discovery.	Page 4
Preparing your computer for CobraNet Discovery.	Page 5
Setting up CobraNet Discovery.	Page 8
Using your digital snake in a multiple split DS system.	Page 13
Using your digital snake as a CobraNet I/O device.	Page 17
CobraNet bundle assignments.	Page 18
Specifications.	Page 19

Overview: The typical Whirlwind DS series digital snake system consists of two components: a transmitter module (either a DS168T or a DS328T) and its matching receiver module (either a DS168R or a DS328R). The transmitter "T" unit is the input side of the system and the receiver "R" is the output side.

Front Panel: This section describes the transmitter modules. The receiver modules are similar, having 8 analog inputs and either 16 or 32 analog outputs and either 1 or 2 digital outputs.

Connections and controls:

- A. Locking female XLR connectors are provided for each input channel.
- B. Male XLR connectors are provided for each return (output) channel.
- C. Power: Flip this switch to the "ON" position to power the unit. (The main power switch on the rear must also be on). A red light indicates the unit is on.
- D. Gain control: The gain control offers a 60dB range (-30dBV to +30dBV), allowing the use of a wide variety of inputs. With signal applied, adjust the gain control until the Overload LED just begins to flash. Now reduce the gain about 10dB to give yourself some headroom.
- E. 48V (Phantom Power): Move the switch to the ON position (to the right) if you are using a condenser microphone or a direct box that requires 48 Volts of phantom power. (This switch should be in the Off position when you are patching to prevent popping in your system.)
- F. Digital Input: The DS series snakes give you the ability to also send SPDIF or AES/EBU digital signals through the snake.
 - With the switch in the IN 1,2 position, analog signals will be sent on channels 1 and 2 of the snake. No digital signals can be sent.
 - With the switch in the SPDIF position and a SPDIF cable connected to the RCA jack, a SPDIF signal can be sent through the snake. In this position, analog channels 1 and 2 and AES will not function.
 - With the switch in the AES position and an AES cable plugged into the AES XLR an AES signal can be sent through the snake. In this position, analog channels 1 and 2 and SPDF will not function.

The DS328 gives you an additional digital input that operates in the same fashion on channels 17 and 18.

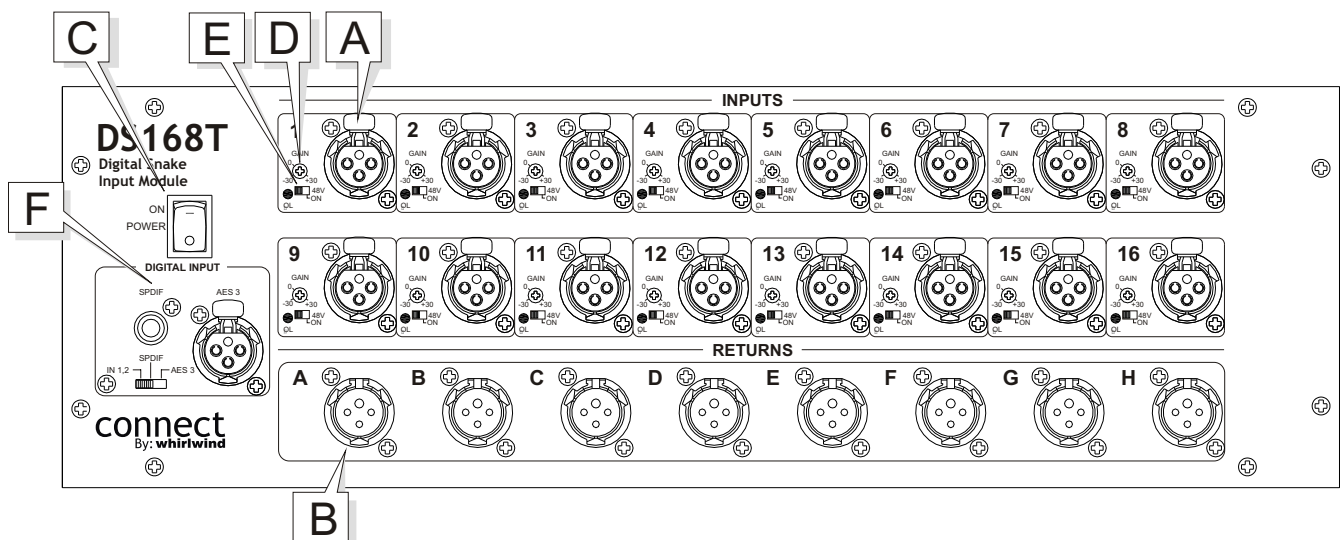

Rear panel: The rear panel connections of transmitter and receiver modules are identical.

Connections and switches:

- A. Female DSUB25: These are paralleled to the XLR connectors on the front panel and are wired to the Tascam analog standard. These allow for an analog split to a monitor console on the DS168T and DS328T units or as alternate input/output connections on any DS unit. Whirlwind cables from the DBF-1 or DBM series are an excellent choice for this purpose.
- B. Neutrik Ethercon: This RJ45 connector is provided for connection to a CobraNet network or to another DS series snake. When a proper connection is made the green LED over the connector will flash.
- C. I.E.C. power inlet: This is provided for use with the included A.C. cable.
- D. "Selector" switch: Allows you to choose between 115 (default) or 230 Volt operation.
- E. "Main Power" switch: This switch must be in the On position for the front panel Power switch to be operational.

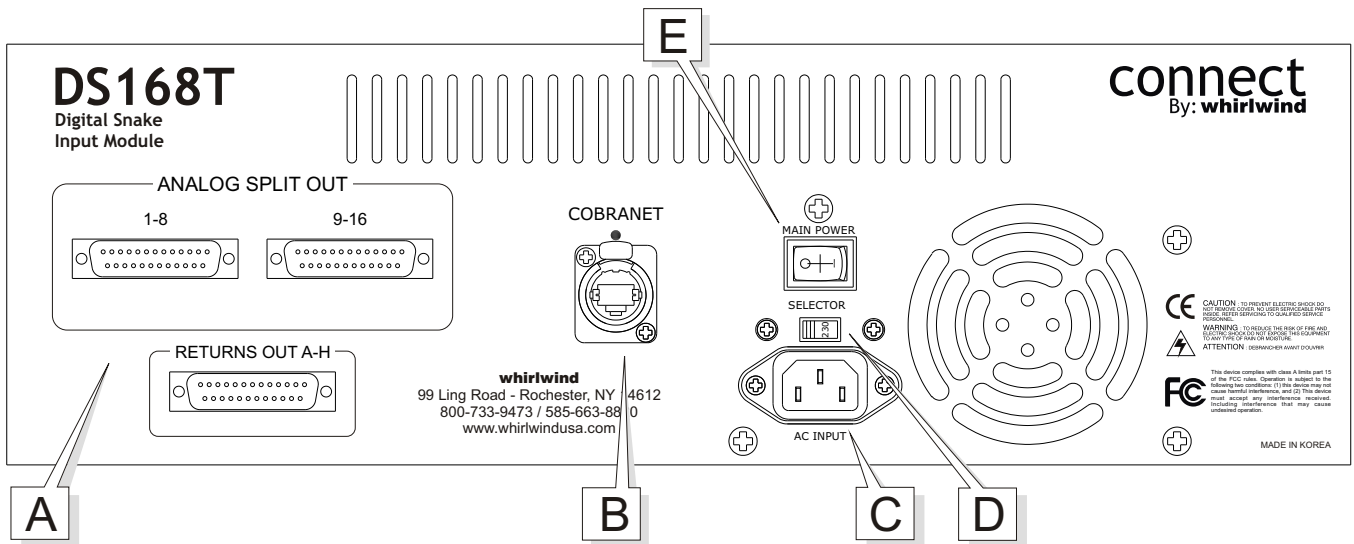

Using your digital snake:

Basic system:

The DS series digital snakes are designed to be simple plug and play devices. If you are using a DS168T or DS328T Input Module with its matching Output Module, simply connect a Cat5e cable between the two units, power them up, make your analog connections, adjust your input levels and enjoy the show (Fig. 1).

Note: The maximum length for Cat5e cable is 328 feet (100 meters).

Fig. 1

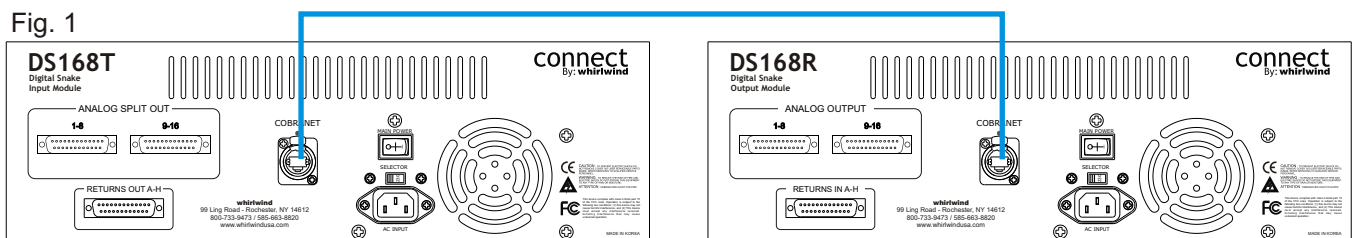

Cat5e

High channel count system:

A DS168T/R system can be combined with a DS328T/R system to create a 48x16 channel digital snake. A piece of Cat5e cable can be run for each system (Fig. 2) or both “T” units can be connected to an Ethernet switch at one end, while both “R” units are connected to an Ethernet switch at the other end. A single piece of Cat5e then connects the two switches (Fig. 3).

Note 1: The maximum length for Cat5e cable is 328 feet (100 meters).

Note 2: Multiples of the same unit, ie: (2) DS168T, (2) DS328T, (2) DS168R, or (2) DS328R can not operate on the same network without making changes to the CobraNet parameters in one of the units. This procedure is outlined beginning on page 14.

Fig. 2

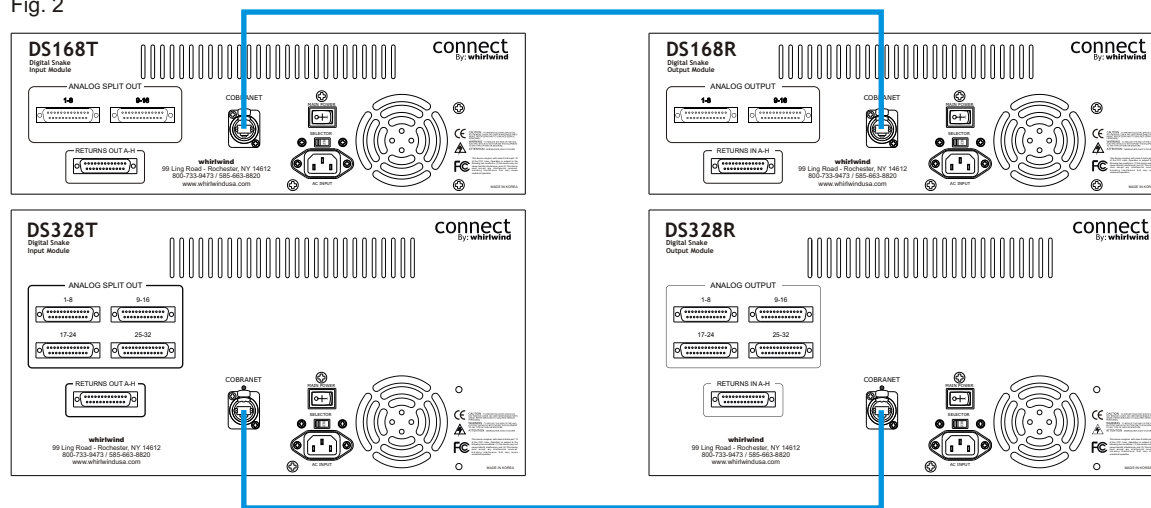
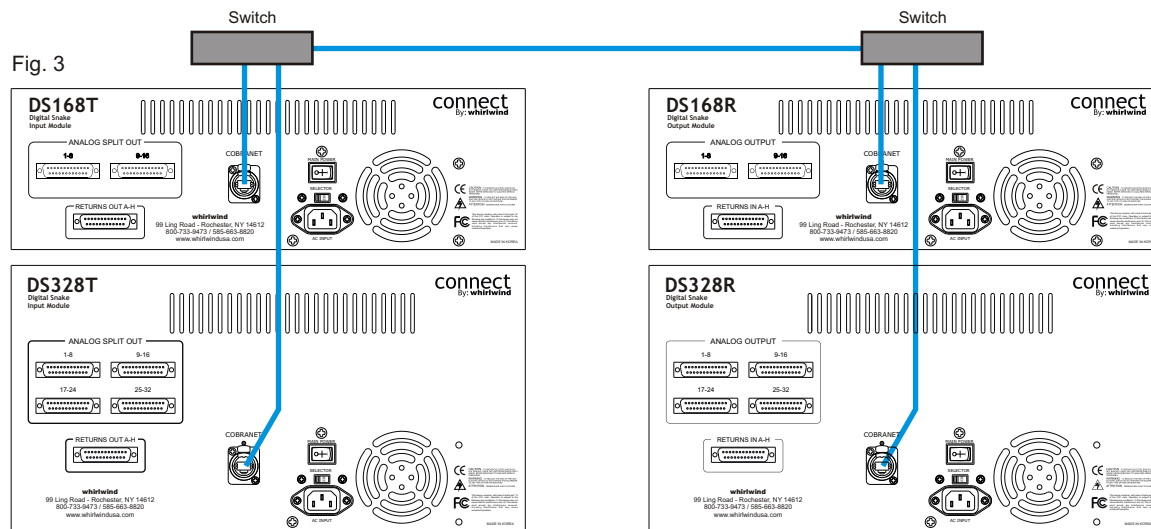

Fig. 3



Cat5e

Advanced Settings: CobraNet Discovery

Many of the systems described in the remainder of this manual will require using CobraNet Discovery (Disco) software to change parameters in your DS series snakes. Two versions of Disco are on this disc: Version 3.4.5 is for computers using Windows XP and 4.0.2 is for those using Vista. (The following install was done on an XP machine.) A complete manual for Disco is also installed with the software. The steps outlined in this manual are only a part of what Disco can do, but should be sufficient for most applications.

Preparing your computer for CobraNet Discovery: Before installing CobraNet Discovery you need to make a few modifications to your computer's IP settings. Begin by clicking the start button on your desktop, select the Control Panel option and click it.

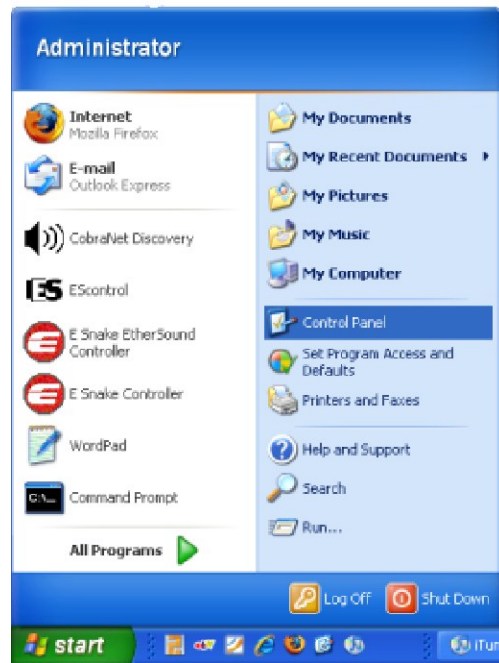

Then click on the "Network and Internet Connections" icon.

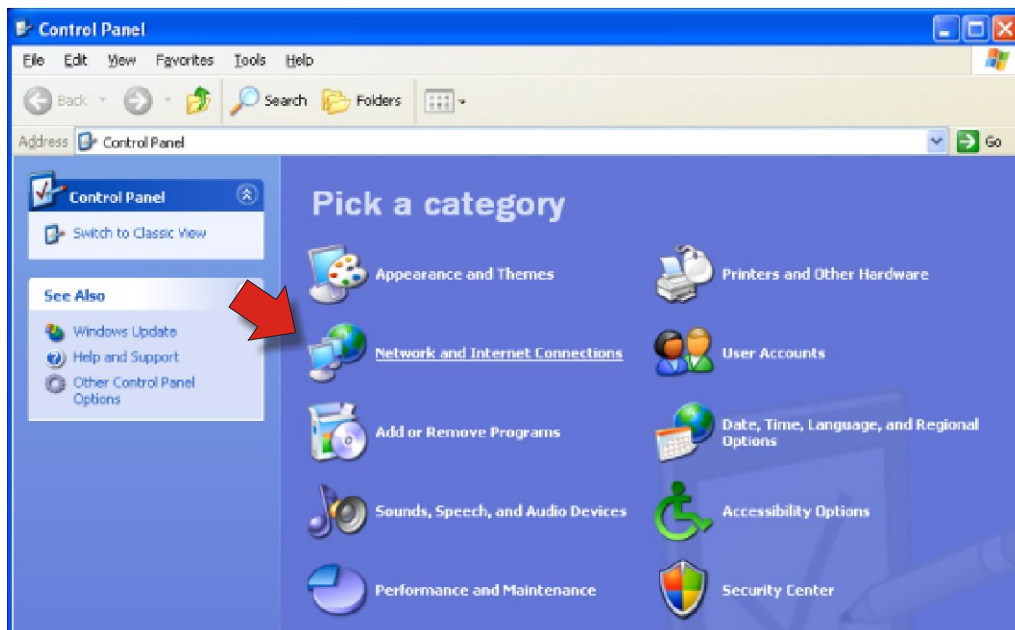

Click on the "Network Connections" icon.

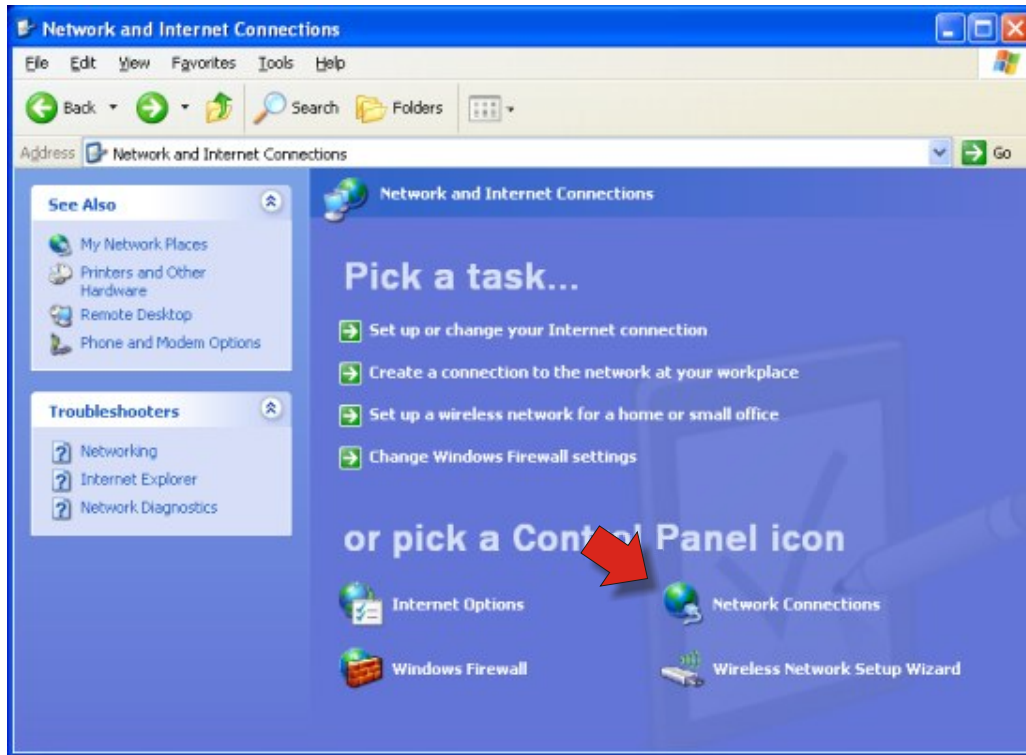

Choose the NIC card you will be using for your CobraNet network, right click, select "Properties" from the menu and click it.

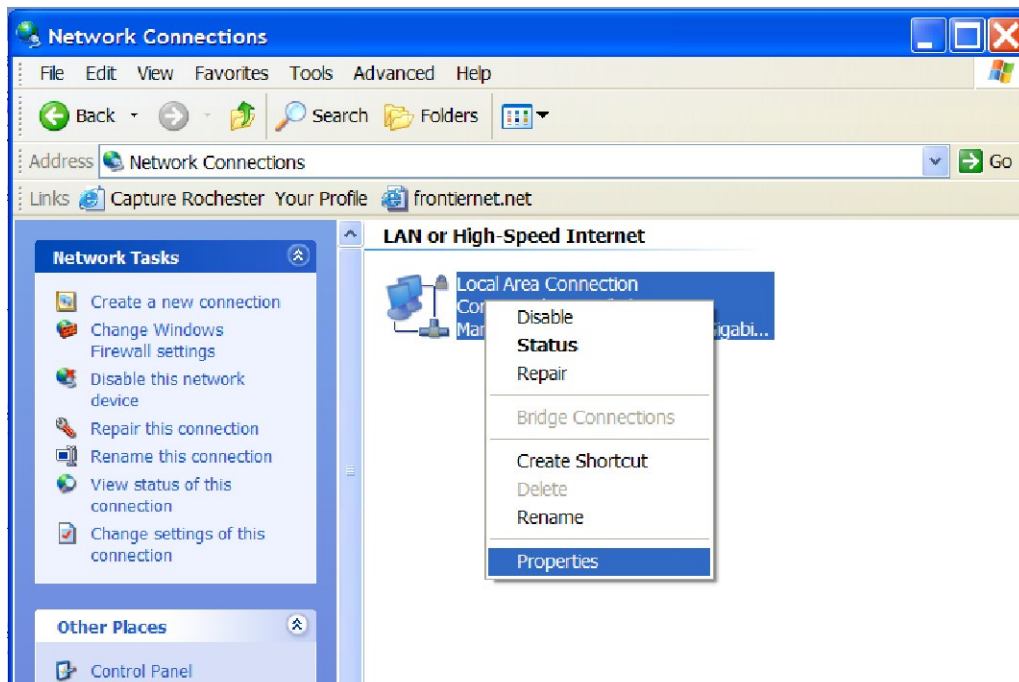

Select Internet Protocol (TCP/IP), then click the "Properties" button.

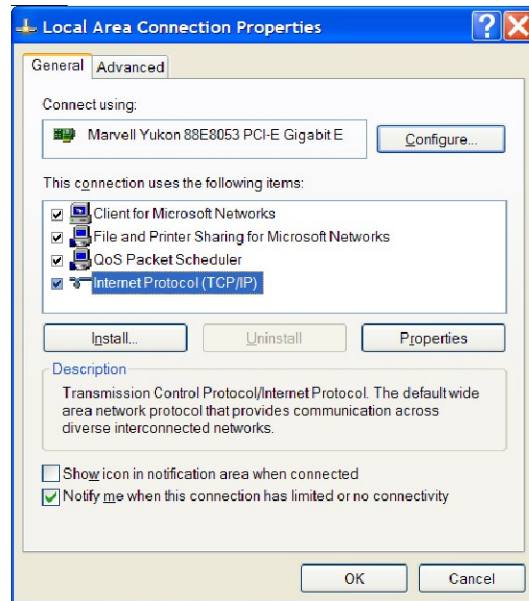

Choose the "Alternate Configuration" tab. Select the "User Configured" option and enter the IP address 169.254.1.1 as shown below and click OK. You can now close this window. This procedure ensures that when you use this computer to access your CobraNet network it will always be in the proper IP range. You are now ready to install CobraNet Discovery.

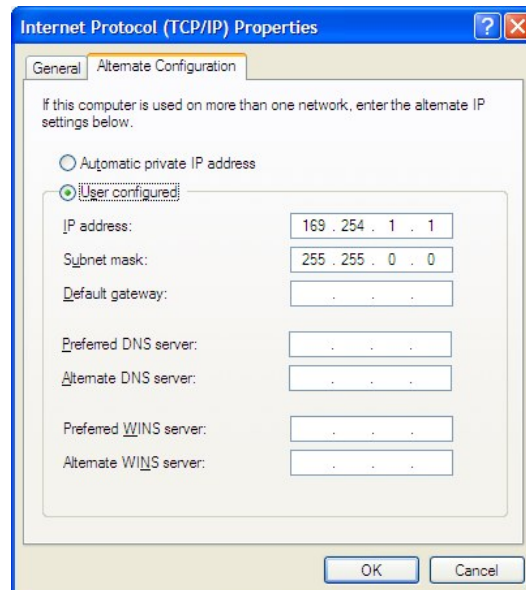

Setting up CobraNet Discovery:

After installing Disco, the first time you launch the application the screen will look like this:



Under the "Tools" menu choose "Options", the following Dialog Box will appear. Use the Drop Down arrow to locate your computer's Network Interface Card (NIC) that is connected to your CobraNet network and select it. There may be default settings in the IP Address Range Start and End boxes. Change these values to those shown below. Most computer data networks use the 192.168.1.255 IP range, changing the values of your audio network to those shown below will help isolate it from your computer data network.

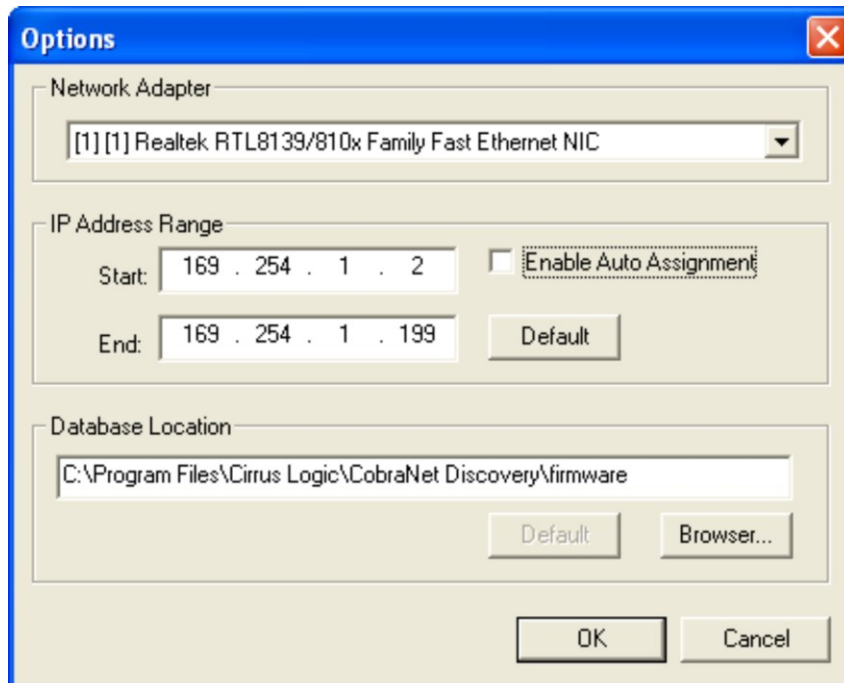

After making your changes to the Start and End range, check the Enable Auto Assignment box. Click the OK tab and close the Dialog Box.

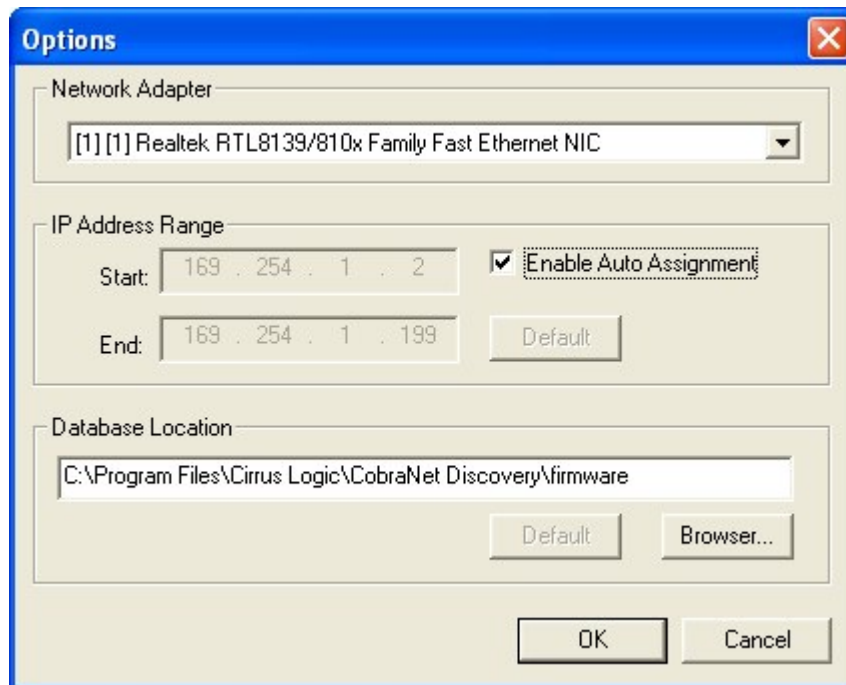

In addition to giving you the ability to change parameters, Disco is a great place to see information about the hardware on your network. To get the most out of it you need to add information “Columns” to the main display. Under the “View” menu choose “Column Chooser”. You will see the following dialog box:

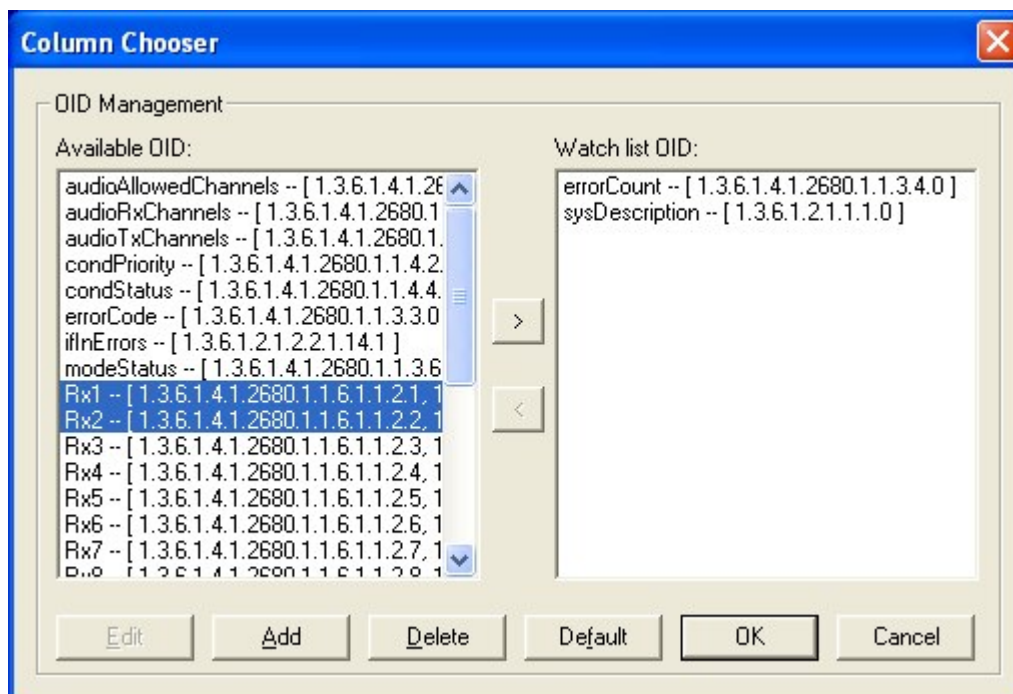

Highlight the columns in the left display that you want to see in Disco. RX1, RX2, syslocation, TX1 and TX2 are a good place to start. Additional columns can always be added later if you need them. Highlight each selection and use the right arrow in the middle of the two displays to move the selection to the right display. When you are done, click the OK button and close the dialog box. Disco will now look like this:

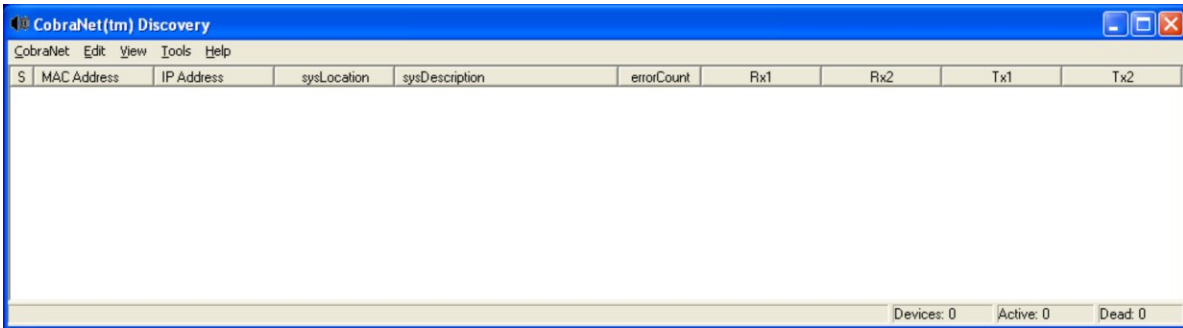

If a DS168T and a DS168R are added to the network, Disco will update and you will see this information in the display:

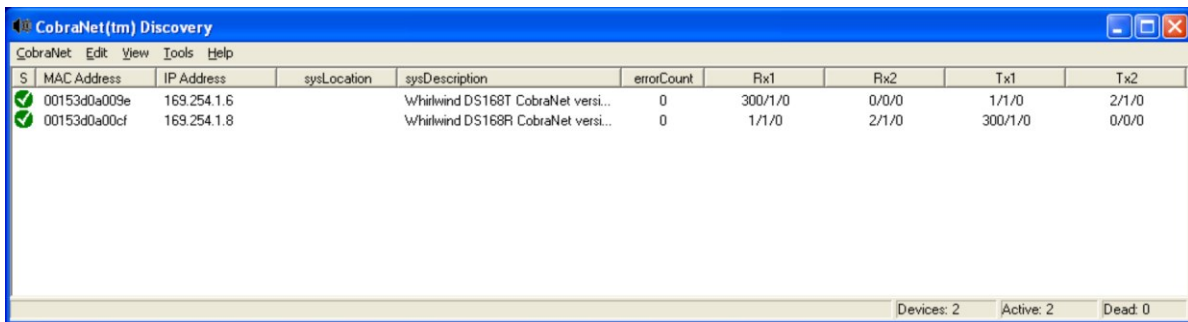

MAC ADDRESS: The second column from the left shows the MAC Address of each CobraNet device on the network. This is a permanent identifier for the device. The IP Address of each device may change but the MAC Address never will. A DS168 has one MAC Address. A DS328 has two, channels 1-16 are in the first MAC Address shown in Disco, channels 17-32 and A-H are in the second.

The "syslocation" column is where the name you have given a device will be shown. To do this, highlight the unit you want to name, then choose the "Configure" option:

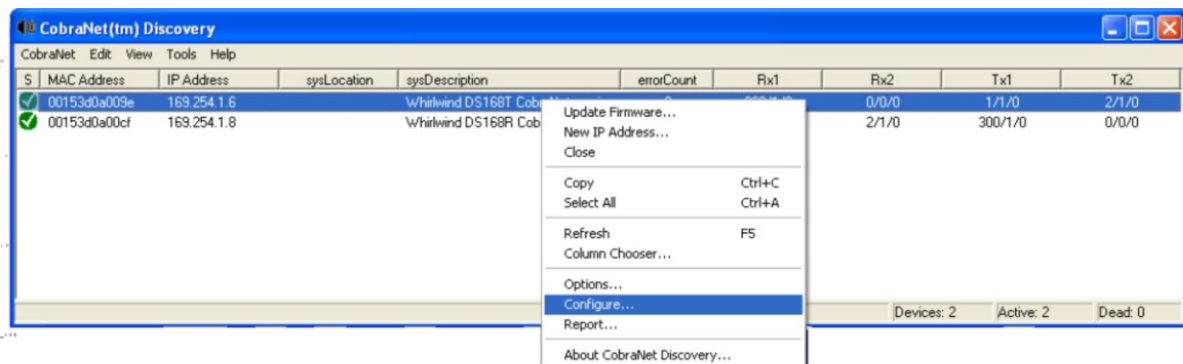

You will see this Dialog Box:

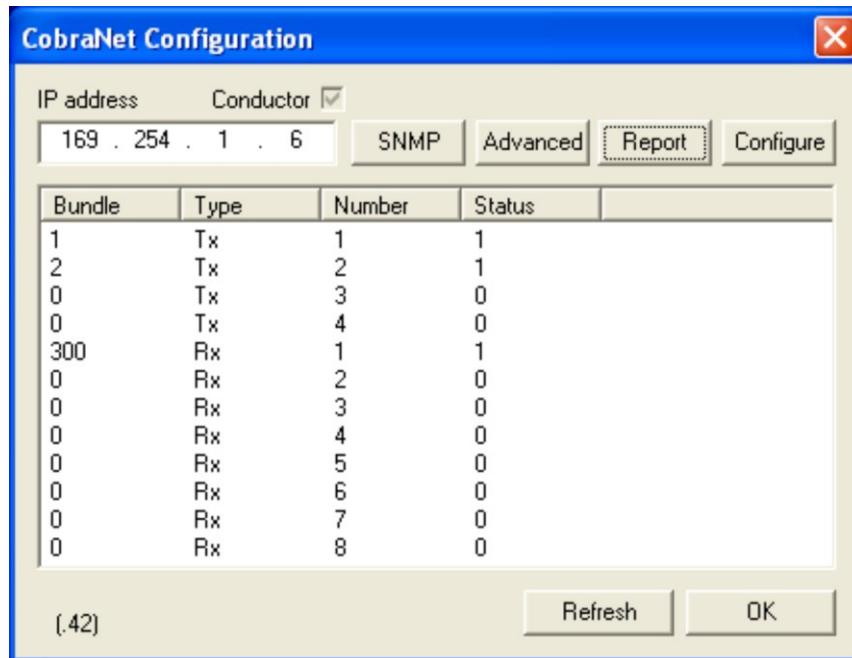

Highlight any of the active transmitters (Tx) or receivers (Rx):

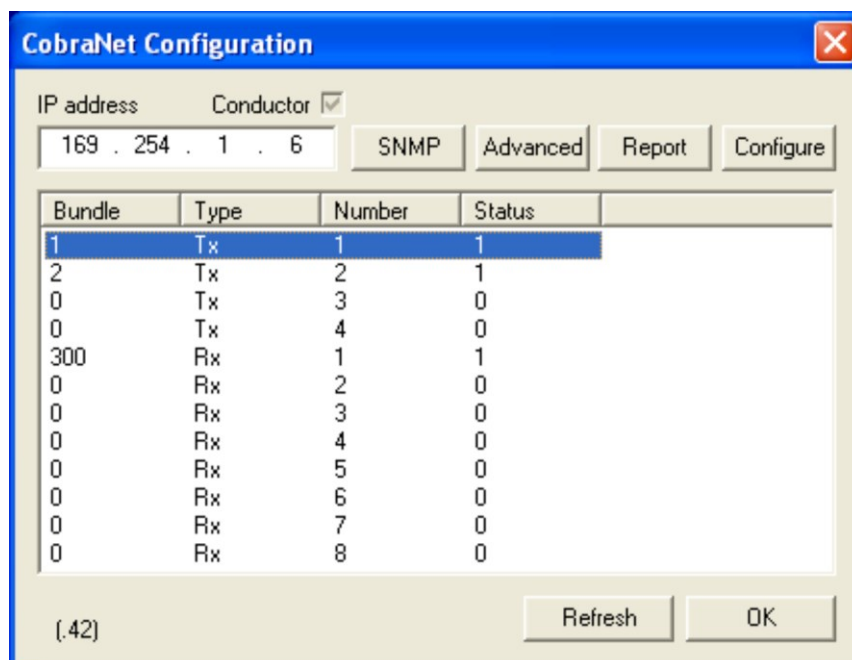

Click the “Advanced” button to display the "Advanced Configuration" dialog box (shown below on the left). In the Location box, type in the name you want to give the device. In our example we used STAGE for the “T” unit and F.O.H. for the “R” unit. Check the Persistence box at the top of the panel, click “Apply”, and then click “OK” (shown below on right). If you do not turn Persistence on, any change you make will be temporary and will be lost when the unit is power cycled.

This is also where you can change the latency setting of your DS snake if necessary. Use the Drop Down arrow of the "modeRate Control" box. Choose 48 kHz, 1 1/3 mS, 2 2/3 mS or 5 1/3 mS. Do not use the 96 kHz options.

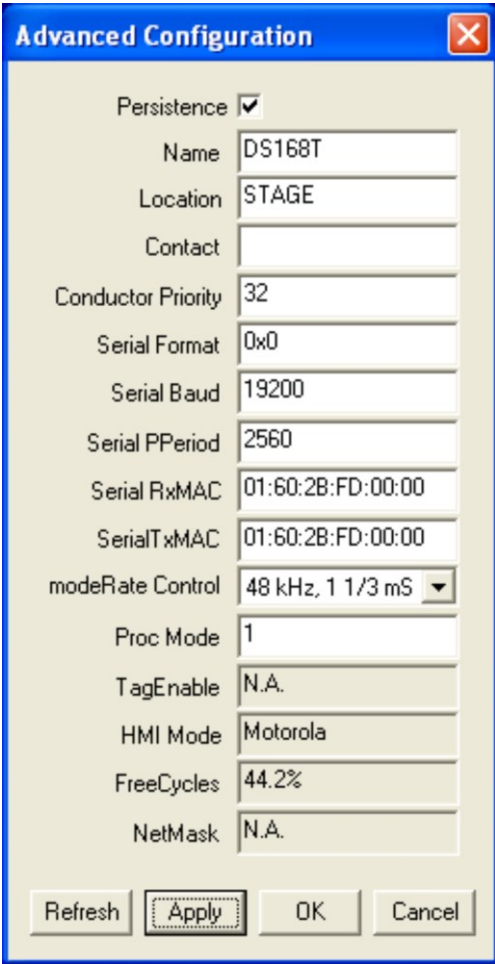
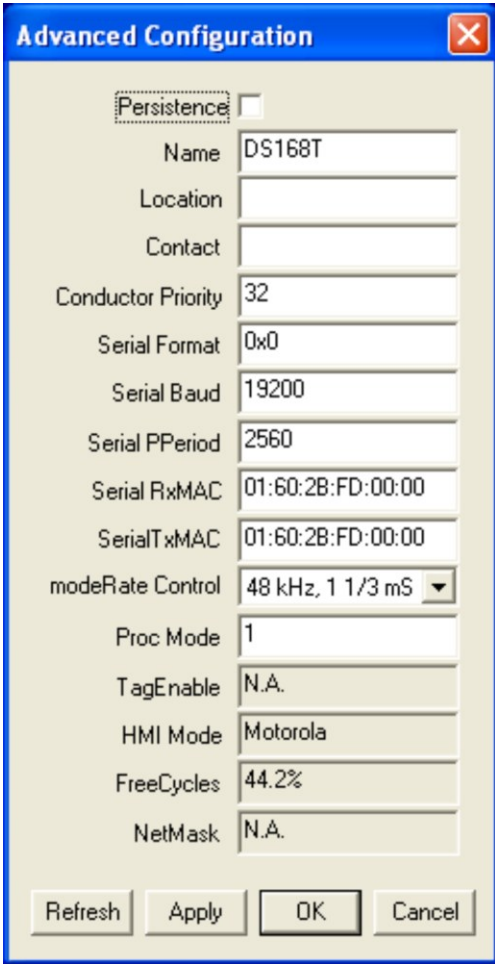

When done, you will have a screen like this:

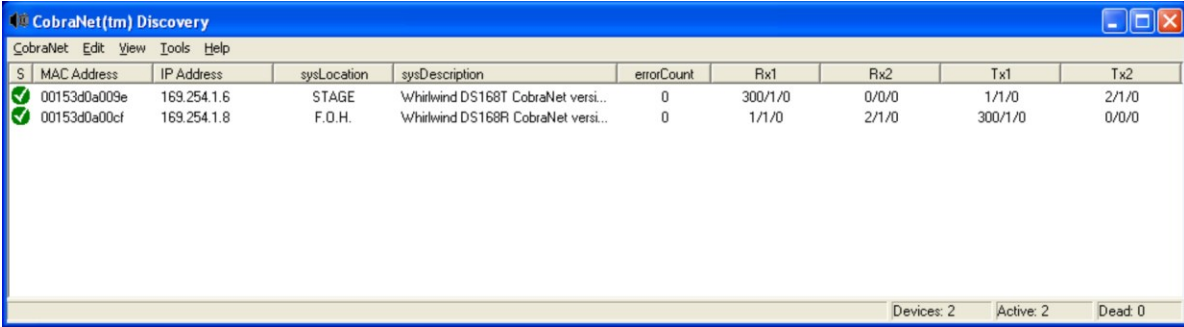

You can use this procedure to name all the CobraNet devices on your network. This will make it easier for you to identify a particular unit when you have multiples of the same device in your system. Disco is also a great place to quickly troubleshoot your system. If a device is having a network related problem, you will see a red X next to the MAC Address of that device. This tells you that the unit is offline, or that there is a problem with the network. When the problem is resolved, the green check will reappear.

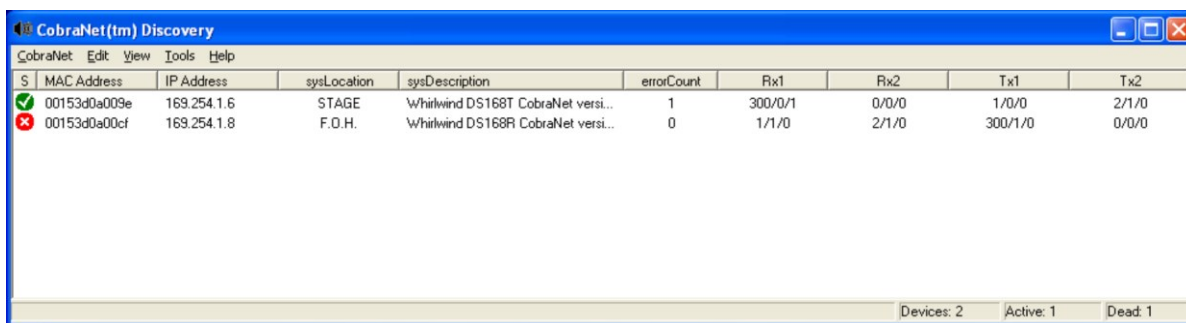

Now that Disco is installed, and you are comfortable with it, you can start building networks with your DS series snakes.

Multiple split DS system: A DS168T or DS328T input device can transmit to multiple corresponding “R” output devices for Front Of House, monitors, recording, broadcast or remote location mixing. All DS units on the network are connected to an Ethernet switch (Fig. 4). The DS series snakes transmit their audio in 8 channel “bundles”. The “T” units transmit their inputs using “multi-cast” bundles. Any and all CobraNet devices on the network that are set to receive these bundles, and have the same bitwidth and latency settings as the “T” units will receive these audio channels. The “R” units transmit their Return inputs using “uni-cast” bundles. This means that only one CobraNet device on the network with the same bundle number, bitwidth and latency settings will be able to receive this particular bundle.

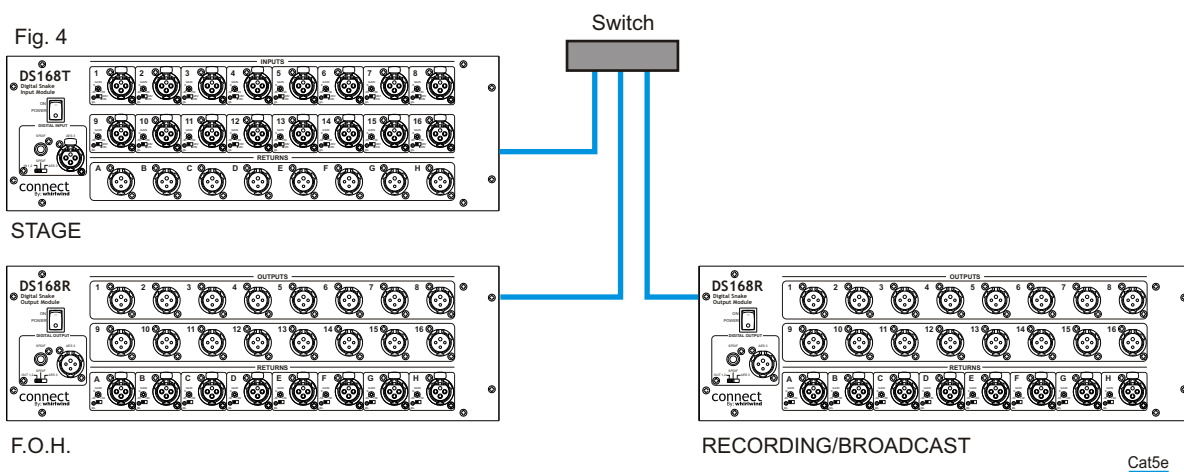

Cat5e

In the system in Fig. 4, the bundle number of the DS168R's 8 channels of return (A-H) at Recording/Broadcast and at Front of House are the same (300). Whichever DS168R is turned on first is the one that will be transmitting to the DS168T on stage, the other DS168R will not be able to transmit its returns. This can be changed by using Disco to alter the bundle numbers. Open Disco, highlight the Recording DS168R, scroll down to "Configure" and select it. This dialog box will appear:

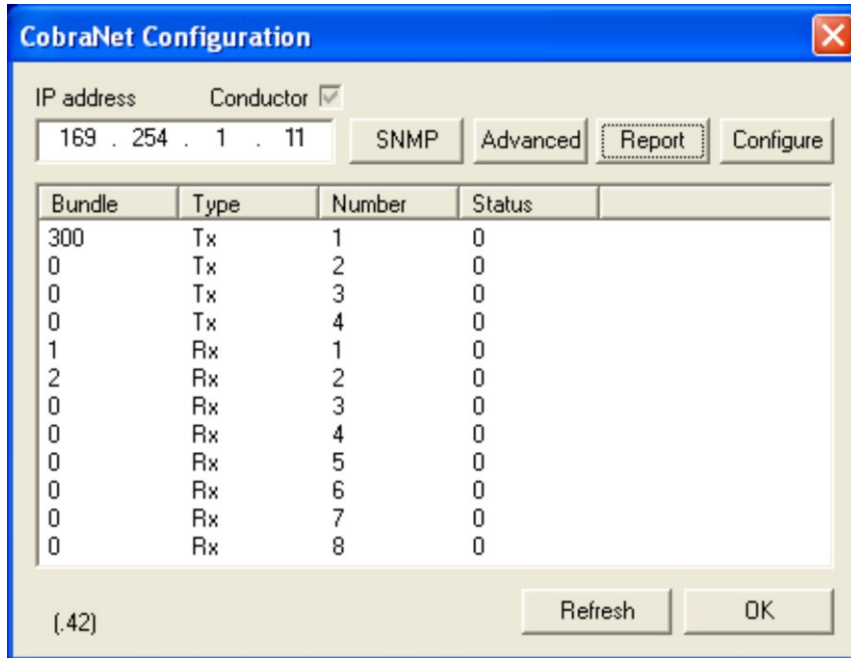

Highlight Tx 1 which carries the eight channels of Return inputs:

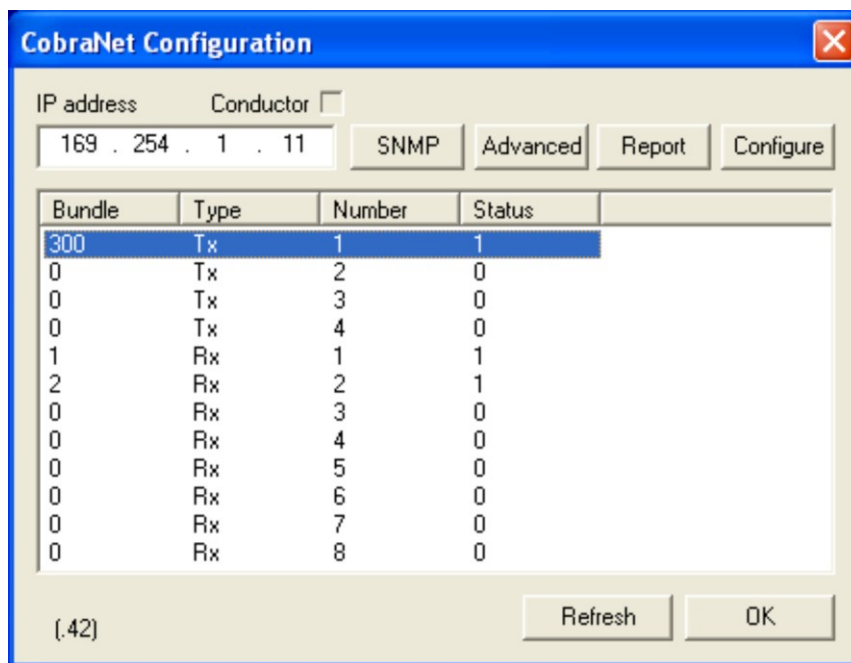

Then Click on 300:

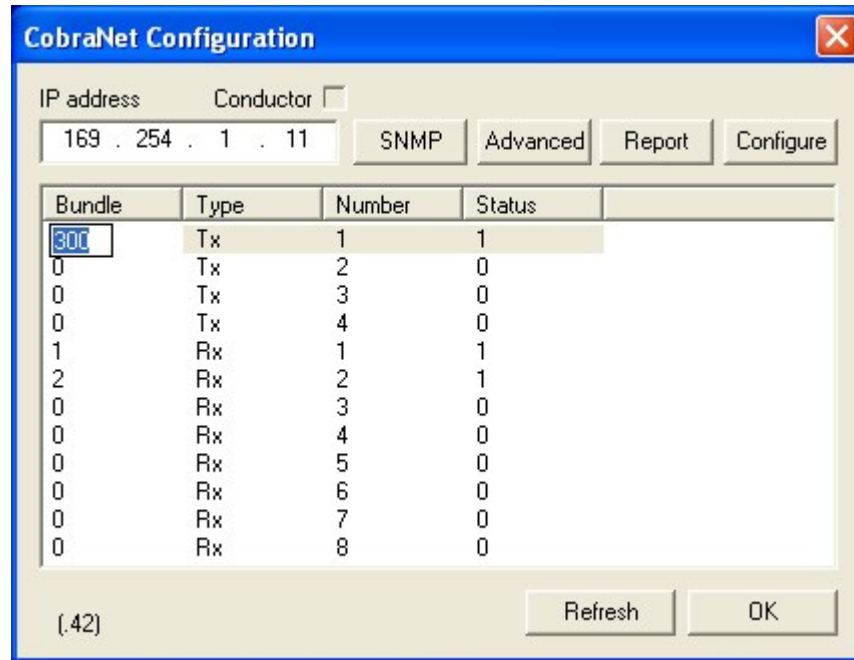

Change this to 0:

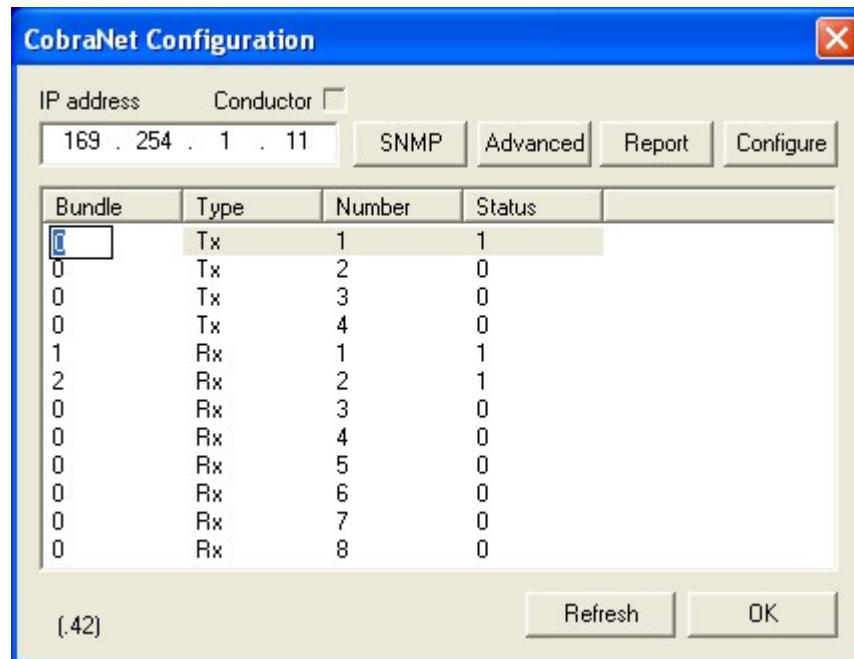

Make sure you have Persistence turned on (see page 9), then click OK.

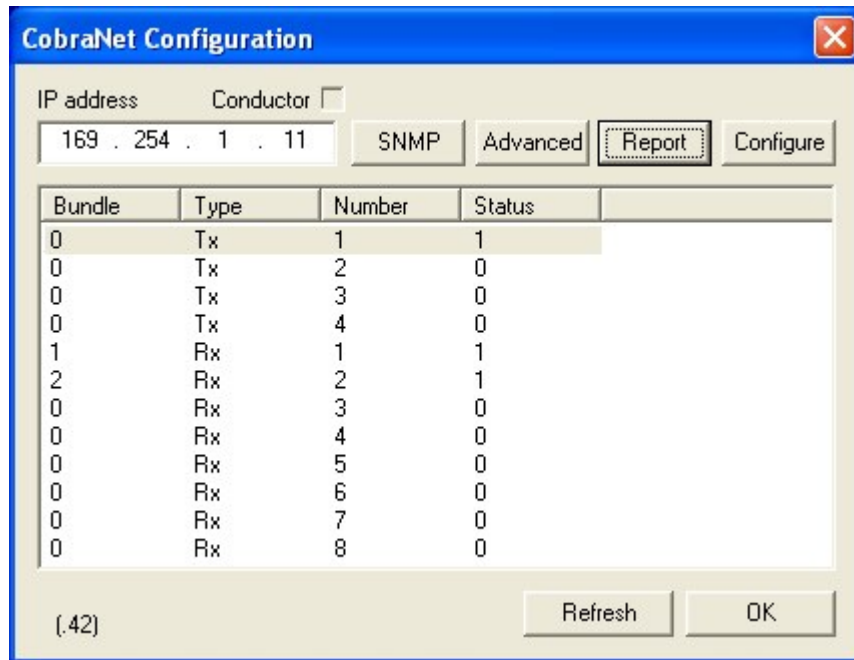

You have now turned off the Returns of the DS168R at Recording (Fig. 5). The returns from F.O.H. will work properly regardless of which "R" unit is turned on first. If you have more than two DS168Rs on the network perform the same procedure for the other units. A DS168 was used for this example, the same procedure is followed when multiple DS328 units are used.

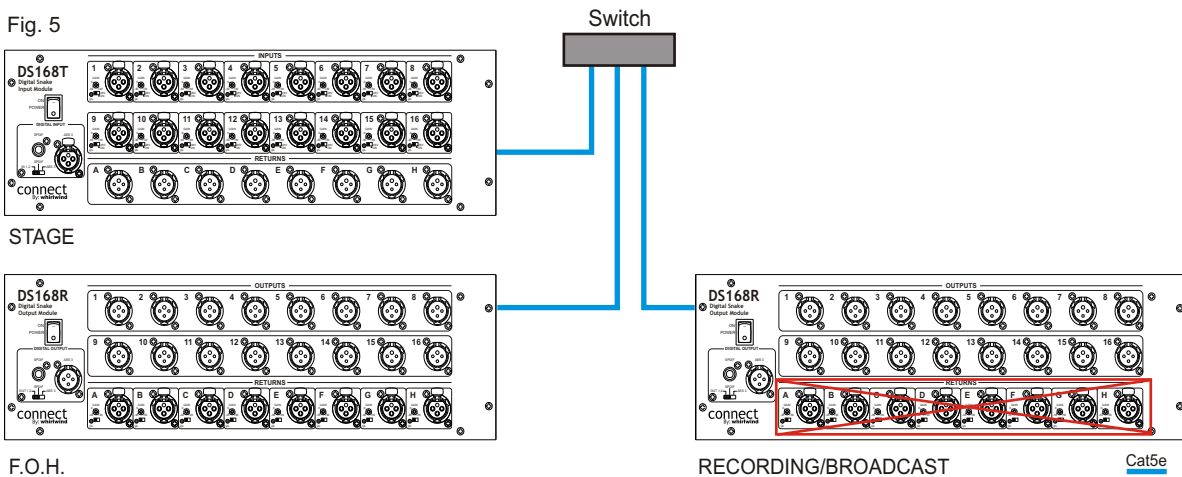

If you would like the Returns (A-H) of Recording/Broadcast to transmit to the stage, you can add an output device like Whirlwind's CO8a at the stage (Fig. 6). Instead of setting TX 1 of the Recording/Broadcast DS168R to 0, set it to another bundle such as 301. Now set the CO8a to receive 301 and you're all set. The returns from F.O.H. and Recording/Broadcast will all be available at the stage.

Fig. 6

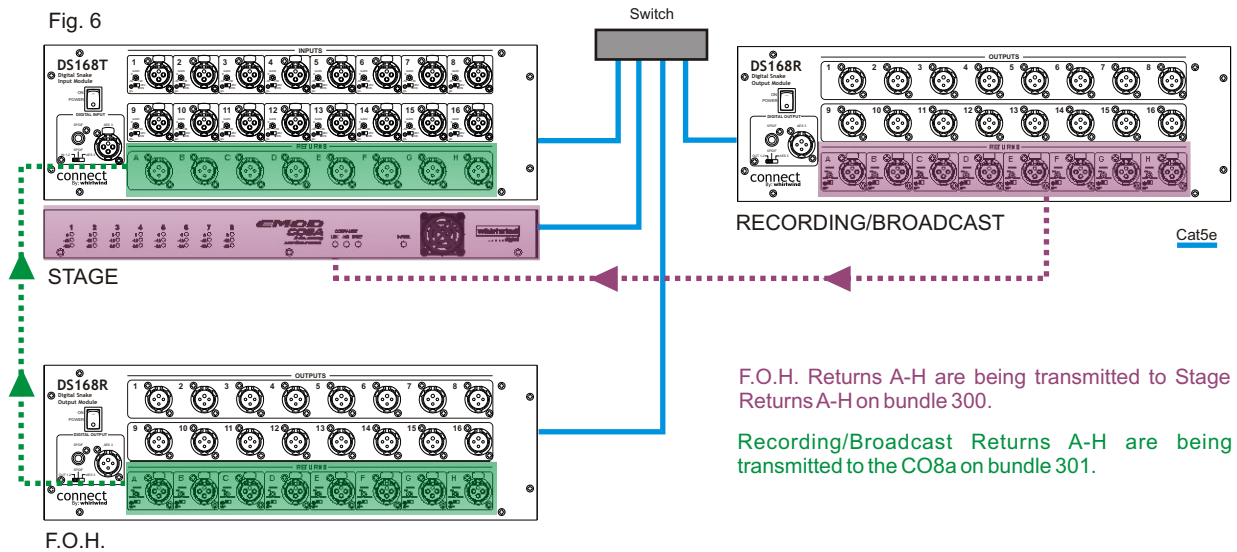

CobraNet I/O device: The DS series snakes can also be used as input/output devices for any CobraNet based audio network. A DS168T or DS328T can be used as an input device for a CobraNet based DSP unit such as a Whirlwind E Desk (Fig. 7), while the DS168R or DS328R offer multiple outputs in a compact and economical package. They can also be used with any Yamaha digital console or Digital Mixing Engine that accepts Yamaha's MY16C-II CobraNet card(s) (Fig. 8). The CobraNet Bundle Assignment Chart on page 15 will give you the information you need to set up the bundles in the devices the DS snakes are connected to. If you need to make changes to the DS snakes follow the procedure described on page 11.

Fig. 7

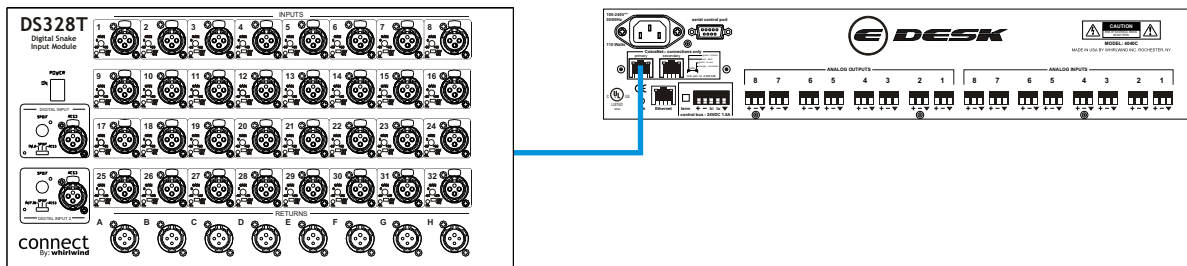
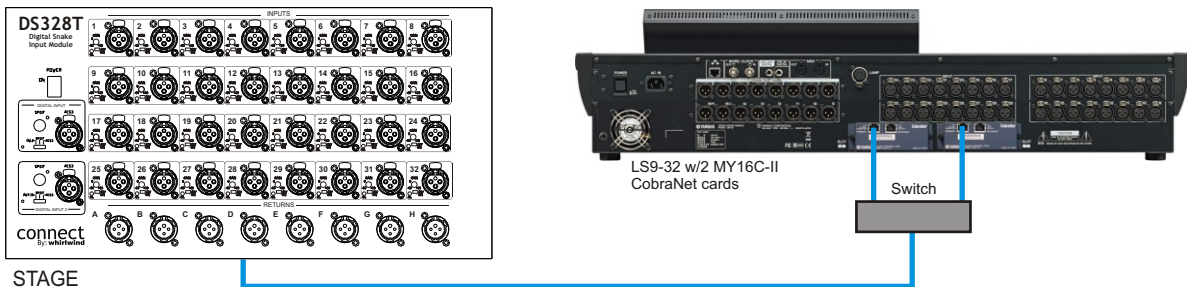

Fig. 8



Cat5e

CobraNet Bundle Assignments

DS168T	TX 1	TX 2	RX 1	RX 2
Inputs 1-8	1			
Inputs 9-16		2		
Returns A-H			300	

DS168R	TX 1	TX 2	RX 1	RX 2
Outputs 1-8			1	
Outputs 9-16				2
Returns A-H	300			

The DS328 has two Mac addresses. Channels 1-16 are in the 1st MAC Address, 17-32 and A-H are in the 2nd.

DS328T	TX 1	TX 2	RX 1	RX 2
Inputs 1-8	10			
Inputs 9-16		11		
Inputs 17-24	12			
Inputs 25-32		13		
Returns A-H			400	

DS328R	TX 1	TX 2	RX 1	RX 2
Outputs 1-8			10	
Outputs 9-16				11
Outputs 17-24			12	
Outouts 25-32				13
Returns A-H	400			

Factory default on all bundles is 24Bit, 1.33ms latency.

1st MAC Address

2nd MAC Address

SPECIFICATIONS

DIGITAL

A/D Section

Conversion	24-Bit/48kHz
Dynamic Range	114dB
THD+N	-100dB

D/A Section

Conversion	24-Bit/48kHz
Dynamic Range	114dB
THD+N	-105dB

Latency	Selectable: 1.33ms (default), 2.66ms, 5.33ms
SPDIF	IEC-60958 AC Coupled
AES/EBU	IEC-60958 Transformer Coupled
Ethernet	100 Base-T, Cat5e, 328 ft. max distance

ANALOG

Frequency Response	20-20kHz +/- 0.5dB @ 48kHz
THD+N	<0.008%
Dynamic Range	110dB
Noise Floor	<-100dBV, 0dB gain
Cross Talk	<-100dBV, 0dB gain @ 1kHz 0dBV input
Input Range	-30dBV to +30dBV

PHYSICAL

	DS168T	DS168R	DS328T	DS328R
Channel Count (analog)	16 In, 8 Out	16 Out, 8 In	32 In, 8 Out	32 Out, 8 In
Power	115/230VAC/50Hz, 60Hz (all models)			
Weight	15.5 lbs. each		22.1 lbs. each	
Dim. (Inches WxHxD)	19 x 5.25 x 11		19 x 8.75 x 11	

WARRANTY

This product is guaranteed to be free from defects in materials and workmanship to the original purchaser for a period of 1 year from the date of purchase. Should service be required, return the unit postage prepaid along with the original sales receipt to:

whirlwind

Attention - Repair
 99 Ling Road
 Rochester, New York 14612

The warranty on this product shall not apply to defects or damage resulting from abuse, abnormal use or from repairs or modifications performed by anyone other than whirlwind. If it is determined a manufacturing defect has occurred, whirlwind will repair or replace the unit at our option and pay the postage back to you.