

# Panasonic®

## Operating Instructions

---

Hard Disk Storage Unit

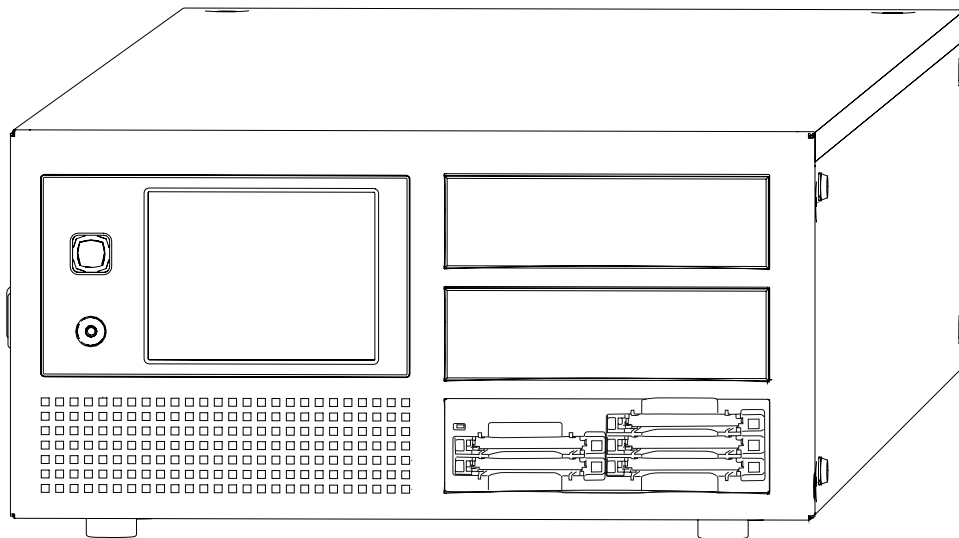

Model No. **AJ-HRW10G**

# *P2HD*



Before operating this product, please read the instructions carefully and save this manual for future use.

# Read this first!

	<b>CAUTION</b> RISK OF ELECTRIC SHOCK DO NOT OPEN	
<b>CAUTION: TO REDUCE THE RISK OF ELECTRIC SHOCK, DO NOT REMOVE COVER (OR BACK). NO USER SERVICEABLE PARTS INSIDE. REFER TO SERVICING TO QUALIFIED SERVICE PERSONNEL.</b>		

 The lightning flash with arrowhead symbol, within an equilateral triangle, is intended to alert the user to the presence of uninsulated "dangerous voltage" within the product's enclosure that may be of sufficient magnitude to constitute a risk of electric shock to persons.

 The exclamation point within an equilateral triangle is intended to alert the user to the presence of important operating and maintenance (service) instructions in the literature accompanying the appliance.

## WARNING:

- TO REDUCE THE RISK OF FIRE OR SHOCK HAZARD, DO NOT EXPOSE THIS EQUIPMENT TO RAIN OR MOISTURE.
- TO REDUCE THE RISK OF FIRE OR SHOCK HAZARD, KEEP THIS EQUIPMENT AWAY FROM ALL LIQUIDS. USE AND STORE ONLY IN LOCATIONS WHICH ARE NOT EXPOSED TO THE RISK OF DRIPPING OR SPLASHING LIQUIDS, AND DO NOT PLACE ANY LIQUID CONTAINERS ON TOP OF THE EQUIPMENT.

## WARNING:

Always keep memory cards or accessories (Ferrite core, Binder, Screws) out of the reach of babies and small children.

## CAUTION:

In order to maintain adequate ventilation, do not install or place this unit in a bookcase, built-in cabinet or any other confined space. To prevent risk of electric shock or fire hazard due to overheating, ensure that curtains and any other materials do not obstruct the ventilation.

## CAUTION:

TO REDUCE THE RISK OF FIRE OR SHOCK HAZARD AND ANNOYING INTERFERENCE, USE THE RECOMMENDED ACCESSORIES ONLY.

## CAUTION:

Excessive sound pressure from earphones and headphones can cause hearing loss.

## Declaration of Conformity

Model Number: AJ-HRW10G  
Trade Name: PANASONIC  
Responsible Party: Panasonic Corporation of North America  
One Panasonic Way, Secaucus, NJ  
07094  
Support contact: Panasonic Broadcast & Television  
Systems Company 1-800-524-1448

This device complies with Part 15 of the FCC Rules. Operation is subject to the following two conditions: (1) This device may not cause harmful interference, and (2) this device must accept any interference received, including interference that may cause undesired operation.

### FCC Note:

This equipment has been tested and found to comply with the limits for a class B digital device, pursuant to Part 15 of the FCC Rules. These limits are designed to provide reasonable protection against harmful interference in a residential installation. This equipment generates, uses, and can radiate radio frequency energy and, if not installed and used in accordance with the instruction manual, may cause harmful interference to radio communications. However, there is no guarantee that interference will not occur in a particular installation. If this equipment does cause harmful interference to radio or television reception, which can be determined by turning the equipment off and on, the user is encouraged to try to correct the interference by one or more of the following measures:

- Reorient or relocate the receiving antenna.
- Increase the separation between the equipment and receiver.
- Connect the equipment into an outlet on a circuit different from that to which the receiver is connected.
- Consult the dealer or an experienced radio/TV technician for help.
- The user may find the booklet "Something About Interference" available from FCC local regional offices helpful.

### Warning:

To assure continued FCC emission limit compliance, follow the attached installation instructions and the user must use only shielded interface cables when connecting to host computer or peripheral devices. Also any unauthorized changes or modifications to this equipment could void the user's authority to operate this device.

 indicates safety information.

## Read this first! (continued)

---

A rechargeable battery that is recyclable powers the product you have purchased.

### <For USA-California Only>

This product contains a CR Coin Cell Lithium Battery which contains Perchlorate Material — special handling may apply. See [www.dtsc.ca.gov/hazardouswaste/perchlorate](http://www.dtsc.ca.gov/hazardouswaste/perchlorate).



## To remove the battery

### Main Power Battery (Ni-Cd / Ni-MH / Li-ion Battery)

- To detach the battery, please proceed in the reverse order of the installation method described in this manual. (Refer to page 8 for the detail.)
- If a battery made by any other manufacturer is to be used, check the Operating Instructions accompanying the battery.

### Back-up Battery (Lithium Battery)

- For the removal of the battery for disposal at the end of its service life, please consult your dealer.

# Contents

---

<b>Read this first!</b> .....	<b>2</b>	<b>Checking the clips in P2 card/HDD</b> .....	<b>25</b>
<b>Standard accessories</b> .....	<b>5</b>	Copying individual clips (COPY) .....	27
<b>Precautions for Use</b> .....	<b>5</b>	Deleting individual clips (DELETE) .....	27
<b>Overview</b> .....	<b>5</b>	Viewing clip properties (PROP) .....	28
<b>Control reference guide</b> .....	<b>6</b>	Select listed devices (device selection buttons) ...	29
Front Panel .....	6	Selecting clips to display (FILTER) .....	30
Back Panel .....	7	Changing how clips are listed (SORT) .....	31
<b>Power Supply</b> .....	<b>8</b>	Viewing slot numbers and HDD status .....	31
Mounting the Battery .....	8	<b>Playing the clips</b> .....	<b>32</b>
Removing the battery .....	8	Setting the FF/REW rate .....	33
<b>How to install the 5-inch bay units</b> .....	<b>9</b>	<b>Sharing the folders</b> .....	<b>34</b>
<b>For better performance</b> .....	<b>11</b>	<b>Returning the clips in the RECYCLE folder</b> ...	<b>35</b>
Shock resistance and vibration resistance .....	11	<b>Formatting</b> .....	<b>36</b>
Handling HDDs .....	11	<b>Checking the state of all slots</b> .....	<b>37</b>
Moving the unit .....	11	<b>System setting</b> .....	<b>38</b>
Recorded data .....	12	Configuring network settings (Network) .....	38
Cleaning .....	12	Specifying the display language (Language) .....	38
Handling the touch panel .....	12	Specifying copy options (Copy Setting) .....	39
Precautions when connecting the LAN cable .....	13	Changing thumbnail display (Thumbnail) .....	39
Use of external DC power supply .....	13	Checking SMART Info .....	40
Battery pack .....	13	Setting battery level warnings (Battery) .....	41
<b>Basic operations</b> .....	<b>14</b>	Setting the date and time (Date and Time) .....	41
Inserting P2 card .....	14	Undoing the setting (Default) .....	42
Ejecting P2 card .....	14	<b>Maintenance</b> .....	<b>43</b>
To Prevent Accidental Erasure of P2 Card Content .....	14	Checking HDD status (Maintenance) .....	43
Turning the unit ON and OFF / Exiting .....	15	Creating PASS registration data .....	44
Functions .....	16	Selecting a workgroup .....	44
Power indication .....	16	<b>Version up</b> .....	<b>45</b>
<b>Setting the RAID function</b> .....	<b>17</b>	<b>Connecting to a computer</b> .....	<b>46</b>
Viewing basic RAID information (Basic Information) .....	18	Network connecting .....	46
Setting up RAID drives (Create RAID) .....	18	Inserting the HDD directly in the 5 inch bay unit ..	46
Deleting RAID drives (Delete RAID) .....	19	<b>Backing up the data</b> .....	<b>46</b>
Rebuilding RAID drives (Rebuild) .....	20	For Windows .....	46
RAID Setting .....	21	For Macintosh .....	46
<b>Copying</b> .....	<b>22</b>	<b>Troubleshooting</b> .....	<b>46</b>
Copying entire cards .....	22	<b>Specifications</b> .....	<b>47</b>
Manual copy mode .....	22		
Auto copy mode .....	23		
Confirmation after copying .....	24		

- 
- Microsoft and Windows are the registered trademarks of Microsoft Corporation of the United States in the United States and other countries.
  - Macintosh is a trademark of Apple Inc. which has been registered in the United States and other countries.
  - Core Inside and Intel Core are trademarks of Intel Corporation in the United States and other countries.
  - Other product names or corporate names in this manual are either trademarks or registered trademarks of their respective owners. In this manual, the trademark symbol ™ and registered symbol ® are omitted.

# Standard accessories

---

- **Ferrite core × 4**

When using a LAN cable (optional), make sure to attach ferrite cores to the ends of the cable. (page 13)

Failure to attach ferrite cores could cause interference with nearby equipment.

- **Binder × 8 (page 13)**

- **Screws x 16**

For installing the 5-inch bay units (page 9)

- **Front cushion x 1**

A cushion to protect the front surface when the unit is carried by the handle.

Always attach the cushion when moving the unit (page 11).

## Precautions for Use

---

### **Points to bear in mind when destroying or transferring the P2 cards or hard disk drives**

Formatting memory cards or hard disk drives (hereafter "HDDs") or deleting data on them using the format or delete function on the unit or on a computer will only change the file management data--it will not completely delete the data on the memory cards or HDDs. It is recommended either that the memory cards or HDDs be physically destroyed or that a data erasure software program for computers available on the market be used to completely delete the data on the memory cards or HDDs. Note that managing the memory card and HDD data is the owner's responsibility.

**This product is licensed under the AVC Patent Portfolio License for the personal and non-commercial use of the following activities of a consumer but no license is granted or implied for any other use.**

- Encode video in compliance with the AVC standard ("AVC video").
- Decode AVC video that was encoded by a consumer engaged in a personal and non-commercial activity.
- Decode AVC video that was obtained from a video provider licensed to provide AVC video.

Additional information may be obtained from MPEG LA, LLC (<http://www.mpegla.com>).

## Overview

---

This unit is a hard disk storage unit specifically designed for P2 cards.

The data recorded on P2 cards can be copied at high speed from the unit's P2 drive onto HDDs.

However, data cannot be written onto the P2 cards.

- **Easy to use**

Designed to enable all operations from the touch panel.

- **Supports two HDDs**

It is now possible to ensure the safety of the data thanks to mirroring.

- **Network ready**

A Gigabit Ethernet LAN (hereafter "Gigabit LAN") port is provided.

This makes it possible to access the data on the unit's HDDs over a network.

---

5-inch bay units and HDDs sold separately.

---

# Control reference guide

## Front Panel

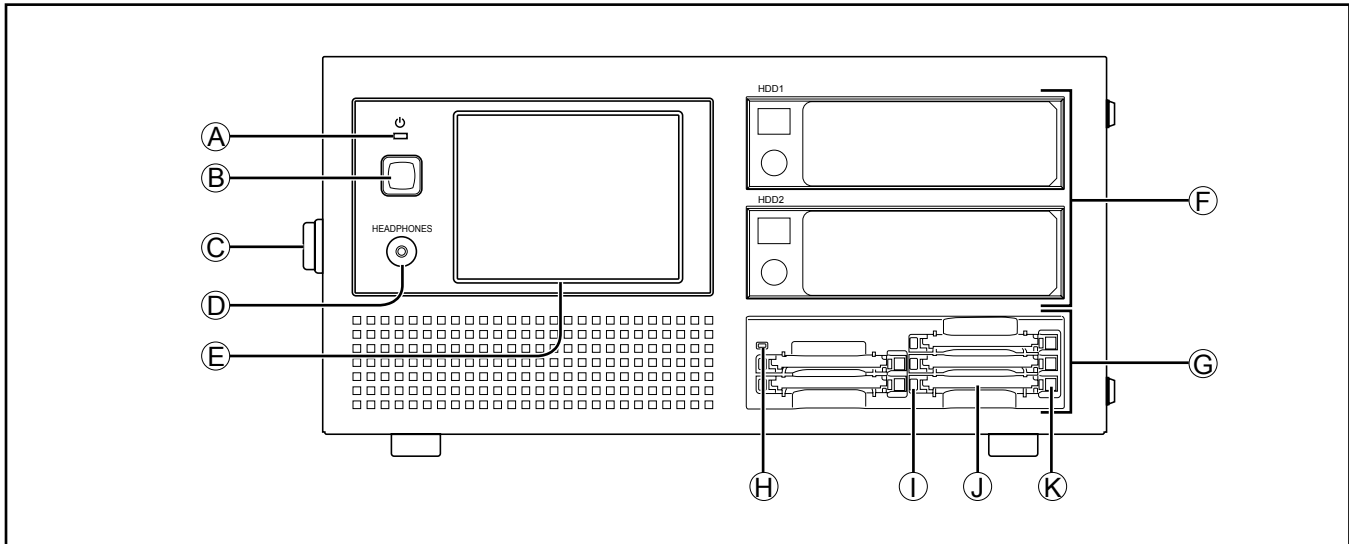

### Ⓐ Front POWER LED

Lights when the unit is ON.

When the LED goes off and the rear POWER switch is ON, electric power is still consumed.

Always turn the rear POWER switch OFF when the battery is not used.

When an external DC power supply is used, standby power will continue to be consumed so set the rear POWER switch to OFF.

### Ⓑ Front POWER button

This button is used to start up the unit and shut it down.

When it is at the OFF setting:

The unit starts up when the front POWER button is pressed.

When it is at the ON setting:

The unit shuts down automatically when the front POWER button is pressed. After the unit has shut down, set the rear POWER switch to OFF.

### Ⓒ Grips

This is the handle for carrying the unit.

### Ⓓ HEADPHONES jack

Use mini-jack HEADPHONE.

### Ⓔ LCD panel with touch panel

All the operations are done on the touch panel except power ON and OFF.

### Ⓕ 5-inch bay units used to install the HDD

You can install the HDD (SATA) which you purchased with the 5 inch bay unit.

For details on the installation method and the HDDs which can be used, refer to the procedure described separately, and proceed with the installation. (page 9)

### Ⓖ P2 Drive

The P2 drive has been installed.

### Ⓗ Power Indicator

This indicator lights up in green when the P2 drive is running.

### Ⓘ Status Indicator

This indicator blinks in green during access to a P2 card.

---

Do not remove the P2 card during access of the card, otherwise files may be corrupted, or the P2 card may fail.

---

### Ⓙ Card Slots

The P2 drive's card slots are designed for P2 cards. The P2 drive does not operate with cards other than P2 cards.

### Ⓚ EJECT Button

To remove a P2 card, press this button so that the button pops out, then press it in again.

**Back Panel**

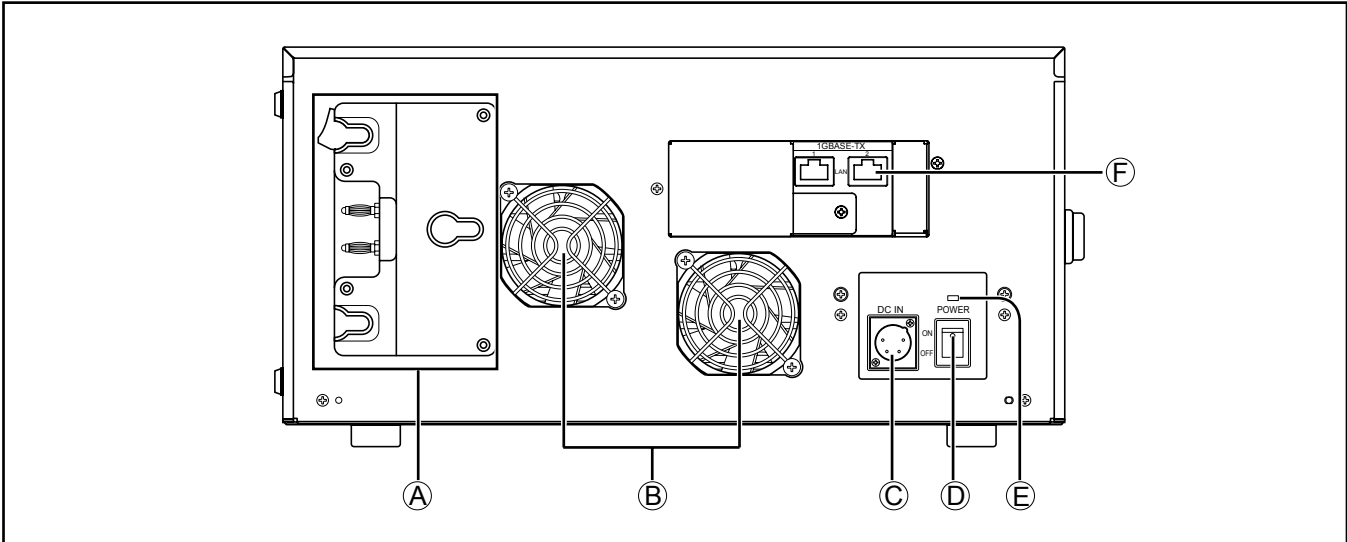

**A Battery holder**

You can install the battery directly if it is compatible with Anton Bauer battery holders.

- Charge the battery with the battery charger before using it. (For details on the charging methods, refer to the operating instructions concerned.)
- When replacing the battery plate or installing the V-mount type adapter plate, consult your dealer.
- When installing the battery plate, take care not to sandwich or pinch the connecting wires.

**B Cooling fan**

**C DC-IN connector**

This DC-IN connector (XLR 4 pin) is used with an external DC power supply.

Use an external DC power supply with a rated value of 100 W or more.

**D Rear POWER switch**

Use this switch to turn the power ON or OFF when an external DC power supply or battery is used.

- When the switch is ON, the power (about 2W) is still consumed in idle state. Always turn the power OFF when the unit is not used.
- If the switch is set to OFF during HDD operations, it may cause HDD failure. Set the switch OFF after normal shutdown.

**E Rear POWER LED**

Lights when the rear POWER switch is ON.

**F LAN connector**

These LAN connectors support speeds of 1000, 100 and 10 Mbps.

Please set the IP address in GUI of this unit. (page 38)

**• Use of external DC power supply**

Make sure that the output voltage of the external DC power supply meets the rated voltage of the unit before connecting the power supply.

Inrush current occurs when the unit is turned on, and insufficient power at this time may damage the unit. Thus, we recommend using an external DC power supply rated at least 100 W. Use the DC cable recommended for the external DC power supply.

- When using an external power supply other than the AC adapter, check the DC IN socket pin information to ensure correct polarity. If a +12 V power supply is accidentally connected to the GND terminal, this could cause a fire or personal injury.

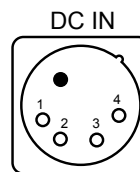

Pin No.	Signal
1	GND
2, 3	-
4	+12 V

- When both the battery and the external DC power supply are connected, power is supplied from the external DC power supply. The battery can be removed or mounted while using an external DC power supply.
- When using an external DC power supply, make sure you turn on the external DC power supply before turning on the unit's power switch.

# Power Supply

A battery or external DC power supply can be used as the power supply for the unit.

## Mounting the Battery

### 1 Mount an Anton/Bauer battery.

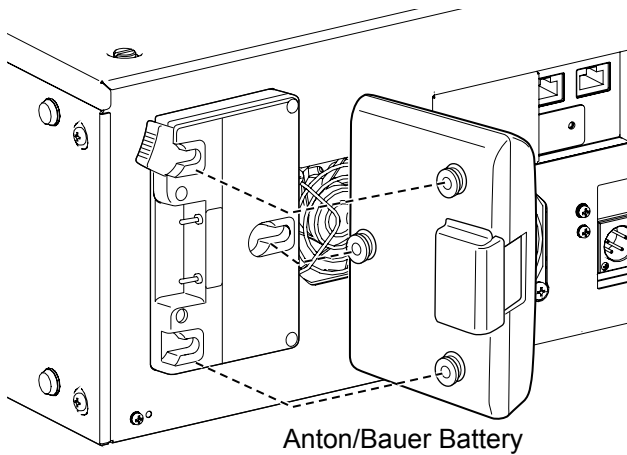

### 2 Insert the battery and slide it in the direction of the arrow.

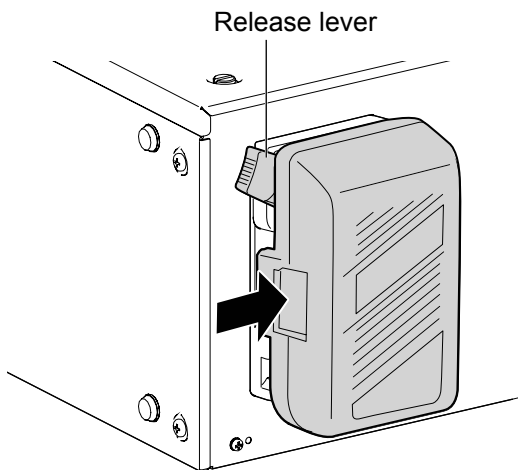

### 3 Set the battery type.

Specify the type of battery on the [Battery] tab of the "SETTING" screen. (page 41)

## Removing the battery

Completely push down and hold the release lever on the battery holder. Then, slide the battery in the opposite direction to the arrow while holding the lever down.

The following is a list of batteries that have been tested and verified to work with this unit.

- PROPAC14
- TRIMPAC14
- HYTRON50
- HYTRON140
- DIONIC90
- DIONIC160



# How to install the 5-inch bay units

Follow the steps below to install the 5-inch bay units.

5-inch bay units and HDDs sold separately.

- 1** Remove the screws (x2) of the top panel, and remove the top panel.

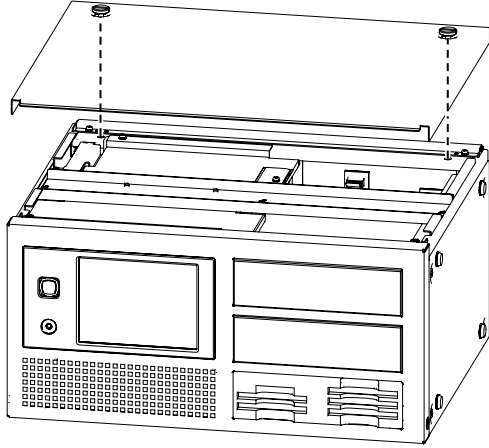

- 2** Remove the screws (x2) at the left and right and also the screws (x2) at the top of the front panel, and remove the panel. (Total: 4 screws)

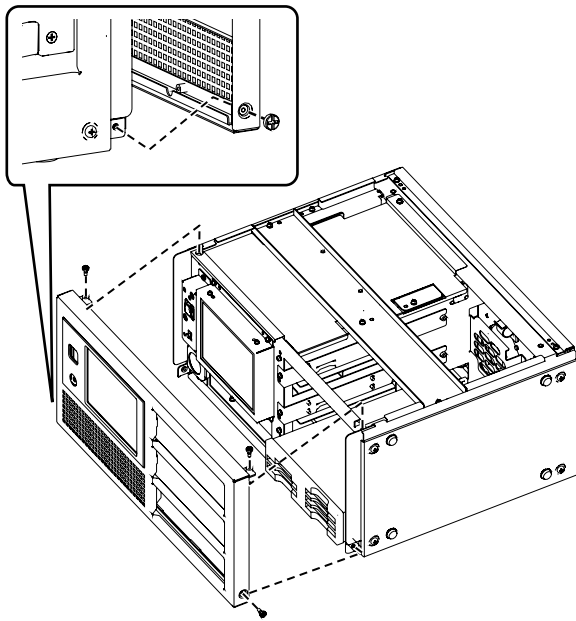

Exercise caution when removing the front panel since the screw at the top left in the figure above will catch on the transparent panel.

- 3** Remove the screws (x2 each) securing the 5-inch bay unit cover to the front panel, and then remove the cover.

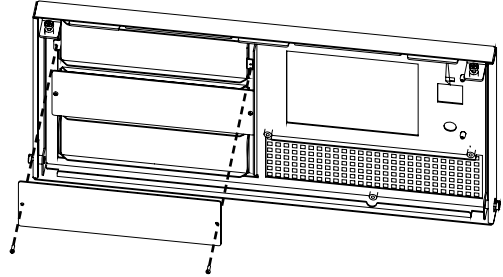

- 4** Loosen the left and right anchoring screws of the 5-inch bay unit brackets, and then remove the brackets from the main unit. (x1 screw each at left and right for each 5-inch bay unit)

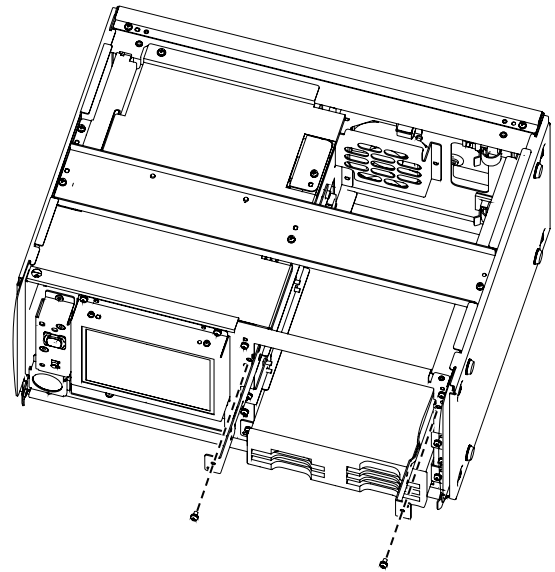

(Continued on next page)

## How to install the 5-inch bay units (continued)

---

- 5** Install the removed brackets on the 5-inch bay unit.  
(Use the screws provided.)

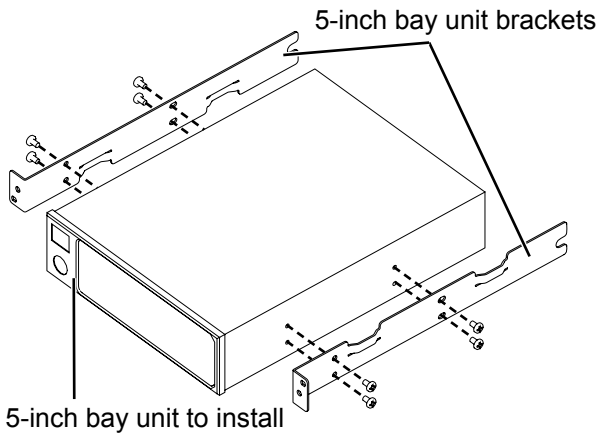

- 8** Put the front panel back in its original position (using the 4 screws).

- 9** Close the top panel, and tighten the top panel screws (x2).

---

We recommend you to use the following HDD:

Connect IF:	SATA-2
Appearance:	3.5-inch internal type
Rotating number:	above 7200

---

- 6** Insert each 5-inch bay unit on a shelf, and then connect the wire harnesses to the power connector and SATA signal connector on the back of the bay unit.

---

For connection details, refer to the operating instructions for the 5-inch bay units.

---

- 7** Anchor the 5-inch bay unit brackets to the main unit using the left and right anchoring screws.

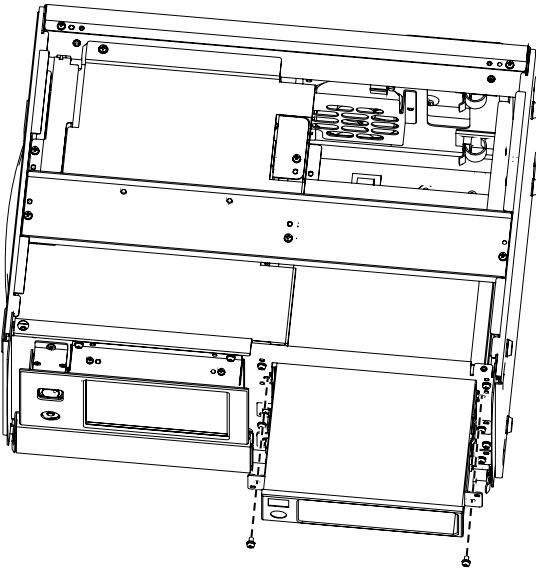

# For better performance

This unit is constructed to allow the HDDs to be installed on 5-inch bay units, but its design does not improve the HDD drop resistance or impact resistance performance. Remember to take extra care when handling the bay units.

- The 5-inch bay units are not packed with the storage unit. Give due consideration to the applications for which they will be used, obtain bay units with a sufficient shock and vibration resistance, and install them.

## Shock resistance and vibration resistance

There are cushions on the legs to absorb the vibration. However, please understand that no guarantee against damage or failure.

## Handling HDDs

The unit is designed for use with typical HDDs installed. To minimize any risks associated with HDD damage, loss of data on HDDs, or interrupted operation, refer to the HDD user manual for information on installation and use.

- When moving the unit, after setting the rear POWER switch to OFF be sure to wait until the HDDs stop rotating (about 2 minutes) before moving the unit to avoid subjecting the unit to shock or vibration. (After the unit is turned OFF, HDDs continue spinning from inertia for a while.)

---

Before moving the storage unit, be absolutely sure to press the EJECT buttons and set it to in position.

---

## Moving the unit

When moving the unit, protect the front panel with the front cushion.

## Structure of front cushion

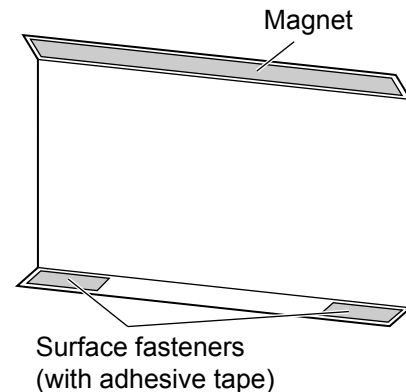

## Installation method

- 1 Attach the magnetic surface of the front cushion to the upper area of the unit's front panel, and decide on where the surface fasteners will be mounted.**

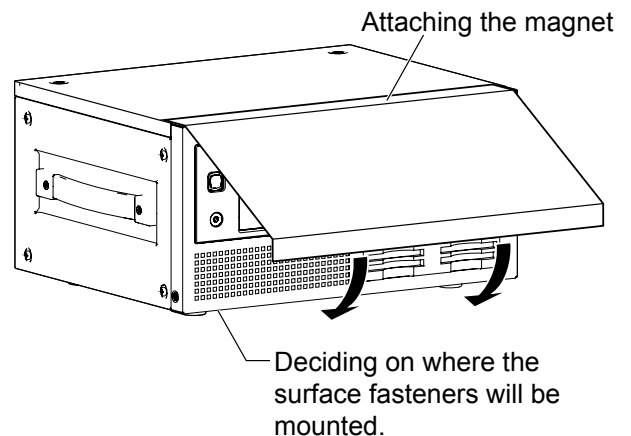

- 2 Peel off the separator of the adhesive tape, and adhere the cushion to the lower area of the front panel.**

(Continued on next page)

### Operation

- 1 As shown below, attach the surface fasteners of the front cushion to the bottom of the front panel.

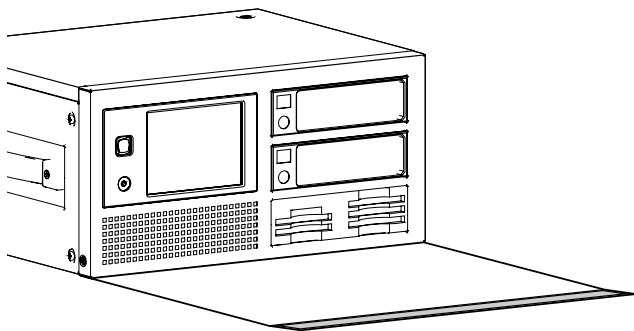

- 2 Lift the front cushion and attach it to the top of the front panel using the magnet.

Place the front cushion magnet here to secure the cushion.

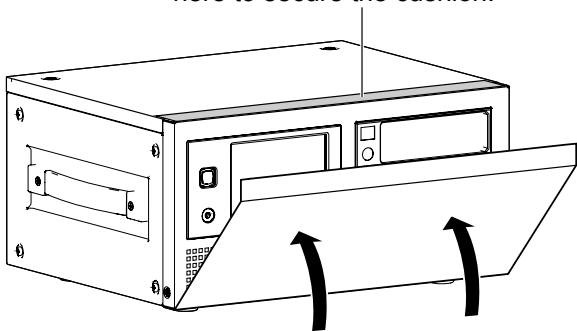

Before moving the unit, remove the HDDs.  
(HDDs may be damaged if the unit is moved with these drives left in place inside the unit.)

### Recorded data

If P2 cards or HDDs are damaged, data on them will be lost. Always keep an extra copy of important data on separate media.

This unit supports mirror (RAID1) operation. Please consider the worst situation of the operations.

Panasonic is not liable for data lost from P2 card or HDD failure or other problems, or for other direct or indirect loss.

### Cleaning

Never clean the unit with solvents such as benzene, thinner, or alcohol.

- Before cleaning, remove the battery or unplug the unit from the external DC power supply.
- Cleaning the unit with solvents may damage the external case or cause the paint to peel.
- Use a clean, soft dry cloth to wipe away dust or dirt. If the unit becomes quite dirty, wipe it with a cloth dampened in diluted neutral detergent after wringing the cloth well. Use a dry cloth to wipe it dry.
- If you use a chemically treated dust cloth, follow the precautions for use.

### Handling the touch panel

Do not press pointed objects, hard metallic objects, or objects such as pencils or ballpoint pens against the touch panel. This may damage the screen.

- If there is any oil or other substance adhering to the surface of the touch panel, it will not be possible to conduct operations properly.
- To clean the touch panel, wipe it with a soft cloth. Do not use benzene, thinner, or similar substances.

## For better performance (continued)

---

### Precautions when connecting the LAN cable

- When connecting the unit to a computer using a LAN cable, attach the two ferrite cores (included) on the LAN cable, one 5–10 cm from the computer LAN port and the other 5–10 cm from the LAN port on the unit.

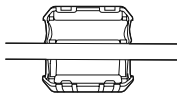

Failure to attach ferrite cores could cause interference with nearby equipment.

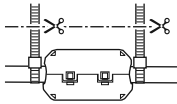

- After attaching the ferrite cores as shown at right, close them until they click and lock into place.
- If a ferrite core moves along the cable and cannot be fixed in place, attach binders on both sides of the ferrite core to immobilize it. Cut the binders with scissors to adjust the length.
- Handle ferrite cores with care. Dropping or subjecting the cores to impact may break them in two.
- Always use a shielded LAN cable.

### Use of external DC power supply

Use an external DC power supply rated at 100 W or more.

Read the DC power supply user manual carefully before use.

Always use a shielded DC cable.

### Battery pack

Use a battery rated at 100 W or more. Read the battery user manual carefully before use.

# Basic operations

## Inserting P2 card

When inserting a P2 card into the P2 card slot of the P2 drive provided in the unit, be absolutely sure to position the P2 card parallel to the slot and insert it straight into the drive.

- Forcing cards in the slot at an angle may damage P2 card, P2 Drive or this unit.
- To prevent cards from falling out, protect the unit from dust, and reduce the risk of exposure to static electricity, remove P2 cards before moving the unit.
- Format P2 cards only on a P2 card device.

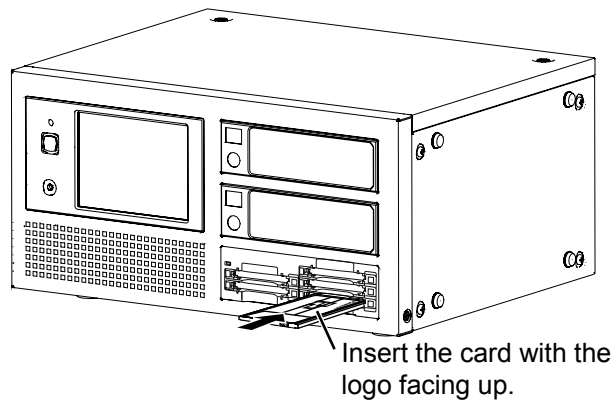

**1** Turn the unit on.

**2** Insert a P2 card in a P2 card slot.

When a P2 card is inserted, an icon is displayed on the control panel.

Also at this time, the P2 CARD ACCESS LED for the corresponding slot indicates the status of the P2 card.

P2 CARD ACCESS LED	Status of P2 Card	
	Blinks in green	Being accessed
Quickly blinks in green	Being recognized	The P2 card is being recognized.
Stays off	Card not supported	The card is not supported by the unit. Use another card.
	Incorrect format	The P2 card is not properly formatted. Reformat the card.
	Card not inserted	No P2 card is inserted. Card recognition standby.

## Ejecting P2 card

**1** Press the EJECT button next to the P2 card slot.

**2** After the EJECT button emerges, press it again to eject the P2 card.

- During access or detection of P2 cards after insertion (when the P2 CARD ACCESS LED blinks in green), do not remove the cards. Removing cards during access may damage them.
- If a P2 card being formatted is removed, it may not be formatted properly.
- Do not move the unit while the EJECT button is set to its out position. Doing so may cause damage. Be sure to press the EJECT button and set it to its in position first.

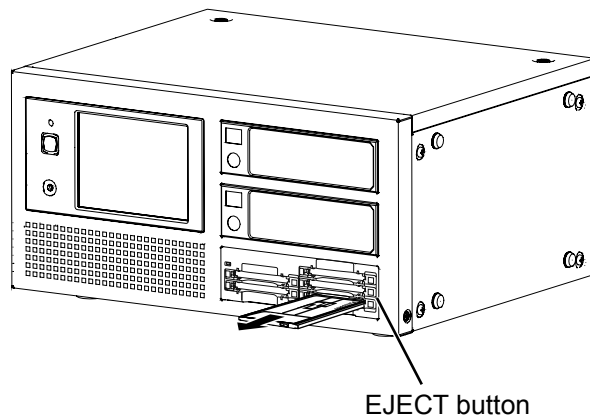

## To Prevent Accidental Erasure of P2 Card Content

To prevent the content of a P2 card being accidentally erased, position the write-protect switch on the P2 card at [Protect].

Write-protect switchover can be performed while the card is being accessed (during recording or playback), but does not take effect until access to the card ceases.

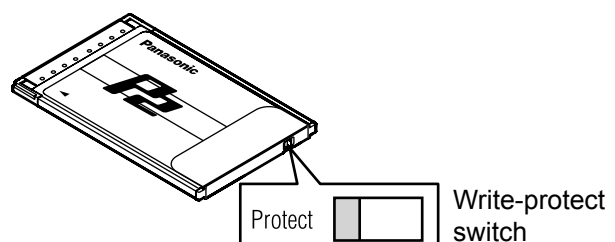

## Basic operations (continued)

### Turning the unit ON and OFF / Exiting

Confirm that the battery or external DC power supply is firmly connected to the unit. Please refer to the operation instructions of this unit for the details of access.

#### Power ON

After setting the rear POWER switch to ON, press the front POWER button to turn the unit on. While the unit is starting up, the startup screen appears on the LCD panel display. About one minute later, the main screen appears. The unit can now be used.

- The unit will automatically shut down if a low-voltage error occurs. Switch to another, fully charged battery or use an external DC power supply.
- When the temperature is below the rating temperature of HDD, the HDD may be damaged. Please move the unit to a warmer place and do not use it until the temperature is melt. When the temperature is above the rating temperature of HDD, the HDD may be damaged. Please move the unit to a cooler place and do not use it until the temperature is melt. (You can check the HDD temperature on the screen after startup.) For the rating temperature, refer to the specifications of each HDD used.

#### Power OFF

To turn off the power, either press the front POWER button or the EXIT button on the main screen displayed after startup, and then press the OFF button or RESTART button on the shutdown method selection screen displayed next.

The power is now turned off automatically.

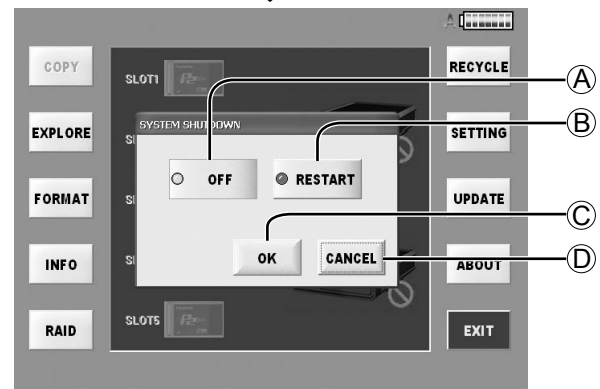
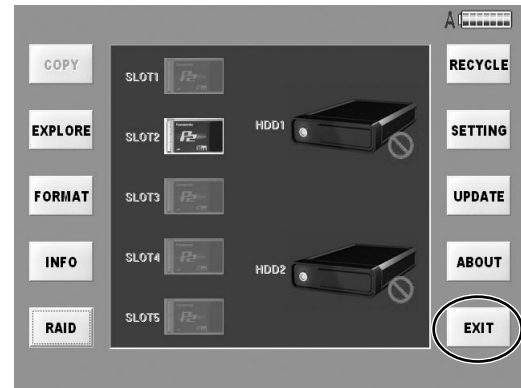

#### Ⓐ OFF button

After shutdown is completed, the power is turned off automatically.

#### Ⓑ RESTART button

After shutdown is completed, the unit is restarted automatically.

#### Ⓒ OK button

The shutdown method, which was selected on the shutdown method selection screen, is executed.

#### Ⓓ CANCEL button

The main screen that was displayed previously is now restored.

Although the front POWER LED goes off, power is still consumed if the rear POWER switch is not set to OFF. Also set the rear POWER switch to OFF when the unit is not used.

## Basic operations (continued)

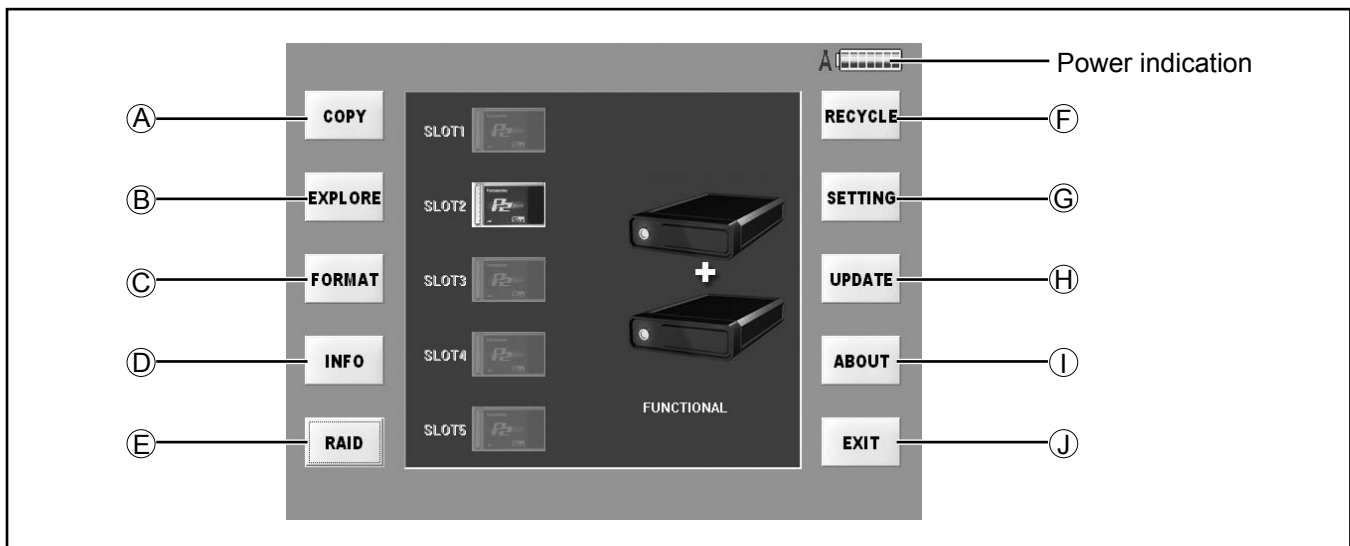

### Functions

Described below are the functions of the buttons which are provided on the left and right sides of the main screen.

- A COPY button (page 22)**  
Copy the clips from P2 cards to HDD.
- B EXPLORE button (page 25)**  
Explore the clips in P2 cards or in HDD.
- C FORMAT button (page 36)**  
Format P2 cards or HDD.
- D INFO button (page 37)**  
Check the current volume of P2 cards or HDD.
- E RAID button (page 17)**  
Set RAID of HDD.
- F RECYCLE button (page 35)**  
The clips in the RECYCLE folder and folders can now be displayed, deleted or restored.
- G SETTING button (page 38)**  
Do various settings.
- H UPDATE button (page 45)**  
Update the application.
- I ABOUT button (page 45)**  
Check the current version of application.
- J EXIT button (page 15)**  
Turn OFF or RESTART.

### Power indication

The icon at the top right of the screen indicates the power supply status as shown by the displays below.

Icon	Information
<b>A</b>	External DC power supply
<b>B</b>	Battery power supply (full or nearly full charge)
<b>B</b>	Battery power supply (charge level after some use)
<b>B</b>	Battery power supply (nearly depleted; Near End: insufficient voltage) Switch to another power supply immediately. Use either a fully charged battery or an external DC power supply.
<b>B</b>	Battery power supply (depleted; End: insufficient voltage)



# Setting the RAID function

The RAID function must be set when a new HDD has been installed.

**RAID1 mode:** The same data is written simultaneously onto two HDDs.

The data safety is ensured by data redundancy (mirroring).

When HDDs with different memory sizes are combined, the smaller memory size will be used.

**JBOD mode:** The data is written onto only the specified HDD.

Use this mode when storing large amounts of data.

This screen displays in several TAB screen as the following.

For details, refer to the explanations for each individual tag.

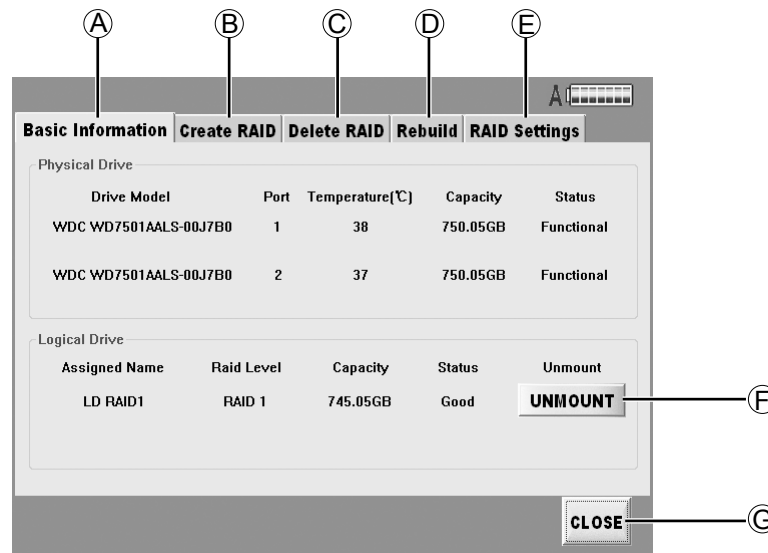

## Ⓐ Basic Information (page 18)

Display the physical and logical device status.  
If arbitrary one is abnormal, the "Critical" will indicate in the Status.

## Ⓑ Create RAID (page 18)

A JBOD or RAID1 logical device can be prepared.

Proceed with this when:

- Inserting a new HDD and creating a new logical drive.
- Changing the JBOD setting to the RAID1 setting or vice versa.
- Installing a new HDD with the JBOD setting established and using the HDD with the JBOD setting.

## Ⓒ Delete RAID (page 19)

This deletes the JBOD or RAID1 logical drive.

Proceed with this when:

- Using an HDD, this was previously used with the JBOD setting, now with the RAID1 setting.
- Using an HDD, this was previously used with the RAID1 setting, now with the JBOD setting.

## Ⓓ Rebuild (page 20)

This starts and finishes the data rebuilding process.

Proceed with this when either of the following events has occurred with the RAID1 setting:

- When trouble occurred in one HDD, and the HDD was replaced.
- When data could not be written on one HDD during copying because of reason or other.

## Ⓔ RAID Settings (page 21)

This makes it possible to perform the settings related to the RAID board.

## Ⓕ UNMOUNT button

With the power ON, press this button before removing the HDD.

The indicated HDD is now logically isolated. After this setting, remove the HDD.

If the HDD is not installed, this button will not be displayed.

## Ⓖ CLOSE button

This closes the screen and restores the main screen.

No guarantees are given for what might happen when an HDD is installed while the power is on.

Be absolutely sure that the power is turned off before installing the HDD, and then start it.

## Setting the RAID function (continued)

### Viewing basic RAID information (Basic Information)

The statuses concerning the HDDs used and RAID are displayed.

Physical Drive				
Drive Model	Port	Temperature(C)	Capacity	Status
WDC WD7501AALS-00J7B0	1	38	750.05GB	Functional
WDC WD7501AALS-00J7B0	2	37	750.05GB	Functional

Logical Drive				
Assigned Name	Raid Level	Capacity	Status	Unmount
LD RAID1	RAID 1	745.05GB	Good	UNMOUNT

#### Ⓐ Physical Drive

The following information about the HDD installed is displayed.

- **Drive Model**

Display the HDD product numbers.

- **Port**

Display the numbers of the ports where the RAID boards are connected

- **Temperature**

Display the temperatures of the HDDs

- **Capacity**

Display the memory sizes of the HDDs

- **Status**

Display the statuses of the individual HDDs

#### Ⓑ Logical Drive

- **Assigned Name**

Display the setting names

- **Raid Level**

Display either JBOD or RAID1

- **Capacity**

Display the memory size of the HDDs

- **Status**

Display the statuses

- **UNMOUNT button (page 17)**

Press this when logically isolating the HDD before it is unmounted.

If the HDD is not installed, this button will not be displayed.

#### Ⓒ CLOSE button

Return to the main screen.

### Setting up RAID drives (Create RAID)

When RAID is re-set, the data on the HDD will be deleted so take care before proceeding.

This is used when specifying either JBOD mode with separate logical drive names for each HDD or RAID1 mode with mirrored HDDs.

This job is required when installing a new HDD.

(In the RAID1 mode)

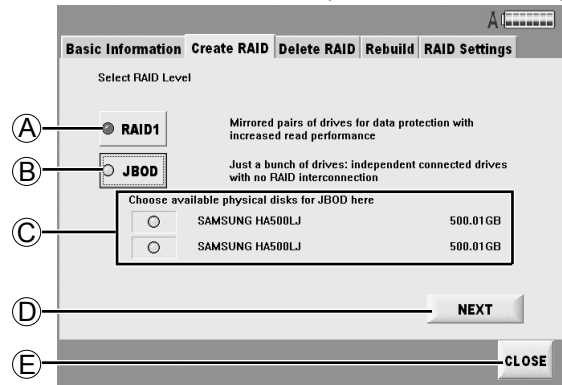

(In the JBOD mode)

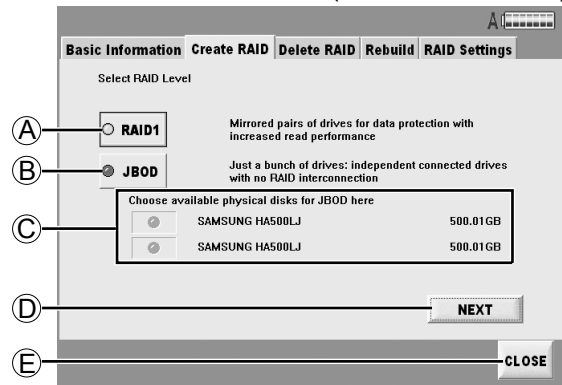

#### Ⓐ RAID1 button

This is used when writing the same data simultaneously onto two HDDs.

#### Ⓑ JBOD button

Using each HDD as an individual device.

#### Ⓒ HDD-related information

The HDD manufacturer name, product number, and disk size will be displayed on the right-hand side of the button.

In JBOD mode, the HDD may be selected with the button on the left.

#### Ⓓ NEXT button

This continues settings.

#### Ⓔ CLOSE button

Return to the main screen.

## Setting the RAID function (continued)

Press NEXT button after setting, the confirming screen will display. Please press OK button.

(In the RAID1 mode)

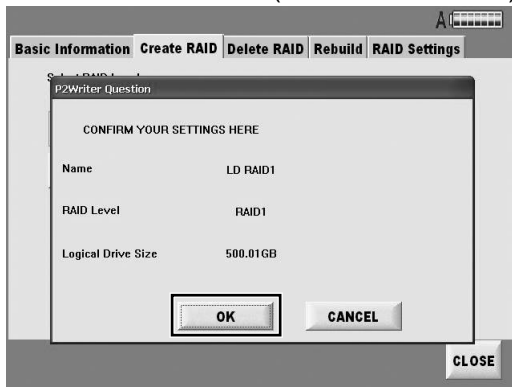

(In the JBOD mode)



When HDDs of different capacities have been set as RAID1, the smaller size of the two installed HDDs is displayed in Logical Drive Size.

Please press OK button in the further confirming screen.

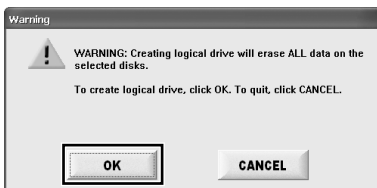

When the OK button on the reconfirmation screen is pressed, all the data on the HDD is deleted. Make sure that you do not need the data before pressing this button.

Press the OK button when a message is displayed after RAID initialization. The unit can now be used as a RAID drive.

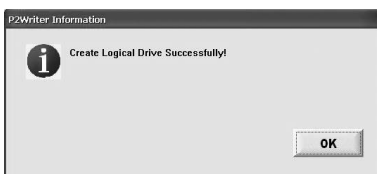

## Deleting RAID drives (Delete RAID)

When switching between RAID1 and JBOD or otherwise changing the RAID level, delete the logical drive which is currently set.

When the RAID level is re-set, the data on the HDD will be deleted so take care before proceeding.

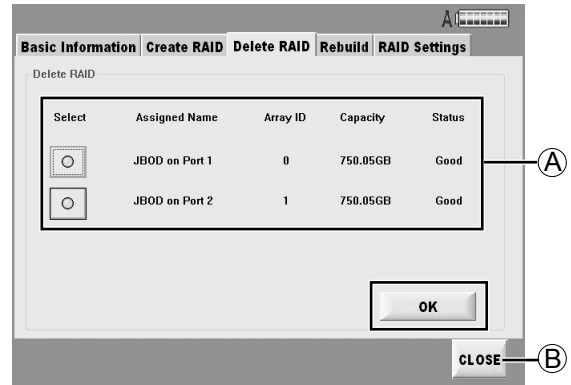

### A HDD-related information

- **Select**  
The button will flash green when selected.
- **Assigned Name**  
Display the RAID board connection location and RAID level.
- **Array ID**  
Displays RAID control number.
- **Capacity**  
Displays RAID disk capacity.
- **Status**  
Displays operating conditions.

### B CLOSE button

Return to the main screen.

The HDD is indicated as a theoretical device. Select the device you want to delete and press OK button, a confirming message will display.

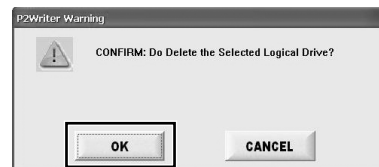

Press OK button and the selected theoretical device will be deleted from the theoretical device list. After the finished message is displayed, Press the OK button.

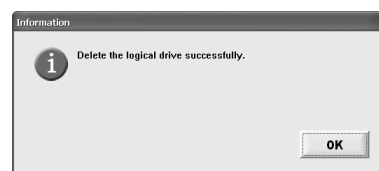

## Setting the RAID function (continued)

### Rebuilding RAID drives (Rebuild)

When data rebuilding is necessary or during the rebuilding process, either “Need Rebuild” or “Rebuilding” is displayed under the HDD icon on the main screen.

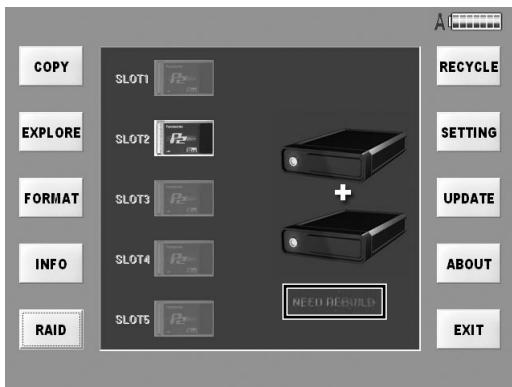

Press the RAID button in this status, and select the [REBUILD] tab. The screen shown below now appears.

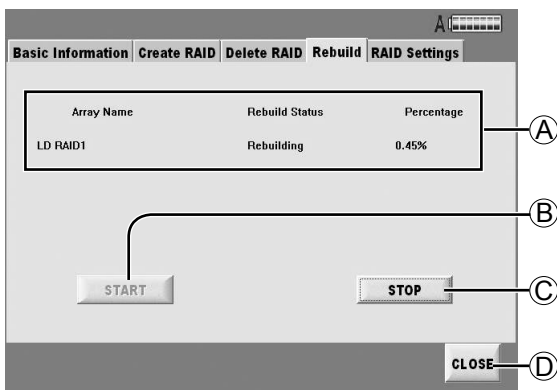

(When rebuilding is in progress)

#### Ⓐ HDD-related information

##### ● Array Name

Display name of logical drive.

##### ● Rebuild Status

Display Rebuild Status.

If “Need Rebuild” is displayed, rebuild is required.

If “Rebuilding” is displayed, rebuild is in progress.

##### ● Percentage

Display rebuild completion ratio (%). (Rebuild is complete when this ratio reaches 100 %.)

#### Ⓑ START button

Start the rebuilding process.

When “Need Rebuild” was displayed, this button is shown with black text.

#### Ⓒ STOP button

Stop the rebuilding.

#### Ⓓ CLOSE button

Return to the main screen.

When the STOP button has been pressed, a confirmation message such as the one shown below is displayed.

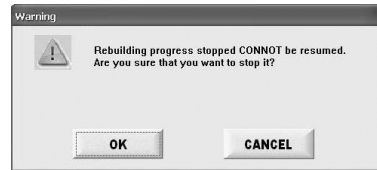

To stop the rebuilding, press the OK button; to cancel the stopping, press the CANCEL button.

- If an HDD has been replaced due to trouble while setting RAID1, rebuilding from a trouble-free HDD must be undertaken for mirroring purposes.
- When the automatic rebuilding can not work normally as usual, please follow the indication to rebuild in this screen. Automatic rebuilding is not initiated if [Disable] is set for the Automatic Rebuilding Status on the RAID settings screen.
- The status and progress are indicated during the rebuilding process. Note that it takes about 2 hours to rebuild a 500 GB HDD. Do not unplug the external DC power supply during this time.

## RAID Settings

The basic processing of the RAID1 function is set.

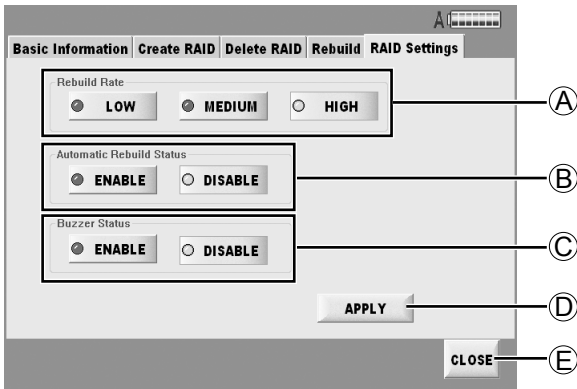

### A Rebuild Rate

Set the rebuilding rate.

While the rebuilding process is underway, both playback and access from an external source via the LAN can be performed at the same time. When rebuilding and playback or rebuilding and external access have been performed at the same time, the rate of not only the rebuilding but the playback or external access as well will be reduced.

For details on the rates provided by the LOW button, MEDIUM button and HIGH button, refer to the table below.

	LOW button	MEDIUM button	HIGH button
Rebuilding time	Slow	Normal*	Fast
Playback frame skip amount	Low number of frames	Middling number of frames	High number of frames

\* The rebuilding time is about 2 hours for 500 GB. The rebuilding times given are estimates only and will vary depending on the HDD used and operating environment.

### B Automatic Rebuilding Status

- **Enable button**  
Rebuild automatically.
- **Disable button**  
Rebuild manually.  
To initiate rebuilding, press the START button of the Rebuild tab.

### C Buzzer Status

These control the ON/OFF statuses of the BUZZER on the RAID board. This BUZZER sounds when trouble has occurred on the RAID button.

- **Enable button**  
Buzz when HDD is plugged.
- **Disable button**  
Be quiet all the time.

### D APPLY button

Register currently set details.

### E CLOSE button

Return to the main screen.

# Copying

The data on the recorded P2 cards is copied onto the HDD.

The data is copied from the P2 card onto the HDD on a card by card basis or clip by clip basis (see page 27).

Use the copying method that best suits the application concerned.

## Copying entire cards

Two copy modes are available when copying entire cards, as follows.

- Manual copy mode: Data is copied after inserted P2 cards are selected.
- Auto copy mode: Data is automatically copied from inserted P2 cards.

To switch between auto and manual copy modes and complete the settings, access the [Copy Settings] tab on the "SETTING" screen (page 39).

## Manual copy mode

Insert the P2 card to copy and press the COPY button on the main screen. Next, complete the copy settings as follows.

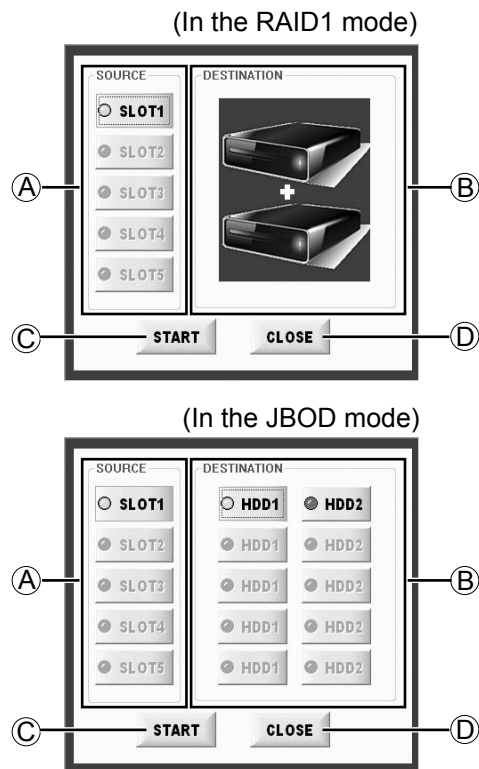

- Ⓐ **SOURCE**  
Select the P2 card to copy.  
(Multiple cards in slots 1–5 can be selected.)

- Ⓑ **DESTINATION**  
Select the destination for copying.

---

In RAID1 mode, there is only one destination available, and there is no need to select it.

---

- Ⓒ **START button**  
Start manual copying.

- Ⓓ **CLOSE button**  
Return to the main screen.

### Manual copy mode (continued)

Take the steps below for manual copying.

**1** In **SOURCE**, select the **P2 card to copy**.  
(More than one card can be selected using **SLOT1** to **SLOT5**.)

**2** In **DESTINATION**, select the destination for copying.  
(**HDD1**, **HDD2** for the **JBOD** mode; no destination selected for the **RAID1** mode)

**3** Press the **START** button.

Copying will begin.

A confirmation screen will be displayed for any cards that have already been copied.

Press the **YES** button to proceed to a screen displaying the current copying progress (page 24).

Press the **NO** button to return to the main screen.

If you press **CLOSE** button in this screen, you will go back to the main screen.

---

In **RAID1** mode, there is only one destination available, and there is no need to select it in step 2.

---

### Auto copy mode

In auto copy mode, a popup screen is displayed when a P2 card is inserted.

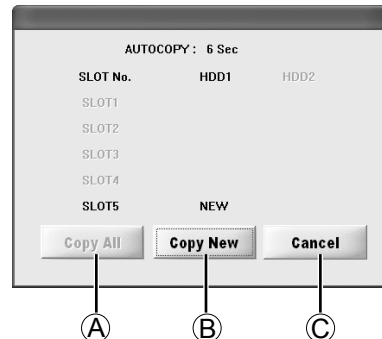

**A** **Copy All button**

Copy the currently inserted card.

**B** **Copy New button**

Copy new cards only.

**C** **Cancel button**

Return to the main screen without automatic copying.

In this mode, the unit detects when a card is inserted. If no other card is inserted within 10 seconds, data is automatically copied from the inserted card to the designated HDD.

After copying, it will copy automatically when inserting a new P2 card.

- 
- Multiple P2 cards may not be recognized if inserted at the same time. In this case, automatic copying is not performed.  
Try reinserting the P2 cards.
  - Auto copy will not be executed even when the unit is started or restarted while a P2 is inserted.
  - The data is not copied automatically if the amount of recordable memory on the HDD is less than that on the P2 card.
  - If a copied card has been inserted into the HDD while **ON** is set for the copied card check function (Card Check), auto copy will not be executed.  
To re-copy an already copied card, press the **Copy All** button.
-

## Copying (continued)

Once copying starts in manual or auto copy mode, the sequence of processing is as follows.

The copying state and the progress of each card displays on the screen.

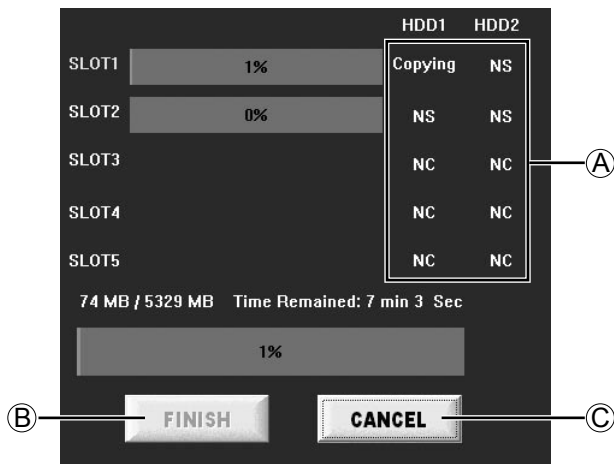

### A Status displays

The meaning of the status indicated is described below.

- **Copying**

The contents are being copied to this destination.

- **Waiting**

Copy standby state.

- **Verifying**

State in which copying is completed and the data on the HDD is being compared with the data on the P2 card.

- **NS**

The destination is not selected now.

- **NC**

No card inserted.

### B FINISH button

Enter the completion of the copying process.

### C CANCEL button

Cancel copying in progress.

- 
- If copying is cancelled before completion, all copied data will be erased.
  - Copying cannot be canceled while verifying is underway.
- 

## Confirmation after copying

The results of copying can be checked on the copy confirmation screen displayed after copying is finished.

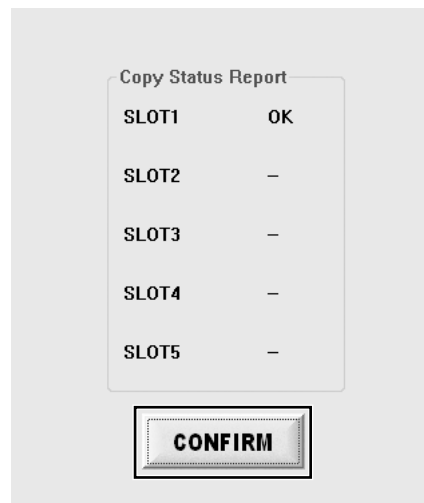

By pressing the CONFIRM button, the copying is finished, and when the FINISH button on the copy state display screen is pressed, a screen on which to confirm the previewing of the copied data is displayed.

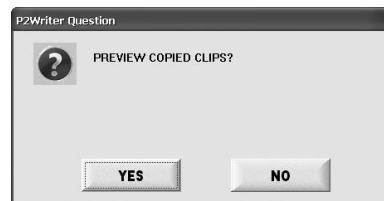

If the YES button is pressed on the confirmation screen, the EXPLORE screen which displays the folders and icons on the HDD will appear. If the NO button is pressed instead, the main screen is restored.



# Checking the clips in P2 card/HDD

Open EXPLORE screen, you will find that data in different device displays in different ways.

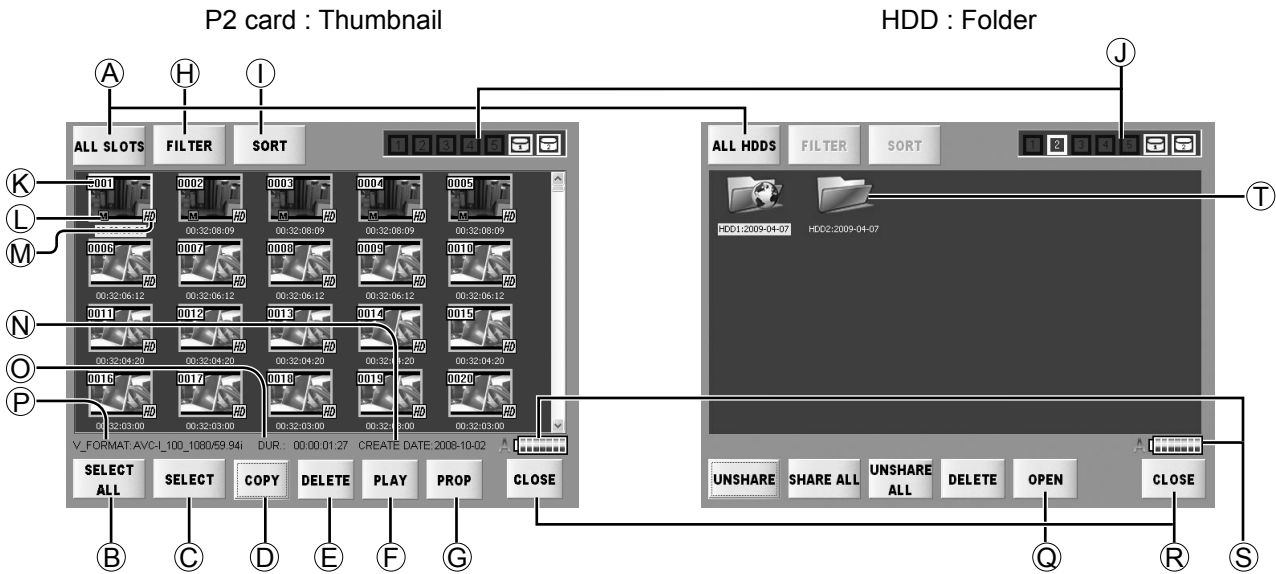

To display the clips on the HDD, double-click the folder for the day when the data was copied. All thumbnails in the folder are shown.

- (A) Device selection button (page 29)**  
Select the device displays in the thumbnail screen. The selected device will be displayed on the button.

**(B) SELECT ALL button / UNSELECT ALL button**  
Press SELECT ALL button to select all the clips in the same time. The display changes to [UNSELECT ALL]. When the UNSELECT ALL button is pressed, the selected status is cleared and the button label changes to [SELECT ALL].

**(C) SELECT button / UNSELECT button**  
Move the cursor to select the clip you want, and press SELECT button to make it selected. When you move the cursor to the clip which is selected, the button label changes to [UNSELECT]. Press it and make the clip in unselected state. When the button is double-clicked, its display is switched between SELECT and UNSELECT.

**(D) COPY button (page 27)**  
Select the file (blue framed) and press this button, the copying destination will be displayed.

---

This function button is not displayed when HDD is selected.

---

**(E) DELETE button (page 27)**  
Press this button will delete the selected clips (blue framed).
- (F) PLAY button (page 32)**  
Start the application to play the selected clip (blue framed).

**(G) PROP button (page 28)**  
Press this button, the property of the clip (yellow framed) in cursor will be displayed.

**(H) FILTER button (page 30)**  
You can select the combination displayed in thumbnail screen.

**(I) SORT button (page 31)**  
Change the displaying order of the selected clips.

**(J) Slot number/HDD state (page 31)**  
Indicates the device containing the clip by the cursor (yellow framed).

**(K) Clip number**  
Clip numbers will be ordered from top-left to bottom-right, starting with 0001. Clips will be similarly re-numbered from the top-left if the SORT function is used to change their order.

(Continued on next page)

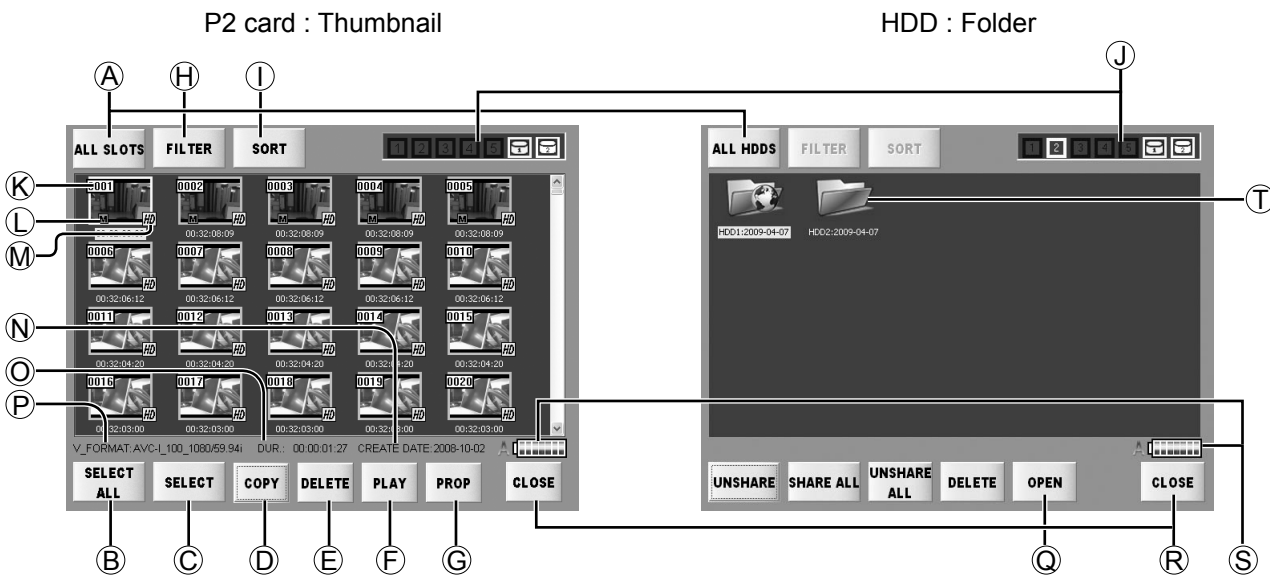

**L Shot marks**

These are displayed on the clips which have been provided with shot marks.  
The clips can be filtered depending on whether they are provided with shot marks or not. (page 30)

**M Icons**

- HD** : Displayed for high-definition clip.
- !** : Displayed if certain clips from a sequence are missing.
- X** : This is displayed when something is wrong with a clip.  
Clips with this mark cannot be copied or played back.

**N CREATE DATE**

The creation time of the clip (yellow framed) where the cursor is positioned is displayed here.

**O DUR.**

The recording duration of the clip (yellow framed) where the cursor is positioned is displayed here.

**P V\_FORMAT**

The recording signal format of the clip (yellow framed) where the cursor is positioned is displayed here.

**Q OPEN button**

Select the folder you want to view and press this button to open it.

**R CLOSE button**

P2 cards:  
Close the thumbnail screen and go back to the folder displaying screen.  
HDDs:  
Return to the main screen.

**S Power supply indicator (page 16)**

Shows the power supply status.

**T Folder**

The date on which copying was started is displayed as the folder name.

## Checking the clips in P2 card/HDD (continued)

### Copying individual clips (COPY)

This function button is not displayed when HDD is selected.

When the COPY button is pressed after the file has been selected (blue framed) on the EXPLORE screen, the copy destination selection screen appears.

(In the RAID1 mode)

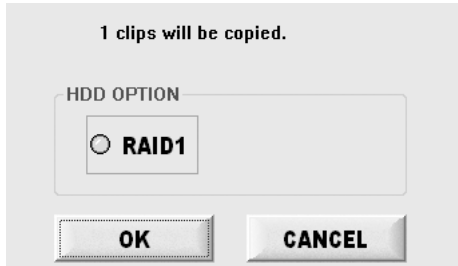

(In the JBOD mode)



Select the copying destination and press OK button to start the copying.

If Verify = ON button is set in the SETTING screen (page 39), it will Verify automatically after the copying. After the copying (or Verifying) is completed, the completion confirmation screen appears.

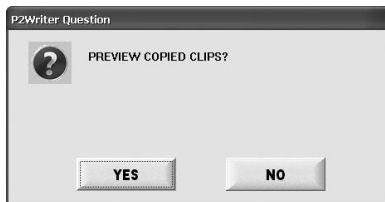

If the YES button is pressed on the confirmation screen, the EXPLORE screen which displays the folders and icons on the HDD will appear. If the NO button is pressed instead, the main screen is restored.

### Deleting individual clips (DELETE)

When the DELETE button is pressed on the EXPLORE screen, the selected clip (blue framed) can be deleted. "DELETE CLIP NUMBER" displays the number of clips selected.



You can do deleting operation according to the following methods.

#### A RECYCLE button

Move the clips to RECYCLE folder.

If necessary, the clips can be restored. (Page 35)

However, this button cannot be used with P2 cards.

#### B ERASE button

Delete from HDD completely.

Select the deleting method and press DELETE button, the clip will be deleted.

Press CANCEL button, you will go back to the thumbnail screen without deletion.

### Viewing clip properties (PROP)

When the PROP button is pressed on the EXPLORE screen, the properties of the clip where the cursor is located (yellow framed) will be displayed.

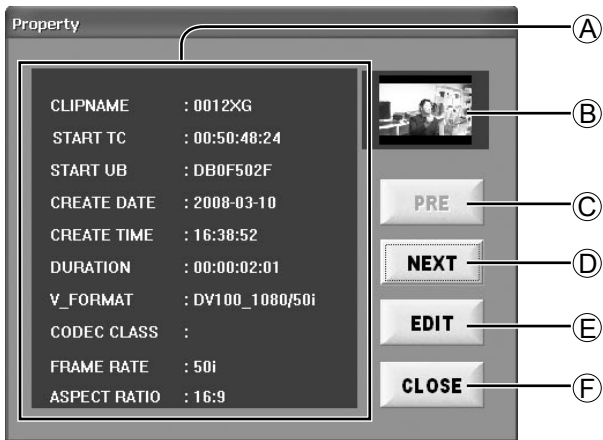

#### A Clip properties

Items are displayed as follows:

##### • CLIP NAME

Displays name of clip.

##### • START TC

Displays time code at beginning of clip.

##### • START UB

Displays Users Bit at beginning of clip.

##### • CREATE DATE

Displays date of recording.

##### • CREATE TIME

Displays time of recording.

##### • DURATION

Displays duration of recording.

##### • V\_FORMAT

Displays video compression format.

##### • CODEC CLASS

Displays compression ratio.

##### • FRAME RATE

Displays number of frames.

##### • ASPECT RATIO

Displays clip aspect ratio.

#### B Thumbnails

Shows a thumbnail of the clip for which you are viewing property information.

#### C PRE button

The property of the one chip before the one in cursor will be displayed.

#### D NEXT button

The property of the one chip after the one in cursor will be displayed.

#### E EDIT button

When this button is pressed, the Meta Data Edit screen (with the items shown on the right) is displayed, and the Meta Data can be changed.

#### F CLOSE button

Close the property screen and go back to the thumbnail screen.

The cursor moves to the thumbnail displayed last on the property display screen.

### Editing Meta Data

When any of the items to be edited on the Meta Data Edit screen is clicked, the letters of the EDIT button turn black only for those items which can be changed.

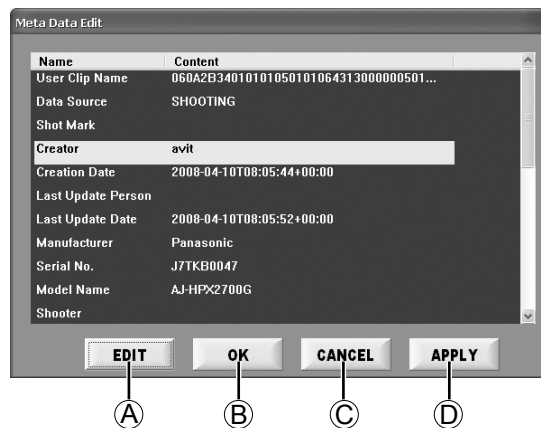

#### A EDIT button (page 29)

The soft keyboard is displayed.

For details on the soft keyboard, refer to page 29.

Meta Data of clips created using the Edit Clip function of other P2 devices cannot be edited.

#### B OK button

After overwriting the Meta Data with the currently displayed Meta Data, the Property screen is restored.

#### C CANCEL button

The Meta Data remains unchanged, and the Property screen is restored.

#### D APPLY button

The Meta Data is overwritten with the currently displayed Meta Data.

### soft keyboard

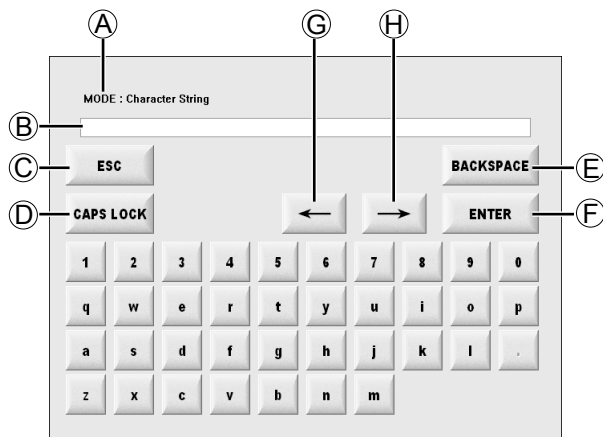

#### Ⓐ MODE

The names of the modes corresponding to the items are displayed here.

- Alphanumeric characters can be inputted when [Character String Mode] is displayed.
- Only numbers can be inputted when [Number Mode] is displayed.

#### Ⓑ Input column

Inputted alphanumeric characters are displayed.

#### Ⓒ ESC button

This restores the original Meta Data screen.

#### Ⓓ CAPS LOCK button

This switches the letters between the upper case and lower case.

#### Ⓔ BACKSPACE button

This deletes the character in front of the character where the cursor is located.

#### Ⓕ ENTER button

This enters the currently displayed data.

#### Ⓖ ← button

This moves the cursor in the input field toward the left.

#### Ⓗ → button

This moves the cursor in the input field toward the right.

Input instructions are as follows.

1. To enter letters, press keys on the on-screen keyboard.
2. To confirm input, press the ENTER button.

### Select listed devices (device selection buttons)

When the Device Selection Button is pressed on the EXPLORE screen, the devices to be displayed on the thumbnail screen are selected.

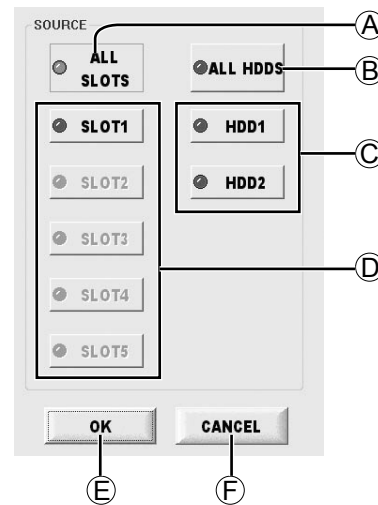

#### Ⓐ ALL SLOTS button

This displays all the slots.

#### Ⓑ ALL HDDS button

This displays all the HDD.  
This display will not appear when in RAID mode.

#### Ⓒ HDD1 button / HDD2 button / RAID1 button

HDD will be selected for each when in HDD mode.  
This button will be displayed as [RAID1] when in RAID mode.

#### Ⓓ SLOT1 button ~ SLOT5 button

These are used to select and display the slots.

#### Ⓔ OK button

Thumbnails are displayed in the case of P2 cards.  
Folders are displayed in the case of the HDDs.

#### Ⓕ CANCEL button

Close this screen and return to the EXPLORE screen.

Select devices as follows.

#### • P2 cards

Select the P2 card slot you require (either the ALL SLOTS or individual SLOT (1-5) buttons), and then press the OK button.

#### • HDDs

Select the HDD you require (from among the ALL HDDS, HDD1 or HDD2, or RAID1 button), and then press the OK button.

### Selecting clips to display (FILTER)

When the FILTER button is pressed on the EXPLORE screen, the combinations to be displayed on the thumbnail screen can be selected.

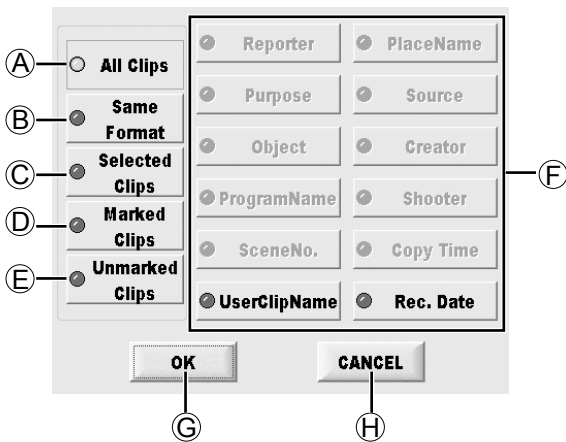

#### (A) ALL CLIPS button

All the clips of the displayed devices are displayed.

#### (B) SAME FORMAT button

This displays only those clips recorded in the same format as the clip (yellow framed) where the cursor is positioned.

#### (C) SELECTED CLIPS button

This displays only the clip (blue framed) which is in the selected status.

#### (D) Marked Clips

This displays only the clips provided with shot marks.

#### (E) Unmarked Clips

This displays only the clips not provided with shot marks.

#### (F) Meta Data items

Only the clips corresponding to the keyword which was input in the selected item are displayed.

#### (G) OK button

Filter by selected or preset conditions.

#### (H) CANCEL button

Close FILTER selection screen without performing filtering process.

When any of the Meta Data item buttons is pressed, the “keyword input” screen is displayed.

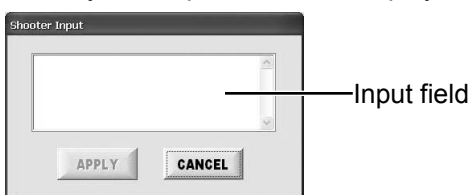

To input a keyword, click the input field, input the word using the soft keyboard screen, and enter it. For details on the soft keyboard, refer to page 29.

After entering the keyword, press the APPLY button and the OK button to proceed with filtering.

If there are no clips which match the keyword concerned, a message indicating that no such clips exist is displayed.

If clips matching the keyword exist, only the thumbnails of those clips are displayed.

Multiple keywords can be selected at once.

Press the CANCEL button to close the “keyword input” screen and return to the previous screen.

### Meta Data items

The following filtering processes may be performed for Meta Data items:

#### ● Reporter button

Filter by reporter.

#### ● Purpose button

Filter by coverage target.

#### ● Object button

Filter clips by content.

#### ● ProgramName button

Filter by program name.

#### ● SceneNo. button

Filter by scene number.

#### ● UserClipName button

Filter by clip name (set by user).

#### ● PlaceName button

Filter by coverage location.

#### ● Source button

Filter by input source.

#### ● Creator button

Filter by creator.

#### ● Shooter button

Filter by cameraman.

#### ● Copy Time button

Filter by time of copying to this unit.

#### ● Rec. Date button

Filter by date of recording.

## Checking the clips in P2 card/HDD (continued)

### Changing how clips are listed (SORT)

Change the displaying order of the selected clips. The following display appears when the SORT button is pressed on the EXPLORE screen.

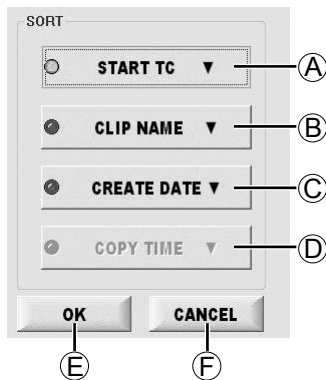

#### Ⓐ START TC button

This button rearranges the clips in the START TC order. Each time it is pressed, the start TC of the clips is switched between ascending or descending order.

#### Ⓑ CLIP NAME button

This button rearranges the clips in the CLIP NAME order. Each time it is pressed, the clip names are switched between ascending or descending order.

#### Ⓒ CREATE DATE button

This button rearranges the clips in the CREATE DATE order. Each time it is pressed, the dates of the clips are switched between ascending or descending order.

#### Ⓓ COPY TIME button

This button rearranges the clips in the COPY TIME order. Each time it is pressed, the copy times of the clips are switched between ascending or descending order.

#### Ⓔ OK button

This initiates the rearrangement of the clips as per the condition selected.

#### Ⓕ CANCEL button

This cancels the rearrangement of the clips, and restores the EXPLORE screen.

### Viewing slot numbers and HDD status

This indicates the P2 card or HDD containing the clip where the cursor is positioned.

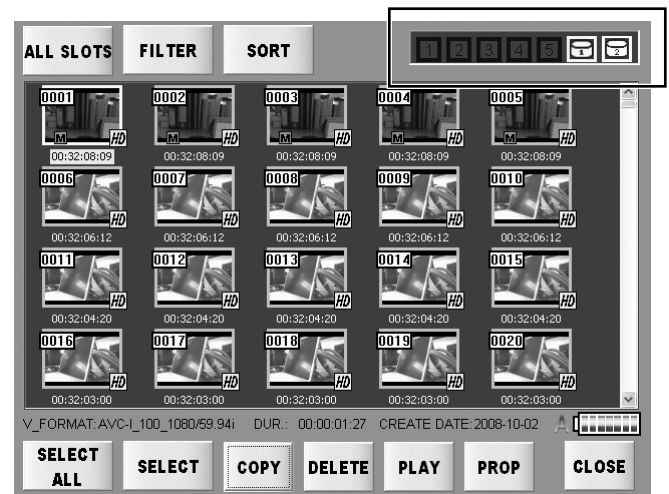

This displays the P2 card slot number or HDD containing the clips, in yellow.

If the recording of a clip extends over a multiple number of P2 cards, all the numbers of the slots where the P2 cards with the recorded clip are inserted are displayed.

The numbers of the slots where the P2 cards are inserted are displayed in white.

One HDD mark indicates a RAID1 configuration, and two HDD marks indicate a JBOD configuration. As with P2 cards, the HDD containing the clip where the cursor is positioned is displayed.

# Playing the clips

The PLAYER application starts up when the PLAY button is pressed after the clips to be played have been selected on the EXPLORE screen.

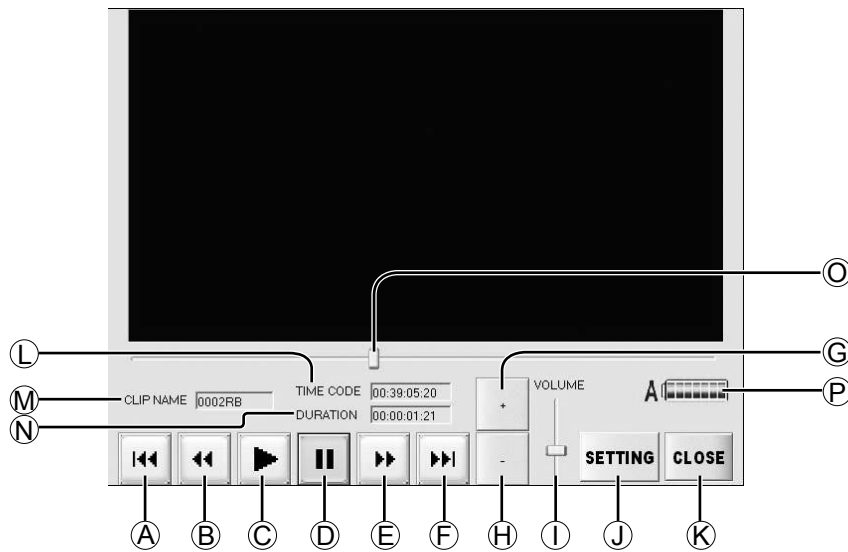

**A** (PREV button)

Each time this button is pressed, play jumps to the start of the previous clip.

**B** (REW button)

When this button is pressed, clips are played rapidly in reverse, skipping frames, at the playback speed specified on the SETTING screen (page 33).

**C** (PLAY button)

Press this button to play the clip.

**D** (PAUSE button)

Press this button to stop playing temporarily.

**E** (FF button)

When this button is pressed, clips are played forward rapidly, skipping frames, at the playback speed specified on the SETTING screen (page 33).

**F** (NEXT button)

Each time this button is pressed, play jumps to the start of the next clip.  
In the final clip, press the button again to jump to the end of the clip.

**G** (Volume Up button)

This increases the volume level of the sound.

**H** (Volume Down button)

This reduces the volume level of the sound.

**I** **VOLUME**

The slider is slid by operating the + and - buttons on the left.

**J** **SETTING button (page 33)**

Set the speed in the REW and FF.

**K** **CLOSE button**

Stop playing clips in PLAYER and go back to EXPLORE screen.

**L** **TIME CODE**

Indicate the time code of the clip being played now.

**M** **CLIP NAME**

Indicate the name of the clip being played now.

**N** **DURATION**

Indicate the duration of the clip being played now.

**O** **Slider**

You also can move the slider in the bottom of the screen to move to the designated position.

**P** **Power supply indicator (page 16)**

Shows the power supply status.

- 
- Black burst may occur between clips. This does not indicate a mechanical problem.
  - Because playback relies on software codecs, some frames are skipped. Real-time playback is not ensured.
-



## Playing the clips (continued)

---

### Setting the FF/REW rate

Set the speed in the REW and FF.

When SETTING button is pressed on the PLAYER application screen, the following screen appears.

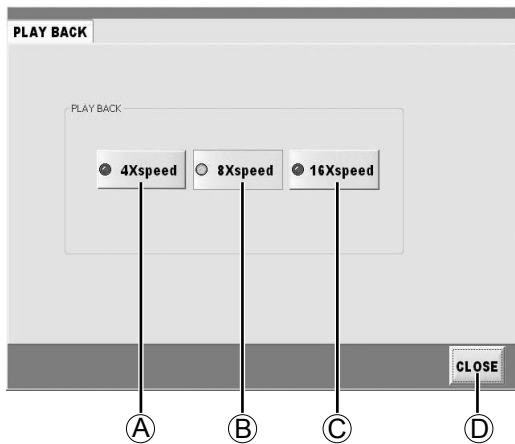

**Ⓐ 4Xspeed button**

Clips are played rapidly while skipping frames at a speed equivalent to 4 times the normal speed.

**Ⓑ 8Xspeed button**

Clips are played rapidly while skipping frames at a speed equivalent to 8 times the normal speed.

**Ⓒ 16Xspeed button**

Clips are played rapidly while skipping frames at a speed equivalent to 16 times the normal speed.

**Ⓓ CLOSE button**

This restores the PLAYER application screen.

# Sharing the folders

A shared setting can be established to allow the folders of an HDD selected on the "EXPLORE" screen to be accessed from another computer.

Please set Network in SETTING screen in advance.  
(page 38) Accessing via network will not enable if you do not set so.

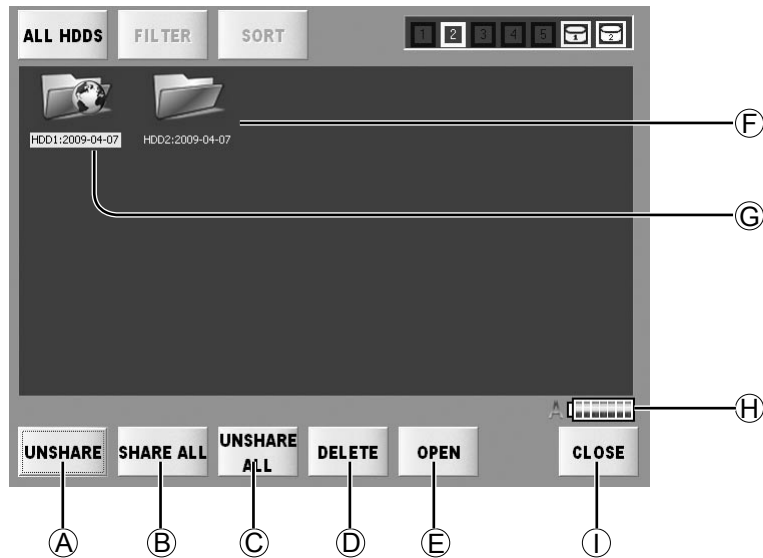

## Ⓐ SHARE button / UNSHARE button

Select the folder and press this button to share. Select the shared folder and press UNSHARE button to make it in unshared state.

## Ⓑ SHARE ALL button

Press this button to share all the folders.

## Ⓒ UNSHARE ALL button

Press this button to make all the folders in unshared state.

Sharing is on the basis of individual folders.

## Ⓓ DELETE button

When this button is pressed, the selected folder can be deleted. (page 27)

## Ⓔ OPEN button

Select the folder you want to view and press this button to open it.



In this status, the network is not shared.



In this status, the network is shared.

## Ⓕ Power supply indicator (page 16)

Shows the power supply status.

## Ⓖ CLOSE button

This closes the EXPLORE screen and restores the main screen.

# Returning the clips in the RECYCLE folder

When the RECYCLE button is pressed on the main screen, the RECYCLE screen is displayed. The clips in the RECYCLE folder and folders can now be displayed, deleted or restored.

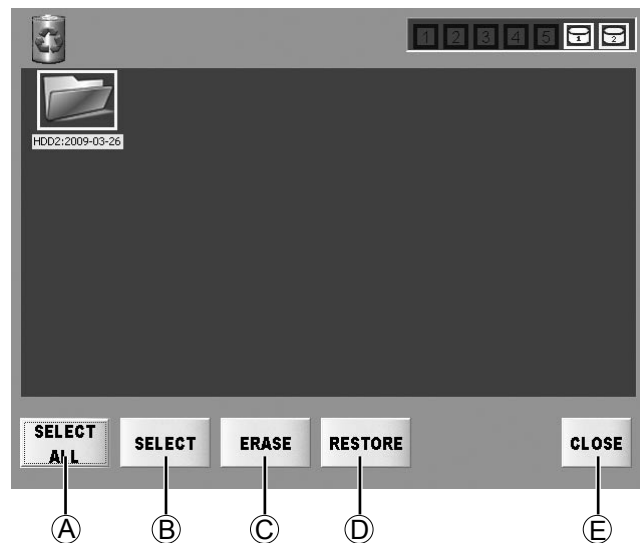

**(A) SELECT ALL button / UNSELECT ALL button**

Pressing the SELECT ALL button enables you to select all clips and folders in the RECYCLE folder at once. Afterwards, the button is labeled "UNSELECT ALL."

Pressing the UNSELECT ALL button clears the selected status of all clips and folders and changes the button label to "SELECT ALL."

**(B) SELECT button / UNSELECT button**

Move the cursor to desired clips and folders and press the SELECT button to select them.

The button label changes to "UNSELECT" when the cursor is moved to selected clips and folders. Pressing the UNSELECT button clears the selected status.

When the button is double-clicked, its display is switched between SELECT and UNSELECT.

**(C) ERASE button**

This completely erases the selected folder and clips.

---

Folders and clips, once erased, cannot be restored. Check carefully if a folder or clip will be needed before erasing folders and clips.

---

**(D) RESTORE button**

This returns the selected folder and clips to their original location.

**(E) CLOSE button**

Return to the main screen.

# Formatting

To format a P2 card or HDD, press the **FORMAT** button on the main screen. The device selection screen to be formatted now appears.

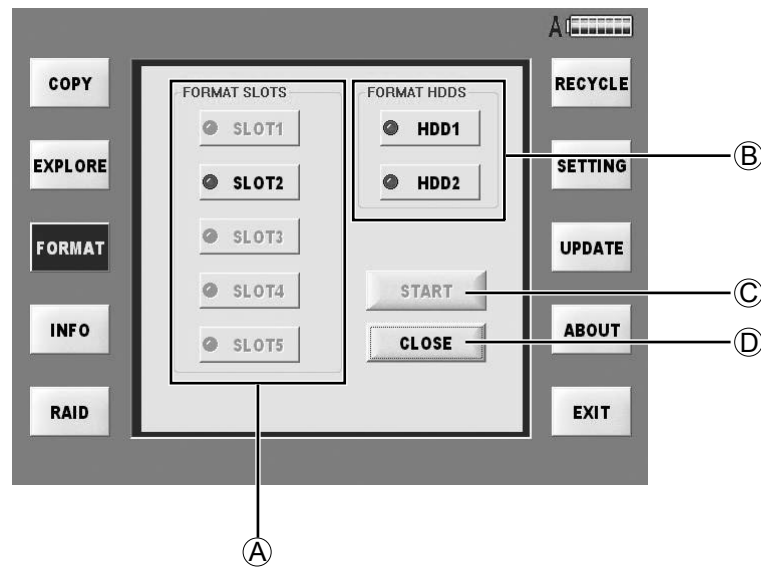

## Ⓐ **FORMAT SLOTS button**

SLOT1 button/SLOT2 button/SLOT3 button/  
SLOT4 button/SLOT5 button

These buttons can be used to select the P2 cards inserted in any slot.

## Ⓑ **FORMAT HDDS button**

HDD1 button/HDD2 button/RAID1 button

These buttons can be used to select any of the HDDs.

## Ⓒ **START button**

This starts the formatting.

## Ⓓ **CLOSE button**

Return to the main screen.

- 
- Be careful when formatting media or devices. Formatting will erase all data on P2 cards or HDDs.
  - P2 cards cannot be formatted if the write-protect switch is set to Protect.
- 

The device is formatted by taking the following steps.

- 1 Select the device and press **START** button, the **FORMAT** confirming screen will display.**
- 2 Press **OK** button in this screen, the further confirming screen will display.**
- 3 Press **OK** button again and begin the formatting. Please understand that it can not be canceled once the formatting begins.**

The ending confirming screen will display after formatting, press **OK** button to go back to the device selecting screen.

If you press **CANCEL** button before formatting, you can go back to the device selecting screen.

An error message is displayed if formatting is not possible.

---

All the formats are FAT32. (The largest volume is limited to 2 TB by the FAT32 format. Please understand it when you install larger HDD in the future.)

---

# Checking the state of all slots

Press INFO button in the main screen, the INFO screen will display.

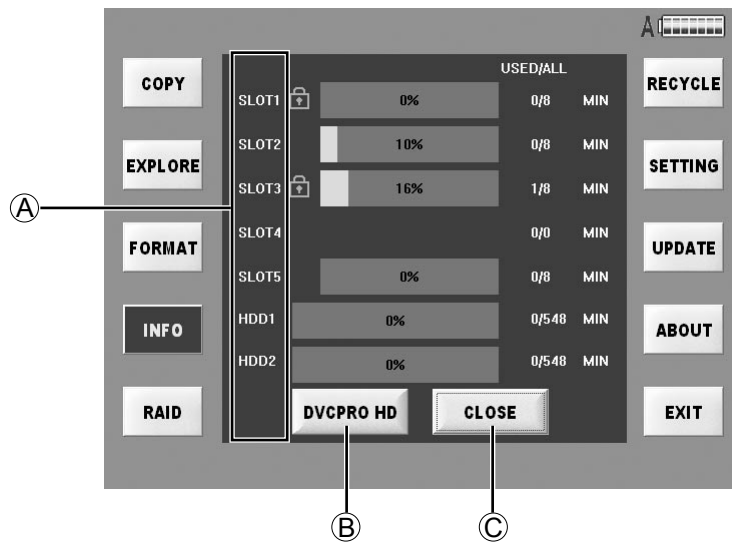

You can check the volume of P2 cards in any slot or the HDDs. The default volume name is DVCPRO HD. If you want to check the volume in other format, please press FORMAT select button on the bottom of the screen.

## Ⓐ Slots

Write-protected P2 cards are identified by a (🔒) mark next to the slot number.

## Ⓑ Format select button

This indicates the used memory and total memory (USED/ALL) in minutes (MIN) for the corresponding format.

One of the following 5 buttons is displayed.

- [DVCPRO]
- [DVCPRO 50]
- [DVCPRO HD]
- [AVC-I50]
- [AVC-I100]

## Ⓒ CLOSE button

Close the INFO screen and go back to the main screen.

# System setting

Press SETTING button to set the system in the main screen.  
This SETTING screen is constructed by plural TAB as the following.  
For details, refer to the explanations for each individual tag

## Configuring network settings (Network)

Set network access of LAN1 as well as LAN2.

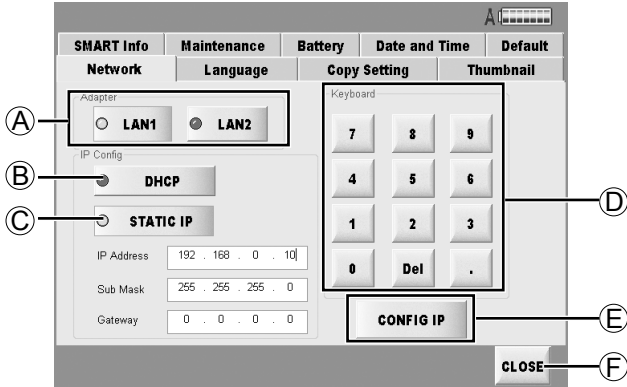

### A Adapter

Select rear panel LAN connector. (Page 7)

### B DHCP

This sets the IP address automatically.  
The IP address is allocated automatically from the DHCP server if a DHCP server is available in the network environment connected.

### C STATIC IP

With this, the IP address is set manually.  
Input from the numeric keypad on this screen and press CONFIG IP button to set.

#### • IP Address

Indicate the IP address you set or set by the server.

#### • Sub Mask

Indicate the sub mask you set.

#### • Gateway

Indicate the gateway you set.

### D Keyboard

Use this numeric keypad to input IP address when setting address manually.

### E CONFIG IP button

Press this button to confirm manual IP address setting after inputting the address.

### F CLOSE button

Return to the main screen.

## Specifying the display language (Language)

Select the language you want to use in all the screens.

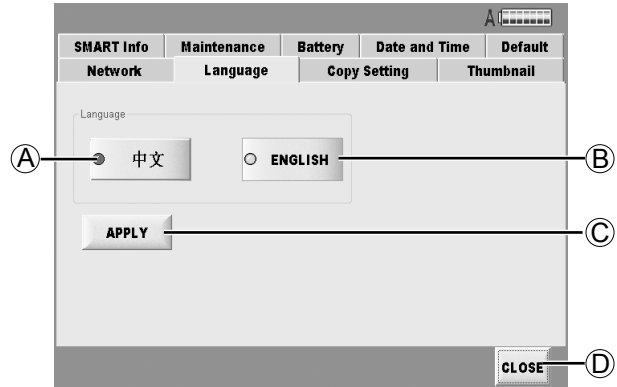

### A 中文

displaying in Chinese

### B ENGLISH

displaying in English

### C APPLY button

Set to selected language.

### D CLOSE button

Return to the main screen.

Even if the APPLY button is pressed, the display will not be switched.  
After the unit is restarted, the display will be in the selected language.

### Specifying copy options (Copy Setting)

Set the option functions in copying.

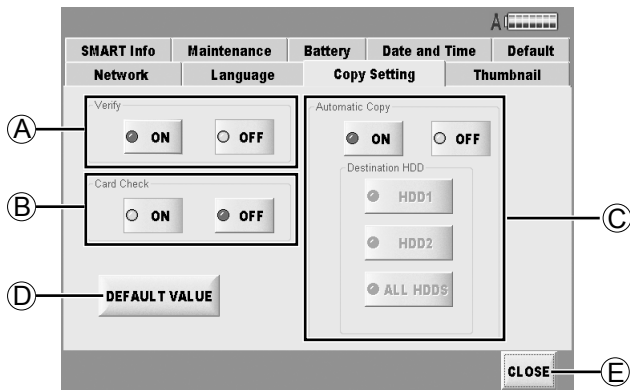

#### A Verify

Compare source and destination data after copying is finished.

- **ON button**  
Compare data.
- **OFF button**  
Do not compare data.

#### B Card Check

Check whether the same status applies to the data on the P2 card which has been inserted as that for the data copied onto the HDD.  
If any changes have been made to a copied P2 card such as when data has added or deleted, the card will not be treated as a copied card.

- **ON button / OFF button**  
Set the CARD CHECK function to Activate (ON) or Deactivate (OFF).

#### C Automatic COPY

This function will automatically copy inserted P2 cards.

- **ON button / OFF button**  
Set the AUTO COPY function to Activate (ON) or Deactivate (OFF).
- **Destination HDD button**  
Set the destination for AUTO COPY.  
"Destination HDD" will be displayed as "RAID1" when in RAID1 mode.

#### D DEFAULT VALUE button

Restore [Copy Setting] screen settings only to factory settings.

#### E CLOSE button

Return to the main screen.

### Changing thumbnail display (Thumbnail)

Specify how the thumbnail screen is organized for clips shown on the "EXPLORE" screen.

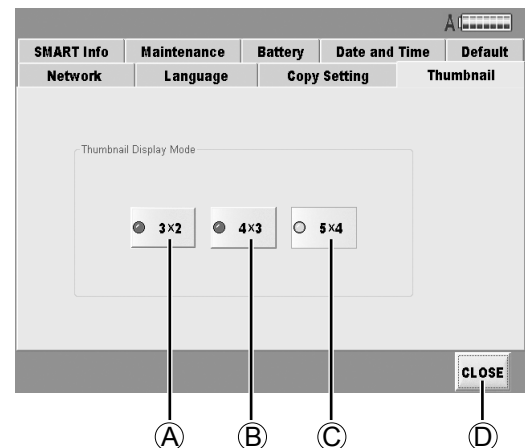

#### A 3x2 button

The thumbnails are displayed in three rows on two levels.

#### B 4x3 button

The thumbnails are displayed in four rows on three levels.

#### C 5x4 button

The thumbnails are displayed in five rows on four levels.

#### D CLOSE button

Return to the main screen.

### Checking SMART Info

“SMART” is an abbreviation of “Self-Monitoring, Analysis and Reporting Technology”. This function is incorporated within hard disk drives in order to quickly discover any problems the drive and estimate the extent of the damage.

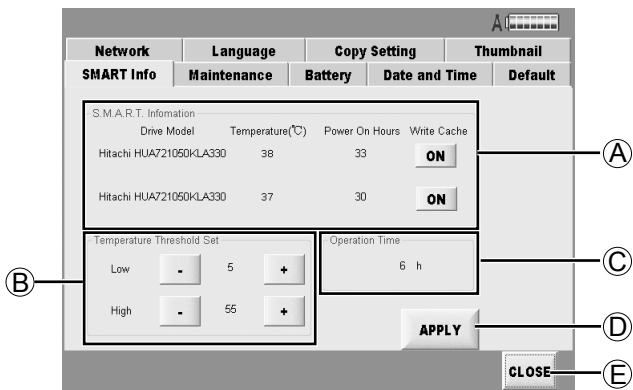

#### Ⓐ S.M.A.R.T. Information

##### ● Drive Model

The model numbers of the HDD currently used are displayed in this column.

##### ● Temperature (°C)

The current temperatures of the HDD are displayed in this column.

##### ● Power On Hours

The total power-on time of the HDD are displayed in this column.

##### ● Write Cache

These can be used to set the Write Cache of the HDD to ON or OFF.

##### ON button:

The response to data writing is faster but it may actually take a short while for the data to be written on the HDD.

##### OFF button:

The response time is longer than at the ON setting, but the data will definitely be written. (This is the factory setting.)

#### Ⓑ Temperature Threshold Set

Alarm messages are displayed if HDDs exceed the specified temperature. If the APPLY button is not pressed after these settings have been changed, the new settings will not be reflected.

##### ● Low (Setting range: 0 °C to 10 °C)

When the temperature falls below this setting, the low-temperature alarm is displayed. (Factory setting: 5 °C)

##### ● High (Setting range: 50 °C to 60 °C)

When the temperature rises above this setting, the high-temperature alarm is displayed. (Factory setting: 55 °C)

##### ● + button

When this is pressed, the temperature setting is increased.

##### ● – button

When this is pressed, the temperature setting is reduced.

When these settings are changed, the following message is displayed.

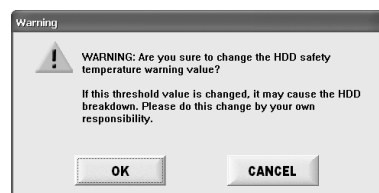

#### Ⓒ Operation Time

Displayed here is the main unit's operation time.

#### Ⓓ APPLY button

Set the Write Cache mode and the Temperature Threshold Set value in the S.M.A.R.T. Information box.

#### Ⓔ CLOSE button

Return to the main screen.



## System setting (continued)

### Setting battery level warnings (Battery)

Change battery settings.

Settings can be made for two different batteries

– Battery1 and Battery2 – which may then be selected as required

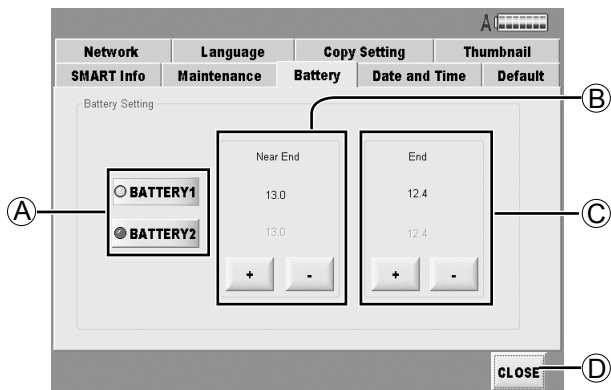

- Ⓐ **BATTERY1 button / BATTERY2 button**  
Individual settings may be made.
- Ⓑ **Near End**  
If the voltage falls below this value, an error message will be displayed and the final part of the “Power Indication” will be shown in red.
- Ⓒ **End**  
If the voltage falls below this value, the unit will be automatically shut down.
- Ⓓ **CLOSE button**  
Return to the main screen.

### Setting the date and time (Date and Time)

Set the unit's date and time.

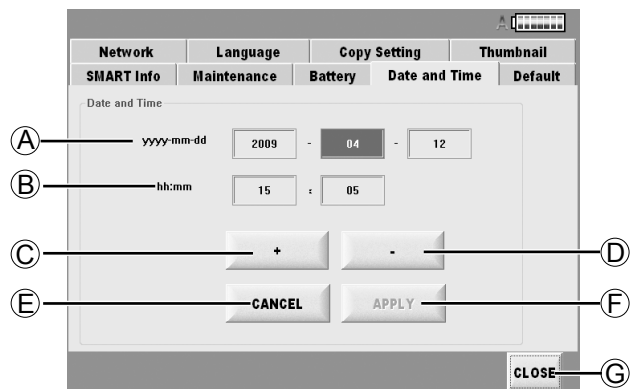

- Ⓐ **yyyy-mm-dd**  
Set the date (year/month/day).
- Ⓑ **hh:mm**  
Set the time.
- Ⓒ **+ button**  
Use this to increment the numerical values.
- Ⓓ **- button**  
Use this to decrement the numerical values.
- Ⓔ **CANCEL button**  
Use this to undo the change made to a numerical value.
- Ⓕ **APPLY button**  
Use this to set the date and time which have been input.
- Ⓖ **CLOSE button**  
Return to the main screen.

Follow the steps below to change the date.

- 1** Select the column where the change is to be made.
- 2** Press the + button or - button to change the numerical value.
- 3** To enter the change, press the APPLY button.  
To cancel the setting, press the CANCEL button.

### Undoing the setting (Default)

The setting is undone.

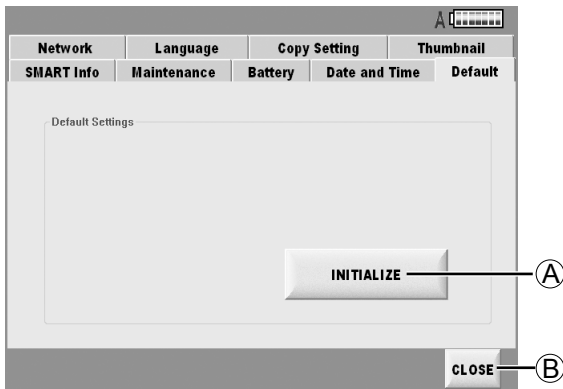

**Ⓐ INITIALIZE button**

Use this to restore all the settings except the ones below to the factory settings.

- Network
- Battery

**Ⓑ CLOSE button**

Return to the main screen.

**1 To restore the settings to the factory settings, press the INITIALIZE button.**

---

Bear in mind that all the settings except for Network and Battery will be restored to the factory settings.

---

# Maintenance

## Checking HDD status (Maintenance)

The operations of the installed HDD can be checked on the screen which appears when the maintenance button on the SETTING screen is pressed.

The inserted HDD is easily damaged. To keep the unit in optimal condition, we recommend that you inspect it regularly and confirm the state of the HDD in advance.

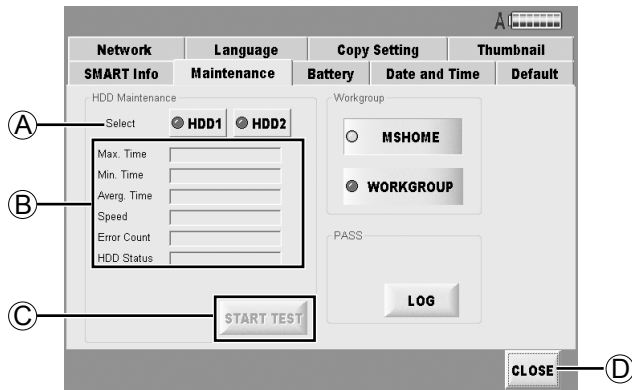

**1 Select the HDD to check.**

**2 Press the Start Test button.**

The display changes to [STOP].

The data on the entire HDD is read, and if it is taking longer to access the data than the prescribed access time, a warning message is displayed.

To stop the checking operation at any time, press the STOP button. The check operation is stopped, and the results of what has been checked so far are displayed.

- It takes about 2 hours to check 500 GB of data so use the external DC power supply.
- Only HDD1 is accessed when the unit is used in the RAID1 mode. To check both HDDs, set the RAID1 mode to the JBOD mode, and check each HDD in turn.

**A Select**

Select HDD on which to perform maintenance.

**B Maintenance status**

- **Max. Time**  
Display maximum access time (ms).
- **Min. Time**  
Display minimum access time (ms).
- **Averg. Time**  
Display average access time (ms).
- **Speed**  
Display average access rate (MB/s).
- **Error Count**  
Display average number of errors detected.
- **HDD Status**  
Display HDD status.  
If "WARNING" or "NG" is displayed, remove the HDD immediately.

**C START TEST button**

Start HDD status verification.

**D CLOSE button**

Return to the main screen.

## Maintenance (continued)

### Creating PASS registration data

Register as a PASS (P2 Asset Support System) member to use P2 Status Logger, an inspection utility for P2 devices. With this utility, you can check the software version of registered devices, update the software, and manage usage records. Prepare the latest data for checking and management as follows.

**1** Connect the unit to a network where there is a computer with P2 Status Logger installed.

**2** Press the LOG button at the bottom right of the Maintenance tab screen on the SETTING screen.

The latest registration data is created automatically.

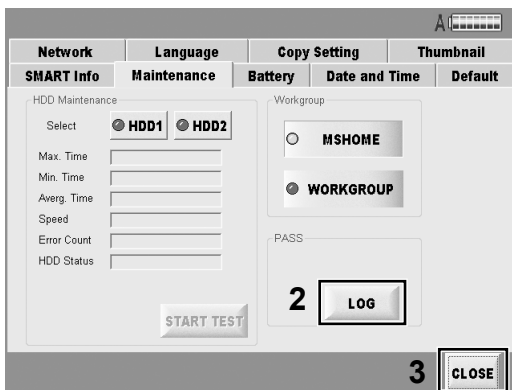

On the computer mentioned in step 1, access the registration folder on the unit (\\P2Writer PASS) over the network and acquire the registration data. You can now review a variety of information about the unit and manage records.

**3** After registration data is acquired, press the CLOSE button to return to the main screen.

### Selecting a workgroup

You can choose either MSHOME or WORKGROUP as the name of the workgroup to be used by the network.



# Version up

Follow the steps below to proceed with version updating.

- 1** The version update module which is downloaded from the Panasonic home page contains compressed files so unzip them.

For further details about the updating methods, refer to the following website.

<https://www.pavc.panasonic.co.jp/pro-av/>

- 2** On the main screen, press the UPDATE button.

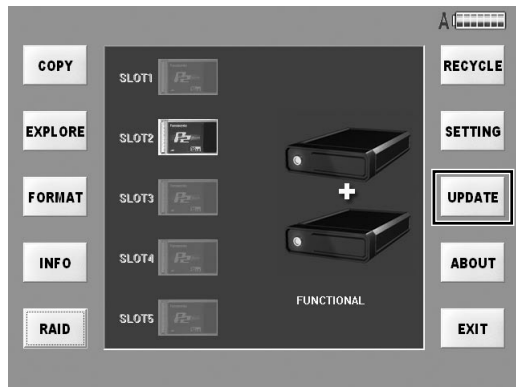

The following message is displayed.

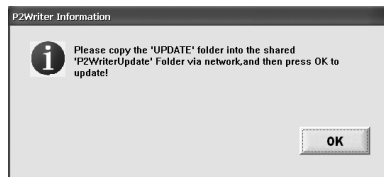

- 3** At the time when step 2 is taken, copy the data which was unzipped in step 1 into the unit's version update folder (C:\P2WriterUpdate) over the network from the PC used to download the data.

- 4** After copying the data, please push the OK button.

- 5** If a new version is found, the version will be updated automatically. A message prompting you to restart the unit is then displayed so restart the unit.

If only the data for an old version is found, the version is not updated.

- 6** After the unit has been restarted, check that the version has been updated successfully by noting the version number on the ABOUT screen.

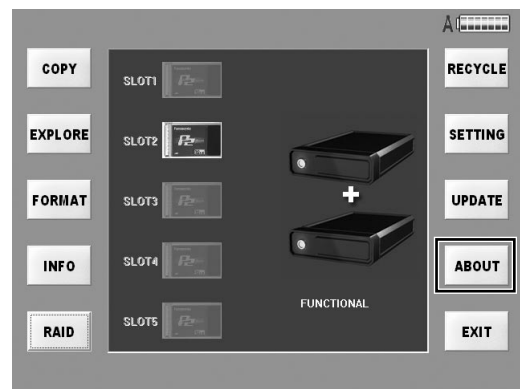

Press OK button to go back to the main screen. The number of the version is indicated in "X.X.XX" displayed in the dialog box.

# Connecting to a computer

---

## Network connecting

When data sharing has been set using the SHARE function, the HDD data which has been set to be shared over the network can be accessed. For security reasons, "Read Only" is displayed if access is attempted by external users.

When you connect this unit to another computer via a network, the computer must be set up to enable the joint drives of the Windows computer to be accessed. You have to refer to the joint part of the network of the computer for details of the setting.

## Inserting the HDD directly in the 5 inch bay unit

If identical 5-inch bay units have been installed, the HDDs unmounted from the unit can be connected directly.

It is also possible to connect discrete HDDs by using the interfaces.

---

The contents may be deleted in the OS such as Windows, Macintosh, Linux for the clips are in FAT32 format. Please understand it when you access to HDD.

---

# Backing up the data

---

We recommend that you make a backup on a separate storage media in order to protect the important data saved in the HDD.

It is necessary to check the volume of the storage media which used to back up the data.

## For Windows

### • Using Windows Explorer

Select top-level folders and files of a displays drive on the unit. Copy the folder to your preferred target folder on the computer. Execute the same procedure on all drives of the unit.

### • Using the "P2 Viewer"

Select needed clips and copy them to your preferred target folder on the computer, where you have set up the virtual drive. Refer to the P2 viewer's operating instructions for details on operation.

## For Macintosh

### • Using Finder

Double-click folders displayed on the desktop (which represent drives on the unit) to open them. Select top-level folders and files and copy them to your preferred folder on the computer. Copy all the contents of other drives on the unit the same way.

# Troubleshooting

---

If the unit seems to be malfunctioning, try checking the following points.

If the problem persists, contact the place of purchase.

Symptom	What to check
The unit does not go on even when the front POWER button is pressed.	<ul style="list-style-type: none"><li>• Is the rear POWER switch at the OFF setting?</li><li>• Is the battery drained?</li><li>• Is the external DC power supply connected correctly?</li></ul>
The auto copying does not begin after inserting P2 cards.	<ul style="list-style-type: none"><li>• Is the remaining volume of HDD enough?</li><li>• Is there enough charge left in the battery?</li><li>• Is the auto copy function set to OFF?</li></ul>
P2 cards cannot be formatted	<ul style="list-style-type: none"><li>• Is the write-protect switch set to PROTECT?</li><li>• Is the P2 card inserted correctly?</li></ul>

# Specifications

---

**Power supply** DC 12 V (11 V to 17 V)

**Power consumption** 70 W

indicates safety information.

## External IF

LAN1/LAN2 : Gigabit Ethernet LAN port

## Dimensions (W) × (H) × (D)

368 mm × 177 mm × 303 mm  
(14.49 inches × 6.97 inches × 11.93 inches)  
(Excluding protrusions)

## Weight

Approx. 6.3 kg (13.86 lb)  
(excluding the HDDs and 5-inch bay units)

## Operation environment

Operating temperature: 0 °C to 40 °C  
(32 °F to 104 °F)  
Humidity: 10 % to 85 %  
Storage temperature: -20 °C to 60 °C  
(-4 °F to 140 °F)  
Humidity: 10 % to 85 %

In order to protect the HDD, if the internal temperature of the HDD exceeds the specified temperature range of the unit, a warning is displayed and some operations are disabled, because operation under these conditions may damage the unit.

## Requirement for connecting to PC

Be able to connect to Microsoft Network  
Be able to connect the PC using a Gigabit LAN.

## Specifications of HDD which can be used (Optional)

SATA-2, 7200 r/min, 3.5-inch internal type

## 5-inch bay unit box (×2) specifications

Power : Power source connector for SATA  
4 pin power connector  
SATA signal : 7 pin connector for SATA

## Audio output connectors

Headphone output: 3.5-mm stereo mini jack ×1  
Speakers×1

## Information for Users on Collection and Disposal of Old Equipment and used Batteries



These symbols on the products, packaging, and/or accompanying documents mean that used electrical and electronic products and batteries should not be mixed with general household waste. For proper treatment, recovery and recycling of old products and used batteries, please take them to applicable collection points, in accordance with your national legislation and the Directives 2002/96/EC and 2006/66/EC. By disposing of these products and batteries correctly, you will help to save valuable resources and prevent any potential negative effects on human health and the environment which could otherwise arise from inappropriate waste handling. For more information about collection and recycling of old products and batteries, please contact your local municipality, your waste disposal service or the point of sale where you purchased the items. Penalties may be applicable for incorrect disposal of this waste, in accordance with national legislation.



### For business users in the European Union

If you wish to discard electrical and electronic equipment, please contact your dealer or supplier for further information.

### Information on Disposal in other Countries outside the European Union

These symbols are only valid in the European Union. If you wish to discard these items, please contact your local authorities or dealer and ask for the correct method of disposal.



### Note for the battery symbol (bottom two symbol examples):

This symbol might be used in combination with a chemical symbol. In this case it complies with the requirement set by the Directive for the chemical involved.

## Panasonic Corporation

Web Site: <http://panasonic.net>

## Panasonic Broadcast & Television Systems Company

### Unit Company of Panasonic Corporation of North America

Executive Office: One Panasonic Way 4E-7, Secaucus, NJ 07094 Tel: 201-348-7000

Eastern Zone: One Panasonic Way 4E-7, Secaucus, NJ 07094 Tel: 201-348-7196

Southeast Region: Tel: 201-392-6151

Western Zone: 3330 Cahuenga Blvd W., Los Angeles, CA 90068 Tel: 323-436-3608

### Government Marketing Department:

One Panasonic Way 2E-10, Secaucus, NJ 07094 Tel: 201-348-7587

### Broadcast PARTS INFORMATION & ORDERING:

9:00 a.m. – 5:00 p.m. (EST) Tel: 800-334-4881/24 Hr. Fax: 800-334-4880

Emergency after hour parts orders Tel: 800-334-4881

e-mail: [PBTSparts@us.panasonic.com](mailto:PBTSparts@us.panasonic.com)

TECHNICAL SUPPORT: Emergency 24 Hour Service Tel: 800-222-0741

e-mail: [PBTSCservice@us.panasonic.com](mailto:PBTSCservice@us.panasonic.com)

## Panasonic Canada Inc.

5770 Ambler Drive, Mississauga, Ontario L4W 2T3 Tel: 905-624-5010

## Panasonic de México S.A. De C.V.

Casa Matriz: Moras No.313 Col. Tlacoquemecatl Del Valle Del Benito Juárez México, D.F., C.P.03200

Tel: 55-5488-1000 Fax: 55-5575-6783

## Panasonic Latin America, S.A.

P.O.Box 0816-03164 Panama, Republic of Panama Tel: +507-229-2955 Fax: 507-229-5352

## Panasonic do Brasil Ltda.

Rua Cubatão, 320-6º andar-Paraíso CEP 04013-001- São Paulo -SP Tel: 11-3889-4000 Fax: 11-3889-4004

## Professional & Broadcast IT Systems Business Unit Europe

### Panasonic AVC Systems Europe a Division of Panasonic Marketing Europe GmbH

Hagenauer Str. 43, 65203 Wiesbaden-Biebrich Deutschland Tel: +49-611-235-481

## Panasonic Systems Asia Pacific (Broadcast Regional Operation Center)

2 Jalan Kilang Barat, Panasonic Building, Singapore 159346 Tel: +65-6270-0110

## 파나소닉 코리아 주식회사 (PKL)

서울특별시 서초구 서초동 1718-9 서현 BLDG

서비스 문의 : 02-533-8452

<http://panasonic.kr>

## パナソニック株式会社 AVCネットワークス社 システム事業グループ

〒 571-8503 大阪府門真市松葉町 2 番 15 号 ☎ (06) 6901-1161