

SONY®



XDCAM EX Family

XDCAM EX Camcorder

PMW-350

PMW-EX3

PMW-EX1R

XDCAM EX Recording Deck

PMW-EX30

www.sony.com/xdcamex

XDCAM EX

XDCAM EX Series – Comprehensive Line-up Opens New Horizons of Visual Expression, Delivers New Levels of Convenience

Since 2007 and the introduction of the first camcorder in this line-up, the SONY XDCAM EX™ Series has achieved wide acclaim among creative professionals, and now grows from strength to strength, opening up new horizons of visual expression and delivering new levels of convenience.

The series already includes two outstanding camcorders – the PMW-EX1 and PMW-EX3 – which realize full-HD pictures of amazingly high quality by adopting three 1/2-inch-type Exmor™ full-HD CMOS sensors in a compact body. An advanced workflow, based on SxS PRO™ memory card as the recording media, ensures effective file-based operation.

Now Sony evolves this XDCAM EX line-up with the introduction of two new camcorders.

The PMW-350 is the first and long-awaited shoulder-mount camcorder in the family. It comes equipped with the cutting-edge imaging technology of three 2/3-inch-type Exmor full-HD CMOS sensors, and uses SxS memory card as the recording media.

The other new camcorder is the PMW-EX1R, the direct successor of the PMW-EX1. It includes DVCAM recording and playback function as standard, as well as numerous improvements over the PMW-EX1.

Both new camcorders utilize not just SxS PRO memory but also more affordable SxS-1™ media. There is also an innovative on-site backup solution with PXU-MS240 – enhancements which improve workflow and expand user convenience.

This full Sony XDCAM EX line-up provides stunning HD picture quality and efficient nonlinear operation, expanding the creative possibilities in every type of HD video production. Added to this, these new horizons of visual expression and new levels of convenience can be achieved at affordable price points.



XDCAM EX – A New Generation of HD Recording System

Enhanced Functionality with Exmor CMOS

In XDCAM EX camcorders, multiple A/D converters on each pixel row convert analog signals to digital as soon as they are generated, unlike traditional technology that only has one A/D converter on each chip. Exmor virtually eliminates the influence of any external noise that enters the signal chain during transfer to the A/D converter, resulting in high-quality digital signals with extremely low noise. This significantly enhances shooting in low-light environments.

Exmor
FULL HD 3CMOS

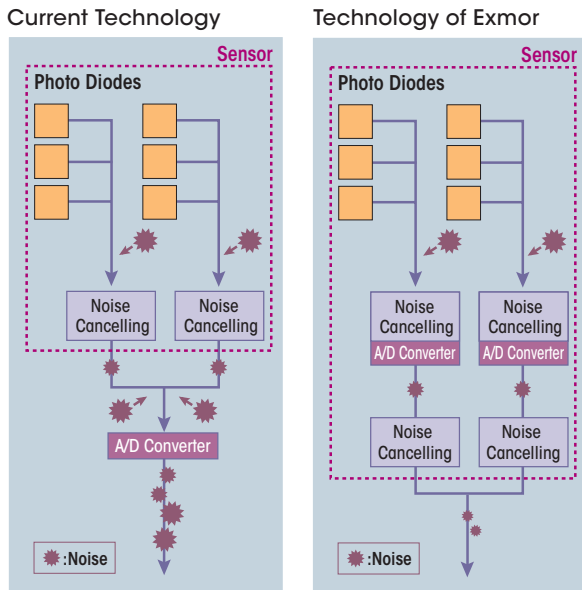

New Nonlinear Recording Media – SxS Memory Card – For Greater Efficiency and Operability

The XDCAM EX Series adopts the SxS memory card as its recording media. This is an ultra-compact nonlinear medium using flash memory; and offers a number of distinguishing features:

SxS

- Compatible with the ExpressCard/34 standard
- Uses the PCI Express interface, and achieves an extremely high data transfer speed of 800 Mbps*
- Large storage capacity: up to 32-GB
- Most new Macintosh and PC computers are equipped with ExpressCard slots
- Compact size: approx. 3 x 1 3/8 x 7/32 inches (75 x 34 x 5 mm) excluding projecting parts; about half the size of a conventional PC card
- Low power consumption

In addition to the conventional SxS PRO memory card, there is now a new member of the SxS memory card family, the SxS-1.** It maintains the superb usability and high-speed transfer rate of SxS PRO card, at



SxS PRO Memory Card



SxS-1 Memory Card

an affordable price. A high-capacity SBS-32G1 (32-GB) memory card is available.

* This data is read-speed measured with benchmark software. Actual data transfer speeds may vary according to measurement conditions. Please refer to <http://www.sony.net/SxS-Support/> for information on measuring methods.

** SxS-1 memory card supports fewer re-writes than SxS PRO memory card. Notification is given when an SxS-1 memory card approaches its end of life. Current PMW-EX1, PMW-EX3 camcorders and PMW-EX30 deck require an update (available in the Spring of 2010) to use SxS-1 memory cards.

1920 x 1080 HD Recording Using the MPEG-2 Long GOP Codec

XDCAM EX products record 1920 x 1080 HD images using the MPEG-2 Long GOP codec, which conforms to the MPEG-2 MP@HL compression standard. This highly efficient codec, also adopted in XDCAM® HD Series and HDV™ 1080i Series products, enables users to record stunning-quality HD video and audio over a long period of time thanks to efficient data compression.

MPEG HD

Selectable Format and Bit Rates

A choice of bit rates is offered with XDCAM EX products – either 35 Mbps (HQ mode) or 25 Mbps (SP mode) – depending on the desired picture quality and recording time.

In addition to conventional 1920 x 1080 and 1280 x 720 resolutions, the PMW-350 and PMW-EX1R also offer a new 1440 x 1080 resolution in HQ mode, with interoperability at 35 Mbps between XDCAM EX and XDCAM HD systems. Clip Browser software can very rapidly unwrap MP4 file wrappers created by XDCAM EX products into MXF file wrappers for XDCAM HD products without touching the MPEG2 Long GOP codec inside these two wrappers.

SP mode supports 1440 x 1080 resolution at 25 Mbps, providing compatibility with HDV 1080i products. Footage recorded in SP mode can be seamlessly integrated into HDV-compatible editing systems by connecting the camcorder via an i.LINK* (HDV) interface. It can also be recorded on an XDCAM HD optical disc using supplied Clip Browser software.

* i.LINK is a trademark of Sony Corporation used only to designate that a product contains an IEEE 1394 connector. Not all products with an i.LINK connector will necessarily communicate with each other. For information on compatibility, operating conditions, and proper connection, please refer to the documentation supplied with any device with an i.LINK connector. For information on devices that include an i.LINK connection, please contact your nearest Sony office or authorized dealer.

Recording and Playback in DVCAM™ Mode (PMW-EX1R & PMW-350 Only)

In addition to HD mode, the PMW-EX1R and PMW-350* support SD recording and playback in DVCAM mode. This is extremely useful for those currently using an SD production system who need a smooth migration path to a future HD production system. An AVI Type 2 file is recorded, which is a highly interoperable file format for nonlinear editing systems.

DVCAM

* The PMW-350 requires an optional hardware key, CBK-DV01.

Long Recording Time

Combining the moderate bit rates produced by efficient MPEG-2 Long GOP compression and a large-capacity SxS memory card, XDCAM EX products record high-quality HD images for a long recording time of up to 140 minutes on a single 32-GB SxS memory card in SP mode.

When a clip spans two cards, the transition is seamless, without any artifacts or frame loss. The SxS memory card can be hot-swapped while shooting, without interrupting the recording. This feature makes XDCAM EX products ideal for a wide variety of long-form content-production applications.

Recording Time (approx.)* (on 32-GB memory card)	HQ mode, 35 Mb/s VBR	100 minutes
	SP mode, 25 Mb/s CBR	140 minutes
	SD mode	

* When recording in HQ (35 Mbps) mode, actual recording times may vary according to the bit rate adopted during VBR encoding.

Multiple-format Recording: 1080/720 and Interlace/Progressive Switchable Operation

XDCAM EX products offer a wide array of recording formats for multiple content-creation applications. Recording mode is switchable between 1920 x 1080, 1280 x 720, and 1440 x 1080 resolutions. The scanning system is also selectable from interlace and progressive, such as 59.94i, 50i, 59.94p, and 50p.

In addition, XDCAM EX camcorders* offer native 23.98p progressive recording in 1920x1080 and 1280x720 modes, while the XDCAM EX deck** offers 23.98p in 1920x1080 mode.

The PMW-EX30 supports the Record function in 29.97p/25p/23.98p mode and the EE/PB function in 29.97PsF/25PsF/23.98PsF mode through HD-SDI input/output.** XDCAM EX camcorders do not support a PB function, but do support an EE function in 23.98PsF mode. An SxS memory card can simultaneously hold a mix of multiple files in any of these recording formats, including DVCAM files – a new capability of PMW-350 and PMW-EX1R camcorders only – allowing flexible memory card use.***

* Images are handled on XDCAM EX camcorders as 23.98p, and recorded as 59.94i signals via 2-3 pull-down in 1440x1080/23.98p (SP) mode.

** An early version of the PMW-EX30 requires upgrade to achieve these capabilities. Please contact your local Sony service representative for further details.

*** Memory card with material recorded by PMW-350 or PMW-EX1R camcorders in HQ 1440x1080 or DVCAM mode cannot be read by current PMW-EX1, PMW-EX3 camcorders and PMW-EX30 deck.

High-quality Uncompressed Audio Recording

XDCAM EX products support high-quality, two-channel, 16-bit, 48-kHz linear PCM uncompressed audio. In addition, the PMW-350 camcorder records four-channel audio and, when this is replayed from the memory card by other XDCAM EX products, the user must select from CH-1/2 or CH-3/4.

High Reliability Memory

SxS memory cards resists considerable shock (1500 G) and vibration (15 G). Adopting this memory recording system, the unit's mechanism is simplified. Also, a unique Salvage function serves to restore content that is damaged by power loss or memory disconnection during recording.*

* In some cases, images recorded just before an accident may not be restored (four seconds maximum). No warranty is given on always achieving content restoration.

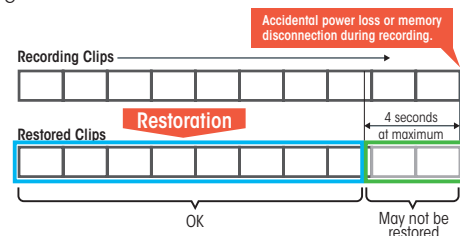

IT Friendly

With XDCAM EX products, recordings are made as data files in ISO-standardized MP4 format. File-based recording allows material to be handled with great flexibility in an IT-based environment for copying, transferring, sharing, and archiving. These operations are accomplished without loss, and without any re-digitizing process.

The recording system also allows for material to be viewed directly on a Macintosh or PC – the user simply inserts the SxS memory card into a computer's ExpressCard slot and uses the supplied Clip Browser Version 2.6 and compatible nonlinear editing software, to view, edit, and search metadata. This helps to improve workflow efficiency.

Acquisition Metadata (HD mode only)

As part of a variety of metadata such as shooting Date/Time, OK status, Title, Shooter name, Description and Essence Mark, XDCAM EX camcorders have a unique capability of recording camera parameters onto the recording media while shooting - such as Focus, Zoom, Iris, Shutter, Gain, White Balance and Gamma. Clip Browser V2.6 allows to review these acquisition metadata in viewing clips, which is useful as a reference for editing process or next shooting.

	Mode	Sampling	Resolution	PMW-350 / PMW-EX1R		PMW-EX1 / PMW-EX3		PMW-EX30	
				NTSC area	PAL area	NTSC area	PAL area	NTSC area	PAL area
HD	HQ 35 Mbps (VBR)	4:2:0	1920x1080	59.94i, 29.97p 23.98p	50i, 25p	59.94i, 29.97p 23.98p	50i, 25p	59.94i, 29.97p 23.98p	50i, 25p
			1440x1080	59.94i, 29.97p 23.98p	50i, 25p	-	-	-	-
			1280x720	59.94p, 29.97p 23.98p	50p, 25p	59.94p, 29.97p 23.98p	50p, 25p	59.94p	50p
SD*	DVCAM 25 Mbps (CBR)	4:1:1 4:2:0	720x480	59.94i, 23.98p (Pull Down)	50i	59.94i, 23.98p (Pull Down)	50i	59.94i	50i
			720x576	-	50i, 25PsF	-	-	-	-

* The PMW-350 requires an optional hardware key, CBK-DV01.

XDCAM EX Camcorder PMW-350



Only PMW-350K comes with lens.
Shotgun microphone and windscreen are supplied accessories.
Battery and wireless microphone unit shown in picture are optional accessories.

The first Sony memory shoulder-mount camcorder with 2/3-inch imagers
The PMW-350, a new addition to the XDCAM EX family, is the first and long-awaited shoulder-mount camcorder in this Sony range. It comes equipped with cutting-edge imaging technology: three 2/3-inch-type Exmor full-HD CMOS sensors, which give stunningly high-quality images with high sensitivity and a high signal-to-noise ratio. The PMW-350 inherits a rich variety of features for creative shooting from the successful camcorders that precede it - the PMW-EX1 and PMW-EX3.

Sony and the Environment

The PMW-350 is designed to be environmentally friendly thanks to its low power consumption, which is around 60% less than conventional HD camcorders from Sony*.
This energy-saving design means that the camcorder emits less CO₂ when in use.

* Based on a comparison with the HDW-700 full-HD shoulder camcorder from Sony with a 2/3-inch image sensor.

Impressive Body Design

Designed to be very compact and ergonomically well balanced, the PMW-350 provides a high level of mobility and comfort in various shooting situations. It inherits these qualities from the XDCAM HD 422 camcorders, which are well accepted by broadcasters and post production houses. In addition, it has a low center of gravity, ensuring outstanding stability on the shoulder. The low-profile design provides a wide space between the main frame of the camera and the handle, and an unobstructed view to the right-hand side of the camera operator. The main body weighs only 3.2 kg (7 lb 1 oz), and it is one of the lightest shoulder-mount camcorders with three 2/3-inch full-HD imagers.

Three 2/3-inch-type Exmor Full-HD CMOS Sensors

The PMW-350 is equipped with three newly developed 2/3-inch-type Exmor CMOS sensors, each with an effective pixel count of 1920 (H) x 1080 (V). These deliver superior picture performance with full-HD resolution. This 2/3-inch-type image sensor allows the camcorder to provide an excellent sensitivity of F12, a remarkable signal-to-noise ratio of 59 dB, and a high horizontal resolution of 1000 TV lines.* In addition, the large 2/3-inch-type image sensors can capture images with a shallower depth of field, giving users more freedom of creative expression.

*In HD-SDI, HQ 1080 mode.



Low Power Consumption

There is no fan motor to ventilate the inside of the body, and power consumption is only 15W*.

*Camcorder body only, in recording mode.

Lens Package Choice

There are two different models of the PMW-350. One is the PMW-350K, which comes equipped with an HD lens with 16x zoom. The other is the PMW-350L, which comes without a lens. Both models have a standard 2/3-inch bayonet lens mount, and the user can choose from a wide variety of optional lenses in the existing 2/3-inch HD lens lineup.

Unique Focus Operation – Professional Manual Focus and Auto Focus

The supplied lens for the PMW-350K adopts a unique focus ring mechanism, which offers two types of manual focus, plus auto focus operation. The lens is equipped with two independent focus wheel mechanisms, which can be switched by sliding the focus ring forward and back. When the focus ring is in the forward position, the lens works in the same way as a typical auto focus lens. The operator can select either Manual or Auto Focus mode using the AF/MF switch on the lens. When the focus ring is in the back position, the lens has an absolute focus position, which is a familiar feature to professional users.



Front : AF/MF



Back : Full MF

AF/MF Mode

- Full AF
- One-push AF
- MF
- AF/MF Assist

Full MF Mode

- Full MF (absolute focus position)

AF Assist

The AF (Auto Focus) Assist function of the PMW-350K enables operators to manually change focus positions using the focus ring in AF mode. This means that AF reference focus positions can be shifted manually to a new position.

MF Assist

The MF (Manual Focus) Assist function of the PMW-350K helps to precisely focus on the target subject when shooting in MF mode. When MF Assist is enabled, the auto focus is momentarily activated when the user stops adjusting the focus ring. The camera then finely focuses on the subject that's closest to the focal point of the lens at that time.

Focus Magnification

At the touch of an assignable button, the center of the screen on the PMW-350 viewfinder can be magnified to about twice its size, making it easier to confirm focus settings during manual focusing. When the switch is released, the center of the screen goes back to normal size.

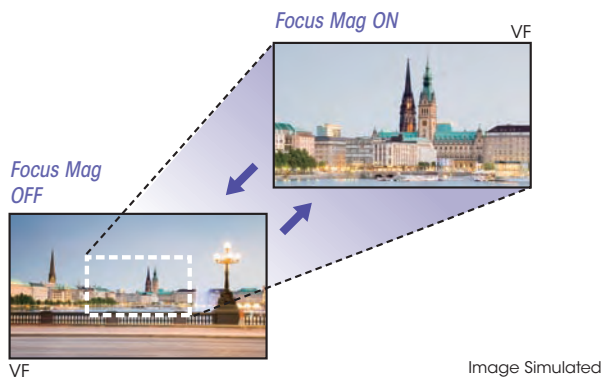

Selectable Peaking

The Peaking function of the PMW-350 can help operators to quickly and accurately adjust the camera's focus by altering the way pictures are displayed on the viewfinder. It can enhance the outline of images that the camera focuses on most, and can change the color so that it stands out. The operator can choose from various Peaking settings for the required levels and outline colors.

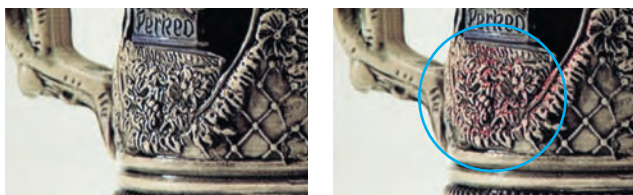

ALAC (Automatic Lens Aberration Compensation)

This feature decreases any chromatic aberration caused by the lens.* ALAC is activated only with the supplied lens and with certain third-party lenses that incorporate compensation data.*

*Please check with lens manufacturers for other ALAC supported lens.

Optical ND Filters and Electrical CC Filters

The PMW-350 camcorder comes equipped with optical ND (Neutral Density) filters and electrical CC (Color Correction) filters. The optical ND filters are controlled via a built-in ND filter wheel -- Clear, 1/4ND, 1/16ND, and 1/64ND. And with the electrical CC filters, users can easily obtain the desired color temperature by setting the mode -- 3200K/4300K/5600K/6300K -- on a camcorder-assignable switch. Users can select the four values cyclically, or choose one preset value. This is also available via an assignable switch. This is useful when a sudden change occurs during shooting, and a quick and direct setting is required.

23.98p Native Recording

CINEALTA

Like other XDCAM EX camcorders, the PMW-350 offers a native 23.98p* recording capability. This feature, accompanied by other creative features, makes the camcorder ideal for cinema production.

*In 1440 x 1080/23.98p (SP) mode, images are handled as 23.98p and recorded as 59.94i signals via 2-3 pull-down.

Slow & Quick Motion Function

The PMW-350 offers a powerful Slow & Quick Motion function -- commonly known as over-cranking and under-cranking by filmmakers -- that enables users to create unique looks with slow- and fast-motion special effects. The PMW-350 can capture images at frame rates selectable from 1 fps (frame per second) to 60 fps in 720p mode and from 1 fps to 30 fps in 1080p mode, in increments of 1 fps. For example, when viewed at 23.98p, images captured at 60 fps appear two and a half times slower than normal. Conversely, images captured at 4 fps appear six times faster than normal.

With this Slow & Quick Motion function, images are recorded natively with no padded frames and at full resolution. The obtained quality of slow- and fast-motion images is significantly higher than those created in the editing process. In addition, these slow- and quick-motion images can be played back immediately after shooting, without using any converters or processing on nonlinear editing systems.

Example of slow motion mechanism

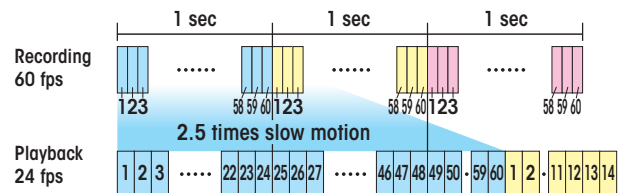

Slow Shutter Function

To capture clear images in low-light environments, the PMW-350 offers a Slow Shutter function. This not only increases camera sensitivity but also, for enhanced shooting creativity, produces a special blurring effect when shooting a moving object. The shutter speed is selectable from 2, 3, 4, 5, 6, 7, 8, 16, 32, and 64-frame accumulation periods.

Selectable Gamma Curves

The PMW-350 offers a wide variety of gamma curves to flexibly handle contrast, and give a specific look to an image. In addition to six types of standard gamma curves, there are four types of Hyper Gamma which are identical to those on high-end CineAlta™ camcorders. Operators can select the suitable preset gamma curve, depending on scene requirements.

Interval Recording Function

The Interval Recording function of XDCAM EX camcorders intermittently records one frame at pre-determined intervals. This is convenient for shooting over long periods of time, and also when creating special effects with extremely rapid motion.

Frame Recording Function

Frame Recording is a unique feature of XDCAM EX camcorder that is especially useful for clay animation shooting. Using this function, images for pre-determined frames are recorded every time the record button is pressed.

Shutter Angle Settings

In addition to traditional electronic shutter speed controls, adjustable in fractions of a second, XDCAM EX camcorders offer shutter angle control, which is familiar to filmmakers.

ATW (Auto Tracing White Balance) & Hold

The Auto Tracing White Balance function of XDCAM EX camcorders automatically adjusts the camera's color temperature according to changes in lighting conditions. This function is useful when recording outside for long periods, and the lighting changes gradually over time. With PMW-350 and PMW-EX1R, the user can hold auto tracing at a desired color balance via an assignable switch.

Image Inverter

With a DOF (Depth of Field) adaptor to attach a cinema or still-camera lens to PMW-350 or PMW-EX1R camcorders, the image is rotated 180 degrees. The Image Inverter function normalizes the image by reverse scanning.

Turbo Gain

The Turbo Gain function can boost the camera gain up to +42 dB, which helps reproduce images in very low-light environments.

1440 x 1080 35Mbps Recording

PMW-350 and PMW-EX1R offer 1440 x 1080 35Mbps (VBR) HQ mode recording at 59.94i, 50i, 29.97p, 25p, 23.98p.

DVCAM Recording and Playback with Optional Hardware Key, CBK-DV01

DVCAM format recording and playback are supported by the CBK-DV01, an optional hardware key that can be installed by the user.



Picture Cache Recording

With the PMW-350 Picture Cache Recording function, up to 15 seconds of audio and video signals are buffered into the camcorder's internal memory even before the record start button is pressed. This means that everything that happens 15 seconds prior to the record start button being pressed is recorded onto SxS memory card, helping to prevent the loss of any unexpected, yet important, events. The caching period can be adjusted by menu setting.

Four-channel Audio*

The PMW-350 is the first XDCAM EX camcorder to record four channels of 16-bit, 48-kHz, linear PCM uncompressed audio. Each channel level can be controlled by an independent individual level controller.

*When an SxS memory card with four-channel audio is replayed by the PMW-EX1, PMW-EX1R, PMW-EX3, or PMW-EX30, only CH-1/2 or CH-3/4 can be replayed.

Total Level Control System (TLCS)

For all XDCAM EX camcorders, by activating TLCS, the correct exposure is automatically set for normal, dark, and very bright shooting environments by controlling the lens iris, electronic shutter, and Auto Gain Control.

Scene File System

The Scene File feature of the PMW-350 allows camera operators to easily call up customized picture-tonal settings – such as the parameters of matrix, detail, gamma, and knee – to suit particular shooting conditions, rather than having to readjust the camera each time. This gives users greater operational efficiency. SxS memory cards can be used for storing and loading scene files.

Viewfinder with 3.5-inch* Color LCD

The PMW-350 is equipped with a large, easy-to-view, color LCD with a high resolution of 1920 x 480 pixels, which simplifies focusing. The viewfinder can also be used to instantly review recorded footage, as well as access the camera's set-up menus, view thumbnails, and display status indications.

When the elbow block is opened up, the screen can be monitored directly, and menu setting and thumbnails are easily accessed using switches on the inside panel. The PMW-350 also has an interface for the DXF-20W and DXF-51.**

*Viewable area measured diagonally.

**The supplied viewfinder and DXF viewfinder cannot be used concurrently.



Wide Choice of Optional Microphones

Although the PMW-350 is equipped with a shotgun microphone, three optional microphones – the ECM-680S, ECM-678/9X and ECM-673/9X – are also available. As with the supplied microphone, the ECM-680S can operate in either Stereo or Monaural (Uni-directional) mode. These modes can be selected from the switch on the microphone or from the PMW-350 itself.

The camcorder is also equipped with a slot to accommodate a DWR-S01D* digital wireless microphone receiver, which provides two-channel audio with stable and secure transmission that tolerates interference waves. The WRR-855 Series microphone receiver can also be used in this slot.

*The digital wireless microphone system is not available in countries where prohibited by radio law.

Assignable Buttons for Quick Access to Desired Functions

Frequently used functions can be programmed to six assignable buttons on the PMW-350, allowing operators to make rapid changes when working in the field. The color temperature button and lens RET button also can be utilized as additional assignable buttons.

HDMI

The PMW-350 is equipped with an HDMI connector for monitoring video output with a consumer display or professional monitor with an HDMI input.

Camera Remote Control

A Sony 8-pin remote interface is supplied with the PMW-350. Various camera settings can be remotely controlled using an optional RM-B150 RM-B750, RCP-750, RCP-751, RCP-920, or RCP-921 Remote Control Unit via its 8-pin remote connector.* Composite output is always available for monitoring purposes, regardless of HD/SD output selection.

*Some controls on the remote control unit are not supported by the PMW-350.

Selectable Shoulder Pad

The position of the shoulder pad can be adjusted – either forward or backward – to provide users with optimum weight balance. This is particularly useful when the camera is docked with any type of lens or camera adaptor. In addition, no tools are required for this adjustment. For those who prefer a soft shoulder pad, there is the optional CBK-SP01.



Camcorder View



Top View

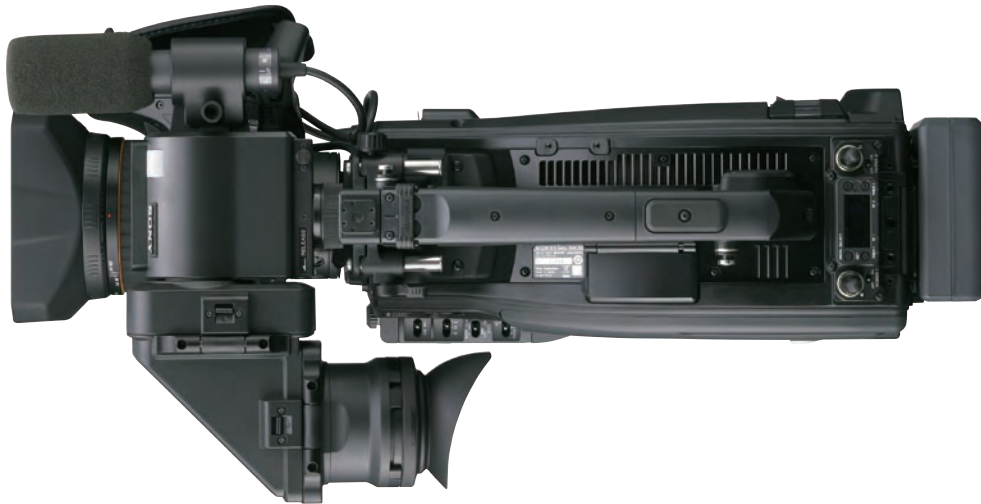

Connector Panel



Side



Rear

Camcorder System Diagrams

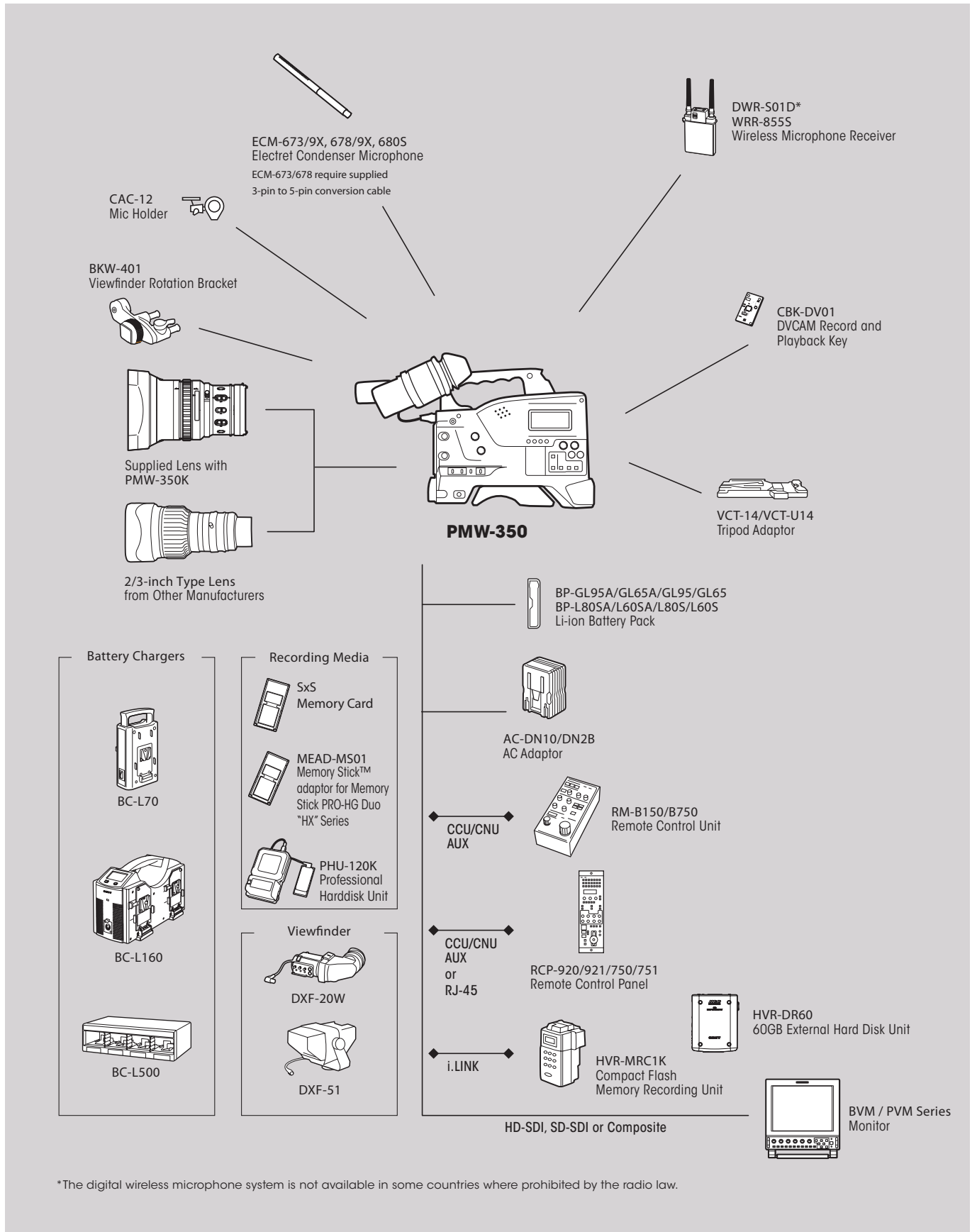

*The digital wireless microphone system is not available in some countries where prohibited by the radio law.

XDCAM EX Camcorders

PMW-EX3

PMW-EX1R



PMW-EX3



PMW-EX1R

The shotgun microphone is an optional accessory.

The XDCAM EX Series offers two camcorders equipped with three 1/2-inch-type Exmor full-HD CMOS Sensors. One is the PMW-EX1R, successor to the PMW-EX1 model, a handheld camcorder with a fixed zoom lens. The other is the PMW-EX3, a compact camcorder with an interchangeable lens system.

Cutting-edge Camera Technology

Three 1/2-inch-type Exmor Full-HD CMOS Sensors

The PMW-EX1R and PMW-EX3 are equipped with three 1/2-inch-type Exmor CMOS sensors, each with an effective pixel count of 1920 (H) x 1080 (V). This technology delivers superior picture performance with full-HD resolution. Furthermore, this type of sensor allows the camcorder to provide an excellent sensitivity of F10, a remarkable signal-to-noise ratio of 54 dB, and a high horizontal resolution of 1,000 TV lines.*

Other benefits include greatly reduced power consumption and associated heat dissipation in the PMW-EX1R and PMW-EX3, qualities which make possible the unique use of 1/2-inch-type sensors on these compact camcorders. In addition, this type of sensor can capture images with a shallower depth of field, giving users more freedom of creative expression.

*In HD-SDI, HQ 1080 mode.

Exmor
FULL HD 3CMOS

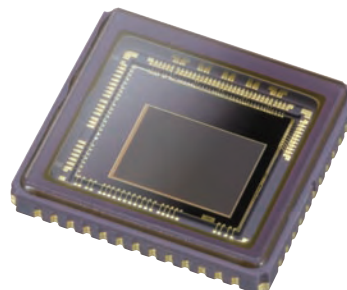

Unique Lens Operation

Supplied Wide-angle Fujinon 14x Zoom Lens

Both camcorders are equipped with a high-quality, high-definition Fujinon 14x zoom lens specifically designed to offer optimum picture performance and unprecedented functionality.

The lens offers a wide viewing angle of 5.8 mm (equivalent to 31.4 mm on a 35-mm lens), and many convenient features for diverse shooting situations.

Unique Focus Ring Mechanism - Professional Manual Focus and Auto Focus

The lens adopts a unique focus ring mechanism, which offers two types of manual focus, plus auto focus operation. The lens is equipped with two independent focus wheel mechanisms, which can be switched by sliding the focus ring forward and back.

When the focus ring is in the forward position, the lens works as an auto focus lens. Either Manual or Auto Focus mode can be selected using the AF/MF switch on the lens. When the focus ring is set to the back position, the lens has an absolute focus position.

In addition to the focus ring, the lens is equipped with independent rings for zoom and iris adjustment; all have physical stops and absolute markings, permitting precise adjustments. The location, rotational range, and feel are identical to other manual high-end HD lenses. This gives users a high level of familiarity and operational comfort.



AF/MF Mode

- Full AF
- One-push AF
- MF
- AF/MF Assist

Back : Full MF

- Full MF (absolute focus position)

AF Assist

The AF (Auto Focus) Assist function of the PMW-EX1R and PMW-EX3 enables operators to manually change focus positions using the focus ring in AF mode. This means that AF reference focus positions can be shifted manually to a new position.

MF Assist

The MF (Manual Focus) Assist function of the PMW-EX1R and PMW-EX3 helps to precisely focus on the target subject when shooting in MF mode. When MF Assist is enabled, auto focus is momentarily activated when the user stops adjusting the focus ring. The camera then finely focuses on the subject that is closest to the focal point of the lens at that time.

One-push Auto Iris (PMW-EX1R Only)

A One-push Auto Iris button has been added to the lens of the PMW-EX1R, allowing the user to go into Auto Iris mode only when this button is pushed.



Interchangeable Lens System (PMW-EX3 Only)

The PMW-EX3 camcorder incorporates a 1/2-inch-type EX-mount interchangeable lens system that allows the lens to be as compact and lightweight as possible while maintaining high optical performance. This mount system supports a variety of 1/2-inch-type HD lenses available from major manufacturers with the PMW-EX3 camcorder via the supplied lens adaptor, expanding the spectrum of creative expression.*

A 2/3-inch-type lens** can also be used with the PMW-EX3 camcorder via the mount system; this requires a 2/3-inch-type lens adaptor*** equipped with a 12-pin lens connector. This illustrates the range of lens choice, including cinema-style lenses, to suit every specific shooting requirement.

*The 1/2-inch-type lens adaptor supplied with the PMW-EX3 camcorder is equipped with a hot-shoe lens mount connector only. Automatic lens iris control is achieved only if the lens has hot-shoe connectors. Some lens functions are not supported by the PMW-EX3. For more details, please contact each lens manufacturer.

**In this configuration, the resulting focal length will be 1.37 times the actual focal length of the lens.

***When using 2/3-inch-type lenses with the PMW-EX3 camcorder, a Fujinon LCV-21 or Canon LCV-41E lens mount adaptor is required.



Supplied EX mount lens

1/2-inch type lens

Use supplied 1/2 inch type lens adaptor for 1/2 inch B4 mount lens with double hot shoe

Use Canon LCV-20E for 1/2 inch type B4 mount lens without double hot shoe

Optical Image Stabilizer

To minimize the blurring effect caused by a shaking hand, the lens incorporates an Optical Image Stabilizer function.

Expanded Focus

At the touch of a button, the center of the screen on the LCD monitor and viewfinder of the PMW-EX1R and PMW-EX3 can be magnified to about twice normal size, making it easier to confirm focus settings during manual focusing.

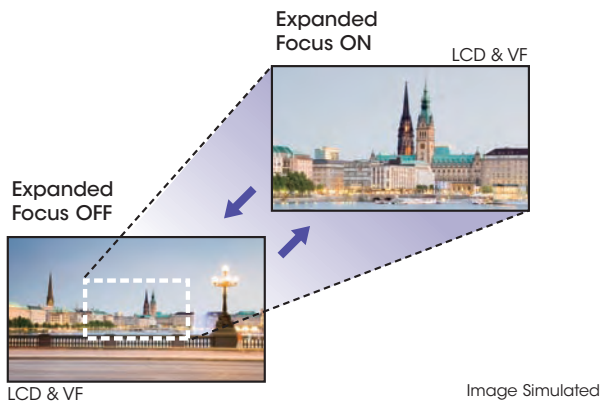

Selectable Peaking

The Peaking function of the PMW-EX1R and PMW-EX3 can help operators to quickly and accurately adjust the camera's focus by altering the way pictures are displayed on the LCD monitor and viewfinder. It can enhance the outline of the image which the camera focuses on most, and change its color to make it stand out. This function offers three enhancement levels and four outline colors.



Peaking OFF

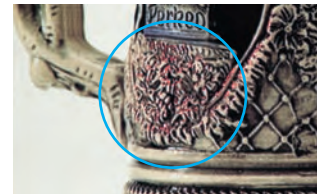

Peaking ON

Creative Recording Modes and Settings

23.98p Native Recording



The compact PMW-EX1R and PMW-EX3 offer a native 23.98p* recording capability. This feature, accompanied by other creative features, makes these camcorders ideal for cinema production.

*In 1440 x 1080/23.98p (SP) mode, images are handled as 23.98p and recorded as 59.94i signals via 2-3 pull-down.

Slow & Quick Motion Function

The PMW-EX1R and PMW-EX3 offer a powerful Slow & Quick Motion function – commonly known by filmmakers as over-cranking and under-cranking – that enables users to create unique looks as well as slow- and fast-motion special effects.

The PMW-EX1R and PMW-EX3 can capture images at frame rates selectable from 1 fps (frame per second) to 60 fps in 720p mode, and from 1 fps to 30 fps in 1080p mode, in increments of 1 fps.

For example, when viewed at 23.98p, images captured at 60 fps appear two and a half times slower than normal. Conversely, images captured at 4 fps appear six times faster than normal.

With this Slow & Quick Motion function, images are recorded natively and at full resolution. The captured quality of slow- and fast-motion images is significantly higher than those created in the editing process.

Example of slow motion mechanism

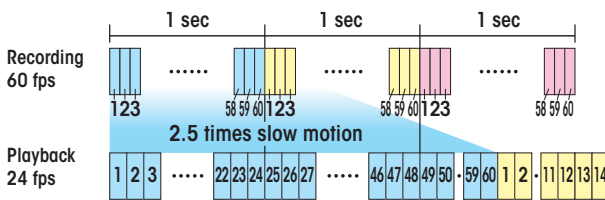

One-push S&Q Switch (PMW-EX1R Only)

For the PMW-EX1R, a new S&Q (Slow & Quick Motion) button has been added to the inside panel. It allows the user to switch quickly between Normal mode and S&Q mode. In S&Q mode, a blue LED on the button lights up. When the switch is pressed, S&Q mode is activated, and the recording format and frame rate are instantly changed to the conditions previously set via the menu.



Slow Shutter Function

The PMW-EX1R and PMW-EX3 offer a Slow Shutter function for capturing clear images in low-light environments. The Slow Shutter function not only increases camera sensitivity but also produces a special blurring effect when shooting a moving object, for enhanced shooting creativity. The shutter speed is selectable from 2, 3, 4, 5, 6, 7, 8, 16, 32, and 64-frame accumulation periods.

Interval Recording Function

XDCAM EX camcorders offer an Interval Recording function that records one frame at pre-determined intervals. This is convenient for shooting over long periods of time, and also when creating special effects with extremely rapid motion.

Frame Recording Function

Frame Recording is a unique feature of XDCAM EX Camcorders that is especially useful for clay animation shooting. Using this function, images for pre-determined frames are recorded every time the record button is pressed.

Shutter Angle Settings

In addition to electronic shutter speed controls, adjustable in fractions of a second, all XDCAM EX camcorders offer shutter angle control which is familiar to filmmakers.

By setting the shutter adjustment mode to "angle", the XDCAM EX camcorders automatically set the proper exposure time, based on the selected frame rate and shutter angle.

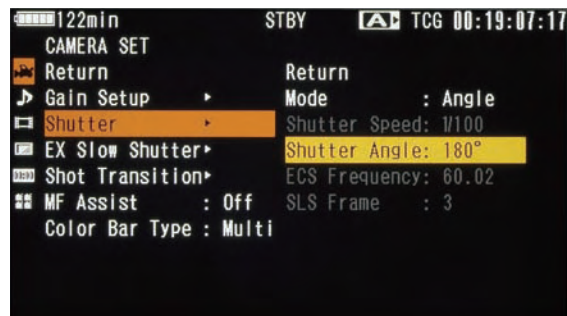

Operational Versatility

DVCAM Recording (PMW-EX1R Only)

A newly added feature in the PMW-EX1R – SD recording in DVCAM mode – offers those currently using SD systems a smooth migration path to HD production. By introducing the PMW-EX1R as a DVCAM acquisition camcorder, the conventional ingesting process to non-linear systems becomes dramatically more efficient. Once a non-linear system is HD-capable, the PMW-EX1R can continue to be deployed for HD acquisition.



Picture Profile™ Feature

The Picture Profile feature of the PMW-EX1R and PMW-EX3 allows camera operators to easily call up customized picture-tonal settings to suit particular shooting conditions, rather than having to readjust the camera each time, giving users greater operational efficiency. Up to six different pictures – tonal settings such as the parameters of matrix, color correction, detail, one of eight gamma curves, and knee – can be saved to an SxS memory card. These settings are displayed on the LCD monitor at the touch of a button.

Shot Transition™ Function

The Shot Transition function of the PMW-EX1R and PMW-EX3, with a simple push of a button, enables smooth, precise, and repeatable automatic scene transitions. The operator can program the duration and select from three transition profiles: Linear, Soft Stop, and Soft Transition.

Many lens parameters such as the start and end settings for zoom, focus, and/or camera parameters such as white balance and gain can be programmed to transition in unison. It works by automatically calculating the intermediate values during scene transition.

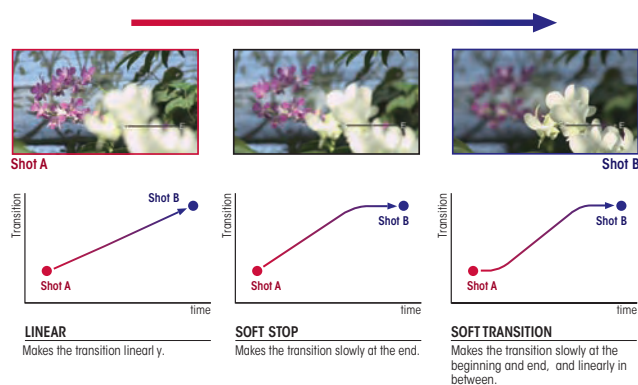

ATW & Hold (PMW-EX1R Only)

The ATW (Auto Tracing White Balance) function of the PMW-EX1R and PMW-EX3 automatically adjusts the camera's color temperature according to changes in the lighting conditions. This function is useful when recording outside for long periods, and the lighting changes gradually over time. The PMW-EX1R also has an ATW Hold function, which allows the operator to hold auto tracing at a desired color balance via an assignable switch.

Cache Recording Function (PMW-EX1R Only)

A Cache Recording function is newly added in the PMW-EX1R. Audio and video signals are buffered to the camcorder's internal memory before the record button is pressed. Once the record button is pushed, the cached portion is recorded onto memory media. This portion is added in front of the clip.

The caching period can be adjusted by menu setting up to 15 seconds. When in Cache Recording mode, an indicator on the camera panel lights up.



Image Inversion Function (PMW-EX1R Only)

When the cinema lens or still-camera lens is attached to the camera with a DOF (Depth of Field) adaptor, the image is rotated 180 degrees. Image Inversion is the function that normalizes the image.

IR Remote Control On Rear (PMW-EX1R Only)

The PMW-EX1R has a newly added IR remote control receptor on the rear of its handle. This allows the user to control the PMW-EX1R with a Remote Commander® unit both from the front and rear of the camcorder.

Additional Aspect Markers For Cinema Operation (PMW-EX1R Only)

Several new aspect markers such as 1.66:1, 1.85:1, 2.35:1, and 2.4:1 are added for more convenient cinema operation.

Operational Versatility

Camera Remote Control (PMW-EX3 Only)

The PMW-EX3 camcorder comes equipped with a remote control interface. Various camera settings can be remotely controlled using an optional RM-B150 or RM-B750 Remote Control Unit via its 8-pin remote connector.*

*Some controls on the RM-B150 and RM-B750 are not supported by the PMW-EX3. See a Sony Authorized XL Reseller for details.

Adjustable Shoulder Pad and Cheek Pad (PMW-EX3 Only)

The position of the PMW-EX3 camcorder's shoulder pad can be selected from two positions. In addition, the PMW-EX3 is supplied with a detachable cheek pad. Operators can always attain a comfortable and well-balanced camera position, even when the camcorder is docked with long lenses.



HDMI Output (PMW-EX1R Only)

The standard HDMI connector (Type A) allows the user to show the picture on a consumer display or professional monitor equipped with an HDMI input. Non-compressed video and two channels of audio can be output. When HDMI output is selected, the other output is not available.

HD-SDI and Other Versatile Interfaces

The PMW-EX1R and PMW-EX3 come equipped with a wide range of interfaces optimized for a variety of operational needs, wide interoperability, and flexible workflow. These include an HD-SDI output and, in E-to-E mode, 10 bits of 4:2:2 signal can be output from the connector. For versatile usage, there is also a down-converted SD-SDI output, i.LINK (HDV/DVCAM),* and analog composite/component output. Additionally, the PMW-EX3 camcorder is equipped with a timecode input/output and genlock input, allowing the camcorder to be used in a multi-camera system.

*PMW-EX1R supports i.LINK (HDV/DVCAM). PMW-EX1/PMW-EX3 support i.LINK (HDV) only.

Other Features

- Built-in ND filter wheel: OFF: Clear, 1: 1/8ND, 2: 1/64ND
- Selectable gain: -3, 0, 3, 6, 9, 12, 18 dB
- High-speed picture search: x4, x15
- Freeze Mix function
- Skin-tone detail control
- Low-key saturation

A 3.5-inch* Color LCD

Both of these camcorders are equipped with a large, easy-to-view, color LCD with a high resolution of 1920 x 480 pixels. This screen can be flexibly rotated for accessible viewing from any shooting angle. The ease of focusing offered by this high-resolution panel, and its location and adjustability, enables it to be used as a viewfinder or camera assistant operator panel. It can also be used to instantly review recorded footage, as well as access the camera's set-up menus, view thumbnails, and display status indications.



*Viewable area measured diagonally.

B Four Assignable Buttons

Frequently used functions can be programmed to four assignable buttons on the PMW-EX1R and PMW-EX3, allowing operators to make rapid changes when working in the field.



C 0.45-inch* Color LCD Viewfinder (PMW-EX1R Only)

The PMW-EX1R comes equipped with a new color LCD viewfinder, which displays high-resolution color pictures of approximately 1,226,000 pixels in a wide-screen aspect ratio of 16:9, which simplifies focusing. Operators can switch between Color and Monochrome Display modes, according to their preference.

*Viewable area measured diagonally.



D On-handle Zoom Switch and Record Start/Stop Button

To facilitate zoom control and recording operation during low-angle shooting, an additional zoom switch and record start/stop button are located on the carrying handle of the PMW-EX1R and PMW-EX3. In addition, the PMW-EX1R has a new zoom transition menu which ensures smooth transitions – the user simply selects "Soft" to enable the on-handle zoom to start and stop more smoothly.



E Rotary Grip

The hand grip of the PMW-EX1R and PMW-EX3 can rotate approximately 120 degrees, which allows camera operators to flexibly adjust the angle of the grip. This gives users greater control and comfort when holding the camera in any shooting position. The grip for the PMW-EX1R has a new, enhanced shape that better fits the user's hand.



F Built-in Stereo Microphone and Two-channel Audio Input

Both camcorders have a built-in stereo microphone and two XLR audio input connectors for connecting professional microphones or feeding an external-line audio source. These allow high-quality, two-channel 16-bit, 48-kHz linear PCM uncompressed audio to be recorded.



NIPROS/1 for the PMW-EX3 XDCAM EX Camcorder

According to Nippon Video System Co. Ltd., the NIPROS/1 kit makes the Sony PMW-EX3 a full HD XDCAM EX camcorder at home in the field or in the studio.

The PMW-EX3 camcorder and NIPROS/1 kit are available from Sony, providing a comprehensive studio solution for small to mid-sized production facilities.

For broadcast quality remote control capability, Sony recommends adding an RM-B150 or RM-B750 remote controller to your NIPROS/1 configuration.

Broadcast quality remote controllers



Function	Operation on the PMW-EX3 camcorder	Operation on the RM-B150	Operation on the RM-B750
Menu ON/OFF	MENU button	Yes	Yes
Master gain selection	GAIN switch	Yes	
Gain adjustment	CAMERA SET menu → gain setup	Yes	
Step gain selection			Yes
Color bar signal output ON/OFF	CAM/BAR button	Yes	Yes
Shutter ON/OFF	SHUTTER switch + CAMERA SET menu → shutter	Yes	Yes
Shutter speed selection	CAMERA SET menu → shutter	Yes	Yes
ECS ON/OFF	SHUTTER switch + CAMERA SET menu → shutter	Yes	Yes
ECS frequency selection	CAMERA SET menu → shutter	Yes	Yes
Auto white balance	AUTO W BAL button	Yes	Yes
Auto black balance	CAMERA SET menu → Auto BLK balance	Yes	Yes
White R/B level adjustments		Yes	Yes
Black R/B level adjustments		Yes	Yes
White balance memory selection	WHITE BAL switch	Yes	Yes
Auto tracing white ON/OFF	Assignable button (with "ATW" assigned)	Yes	Yes
Recording start/stop	REC START/STOP button	Yes	Yes
Rec review	REC REVIEW button	Yes	Yes
Rec review stop	STOP button	Yes	Yes
Call signal ON/OFF			Yes
Picture Profile item			
Matrix	Setting		Yes
	Level		Yes
Detail	R-G, R-B, G-R, G-B, B-R, B-G		Yes
	Setting		Yes
	Level	Yes	Yes
	Frequency		Yes
	Crispning		Yes
	H/V Ratio		Yes
	White Limiter		Yes
	Black Limiter		Yes
	Knee APT Level		Yes
	Skin Tone Detail	Setting	Yes
Level		Yes	Yes
Area Indication			Yes
Saturation			Yes
Phase			Yes
Width			Yes
Knee	Setting		Yes
	Auto Knee	Yes	Yes
	Point	Yes	Yes
	Slope	Yes	Yes
	Knee SAT Level	Yes	Yes
Gamma	Level	Yes	Yes
	Select		Yes
Black		Yes	Yes
Black Gamma			Yes
Low Key SAT			Yes

Camcorder System Diagrams

Unless specified as "supplied", all the components below are optional.

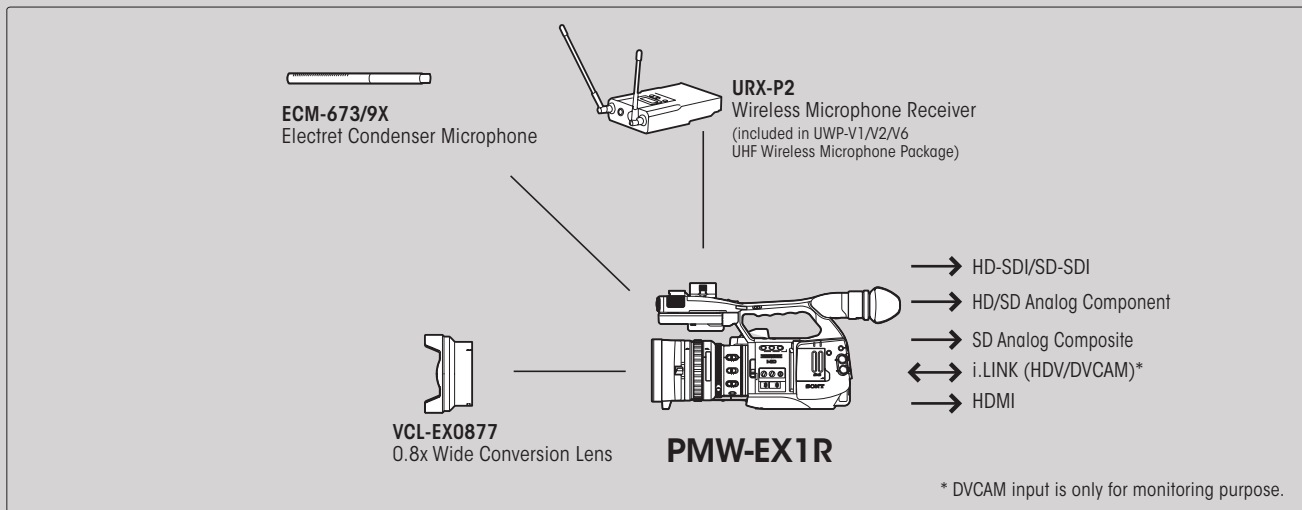
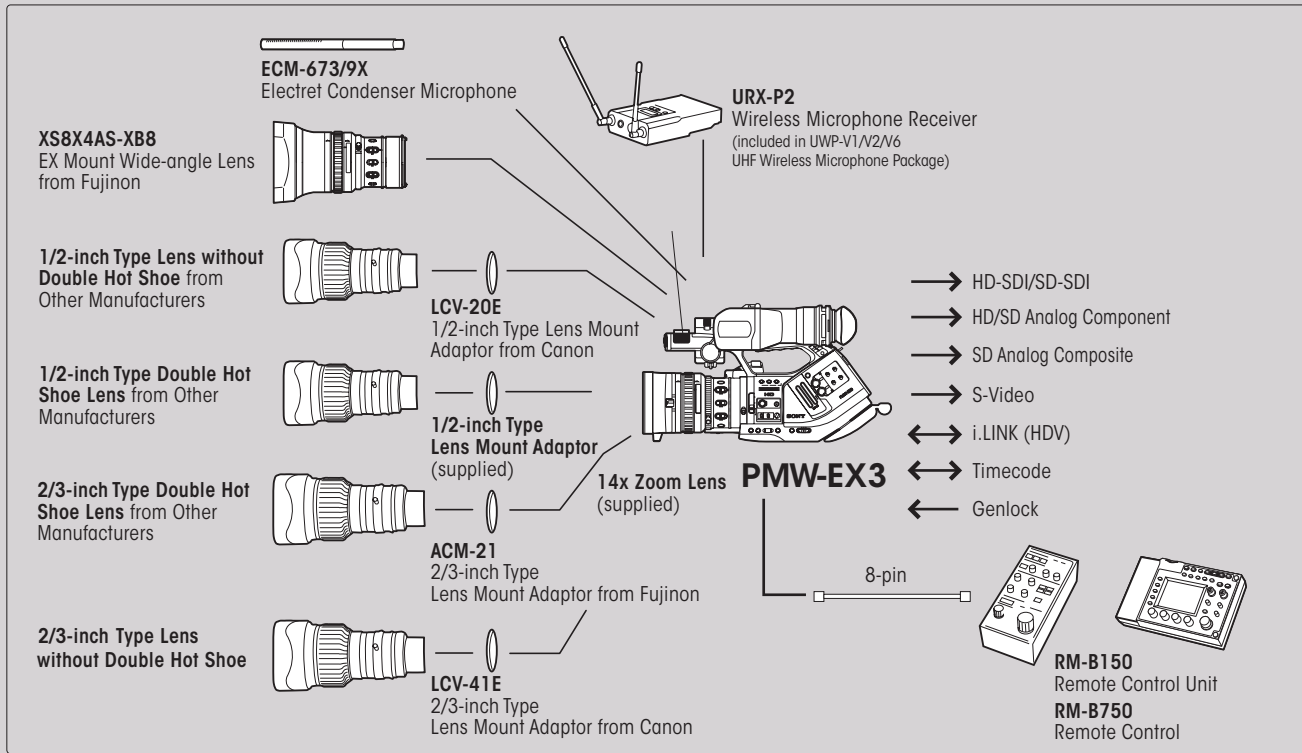

Battery Charger

BC-U1
Battery Charger/
AC Adaptor (supplied)

BC-U2
Battery Charger/
AC Adaptor

Battery

BP-U30
Lithium-ion Battery Pack
(supplied)

BP-U60
Lithium-ion Battery Pack

Remote Commander® Unit

Remote Commander Unit
(supplied)

Recording Media

SxS Memory Card

MEAD-MS01

PHU-120K
Professional Harddisk Unit

Memory Stick™ Adapter
with Memory Stick PRO-HG Duo
"HX" Series

XDCAM EX Recording Deck PMW-EX30



Image Simulated

The PMW-EX30 is a highly versatile and affordable compact recording deck that can be used for many different applications. It allows simple viewing of recorded materials on a monitor, as well as dubbing to other formats and media, such as HDV, XDCAM HD, and HDCAM™, and feeding to nonlinear editing systems. In addition, the PMW-EX30 can be used as an affordable full-HD recorder for event recordings – it can record HD signal outputs from a switcher. The PMW-EX30 deck offers a wide array of interfaces including HD-SDI input and output, HDMI output, HD analog component, composite outputs, and more. Equipped with two SxS PRO* memory card slots, the PMW-EX30 can record up to 280 minutes of HD footage using two 32-GB SxS PRO memory cards.**

*PMW-EX30 will support the SxS-1 memory card and MEAD-MS01 after a firmware upgrade at Sony Service Centers. Planned availability is Spring 2010.

**In SP mode.

Features

- Highly compact design – the deck can be placed either horizontally or vertically
- MPEG HD recording and playback at 35 and 25 Mbps
- Equipped with two SxS memory card slots*
- Built-in 3.5-inch* LCD monitor
*Viewable area measured diagonally.
- Comprehensive range of HD interfaces: HD-SDI input/output, i.LINK (HDV) input/output, and component output
- Supports recording and playback in 29.97p/25p/23.98p mode, and 29.97PsF/25PsF/23.98PsF signal handling via HD-SDI input/output*
- Down-converted SD outputs for migration to SD environments: SD-SDI, i.LINK (DVCAM), component, S-Video, and composite

- HDMI output for digital connection to a range of consumer displays
- Adjustable audio input volume (CH1 and CH2)

Recording Format

	NTSC setting	PAL setting
1920 x 1080 (HQ mode)	59.94i, 29.97p*, 23.98p*	50i, 25p*
1280 x 720 (HQ mode)	59.94p	50p
1440 x 1080 (SP mode)	59.94i	50i

*Early versions of the PMW-EX30 require an upgrade to achieve these capabilities. Please contact your local Sony service representative for further details.

Please note that the operator will receive an Unknown Media alarm when using a SxS PRO memory card that previously stored PMW-EX1R or PMW-350 camcorder recordings in DVCAM mode or HQ 1440 x 1080 mode.



Examples of how to use the stands



Rear

XDCAM EX Application Software

XDCAM EX products come with two application software packages for powerful yet easy and intuitive management of recorded content. Included are two versions (Macintosh and PC) of Clip Browser as well as XDCAM Transfer application software for Apple Final Cut Pro nonlinear editing systems.



Clip Browser Version 2.6

Newly added features include detection and correction of the so called "flash band" that may appear if XDCAM EX footage was captured in an environment where lights were flashing.

Features

- Browse video clips recorded by XDCAM EX products, including those in newly added formats, such as in HQ 1440 x 1080 mode, four-channel audio, and DVCAM mode
- Copy XDCAM EX clip files from SxS memory card to other devices such as hard disk drives
- Combine segmented clips recorded across two SxS memory cards
- Display Acquisition Metadata recorded in MP4 files
- Detect and correct for Flash Bands
- Convert file formats from MP4 to other file formats, such as MXF format*, DV format, AAF format, H.264/AVC format (for field viewing on Sony PSP™, Apple iPod™ and Apple iPhone™ devices), and WMV format*
- Create sub clips with Mark IN/OUT operation
- Register metadata for clips, such as "title", "creator", and "comments"
- Register shot mark metadata for instant cue-up to desired scenes
- Capture and create still-image files (BMP files) for desired scenes

*Requires optional plug-in software from MainConcept AG (<http://www.mainconcept.com/plugin4clipbrowser>)



System Requirements

MS Windows OS:
Windows XP™ SP3 or later (32-bit version)
Windows Vista™ XP SP1 or later (32-bit version, 64-bit version)
Windows 7 (32-bit version, 64-bit version)

CPU:
Intel Pentium™ 4 2.0-GHz (minimum)
Intel Core 2 Duo Processor 2.0-GHz or higher (recommended)

RAM:
1 GB (minimum), 2 GB or more (recommended)

Macintosh OS:
Macintosh OS X 10.4.11 or later
Macintosh OS X 10.5.1 or later
Macintosh OS X 10.6 or later

CPU
Intel Core 2 Duo™ Processor 2.0-GHz (minimum), Intel Core 2 Duo Processor 2.4-GHz, or higher (recommended)

RAM
1 GB (minimum), 2 GB or more (recommended)



Clip Browser GUI (Windows)



Clip Browser GUI (Macintosh)

PDZK-P1* Ver. 2.11 XDCAM Transfer for Apple Final Cut Pro™

The PDZK-P1 XDCAM Transfer is plug-in software for Apple Final Cut Pro nonlinear editing systems that provides support for MP4 files recorded by XDCAM EX products. With this software installed on a Macintosh computer, XDCAM EX products or SxS memory cards can be mounted directly onto Mac Finder, and users can seamlessly import and edit recorded material.

*The latest version of this software can be downloaded from Sony websites. Please contact your nearest Sony authorized dealer for further information.

PDZK-P1 does not support DVCAM (AVI) files recorded with PMW-EX1R or PMW-350 camcorders.

Without using PDZK-P1, those files can be imported by drag & drop operation from Finder to Browser window of Final Cut Pro.



System requirements

OS
Macintosh OS X 10.4.11 or later
Macintosh OS X 10.5.8 or later

CPU
PowerPC G5 2-GHz, or higher
Intel Core 2 Duo 2-GHz, or higher
Intel Xeon 2-GHz, or higher

RAM
1 GB or more

Optional Accessories

PXU-MS240 Mobile Storage Unit PXU-HC240 HDD Cartridge

The PXU-MS240 is a hard disk drive (HDD)-based high-capacity storage device enabling reliable and fast off-loading of SxS content, while in the field, without the need for a computer. (as it relates to PXU products, change PC to computer universally since it works with both PC & Macs). Capacity can be added by replacing the removable PXU-HC240 HDD cartridge. As well as USB 2.0, the unit supports the very high-speed eSATA interface effective for data transfer to, or direct editing with, a computer.

High-capacity Storage

The user simply attaches the supplied HDD cartridge to the PXU-MS240 slot. This cartridge offers a large 240-GB capacity, storing approximately 800 minutes in HQ mode and 1,040 minutes in SP mode.



High-speed Data Backup of SxS Memory Card

Data on SxS memory cards can be fully backed up simply by inserting a card in the PXU-MS240 slot and pressing the copy button.

The maximum transfer speed from an SxS memory card to an HDD cartridge is approximately 600 Mbps, and it takes approximately ten minutes to copy 32 GB of data. Since data verification occurs during copying, an SxS memory card can be wiped for re-use after Data off-load/backup.

Versatile Interfaces

To review PXU-MS240 clips on any XDCAM EX camcorder's LCD, simply use the supplied PHU cable to connect the PXU-MS240 USB terminal to the camcorder's SxS memory card slot*1.

For fast data transfer, connect the PXU-MS240 to a PC via a third-party eSATA cable. It takes approximately 60 minutes to transfer up to 240 GB of data, and this function can also be achieved using a USB 2.0 connection with a slightly longer transfer time. Additionally, an HDD cartridge can be connected directly to a computer via the USB 2.0, even in a stand-alone configuration.*2



*1: Please note that it is not possible to record directly from an XDCAM EX camcorder to the PXU-MS240 or PXU-HC240.

*2: The HDD cartridge requires an AC adaptor when used without the PXU-MS240.

Shock-resistant Mechanism

When the three-axis acceleration sensor detects a sudden movement in the PXU-MS240, the HDD head is retracted. This helps to minimize damage to the drive. Additionally, the cartridge is equipped with a newly designed shock absorber to protect the hard disk drive from drop impact.*

* This feature cannot guarantee proper functioning and trouble-free operation.

OLED Display

The OLED display ensures a high level of visibility even for outside use. It indicates mode of operation, battery level, remaining HDD capacity, and copy status.*

* Clip review and thumbnail indication are not available.

Two-way Powering

For outdoor operation, the PXU-MS240 uses a BP-U30 battery – the same battery used in PMW-EX1R and PMW-EX3 camcorders. An AC adaptor is also supplied.

Workflow Example

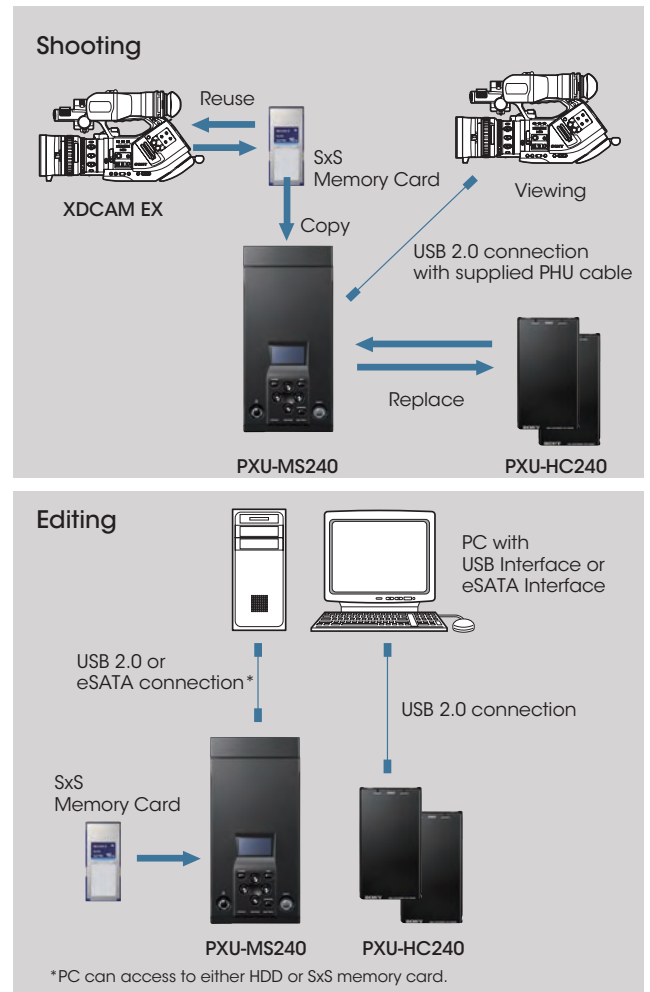

PHU-120R Professional Hard Drive Recording Unit

The PHU-120R* is an external storage unit for XDCAM EX products. It allows XDCAM EX clips to be recorded on its large-capacity 120-GB hard disk drive for up to approximately 400 minutes in HQ mode and 520 minutes in SP mode.** Offering long recording times at an affordable price, the unit is easily connected to XDCAM EX products using the supplied cable, and can be attached to XDCAM EX camcorders using the supplied shoe adaptor.

*The PHU-120R does not support slow-motion recording.

**When using with the PMW-EX1, PMW-EX3, or PMW-EX30, the mechanical switch of PHU-120R needs to be set to one of two 60GB partitions.



MEAD-MS01 Memory Stick Adaptor

The MEAD-MS01 is an adaptor which enables the use of high-speed Memory Stick™* as XDCAM EX emergency recording media.

Using 8, 16, or 32-GB media, approximately 35, 70, or 140 minutes of recording (in SP mode) can be achieved.**

*The Memory Stick PRO-HG Duo "HX" Series, MS-HX8G (8-GB), MS-HX16G (16-GB), and MS-HX32G (32-GB) are recommended. Please contact your local Sony office for the latest compatibility information.

**Slow Motion and Salvage functions are not supported.



SBAC-US10 SxS Memory Card USB Reader/Writer

The SBAC-US10 is an SxS PRO memory card reader/writer* that works with both MS Windows-based PCs and Macintosh computers via a USB 2.0 interface. This compact and portable device comes in handy in many situations such as on location, and for desktop browsing and full-fledged editing.

*The SBAC-US10 does not support MEAD-MS01.



BC-U2 Battery Charger

The BC-U2 is a battery charger for BP-U30/U60 that can charge two batteries simultaneously. It can supply power to PMW-EX1R or PMW-EX3 while the battery is recharging.



VCT-SP2BP Camcorder Support (for PMW-EX1R & PMW-EX3)

Using the VCT-SP2BP, the handheld PMW-EX1R and PMW-EX3 can be held steady for long periods of time. This device provides three-point support: at the handle, shoulder, and chest. It can also be mounted on a tripod with a camcorder.



Optional Accessories for PMW-350

SBP-32/16
SxS PRO Memory Card



SBS-32G1
SxS-1 Memory Card



MEAD-MS01
Memory Stick Adaptor



MS-HX8G, HX16G, HX32G
Memory Stick PRO-HG Duo "HX" Series



PHU-120R
Professional Harddisk Unit



PXU-MS240
Mobile Storage Unit



PXU-HC240
HDD Cartridge



HVR-MRC1K
Memory Recording Unit



HVR-DR60
Hard Disk Recording Unit



SBAC-US10
SxS Memory Card USB Reader/Writer



BP-GL95A/GL65A/GL95 GL65
Lithium-ion Battery Pack



Photo Shows BP-GL95/GL65

BP-L80S/L60S
Lithium-ion Battery Pack



Photo Shows BP-L80S

AC-DN10/DN2B
AC Adaptor



Photo Shows AC-DN10

BC-L500/L160/L70
Battery Charger



Photo Shows BC-L500

RM-B150
Remote Control Unit



RM-B750
Remote Control Unit



RCP-750/751/920/921
Remote Control Unit



Photo Shows RCP-920

ECM-680S
Shotgun-type Electret Condenser Microphone



Photo Shows ECM-678. Requires 3-pin to 5-pin conversion cable

ECM-673/9X, 678/9X
Shotgun-type Electret Condenser Microphone



WRR-855S
Wireless Microphone Receiver



DWR-S01D*
Wireless Microphone Receiver



CBK-DV01
SD Recording and Playback Key

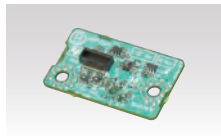

CBK-SP01
Shoulder Pad



VCT-14/VCT-U14
Tripod Adaptor



DXF-20W
2.0-inch Monochrome Viewfinder



DXF-51
5-inch Monochrome Viewfinder



BKW-401
Viewfinder Rotation Bracket



CAC-12
Mic Holder



* The digital wireless microphone system is not available in some countries where prohibited by the radio law.

Optional Accessories for PMW-EX3/EX1R

<p>SBP-32/16 SxS PRO Memory Card</p> 	<p>SBS-32G1 SxS-1 Memory Card</p> 	<p>MEAD-MS01 Memory Stick Adaptor</p> 	<p>MS-HX8G, HX16G, HX32G Memory Stick PRO-HG Duo "HX" Series</p> 	<p>PHU-120R Professional Harddisk Unit</p> 
<p>PXU-MS240 Mobile Storage Unit</p> 	<p>PXU-HC240 HDD Cartridge</p> 	<p>HVR-MRC1K Memory Recording Unit</p> 	<p>BP-U30 Lithium-ion Battery Pack (28 Wh)</p> 	<p>BP-U60 Lithium-ion Battery Pack (56 Wh)</p> 
<p>BC-U1 Battery Charger (for BP-U30/U60)</p> 	<p>BC-U2 Battery Charger</p> 	<p>VCL-EX0877 0.8x Wide Conversion Lens (for PMW-EX1, PMW-EX1R)</p> 	<p>NIPROS/1 Studio Configuration kit for PMW-EX3</p> 	<p>RM-B150 Remote Control Unit (for PMW-EX3)</p> 
<p>RM-B750 Remote Control Unit (for PMW-EX3)</p> 	<p>ECM-680S Shotgun-type Electret Condenser Microphone</p> 	<p>ECM-673/9X Shotgun-type Electret Condenser Microphone</p> 	<p>URX-P2 UHF Diversity Tuner</p> 	<p>UWP-V1 UHF Wireless Microphone Package</p> 
<p>UWP-V2 UHF Wireless Microphone Package</p> 	<p>UWP-V6 UHF Wireless Microphone Package</p> 	<p>VCTSP2BP (available Jan 2010) Camcorder Support</p> 	<p>Requires 5-pin to 3-pin x2 conversion cable</p>	

1/2-inch Type HD Lenses From Other Manufacturers

Canon
KH20x6.4 KRS*



Canon
KH13x4.5 KRS*



Canon
KH16e x5.7



Canon
KH10e x3.6



Canon
KH21e x5.6



* Requires the lens mount adaptor supplied with the PMW-EX3 camcorder to attach these lenses to the PMW-EX3. Some lens functions are not supported by the PMW-EX3 camcorder. For details of the lenses, please contact each manufacturer.

Fujinon
XS17x5.5BRM/BRD*



Fujinon
XS13x3.3BRM/BRD*



Fujinon
XS8X4AS-XB8
(EX Mount Wide-angle Lens)



VCL-719BXS/B
19x Focus Servo Lens
(for PMW-EX3)



Other Lens Accessories for PMW-EX3

Fujinon
ACM-21 (for 2/3 inch lenses)

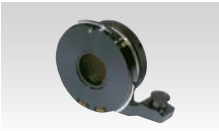

Canon
LCV-41E (for 2/3 inch lenses)



Canon
LCV-21E (for 1/2 inch lenses)



Workflow Examples

Ingest

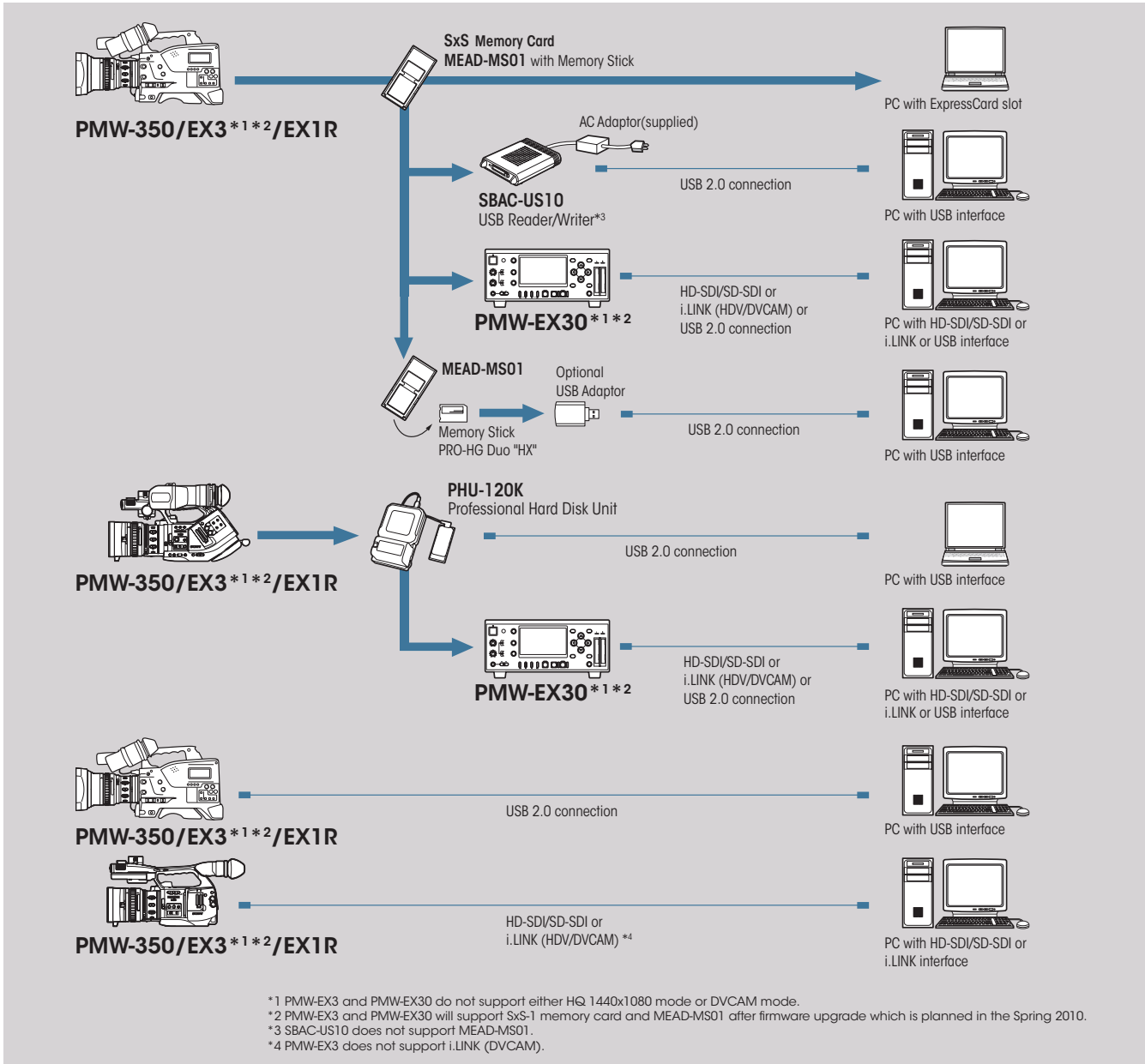

Viewing and Dubbing

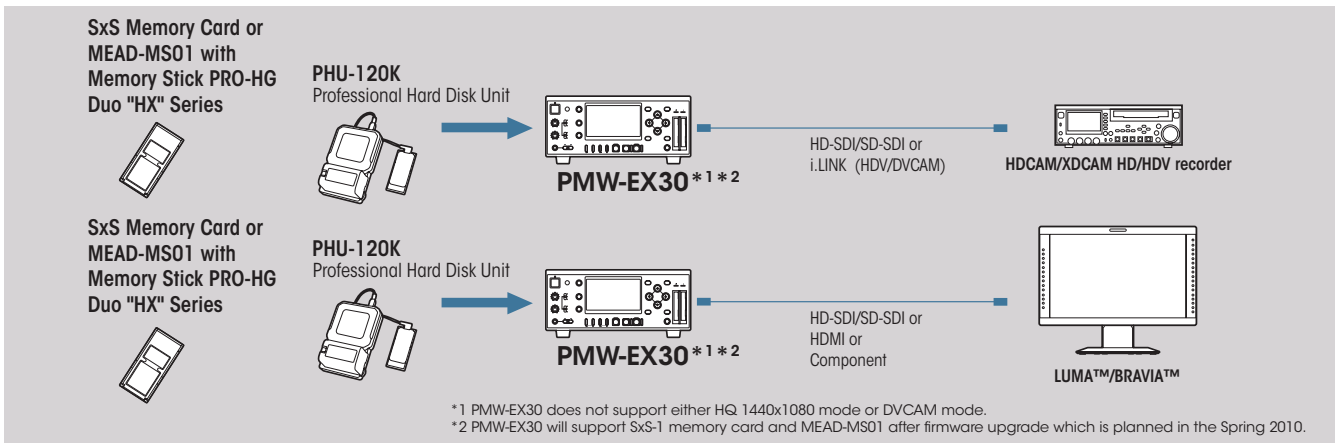

Archiving

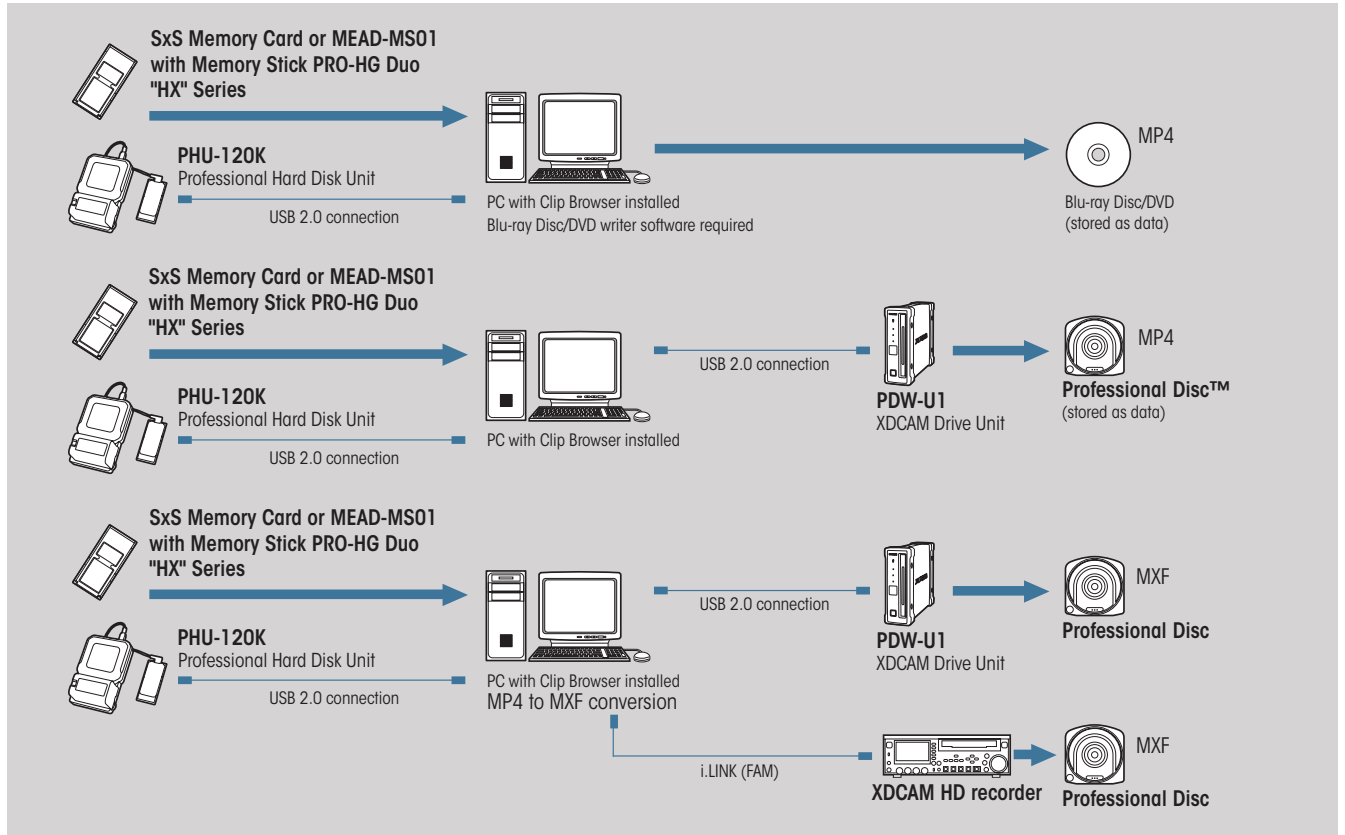

Live Event

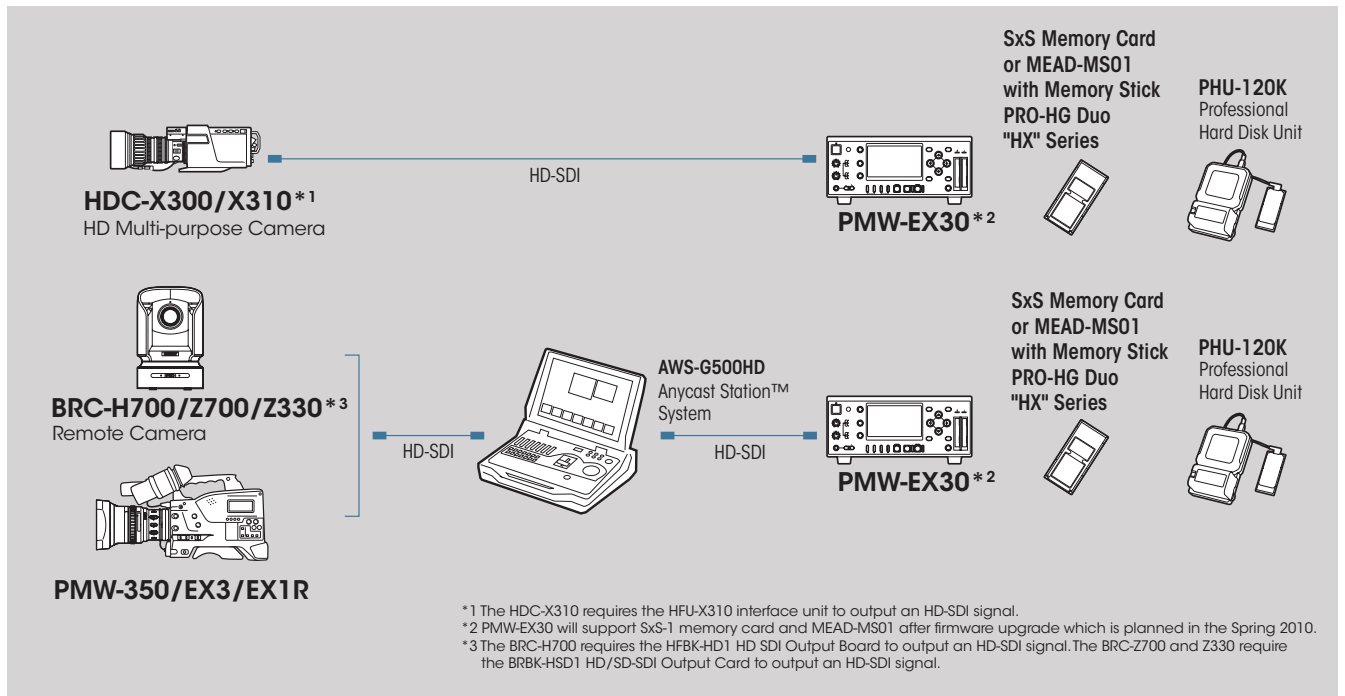

XDCAM EX Camcorder Specifications

	PMW-EX1R	PMW-EX3*	PMW-350L, PMW-350K*
General			
Weight	5 lb 4 oz (2.4 kg) (body) 6 lb 2 oz (2.8 kg) (with lens hood, large eye cup, BP-U30 battery, one SxS PRO memory card)	4 lb 2 oz (1.9 kg) (without lens) 7 lb 9 oz (3.6 kg) (with lens, lens hood, eye piece, BP-U30 battery, one SxS PRO memory card)	7 lb 1 oz (3.2 kg) (body) 13 lb 14 oz (6.3 kg) (with LCD VF, AF lens, Mic, BP-GL95A)
Dimension (W x H x D)	7 1/8 x 7 7/8 x 12 1/4 inches (179 x 199 x 308 mm) without projection	9 7/8 x 8 3/8 x 16 3/4 inches (250 x 210 x 425 mm) without projection	5 x 10 5/8 x 13 1/8 inches (124 x 269 x 332 mm) without projection
Power requirements	DC 12 V		
Power consumption	Approx. 12.5 W (while recording, EVF On, LCD monitor Off)	Approx. 13.5 W (while recording, LCD viewfinder On)	Approx. 18 W (with LCD VF, AF lens, mic, while recording) Approx. 15 W (body while recording)
Operating temperature	+32 °F to +104 °F (0 °C to +40 °C)		
Storage temperature	-4 °F to +140 °F (-20 °C to +60 °C)		
Battery operating time	Approx. 240 min with BP-U60 battery Approx. 120 min with BP-U30 battery	Approx. 210 min with BP-U60 battery Approx. 100 min with BP-U30 battery	Approx. 310 min with BP-GL95A battery
Recording format	Video: MPEG-2 Long GOP HD HQ mode: VBR, maximum bit rate: 35 Mb/s, MPEG-2 MP@HL HD SP mode: CBR, 25 Mb/s, MPEG-2 MP@H-14 SD mode: DVCAM Audio: Linear PCM (2ch, 16-bit, 48-kHz)	Video: MPEG-2 Long GOP HQ mode: VBR, maximum bit rate: 35 Mb/s, MPEG-2 MP@HL SP mode: CBR, 25 Mb/s, MPEG-2 MP@H-14 Audio: Linear PCM (2ch, 16-bit, 48-kHz)	Video: MPEG-2 Long GOP HQ mode: VBR, maximum bit rate: 35 Mb/s, MPEG-2 MP@HL SP mode: CBR, 25 Mb/s, MPEG-2 MP@H-14 SD mode (Option): DVCAM Audio: HD mode: Linear PCM (4ch, 16-bit, 48-kHz) SD mode (Option): Linear PCM (2ch, 16-bit, 48-kHz)
Recording frame rate	NTSC area: HD HQ mode: 1920 x 1080/59.94i, 29.97p, 23.98p, 1440 x 1080/59.94i, 29.97p, 23.98p, 1280 x 720/59.94p, 29.97p, 23.98p HD SP mode: 1440 x 1080/59.94i, 23.98p (pull down) SD mode: 720 x 480/59.94i, 29.97PsF PAL area: HD HQ mode: 1920 x 1080/50i, 25p, 1440 x 1080/50i, 25p, 1280 x 720/50p, 25p HD SP mode: 1440 x 1080/50i SD mode: 720 x 576/50i, 25PsF	NTSC area: HD HQ mode: 1920 x 1080/59.94i, 29.97p, 23.98p, 1280 x 720/59.94p, 29.97p, 23.98p HD SP mode: 1440 x 1080/59.94i, 23.98p (pull down) PAL area: HD HQ mode: 1920 x 1080/50i, 25p, 1280 x 720/50p, 25p HD SP mode: 1440 x 1080/50i	NTSC area: HD HQ mode: 1920 x 1080/59.94i, 29.97p, 23.98p, 1440 x 1080/59.94i, 29.97p, 23.98p, 1280 x 720/59.94p, 29.97p, 23.98p HD SP mode: 1440 x 1080/59.94i, 23.98p (pull down) SD mode (Option): 720 x 480/59.94i, 29.97PsF PAL area: HD HQ mode: 1920 x 1080/50i, 25p, 1440 x 1080/50i, 25p, 1280 x 720/50p, 25p HD SP mode: 1440 x 1080/50i SD mode (Option): 720 x 576/50i, 25PsF
Recording/Playback time	HQ Mode: Approx. 100 min with SBP-32 (32 GB) memory card** Approx. 50 min with SBP-16 (16 GB) memory card Approx. 25 min with SBP-8 (8 GB) memory card SP/SD Mode: Approx. 140 min with SBP-32 (32 GB) memory card** Approx. 70 min with SBP-16 (16 GB) memory card Approx. 35 min with SBP-8 (8 GB) memory card	HQ Mode: Approx. 100 min with SBP-32 (32 GB) memory card** Approx. 50 min with SBP-16 (16 GB) memory card Approx. 25 min with SBP-8 (8 GB) memory card SP Mode: Approx. 140 min with SBP-32 (32 GB) memory card** Approx. 70 min with SBP-16 (16 GB) memory card Approx. 35 min with SBP-8 (8 GB) memory card	HQ Mode: Approx. 100 min with SBP-32 (32 GB) memory card** Approx. 50 min with SBP-16 (16 GB) memory card Approx. 25 min with SBP-8 (8 GB) memory card SP/SD Mode: (SD:Option) Approx. 140 min with SBP-32 (32 GB) memory card** Approx. 70 min with SBP-16 (16 GB) memory card Approx. 35 min with SBP-8 (8 GB) memory card
Lens			
Lens mount	–	1/2-inch type EX mount	2/3-type SONY bayonet
Zoom ratio	14x (optical), servo/manual		16x (optical), servo/manual (AF lens for PMW-350K)
Focal length	f = 5.8 mm to 81.2 mm (equivalent to 31.4 mm to 439 mm on 35 mm lens)		f = 8 mm to 128 mm (equivalent to 31.5 mm to 503 mm on 35 mm lens)
Iris	F1.9 to F16 and Close, auto/manual selectable		
Focus	AF/MF/Full MF selectable, 800 mm to ∞ (MACRO OFF), 50 mm to ∞ (MACRO ON, Wide), 735 mm to ∞ (MACRO ON, Tele)		AF/MF/Full MF selectable, 800 mm to ∞ (MACRO OFF), 50 mm to ∞ (MACRO ON)
Image stabilizer	ON/OFF selectable, shift lens		
Filter diameter	M77 mm, pitch 0.75 mm (on lens)		M82 mm, pitch 0.75 mm (on lens)
Camera Section			
Imaging device	3-chip 1/2-inch type "Exmor" Full HD CMOS		3-chip 2/3-inch type "Exmor" Full HD CMOS
Effective picture elements	1920 (H) x 1080 (V)		
Optical system	F1.6 prism system		F1.4 prism system
Built-in optical filters	OFF: Clear, 1: 1/8ND, 2: 1/64ND		1: Clear, 2: 1/4ND, 3: 1/16ND, 4: 1/64ND
Sensitivity (2000 lx, 89.9% reflectance)	F10 (typical) (1920 x 1080/59.94i mode)		F12 (typical) (1920 x 1080/59.94i mode), F13 (typical) (1920 x 1080/50i mode)
Minimum illumination	0.14 lx (typical) (1920 x 1080/59.94i mode, F1.9, +18 dB gain, with 64-frame accumulation)		0.006 lx (typical) (1920 x 1080/59.94i mode, F1.9, +42 dB gain, with 64-frame accumulation)
S/N ratio	54 dB (Y) (typical)		59 dB (Y) (typical)
Horizontal resolution	1,000 TV lines or more (1920 x 1080i mode)		
Shutter speed	1/60 sec to 1/2,000 sec + ECS		
Slow Shutter (SLS)	2, 3, 4, 5, 6, 7, 8, 16, 32, and 64-frame accumulation		

	PMW-EX1R	PMW-EX3*	PMW-350L, PMW-350K*
Slow & Quick Motion function		720p: Selectable from 1fps to 60 fps as recording frame rate 1080p: Selectable from 1fps to 30 fps as recording frame rate	
White balance		Preset (3,200 K), Memory A, Memory B/ATW	
Gain		-3, 0, 3, 6, 9, 12, 18 dB, AGC	-3, 0, 3, 6, 9, 12, 18, 24, 30, 36, 42 dB
Inputs/Outputs			
Audio input		XLR-type 3-pin (female) (x2), line/mic/mic +48 V selectable	
Composite output	Phono jack (x1) via A/V multi connector, NTSC or PAL	BNC (x1), NTSC or PAL	BNC (x1), NTSC or PAL, COMPONENT Y
S-Video output	-	Mini DIN 4-pin (x1)	-
Audio output	Phono jack (CH-1,CH-2) via A/V multi connector	Phono jack (CH-1,CH-2)	XLR-type 5-pin
Component output		Mini D (x1) via A/V multi connector	
SDI output		BNC (x1), HD-SDI/SD-SDI selectable	
i.LINK Interface	IEEE1394, 4-pin (x1), HDV (HDV 1080i) / DVCAM stream input/output, S400	IEEE1394, 4-pin (x1), HDV stream (HDV 1080i) input/output, S400	IEEE1394, 6-pin (x1), HDV (HDV 1080i) / DVCAM stream input/output, S400
Timecode input	-		BNC (x1)
Timecode output	-		BNC (x1)
Genlock input	-		BNC (x1)
USB		USB device, Mini-B (x1)	Device Type B (x1)
Headphone output		Stereo mini-jack (x1)	
Speaker output		Monaural	
DC input		DC jack	XLR-type 4-pin
DC output		-	4-pin
Remote	-		8-pin
Lens remote		12-pin	
MIC	-		XLR-type 5-pin
HDMI output	A Type (x1)	-	19-pin
VF	-	-	26-pin (LCD VF), 20-pin (DXF)
Wireless receiver IN	-	-	D-Sub 15-pin
Monitoring			
Viewfinder	0.45-inch*** type color LCD: 852 (H) x 480 (V), 16:9	3.5-inch*** type color LCD monitor: approx. 921,000 effective pixels, 640 (H) x 3 (RGB) x 480 (V), 16:9, hybrid type	
Built-in LCD monitor	3.5-inch** type color LCD monitor: approx. 921,000 effective pixels, 640 (H) x 3 (RGB) x 480 (V), 16:9, hybrid type	-	Black & white LCD (Audio level, TC, battery and media remaining capacity)
Built-in Microphone			
		Omni-directional stereo electret condenser microphone.	
			-
Media			
Type		ExpressCard/34 slot (x2)	
Supplied Accessories			
	Lens hood (1), Large eye cup (1), IR Remote Commander unit (1), USB cable (1), A/V connecting cable (1), Component video cable (1), Shoulder strap (1), Operation Manual (1), XDCAM EX Clip Browsing software (1), SxS device driver software (1), BP-U30 battery (1), BC-U1 charger (1), Cold Shoe Kit (1)	14x zoom lens (1), Lens hood (1), LO-3830 1/2-inch lens adaptor (1), IR Remote Commander unit (1), USB cable (1), Component video cable (1), Shoulder strap (1), Operation Manual (1), Cheek pad, XDCAM EX Clip Browsing software (1), SxS device driver software (1), BP-U30 battery (1), BC-U1 charger (1)	16x zoom lens (1), Lens hood (1) (PMW-350K only), Stereo mic (1), Windscreen (1), Shoulder belt (1), Operation Manual (1), XDCAM EX Clip Browsing software (1), SxS device driver software (1), Frage focal length adjustment test chart (1)

* The specifications are measured with supplied lens.

** When recording in HQ (35 Mbps) mode, actual recording times may vary according to the bit rate adopted during VBR encoding.

*** Viewable area measured diagonally.

XDCAM EX Deck Specifications

PMW-EX30	
General	
Weight	4 lb 6 oz (2.0 kg)
Dimensions (W x H x D)	8 3/8 x 3 1/2 x 7 7/8 inches (210 x 88 x 200 mm)
Power requirement	DC 12 V
Power consumption	Approx. 12 W
Operating temperature	32°F to 104°F (5°C to 40°C)
Storage temperature	-4°F to +140°F (-20°C to +60°C)
Recording format	Video: MPEG-2 Long GOP HQ mode: VBR, maximum bit rate: 35 Mb/s, MPEG-2 MP@HL SP mode: CBR, 25 Mb/s, MPEG-2 MP@H-14 Audio: Linear PCM (2ch, 16-bit, 48-kHz)
Playback format	MPEG HD: 1080/59.94i, 50i, 29.97p, 25p, 23.98p MPEG HD: 720/59.94p, 50p, 29.97p, 25p, 23.98p
Recording frame rate	NTSC area: HQ mode: 1920 x 1080/59.94i, 29.97p*, 23.98p*, 1280 x 720/59.94p SP mode: 1440 x 1080/59.94i PAL area: HQ mode: 1920 x 1080/50i, 25p*, 1280 x 720/50p SP mode: 1440 x 1080/50i
Recording/Playback time	HQ mode: Approx. 100 min with SBP-32 (32 GB) memory card Approx. 50 min with SBP-16 (16 GB) memory card Approx. 25 min with SBP-8 (8 GB) memory card SP mode: Approx. 140 min with SBP-32 (32 GB) memory card Approx. 70 min with SBP-16 (16 GB) memory card Approx. 35 min with SBP-8 (8 GB) memory card
Inputs/Outputs	
Composite output	BNC (x1), NTSC or PAL
S-Video output	Mini DIN 4-pin (x1)
Component output	BNC (x3)
Analog audio input	Phono jack (CH-1, CH-2)
Analog audio output	Phono jack (CH-1, CH-2)
SDI input	BNC (x1), HD only
SDI output	BNC (x1), HD/SD selectable
HDMI	Type A 19-pin (x1), output
i.LINK	IEEE 1394, 6-pin (x1), HDV stream input/output, DVCAM stream output, S400
USB	USB device, Mini-B (x1)
Headphone output	Stereo mini-jack (x1)
DC input	DC jack (12 V)
Built-in display	3.5-inch** type color LCD monitor, approx. 921,000 effective pixels, 640 (H) x 3 (RGB) x 480 (V), 16:9, hybrid type
Media	
Type	ExpressCard/34 slot (x2)
Supplied Accessories	
AC adaptor (x1), IR Remote Commander unit (x1), USB cable (x1), Stand (x2), Operation Manual (x1), XDCAM EX Clip Browsing Software (x1), SxS device driver software (x1)	

*Early PMW-EX30 requires an upgrade to achieve these capabilities.

**Viewable area measured diagonally.

©2009 Sony Electronics Inc. All rights reserved.
Reproduction in whole or in part without written permissions is prohibited.
Features, design and specifications are subject to change without notice.
PSP is a trademark of Sony Computer Entertainment, Inc.
Sony, the Sony logo, XDCAM EX, XDCAM, CineAlta, SxS PRO, SxS-1, SxS, Exmor, Picture Profile,
Shot Transition, Remote Commander, i.LINK, Professional Disc, HDCAM,
LUMA, BRAVIA, PSP and DVCAM are trademarks of Sony.
HDV and HDV logo are trademarks of Sony Corporation and
Victor Company of Japan, Limited (JVC).
Macintosh, iPod and iPhone and Final Cut Pro are trademarks of Apple Corporation.
Windows XP and Windows Vista are trademarks of Microsoft Corporation.
Core 2 Duo is a trademark of Intel Corporation.

SONY[®]

Sony Electronics Inc.
1 Sony Drive
Park Ridge, NJ 07656
www.sony.com/xdcamex

PMW-350, PMW-EX3, PMW-EX1R and PMW-EX30
are produced at Sony EMCS Kosai Tec, which
has received ISO14001 the Environmental
Management Certification.

