



USER GUIDE



IMPORTANT

Please read this manual carefully before using
your mixer for the first time.



This equipment complies
with the EMC Directive
2004/108/EC and LVD
2006/95/EC

This product is approved to
safety standards:

IEC 60065: 2001
EN60065:2002
UL60065 7th Edition: 2003
CAN/CSA-E60065-03

And EMC standards
EN55103-1: 1996 (E2)
EN55103-2: 1996 (E2)

For further details contact:

Harman International Industries Ltd.
Cranborne House, Cranborne Road
Potters Bar, Hertfordshire, EN6 3JN, UK

Tel: +44 (0) 1707 665000
Fax: +44 (0) 1707 660742
e-mail: soundcraft@harman.com

© Harman International Industries Ltd. 2009

All rights reserved

Parts of the design of this product may be protected by worldwide patents.

Part No. BD10.534000 Issue 0809

Soundcraft is a trading division of Harman International Industries Ltd. Information in this manual is subject to change without notice and does not represent a commitment on the part of the vendor. Soundcraft shall not be liable for any loss or damage whatsoever arising from the use of information or any error contained in this manual.

No part of this manual may be reproduced, stored in a retrieval system, or transmitted, in any form or by any means, electronic, electrical, mechanical, optical, chemical, including photocopying and recording, for any purpose without the express written permission of Soundcraft.



Harman International Industries Limited
Cranborne House
Cranborne Road
POTTERS BAR
Hertfordshire
EN6 3JN
UK

Tel: +44 (0)1707 665000
Fax: +44 (0)1707 660742
<http://www.soundcraft.com>

Contents

IMPORTANT SAFETY INSTRUCTIONS	4
SAFETY SYMBOL GUIDE	5
INTRODUCTION	8
THE 60-SECOND GUIDE	10
WIRING UP	12
BLOCK DIAGRAMS	16
MONO INPUT CHANNELS	18
STEREO INPUT CHANNELS	20
MASTER SECTION	22
FX PROCESSOR OVERVIEW	24
FX OPERATION	25
REVERBS	25
DELAYS	26
MODULATED EFFECTS	26
EFFECTS DATA CHART	27
USING YOUR NOTEPAD 124/124FX CONSOLE	28
MARK-UP SHEETS	30
DIMENSIONS	32
APPLICATIONS	33
TYPICAL CONNECTING LEADS	34
TYPICAL SPECIFICATIONS	36
WARRANTY	37
GLOSSARY	38

IMPORTANT SAFETY INSTRUCTIONS

Read these instructions.

Keep these instructions.

Heed all warnings.

Follow all instructions.

Do not use this apparatus near water.

Clean only with a dry cloth.

Do not block any ventilation openings. Install in accordance with the manufacturer's instructions.

Do not install near any heat sources such as radiators, heat registers, stoves, or other apparatus (including amplifiers) that produce heat.

Do not defeat the safety purpose of a polarised or grounding type plug. A polarised plug has two blades with one wider than the other. A grounding type plug has two blades and a third grounding prong. The wide blade or the third prong are provided for your safety. If the provided plug does not fit into your outlet, consult an electrician for replacement of the obsolete outlet

Protect the power cord from being walked on or pinched particularly at plugs, convenience receptacles and the point where they exit from the apparatus.

Only use attachments/accessories specified by the manufacturer.



Use only with the cart, stand, tripod, bracket or table specified by the manufacturer, or sold with the apparatus. When a cart is used, use caution when moving the cart/apparatus combination to avoid injury from tip-over.

Unplug this apparatus during lightning storms or when unused for long periods of time.

NOTE: This equipment has been tested and found to comply with the limits for a Class A digital device, pursuant to Part 15 of the FCC Rules. These limits are designed to provide reasonable protection against harmful interference when the equipment is operated in a commercial environment. This equipment generates, uses and can radiate radio frequency energy and, if not installed and used in accordance with the instruction manual, may cause harmful interference to radio communications. Operation of this equipment in a residential area is likely to cause harmful interference in which case the user will be required to correct the interference at his own expense.

This Class A digital apparatus meets the requirements of the Canadian Interference-Causing Equipment Regulations.

Cet appareil numérique de la Classe A respecte toutes les exigences du Règlement sur le matériel brouilleur du Canada.

For your own safety and to avoid invalidation of the warranty please read this section carefully.

SAFETY SYMBOL GUIDE

For your own safety and to avoid invalidation of the warranty all text marked with these symbols should be read carefully.

WARNINGS



The lightning flash with arrowhead symbol, is intended to alert the user to the presence of un-insulated 'dangerous voltage' within the product's enclosure that may be of sufficient magnitude to constitute a risk of electric shock to persons.

CAUTIONS



The exclamation point within an equilateral triangle is intended to alert the user to the presence of important operating and maintenance (servicing) instructions in the literature accompanying the appliance.



NOTES

Contain important information and useful tips on the operation of your equipment.



HEADPHONES SAFETY WARNING

Contain important information and useful tips on headphone outputs and monitoring levels.

Recommended Headphone Impedance \geq 32 Ohms.

Refer all servicing to qualified service personnel. Servicing is required when the apparatus has been damaged in any way, such as power-supply cord or plug is damaged, liquid has been spilled or objects fallen into the apparatus, the apparatus has been exposed to rain or moisture, does not operate normally, or has been dropped.

Note: It is recommended that all maintenance and service on the product should be carried out by Soundcraft or its authorised agents. Soundcraft cannot accept any liability whatsoever for any loss or damage caused by service, maintenance or repair by unauthorised personnel.

WARNING: To reduce the risk of fire or electric shock, do not expose this apparatus to rain or moisture.

Do not expose the apparatus to dripping or splashing and do not place objects filled with liquids, such as vases, on the apparatus.

No naked flame sources, such as lighted candles, should be placed on the apparatus.

Batteries (battery pack or batteries installed) should not be exposed to excessive heat such as sunshine, fire or the like.

Ventilation should not be impeded by covering the ventilation openings with items such as newspapers, table cloths, curtains etc.

The Soundcraft Notepad mixer must only be connected through the AC power adaptor supplied, which must have one of the following part numbers:

Notepad AC Adaptor UK	C089.202100
Notepad AC Adaptor EU	C089.202101
Notepad AC Adaptor US	C089.202102
Notepad AC Adaptor JP	C089.202103
Notepad AC Adaptor AZ	C089.202104

The mains supply disconnect device is the mains plug. It must remain accessible so as to be readily operable when the apparatus is in use.

If any part of the mains cord set is damaged, the complete cord set should be replaced. The following information is for reference only.

The wires in the mains lead are coloured in accordance with the following code:

Earth (Ground):	Green and Yellow (US - Green/Yellow)
Neutral:	Blue (US - White)
Live (Hot):	Brown (US - Black)

As the colours of the wires in the mains lead may not correspond with the coloured markings identifying the terminals in your plug, proceed as follows:



The wire which is coloured Green and Yellow must be connected to the terminal in the plug which is marked with the letter E or by the earth symbol.

The wire which is coloured Blue must be connected to the terminal in the plug which is marked with the letter N

The wire which is coloured Brown must be connected to the terminal in the plug which is marked with the letter L

Ensure that these colour codes are followed carefully in the event of the plug being changed.

This unit is capable of operating over a range of mains voltages as marked on power supply unit.

INTRODUCTION

Thank you for purchasing a Soundcraft Notepad mixer. The Notepad range is a compact mixing solution, bringing you all the features and performance that you expect from a Soundcraft product, at an extraordinarily low price.

The packaging in which your Notepad arrived forms part of the product and should be retained for future use.

Owning a Soundcraft console brings you the expertise and support of one of the industry's leading manufacturers, and the results of over 3 decades of supporting some of the biggest names in the business. Our knowledge has been attained through working in close contact with leading professionals and institutes to bring you products designed to get the best possible results from your mixing.

Built to the highest standards using quality components and surface mount technology, the Notepad is designed to be as easy to use as possible. We have spent years researching the most efficient methods of control for two key reasons:

1) Engineers, musicians, writers and programmers all need to have very few interruptions to the creative process; our products have been designed to be almost transparent, allowing this process to breathe.

2) Whether performing or recording, time is a very expensive and rare commodity. Our products have a user interface which is recognised by millions to be the industry standard because of its efficiency.

The sonic qualities of our products are exemplary - some of the same circuits which are used on our most expensive consoles used on International tours are employed in the Notepad, bringing you the great Soundcraft quality in a small format console without compromise.

You will also be glad to know you have a one year warranty with your product from the date of purchase. The Notepad has been designed using the latest high-end software based engineering packages. Every console from Soundcraft has been proven to stand up to all the stress and rigours of modern day mixing environments.

The entire Notepad is manufactured using some of the most advanced techniques in the world, from high density surface mount PCB technology, to computer aided test equipment able to measure signals well outside the range of normal hearing.

ADVICE FOR THOSE WHO PUSH THE BOUNDARIES

Although your new console will not output any sound until you feed it signals, it has the capability to produce sounds which when monitored through an amplifier or headphones can damage hearing over time.



Please take care when working with your audio - if you are manipulating controls which you don't understand (which we all do when we are learning), make sure your monitors are turned down. Remember that your ears are the most important tool of your trade, look after them, and they will look after you. Most importantly - don't be afraid to experiment to find out how each parameter affects the sound - this will extend your creativity and help you to get the best from your mixer and the most respect from your artists and audience.

THE 60-SECOND GUIDE (NOTEPAD 124FX shown)

To get you working as fast as possible, this manual begins with a 60-second guide. Here you can find quick information on any feature of the console.

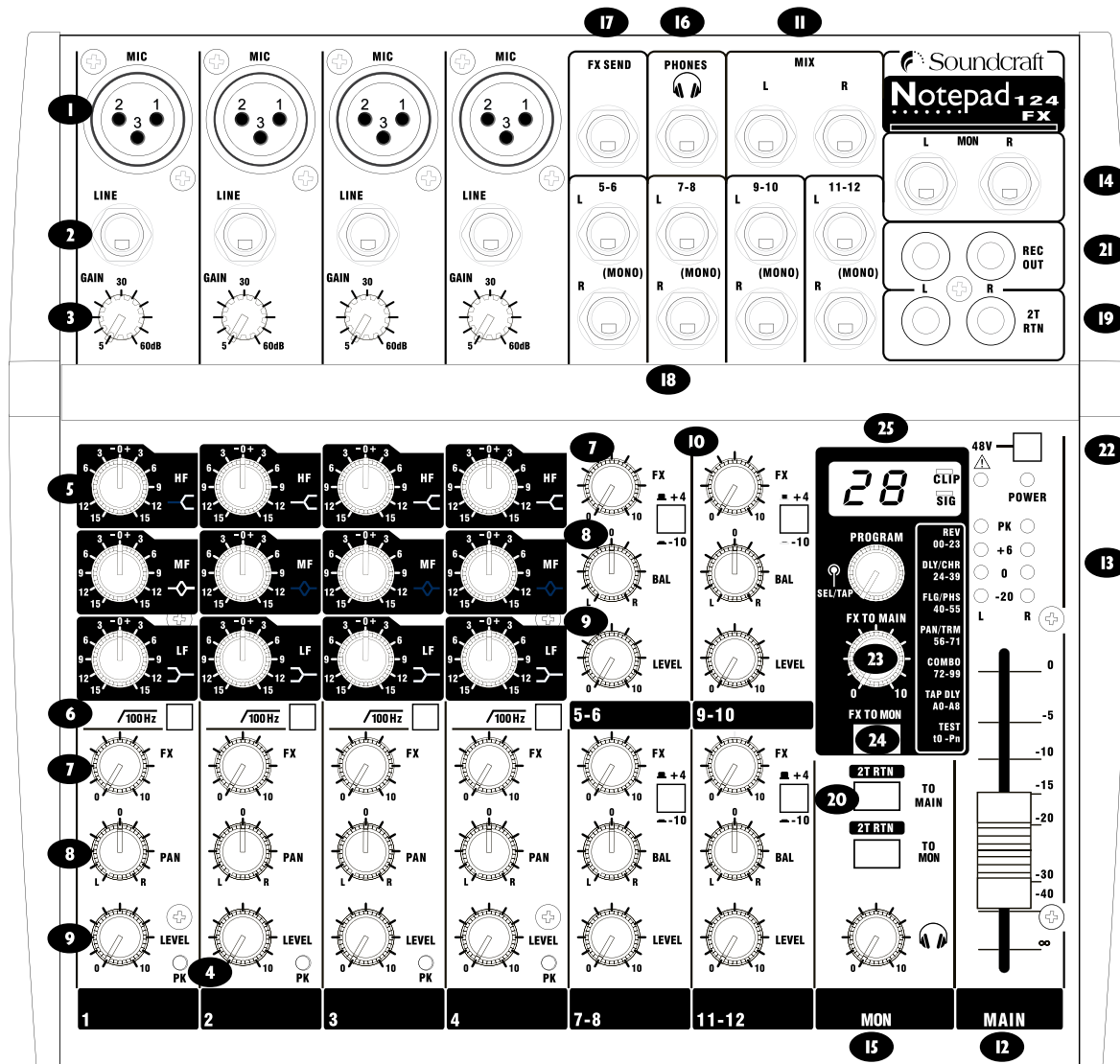

1 MIC INPUT (XLR)



Connect Microphones here. If you are using a condenser mic, ensure phantom power is supplied by pressing the switch at the top of the master section.

2 LINE INPUT (1/4" Jack)

WARNING: Do Not apply Phantom Power before connecting a microphone.

3 GAIN CONTROL

Connect Line level sources here, e.g. Synth, Drum Machine, DI etc.

4 PEAK LED

Adjust this to increase or decrease the level of the incoming signal.

This is used to indicate that the signal is close to distorting (clipping) on a specific channel.

5 EQ STAGE

Adjust these controls to change the signal tone (the character of the signal).

6 HPF

The high-pass filter reduces the level of bass frequencies only. Use this in live PA situations to reduce stage rumble or 'popping' from mics.

7 FX SEND /AUX SEND

Adjust this control to change the level of the signal to the FX processor (Notepad 124FX) or an artist's monitors (headphones/in-ear/stage monitors, Notepad 124).

8 PAN or BAL CONTROL

Use the PAN control to position the signal within the stereo field. On Stereo inputs, BAL adjusts the balance of the stereo signal within the mix.

9 INPUT CHANNEL FADER

This is used to control the level fed to the Mix Bus outputs.

10 +4/-10 SWITCH

Used to set the input sensitivity of the stereo input channels.

11 MIX OUTPUTS (1/4" Jack)

Connect these to your analogue recording device, or to your amplification system.

12 MASTER FADER

This fader controls the overall level of the mix outputs.

13 MAIN METERS

These show the level of the mix outputs. This signal is replaced by the FX or 2-Track return signals depending upon the settings of the 2-Track and FX switches.

14 MONITOR OUTPUTS

(1/4" Jack)

These are used to feed your monitoring system. This can be directly connected to powered monitors, or indirectly via an amplifier to standard monitors.

15 MONITOR/PHONES CONTROL

This controls the level of the signal sent to your monitoring system **and** signal sent to the headphones jack socket.

16 HEADPHONES (1/4" Jack)

Plug your headphones into this socket. Recommended headphones impedance is 32 ohms or greater.

17 FX SEND/AUX OUTPUT

(1/4" Jack)

This output can be used to send the channel signal to an artist's monitors (headphones/in-ear/stage monitors). or external FX processor).

18 STEREO INPUTS (1/4" Jack)

These inputs can be used to connect line level stereo inputs from keyboards, sound modules, samplers, computer based audio cards etc.

19 2-TRACK INPUTS (RCA Phono)

You can connect the playback from your recording device or CD/MP3 player here.

20 2-TRACK CONTROLS

Use these to control the 2 Track signal. The TO MON switch sends the signal to the monitor outputs and phones, whilst the TO MAIN switch sends it to the main mix. You can connect these to the inputs of your recording device.

21 RECORD OUTPUTS

(RCA Phono)

22 PHANTOM POWER

Press this to switch the phantom power (48V) on for condenser microphones.



WARNING: Do Not apply Phantom Power before connecting a microphone.

Notepad 124FX only

23 FX TO MAIN

The rotary control regulates the signal level being fed from the FX processor to the MAIN MIX L and R outputs.

24 FX TO MON

The FX TO MON switch routes the post-FX signal to the monitor/headphones outputs.

25 FX PROCESSOR

See the information starting on page 24.

Notepad 124 only

26 AUX SEND

26

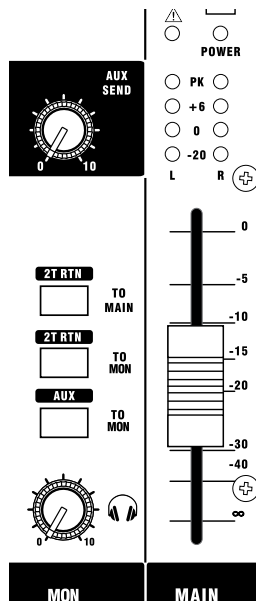

The rotary control regulates the signal level being fed from the AUX bus to the AUX OUTPUT socket (and MON output when selected).

27 AUX TO MON

27

The AUX TO MON switch routes the AUX signal to the Monitor/Headphone outputs.

INPUTS

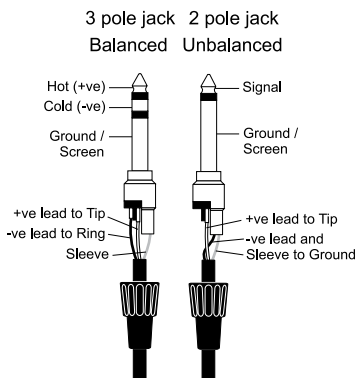
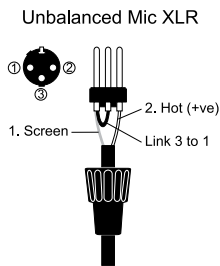
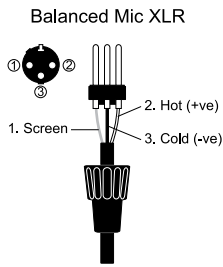

WIRING UP

Mic Input

The MIC input accepts XLR-type connectors and is designed to suit a wide range of BALANCED or UNBALANCED low-level signals, whether from delicate vocals requiring the best low-noise performance, or drum kits needing maximum headroom. Professional dynamic, condenser or ribbon mics are best because these will be LOW IMPEDANCE. While you can use low-cost HIGH IMPEDANCE mics, you do not get the same degree of immunity to interference on the microphone cable and as a result the level of background noise may be higher. If you turn the PHANTOM POWER on, the socket provides a suitable powering voltage for professional condenser mics. We recommend you check out the range of microphones available from AKG, at www.ake.com



DO NOT use UNBALANCED sources with the phantom power switched on. The voltage on pins 2 & 3 of the XLR connector may cause serious damage. BALANCED dynamic mics may normally be used with phantom power switched on (contact your microphone manufacturer for guidance)

The input level is set using the input GAIN knob.

The LINE input offers the same gain range as the MIC input, but at a higher input impedance, and is 15dB less sensitive. This is suitable for most line level sources.



WARNING !

Start with the input GAIN knob turned fully anticlockwise when plugging high level sources into the LINE input to avoid overloading the input channel or giving you a very loud surprise!

Line Input

Accepts 3-pole 6.35mm (1/4") jacks, or 2-pole mono jacks which will automatically ground the 'cold' input. Use this input for sources other than mics, such as keyboards, drum machines, synths, tape machines or DI boxes. The input is BALANCED for low noise and immunity from interference, but you can use UNBALANCED sources by wiring up the jacks as shown, although you should then keep cable lengths as short as possible to minimise interference pick-up on the cable. Note that the ring must be grounded if the source is unbalanced. Set the input level using the GAIN knob, starting with the knob turned fully anticlockwise. Unplug any MIC connection when using the LINE input.

Stereo Inputs

These accept 3-pole 6.35mm (1/4") jacks, or 2-pole mono jacks which will automatically ground the 'cold' input. Use these inputs for sources such as keyboards, drum machines, synths, tape machines or as returns from processing units. The input is BALANCED for low noise and immunity from interference, but you can use UNBALANCED sources by wiring up the jacks as shown, although you should keep cable lengths as short as possible to minimise interference pick-up on the cable, but the ring must be grounded if the source is unbalanced. Mono sources can be fed to both paths by plugging into the Left jack only.

OUTPUTS

Mix Output
Aux Outputs
Monitor Outputs

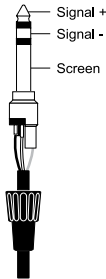

Mix Outputs

The MIX outputs are on 1/4" TRS jacks, wired as shown, and incorporate impedance balancing, allowing long cable runs to balanced amplifiers and other equipment.

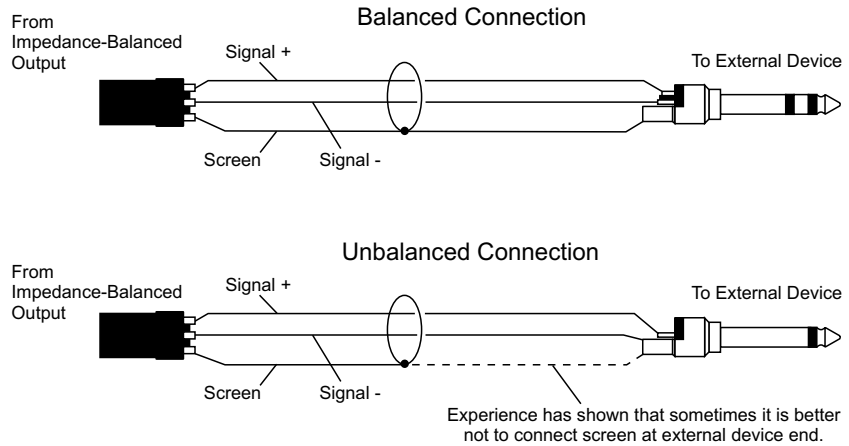

Aux/FX SEND Outputs

The Aux/FX Bus outputs are on 3-pole 6.35mm (1/4") jack sockets, wired as shown on the left, and are impedance balanced.

MONITOR Outputs

The MONITOR outputs are on 3-pole 6.35mm (1/4") jack sockets, wired as shown on the left, and are impedance balanced.

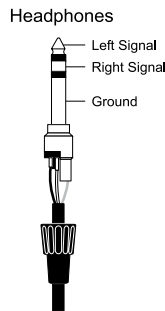

Headphones

The PHONES output is a 3-pole 6.35mm (1/4") jack, wired as a stereo output as shown, ideally for headphones of 32Ω or greater. 8Ω headphones are **not** recommended.

We recommend you check out the range of headphones available from AKG, at www.ake.com

Polarity (Phase)

You will probably be familiar with the concept of polarity in electrical signals and this is of particular importance to balanced audio signals. Just as a balanced signal is highly effective at cancelling out unwanted interference, so two microphones picking up the same signal can cancel out, or cause serious degradation of the signal if one of the cables has the +ve and -ve wires reversed. This phase reversal can be a real problem when microphones are close together and you should therefore always take care to connect pins correctly when wiring audio cables.

Grounding and Shielding

For optimum performance use balanced connections where possible and ensure that all signals are referenced to a solid, noise-free earthing point and that all signal cables have their screens connected to ground. In some unusual circumstances, to avoid earth or ground 'loops' ensure that all cable screens and other signal earths are connected to ground only at their source and not at both ends.

If the use of unbalanced connections is unavoidable, you can minimise noise by following these wiring guidelines:

- On INPUTS, unbalance at the source and use a twin screened cable as though it were balanced.
- On OUTPUTS, connect the signal to the +ve output pin, and the ground of the output device to -ve. If a twin screened cable is used, connect the screen only at the mixer end.
- Avoid running audio cables or placing audio equipment close to thyristor dimmer units or power cables.
- Noise immunity is improved significantly by the use of low impedance sources, such as good quality professional microphones or the outputs from most modern audio equipment. Avoid cheaper high impedance microphones, which may suffer from interference over long cable runs, even with well-made cables.

Grounding and shielding is still seen as a black art, and the suggestions above are only guidelines. If your system still hums, an earth/ground loop is the most likely cause. Two examples of how an earth loop can occur are shown below.

Example 1

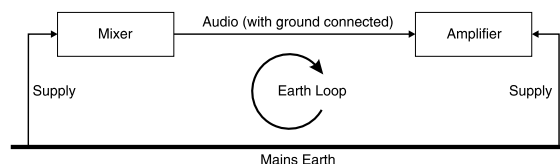

Example 2

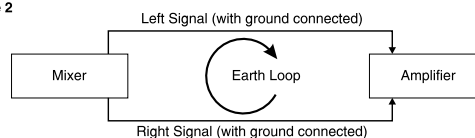



Warning!

Under NO circumstances must the AC power mains earth be disconnected from the mains lead.

PROBLEM SOLVING

Basic problem solving is within the scope of any user if a few basic rules are followed.

- Get to know the Block Diagram of your console (see page 14).
- Get to know what all controls and/or connections in the system are supposed to do.
- Learn where to look for common trouble spots.

The Block Diagram is a representative sketch of all the components of the console, showing how they connect together and how the signal flows through the system.

Once you have become familiar with the various component blocks you will find the Block Diagram is quite easy to follow and you will have gained a valuable understanding of the internal structure of the console.

Each component has a specific function and only by getting to know what each part is supposed to do will you be able to tell if there is a genuine fault! Many “faults” are the result of incorrect connection or control settings which may have been overlooked.

Basic Troubleshooting is a process of applying logical thought to the signal path through the console and tracking down the problem by elimination.

- Swap input connections to check that the source is really present. Check both Mic and Line inputs.
- Route channels to different outputs or to auxiliary sends to identify problems on the Master section.
- Compare a suspect channel with an adjacent channel which has been set up identically.

If in doubt please contact Soundcraft customer support.

PRODUCTS UNDER WARRANTY

UK customers should contact their local dealer.

Customers outside the UK are requested to contact their territorial distributor who is able to offer support in the local time zone and language. Please see the distributor listings on our website (www.soundcraft.com) to locate your local distributor.

OUT-OF-WARRANTY PRODUCTS

For out-of-warranty consoles purchased in the United Kingdom, please contact the Customer Services Department (e-mail: soundcraft.support@harman.com) at the factory in Potters Bar, Hertfordshire: Telephone +44 (0)1707 665000.

For all other out-of-warranty consoles, please contact the appropriate territorial distributor. When mailing or faxing please remember to give as much information as possible. This should include your name, address and a daytime telephone number. Should you experience any difficulty please contact Customer Services Department (e-mail: soundcraft.support@harman.com)

BLOCK DIAGRAM - NOTEPAD 124FX

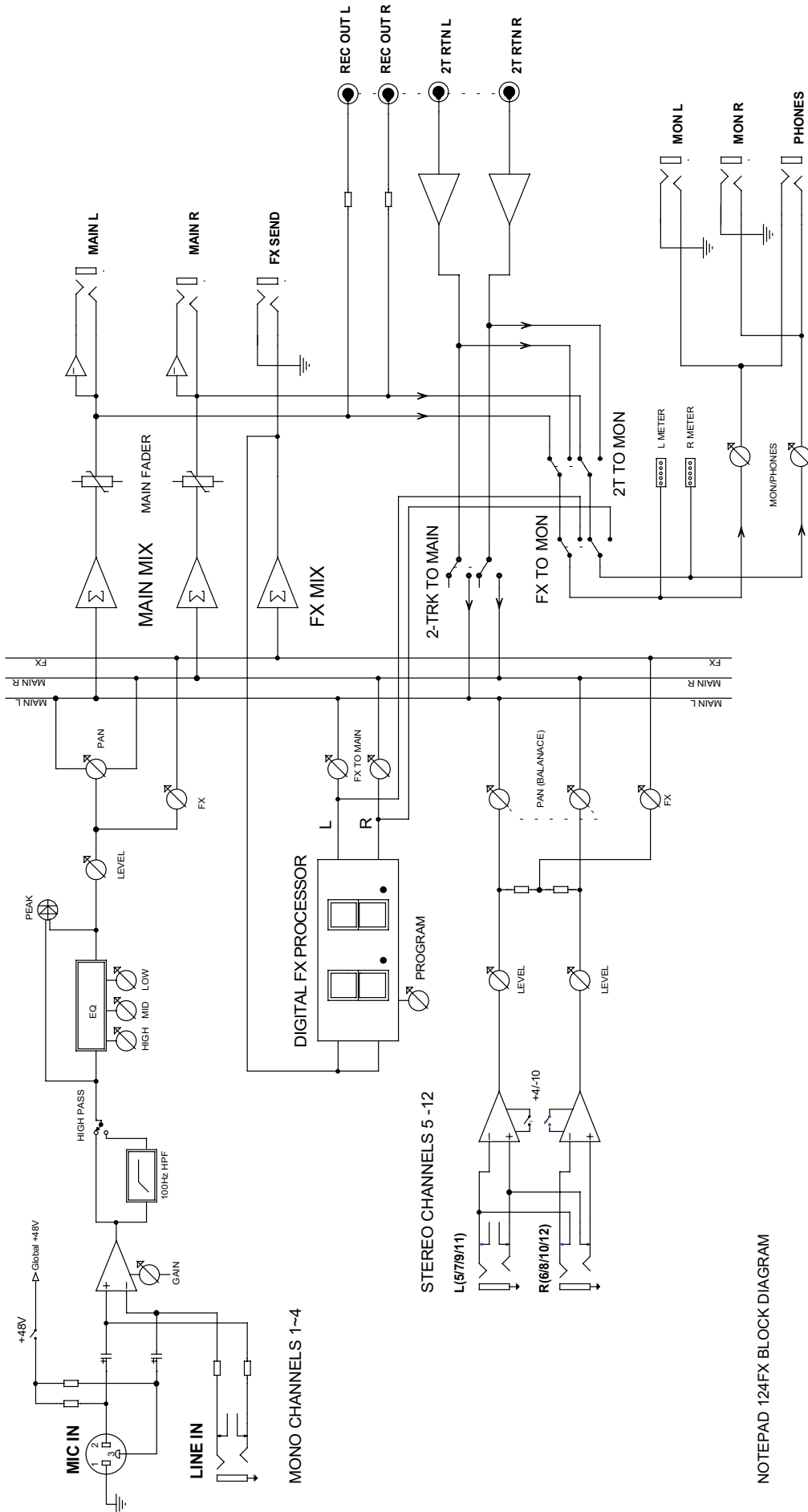

NOTEPAD 124FX BLOCK DIAGRAM

BLOCK DIAGRAM - NOTEPAD 124

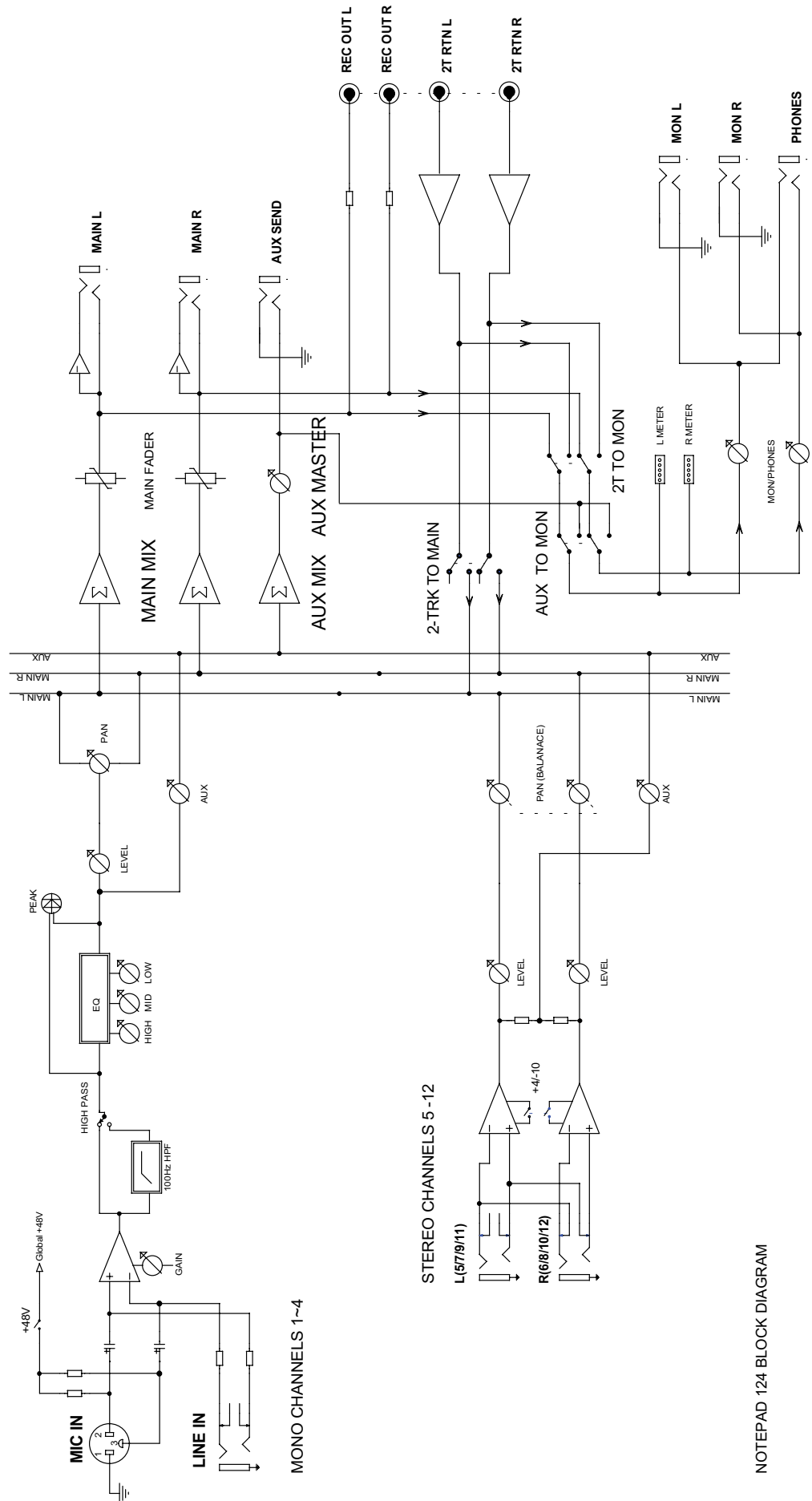

NOTEPAD 124 BLOCK DIAGRAM

MONO INPUT CHANNELS

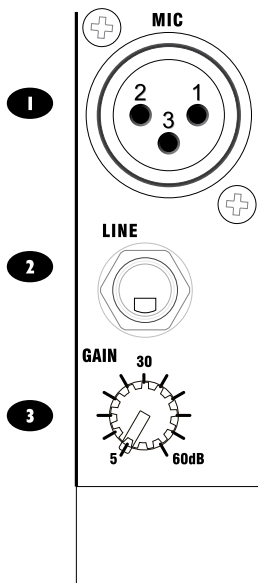

1 Mic Input

The MIC input accepts XLR-type connectors and is designed to suit a wide range of BALANCED or UNBALANCED signals. Professional dynamic, condenser or ribbon mics are best because these will be LOW IMPEDANCE. You can use low-cost HIGH IMPEDANCE mics, but the level of background noise will be higher. If you turn the PHANTOM POWER on (right-hand side of the mixer) the socket provides a suitable powering voltage for professional condenser mics.



ONLY connect condenser microphones with the +48V powering OFF, and ONLY turn the +48V powering on or off with all output faders DOWN, to prevent damage to the mixer or external devices.

TAKE CARE when using unbalanced sources, which may be damaged by the phantom power voltage on pins 2 & 3 of the XLR connector. Unplug any mics if you want to use the LINE Input.

The input level is set using the GAIN knob.

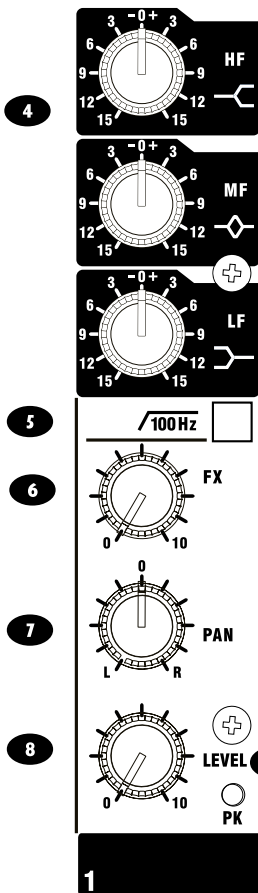

2 Line Input

Accepts 3-pole 6.35mm (1/4") jacks. Use this input for sources other than mics, such as keyboards, drum machines, synths, tape machines or DI'd guitars. The input is BALANCED for low noise and top quality from professional equipment, but you can use UNBALANCED sources by wiring up the jacks as shown in the 'wiring up' section, although you should then keep cable lengths as short as possible. Unplug anything in the MIC input if you want to use this socket. Set the input level using the GAIN knob.

3 Gain

This knob sets how much of the source signal is sent to the rest of the mixer. Too high, and the signal will distort as it overloads the channel. Too low, and the level of any background hiss will be more noticeable and you may not be able to get enough signal level to the output of the mixer.

Note that some sound equipment, particularly that intended for domestic use, operates at a lower level (-10dBV) than professional equipment and will therefore need a higher gain setting to give the same output level.

4 Equaliser

The Equaliser (EQ) allows fine manipulation of the sound, particularly to improve the sound in live PA applications where the original signal is often far from ideal and where slight boosting or cutting of particular voice frequencies can really make a difference to clarity. There are three sections giving the sort of control usually only found on much larger mixers. The EQ knobs can have a dramatic effect, so use them sparingly and listen carefully as you change any settings so that you get to know how they affect the sound.

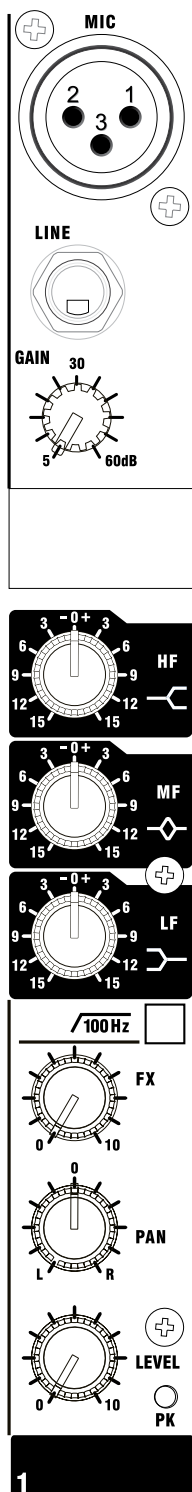

HF EQ

Turn to the right to boost high (treble) frequencies above 10kHz by up to 15dB, adding crispness to cymbals, vocals and electronic instruments. Turn to the left to cut by up to 15dB, reducing hiss or excessive sibilance which can occur with certain types of microphone. Set the knob in the centre-detented position when not required.

MID EQ

Turn to the right to boost mid frequencies around 1kHz by up to 15dB. This allows some truly creative improvement of the signal in live situations, because this mid band covers the range of most vocals. Set the knob to the centre-detented position when not required.

LF EQ

Turn to the right to boost low (bass) frequencies below 80Hz by up to 15dB, adding warmth to vocals or extra punch to synths, guitars and drums. Turn to the left to cut low frequencies by up to 15dB for reducing hum, stage rumble or to improve a mushy sound. Set the knob to the centre-detented position when not required.

5 HIGH-PASS FILTER

Pressing this switch activates the high-pass filter. This reduces the level of bass frequencies only. Use this in live PA situations to reduce stage rumble or 'popping' from mics.

6 AUX SEND (Notepad 124)

This is used to set up a separate mix for FOLDBACK or MONITORS and is mixed to the respective Aux Output. The send is pre-fade, so the output level will be independent of the CHANNEL LEVEL control setting.

6 FX SEND (Notepad 124FX)

This control sets the level of the post-fade signal being sent to the FX bus; from there it is routed to the FX processor. The FX Send is post-fade.

7 PAN

This control sets the amount of the channel signal feeding the Left and Right MIX buses, allowing you to move the source smoothly across the stereo image. When the control is turned fully left or right you are able to route the signal at unity gain to either left or right outputs individually.

8 INPUT CHANNEL LEVEL

This control allows precise balancing of the various source signals being mixed to the Master Section. You get most control when the input GAIN is set up correctly, giving full travel on the control.

9 PEAK LED

This LED will light when the signal level approaches clipping at either of two monitored points: PRE-EQ and POST-EQ.

STEREO INPUT CHANNELS

There are four stereo inputs available.

1 STEREO INPUTS

These inputs accept 3-pole 6.35mm (1/4") jacks. Use these inputs for sources such as keyboards, drum machines, synths, tape machines or processing units. The inputs are BALANCED for low noise and top quality from professional equipment, but you can use UNBALANCED sources by wiring up the jacks as shown in the 'Wiring Up' section earlier in this manual, although you should then keep cable lengths as short as possible. Mono sources may be used by plugging into the left jack only.

2 AUX/FX SEND (FX send shown, Notepad 124FX)

This is used to set up a separate mix for FOLDBACK, EFFECTS or RECORDING, and is mixed to the Aux or FX Send Output at the rear of the mixer. For the Notepad 124FX, it is desired that for the signal fades up and down with the fader (this is called POST-FADE), but for Foldback or Monitor feeds using the Notepad 124, it is important for the send to be independent of the fader (this is called PRE-FADE).

3 +4/-10 SWITCH

This switch allows you to change the input sensitivity of the stereo input. Most consumer-type equipment such as CD players has an output of -10dBv so this switch setting should be used. For professional equipment which has higher level outputs, the +4 setting should be used. If in doubt, always start with the +4 setting so that you do not overload the input.

4 BAL (BALANCE)

This control sets the amount of the channel signal feeding the Left and Right MIX buses, allowing you to balance the source in the stereo image. When the control is turned fully right or left you feed only that side of the signal to the mix. Unity gain is provided by the control in the centre-detented position.

5 INPUT CHANNEL LEVEL

This control allows precise balancing of the various source signals being mixed to the Master Section.

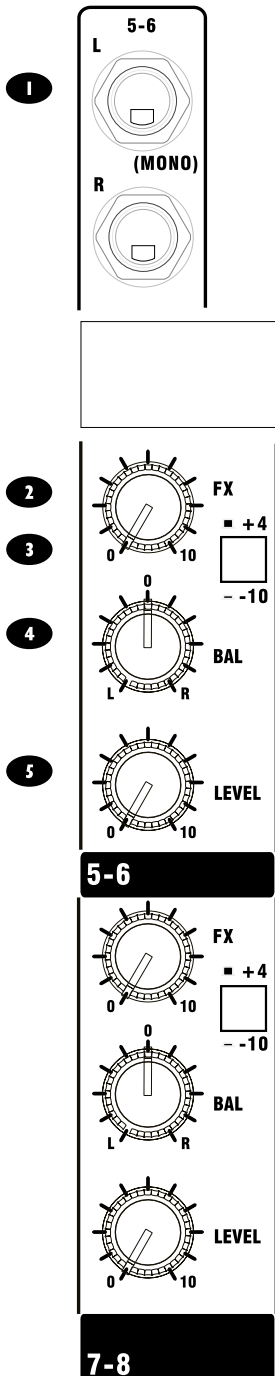

MASTER SECTION

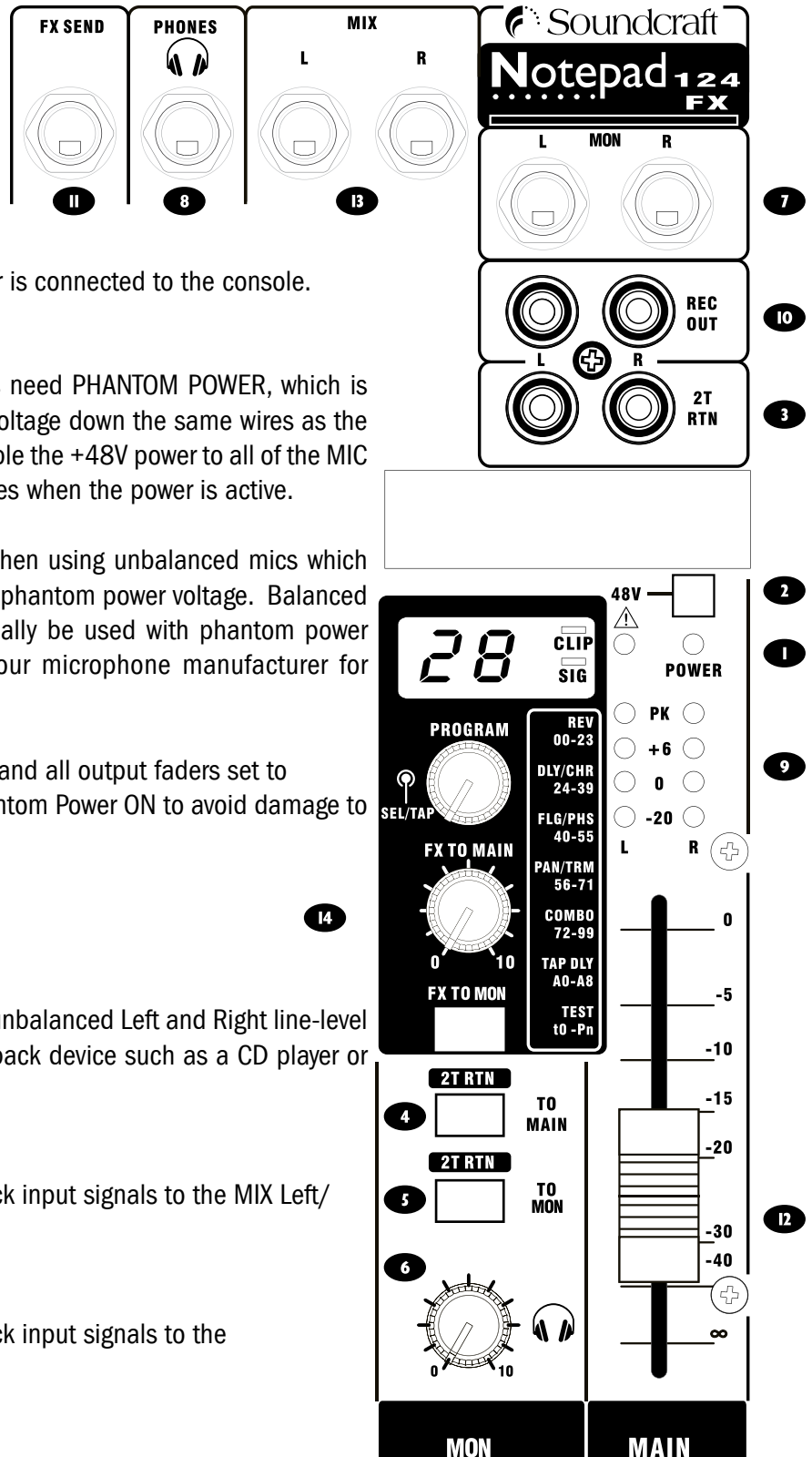

1 POWER INDICATOR

This LED lights to show when power is connected to the console.

2 PHANTOM POWER

Many professional condenser mics need PHANTOM POWER, which is a method of sending a powering voltage down the same wires as the mic signal. Press the switch to enable the +48V power to all of the MIC inputs. The adjacent LED illuminates when the power is active.



WARNING: TAKE CARE when using unbalanced mics which may be damaged by the phantom power voltage. Balanced dynamic mics can normally be used with phantom power switched on (contact your microphone manufacturer for guidance).

Mics should always be plugged in, and all output faders set to minimum before switching the Phantom Power ON to avoid damage to external equipment.

2-TRACK

3 2-TRACK IN

These two RCA phono sockets are unbalanced Left and Right line-level inputs, used for connecting a playback device such as a CD player or MP3 player.

4 2-TRACK TO MAIN

Press this switch to route the 2 Track input signals to the MIX Left/Right signals.

5 2-TRACK TO MON

Press this switch to route the 2 Track input signals to the MONITORING outputs.

MONITOR OUT

6 MONITOR OUTPUT LEVEL

This control sets the signal level fed to the MONITOR LEFT & RIGHT outputs and the Headphone outputs.

7 MONITOR OUTPUTS

The Monitor Outputs are on 3-pole 6.35mm (1/4") jacks and are impedance balanced.

8 HEADPHONES SOCKET

The PHONES output is a 3-pole 6.35mm (1/4") jack, wired as a stereo output, ideally for headphones of 32Ω or greater. 8Ω headphones are **not** recommended.

9 METERS

The three-colour peak reading BARGRAPH METERS normally show the level of the signal(s) selected by the monitor source-select switches, giving you a constant warning of excessive peaks in the signal(s) which might cause overloading. Aim to keep the signal within the amber segments at peak levels for best performance.

Similarly, if the output level is too low and hardly registering at all on the meters, the level of background noise may become significant. Take care to set up the input levels for best performance.

10 RECORD OUTPUTS

These two RCA outputs carry a copy of the MIX L and MIX R signals. They allow the use of a recording device, e.g. PC, cassette tape recorder, hard-disk recorder etc.

11 AUX (Notepad 124)/FX BUS (Notepad 124FX) OUTPUT

This output is on a 3-pole 6.35mm (1/4") jack and is impedance balanced.

MIX OUTPUTS

12 MIX FADER

The MIX FADER sets the final level of the Mix outputs. This should normally be set close to the '0' mark if the input GAIN settings have been correctly set, to give maximum travel on the fader for smoothest control.

13 MIX OUTPUTS

The Mix LEFT and RIGHT outputs are sent from the 1/4" jack sockets as balanced signals.

FX PROCESSOR - NOTEPAD 124FX Only

For detailed instructions on using the FX Processor see the section which starts on the next page.

14 FX TO MAIN

This control regulates the signal level being fed from the FX processor to the MAIN mix L and R outputs.

FX PROCESSOR OVERVIEW (NOTEPAD 124FX ONLY)

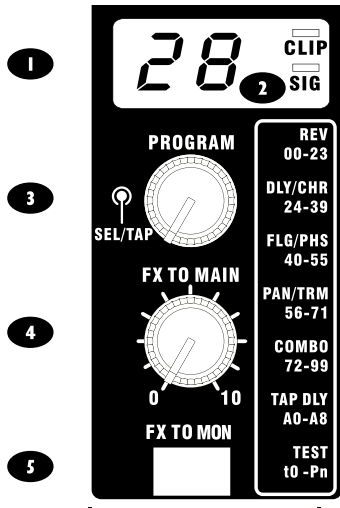

1. Digital Effect Display

This 2-digital numeric display shows the program number that is currently applied. Rotating the Program control will scroll through different program numbers, pressing the PROGRAM control (3) will select the effect. The display will revert back to the original program if a new program is not selected within fifteen seconds.

For a list of available effects, please refer to the Effects Data Chart Table.

2. Sig and Clip Indicators

The Sig LED will light up when signal is sent to the effects processor, and the Clip LED will light up shortly before excessive signals are dynamically clipped. If the Clip LED lights up too often, to turn down one or all FX sends on input channels.

3. Program Control

This control is used to scroll through the various effects. Pushing this control will apply the new effect.

Tap Delay (selections A0 to A8)

When a tap-delay effect is selected, pressing this control will allow users to select the tap-delay time. By pushing the button several times, the effects processor interprets the time between last two pushes and remembers this as the delay time, until the button is pushed again (this is kept, even after the power is turned off). When the tap delay effect is selected, a small LED will flash within the display window to mark the tempo.

4. EFX 'to Main' Control

This will adjust the level of the FX signal that will be sent to the Main Mix left and right outputs.

5. EFX 'to MON' Button

This button is pushed to allow the signal from the Digital Effect processor to be sent to the Monitoring outputs for monitoring purposes.

The effects within the console have been designed with both live sound reinforcement and home recording in mind. The effects processor offers increased versatility and high quality effects, all instantly accessible via the extremely intuitive front panel controls. The effects processor has more than 100 programs.

FX OPERATION

Select and Load a Program

Turn the PROGRAM control to choose a program and press down to select the effect.

Set Audio Levels

1. Set the gain on the input channel appropriate to the source (vocal microphone, guitar, keyboard, etc.).
2. Set the FX send on the input channel to the 12 o'clock position.
3. Set the FX Master level to the 12 o'clock position.
4. Provide source signal (by speaking or singing into the microphone, playing guitar, keyboard, etc.) on the selected channel.
5. Turn up the FX Send level on the channel until the Red CLIP LED in the FX Panel lights only occasionally. If the red Input LED stays lit, too much signal is being sent to the effect processor; reduce the FX Send on the input channel.
7. To increase or decrease the amount of effect on the signal, adjust the FX Send level on the channel that you want affected.

REVERBS

Reverberation (or “reverb” for short) is the complex effect created by the way we perceive sound in an enclosed space. When sound waves encounter an object or boundary, they don't just stop. Some of the sound is absorbed by the object, but most of the sound is reflected or is diffused. In an enclosed space, reverb is dependent on many features of that space, including the size, shape and the type of materials that line the walls. Even with closed eyes, a listener can easily tell the difference between a closet, a locker room and a large auditorium. Reverb is a natural component of the acoustic experience, and most people feel that something is missing without it.

Room Reverb

Room produces an excellent simulation of a very small room which is useful for dialog and voiceover applications. Room is also practical when used judiciously for fattening up high energy signals like electric guitar amp recordings. Historically, recording studio chambers were oddly shaped rooms with a loudspeaker and set of microphones to collect ambience in various parts of the room.

Hall Reverb

A Hall effect is designed to emulate the acoustics of a concert hall – a space large enough to contain an orchestra and an audience. Because of the size and characteristics, halls are the most natural-sounding reverbs, designed to remain ‘behind’ the direct sound – adding ambience and space, but leaving the source unchanged. This effect has a relatively low initial echo density which builds up gradually over time.

Plate Reverb

A Plate reverb is a large, thin sheet of metal suspended upright under tension on springs. Transducers attached to the plate transmit a signal that makes the plate vibrate, causing sounds to appear to be occurring in a large, open space. The Plates in the FX processor model the sound of metal plates with high initial diffusion and a relatively bright, colored sound. Plate reverbs are designed to be heard as part of the

music, mellowing and thickening the initial sound. Plate reverbs are often used to enhance popular music, particularly percussion.

Reverse Reverb

Reverse reverb works in the opposite fashion from normal reverb. Whereas a normal reverb has the loudest series of reflections heard first that then become quieter over time, the Reverse reverb has the softest reflections (essentially the tail of the reverb) heard first, and then grows louder over time until they abruptly cut off.

Gated Reverb

Gated reverb is created by feeding a reverb, such as a metal plate, through a gate device. The Gated reverb provides a fairly constant sound with no decay until the reverb is cut off abruptly. This program works well on percussion – particularly on snare and toms; be sure to experiment with other sound sources as well.

DELAYS

Delays repeat a sound a short time after it first occurs. Delay becomes echo when the output is fed back into the input (feedback). This turns a single repeat into a series of repeats, each a little softer than the last.

Ping-Pong Delay

This delay effect pans the delay repeats from left to right, while the input signal remains at its original (center) position.

MODULATED EFFECTS

Chorus

Chorus creates a lush, full sound by combining two or more signals together where one is unaffected and the other signals vary in pitch very slightly over time. Chorus is commonly used to fatten up tracks and to add body to guitars without coloring the original tone. Chorus can also be used with discretion to thicken a vocal track.

Flanger

This effect was originally created by simultaneously recording and playing back two identical programs on two tape recorders, then using hand pressure against the flange of the tape reels to slow down first one machine, then the other. The result was a series of changing phase cancellations and reinforcements, with characteristic swishing, tunneling, and fading sounds.

Phaser

The Phaser automatically moves frequency notches up and down the spectrum of the signal by means of a low frequency oscillator (LFO), creating an oscillating 'comb-filter' type effect. This effect is very useful on keyboards (especially pad presets) and guitars.

Tremelo

Tremolo creates rhythmic changes in signal amplitude. Tremolo affects both channel's amplitude simultaneously.

EFFECTS DATA CHART

NO	PROGRAM NAME	PARAMETER SETTING	NO	PROGRAM NAME	PARAMETER SETTING
	ROOM	REV-TIME			PAN TYPE
00	COMPACT ROOM 1	0.05	56	SLOW PAN	R-->L
01	COMPACT ROOM 2	0.4	57	SLOW PAN 1	R<-->L
02	SMALL ROOM 1	0.45	58	SLOW PAN 2	R-->L
03	SMALL ROOM 2	0.6	59	MID SHIFT	R<-->L
04	MID ROOM 1	0.9	60	MID SHIFT 1	L-->R
05	MID ROOM 2	1	61	MID SHIFT 2	L-->R
06	BIG ROOM 1	1.2	62	MID SHIFT 3	R-->L
07	TUNNEL	3.85	63	FAST MOVE	R<-->L
	HALL	REV-TIME			MODE-TYPE
08	JAZZ CLUB	0.9	64	LAZY TREMOLO	TRG
09	SMALL HALL 1	1.5	65	VINTAGE TREMOLO	TRG
10	SMALL HALL 2	1.75	66	WARM TREMOLO	TRG
11	SPRING HALL	1.9	67	WARM TREMOLO 1	TRG
12	MID HALL 1	2.3	68	HOT TREMOLO	TRG
13	MID HALL 2	2.45	69	HOT TREMOLO 1	TRG
14	RECITAL HALL	2.7	70	CRAZY TREMOLO 1	TRG
15	BIG HALL 2	3.3	71	CRAZY TREMOLO 2	TRG
	PLATE	REV-TIME			DELAY-1
16	SMALL PLATE	0.9	72	DELAY+REV 1	1
17	TAIL PLATE	1.2	73	DELAY+REV 2	2
18	MID PLATE 1	1.3	74	DELAY+REV 3	3
19	MID PLATE 2	2.2	75	DELAY+REV 4	4
20	REVERSE PLATE	2.25	76	DELAY+REV 5	5
21	LONG PLATE 1	2.6	77	DELAY+REV 6	6
22	LONG PLATE 2	3	78	DELAY+REV 7	7
23	LONG PLATE 3	4.2	79	DELAY+REV 8	8
	DELAY-1(stereo)	DELAY AVERG.			CHORUS
24	SHORT DELAY 1	0.07	80	CHORUS+REV 1	1
25	SHORT DELAY 2	0.14	81	CHORUS+REV 2	2
26	PING PONG DELAY	0.11	82	CHORUS+REV 3	3
27	MID DELAY 1	0.15	83	CHORUS+REV 4	4
28	MID DELAY 1	0.3	84	CHORUS+REV 5	5
29	SHORT DELAY 1 (MONO)	0.06	85	CHORUS+REV 6	6
30	MID DELAY 1 (MONO)	0.13	86	CHORUS+REV 7	7
31	LONG DELAY 1 (MONO)	0.18	87	CHORUS+REV 8	8
	CHORUS	LFO			FLANGER
32	SOFT CHORUS	0.2	88	FLANGER+REV 1	1
33	SOFT CHORUS 2	0.5	89	FLANGER+REV 2	2
34	SOFT CHORUS 3	0.8	90	FLANGER+REV 3	3
35	WARM CHORUS	1.8	91	FLANGER+REV 4	4
36	WARMER CHORUS 1	3.2	92	FLANGER+REV 5	5
37	WARMER CHORUS 2	5.2	93	FLANGER+REV 6	6
38	WARMER CHORUS 3	7.8	94	FLANGER+REV 7	7
39	HEAVY CHORUS	9.6	95	FLANGER+REV 8	8
	FLANGER	LFO			REV
40	CLASSIC FLANGER 1	0.1	96	GATED-REV-1 9	0.02
41	CLASSIC FLANGER 2	0.3	97	GATED-REV-2 10	0.2
42	GENTLE FLANGER	0.6	98	GATED-REV-1 9	0.02
43	WARM FLANGER	1.6	99	GATED-REV-2 10	0.5
44	MODERN FLANGER 1	2		TAP DELAY	FB LEVEL
45	MODERN FLANGER 2	2.8	80	TAP DELAY	0
46	DEEP FLANGER 1	4.6	75	A1 TAP DELAY	10
47	DEEP FLANGER 2	10	60	A2 TAP DELAY	20
	PHASER	LFO			RANGE
48	CLASSIC PHASER 1	0.1	A3	TAP DELAY	100mS - 2.7S
49	CLASSIC PHASER 2	0.4	A4	TAP DELAY	100mS - 2.7S
50	COOL PHASER	1.4	A5	TAP DELAY	100mS - 2.7S
51	WARM PHASER	3.2	A6	TAP DELAY	100mS - 2.7S
52	HEAVY PHASER 1	5	A7	TAP DELAY	100mS - 2.7S
53	HEAVY PHASER 2	6	A8	TAP DELAY	100mS - 2.7S
54	WILD PHASER 1	7.4		TEST TONE	FREQUENCY
55	WILD PHASER 2	9.6	0.8	T0 LOW FREQUENCY	100Hz
			4.8	T1 MID FREQUENCY	1kHz
				T2 HIGH FREQUENCY	10kHz
				PN PINK NOISE	20Hz~20kHz

USING YOUR NOTEPAD 124/124FX CONSOLE

The final output from your sound system can only ever be as good as the weakest link in the chain, and especially important is the quality of the source signal because this is the starting point of the chain. Just as you need to become familiar with the control functions of your mixer, so you must recognise the importance of correct choice of inputs, microphone placement and input channel settings. However, no amount of careful setting up can take account of the spontaneity and unpredictability of live performance. The mixer must be set up to provide “spare” control range to compensate for changing microphone position and the absorption effect of a large audience (different acoustic characteristics from soundcheck to show).

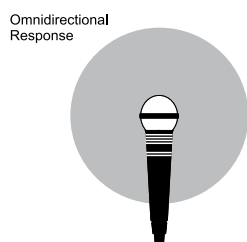
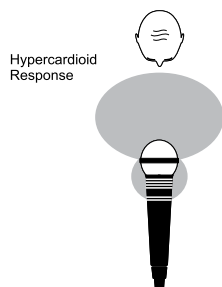
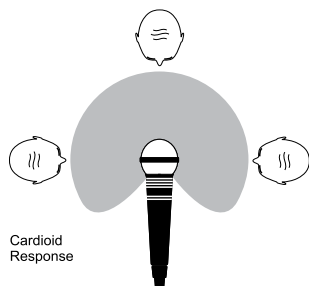

MICROPHONE PLACEMENT

Careful microphone placement and the choice of a suitable type of microphone for the job is one of the essentials of successful sound reinforcement. The diagrams on the left show the different pick-up patterns for the most common types of microphone. Cardioid microphones are most sensitive to sound coming from in front, and hypercardioid microphones offer even greater directivity, with a small amount of pickup behind the microphone. These types are ideal for recording vocalists or instruments, where rejection of unwanted sounds and elimination of feedback is important. The aim should be to place the microphone as close as physically possible to the source, to cut out unwanted surrounding sounds, allow a lower gain setting on the mixer and avoid feedback. Also a well chosen and well placed microphone should not need any appreciable equalisation.

There are no exact rules - let your ears be the judge. In the end, the position that gives the desired effect is the correct position!

For more tips, visit www.akg.com.

INITIAL SETUP

Once you have connected up your system (see the sections on connection and wiring earlier in this manual for guidance) you are ready to set initial positions for the controls on your mixer.

Set up individual input channel as follows:

- Connect your sources (microphone, keyboard etc.) to the required inputs.



WARNING: Phantom powered mics should be connected before the +48V is switched on. Ensure the PA system is OFF when switching phantom power on or off.

- Set Master faders at 0, input faders at 0, and set power amplifier levels to about 70%.
- Adjust the input gain until the PK LED lights occasionally on the loudest sections. This allows sufficient headroom to accommodate peaks and establishes the maximum level for normal operation (but see note below).

- Repeat this procedure on other channels as required. As more channels are added to the mix, the meters may move into the red section. Adjust the overall level using the Master Faders if necessary.
- Listen carefully for the characteristic sound of “feedback”. If you cannot achieve satisfactory input level setting without feedback, check microphone and speaker placement and repeat the exercise. If feedback persists, it may be necessary to use a Graphic Equaliser to reduce the system response at particular resonant frequencies.



Note:

The initial settings should only be regarded as a starting point for your mix. It is important to remember that many factors affect the sound during a live performance, for instance the size of the audience!

You are now ready to start building the mix and this should be done progressively, listening carefully for each component in the mix and watching the meters for any hint of overload. If this occurs, back off the appropriate Channel Fader slightly until the level is out of the red segments, or adjust the Master Faders.

Remember that the mixer is a mixer, not an amplifier. Increasing the overall level is the job of the amplifier, and if it is impossible to provide adequate level, it is probable that the amplifier is too small for the application. Choose your amplifier carefully, and do not try to compensate for lack of power by using the mixer to increase output level.



Note:

The level of any source signal in the final output is affected by many factors, principally the Input Gain control, Channel Fader and Mix Faders. You should try to use only as much microphone gain as required to achieve a good balance between signals, with the faders set as described above. If the input gain is set too high, the channel fader will need to be pulled down too far in compensation to leave enough travel for successful mixing and there is a greater risk of feedback because small fader movements will have a very significant effect on output level. Also there will be a chance of distortion as the signal overloads the channel and causes clipping. If the gain is set too low, you will not find enough gain on the faders to bring the signal up to an adequate level, and background hiss will be more noticeable. This is illustrated below:

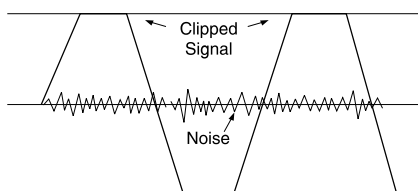

If the signal level is too high, clipping distortion may occur.

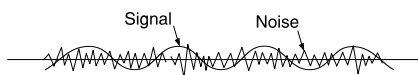

If the signal level is too low it may be masked by the noise.

MARK-UP SHEETS

You may freely copy these pages, and use them to record the settings used for particular applications/gigs.

The diagram illustrates the control panel of the Soundcraft Notepad 124 FX mixer. It is divided into several functional sections:

- Channels 1-4:** Each channel features a MIC input with three pins (2, 3, 1) and a LINE input. Below each input is a GAIN knob with a scale from 5 to 60dB.
- Channels 5-6, 7-8, 9-10, 11-12:** These channels have FX SEND, PHONES, and MIX (L/R) inputs. They also include L and R (MONO) outputs.
- MIX Section:** Includes L and R outputs and a REC OUT section with L and R outputs.
- FX Section:** Contains FX SEND, PHONES, and MIX inputs, along with L and R (MONO) outputs.
- Channel 1-4 EQ:** Each channel has three frequency sliders: HF (High Frequency), MF (Mid Frequency), and LF (Low Frequency). Each slider has a scale from 3 to 15.
- Channel 1-4 FX:** Each channel has an FX knob with a scale from 0 to 10.
- Channel 1-4 PAN:** Each channel has a PAN knob with L and R positions.
- Channel 1-4 LEVEL:** Each channel has a LEVEL knob with a scale from 0 to 10 and a PK (Peak) indicator.
- Channel 5-6 and 9-10:** These channels have FX, BAL (Balance), and LEVEL knobs.
- Channel 7-8 and 11-12:** These channels have FX, BAL, and LEVEL knobs.
- MON and MAIN:** The MON (Monitor) and MAIN sections have 2T RTN (Two-Turn Return) knobs and LEVEL meters.
- Display and Indicators:** A digital display shows the program number (e.g., 28). There are also indicators for CLIP, SIG, and POWER.
- Vertical Scale:** A vertical scale on the right side of the panel ranges from 0 to -40dB, with a PK indicator at the top.

MIC (x4): Each channel has three input jacks (2, 1, 3), a LINE input, and a GAIN knob (0 to 60dB).

AUX SEND: Input for auxiliary sends.

PHONES: Headphone output.

MIX: L and R stereo outputs.

Notepad 1 2 4: L, MON, R outputs.

REC OUT: L and R recording outputs.

2T RTN: Two-track return outputs.

Channel Strips 1-4: Each strip includes HF, MF, and LF frequency sliders, a 100Hz filter, AUX, PAN, and LEVEL knobs, and a PK indicator.

Channel Strips 5-6 and 9-10: Stereo channels with AUX, BAL, and LEVEL controls.

MONITOR: AUX SEND level meter and 2T RTN outputs (TO MAIN, TO MON, AUX).

MAIN: Vertical level meter and 48V power switch.

DIMENSIONS

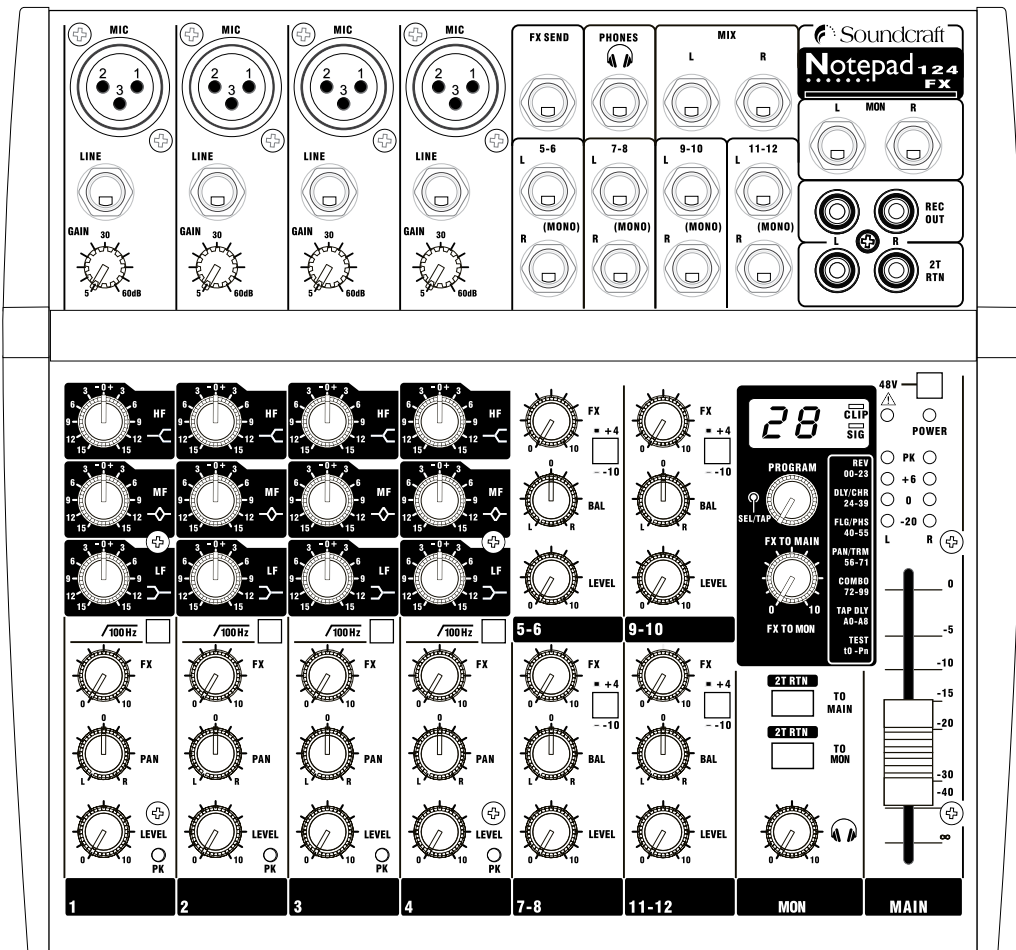
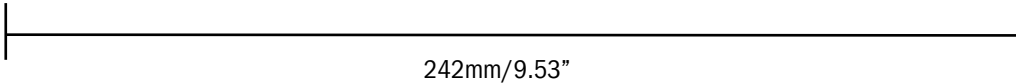

220mm
8.66"

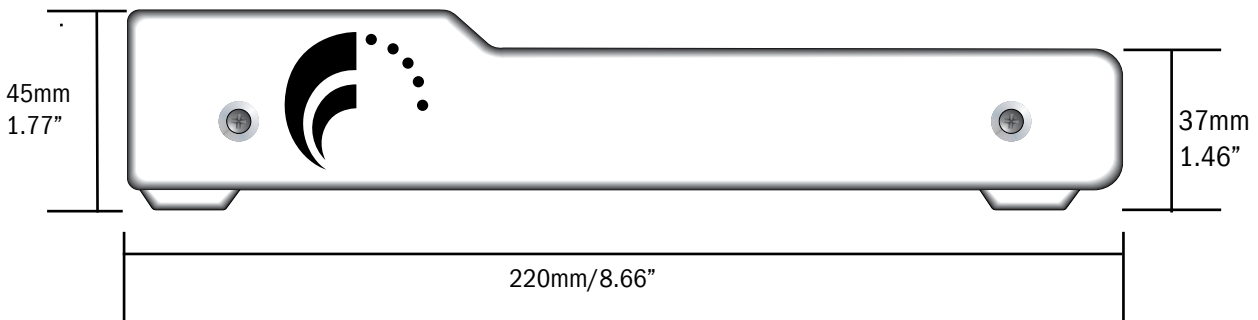

APPLICATIONS

APPLICATION EXAMPLE - LIVE SOUND REINFORCEMENT

Using Notepad 124 model

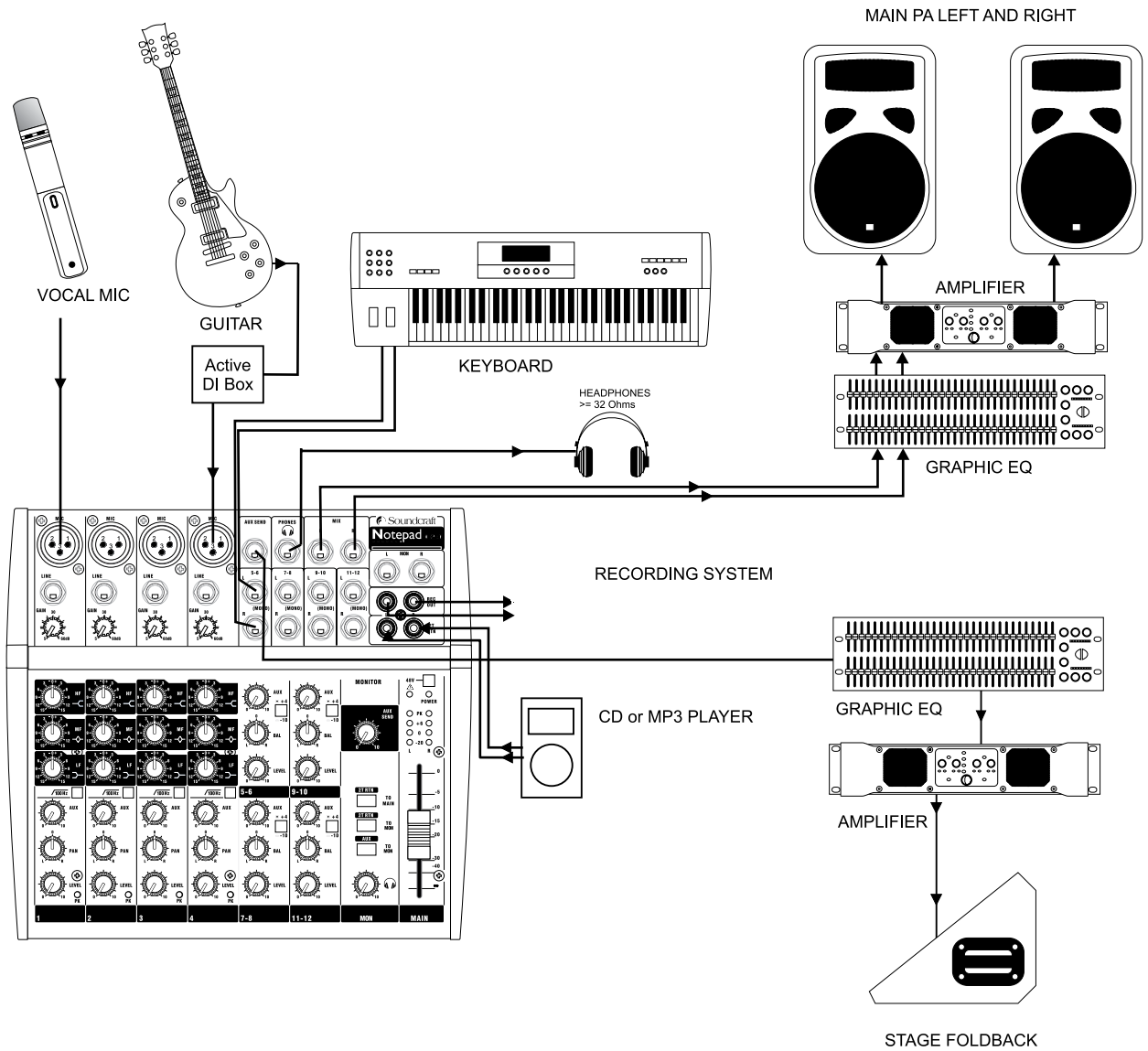

TYPICAL CONNECTING LEADS

Audio connectors used with Soundcraft consoles

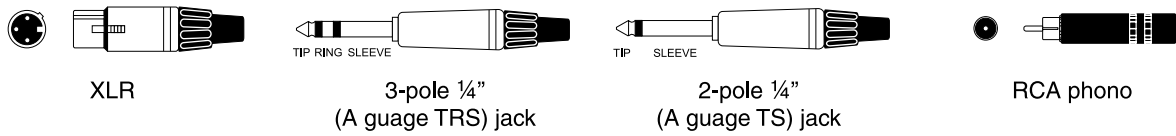

Balanced - Line Inputs, Mix L & R Outputs, Stereo Inputs, Auxiliary Outputs

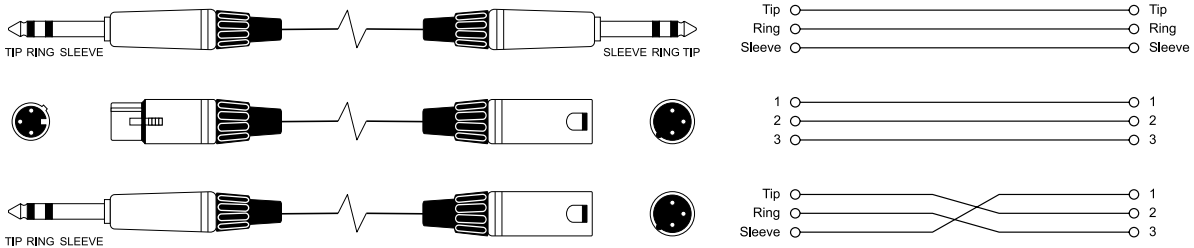

Unbalanced - Direct Output, Monitor Output, Stereo Return Inputs

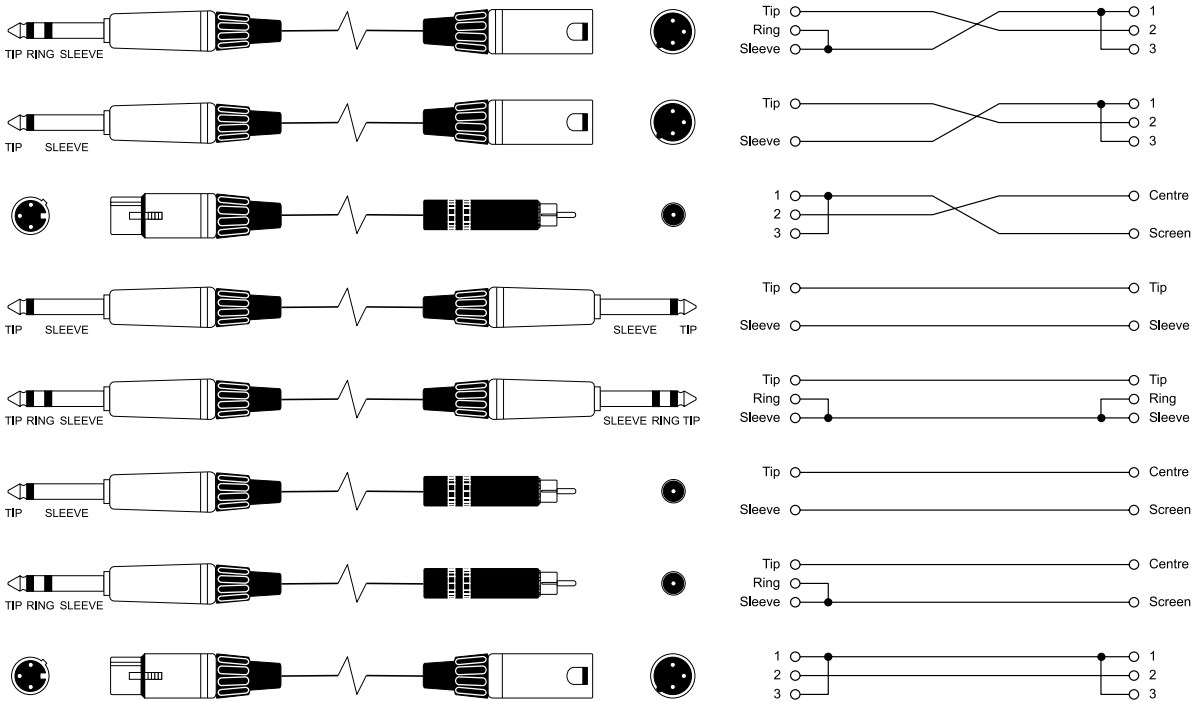

Insert Cables - Mono Inserts

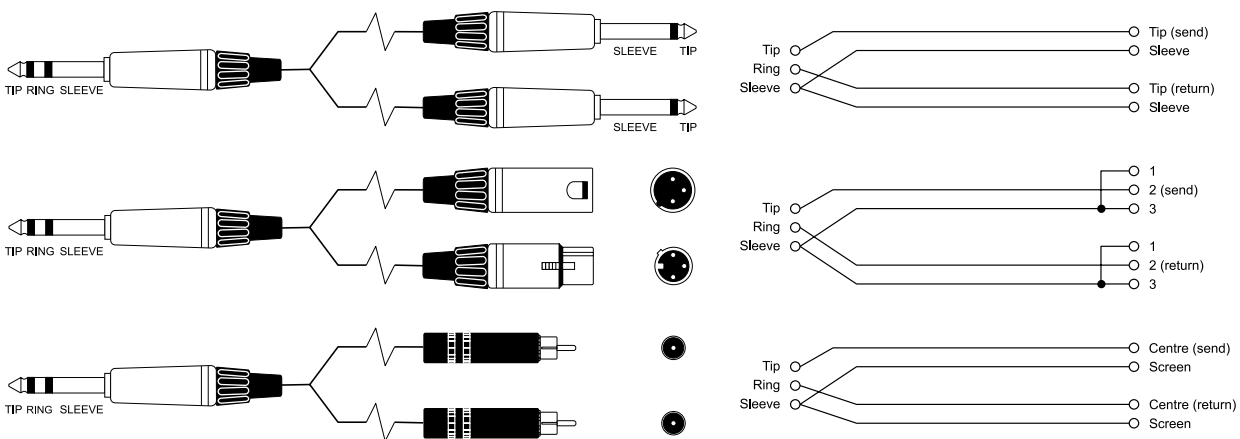

'Y' Cables (Balanced) Where used ... Aux, Mix outputs

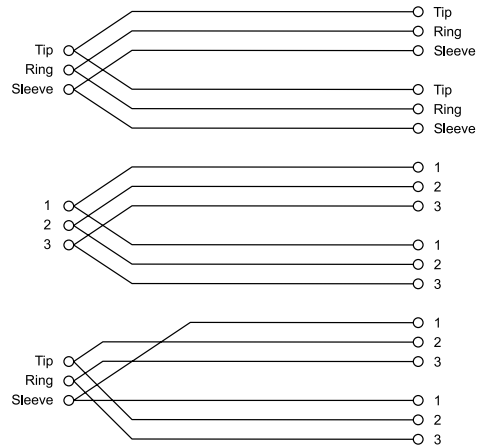
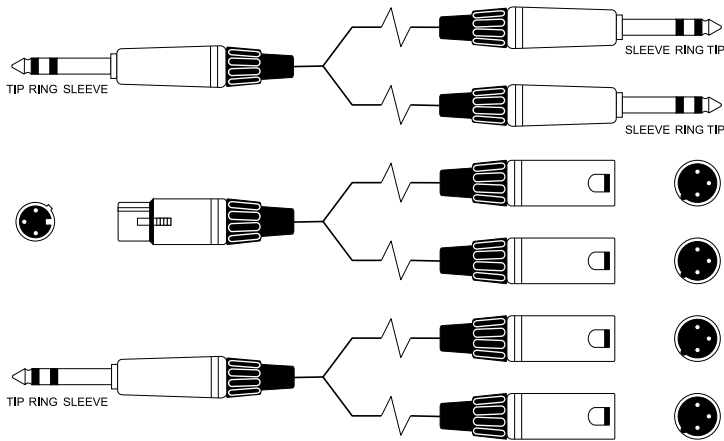

Headphone Separator Note: for every doubling of headphones the load impedance is halved. Do not go below 150 Ohms.

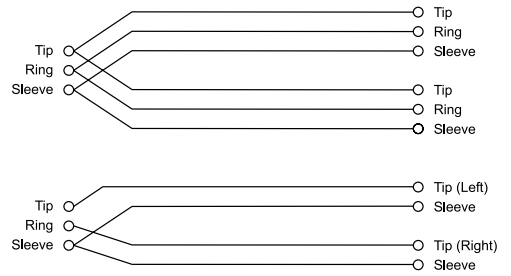
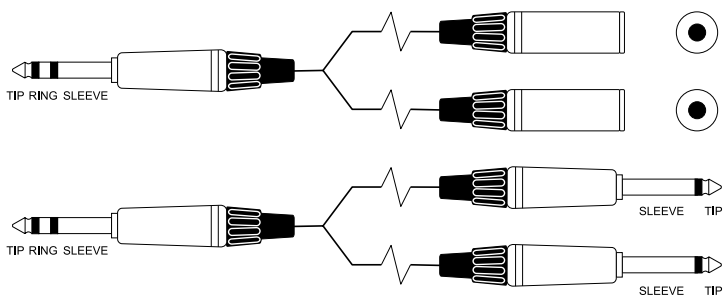

'Y' Cables (Unbalanced)

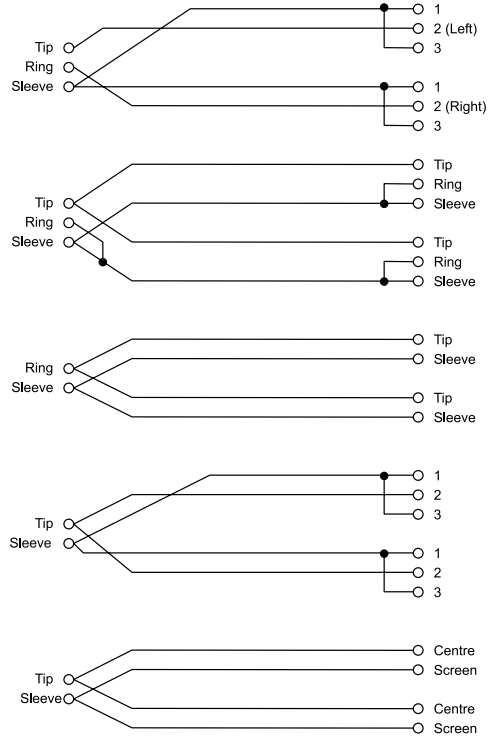
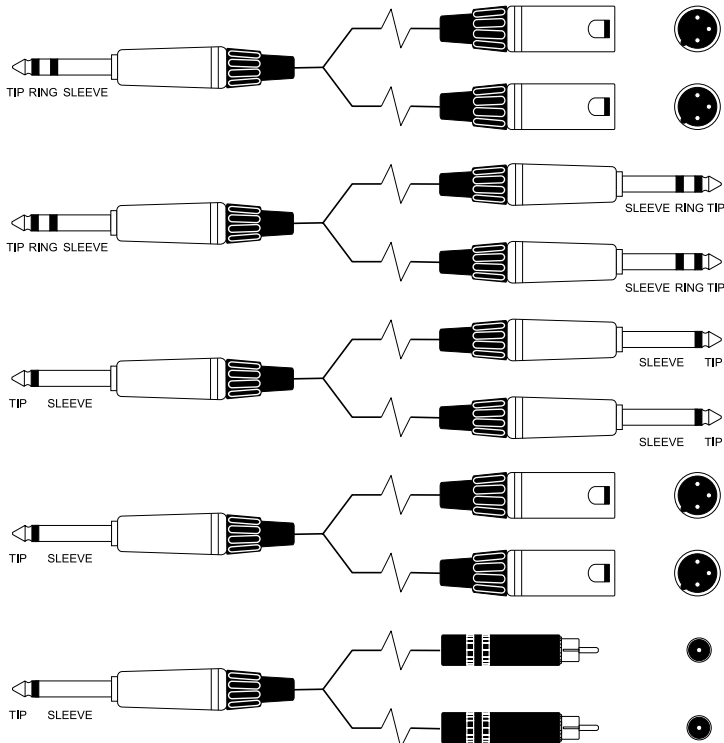

NOTEPAD 124/124FX TYPICAL SPECIFICATIONS

Frequency Response

Mic / Line Input to any Output+1/-1.5dB, 20Hz - 20kHz

T.H.D.

Mic Sensitivity -30dBu, +10dBu @ Mix output, 22Hz-22kHz.....< 0.005%
@ 1kHz

Noise

Mic Input E.I.N. (maximum gain)-128.5dBm (150Ω source)
Aux, Mix and Masters (@ 0dB, at unity).....< -85dBu

Crosstalk (@ 1kHz)

Channel Faders cut.....> 87dB
Master Faders cut.....>100dB

CMRR

@1kHz.....>90dB

EQ

High Pass Filter.....100Hz @ 12db/Octave
HF10kHz, +/-15dB
MF.....1kHz, +/-15dB
LF.....80Hz, +/-15dB
Q.....0.7

Power Consumption.....Less than 40W

Operating Conditions

Temperature Range.....5°C to 40°C

Input & Output Levels

Mic Input+10dBu max
Line Input.....+22dBu max
Stereo Input+20dBu max
Mix Output+25dBu max
Headphones (@32Ω)300mW

Input & Output Impedances

Mic Input2kΩ
Line Input18kΩ
Stereo Input20kΩ
Outputs150Ω
E & OE.

Soundcraft reserves the right to change specifications without notice. July2009

WARRANTY

- 1 Soundcraft is a trading division of Harman International Industries Ltd .
End User means the person who first puts the equipment into regular operation.
Dealer means the person other than Soundcraft (if any) from whom the End User purchased the Equipment, provided such a person is authorised for this purpose by Soundcraft or its accredited Distributor.
Equipment means the equipment supplied with this manual.
- 2 If within the period of twelve months from the date of delivery of the Equipment to the End User it shall prove defective by reason only of faulty materials and/or workmanship to such an extent that the effectiveness and/or usability thereof is materially affected the Equipment or the defective component should be returned to the Dealer or to Soundcraft and subject to the following conditions the Dealer or Soundcraft will repair or replace the defective components. Any components replaced will become the property of Soundcraft.
- 3 Any Equipment or component returned will be at the risk of the End User whilst in transit (both to and from the Dealer or Soundcraft) and postage must be prepaid.
- 4 This warranty shall only be valid if:
 - a) the Equipment has been properly installed in accordance with instructions contained in Soundcraft's manual; and
 - b) the End User has notified Soundcraft or the Dealer within 14 days of the defect appearing; and
 - c) no persons other than authorised representatives of Soundcraft or the Dealer have effected any replacement of parts maintenance adjustments or repairs to the Equipment; and
 - d) the End User has used the Equipment only for such purposes as Soundcraft recommends, with only such operating supplies as meet Soundcraft's specifications and otherwise in all respects in accordance with Soundcraft's recommendations.
- 5 Defects arising as a result of the following are not covered by this Warranty: faulty or negligent handling, chemical or electro-chemical or electrical influences, accidental damage, Acts of God, neglect, deficiency in electrical power, air-conditioning or humidity control.
- 6 The benefit of this Warranty may not be assigned by the End User.
- 7 End Users who are consumers should note their rights under this Warranty are in addition to and do not affect any other rights to which they may be entitled against the seller of the Equipment.

GLOSSARY

AFL	After-fade listen: a function that allows the operator to monitor the post-fade signal in a channel independently of the main mix.
Auxiliary send	An output from the console comprising a mix of signals from channels derived independently of the main stereo mix.
Balance	The relative levels of the left and right channels of a stereo signal.
Balanced	A method of audio connection which 'balances' the signal between two wires, these wires also have a screen which carries no signal. Any interference is picked up equally by the two wires, which results in cancellation of the unwanted signal. In this guide, the term can refer to various circuit architectures. Connection details are given in relevant sections.
Clipping	The onset of severe distortion in the signal path, usually caused by the peak signal voltage being limited by the circuit's power supply voltage.
DAT	Digital Audio Tape, a cassette-based digital recording format.
dB (decibel)	A ratio of two voltages or signal levels, expressed by the equation $\text{dB}=20\text{Log}_{10} (V1/V2)$. Adding the suffix 'u' denotes the ratio is relative to 0.775V RMS.
DI(direct injection) DI Box	The practice of connecting an electric musical instrument directly to the input of the mixing console, rather than to an amplifier and loudspeaker which is covered by a microphone feeding the console.
Equaliser	A device that allows the boosting or cutting of selected bands of frequencies in the signal path.
Fader	A linear control providing level adjustment.
Feedback	The 'howling' sound caused by bringing a microphone too close to a loudspeaker driven from its amplified signal.
Foldback	A feed sent back to the artistes via loudspeakers or headphones to enable them to monitor the sounds they are producing.
Frequency response	The variation in gain of a device with frequency.
Gain	The amount of amplification in level of the signal.
Headroom	The available signal range above the nominal level before clipping occurs.
Impedance balancing	A technique used on unbalanced outputs to minimise the effect of hum and interference when connecting to external balanced inputs.
Insert	A break point in the signal path to allow the connection of external devices, for instance signal processors or other mixers at line level signals. Nominal levels can be anywhere between 0dBu to +6dBu, usually coming from a low impedance source.
Pan (pot)	Abbreviation of 'panorama': controls the levels sent to left and right outputs.
Peaking	The point at which a signal rises to its maximum instantaneous level, before falling back down again. It can also describe an equaliser response curve affecting only a band of frequencies, (like on a graphic equaliser), peaking at the centre of that band.
Peak LED	A visual indication of the signal peaking just before the onset of clipping, which will distort the signal.
PFL	Pre-fade listen: a function that allows the operator to monitor the pre-fade signal in a channel independently of the main mix.
Phase	A term used to describe the relationship of two audio signals. In-phase signals reinforce each other, out-of-phase signals result in cancellation. Phase is a measurement of relative displacement between two waves of identical frequency.
Polarity	A term used to describe the orientation of the positive and negative poles of an audio connection. Normally connections are made with positive to positive, negative to negative. If this is reversed, the result will be out-of-phase signals (see 'phase' above).
Post-fade	The point in the signal path after a fader and therefore affected by the fader position.

Pre-fade	The point in the signal path before a fader, and therefore unaffected by the fader position.
Rolloff	A fall in gain at the extremes of the frequency response.
Shelving	An equaliser response affecting all frequencies above or below the break frequency i.e. a highpass or lowpass derived response.
Spill	Acoustic interference from other sources.
Transient	A momentary rise in the signal level.
Unbalanced	A method of audio connection which uses a single wire and the cable screen as the signal return. This method does not provide the noise immunity of a balanced input (see above).
+48V	The phantom power supply, available at the channel mic inputs, for condenser microphones and active DI boxes.

