

TASCAM[®]

TEAC PROFESSIONAL

D01053920A

202MKV

Double Auto Reverse Cassette Deck

OWNER'S MANUAL

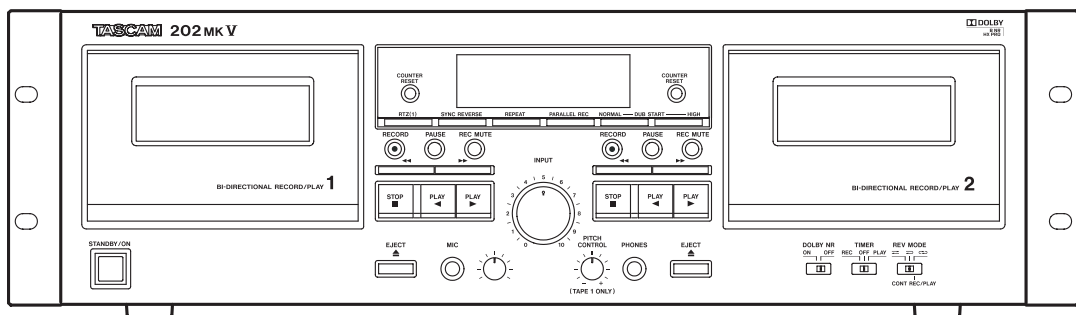

IMPORTANT SAFETY PRECAUTIONS



CAUTION: TO REDUCE THE RISK OF ELECTRIC SHOCK, DO NOT REMOVE COVER (OR BACK). NO USER-SERVICEABLE PARTS INSIDE. REFER SERVICING TO QUALIFIED SERVICE PERSONNEL.



The lightning flash with arrowhead symbol, within equilateral triangle, is intended to alert the user to the presence of uninsulated “dangerous voltage” within the product’s enclosure that may be of sufficient magnitude to constitute a risk of electric shock to persons.



The exclamation point within an equilateral triangle is intended to alert the user to the presence of important operating and maintenance (servicing) instructions in the literature accompanying the appliance.

This appliance has a serial number located on the rear panel. Please record the model number and serial number and retain them for your records.

Model number _____

Serial number _____

WARNING: TO PREVENT FIRE OR SHOCK HAZARD, DO NOT EXPOSE THIS APPLIANCE TO RAIN OR MOISTURE.

For U.S.A.

TO THE USER

This equipment has been tested and found to comply with the limits for a Class B digital device, pursuant to Part 15 of the FCC Rules. These limits are designed to provide reasonable protection against harmful interference in a residential installation. This equipment generates, uses, and can radiate radio frequency energy and, if not installed and used in accordance with the instruction manual, may cause harmful interference to radio communications.

However, there is no guarantee that interference will not occur in a particular installation. If this equipment does cause harmful interference to radio or television reception, which can be determined by turning the equipment off and on, the user is encouraged to try to correct the interference by one or more of the following measures.

- a) Reorient or relocate the receiving antenna.
- b) Increase the separation between the equipment and receiver.
- c) Connect the equipment into an outlet on a circuit different from that to which the receiver is connected.
- d) Consult the dealer or an experienced radio/TV technician for help.

CAUTION:

Changes or modifications to this equipment not expressly approved by TEAC CORPORATION for compliance could void the user's authority to operate this equipment.

IMPORTANT SAFETY INSTRUCTIONS

- 1 Read these instructions.
- 2 Keep these instructions.
- 3 Heed all warnings.
- 4 Follow all instructions.
- 5 Do not use this apparatus near water.
- 6 Clean only with dry cloth.
- 7 Do not block any ventilation openings. Install in accordance with the manufacturer's instructions.
- 8 Do not install near any heat sources such as radiators, heat registers, stoves, or other apparatus (including amplifiers) that produce heat.
- 9 Do not defeat the safety purpose of the polarized or grounding-type plug. A polarized plug has two blades with one wider than the other. A grounding type plug has two blades and a third grounding prong. The wide blade or the third prong are provided for your safety. If the provided plug does not fit into your outlet, consult an electrician for replacement of the obsolete outlet.
- 10 Protect the power cord from being walked on or pinched particularly at plugs, convenience receptacles, and the point where they exit from the apparatus.
- 11 Only use attachments/accessories specified by the manufacturer.
- 12 Use only with the cart, stand, tripod, bracket, or table specified by the manufacturer, or sold with the apparatus. When a cart is used, use caution when moving the cart/apparatus combination to avoid injury from tip-over.
- 14 Refer all servicing to qualified service personnel. Servicing is required when the apparatus has been damaged in any way, such as power-supply cord or plug is damaged, liquid has been spilled or objects have fallen into the apparatus, the apparatus has been exposed to rain or moisture, does not operate normally, or has been dropped.
 - Do not expose this apparatus to drips or splashes.
 - Do not place any objects filled with liquids, such as vases, on the apparatus.
 - Do not install this apparatus in a confined space such as a book case or similar unit.
 - The apparatus draws nominal non-operating power from the AC outlet with its STANDBY/ON in the Standby position.
 - The apparatus should be located close enough to the AC outlet so that you can easily grasp the power cord plug at any time.
 - The main plug is used as the disconnect device; the disconnect device shall remain readily operable.
 - An apparatus with Class I construction shall be connected to an AC outlet with a protective grounding connection.
 - Batteries (battery pack or batteries installed) shall not be exposed to excessive heat such as sunshine, fire or the like.
 - Excessive sound pressure from earphones and headphones can cause hearing loss.



- 13 Unplug this apparatus during lightning storms or when unused for long periods of time.

■ Beware of condensation

If the unit is moved from a cold to a warm place, or used after a sudden temperature change, there is a danger of condensation; vapor in the air could condense on the internal mechanism, making correct operation impossible.

To prevent this, or if this occurs, let the cassette deck sit for one or two hours at the new room temperature before using.

Contents

1 – Introduction	5	Adjusting mix recording level	19
Supplied accessories	5	Continuous recording	19
Rack-mounting the unit.....	5	Parallel recording	20
About this manual	5	Dubbing (from TAPE 1 to	
Precautions and notes for place-		TAPE 2)	21
ment and use	6	Editing during dubbing (only at	
About cassette tapes	6	normal speed)	22
Cassette tapes that you should not		Synchro reverse dubbing (from	
use	6	TAPE 1 to TAPE 2)	22
Automatic tape type detection		Timer playback	23
function.....	7	Playback.....	23
Tape slack.....	7	Timer-controlled recording	24
Accidental erasure prevention		Connections with a timer	24
tabs.....	7		
Maintenance.....	7	5 – Reference and	
Cleaning the heads	7	specifications	25
Connections	8	Troubleshooting	25
		Specifications	26
2 – Features of the 202MKV	9	Dimensional drawing.....	26
Front panel.....	9		
Rear panel	10		
Display.....	11		
3 – Playback.....	12		
Playback 1 (either TAPE 1 or			
TAPE 2)	12		
Playback 2 (either TAPE 1 or			
TAPE 2)	13		
Continuous playback.....	14		
RTZ (TAPE 1 only)	14		
A-B Repeat playback	15		
4 – Recording	16		
Recording (either TAPE 1 or			
TAPE 2)	16		
To erase recordings	17		
Quick record start.....	17		
Recording silence	18		
To create a blank of more than 4			
seconds long	18		
To create a blank of less than 4			
seconds long	18		
Mic mixing recording	18		

1 – Introduction

Thank you for your purchase of the TASCAM 202MKV Double Auto Reverse Cassette Deck.

Before connecting and using the unit, please take time to read this manual thoroughly to ensure you understand how to properly set up and connect the 202MKV, as well as the operation of its many useful and convenient functions. After you have finished reading this manual, please keep it in a safe place for future reference.

Dolby NR

Dolby NR is designed to reduce tape hiss, a noise introduced during the recording and playback processes. This cassette deck is equipped with Dolby B-type Noise Reduction.

The Dolby NR system affects both recording and playback quality. In playback, be sure to set the DOLBY NR switch to the same position used when the recording was made.

Manufactured under license from Dolby Laboratories. HX Pro headroom extension originated by Bang & Olufsen. Dolby, HX Pro, and the double-D symbol are trademarks of Dolby Laboratories.

Supplied accessories

In addition to this manual, the 202MKV has been packed with the following:

- A rack-mounting screw kit (screws and washers) ..1
- A warranty card1

Contact your TASCAM supplier if any of these items are missing.

Rack-mounting the unit

If you are mounting the unit in a rack, leave 1U of space above it and 4 inch (10 cm) or more of space at the rear.

Use the rack-mounting kit to mount the unit in a standard 19-inch equipment rack, as shown in this section. Remove the feet of the unit before mounting.

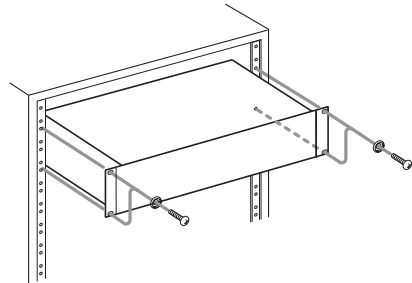

About this manual

In this manual, we use the following conventions:

- The names of keys and controls are given in the following typeface: **EJECT**.
- The alphanumeric portion of the display shows a message, this is shown in the following typeface: **CP01**.
- If a preset indicator in the display (i.e. one which cannot change, but is either on or off) is shown, this is shown as follows: **PARALLEL**.

1 – Introduction

Precautions and notes for placement and use

The 202MKV may be used in most areas, but to maintain top performance, and prolong operating life, observe the following notes, precautions and environmental conditions:

- Avoid exposing it to extremes of temperature and humidity and avoid mechanical shocks and vibration.
- Keep the unit away from strong magnetic fields (TV sets, computer monitors, large electric motors, etc.).
- The nominal temperature should be between 5°C and 35°C (41°F and 95°F).
- Relative humidity should be 30 to 90 percent.
- As the unit may become hot during operation, always leave sufficient space above the unit for ventilation. Do not install this unit in a confined space such as a bookcase, and do not put anything on top of the unit.
- Avoid installing this unit on top of any heat-generating electrical device such as a power amplifier.
- Make sure that the unit is mounted in a level position for correct operation.

- Do not open the sealed cabinet as this might result in damage to the circuitry or electrical shocks. If a foreign object should get inside the unit, contact your supplier or service agency.
- When removing the power plug from the wall outlet, always pull directory on the plug, never yank the cord.
- The voltage selector on the rear panel is only available on units for the North American market. Please set this to match your local supply. If you are in any doubt in this matter, consult an electrician

NOTE

When transporting the unit, always use the original packing materials. For this reason, we strongly recommend that you save all the packing materials that came with the 202MKV, in case you need to transport it in the future. In addition, when transporting the unit, you should tape the cassette decks closed, using an adhesive tape that will not spoil the finish of the unit.

About cassette tapes

CAUTION

- *Do not open the cassette or pull the tape out of the cassette.*
- *Do not touch the tape surface.*
- *Do not use or store the tape in a humid or dusty place.*

- *Keep the tape away from any magnetic sources, such as speakers or TVs, otherwise noise may be produced during playback or important recordings may be erased.*

Cassette tapes that you should not use

Poor performance, errors, or malfunctions may result if you use any of the tapes described below. Some of these tapes may also cause tape clog problems that can damage the tape transport mechanism.

Cassettes that are imperfectly shaped

Do not use a deformed cassette or one that has unstable tape movement or makes a strange sound during fast-forward or rewind.

Long play tapes

Tapes that are longer than 90 minutes are very thin and stretch easily, so using them can result in wow and flutter. In addition, long tapes can become tangled in the equipment, so please use caution with them.

Endless tapes

Do not use these tapes because they can easily get tangled in the tape transport mechanism.

1 – Introduction

Automatic tape type detection function

This cassette deck can detect what type of tape is being used based on the detection holes in the cassette shell. Be sure to use cassettes with detection holes.

With this cassette deck, you can play back normal (Type I), chrome (Type II) and metal (Type IV) tapes. For recording, use normal (Type I) or chrome (Type II) tapes.

Each deck (TAPE 1 and TAPE 2) is equipped with its own auto tape type detection function, so you can use

different types of tape at the same time.

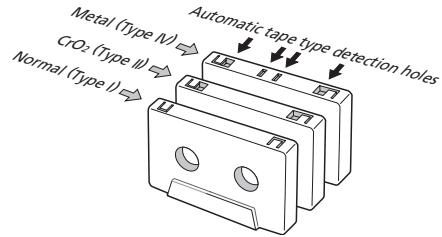

Tape slack

Slack can cause the tape to get tangled in the capstan or other rotating parts. To prevent this, take up all tape slack using a pencil or the like inserted into the reel hole.

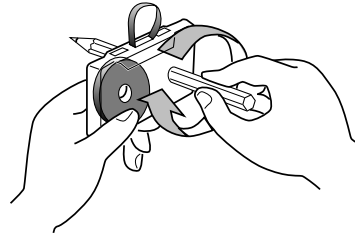

Accidental erasure prevention tabs

Tabs on top of the cassette shell allow you to prevent important recordings from being erased by mistake. There are two tabs on each cassette shell: one for side "A" and the other for side "B".

Once these tabs have been removed using a screwdriver or the like, there is absolutely no chance of the recording function being activated.

To record on a cassette whose tab has been broken off, stick a piece of adhesive tape over the hole. Be careful not to block the tape type detection holes.

Accidental erasure prevention tab for side "A"

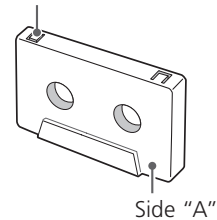

Maintenance

If the surface of the deck becomes soiled, wipe it clean with a dry, soft cloth. Never use volatile cleaners like thinners, benzine or alcohol because they will damage the surface finish.

Do not allow the deck to remain in contact with rubber or vinyl products for a long period of time, as these could damage the surface finish.

CAUTION

For safety, always unplug the power cord before performing any maintenance.

■ Cleaning the heads

If the head section gets dirty, the recording quality will deteriorate, resulting in degraded playback sound or "drops" in sound. Also, if the tape transport path gets dirty, the tape may get entangled in the rotating parts. It is therefore recommended that the heads, pinch rollers and capstans be cleaned regularly at intervals of 10-hour use with a cotton swab moistened with a commercially available, appropriate cleaning liquid.

1 – Introduction

NOTE

Do not make a recording or play back tape when the tape transport path is wet with cleaning liquid, as this could cause the tape to jam or clog.

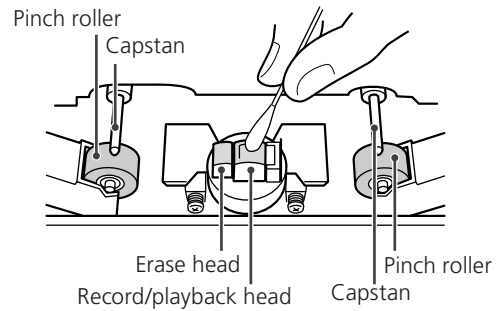

Connections

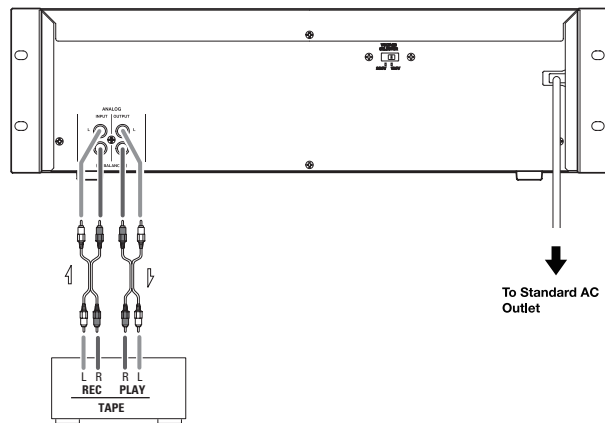

CAUTION

- *Plug the power cord into an AC outlet only after having made all other connections.*
- *Read the instructions of each component you intend to use with this unit.*

Use RCA cables to make connections between this unit and your amplifier. Make sure to connect:

White plug to White jack (L: left channel)

Red plug to Red jack (R: right channel)

NOTE

Plugs must be firmly inserted into the corresponding jacks. Do not bundle the RCA cables together with the power cord and speaker cables. Doing so will degrade sound quality or generate noise.

Plug this AC power cord into an AC wall socket.

NOTE

- *Hold the power plug when plugging or unplugging the power cord. Never pull or yank on the power cord.*
- *Unplug the power cord when you are not going to use the unit for some time.*

2 – Features of the 202MKV

Front panel

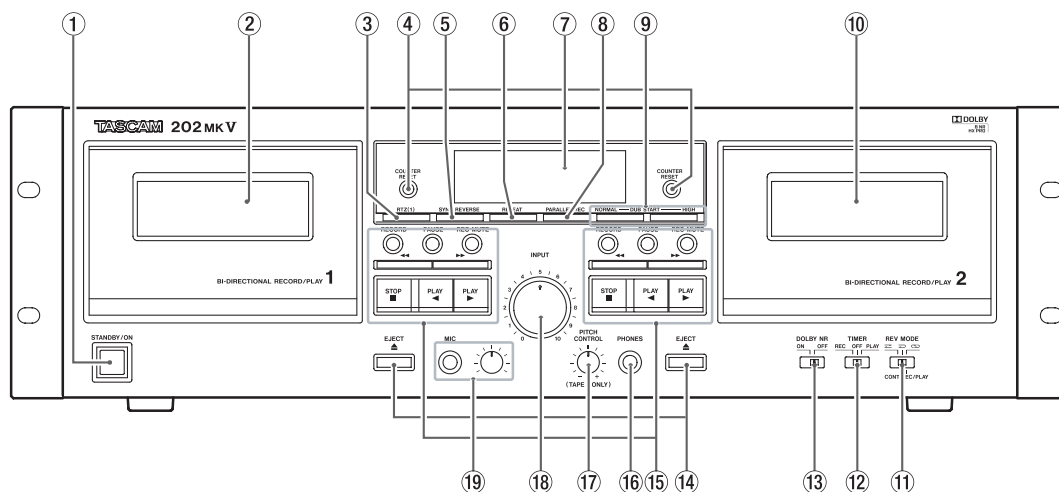

① STANDBY/ON switch

This switches the unit power between standby and on.

NOTE

The apparatus draws nominal non-operating power from the AC outlet with its STANDBY/ON in the Standby position.

② TAPE 1 compartment

③ RTZ key (TAPE 1 only)

This key returns the tape to the counter zero point.

④ COUNTER RESET keys

Pressing these keys reset the tape counter readings for TAPE 1 and TAPE 2, respectively.

⑤ Synchro reverse key (SYNC REVERSE)

Pressing this key activates the synchro reverse dubbing function.

⑥ REPEAT key

This allows repeat playback of a selected section of the tape.

⑦ Display

This shows tape counters, level meters, etc.

⑧ Parallel record key (PARALLEL REC)

This key lets you simultaneously record on both decks.

⑨ Dubbing start key (DUB START)

This key is used when copying the contents of a tape from TAPE 1 to TAPE 2, either at normal or high speed.

⑩ TAPE 2 compartment

⑪ Reverse mode switch (REV MODE)

This switch is used to switch between reverse modes.

⑫ TIMER switch

This switch is provided for use with a commercially available audio timer, to allow timer controlled recording or playback.

Normally, leave this switch to the OFF position.

⑬ DOLBY NR switch

This switch toggles the Dolby Noise Reduction system on/off. In playback you need to set this switch to the same position as when the recording was made.

⑭ EJECT (▲) keys

Pressing these keys opens the TAPE 1 and TAPE 2 compartments.

⑮ Tape transport control keys

RECORD (●) key

Pressing this key shifts the corresponding deck to record-pause mode.

PAUSE key

Pressing this key temporarily stops playback or recording.

Recording mute (REC MUTE) key

This key is for creating the 4-second blank space.

2 – Features of the 202MKV

◀◀/▶▶ key

Fast-forward/Rewind

STOP (■) key

Stop of playback/record

PLAY (◀ / ▶) key

Reverse side play/Forward side play

⑩ Headphones jack (PHONES)

Plug your headphones into this jack.

⑪ PITCH CONTROL

This control is used to vary the playback speed.

⑫ INPUT control

This control is used to adjust the recording level.

⑬ MIC jack and level control

Insert your microphone into this jack and use the knob to adjust the level of mic input.

NOTE

The MIC jack is mono. You cannot use a stereo microphone with this cassette deck.

Rear panel

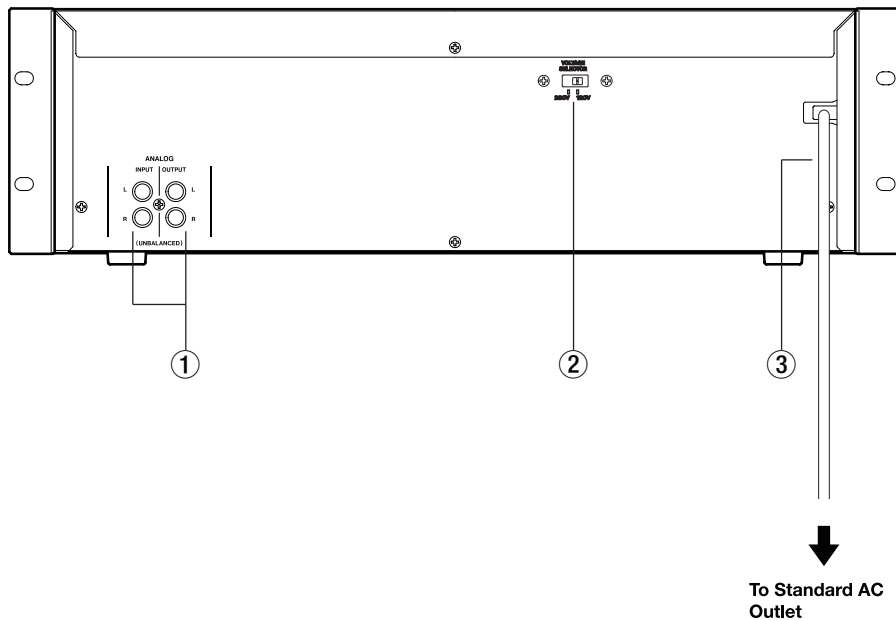

① LINE IN and LINE OUT jacks

Use RCA cables to make connections between this unit and your amplifier. Make sure to connect:

White plug to White jack (L: left channel)

Red plug to Red jack (R: right channel)

② VOLTAGE SELECTOR

Switches the voltage to either 230 V or 120 V.

NOTE

- *The voltage selector is not available on units for some markets.*

IN NORTH AMERICA
USE ONLY ON 120V SUPPLY

③ AC power cord

Plug this AC power cord into an AC wall socket.

2 – Features of the 202MKV

Display

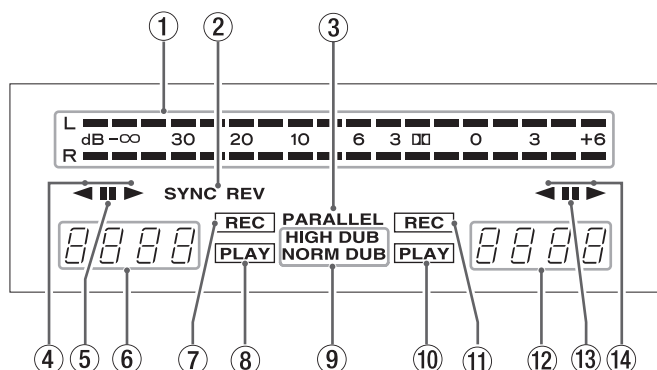

- ① **Peak level meter**
This shows recording and playback levels.
- ② **SYNC REV**
This indicator lights when the synchro reverse dubbing function is switched on.
- ③ **PARALLEL**
This indicator lights to indicate parallel recording is taking place.
- ④ **Playback/recording direction indicator of TAPE 1 deck**
- ⑤ **Pause indicator**
This indicator lights when the TAPE 1 deck is temporarily stopped.
- ⑥ **Tape counter of TAPE 1 deck**
The tape counter indicates the relative position of the tape. You can reset the counter to zero whenever you want.
When an A-B repeat operation is on, RE is shown.
- ⑦ **Record indicator**
This indicator lights when the TAPE 1 deck is in record mode.
- ⑧ **Play indicator**
This indicator lights when the TAPE 1 deck is in play mode.
- ⑨ **Dubbing indicator**
NORMAL DUB lights during normal speed dubbing, and **HIGH DUB** lights during high speed dubbing.
- ⑩ **Play indicator**
This indicator lights when the TAPE 2 deck is in play mode.
- ⑪ **Record indicator**
This indicator lights when the TAPE 2 deck is in record mode.
- ⑫ **Tape counter of TAPE 2 deck**
The tape counter indicates the relative position of the tape. You can reset the counter to zero whenever you want.
When an A-B repeat operation is on, RE is shown.
- ⑬ **Pause indicator**
This indicator lights when the TAPE 2 deck is temporarily stopped.
- ⑭ **Playback/recording direction indicator of TAPE 2 deck**

3 – Playback

Playback 1 (either TAPE 1 or TAPE 2)

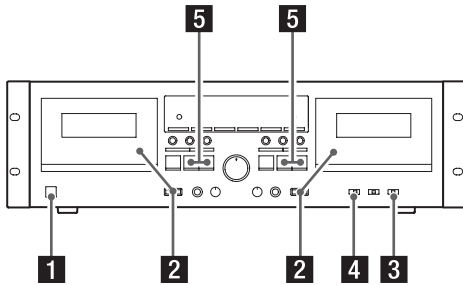

1. Switch on the STANDBY/ON.



2. Load a pre-recorded tape into the TAPE 1 or 2 deck.

Press the EJECT key (▲) to open the cassette compartment. Insert the cassette tape with its open edge facing down, the desired side facing you. Then, close the cassette compartment by pushing on its front part.

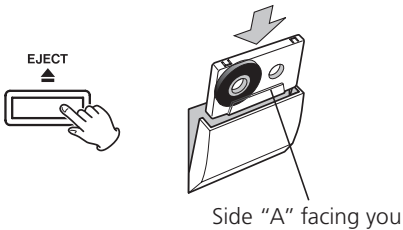

This cassette deck can play back Normal (Type I), Chrome (Type II) and Metal (Type IV) tapes.

For the sake of simplicity, we refer to the tape side facing you as Side “A” and to the tape side facing away as Side “B”. When you insert a cassette with Sides “A” and “B” reversed, Side “A” should read Side “B” and Side “B” should read Side “A”.

3. Select a reverse mode setting using the REV MODE switch.

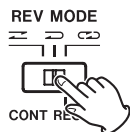

You have a choice of three settings:

: **One way mode**

Set the switch to this position to playback only one side.

: **Two way mode**

Set the switch to this position to play back both sides of the tape in one session. When playback reaches the end of side “A”, the playback direction is automatically reversed, and playback continues on side “B”.

: **Repeat mode**

Set the switch to this position. Both sides of the tape are played back as many as 5 times.

4. Set the DOLBY NR switch.

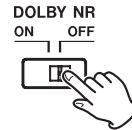

Set the switch to the ON position when playing back tapes recorded with Dolby NR.

To play tapes recorded without Dolby NR, set the switch to the OFF position.

5. Press the PLAY (◀ or ▶) key.

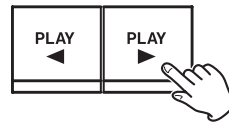

Pressing the ▶ key starts playback from side “A”.

Pressing the ◀ key starts playback from side “B”.

3 – Playback

Playback 2 (either TAPE 1 or TAPE 2)

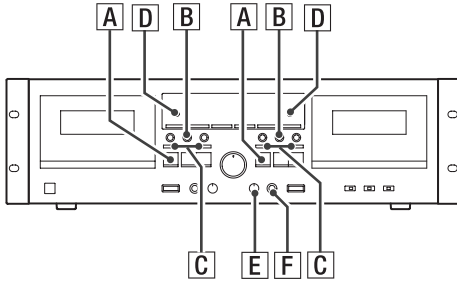

- A. To stop playback, press the STOP (■) key.

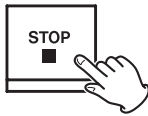

- B. To stop playback temporarily, press the PAUSE key. To resume playback, press the PAUSE key again, or press the PLAY (◀ or ▶) key.



While playback is paused, pressing the PLAY key whose direction is opposite to the indicator (◀ or ▶) on the display, will switch the playback direction. This does not release the pause function. Press PAUSE or the same play key (◀ or ▶) again to start playback on the other side of the tape.

- C. Fast forward/Rewind

Press the ◀◀ or ▶▶ key while in stop mode to fast wind the tape.



To stop the fast winding tape, press the STOP (■) key.

- D. Tape counter

Press the COUNTER RESET key to reset the tape counter to 0000. You can use this function for easy relocation of any desired point on the tape.

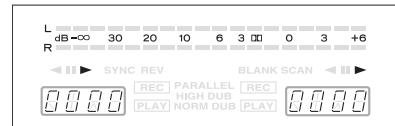

- E. Pitch control (TAPE 1 deck only)

This control varies the pitch of the music during playback (This control does not work during recording or dubbing).

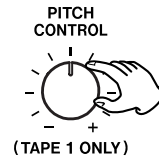

Turning the PITCH CONTROL knob clockwise increases the playback speed and raises the pitch up to +10%.

Turning the PITCH CONTROL knob counter-clockwise reduces the playback speed and lowers the pitch by a maximum of -10%.

- F. To listen through headphones

WARNING

There is no level control for the headphones output. Beware that sudden loud sounds may occur depending on recorded material. You should avoid prolonged exposure to high volume sound as this can damage your hearing.

Plug your headphones into the PHONES jack, and put on the headphones.

Plugging into the PHONES jack does not disable the line outputs.

3 – Playback

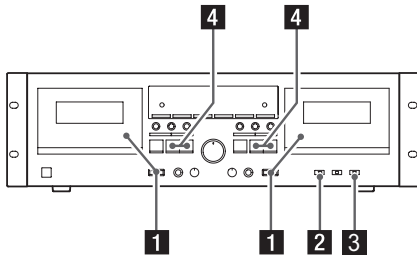

Continuous playback

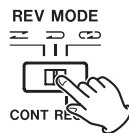

Continuous playback can be performed between TAPE 1 and TAPE 2. When one tape is played back to the end, the other tape automatically starts playback, in a relay fashion.

1. Load pre-recorded tapes into the TAPE 1 and TAPE 2 compartments.
 2. Set the DOLBY NR switch.
- Always set the DOLBY NR switch to the same position that was used for recording.
3. Set the REV MODE switch to the  (CONT PLAY) position.



4. Press the PLAY ( or ) key of the deck you want to start first.

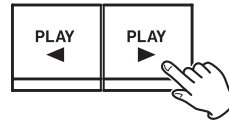

You can start continuous playback from either TAPE 1 or TAPE 2.

Playback cycles through four tape sides as follows, and will continue as many as 5 times when you start the playback from Side “A” on TAPE 1, or until you stop the operation.

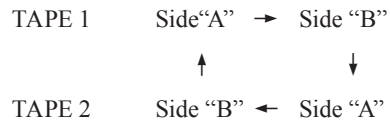

RTZ (1) (TAPE 1 only)

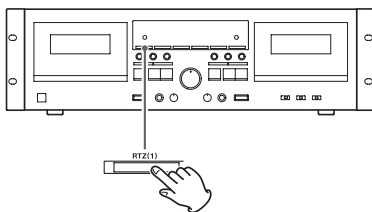

Press the RTZ (1) key to locate to the “0000” position.

NOTE

- RTZ (Return-to-zero) only works on TAPE1.
- If the counter position is too close to the 0000 mark (greater than 9994 or less than 0005), the RTZ function cannot be used.

A-B Repeat playback

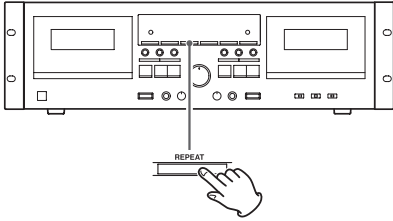

1. During playback, press the REPEAT key at the point where you want to start the repeat playback interval (A point). RE appears on the display when this point is set.
2. Next, press the REPEAT key at the point where you want to end the repeat playback interval (B point).

The tape automatically rewinds to the A point where playback restarts. When the B point is reached, playback stops temporarily, the tape rewinds again to the A point, and playback continues to repeat.

3. Press the STOP (■) key to end repeat playback.

CAUTION

- During repeat playback, only the REPEAT and STOP keys can be used.
- This function cannot be used for durations of less than 10 counts on the tape counter between the starting and end points.
- Only intervals in the current playback direction can be repeated.
- Repeat playback stops automatically after 20 repetitions.

4 – Recording

Recording (either TAPE 1 or TAPE 2)

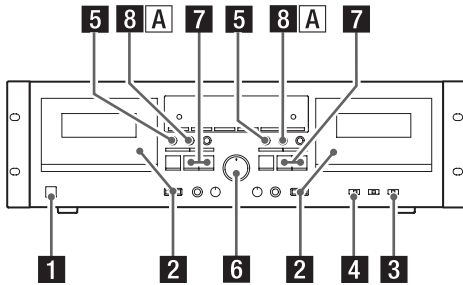

1. Turn on the power.



2. Load a tape for recording.

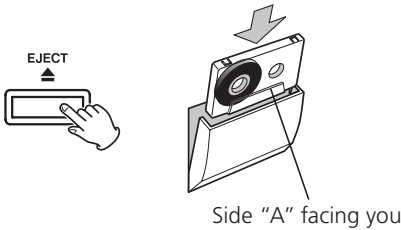



Press the EJECT () key to open the cassette compartment. Insert the cassette tape with its open edge facing down, side “A” facing you. Then close the cassette compartment by pushing in the cassette door until it clicks shut.

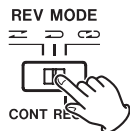

NOTE

- If the erasure prevention tabs of the loaded cassette tape have been broken off, stick a piece of adhesive tape over the hole(s).
- With this cassette deck you can use Normal (Type I) and Chrome (Type II) tapes for recording.

3. Set the REV MODE switch.



: Set to this position to record on one side only.

 or : Set to either of these positions to record on both sides.

4. Set the DOLBY NR switch.

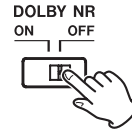



Set the switch to **ON** to record with Dolby Noise Reduction.

Set to **OFF** to record without Dolby Noise Reduction.

5. Press the RECORD (●) key.



The deck enters the record-pause mode.  and  will light on the display.



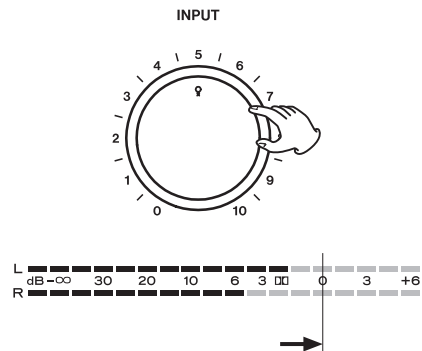

6. Adjust the recording level.



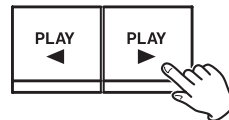

Start playback of your recording source and set the INPUT control knob so that the level meter indicates “0 dB” at peaks.

7. Set the recording direction.



Recording is made in the direction indicated by the play/record direction indicator ( or ). To change this direction, press the opposite direction PLAY ( or ) key.





NOTE

Be careful not to press the PLAY ( or ) key whose arrow points in the same direction as the indicator. Doing so will start recording.

4 – Recording

8. When everything is ready, start recording by pressing the **PAUSE** key or the **PLAY** key whose arrow points in the same direction as the indicator.



To record on both tape sides, set the **REV MODE** switch to  or  and press the forward **PLAY** () key. If you press the reverse **PLAY** () key, recording will be done only on side “B”.

To stop recording, press the **STOP** () key.



- A To stop recording temporarily



Press the **PAUSE** key to stop recording temporarily.



A second press of the key resumes recording.

To erase recordings

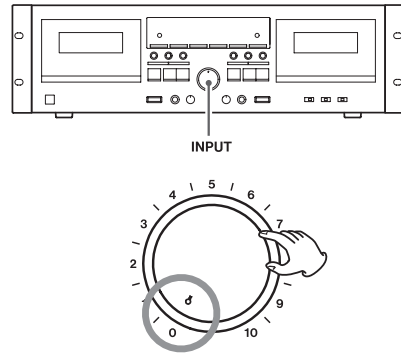
When you make a recording, the tape is overwritten (previous recording is erased). To erase a tape without making a new recording, set the **INPUT** control to the minimum (0) position and press the **RECORD** () key followed by the **PLAY** ( or ) key.



Quick record start

Hold down the **RECORD** () key and press the **PLAY** ( or ) key corresponding to the direction you want the tape to run.

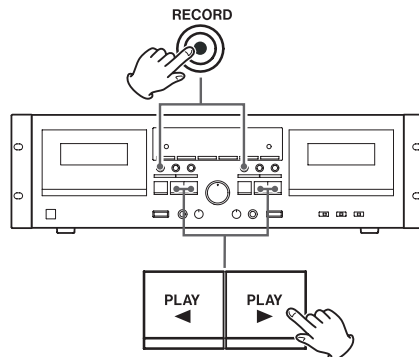

4 – Recording

Recording silence

When you press the **REC MUTE** key during recording, the unit records no signal for about 4 seconds and then enters the record-pause mode. To resume recording, press the **PAUSE** key.

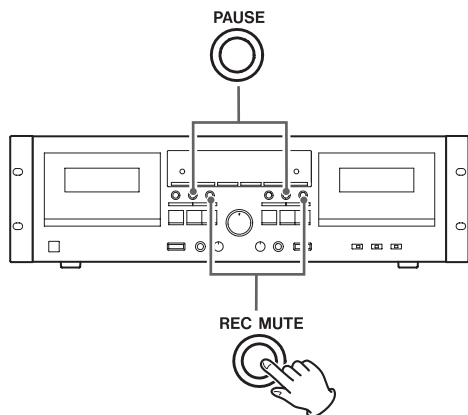

■ To create a blank of more than 4 seconds long

Hold down the **REC MUTE** key for the desired length of time. When you release the key, the deck enters the record-pause mode.

■ To create a blank of less than 4 seconds long

Press the **PAUSE** key within 3 seconds of pressing the **REC MUTE** key.

NOTE

*If you press the **REC MUTE** key when the deck is in the record-pause mode, no signal is recorded for about 4 seconds, and then the deck shifts back to the record-pause mode.*

Mic mixing recording

This function allows you to record your voice and another audio source together on a cassette tape.

The mic sound is fed into both the Left and Right channels so it is located in the center of the stereo image.

You have the choice of either selecting the audio source you want on the amplifier connected to the **LINE IN** jacks of the deck, or plugging the desired source directly into the deck's **LINE IN** jacks.

NOTE

- *To prevent feedback (howling), disable the speaker outputs from the amplifier. Use headphones to monitor recording.*
- *This cassette deck is not compatible with stereo mics. Always use a mono mic.*

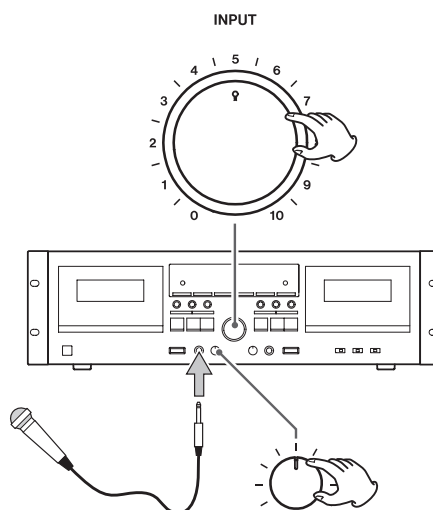

4 – Recording

Adjusting mix recording level

To record a mix of voice and another audio source, you need to adjust the mic input level and then fine tune the overall recording level.

1. Plug your microphone into the MIC jack on the front panel.
2. Start playing the audio source, switch the deck into the record-pause mode (by pressing the RECORD (●) key), and temporarily adjust the INPUT control to a relatively low level.
3. Speak into the mic and adjust the MIC level control to get the optimum balance between your voice and the other source.
4. Fine tune the overall recording level using the INPUT control so that the level meter reads 0 dB at peaks.
5. When everything is ready, start recording as instructed earlier in this manual.

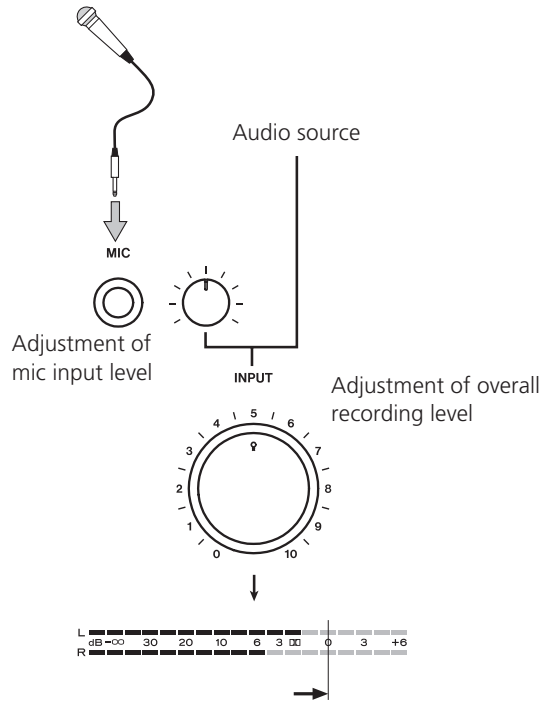

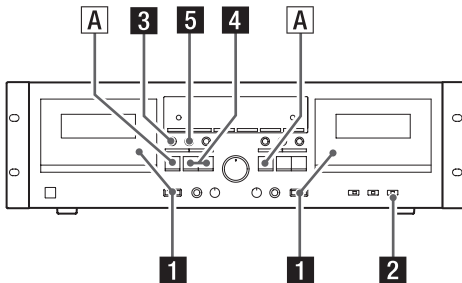

Continuous recording

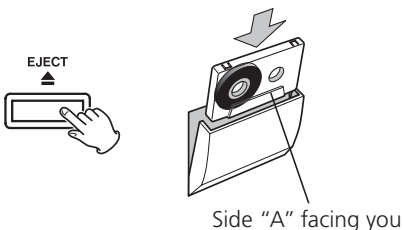

This function allows you to make uninterrupted recordings on both sides of two tapes.

1. Load cassette tapes for recording into the TAPE 1 and TAPE 2 compartments.



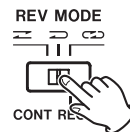

2. Set the REV MODE switch to the  (CONT REC/PLAY) position.



Set the DOLBY NR switch to the ON position if you want to.

3. Press the TAPE 1 deck's RECORD (●) key.



The deck enters the record-pause mode.  and  will light on the display. Now adjust the recording level and any other settings, as required.

4 – Recording

4. Check the recording direction.

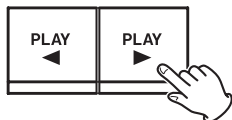

If an indicator is lit which points in the direction opposite to the one desired, change the direction by pressing the opposite direction PLAY (◀ or ▶) key.

NOTE

Be careful not to press the PLAY (◀ or ▶) key whose arrow points in the same direction as the indicator. Doing so will start recording.

Recording is done in this order:

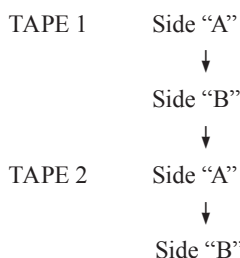

You can start recording from side “B” of TAPE 1. But if you do so, side “A” of this tape is not recorded: when recording reaches the end of side “B”, the TAPE 2 deck starts recording.

NOTE

The TAPE 2 deck always starts recording from side “A”.

5 Start recording.



Recording starts when you press the PAUSE key or the PLAY (◀ or ▶) key whose arrow points in the same direction as the indicator on the TAPE 1 deck.

When recording is finished on the TAPE 1 deck, the TAPE 2 deck automatically starts recording.

NOTE

The transition from TAPE 1 to TAPE 2 takes several seconds.

A. To stop recording

Press the STOP (■) key of the deck which is currently recording.

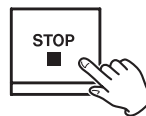

Parallel recording

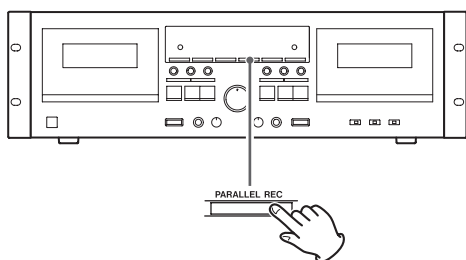

This function allows you to record the same material simultaneously on both TAPE 1 and TAPE 2.

Load tapes into both decks and press the PARALLEL REC key to start recording.

Before starting recording, check and correct the following by performing steps 1 – 7 on page 16 such as Record direction, Reverse mode setting, Dolby NR setting, Recording level, etc.

When everything is ready, get back into stop mode if the deck is in another mode.

During parallel recording, the PARALLEL indicator is lit on the display.

During parallel recording, only the following keys work:

TAPE 1 deck: STOP (■)

TAPE 2 deck: PAUSE, REC MUTE, STOP (■)

Pressing the STOP (■) key on either deck stops both tapes at once.

4 – Recording

Dubbing (from TAPE 1 to TAPE 2)

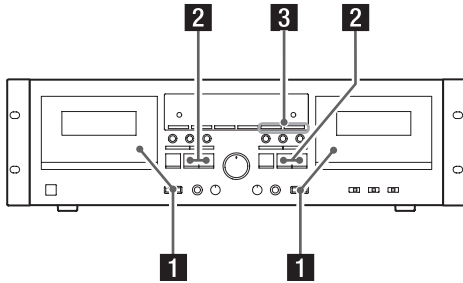

1. Insert a cassette tape for playback into the TAPE 1 compartment and a cassette tape for recording into the TAPE 2 compartment.

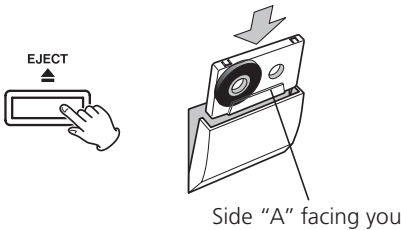

2. Set the tape transport direction on both decks.

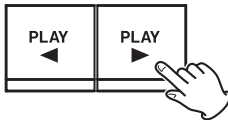

If the play/record direction indicator (◀/▶) on the display points in the direction opposite to the one desired, press the PAUSE key followed by the PLAY (◀ or ▶) key corresponding to the desired direction.

After changing the tape transport direction, be sure to press the STOP (■) key to get out of the pause mode.

NOTE

- Be careful not to press the PLAY (◀ or ▶) key whose arrow points in the same direction as the indicator. Doing so will start playback.
- Set the REV MODE switch as required.
- You don't need to adjust the recording level or set the Dolby NR system, as both depend on the pre-recorded source tape.

3. Press either DUB START key to start dubbing.

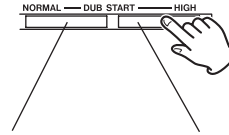

For normal speed dubbing, press the NORMAL key. For high-speed dubbing, press the HIGH key.

NOTE

High-speed dubbing makes a copy at approximately two times the normal speed. We recommend normal speed dubbing for best audio quality.

During dubbing, either the NORM DUB or HIGH DUB indicator lights steadily on the display.

During normal speed dubbing, only the following keys work:

TAPE 1 deck: STOP (■)

TAPE 2 deck: PAUSE, REC MUTE, STOP (■)

During high-speed dubbing, only the STOP (■) key works.

Pressing the STOP (■) key on either deck stops both tapes at once.

Neither DUB START key works immediately after the tape is fast-forwarded or rewound to the end.

Wait for 5 seconds or more before pressing the key.

NOTE

- During dubbing, the pitch control does not work.
- Recording level adjustment is not necessary for dubbing, as the recording level is set to the level of the pre-recorded tape. Operating the INPUT control, before or after starting dubbing, has no effect at all.
- If a nearby television set is switched on during high-speed dubbing, a high-pitched interference noise may be recorded on the tape. To avoid this, either perform dubbing at normal speed, or turn off the television.

4 – Recording

Editing during dubbing (only at normal speed)

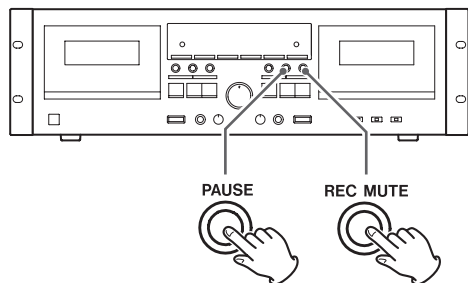

You can prevent unwanted songs or unnecessarily long blanks from being dubbed, or you can create blanks between songs.

1. At the desired point during dubbing, press the **PAUSE** key on the **TAPE 2** deck. The **TAPE 2** deck only enters the pause mode, allowing you to let unwanted songs go by.

To create a 4-second blank between songs, press the **REC MUTE** key on the **TAPE 2** deck. The **TAPE 2** deck temporarily stops after recording no signal for 4 seconds.

The **TAPE 1** deck continues playback when the **TAPE 2** deck is in pause mode.

2. To resume dubbing, press the **PAUSE** key on the **TAPE 2** deck.

Synchro reverse dubbing (from TAPE 1 to TAPE 2)

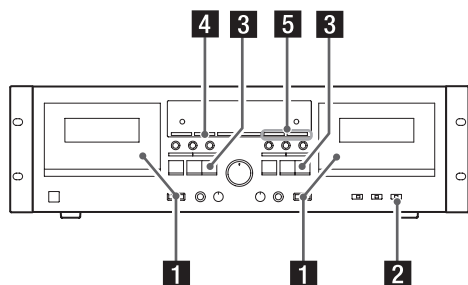

When you use this dubbing function and a shorter tape reaches the end of side “A”, it momentarily stops until the other tape reaches the end of side “A”. Then both tapes automatically switch over to side “B” and recording and playback re-start simultaneously.

If TAPE 1 is shorter than TAPE 2

When **TAPE 1** reaches the end of side “A”, **TAPE 1** stops and **TAPE 2** enters the “blank recording” mode.

When **TAPE 2** reaches the end, both **TAPE 1** and **2** are reversed simultaneously. **TAPE 1** starts reverse play and **TAPE 2** resumes recording.

When **TAPE 1** reaches the end of side “B”, both **TAPE 1** and **2** stop simultaneously.

If TAPE 1 is longer than TAPE 2

When **TAPE 2** reaches the end of side “A”, **TAPE 2** enters the record-pause mode, while **TAPE 1** continues playback.

When **TAPE 1** reaches the end, **TAPE 1** starts reverse play and **TAPE 2** starts recording.

When **TAPE 2** reaches the end of side “B”, both **TAPE 1** and **2** stop simultaneously.

1. Insert a cassette tape for playback into the **TAPE 1** compartment and a cassette tape for recording into the **TAPE 2** compartment.

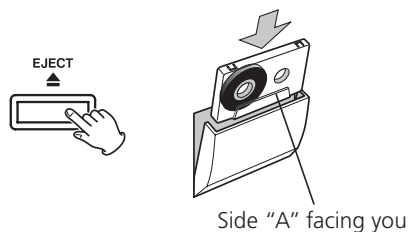

2. Set the **REV MODE** switch to the two-way (↔) position.

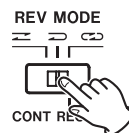

3. Check the recording direction of both decks.



If the reverse direction indicator (◀) lights on the display, press the **PAUSE** key followed by the forward **PLAY** (▶) key. Then, be sure to press the **STOP** (■) key to get out of the pause mode.

4 – Recording

NOTE

- *Be careful not to press the PLAY (◀ or ▶) key whose arrow points in the same direction as the indicator. Doing so will start playback.*
- *You do not need to adjust the recording level or set the Dolby NR system, as both depend on the pre-recorded source tape.*

4 Press the SYNC REVERSE key.

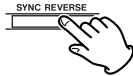

The **SYNC REV** indicator will light on the display.

The **SYNC REVERSE** key does not work if the reverse mode is set to any positions other than  or if the transport direction of both decks is set to reverse (◀).

5 Press either DUB START key to start dubbing.

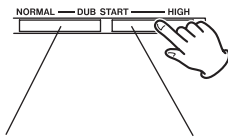

For normal speed dubbing, press the **NORMAL** key. For high-speed dubbing, press the **HIGH** key.

High-speed dubbing makes a copy at approximately two times the normal speed. We recommend normal speed dubbing for best audio quality.

During dubbing, either the **NORM DUB** or **HIGH DUB** indicator lights steadily on the display.

During normal speed dubbing, only the following keys work:

TAPE 1 deck: **STOP** (■)

TAPE 2 deck: **PAUSE**, **REC MUTE**, **STOP** (■)

During high-speed dubbing, only the **STOP** (■) key works.

Pressing the **STOP** (■) key on either deck stops both tapes at once.

Neither **DUB START** key works immediately after the tape is fast-forwarded or rewound to the end.

Wait for 5 seconds or more before pressing the key.

NOTE

- *During dubbing, the pitch control does not work.*
- *Recording level adjustment is not necessary for dubbing, as the recording level is set to the level of the pre-recorded tape. Operating the **INPUT** control, before or after starting dubbing, has no effect at all.*
- *If a nearby television set is switched on during high-speed dubbing, a high-pitched interference noise may be recorded on the tape. To avoid this, either perform dubbing at normal speed, or turn off the television.*

Timer playback

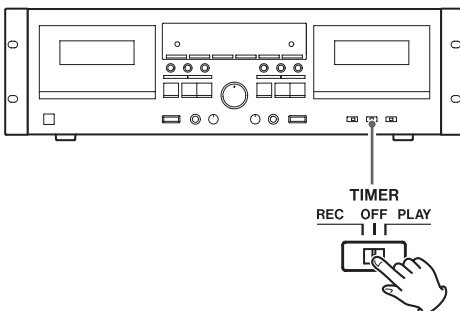

Playback

1. Connect this unit and stereo system to a commercially available audio timer.
 2. Set the power switch of all components to **ON**.
 3. Load a prerecorded cassette tape in **TAPE 1** or **2**.
- You can also insert tapes into both decks. In this case, **TAPE 1** starts first.

4 – Recording

4. Set the REV MODE switch to the required position.

To let both decks play continuously, set the REV MODE switch to the  (CONT PLAY) position.

5. Set the DOLBY NR switch.
6. Set the TIMER switch to the PLAY position.
7. Set the audio timer to the required start (power on) and stop (power off) times. When this setting is completed, the power to all components will be switched off.

When a preset start time is reached, power will be supplied and playback will start automatically.

Playback always starts from side “A”.

NOTE

If you directly connect the deck's AC power cord to the AC outlet, playback automatically starts by simply pressing on the STANDBY/ON switch of this deck when you set the TIMER switch to the PLAY position. When you do not use the timer, set the TIMER switch to the OFF position.

Timer-controlled recording

(Example: Recording a broadcast program)

1. Connect this unit and stereo system to a commercially available audio timer.
2. Set the power switch of all components to ON.
3. Load a recordable cassette tape(s) in TAPE 1 or 2 (or both decks for continuous recording).
4. Set the REV MODE switch to the required position.

For continuous recording on both decks, set the REV MODE switch to the  (CONT PLAY) position.
5. Set the DOLBY NR switch as required.
6. Tune in a broadcasting station to be recorded.
7. Press the RECORD (●) key of the deck to be recorded to set the deck to the record-pause mode.
8. Adjust the recording level.
9. Set the TIMER switch to the REC position.
10. Set the audio timer to the required start (power on) and stop (power off) times. When this set-

ting is completed, the power to all components will be switched off.

When the preset start time is reached, power will be supplied and recording will start automatically.

Recording always starts from side “A”.

CAUTION

If you directly connect the deck's AC power cord to the AC outlet, recording automatically starts by simply pressing on the STANDBY/ON switch of this deck when you set the TIMER switch to the REC position. When you do not use the timer for a while, be sure to set the TIMER switch back to the OFF position to prevent accidental erasure of your important tape.

Connections with a timer

Connecting a commercially available timer to your audio setup lets you wake up to your favorite cassette tape, or start recording at specified times.

Refer to the illustration below, and connect your audio components.

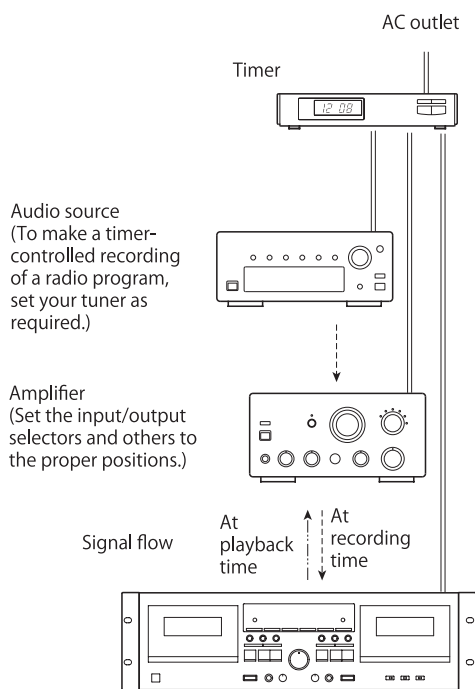

5 – Reference and specifications

Troubleshooting

If you think that there is something wrong with this cassette deck, make the checks listed below before contacting a repair service. In some cases the problem may lie with another component. Check all components.

If the problem cannot be solved with any of the following checks, contact your nearest TEAC authorized service center or your dealer for help.

Cannot switch on the power

- ➔ Check the connection to the AC power supply. Check and make sure the AC source is not a switched outlet and that, if it is, the switch is turned on. Make sure there is power to the AC outlet by plugging another item such as a lamp or fan into the outlet.

No sound

- ➔ Check the connection to the amplifier.
- ➔ Check the amplifier settings.

Noisy playback

- ➔ Keep away from equipment that generates a magnetic field, such as a TV or microwave oven.

Transport control keys do not work.

- ➔ Load a cassette tape if not loaded.
- ➔ If a cassette tape is loaded, reinsert it.

The cassette compartment does not close.

- ➔ The cassette is not properly loaded. Reinsert it.

Poor sound quality

- ➔ Clean the heads.
- ➔ Check that the Dolby NR switch is set to the same position as when recording was made.



Cannot record

- ➔ If the erasure prevention tabs on top of the cassette are broken off, cover the holes using pieces of adhesive tape.
- ➔ Check the connection to the amplifier and to the source equipment.
- ➔ Set the amplifier input/output selectors correctly.
- ➔ Check the recording level setting.



Playback speed seems somewhat fast or slow

- ➔ Check the pitch control setting.

Auto reverse does not occur

- ➔ Set the REV MODE switch to  or .
- ➔ If the REV MODE switch is set to , start playback from the tape side facing you (side “A”).

Synchro reverse dubbing is not possible.

- ➔ Set the REV MODE switch to the  position.
- ➔ Load cassettes into both decks.
- ➔ Set the tape transport direction to  on both decks.

Continuous play/record is not possible

- ➔ Set the REV MODE switch to the  position.
- ➔ Load cassettes into both decks.
- ➔ To make a continuous recording, start with TAPE 1.

NOTE

This cassette deck operates on a delicate micro-computer and there may be occasions when the deck does not function as expected because of external noise or interference. Problems you encounter on such occasions may be cured by turning off the power, waiting for 1 minute or more, then turning the power back on.

5 – Reference and specifications

Specifications

Track System	4-track, 2-channel stereo
Heads Construction	Record/playback head x 1 (each deck) Erase head x 1 (each deck)
Tape Speed	4.8 cm/sec 9.5 cm/sec (high-speed dubbing mode)
Pitch Control	12%
Fast Winding Time	approximately 160 sec (C-60 tape)
Motor	DC servo motor (capstan)
Wow and Flutter	0.25% (WRMS)
Frequency Response (Overall)	
Metal tape (Type IV, playback only)	30 Hz-19 kHz
Chrome tape (Type II)	30 Hz-18 kHz
Normal tape (Type I)	30 Hz-17 kHz
Signal to Noise Ratio (Overall)	58 dB (Dolby NR OFF, nominal recording level) 69 dB (Dolby NR ON, CCIR-ARM)
Line Input (RCA jack)	100 mV (input impedance 50k ohms)
Mic Input (mono 1/4" Phone jack)	0.38 mV (input impedance 200k ohms)
Line Output (RCA jack)	0.46 V (load impedance 50k ohms or more)
Headphones Output (stereo 1/4" Phone jack)	1 mW/32 ohms
Power Requirements	
U.S.A./Canada	120 V AC, 60 Hz
U.K./Europe	230 V AC, 50 Hz
Australia	240 V AC, 50 Hz
Power Consumption	22 W (U.S.A./Canada) 22 W (U.K./Europe) 22 W (Australia)
Dimensions (including protruding parts)	482 (W) x 138.5 (H) x 286 (D) mm (18.95" x 5.45" x 11.26")
Weight	4.0 kg (8.8 lb)

Dimensional drawing

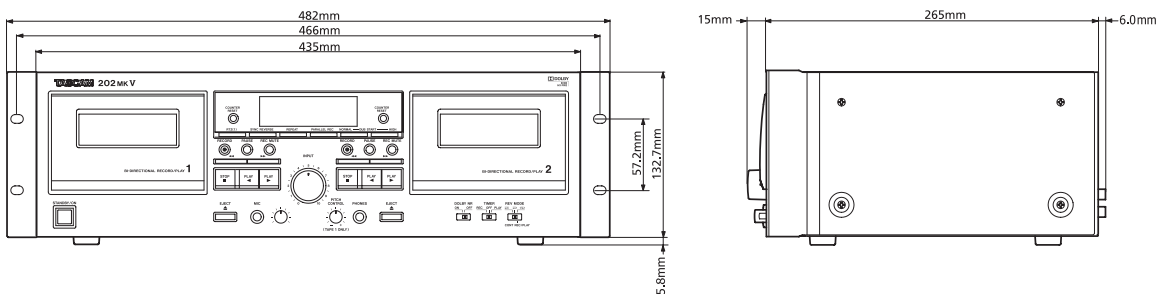

- To improve the product, specifications and external appearance may be changed without notification.
- As a result of product improvements, illustrations and other depictions in the owner's manual may differ in part from the actual product.

产品有毒有害物质或元素的名称及含量

机种：202MKV		有毒有害物质或元素					
	品名	铅 (Pb)	汞 (Hg)	镉 (Cd)	六价铬 (Cr6+)	多溴联苯 (PBB)	多溴二苯醚 (PBDE)
1	CHASSIS部份	○	○	○	○	○	○
2	FRONT PANEL部份	○	○	○	○	○	○
3	螺丝部份	○	○	○	○	○	○
4	线材部份	○	○	○	○	○	○
5	PCB Assy 部份	×	○	○	○	○	○
6	CASSETTE MECH部份	○	○	○	○	○	○
7	电源部份	○	○	○	○	○	○
8	附属品部份	○	○	○	○	○	○
9	SEAL部份	○	○	○	○	○	○
10	包装部份	○	○	○	○	○	○

○：表示该有毒有害物质在该部件所有均质材料中的含有量均在 SJ/T11363-2006 标准规定的限量要求以下。
 ×：表示该有毒有害物质至少在该部件的某一均质材料中的含量超出 SJ/T11363-2006 标准规定的限量要求。
 （针对现在代替技术困难的电子部品及合金中的铅）

TASCAM[®]
TEAC PROFESSIONAL

202MKV

TEAC CORPORATION

Phone: +81-42-356-9143
1-47 Ochiai, Tama-shi, Tokyo 206-8530, Japan

www.tascam.jp

TEAC AMERICA, INC.

Phone: +1-323-726-0303
7733 Telegraph Road, Montebello, California 90640, USA

www.tascam.com

TEAC CANADA LTD.

Phone: +1905-890-8008 Facsimile: +1905-890-9888
5939 Wallace Street, Mississauga, Ontario L4Z 1Z8, Canada

www.tascam.com

TEAC MEXICO, S.A. de C.V.

Phone: +52-55-5010-6000
Río Churubusco 364, Colonia Del Carmen, Delegación Coyoacán, CP 04100,
México DF, México

www.teacmexico.net

TEAC UK LIMITED

Phone: +44-8451-302511
Suites 19 & 20, Building 6, Croxley Green Business Park, Hatters Lane, Watford,
Hertfordshire, WD18 8TE, UK

www.tascam.co.uk

TEAC EUROPE GmbH

Phone: +49-611-71580
Bahnstrasse 12, 65205 Wiesbaden-Erbenheim, Germany

www.tascam.de
