

SONY®



HD

# PCS-XG80/PCS-XG80S

HD Visual Communication Systems

Stunning video and audio brought to you by the IPELA series of visual communication products that encompass the three-pronged concept of "Reality," "Intelligence," and "Usability." IPELA is the identity symbolizing the Sony vision for the workplace of the future, connecting people, places, and information with reality that has never before been achieved. IPELA products let you share, understand, and experience as if you are actually there, when in fact, you are miles away. It allows you to quickly grasp a situation

### Reality

- Stunning 1080i HD Video
- Max. Transfer Rate of 10 Mb/s
- Superb Sound (MPEG-4 AAC stereo)

### Intelligence

- BrightFace Technology (PCSA-CXG80)
- Multi-point Connection – Embedded MCU
- Enhanced Intelligent QoS Function

### Usability

- Backward Compatibility With SD Systems
- Video Annotation Function
- "One-touch Dialing" With RF Remote Commander Unit
- Single Cable Connection (HDMI cable)

Real audiovisual communication over networks – this is business communication of the future, this is business communication brought to you today, this is "IPELA."

## Change Your Daily Business Communication Style With the Powerful and Compact PCS-XG80 HD Visual Communication System

Sony, a leader in the AV industry, introduces a new form of high-definition (HD) visual communication with the PCS-XG80. Powerful, affordable, and compact – the PCS-XG80 achieves 1080i HD video quality, making your daily business communication style more effective, productive, and comfortable.

With approximately four times more detail than standard-definition (SD) images, the exceptional HD video quality of the PCS-XG80 takes your visual communications to the next level. The HD video quality provided by Sony not only enhances your daily videoconferences with life-like images, but also lets you see details that were not before visible with SD systems – which is especially useful for applications such as product design conferences. What's more, the HD camera of the PCS-XG80 adopts the Sony developed BrightFace™ technology, which produces clear images even when used in rooms with less-than-ideal lighting conditions. The unit also features clear and natural-sounding stereo audio, allowing you to hold videoconferences with "real communication" as if you were talking in the same room.

To make videoconferencing a powerful mainstream business communication tool, the PCS-XG80 has been designed to be extremely user-friendly. With an intuitive Graphical User Interface (GUI) that employs a simple layer structure and translucent cascading menus, the system makes videoconferencing easier than ever before. Moreover, the PCS-XG80 offers a number of other features for user convenience, such as one-touch dialing for starting a videoconference, an HDMI interface allowing a single cable connection between the codec and display, an embedded MCU for multi-point connections,<sup>\*1</sup> and a new RF Remote Commander® unit that can be operated without having to be pointed directly towards the system. What's more, the PCS-XG80 is backward compatible with SD videoconferencing systems, allowing seamless integration with existing SD systems your business may be running.

You can enhance the quality of your videoconferences with effective data sharing (video and presentation data from a PC) because the PCS-XG80 complies with the ITU-T H.239 standard.<sup>\*1</sup> Presentation data can be transferred at a frame rate as high as 30fps, which makes it possible to present animations during a videoconference. Moreover, by using the video annotation function<sup>\*2</sup> of the PCS-XG80, you can clearly point out specific parts of an image by writing on a tablet. With these outstanding data-sharing tools, you can now minimize misunderstandings during your videoconference.

With a stylish design suitable for a variety of meeting rooms, 1080i HD video quality, and life-like sound, the powerful, affordable, and compact PCS-XG80 is ideal for videoconferencing at all levels of business — as well as for distance learning. HD videoconferencing is now available for your daily communication needs.

\*1 Requires optional software    \*2 Requires an optional third-party pen tablet.

# FEATURES

## Reality

### Stunning 1080i High-definition (HD) Images

The PCS-XG80 adopts the H.264 video codec to bring you smooth and natural high-definition (HD) images at a resolution of 1920 x 1080 pixels. Stunning HD video enhances your videoconferencing with life-like images. What's more, the unit can be operated at 720p, 60 frames per second, to produce natural video for effective communication.

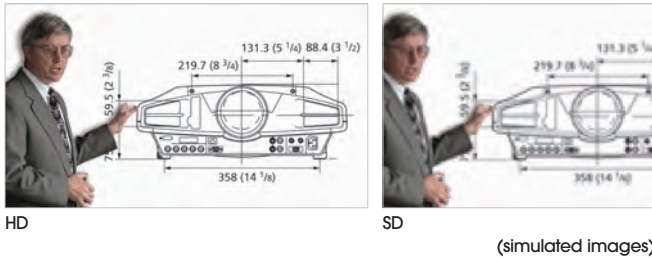

(simulated images)

### Superb Audio Quality

The PCS-XG80 produces clear and natural stereo sound, using the MPEG-4 AAC compression format. And because the unit has a built-in stereo echo canceller, which helps to eliminate the annoying echo often heard with other systems, communication sounds far more natural.

### ITU-T H.239 Support (video and presentation data) – Presentation Data Transferred at 30fps<sup>\*3</sup>

With support for the ITU-T H.239 standard, the PCS-XG80 can send both video and presentation data displayed on your PC to videoconferencing counterparts for more effective communication. Presentation data can be transferred at frame rates as high as 30fps,<sup>\*3</sup> providing natural and smooth presentations even when using animation effects or showing videos from your PC. This presentation data can be shown from either a projector or a sub display using the RGB output.

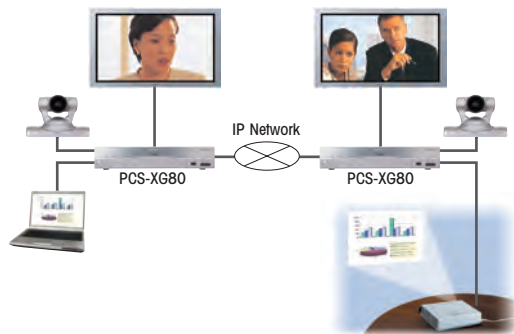

(monitors and laptop sold separately)

## Intelligence

### BrightFace Technology (PCSA-CXG80)

The PCS-XG80 has a dedicated HD camera (PCSA-CXG80) that adopts the Sony newly developed BrightFace technology. This technology optimizes the brightness of each pixel to highlight shadows, while subduing areas of the image that are too bright, allowing operation in less-than-ideal lighting conditions. BrightFace technology can provide clear images even in dimly lit rooms, for example when using a projector, or in rooms with poor backlighting conditions.



With BrightFace Function



Without BrightFace Function

(simulated images)

### Multi-point Connection – Embedded MCU<sup>\*4</sup>

Using optional MCU software, the PCS-XG80 can be configured to communicate with up to five remote videoconferencing sites (six sites total) simultaneously, using either an IP (H.323 or SIP protocol) or ISDN (H.320 protocol) connection.<sup>\*3</sup> It can also support videoconferences in which the connections are a combination of IP and ISDN by using a bridging function. Moreover, two PCS-XG80 units – each installed with the optional MCU software – can be cascaded with an IP connection to support a maximum of ten sites.

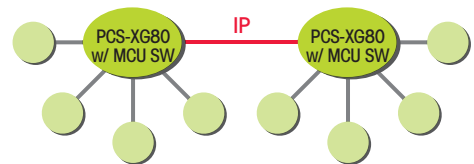

Multi-point Videoconferencing at up to 10 Sites

## Continuous-presence Mode With Voice Activated Switching\*4

The PCS-XG80 supports both four-screen and six-screen continuous-presence modes in 720p HD format, which provides clear images even on the smaller sub screens. When using voice activated switching in continuous-presence mode, the far-end site that is actively speaking is displayed on the largest of the six sub screens. In addition, voice activated switching is available when the unit is in full-screen mode. Plus, of course, fixed-site videoconferencing is available as well.

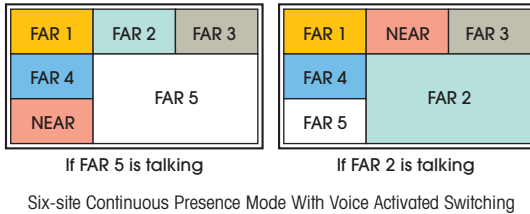

## Stable and Secure Videoconferencing

### Enhanced Intelligent QoS™ (Quality of Service) Functions to Achieve Stable Transmission

To handle the transmission of large amounts of HD video data while maintaining high-quality and stable communication over an IP network, the PCS-XG80 incorporates the following advanced QoS functions:

- Adaptive FEC (Forward Error Correction)
- Real-time ARQ™ (Automatic Repeat reQuest)
- ARC (Adaptive Rate Control)

These functions work “harmoniously” for fast and consistent data throughput during the transmission of video signals by adapting to any changes in the network condition and correcting any packet loss. For more information on the intelligent QoS mechanism, refer to the “Technical Note” insert.



With Enhanced Intelligent QoS



Without Enhanced Intelligent QoS

(simulated images)

## Advanced Encryption Standard (AES) for High Security

Secure videoconferencing over a network is possible because the PCS-XG80 supports 128-bit AES encryption. The system’s encryption complies with the ITU-T H.233/H.234/H.235 standards, which allows encrypted communication with other compliant systems. When the encryption mode is active, video, audio, and presentation data are encrypted for the duration of the videoconference.

### Technical Note - Intelligent QoS Functions

Sony has implemented a number of QoS functions in all of its currently available visual communication systems. However, conventional QoS methods used with SD systems are inadequate when handling large amounts of data associated with high-definition (HD) video. Therefore, Sony has designed and implemented enhanced intelligent QoS functions in its HD visual communication systems.

Two major improvements have been made on the previous methods. First, the system intelligently allocates the amount of ARQ, FEC, and video data based on the bandwidth available, which is determined by the ARC function. Second, FEC is performed with larger FEC blocks and the number of parity packets are adjusted as required. This combination is both efficient and effective for transmitting large amounts of data over IP networks to help maintain high picture quality.

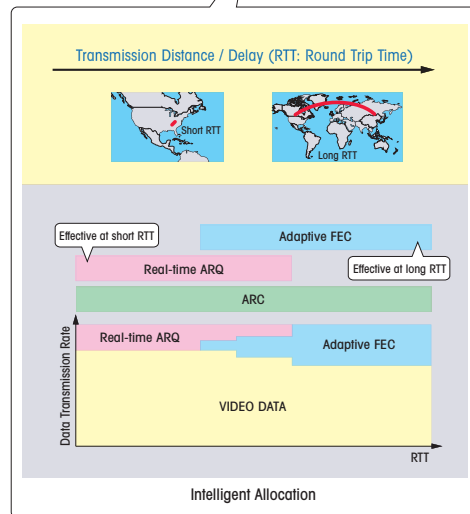
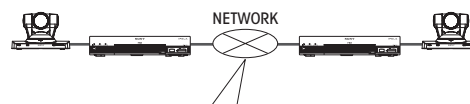

# Usability

## Video Annotation Function\*5

For effective communication, the PCS-XG80 video annotation function is available. Conference participants can clearly point out specific parts of shared data, including live images and presentation data, by simply writing on a tablet. This function can help you minimize time and effort in your communications, and allow you to deliver a clear and strong message.



(simulated images)

## Multiple Display Layout

The PCS-XG80 has multiple display layouts such as Full Screen, Picture-in-Picture, Picture-and-Picture, and a Side-by-Side split screen. Any of these flexible display patterns can be selected so that both videoconferencing images and presentation data can be displayed in a manner that is effective and pleasing to the eye.

## Simple Setup and Easy Operation

### Intuitive GUI – Simple Layer Structure/ Translucent Cascading Menus

The PCS-XG80 was thoughtfully designed with an intuitive GUI, utilizing translucent cascading menus. The simple layer structure and easy functionality allow you to operate the videoconferencing system, including the camera, much easier than ever before.

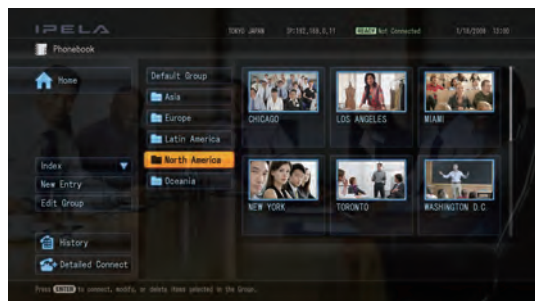

(simulated image)

## “One-touch Dialing” With Newly Designed RF Remote Commander Unit

For user convenience, the PCS-XG80 adopts a newly designed RF Remote Commander unit that does not have to be pointed directly towards the system. What’s more, the PCS-XG80 has a convenient one-touch dialing feature, which allows you to easily connect to any of your registered contacts by just pushing a function button on the RF Remote Commander unit that corresponds to a thumbnail image on the GUI. Up to four contacts for one-touch dialing can be shown on the “home menu” from a maximum of 1000 registered contacts.



## Single Cable Connection With HDMI

With the supplied HDMI cable, the PCS-XG80 can be connected to an HDMI-equipped display. This single cable connection transmits both audio and video, allowing the codec and display to be neatly and quickly wired.



## Dual Network Interfaces – Easily Switch Between LAN and WAN Connections\*4

For ease of use in office environments, the PCS-XG80 is equipped with dual network interfaces, one for a LAN and the other for a WAN connection. This can save you time if you need to use the system both within an intranet environment and over the Internet. What’s more multi-point connections can be made between LAN and WAN environments.

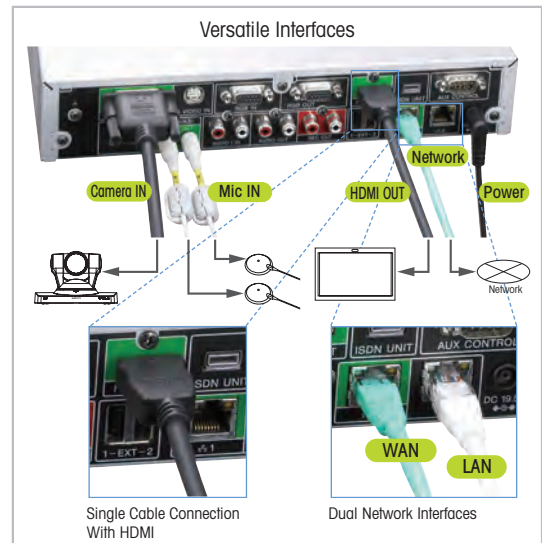

## Backward Compatibility With SD Systems

Since the PCS-XG80 is backward compatible with legacy SD systems, you can seamlessly integrate the system to your existing standard-definition videoconferencing environment. This enables you to migrate from SD to HD at your own pace, with minimal upfront investment.

## Compact and Stylish Design Suitable for a Variety of Meeting Rooms

With its compact and stylish design, the PCS-XG80 fits neatly into boardrooms, medium- and small-sized meeting rooms, and even classrooms. And because the compact and powerful HD videoconferencing system is incredibly light in weight at approximately 4 lb 14 oz (2.2 kg), system integrators will find it easy to install.

Codec Dimensions (W x H x D):  
 Approximately 11 1/8 x 2 1/4 (including rubber feet) x 9 5/8 inches  
 (282 x 56 x 244 mm)  
 excluding projections  
 Codec Weight: Approximately 4 lb 14 oz (2.2 kg)

## OTHER FEATURES

- Memory Stick® recording – video/presentation data (including annotations) and audio can be recorded for later review\*<sup>6</sup>
- Presentation data can be sent as a single stream by selecting the RGB input.
- Built-in streaming function for multicasting to large audiences\*<sup>6</sup>
- Support for IPv6\*<sup>4</sup>
- Support for H. 460 Firewall Traversal\*<sup>4</sup>
- Up to 100 camera preset positions can be stored, each with a thumbnail image\*<sup>4</sup> for easy recall.

\*<sup>3</sup> Requires optional software. These functions are available except when using the 1080i or 720/60p video formats.

\*<sup>4</sup> These functions are available with software version 2.0.

\*<sup>5</sup> Requires optional third-party pen tablet. This function is available except when using the 1080i format.

\*<sup>6</sup> These functions are available except when using the 1080i format.

## Videoconferencing for Our Environment

You can help reduce CO<sub>2</sub> emissions and support our environment by using videoconferences in lieu of business travel. Sony HD visual communication systems can make you feel as if you are communicating in the same room. Stay in touch, travel less, and save our earth. Sony has an answer.

## Sample System Configurations

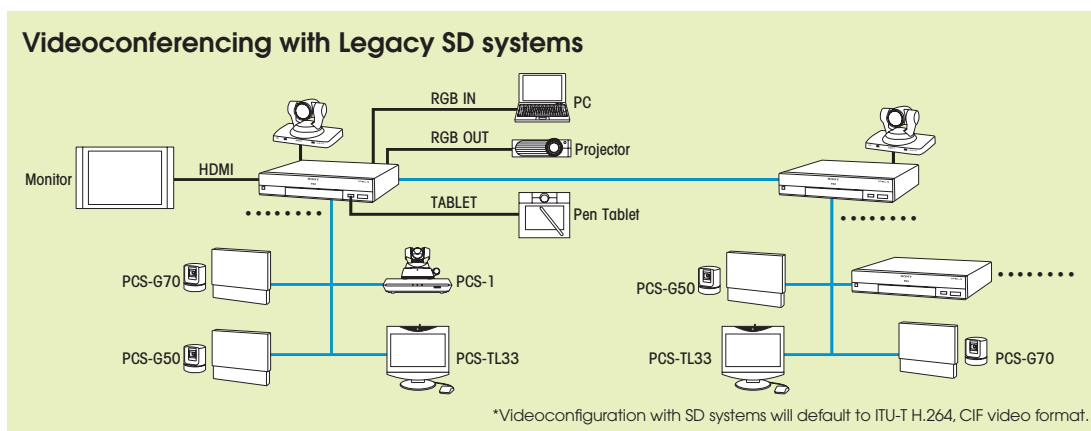
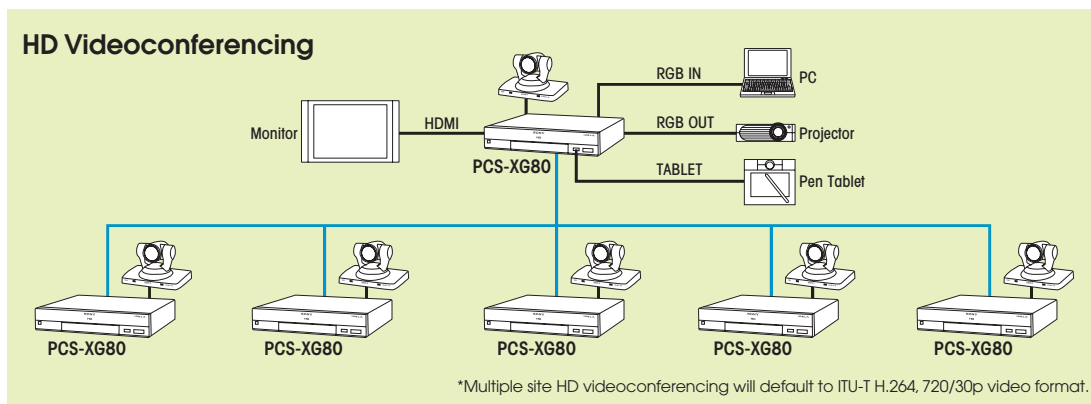

# OPTIONAL ACCESSORIES



**PCSA-CXG80**  
1/3-Type CMOS HD Camera  
(PCSA-CXG80 is supplied with the PCS-XG80)



**EVI-HD1**  
1/3-Type CMOS HD Camera



**BRC-H700**  
1/3-Type 3CCD HD Camera



**PCS-A1**  
Omnidirectional Microphone  
(Two PCS-A1 mics are supplied with the PCS-XG80)



**PCSA-A3**  
Unidirectional Microphone



**PCSA-A7P4**  
Echo Cancelling Microphone  
(4 units per package)



**PCSA-MCG80**  
HD MCU Software  
**PCSA-DSG80**  
HD Data Solution Software  
(for H.239 video and presentation data)



**PCSA-B768S**  
ISDN I/F Box 768Kbps



**PCSA-B384S**  
ISDN I/F Box 384Kbps

# CONNECTOR PANELS

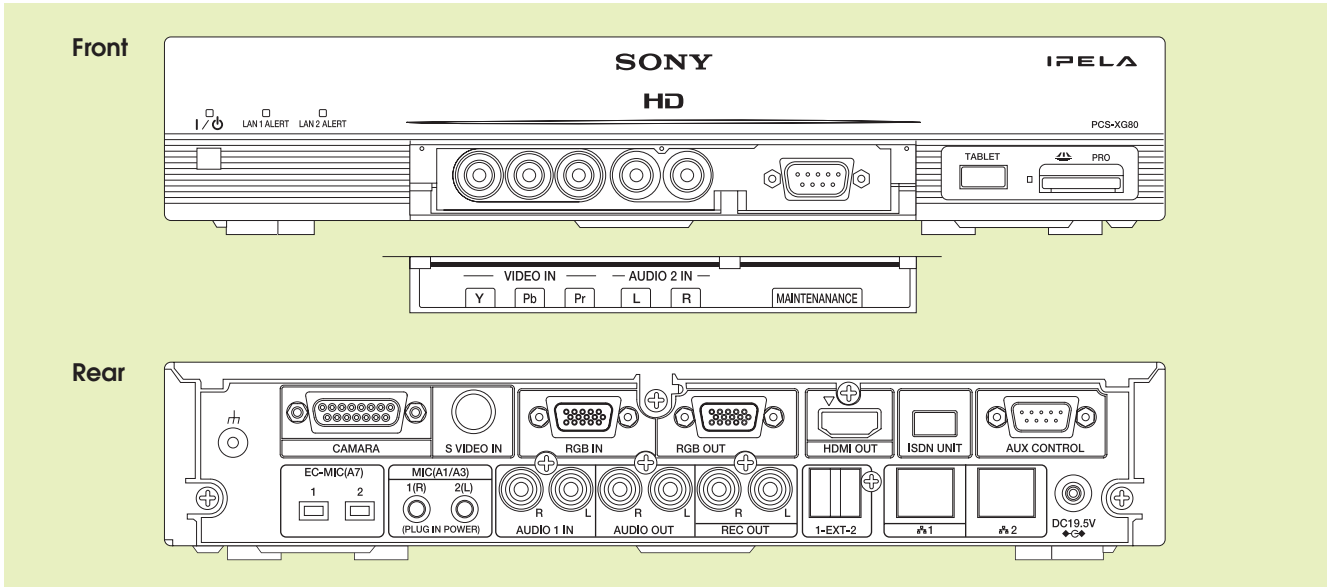

# DIMENSIONS

PCS-XG80S

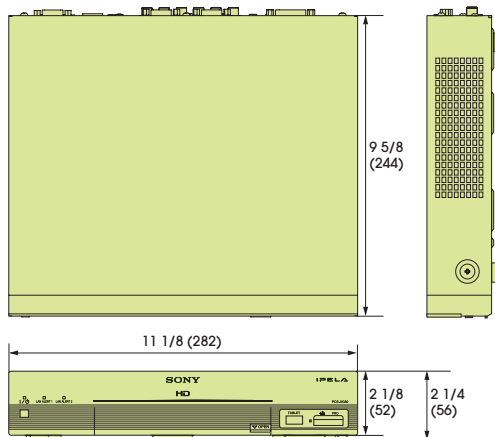

PCSA-CXG80

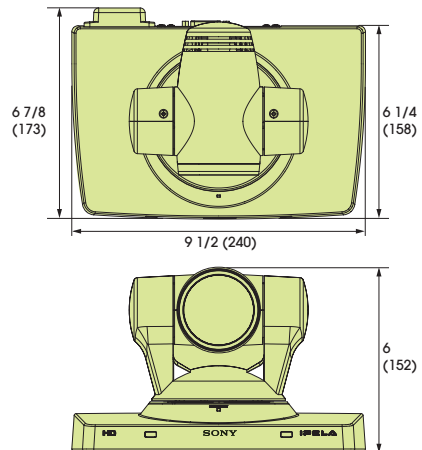

Unit: inches (mm)

## HD Codec Unit

<b>PCS-XG80S (software version 1.0)</b>	
<b>Communication Protocol Standards</b>	
	H.320, H.323, IETF SIP
<b>Video</b>	
Compression Standard	ITU-T H.261, H.263, H.263+, H.263++, H.264, MPEG-4 Video (SIP only)
Resolution	4:3 QCIF (176 x 144), CIF (352 x 288), 4CIF (704 x 576) 16:9 wCIF/w288p (512 x 288), w432p (768 x 432), w4CIF (1024 x 576), 720p (1280 x 720), 1080i (1920 x 1080)
Maximum Frame Rate	H.261 QCIF 30fps, CIF 30fps H.263 QCIF 30fps, CIF 30fps, 4CIF 10fps H.264 QCIF 30fps, CIF 30fps, 4CIF 30fps, wCIF 30fps, w432p 30fps, w4CIF 30fps, 720p 60fps, 1080i 60fps
Bit Rate	IP 64 kb/s to 10 Mb/s ISDN 56 kb/s to 768 kb/s (with optional PCSA-B768S) 56 kb/s to 384 kb/s (with optional PCSA-B384S)
<b>Audio</b>	
Bandwidth and Coding	MPEG-4 AAC-LC Stereo: 22 kHz at 128kb/s, 192 kb/s - IP Only MPEG-4 AAC-LC Mono: 14 kHz at 48 kb/s, 64 kb/s, 96 kb/s MPEG-4 AAC-LC Mono: 22 kHz at 64 kb/s, 96 kb/s - IP only G.711: 3.4 kHz at 56 kb/s, 64 kb/s G.722: 7.0 kHz at 48 kb/s, 56 kb/s, 64 kb/s G.728: 3.4 kHz at 16 kb/s
Echo Cancellation	Stereo echo-cancelling supported Noise reduction included Automatic gain control included
<b>Screen Layout</b>	
	Full screen, Picture-in-Picture, Picture-and-Picture, Side-by-Side split screen
<b>ITU-T Standards (excludes audio/video standards)</b>	
	H.221, BONDING, H.225.0, H.231, H.241, H.242, H.243, H.245
<b>Other Standards</b>	
	RFC2190, RFC3016, RFC3047, RFC3261, RFC3264, RFC3550, RFC3984, RFC4537, RFC4587, RFC4629, RFC4856
<b>Network Protocol</b>	
	TCP/IP, UDP/IP, RTP/RTCP, DHCP, DNS, SNMP, TELNET, SSH, HTTP, HTTPS, NTP, PPPoE, UPnP
<b>Multipoint Capability</b>	
	Internal MCU Up to 6 sites (H.320/H.323/SIP) with optional software PCSA-MC680 Internal MCU Up to 10 sites (H.320/H.323/SIP) with optional software PCSA-MC680 Using Cascaded Connection
<b>Data Sharing</b>	
	H.239 (video and presentation data)*
<b>Lip Synchronization</b>	
	ON/OFF
<b>Mic Off Function</b>	
	ON/OFF
<b>Encryption Protocols</b>	
	H.233, H.234, H.235 ver.3
<b>Network Features</b>	
Intelligent QoS (Quality of Service)	Adaptive FEC (Forward Error Correction), Real-time ARQ (Auto Repeat reQuest), ARC (Adaptive Rate Control)
Others Network Features	NAT, IP Precedence/DiffServe, UDP Shaping, TCP/UDP Port Setting, Auto Gatekeeper Discovery, Packet Reordering, URI Dialing
<b>Camera Control</b>	
Far End Camera Control	H.281
<b>Interface</b>	
Video Input	AUX Video Input (S-Video x 1, analog component Y/Pb/Pr x 1, RGB x 1)
Video Output	HDMI (video, audio) x 1, RGB x 1
Audio Input	Mic Input x 2 (stereo x 1/mono x 2, plug-in power) up to 14 kHz EC-Mic Input x 2 (PCSA-A7) up to 14 kHz Audio Input (MIC/AUX) x 2 (RCA pin, stereo) up to 22 kHz (AUX)
Audio Output	HDMI (video, audio) x 1, Line Output (RCA pin, stereo) x 1, REC Output (RCA pin, stereo) x 1
Control	RS-232C
Memory Stick	Memory Stick™ Slot x 1
Tablet Interface	Tablet Interface x 1
Maintenance Interface	RS-232C x 1
Network	10BASE-T/100BASE-TX x 2, ISDN Unit Interface x 1
<b>General</b>	
Operating Temperature	41 to 95 °F (5 to 35 °C)
Operating Humidity	20 to 80% (non condensing)
Storage Temperature	-4 to 140 °F (-20 to 60 °C)
Storage Humidity	20 to 80% (non condensing)
Power Requirements	DC 19.5 V (AC Adapter: AC 100 to 240 V, 50/60 Hz)
Power Consumption	40 W (codec only)/90 W (with PCSA-CXG80, PCSA-A7P4, PCSA-B768S)
Power Consumption (stand-by)	10 W (codec only)/15 W (with PCSA-CXG80, PCSA-A7P4, PCSA-B768S)
Dimensions (W x H x D)	11 1/8 x 2 1/4 (including rubber feet) x 9 5/8 inches (282 x 56 x 244 mm), excl. projections
Weight	Approx. 4 lb 14 oz (2.2 kg)
<b>Supplied Accessories</b>	
	AC adapter, HDMI cable (3m), RF Remote Commander® Unit, Batteries for Remote Commander® unit x 2, CD-ROM (Operating instructions, Before using this unit, Connection sheet, Quick dial guide), Before using this unit, Connection sheet, Quick dial guide, Important notice regarding software, Warranty booklet

## HD Camera Unit

<b>PCSA-CXG80</b>	
Image Device	1/3-type CMOS
Effective Picture Elements	Approx. 2 Megapixels (16:9)
Focal Length	3.4 to 33.9 mm (F1.8 to F2.1)
Focus	Auto/Manual
Horizontal Image Angle	Approx. 8°(tele) to 70°(wide)
Zoom Ratio	x 10 optical zoom (x 40 with digital zoom)
Pan/Tilt Angle	-100° to +100°(Pan), -25° to +25° (Tilt)
S/N	More than 50 dB
GAIN	AUTO
Control Out	VISCA™ OUT RS-232C for 2nd camera control
Position Preset	100 positions
Operating Temperature	41 to 95°F (5 to 35 °C)
Operating Humidity	20 to 80% (non condensing)
Storage Temperature	-4 to 140°F (-20 to 60°C)
Storage Humidity	20 to 80% (non condensing)
Power Requirements	DC 19.5V (supplied via the codec)
Dimensions (W x H x D)	9 1/2 x 6 (including rubber feet) x 6 1/4 inches (240 x 152 x 158 mm), excl. projections
Weight	Approx. 4 lb 3 oz (2 kg)
Others	BrightFace function, Noise reduction, Backlight compensation, Auto white balance
Supplied Accessories	Camera cable (3m), Hook-and-loop pads x 2, Operating instructions, Warranty booklet

\* PC images up to SXGA resolution is supported.

It requires the optional HD data solution software PCSA-DSG80 to send video and presentation data simultaneously.

## Package Configuration

	<b>PCS-XG80</b>	<b>PCS-XG80S</b>
HD Codec Unit (PCS-XG80S)	○	○
HD Camera Unit (PCSA-CXG80)	○	-
Omnidirectional Microphone (PCS-A1 x 2)	○	-

**SONY**

Sony Electronics Inc.  
1 Sony Drive  
Park Ridge, NJ 07656  
www.sony.com/conferencesolutions

VC-0174-A (MK10473V1)

©2008 Sony Electronics Inc. All rights reserved.  
Reproduction in whole or in part without written permission is prohibited.  
Features and specifications are as of software version 2.0, and subject to change without notice.  
All non-metric weights and measurements are approximate.  
Sony, IPELA, BrightFace, Remote Commander, Intelligent QoS, Real-time ARQ, VISCA and Memory Stick are trademarks of Sony.

Printed in USA (8/08)