

ANY SPOT[®] **TRAVELER[®]**

A5-TV8/TV5 *Plus TXRM Stationary Transmitter* **USER'S GUIDE**



Wireless Portable Sound Systems

**Compact, Lightweight
Clear sound quality
High output power**



GALAXY AUDIO[®]

MAKERS OF THE ORIGINAL HOT SPOT PERSONAL MONITOR

Contents

Introduction.....	1
Before using the TV8 or TV5.....	2
Front Panel Configuration of AS-TV8 Series.....	3
Rear Panel Configuration of AS-TV8 Series	4-6
Description of Functions of AS-TV8 Series.....	7-9
Operation of the AS-TV8.....	10
Power Supply/Charger.....	10
Power Switch.....	10
Mixer.....	10
In/Out Jacks.....	10
Speaker Out Jack.....	10
Wireless Mic/Audio Link Receiver	11
Anti Shock CD/CMP Player.....	11
Digital Echo System.....	12
Audio Link Transmitter.....	12
Rear Panel of AS-TV5 Series.....	13
Operation of TV5 and Optional Modules.....	14
Optional Wireless Receivers.....	14
Description of Functions for Handheld Microphone Front.....	15
Description of Functions for Handheld Microphone Back.....	16
Operation of Handheld Microphone.....	17-19
Description of Functions for Body Pack Transmitter.....	20
Operation of Body Pack Transmitter.....	21-23
AS-TXRM Stationary Transmitter.....	24-26
Setup and Operation of TXRM.....	25
Maintenance.....	23
Specifications.....	26-30
AS-TV8 Series.....	26
AS-TV5 Series.....	28
Wireless Receiver Module (TV8, TV5).....	28-29
Digital Echo Module (TV8).....	29
Audio Link Transmitter Module (TV8, TXRM).....	29
Handheld Microphones.....	29-30
Body Pack Transmitter.....	30

Operating Manual for AS-TV8/TV5 Series

Please visit www.galaxyaudio.com for the latest updates

Introduction

Thank you for purchasing the TV8 / TV5 series wireless portable sound systems. These units feature an “all in one” design that allows them to be configured with a variety of different function modules to suit your specific needs. With rich, full sound and plenty of power, the TV8 series is ideally suited to cover large areas. The TV5, with its compact size, is ideal for classrooms, conference rooms, and guided tours. This manual covers the complete functions and operations of the TV8 and TV5 including all optional function modules. It also covers the TXRM Stationary Transmitter, the TVHH/TVHHC Handheld Wireless Mics, and the TVMBP Bodypack Transmitter. To use these systems to their fullest potential please read this manual carefully.



Before Using the TV8 or TV5

1. Both the TV8 and TV5 use a universal AC switching power supply/charger that will operate on voltages of 100~240V,50/60Hz. The TV8 power supply is internal, while the TV5's is external. Verify that the voltage to which you are connecting is in this range and then connect the AC power cord from the Traveler to the wall outlet.
2. Charge the battery for at least 8 hours with the Power Switch OFF prior to first time use to maintain the quality of the battery and provide maximum operation time. When charging, the charging indicator lights RED. When charging is almost complete, the indicator will flash alternately RED and GREEN. After the battery is fully charged, the indicator will light GREEN. After the initial charge the Traveler may be operated on either AC or Battery power. When operating on AC power the Traveler will simultaneously recharge its internal batteries.
3. These units have auto protection circuitry that will protect the battery from being overcharged or overused. When running on battery power and the power switch LED blinks RED, the battery power is down to 30%. When the battery is nearly exhausted, the system will turn off automatically to protect the battery.

Front Panel Configuration of AS-TV8 Series

AS-TV8 Series

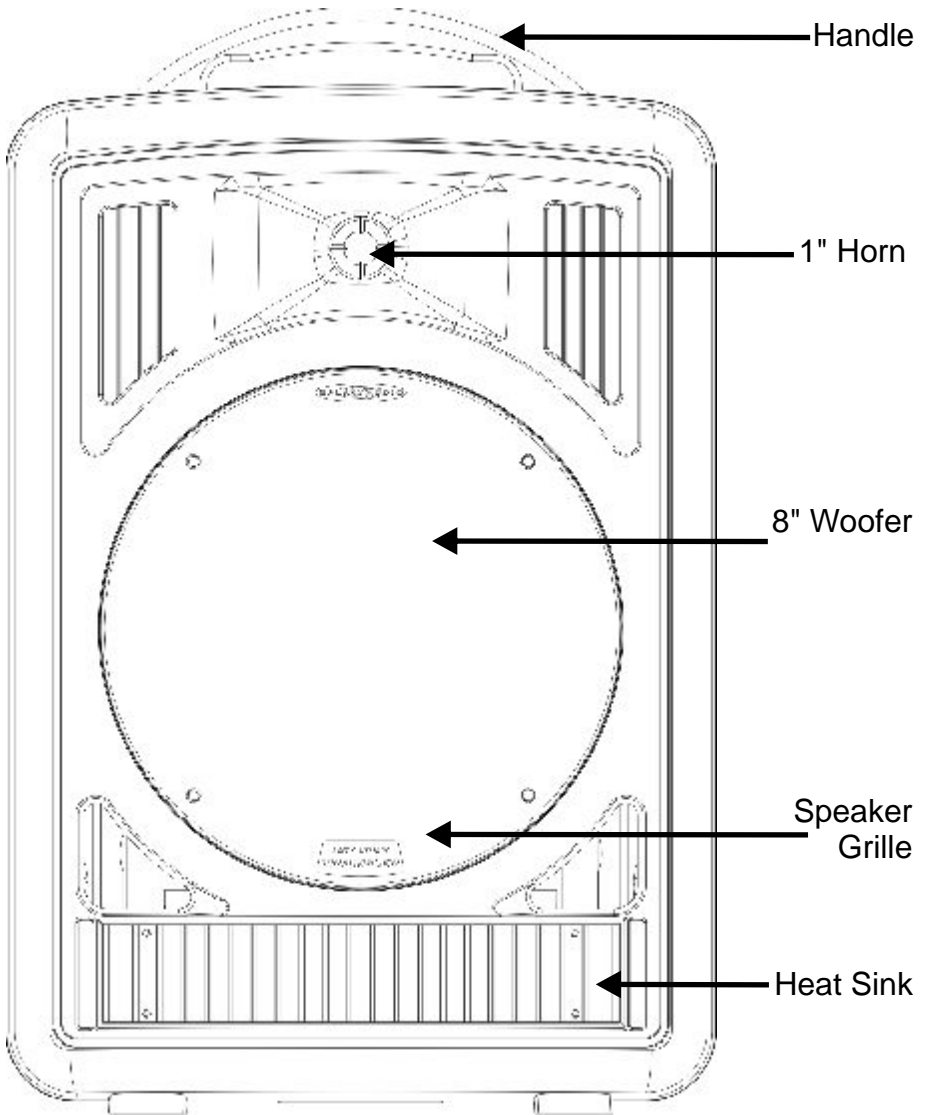

Rear Panel Configuration of AS-TV8C2 Series

AS-TV8C2

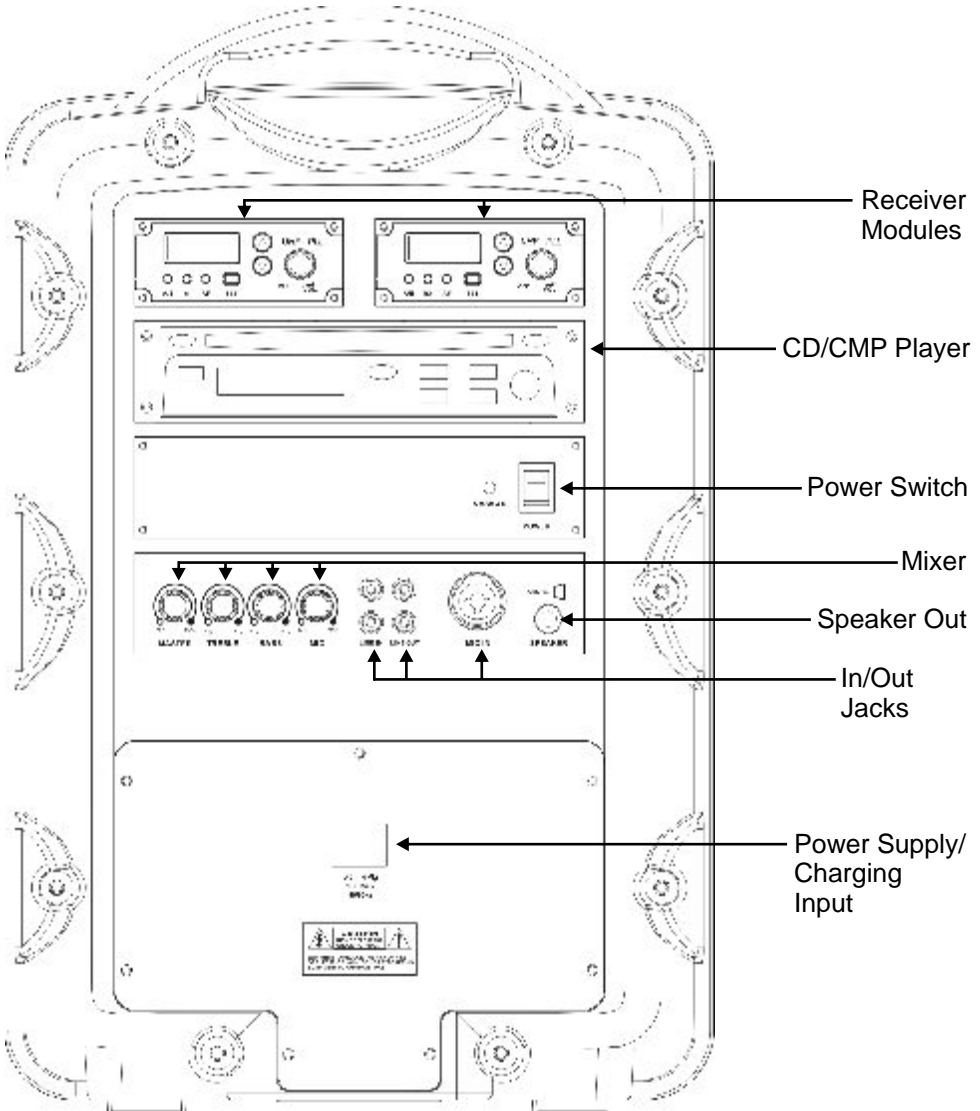

Rear Panel Configuration of AS-TV8CE2 Series

AS-TV8CE2

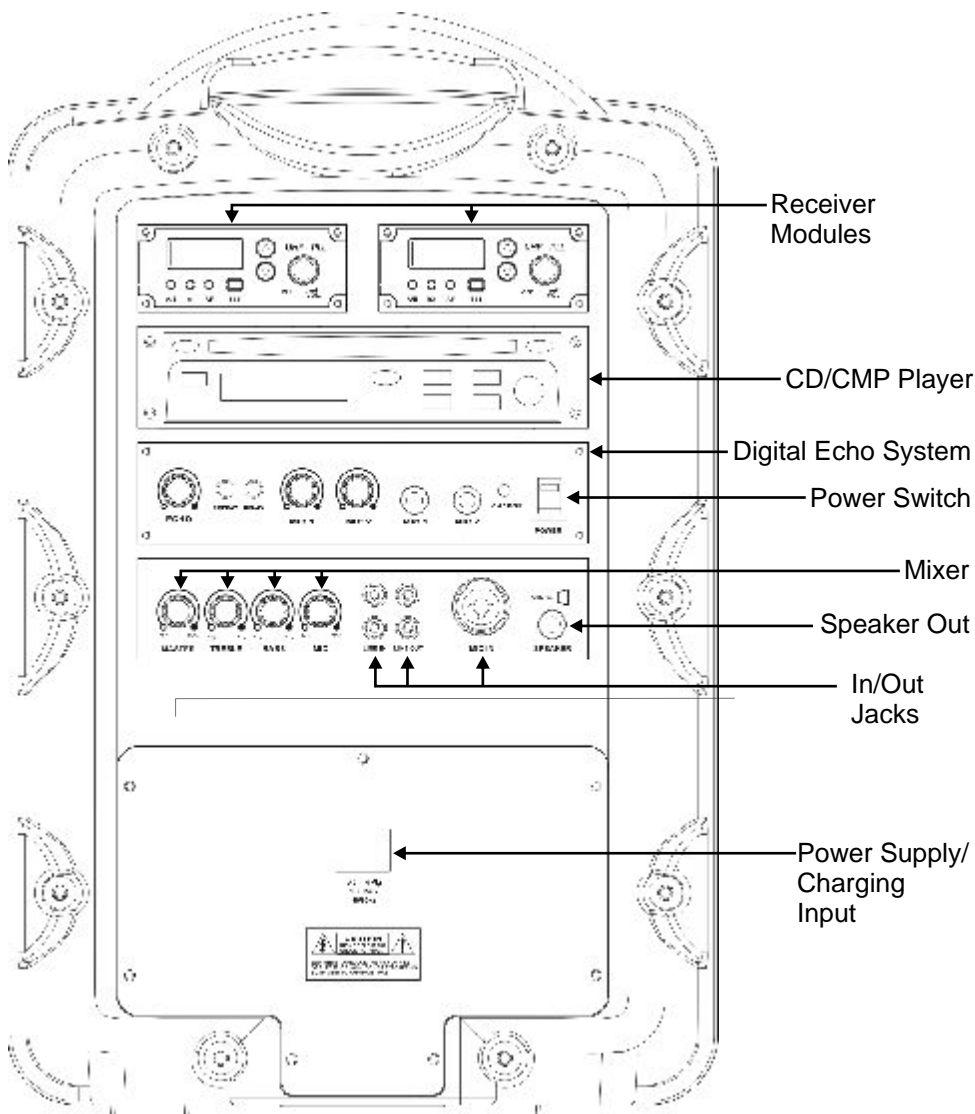

Rear Panel Configuration of AS-TV8CT2 Series

AS-TV8CT2

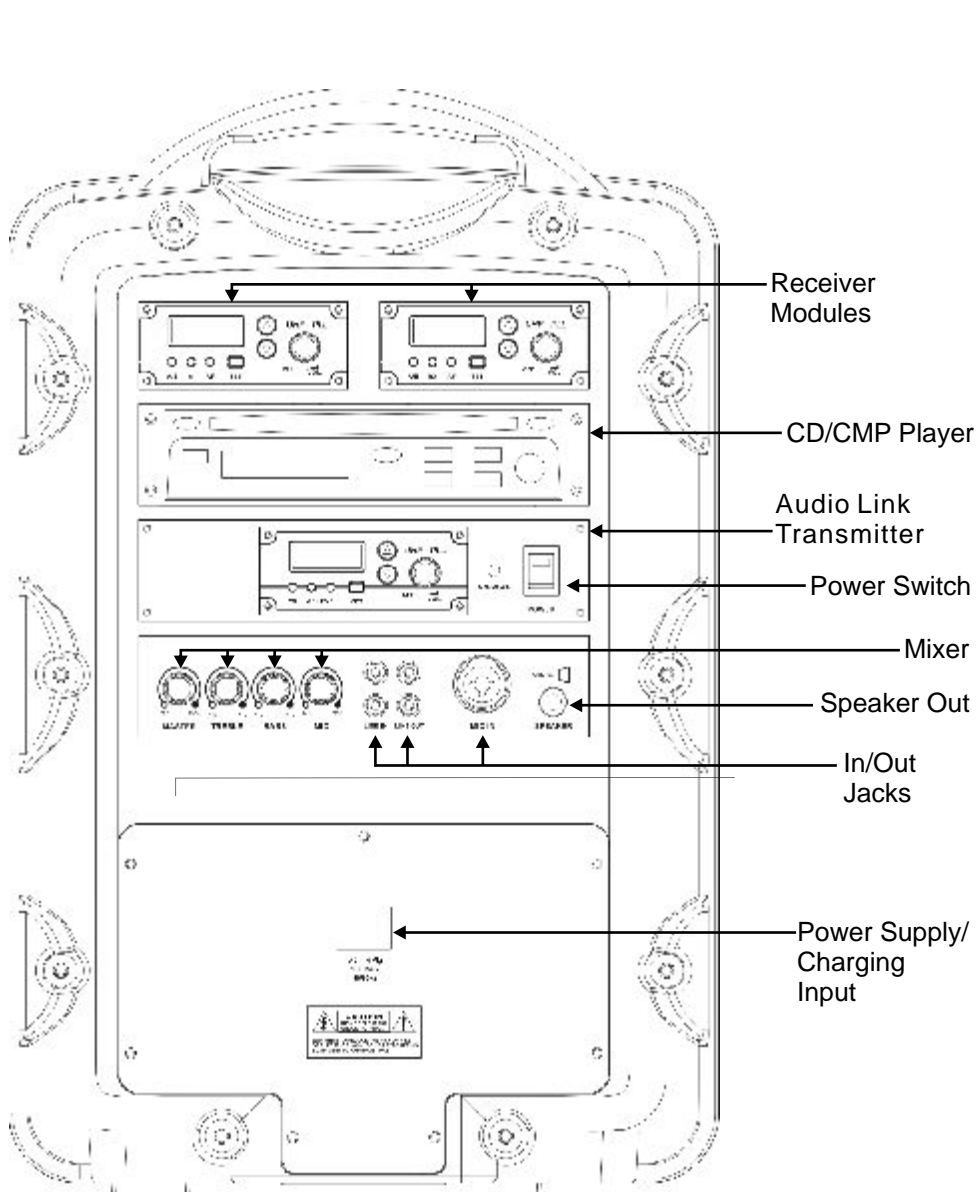

Description of Functions for AS-TV8 Series

A. Power Supply/Charging Input

1. AC Power Cable connector
2. Batteries (behind cover)
3. Battery cover

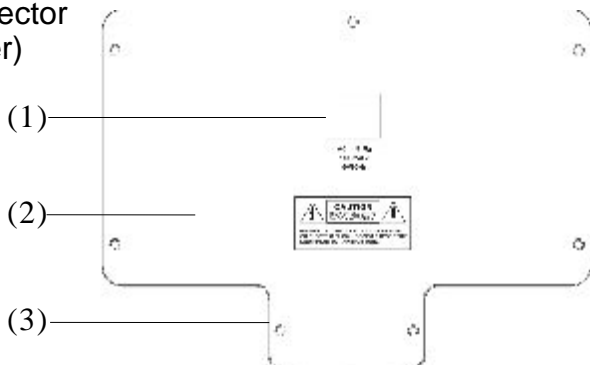

B. Power Switch and Charge Indicator

1. Power LED
2. Charging indicator
3. Power On/Off switch

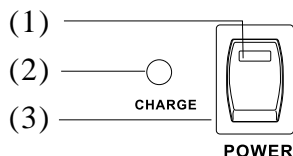

C. Mixer

1. Master volume control
 2. Treble control
 3. Bass control
 4. Mic volume control
- (For wired Mic connected to Mic in jack D3)

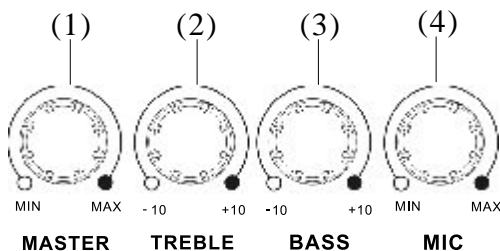

D. In/Out Jacks

1. Line in RCA jacks
2. Line out RCA jacks
3. Mic in XLR/1/4" jack

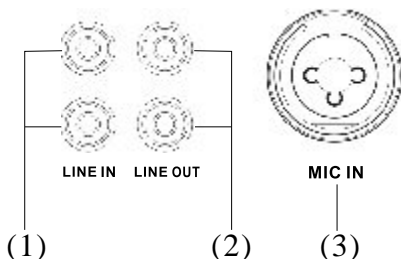

E. Speaker Out

1. Speaker level output jack.
Minimum 8 ohm external speaker

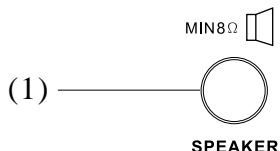

F. Wireless Microphone/Audio Link Receiver (AS-TV8/TV5)

1. LCD display
2. A/B diversity indicator
3. RF indicator
4. AF level indicator
5. Channel Set
6. Channel selector
7. Power switch & mic. volume

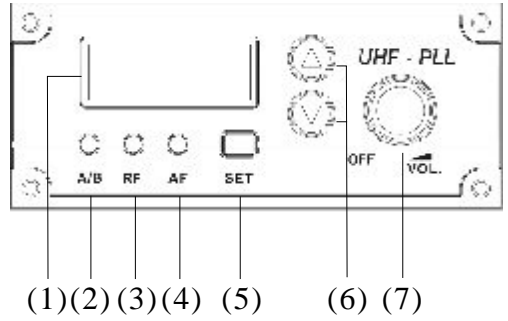

G. Anti-Shock CD/CMP Player

1. Program Playlist
2. Power switch
3. LCD display
4. Shuffle/Repeat
5. Stop/Eject
6. Search and play the previous track
7. Search and play the next track
8. Play/Pause
9. CD volume
10. CD slot
11. CMP (Compressed Media Player) Folder

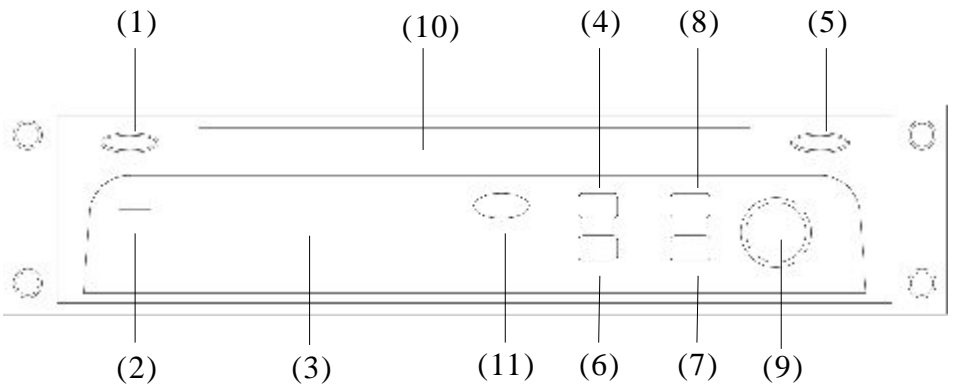

H1. Digital Echo System (for AS-TV8CE2)

1. Master echo volume control
2. Delay repeat control
3. Delay time control
4. Wired mic 1 volume control
5. Wired mic 2 volume control
6. Wired mic 1-1/4" input jack
7. Wired mic 2-1/4" input jack

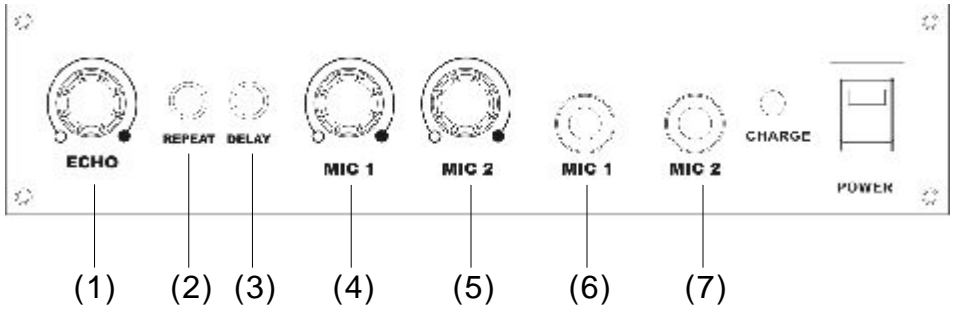

H2. Audio Link Transmitter (AS-TV8CT2)

1. LCD display
2. TX indicator
3. Low audio level indicator
4. High audio level indicator
5. Enter Setting
6. Channel selector
7. Power switch and volume control

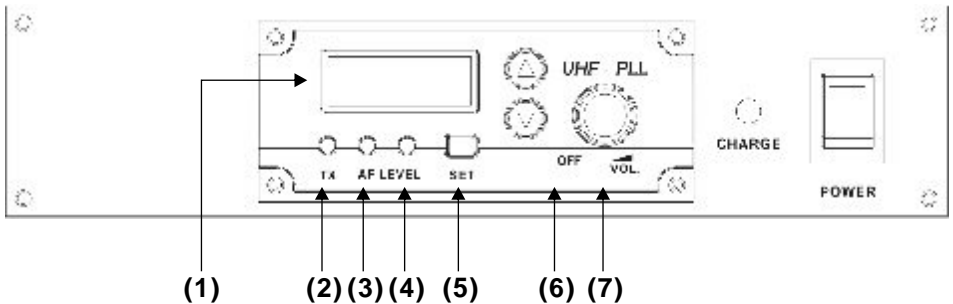

Operation of TV8 Portable Sound System

A. Power Supply/Charger (see page 7)

1. There is a universal AC switching power supply/charger built into the system that will operate on voltages of 100~240V,50/60Hz. Verify that the voltage to which you are connecting is in that range and then connect the AC power cord from the AC IN (**A1**) to the wall outlet.

B. Power Switch and Charge Indicator (see page 7)

1. Power LED lights constant red under normal operation when power switch is on. Blinking Power LED indicates 30% of battery power remaining.
2. When charging is almost complete, the indicator will flash RED and GREEN. After the battery is fully charged, the indicator lights GREEN. The Universal Power Supply/Battery Charger allows the Traveler to be used anywhere in the world. The Traveler will operate for an unlimited time on AC power and for about 6 hours on just battery power. A full recharge of the batteries takes about 4 hours. The Traveler may be operated while recharging the batteries without affecting the charge time. If a power failure occurs when operating on AC, the Traveler will seamlessly switch over to battery power.

C. Mixer (see the page 7)

1. Master Volume Control.
2. Turn the Treble control (**C2**) counterclockwise to decrease the treble, and turn clockwise to increase the treble. The center position (straight up) produces a flat response.
3. Turn the Bass control (**C3**) counterclockwise to decrease the bass, and turn clockwise to increase the bass. The center position (straight up) produces a flat response.
4. Mic Volume for wired mic In jack (D3).

D. In/Out Jacks (see page 7)

1. The system contains Line In, Line Out, and Mic in jacks for connecting external audio devices.
2. Line In (**D1**): RCA jacks to connect external audio sources, such as CD/MP3 players or iPods. The volume of the Line In is controlled solely by the Master (**C1**).
3. Line Out (**D2**): RCA jacks for sending the entire mix signal to other audio devices, such as recorders, mixers, or power amps.
4. Mic In (**D3**): XLR or 1/4" (6.3mm) phone jack for wired microphones. Volume of this input is controlled by Mic In (**C4**) and the Master (**C1**).

E. Speaker Out: (see page 7)

1. Used to connect to an external unpowered speaker (8 Min.)

F. Wireless Mic/Audio link Receiver (see page 8)

This system may include one or two receivers with selectable PLL 96 channel operation. These modules receive signals from wireless Mics or from another Traveler equipped with an Audio Link Transmitter.

1. Turn the power switch **(F7)** clockwise to turn on the receiver.
2. The LCD display **(F1)** will show "On" and the channel that was last in use when the unit was turned off.
3. To select a different channel, press the set button **(F5)**. The channel number will flash in the LCD display. Press the up or down button **(F6)** to select a channel to use, and then press the set button. After a channel has been set, press either the up or down button to display the frequency of the selected channel.
4. Adjust the volume control to the desired level.
5. When receiving signal, the A/B diversity indicator **(F2)** will light RED or Green to show the normal condition. The RF indicator **(F3)** will light to show RF received and the AF indicator **(F4)** will show audio received.

G. Anti-Shock CD/CMP Player (see page 8)

1. Push the powerswitch **(G2)** to turn on the player. Put a CD in the CD slot **(G10)** or push the Stop/Eject button **(G5)** to take a CD out of the slot.
2. Press the Play/Pause button **(G8)** to start or pause CD/MP3 play. Turn the volume control **(G9)** to adjust to the proper volume. Push the Stop/Eject button to stop or change the CD or CMP (Compressed Media Player) disc.
3. Press the Forward **(G7)** or Reverse **(G6)** button to skip forward to the next track or reverse to the previous track. Holding down the Forward or Reverse button will continuously forward or reverse the tracks.
4. Repeat/Shuffle **(G4)** has three modes:
 1. Repeat one song
 2. Repeat all songs
 3. Shuffle for random play.
5. Create Program Playlist:
 - Step 1: Press Prog button **(G1)** to begin setting up the program playlist
 - Step 2: Select a song (see step 3 and 6)
 - Step 3: Press Repeat **(G4)** to enter the song. Repeat steps 2 and 3 to enter additional songs.
 - Step 4: Press Play **(G4)** to play the programmed songs in memory

*Please note that the program will reset once the Program button is pressed again.

6. To select a folder from an CMP, press Folder button **(G11)**. Use Forward or Reverse buttons to select a song.

H1. Digital Echo System (see page 9)

1. Turn the Echo Control (**H1-1**) clockwise to turn on the echo system. Then use this control to adjust the level of echo in the mix. Echo will be applied to all 3 mic inputs.
2. Adjust the repeat button (**H1-2**) to select the number of repeats desired. Adjust the delay button to select the delay time.
3. Mic input jacks (**H1-6** and **H1-7**) are provided for connecting wired Mics. Mic volume is controlled by **H1-4** and **H1-5** plus the Master (**C-1, Pg.7**).

H2. Audio Link Transmitter (see page 9)

This module transmits the entire audio mix from one Traveler to another Traveler equipped with a wireless Mic/Audio Link Receiver.

1. Turn the power switch (**H2-7**) clockwise to turn on the transmitter.
2. The LCD display (**H2-1**) will show "On" and the channel in use when the unit was last turned off.
3. To select a different channel, press the set button (**H2-5**) and the channel will flash in the LCD display. Press the up or down button (**H2-6**) to select the transmit channel, and then press the set button again to enter the setting. The LCD will then automatically display the selected channel. To display the frequency of the selected channel press and hold either the up or down button.
4. Turn the volume control (**H2-7**) to adjust the audio transmit level. Use this control in conjunction with the volume controls on the receiving Traveler.
5. When transmitting signal, the TX indicator (**H2-2**) will light Green to show the transmitting condition. The AF Level indicator lights Yellow (**H2-3**) to show a low audio level and lights Red (**H2-4**) to show high audio level.
6. Set up the receiving Traveler according to the procedure outlined in: F. Wireless Mic/Audio Link Receiver on page 9. Select the same channel chosen on the transmitting Traveler.

I. Rear Panel of TV5.

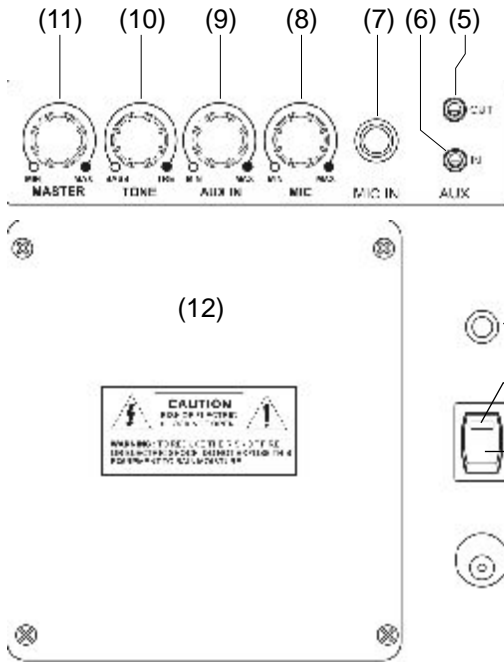

1. DC Power Input
2. Power Switch
3. Power LED
4. Charge LED
5. Aux Out Jack
6. Aux In Jack
7. 1/4" Mic Input
8. Mic Volume
9. Aux Volume
10. Tone Control
11. Master Volume
12. Battery Cover Plate

J. AS-TVF Optional Media Player for TV5

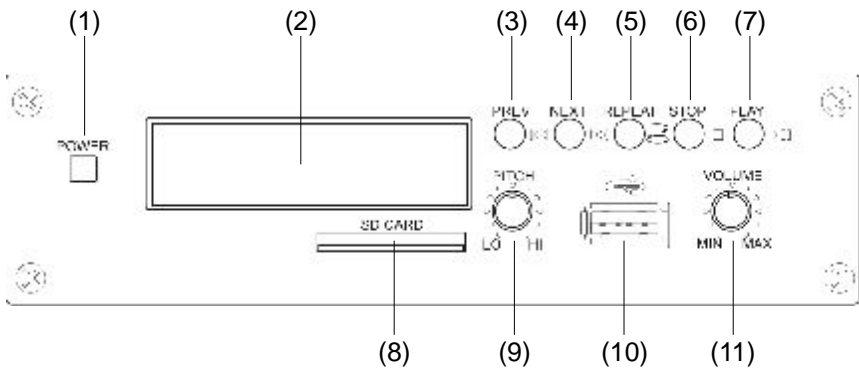

- | | |
|--------------------------|----------------------|
| 1. Power Switch | 7. Play/Pause Button |
| 2. LCD | 8. SD Card Slot |
| 3. Previous Track Button | 9. Pitch Control |
| 4. Next Track Button | 10. USB Jack |
| 5. Repeat Button | 11. Volume |
| 6. Stop Button | |

Operation of TV5 and Optional Modules (See Page 13)

1. For AC power operation or Charging: Connect the DC end of the Power Supply/Charger cable to the DC In Jack (I1). Then connect the other end (AC plug) to the AC wall outlet.
2. See page 2 for more information on Charging, Power Switch, and LED Indicators.
3. The Aux Out Jack (I5) provides a Pre-Master, Pre-Tone line level output of the entire mix.
4. The Aux In Jack (I6) is a line level input and is controlled by the Aux Volume (I9).
5. The ¼" Mic Input (I7) will accept balanced or unbalanced, high or low impedance mic signals, and is controlled by the Mic Volume (I8).
6. Turn the Tone control (I10) to the left for more bass and to the right for more treble. This affects the entire mix of inputs, but not the Aux Out signal.
7. The Master Volume (I11) controls the overall volume of the entire mix, but has no effect on the Aux Out signal.

J. AS-TVF Optional Media Player. (See page 13)

1. The TVF will play audio in the MP3 format from either SD Cards or USB Devices. Press (J1) to switch on the power. The LCD (J2) will display "C" when an SD card is inserted into the slot (J8), or display the "USB symbol" when a USB device is plugged into the USB Jack (J10). Track number, time counter, and play/pause status will also be displayed. To switch from one format to the other, simply unplug one media device and plug in the other.
2. Normal track play functions are controlled by buttons (J3) thru (J7). The Repeat button (J5) offers three modes: Off, repeat track, and repeat all tracks.
3. (J11) controls the volume. The Pitch (speed) of playback may be altered up or down using (J9). For normal Pitch set the control to the center detent.

For a Description and Operation of the Optional Wireless Microphone Receiver (TVREC) (see pages 7 and 11).

Notice: Changes or modifications not expressly approved by the party responsible for compliance could void the user's authority to operate the equipment.

IMPORTANT NOTE: To comply with the FCC RF exposure compliance requirements, no change to the antenna or the device is permitted. Any change to the antenna or the device could result in the device exceeding the RF exposure requirements and void the user's authority to operate the device.

This device complies with Part 15 of the FCC Rules. Operation is subject to the following two conditions: (1) this device may not cause harmful interference, and (2) this device must accept any interference received, including interference that may cause undesired operation.

Description of Functions for Handheld Microphone AS-TVHH/TVHHC

Front Panel

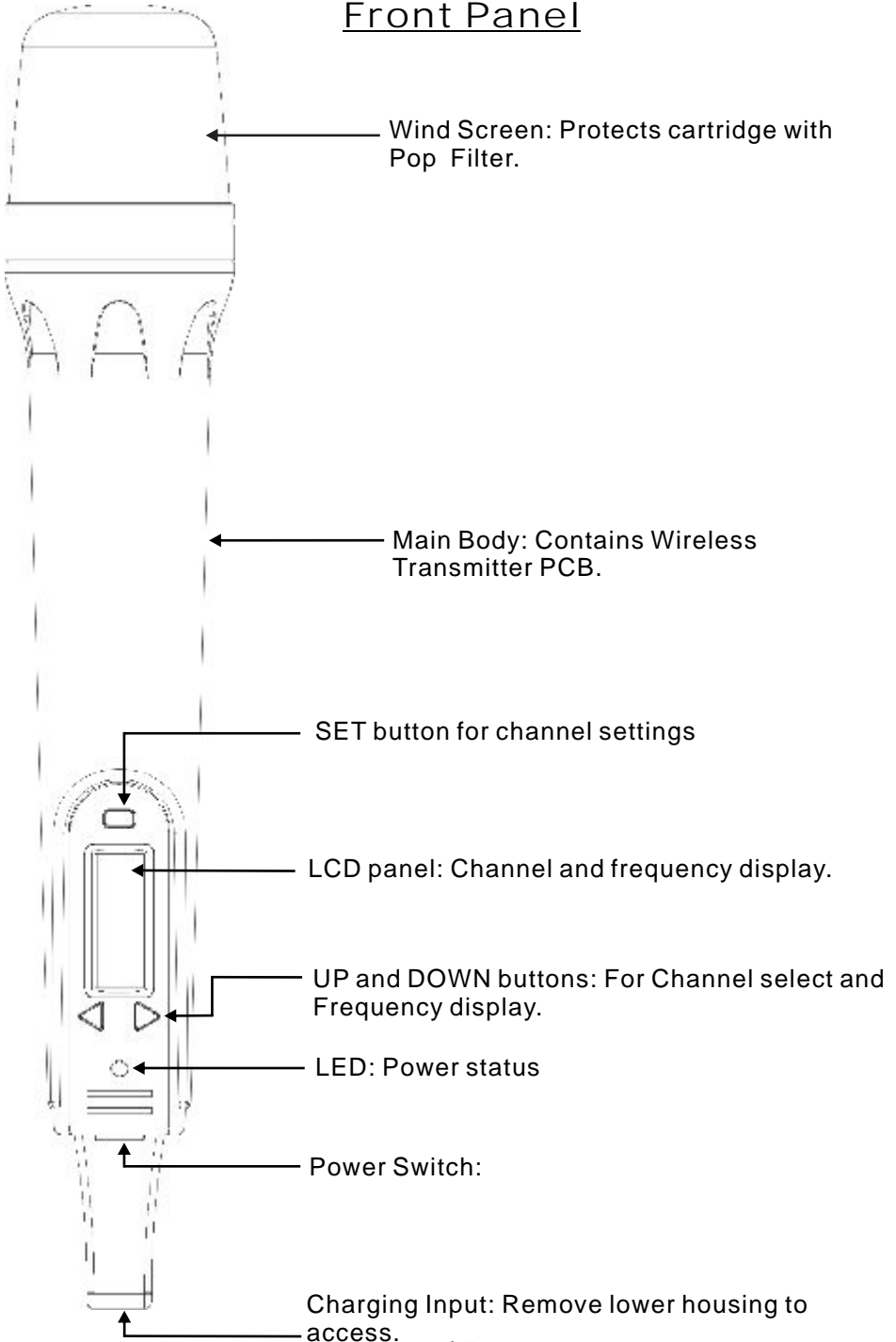

Description of Functions for Handheld Microphone AS-TVHH/TVHHC

Rear Panel

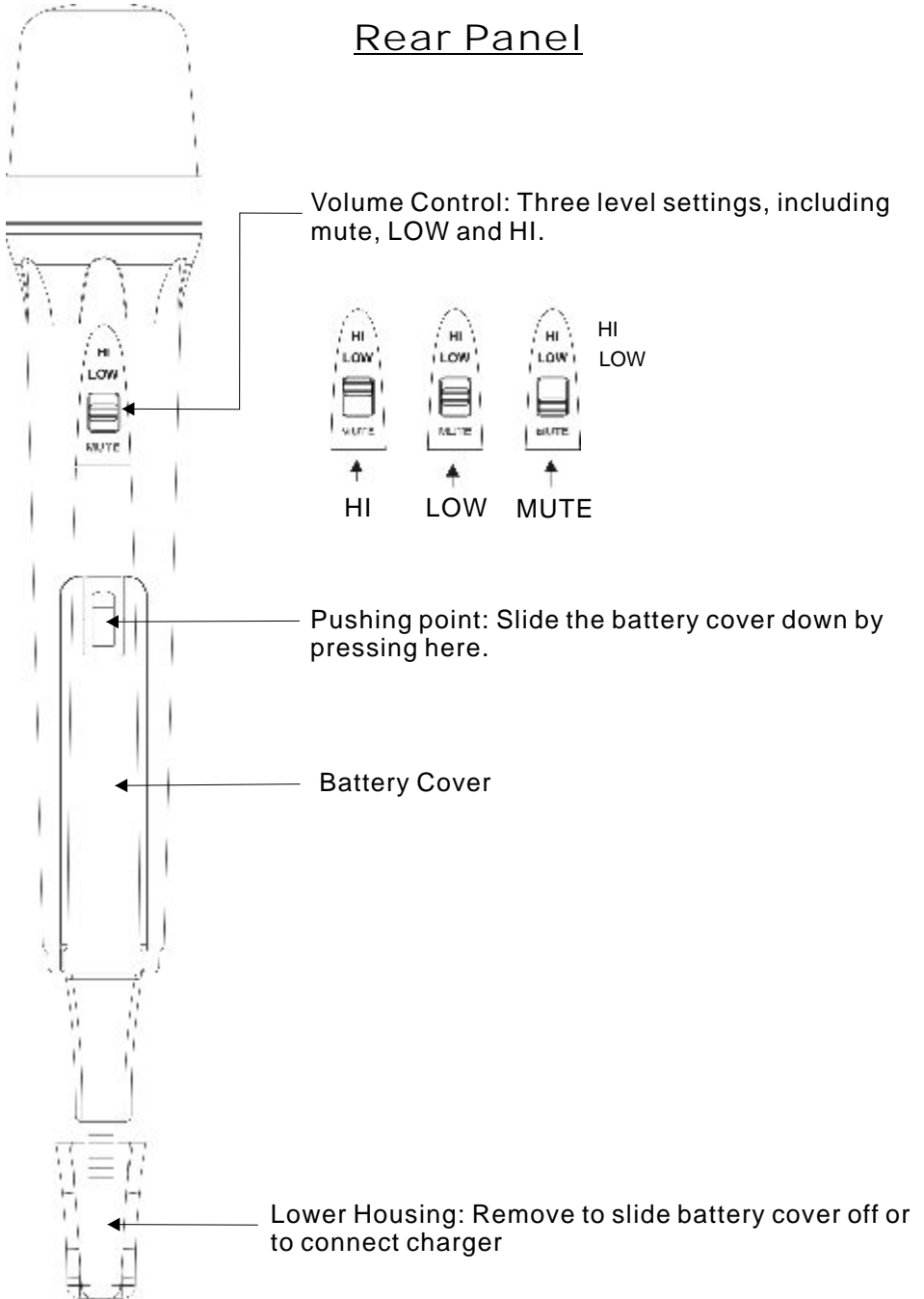



Operation of Handheld Microphone AS-TVHH/TVHHC

A. Battery Installation Steps:

1. Turn off the microphone before inserting batteries.
2. Press in the latch to release the lower housing and slide it off.
3. Press in the latch to release the battery cover and slide it down.
4. Insert 2 disposable batteries of 1.5V type or 2 rechargeable batteries of 1.2V type.
5. Observe proper polarity while inserting batteries.
6. Slide the battery cover back to its original position.
7. Install the lower housing back to the lower part of the microphone.

B. Switch-On Steps:

1. Press the power switch and hold for about two seconds until the LED turns to RED and "on" is displayed in the LCD. 
2. The LCD will then automatically display the selected channel.

 :Channel indicator.

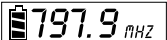
 :Press and hold the Up or Down button to display the corresponding frequency.

C. Switch Off steps:

1. Press and hold power switch for about two seconds until the LCD displays OFF.



D. Channel/Frequency Settings (with power on):

1. Press the SET button and hold for about 2 seconds.
2. The Channel number display will start flashing.
3. Press the Up button to display a higher numbered channel.

4. Press the Down button to display a lower numbered channel.

5. Press the SET button to activate the selected channel.

E. LCD Indications:

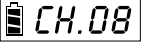
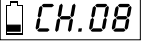
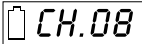

1.  :Three bars means batteries are fully charged.
2.  :One bar indicates low batteries. Replace or recharge the batteries.
3.  :No bars showing indicates batteries are exhausted and after flashing three times the power will automatically shut off.

F. Battery Charging Steps:

1. Rechargeable batteries need to be NiMH AA 1.2V with an amperage of 2100mAH or less as the charging function is limited to batteries of that rating.

2.Recharging is best accomplished by using the AS-DCTVHH charger

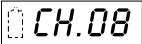
3. Charging status:

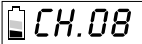
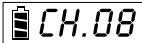
- a.  Battery indicator flashing: Non-Rechargeable batteries installed or no batteries installed. Check the batteries.
- b.  Battery indicator is flashing and LCD backlight is on: Failing, sorroded, or over-temperature batteries.
- c.  One or two bars showing: Batteries are charging successfully.
- d.  Three bars showing: Batteries have been fully charged.

* Please note the microphone will be turned off automatically while it is being charged.

G. Troubleshooting:

1. **LED doesn't light when power switch is pressed to turn on mic.**
 - a. Make sure that the batteries are not discharged.
 - b. Make sure that the batteries are installed correctly.
2. **LCD shows Err when power switch is pressed to turn mic off.**
 - a. Press the SET, UP and DOWN buttons at the same time in order to turn the microphone off automatically. The LCD display will flash about ten times and then the microphone will turn off automatically. The microphone should now turn on and off normally.
 - b. If the problem persists, call for service.
3. **LCD panel shows unusual indications.**
 - a. Remove the batteries from the microphone and re-install them.
4. **No audio from microphone.**
 - a. Check that the frequency of the transmitter is the same as that of the receiver.
 - b. Make sure that the Mic switch is not set to Mute.
 - c. Check if the distance between the transmitter and the receiver is too great.
 - d. Check if the transmitter or the receiver is too close to any large metal objects.
5. **Interference and signal Disturbance.**
 - a. Make sure there are no other wireless systems operating on the same frequency in the same area. This includes Microphones, televisions, radio stations, etc. Try setting the transmitter and receiver to a new channel.

H. Q&A

1. **Q:** How long can the microphone be operated with fully charged batteries?
A: Re-chargeable batteries will last approximately 8 to 10 hours. Disposable batteries will last approximately 13 hours.
- Q:** How much time is required to recharge batteries from a fully exhausted state?
A: Approximately 4 to 5 hours.

Description of Functions for Body Pack Transmitter AS-TVMBP

1. Mini XLR Mic input jack (TA3M)
2. Power switch
3. Mute button
4. Antenna
5. Power light
6. Charging Jack
7. LCD light
8. Set button
9. Channel select button
10. Sensitivity control
11. 3.5mm aux input jack
12. Belt clip
13. Battery compartment
14. Battery cover

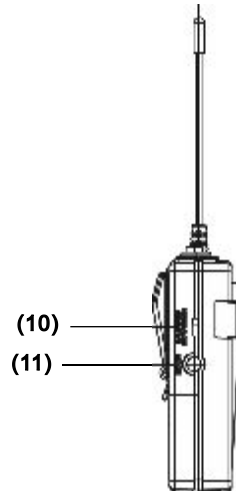
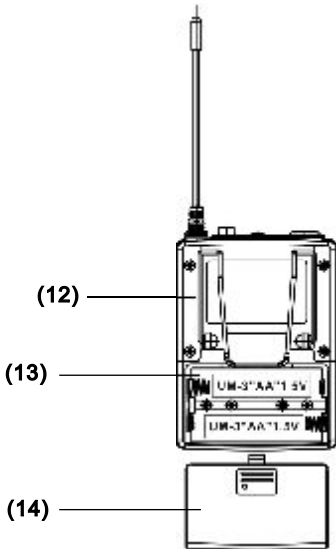
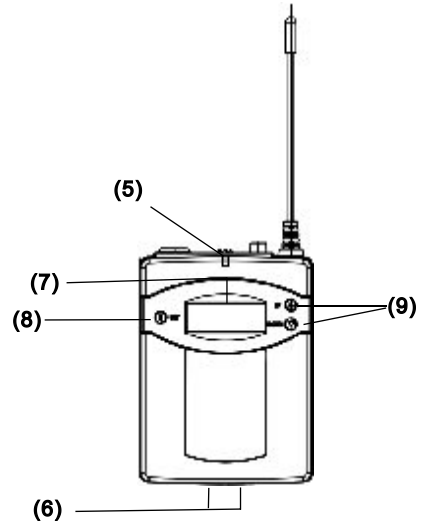
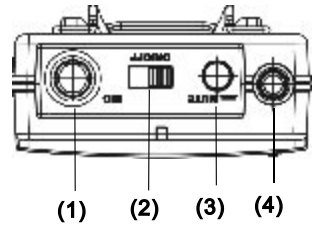

Operation of Bodypack Transmitter

A. Battery Installation:

1. Switch the transmitter off before inserting batteries.
2. Slide the battery cover off.
3. Insert 2 disposable batteries (1.5V AA) or 2 rechargeable batteries (1.2V AA).
4. Observe correct polarity when inserting batteries.
5. Slide the battery cover back to its original position.

B. Turning unit on:

1. Switch the power to ON position
2. The RED LED will light and the LCD will display "On".



Battery status and channel will then appear.



If no other operation is performed, LCD light will go off automatically in 5 seconds.

C. Channel/Frequency Settings:

1. Press and hold the SET button for approximately 2 seconds until the channel number flashes.
2. Release the SET button and the current channel will keep flashing
3. Press the UP or DOWN buttons to select a different channel.
4. When the desired channel is displayed press the SET button again. The display will stop flashing and stay on the channel selected.
5. Press and hold the UP or DOWN buttons to display the frequency associated with the channel number selected.

D. LCD Indications:

1. Batteries fully charged and channel 08 selected.
2. One bar displayed indicates low-battery. The batteries need to be changed or rechargeable batteries need to be recharged.
3. No bars displayed indicates the batteries are exhausted and after flashing three times, the power will automatically shut off.

E. Battery Charging Steps:

1. Insure that the batteries are the rechargeable type.
2. Switch Power to OFF position.
3. Insert AS-TVMBP into its own intelligent charger stand (AS-DCTVMBP).
4. Batteries will recharge automatically.
5. For more details of charger stand please refer to AS-DCTVMBP user guide.

F. Turning the unit OFF:

1. Slide the power switch to the OFF position.

2. LCD display will show "OFF"

OFF

If there is no further operation, the Power LED and LCD will switch off automatically.

G. Troubleshooting

1. No LCD display when the unit is switched on.
 - a. Make sure the batteries are not discharged.
 - b. Make sure the batteries are installed correctly.
2. LCD shows Err when switched on.
 - a. Switch power OFF, repeat steps for turning unit on.
 - b. If the problem persists, call for service
3. No Audio from Transmitter.
 - a. Check that the Transmitter and Receiver are on the same channel.
 - b. Check if "MUTE" is activated.
 - c. Check if the volume control of the receiver is set to a proper position.
 - d. Check if the Transmitter and Receiver are within the operating distance range.
4. Interference and signal disturbances.
 - a. When two Transmitters are being used, select different frequencies. If voice disturbance still occurs try selecting another channel until interference is gone.
 - b. Make sure there are no other wireless systems operating on the same frequency in the area. This includes other wireless microphones, television or radio stations, etc. Try setting the Transmitter and Receiver to a new channel.

Maintenance

Avoid Excessive Heat

Don't leave transmitter or receiver in hot sun, on a radiator, or near other sources of high temperature.

Avoid Rough Handling

The transmitter and receiver may be damaged if dropped.

Storage

Before storage, fully charge the batteries in both transmitters and receivers. If possible, recharge once a month during storage and again before first use.

Storage (Long term)

Remove the internal batteries when storing the units for a long period of time.

Replacing Batteries

Observe the correct polarity when installing batteries. Replace batteries only with the same or equivalent type.

Battery Terminals

Keep the contacts clean and inspect them often to insure they are not corroded. If they become corroded, polish them with a pencil eraser.

AS-TXRM Stationary Transmitter

The AS-TXRM is a stand alone version of our AS-TVTX Audio Link Transmitter module. The module is housed in a standard half-rack sized enclosure, and includes a variety of inputs and outputs as well as mixing controls. The TXRM is great for transmitting the entire mix from a mixing console to one or more Traveler speakers equipped with wireless receivers.

TXRM Stationary Transmitter

Front Panel

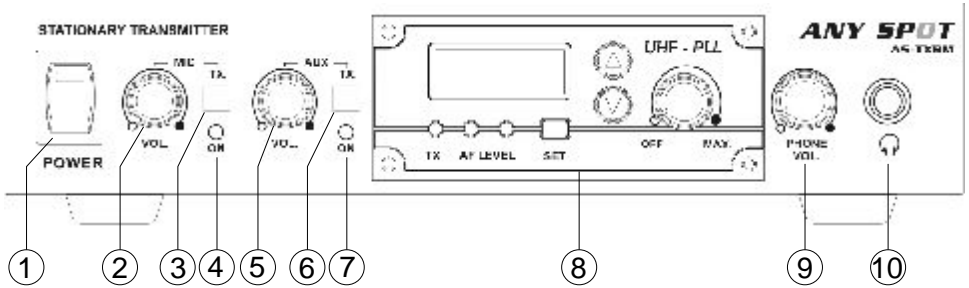

Rear Panel

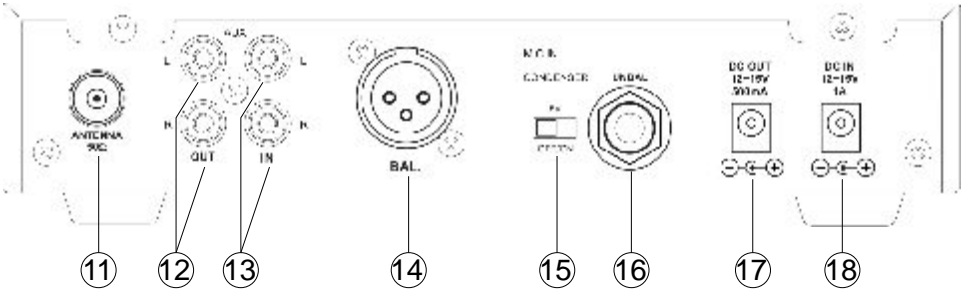

1. Power Switch w/ LED
2. Mic Volume
3. Mic On/Off Switch
4. Mic On LED
5. Aux Volume
6. Aux On/Off Switch
7. Aux On LED
8. Transmitter Module
9. Headphone Volume

10. Headphone Output
11. Antenna Connector
12. L/R Aux Outputs
13. L/R Aux Inputs
14. Balanced Mic Input
15. 5v DC Mic Switch
16. Unbalanced Mic Input
17. 12-15v DC Output
18. 12-15v DC Input

Setup and Operation of TXRM (See Page 24)

1. Starting with both the main power switch off (1) and the transmitter (8) power switch off, plug the included power supply into the DC In jack (18), and then plug the other end into an AC outlet. Connect the supplied antenna to the Antenna Jack (11).
2. Set all volume controls (2), (5), & (9) to the minimum. Set the input TX switches (3) and (6) to off, and then switch on the power (1).
3. Connect the desired source devices (such as a microphone or line output of a mixer) to the appropriate TXRM inputs. The XLR input (14) will accept balanced mic level signals. The ¼" input (16) will accept unbalanced mic level signals, and provide 5v DC to condenser mics when desired, by activating the switch (15). These two inputs are controlled by the Mic Volume (2) and TX switch (3). The L/R Aux Inputs will accept a stereo line level signal, and are controlled by the Aux Volume (5) and TX switch (6). When the TX switches (3) and (6) are engaged, the respective LEDs (4) and (7) will light, indicating that the input signal is being sent to the Transmitter Module (8) and the L/R Aux Output jacks.
4. Switch on the Transmitter Module (8) and set it according to the Audio Link System instructions provided on page 12.
5. Set the receiver(s) according to the Wireless Mic Receiver instructions provided on page 11.
6. Start sending a signal from the source device and set various volume controls (in the signal chain from the source to the receiving device) to the desired levels. It is important to set the gain structure properly to achieve the best signal to noise ratio. Normally you will want to set the output of the source as high as possible without causing distortion to the input of the following device, and so on down the line.
7. Signals sent to the L/R Aux Input will appear at the Headphone Jack (10) and be controlled by the Phone Volume (9). Note: Signals from the Mic Inputs (14) and (16) do not appear at the Headphone Jack.
8. The DC Output Jack (17) supplies 12v DC for charging or powering other devices. Make sure any device connected to this jack complies with the voltage and current rating listed for this jack.

CAUTION

Danger of explosion if the battery is incorrectly installed.
Replace only with the same or the equivalent type.



TV8

Specifications Portable Amplifier Speaker

◦ Sensitivity	92 dB, 1Watt @ 1 M
◦ Maximum SPL	112 dB
◦ Frequency response	70 Hz ~ 20 kHz (audio)
◦ Speakers	8" LF woofer, 1" HF horn
◦ Receiver module	AS-TVREC x 2 @ diversity
◦ Output power	50 W RMS, 80 W MAX.
◦ Signal to noise ratio	Up 70 dB
◦ CD/CMP player	AS-CD (optional)
◦ Audio link TX	AS-TVTX transmitter (optional)
◦ Audio input	XLR-Mic. In, RCA-Line in
◦ Audio output	RCA-Line out, SPK Out (unswitched)
◦ Controls	Mic., Line, Bass, Treble, Master
◦ Power requirement	100-240V AC 50/60Hz
◦ Battery	12V, 2.9Ah * 2 (Lead-Acid) rechargeable batteries
◦ Operating life	4 ~ 6 Hours
◦ Charging time	4 ~ 6 Hours
◦ Dimensions (D x W x H)	12" x 9" x 18.5" (300 x 230 x 470 mm)
◦ Weight	26.5lbs (12 kg)

◦ Sensitivity	92 dB, 1Watt @ 1 M
◦ Maximum SPL	112 dB
◦ Frequency response	70 Hz ~ 16 kHz (audio)
◦ Speakers	5" Full Range
◦ Receiver module	AS-TVREC x 2 @ diversity
◦ Output power	30 W RMS, 50 W MAX.
◦ Signal to noise ratio	Up 70 dB
◦ Optional Media Player	AS-TVF (optional)
◦ Audio input	¼"-Mic. In, 1/8"-Aux In
◦ Audio output	1/8"-Aux Out,
◦ Controls	Master, Tone, Aux In, Mic
◦ Power requirement	100-240V AC 50/60Hz Power Supply/Charger
◦ Battery	12V, Ah * (Lead-Acid) rechargeable battery
◦ Operating life	4 ~ 6 Hours
◦ Charging time	4 ~ 6 Hours
◦ Dimensions (D x W x H)	10.25" x 8.25" x 11.5" (260 x 210 x 292 mm)
◦ Weight	9lbs (4.1 kg)

Wireless Mic/Audio link Receiver Module

• Oscillation type	PLL synthesized control OSC
• Adjustable frequency	Pre-programmed max. 96 switchable channels
• Switching bandwidth	Max. 12 MHz
• Ambient temperature	-10 °C ~ 50 °C
• Maximum deviation	50 kHz, with level limiting
• Dynamic range	110 dB
• T. H. D.	Less than 0.5%
• Pre/De- emphasis	50 μ s
• Squelch	Tone key and noise lock dual-squelch
• Frequency response	70 Hz ~ 16 kHz (wireless)
• Operating range	160 - 230 feet (50 ~ 70 M) (open field) with built-in antenna
• Antenna mode	Diversity
• Sensitivity	4 μ V @ 30 dB SINAD
• Double intermediate	110.6 Mhz / 10.7 MHz
• Display status	LCD indicator displays channel or frequency
• Channel select	SET, UP, DOWN keys
• RF spurious rejection	70 dB
• Adjacent channel performance	68 dB @ 250kHz
• IMD rejection	58 dB
• Carrier frequency range	Group M. 600 ~ 640 MHz (96 ch.)

Continued on page 29

Wireless Mic/Audio link Receiver Module (continued)

◦ Antenna	Built-in or external
◦ Dimensions (L x W x H)	5.25" x 3.46" x 1.45" (133 x 88 x 37 mm)
◦ Weight	3.88 oz. (110 g)

Audio Link Transmitter Module (also used in TXRM)

◦ RF output	10mW
◦ Spurious emission	Less than 250 nW
◦ Display status	LCD indicator displays channel or frequency
◦ Channel select	SET, UP, DOWN keys
◦ Antenna	Built-in or external
◦ Dimensions (L x W x H)	4.25" x 7.5" x 1.75" (108 x 190 x 44 mm)
◦ Weight	5.99 oz. (170 g)

Digital Echo Module

◦ Input sensitivity	10 mV
◦ Delay time	110 ms ~ 340 ms
◦ Audio input	6.3 ϕ -Mic in * 2 TRS, Low 2
◦ Controls	Echo, Repeat, Delay, MIC1, MIC2

Handheld Microphone

◦ Microphone type	Cardioid dynamic capsule
◦ RF output	10mW
◦ Spurious emission	Less than 250 nW
◦ Display status	LCD indicator displays channel or frequency, battery condition

Continued on page 30

◦ Channel select	SET, UP, DOWN keys
◦ AF controls	Hi/Low/Mute switch
◦ Battery	1.2 V (Ni-MH 1300 mAh) * 2 AA type rechargeable battery 1.5V * 2 AA Alkaline disposable
◦ Battery life Ni-MH rechargeable	11 hours typical
◦ Battery life Alkaline disposable	14 hours typical
◦ Antenna	Built-in
◦ Dimensions (Dia x L)	1.8" x 10.4" (46 x 264 mm)
◦ Weight with battery	9.87 oz. (280 g)

Bodypack Transmitter

◦ Microphone Type	Condenser mic.
◦ RF output	10mW
◦ Spurious emission	Less than 250 nW
◦ Display status	LCD indicator displays channel or frequency, battery life
◦ Channel select	SET, UP, DOWN keys
◦ AF controls	Mute switch, Hi/Mid/Low switch
◦ Audio input	Mic in, Aux in
◦ Battery	1.2 V (Ni-MH 1300 mAh) * 2 AA type rechargeable battery 1.5V * 2 AA Alkaline disposable
◦ Battery life Ni-MH rechargeable	11 hours typical
◦ Battery life Alkaline disposable	14 hours typical
◦ Housing	Aluminium
◦ Dimensions (D x W x H)	1.04" x 2.52" x 3.48" (27 x 64 x 88 mm)
◦ Weight with battery	4.48 oz. (127 g)

REGISTRATION CARD

Registration information is used ONLY by GALAXY AUDIO and will be kept strictly confidential.

Registration

Name _____ Phone _____
Address _____
City, State, Zip _____
email _____
Dealer _____ Purchase Date _____

Serial number

Model

This Galaxy Audio product will be used for:

- Live Sound
Church
Recording
Home/Project Studio
Commercial Studio
Post-Production/Mastering

Broadcast

- On-Air
Production

What magazines do you read? _____

How can Galaxy Audio better serve you?

PLACE
STAMP
HERE

GALAXY AUDIO
P.O. BOX 16285
WICHITA, KS 67216-0285

LIMITED WARRANTY

This warranty gives you specific legal rights, and you may also have other rights which may vary from state to state. This warranty is extended to the purchaser and to any purchaser from him for value.

GALAXY AUDIO warrants the materials and workmanship of its products from the date of the original purchase.

1. Hot Spot Series, Micro Spot Series, Audio Solutions (including Cricket, Jacks In the Box, & Check Mate) are products covered by **3 year warranty**.
2. Any Spot Wireless, including Wireless Personal Monitor (WPM), Assistive Listening System, 500 Series Wireless Microphone, 700 Series Wireless Microphone, Lightweight Headset Microphones, Tour Guide/Translator System, Wireless Camera Kit are covered by a **1 year warranty**.
3. The Traveler is supported with a **3 year warranty** on speaker components and casing, and a **1 year warranty** on wireless and CD/MP3 player components.
4. Any units containing a battery will have a 90 day warranty on the battery.

The following are not covered by the warranty:

1. Damage to or deterioration of the exterior cabinet which occurs after delivery.
2. Damage after initial delivery resulting from accident, misuse or neglect.
3. Damage resulting from failure to follow instructions contained in the owner's manual.
4. Damage resulting from the performance of repairs by someone other than GALAXY AUDIO or an authorized GALAXY AUDIO service center.
5. Damage occurring during the shipment or delivery of any GALAXY AUDIO product to GALAXY AUDIO or an authorized service center after initial delivery of the product to you.
6. Damage to any GALAXY AUDIO product which has been altered, or on which the serial number has been effaced or removed.

If your unit requires service, it must be returned, shipping charges prepaid to GALAXY AUDIO in the United States. (This warranty is not enforceable outside the U.S.) Please call or write GALAXY AUDIO, 601 E. Pawnee, Wichita, Kansas 67211, (316) 263-2852. We will then issue you to an RMA# (Return Merchandise Authorization) which will need to be applied to the returned item. Under no circumstances should you return your unit to the factory without receiving an RMA or written instruction to do so. If service is required, you must present the original or a copy of the bill of sale as a proof of date of purchase of your unit. Upon receipt of your unit for service, GALAXY AUDIO will repair or replace your unit as soon as possible, but in no event later than 30 days after the receipt of the unit. We will return the unit to you, shipping charges prepaid, provided the necessary repairs are covered by this warranty.

IMPLIED WARRANTIES OF MERCHANTABILITY AND FITNESS FOR PARTICULAR PURPOSE ARE LIMITED IN DURATION TO THE LENGTH OF THIS WARRANTY, UNLESS OTHERWISE PROVIDED FOR BY STATE LAW. GALAXY AUDIO'S LIABILITY IS LIMITED TO THE REPAIR OR REPLACEMENT, AT OUR OPTION, OF ANY DEFECTIVE PRODUCT, AND SHALL IN NO EVENT INCLUDE INCIDENTAL OR CONSEQUENTIAL DAMAGES OF ANY KIND. SOME STATES DO NOT ALLOW LIMITATIONS ON HOW LONG AN IMPLIED WARRANTY LASTS AND/OR DO NOT ALLOW THE EXCLUSION OR LIMITATION OF INCIDENTAL OR CONSEQUENTIAL DAMAGES, SO THE ABOVE LIMITATIONS AND EXCLUSIONS MAY NOT APPLY TO YOU.

GALAXY AUDIO does not authorize any third party, including any dealer or Authorized Service Center, to assume any liability on behalf of GALAXY AUDIO or to make any warranty for GALAXY AUDIO.



MAKERS OF THE ORIGINAL HOT SPOT PERSONAL MONITOR