

IMPACT SERIES ENGINEERING INFORMATION

The Impact series of full range, passive loudspeakers has been designed to be used in a variety of installed sound system applications, both indoors and outdoors, ranging from cafes and restaurants, clubs and wine bars to theatres, mass transport facilities, retail environments and places of worship.

Impact series enclosures are injection-moulded using unique gas-injected glass filled fire-retardant ABS plastic, giving an elegantly stylish and extremely durable finish, plus the added benefit of IP54 weather resistance making them suitable for installation outdoors or in humid conditions.

The Impact 55T is a compact passive two-way reflex design loudspeaker using a proprietary 5" low frequency drive unit matched to a 1" neodymium ferrofluid-cooled HF tweeter with an internal passive crossover network. It is supplied as standard with a multi-tapped internal line transformer for use in 70 volt line and 100 volt line distributed systems, and includes a low impedance setting. The Impact 55T will provide high quality sound reproduction from an unobtrusive cabinet designed to blend effectively into any decor.

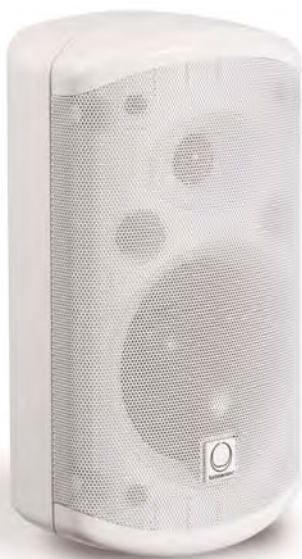

The low frequency range of the Impact 55T can easily be extended with subwoofers from the TSB range of bandpass enclosures. Passive subwoofers such as the TSB-110 provide sub-bass support without the need for additional crossovers and amplifiers by connecting to the Impact satellite speakers through the passive crossover built into the subwoofer.

The Impact 55T is supplied with a universal adjustable wall mounting bracket which provides the loudspeaker connections as an integral part of the bracket assembly. This facility allows the brackets to be sited, installed and wired independently of the loudspeakers being available on-site, making the final installation and commissioning of the loudspeaker system a greatly simplified process. The cabinet also provides M6 fixings for use with CB-10 wall brackets, WB-10 ceiling brackets and OmniMount™ brackets

A 3/8" threaded insert is provided behind an EPDM rubber cover on the bottom of the cabinet for use with microphone stands as a spot monitor.

The drive units are protected by a perforated stainless steel grille which, together with the moulded cabinet, provides IP54 weather resistance suitable for outdoor applications.

FEATURES

70v/100v line transformer with low impedance tap

Compact injection-moulded enclosure

IP54 weather resistance

Wall bracket with integral connections

Passive crossover

Paintable enclosure

OmniMount™ compatible

APPLICATIONS

Cafés and bars

Restaurants

Retail shops

Sports and Leisure

Discotheques and Clubs

Themed environments

Houses of Worship

DIMENSIONS (HxWxD)	300mm x 164mm x 158mm (11.8" x 6.5" x 6.2")														
NET WEIGHT	3.5kg (7.7lbs)														
COMPONENTS	1 x 5" (127mm) LF driver, 1 x 1" (25mm) ferrofluid-cooled neodymium HF tweeter														
FREQUENCY RESPONSE¹	89Hz – 20kHz ±3dB, 64Hz – 20kHz ±10dB														
NOMINAL DISPERSION²	100°H x 70°V @ -6dB points														
POWER HANDLING	80 watts continuous, 160 watts program														
SENSITIVITY	90dB SPL, 1 watt @ 1metre														
CALC. MAXIMUM SPL	109dB continuous, 115dB peak														
NOMINAL IMPEDANCE	16 ohms														
LINE TRANSFORMER	Transformer taps at 60 watts, 30 watts, 15 watts (100v line); 60 watts, 30 watts, 15 watts, 7.5 watts (70v line), and low impedance setting														
CROSSOVER	Internal passive crossover at 2.5kHz, 12dB/octave														
CONSTRUCTION	Gas injected glass-filled ABS enclosure														
GRILLE	Powder-coated perforated stainless steel														
MOUNTING	Two M6 fixing points for WB-5 wall bracket (supplied). Compatible with WB-10 wall bracket and CB-10 ceiling bracket, and OmniMount brackets														
CONNECTORS	Colour coded binding posts														
STANDARDS	Fire retardant V0 ABS														
OPTIONS	Available colours: White, Black														
SPARES AND ACCESSORIES	<table border="0"> <tr> <td>LS-50</td> <td>LF driver</td> </tr> <tr> <td>TW-52</td> <td>HF tweeter</td> </tr> <tr> <td>PX-55</td> <td>Passive crossover network</td> </tr> <tr> <td>MG-IMP55</td> <td>Metal grille</td> </tr> <tr> <td>WB-5</td> <td>Adjustable wall bracket</td> </tr> <tr> <td>WB-10</td> <td>Wall bracket</td> </tr> <tr> <td>CB-10</td> <td>Ceiling bracket</td> </tr> </table>	LS-50	LF driver	TW-52	HF tweeter	PX-55	Passive crossover network	MG-IMP55	Metal grille	WB-5	Adjustable wall bracket	WB-10	Wall bracket	CB-10	Ceiling bracket
LS-50	LF driver														
TW-52	HF tweeter														
PX-55	Passive crossover network														
MG-IMP55	Metal grille														
WB-5	Adjustable wall bracket														
WB-10	Wall bracket														
CB-10	Ceiling bracket														

All measurements are actual figures taken from real-time testing using stated inputs, free from any filtering or weighting. Therefore actual figures may significantly exceed that of other manufacturers with higher published weighted ratings.

Notes

¹Measured on axis

²Average over stated bandwidth.

FREQUENCY RESPONSE

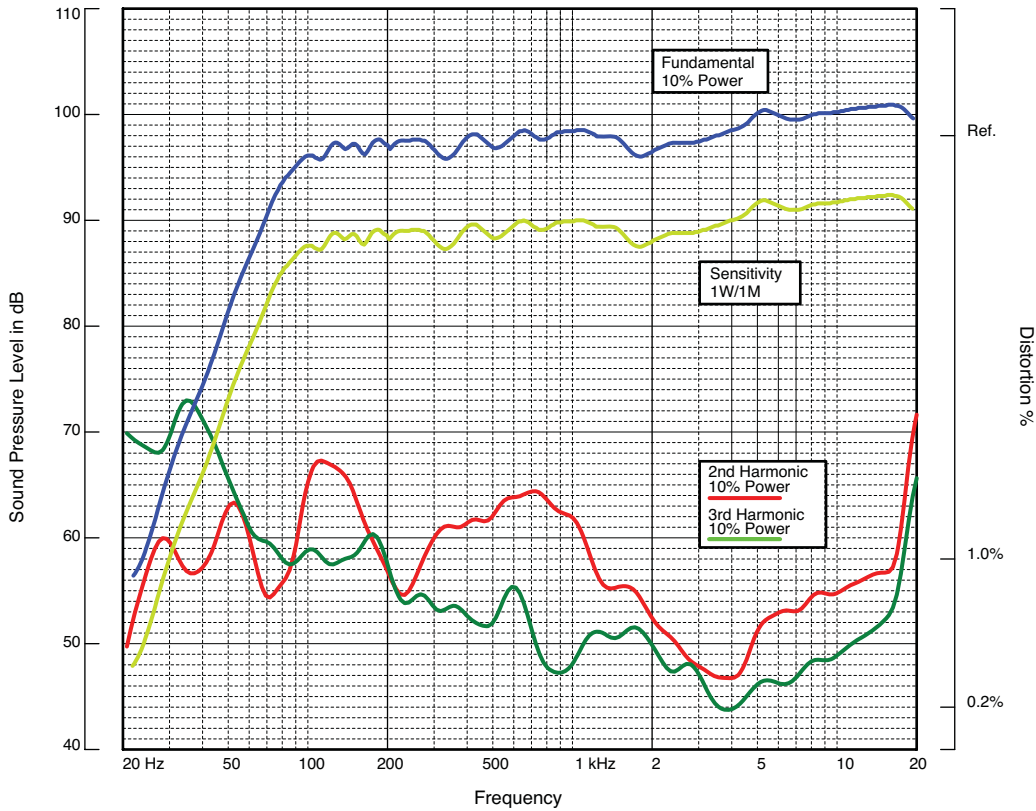

IMPEDANCE

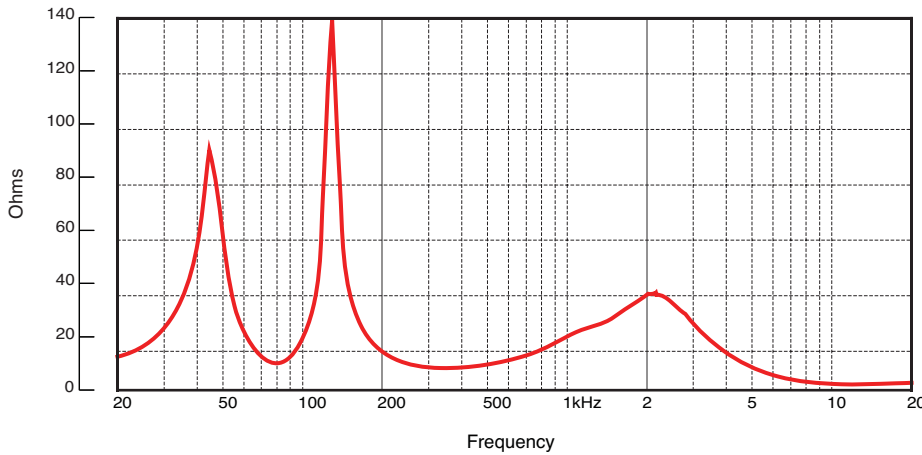

Impedance A constant current circuit was used to measure the impedance. **Frequency response** The frequency response shown was obtained by feeding a swept sine wave through the system in a half space environment. The position of the microphone was vertically on-axis at a distance of 2 metres, then scaled to represent 1 metre. **2nd & 3rd Harmonic Distortion** Distortion measurements were obtained using an Audio Precision harmonic distortion analysis system and comply with AES recommendations for enclosure measurement (AES paper ANSI S4-26-1984). **Data Conversion** All graphs were digitally generated using the APEX custom software system, designed to translate data derived from Audio Precision 'System One' test equipment into AutoCAD™. This program enables graphical information to be plotted to a high degree of accuracy.

NOTES ON MEASUREMENT CONDITIONS

HORIZONTAL THIRD OCTAVE POLARS

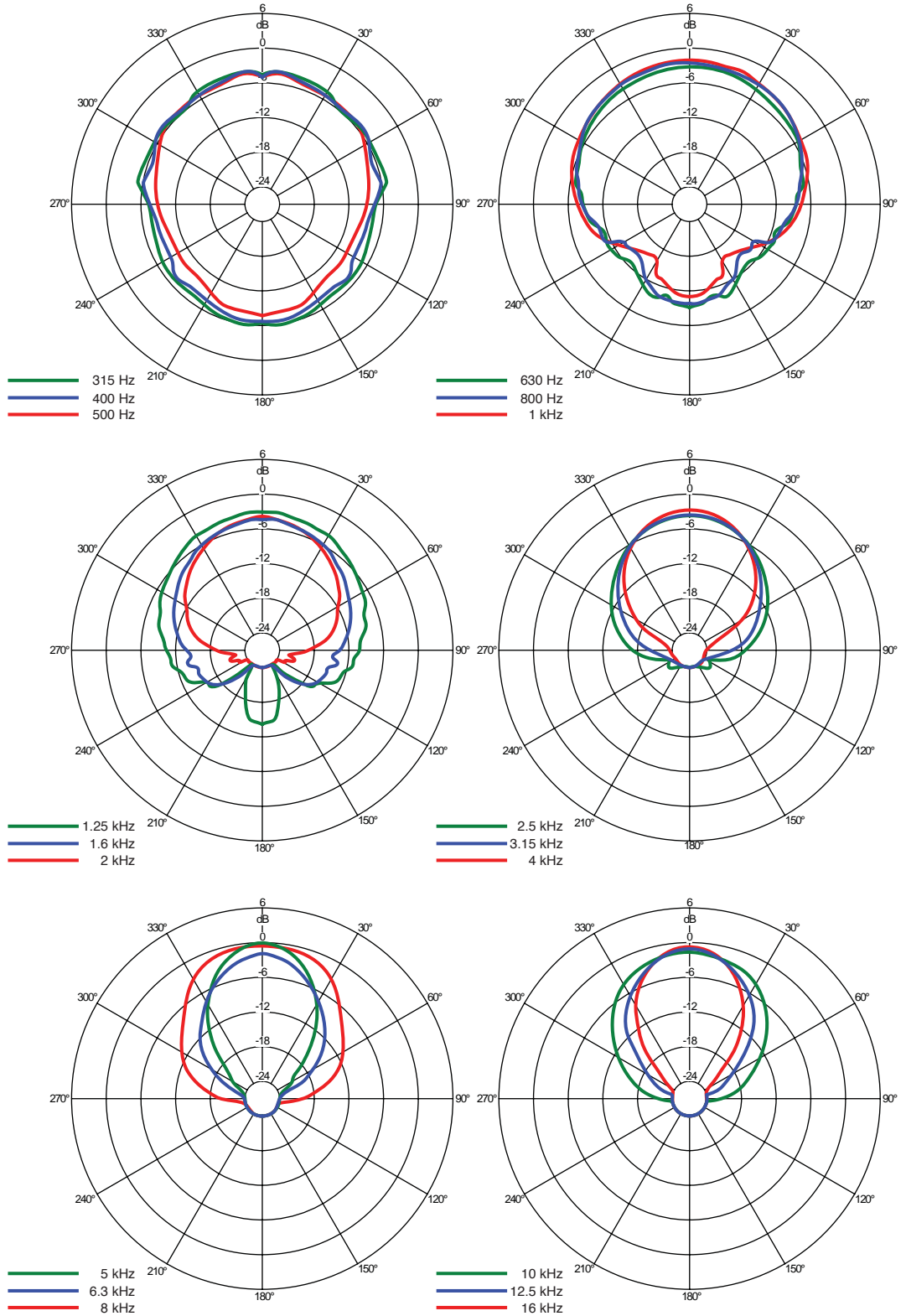

**VERTICAL THIRD
OCTAVE POLARS**

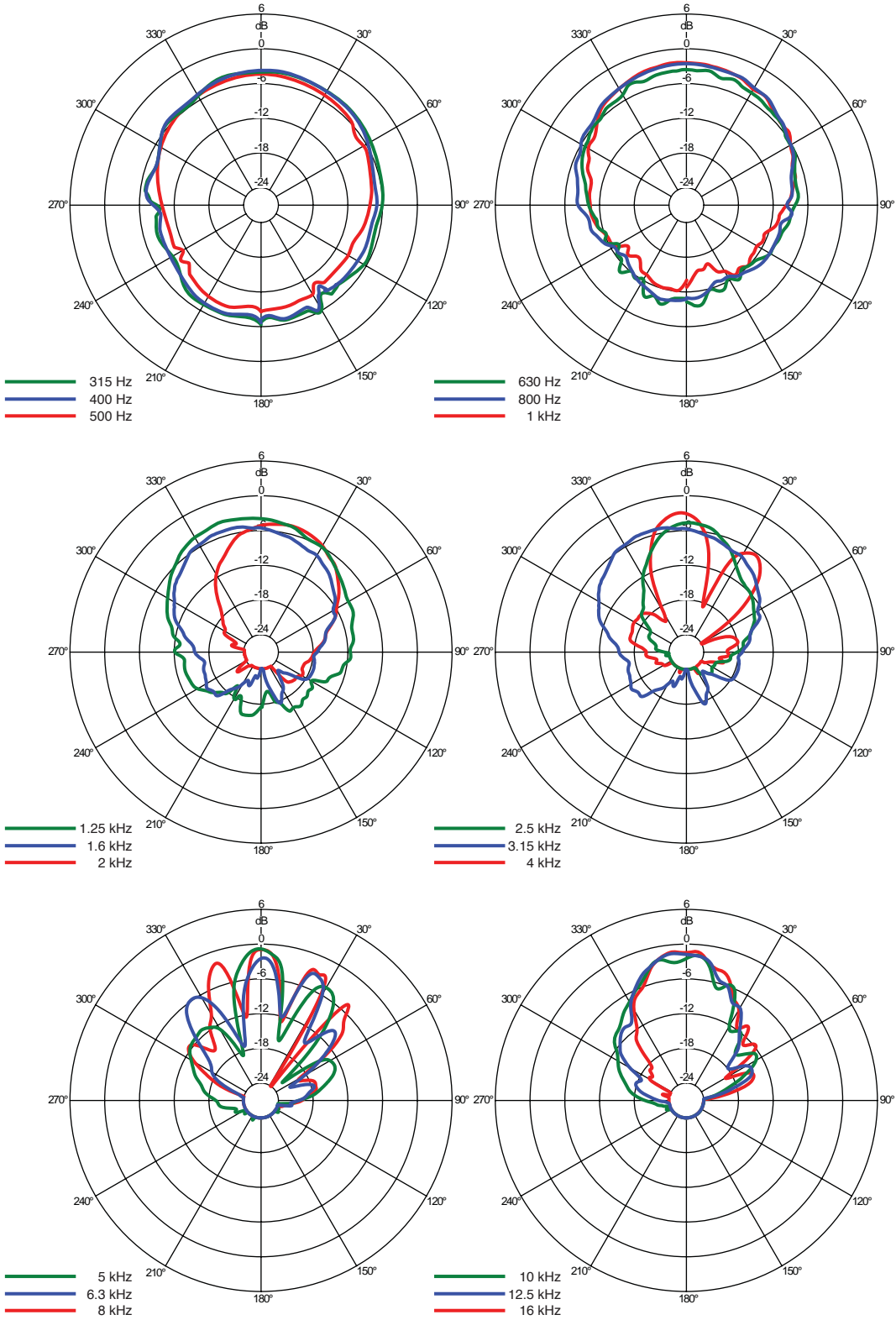

**HORIZONTAL
DIRECTIVITY**

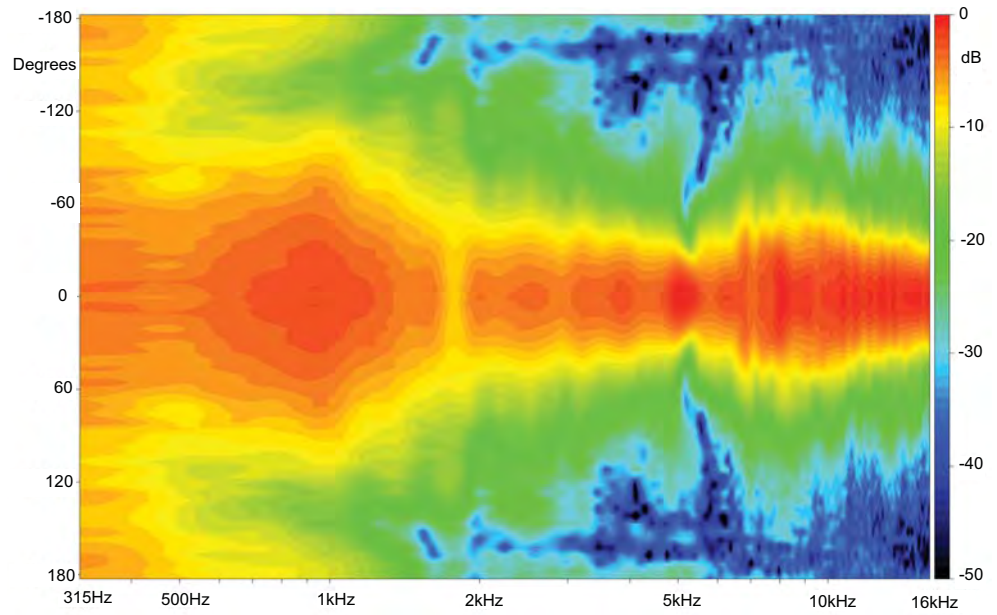

**VERTICAL
DIRECTIVITY**

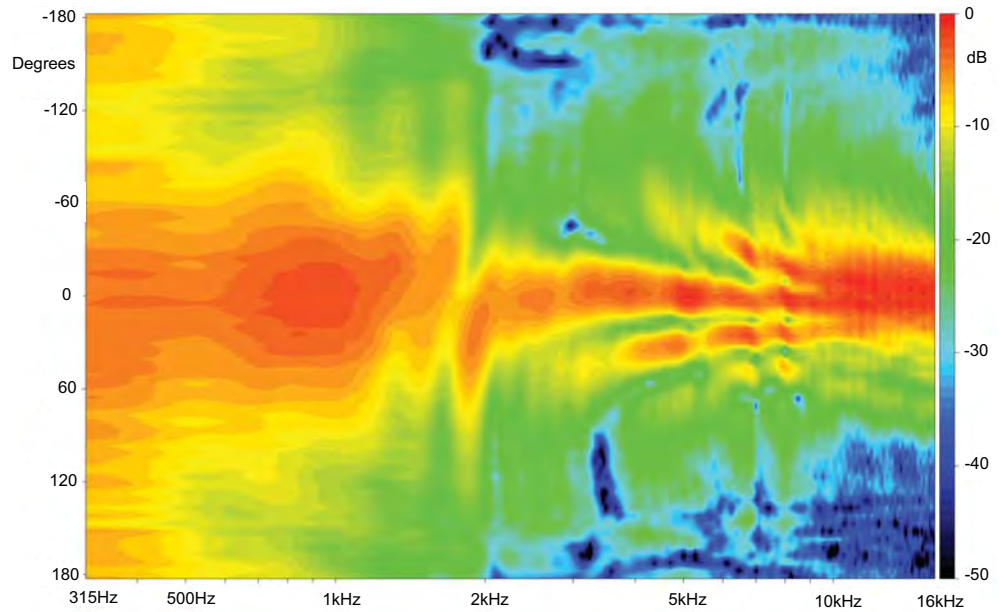

IMPACT SERIES ENGINEERING INFORMATION

The supplied wall bracket provides integral electrical connections to the loudspeaker, allowing the brackets to be installed independently of the loudspeakers being available on site. It allows for a wide range of adjustment angles in both horizontal and vertical planes.

The cabinet can also be installed using CB-10 ceiling brackets and WB-10 wall brackets, as well as with OmniMount™ wall and ceiling brackets.

A threaded insert is also provided on the bottom of the cabinet, and this can be used to attach the loudspeaker to standard 3/8" microphone stand fittings.

INSTALLATION HARDWARE

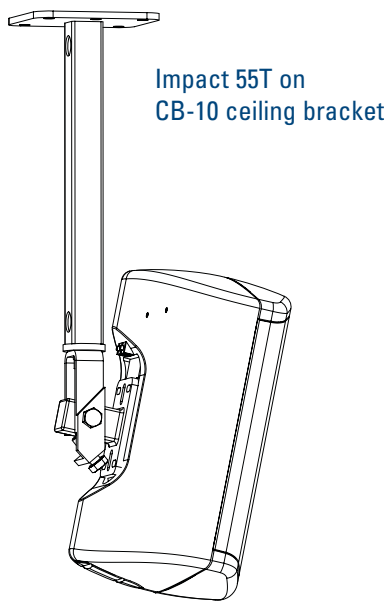

Impact 55T on
WB-10 wall bracket

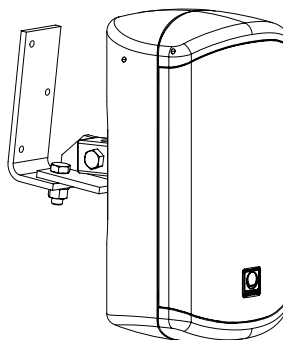

**ARCHITECTURAL
& ENGINEER'S
SPECIFICATIONS**

The system shall be of the two-way passive type consisting of one 5" (127mm) low frequency loudspeaker and one 1" (25mm) high frequency tweeter and shall be supplied with an adjustable wall bracket providing integral electrical connections. Performance specifications of a typical production unit shall meet or exceed the following: Frequency response, measured with swept sine wave input, shall be flat within $\pm 3\text{dB}$ from 89Hz to 20kHz, and within $\pm 10\text{dB}$ from 64Hz to 20kHz. Nominal dispersion, at -6dB points, shall average $100^\circ\text{H} \times 70^\circ\text{V}$. Nominal impedance shall be 16 ohms. Power handling shall be 80 watts continuous, 160 watts program. Sensitivity, measured with 1 watt input at 1 metre distance on axis, mean averaged over stated bandwidth shall be 90dB. Maximum SPL (peak) measured with music program input at stated amplifier power shall be 115dB. Dimensions: 300mm x 164mm x 158mm (11.8" x 6.5" x 6.2"). Net weight: 3.5kg (7.7lbs). The loudspeaker system shall be the Turbosound Impact 55T. No other loudspeaker shall be acceptable unless submitted data from an independent test laboratory verify that the above combined performance / size specifications are equalled or exceeded.

DIMENSIONS

