

SONY[®]

3-875-814-11(2)

■ Multi Channel
■ AV Receiver

Operating Instructions
STR-DA6400ES



* 3 8 7 5 8 1 4 1 1 * (2)

Printed in Malaysia

<http://www.sony.net/>

©2008 Sony Corporation

WARNING

To reduce the risk of fire or electric shock, do not expose this apparatus to rain or moisture.

To reduce the risk of fire, do not cover the ventilation opening of the apparatus with newspapers, tablecloths, curtains, etc. Do not place the naked flame sources such as lighted candles on the apparatus.

Do not install the appliance in a confined space, such as a bookcase or built-in cabinet.

To reduce the risk of fire or electric shock, do not expose this apparatus to dripping or splashing, and do not place objects filled with liquids, such as vases, on the apparatus.

As the main plug is used to disconnect the unit from the mains, connect the unit to an easily accessible AC outlet. Should you notice an abnormality in the unit, disconnect the main plug from the AC outlet immediately.

Do not expose batteries or apparatus with battery-installed to excessive heat such as sunshine, fire or the like.

The unit is not disconnected from the mains as long as it is connected to the AC outlet, even if the unit itself has been turned off.

Excessive sound pressure from earphones and headphones can cause hearing loss.

For customers in the United States



This symbol is intended to alert the user to the presence of uninsulated "dangerous voltage" within the product's enclosure that may be of sufficient magnitude to constitute a risk of electric shock to persons.



This symbol is intended to alert the user to the presence of important operating and maintenance (servicing) instructions in the literature accompanying the appliance.

For customers in the United States and Canada

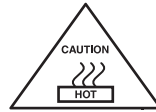

This symbol is intended to alert the user to the presence of the Hot Surface that may be hot if it is touched during the normal operation.

Owner's Record

The model and serial numbers are located on the rear of the unit. Record these numbers in the space provided below. Refer to them whenever you call upon your Sony dealer regarding this product.

Model No. _____ Serial No. _____

Important Safety Instructions

- 1) Read these instructions.
- 2) Keep these instructions.
- 3) Heed all warnings.
- 4) Follow all instructions.
- 5) Do not use this apparatus near water.
- 6) Clean only with dry cloth.
- 7) Do not block any ventilation openings. Install in accordance with the manufacturer's instructions.
- 8) Do not install near any heat sources such as radiators, heat registers, stoves, or other apparatus (including amplifiers) that produce heat.
- 9) Do not defeat the safety purpose of the polarized or grounding-type plug. A polarized plug has two blades with one wider than the other. A grounding type plug has two blades and a third grounding prong. The wide blade or the third prong are provided for your safety. If the provided plug does not fit into your outlet, consult an electrician for replacement of the obsolete outlet.
- 10) Protect the power cord from being walked on or pinched particularly at plugs, convenience receptacles, and the point where they exit from the apparatus.
- 11) Only use attachments/accessories specified by the manufacturer.
- 12) Use only with the cart, stand, tripod, bracket, or table specified by the manufacturer, or sold with the apparatus. When a cart is used, use caution when moving the cart/apparatus combination to avoid injury from tip-over.



- 13) Unplug this apparatus during lightning storms or when unused for long periods of time.
- 14) Refer all servicing to qualified service personnel. Servicing is required when the apparatus has been damaged in any way, such as power-supply cord or plug is damaged, liquid has been spilled or objects have fallen into the apparatus, the apparatus has been exposed to rain or moisture, does not operate normally, or has been dropped.

The following FCC statement applies only to the version of this model manufactured for sale in the U.S.A. Other versions may not comply with FCC technical regulations.

NOTE:

This equipment has been tested and found to comply with the limits for a Class B digital device, pursuant to Part 15 of the FCC Rules. These limits are designed to provide reasonable protection against harmful interference in a residential installation.

This equipment generates, uses and can radiate radio frequency energy and, if not installed and used in accordance with the instructions, may cause harmful interference to radio communications. However, there is no guarantee that interference will not occur in a particular installation. If this equipment does cause harmful interference to radio or television reception, which can be determined by turning the equipment off and on, the user is encouraged to try to correct the interference by one or more of the following measures:

- Reorient or relocate the receiving antenna.
- Increase the separation between the equipment and receiver.
- Connect the equipment into an outlet on a circuit different from that to which the receiver is connected.
- Consult the dealer or an experienced radio/TV technician for help.

CAUTION

You are cautioned that any changes or modifications not expressly approved in this manual could void your authority to operate this equipment.

To reduce the risk of electric shock, the speaker cord should be connected to the apparatus and the speakers in accordance with the following instructions.

- 1) Disconnect the AC power cord from the MAINS.
- 2) Strip 10 to 15 mm of the wire insulation of the speaker cord.
- 3) Connect the speaker cord to the apparatus and the speakers carefully so as not to touch the core of speaker cord by hand. Also disconnect the AC power cord from the MAINS before disconnecting the speaker cord from the apparatus and the speakers.

About This Manual

- The instructions in this manual are for model STR-DA6400ES. Check your model number by looking at the lower right corner of the front panel.
- The instructions in this manual describe the controls on the supplied remote. You can also use the controls on the receiver if they have the same or similar names as those on the remote.

About the supplied manual

STR-DA6400ES contains the following manuals. Refer to them as required by the operation.

STR-DA6400ES Operating Instructions (this manual)

This manual explains the operations of the system itself.

This manual mainly explains operations using the main remote commander, but most of the same operations can also be performed using the buttons and controls on the system having the same or similar names.

Using Network Features

This manual explains the operations of the network function of STR-DA6400ES.

It explains also how to install supplied “ES Utility” application software on your computer.

Quick Setup Guide

It explains how to connect components, speakers, and a subwoofer so that you can enjoy multi-channel surround sound.

GUI Menu List

GUI Menu List shows the menu tree of STR-DA6400ES.

On Copyrights

- “Neural-THX” and “neural THX” introduced in the Operating Instructions and displayed in the display window and on the GUI menu screen mean Neural-THX Surround.

This receiver incorporates Dolby* Digital and Pro Logic Surround and the DTS** Digital Surround System.

- * Manufactured under license from Dolby Laboratories.
Dolby, Pro Logic, Surround EX, and the double-D symbol are trademarks of Dolby Laboratories.
- ** Manufactured under license under U.S. Patent #'s: 5,451,942; 5,956,674; 5,974,380; 5,978,762; 6,226,616; 6,487,535 & other U.S. and worldwide patents issued & pending. DTS is a registered trademark and the DTS logos, Symbol, DTS-HD and DTS-HD Master Audio are trademarks of DTS, Inc. © 1996-2007 DTS, Inc. All Rights Reserved.

This receiver incorporates High-Definition Multimedia Interface (HDMI™) technology.

HDMI, the HDMI logo and High-Definition Multimedia Interface are trademarks or registered trademarks of HDMI Licensing LLC.

XM Ready® is a registered trademark of XM Satellite Radio Inc. All rights reserved.

©2008 SIRIUS Satellite Radio Inc. “SIRIUS” and the SIRIUS dog logo are registered trademarks of SIRIUS Satellite Radio Inc.

This product using Neural-THX® Surround is manufactured under license from Neural Audio Corporation and THX Ltd. Sony Corporation hereby grants the user a non-exclusive, non-transferable, limited right of use to this product under USA and foreign patent, patent pending and other technology or trademarks owned by Neural Audio Corporation and THX Ltd. “Neural Surround”, “Neural Audio”, “Neural” and “NRL” are trademarks and logos owned by Neural Audio Corporation, THX is a trademark of THX Ltd., which may be registered in some jurisdictions. All rights reserved.

The font type (Shin Go R) installed in this receiver is provided by MORISAWA & COMPANY LTD. These names are the trademarks of MORISAWA & COMPANY LTD., and the copyright of the font also belongs to MORISAWA & COMPANY LTD.

iPod is a trademark of Apple Inc., registered in the U.S. and other countries.

All other trademarks and registered trademarks are of their respective holders. In this manual, ™ and ® marks are not specified.

The Bluetooth word mark and logos are owned by the Bluetooth SIG, Inc. and any use of such marks by Sony Corporation is under license. Other trademarks and trade names are those of their respective owners.

“BRAVIA” is a trademark of Sony Corporation.

Table of Contents

Description and location of parts8

Getting Started

1: Installing speakers	22
2: Connecting speakers	24
3: Connecting the monitor	26
4a: Connecting the audio components	28
4b: Connecting the video components	33
5: Connecting the antennas (aerials)	43
6: Preparing the receiver and the remote	44
7: Displaying the GUI menu on the TV screen	45
8: Setting the speakers	46
9: Calibrating the appropriate speaker settings automatically (Auto Calibration)	48
Guide to on-screen display operation	55

Playback

Enjoying sound/images from the component connected to the receiver	58
Enjoying sound/images from the components connected to the DIGITAL MEDIA PORT	60
Operating the TDM-iP1/iP50 using the GUI menu of the receiver	62

Tuning

Listening to FM/AM radio	65
Presetting FM/AM radio stations	67
Listening to satellite radio	68
Connecting a satellite radio tuner	70
Preparing to listen to a satellite radio	70
Selecting a channel of the satellite radio	72
Presetting satellite radio channels	73
Restricting access to specific channels (Parental Lock) (SIRIUS only)	74

Enjoying Surround Sound

Playing back with 2-channel sound	78
Playing back with multi-channel surround	79
Enjoying a surround effect for music	82
Enjoying a surround effect for movies	84

Using Multi-zone Features

What you can do with the Multi-zone function	88
Making a multi-zone connection	89
Setting the speakers in zone 2	93
Switching the zone setting of the remote ...	94
Operating the receiver from another zone (ZONE 2/ZONE 3 operations)	95
Listening to the same music in different zone (Party Mode)	96

Using Other Features

Using “BRAVIA” Sync features	98
Switching the monitors that output the HDMI video signals	101
Switching between digital and analog audio	102
Enjoying the sound/images from other inputs (Input Assign)	103
Using the sleep timer	105
Enjoying the surround effect at low volume levels	106
Recording using the receiver	107
Switching the command mode of the receiver and the remote	108
Using a bi-amplifier connection	109

Adjusting Settings

Using the setting menu	111
Auto Calibration	112
Speaker settings	114
Surround settings	118
EQ settings	119
Multi Zone settings	120
Audio settings	121
Video settings	123
HDMI settings	126
Network Settings	127
Quick Click settings	128
System settings	128
Operating without connecting to a TV	129

Additional Information

Glossary	161
Precautions	164
Troubleshooting	165
Specifications	171
Index	173

Using the Remote

Operating each component using the remote	134
Programming the remote	137
Performing several commands in sequence automatically (Macro Play)	141
Setting remote commander codes that are not stored in the remote	143
Clearing all the contents of the remote's memory	144

Using On-screen Remote (Quick Click)

Operating components or lighting connected to the receiver using the on screen remote (Quick Click)	145
Preparing Quick Click	146
Using Quick Click	147
Setting components that are operated by the on-screen remote	153
Performing several commands in sequence automatically with Quick Click (Macro Play)	156
Setting remote control codes that are not stored in Quick Click	158
Resetting the remote code for Quick Click	160

Description and location of parts

Front panel

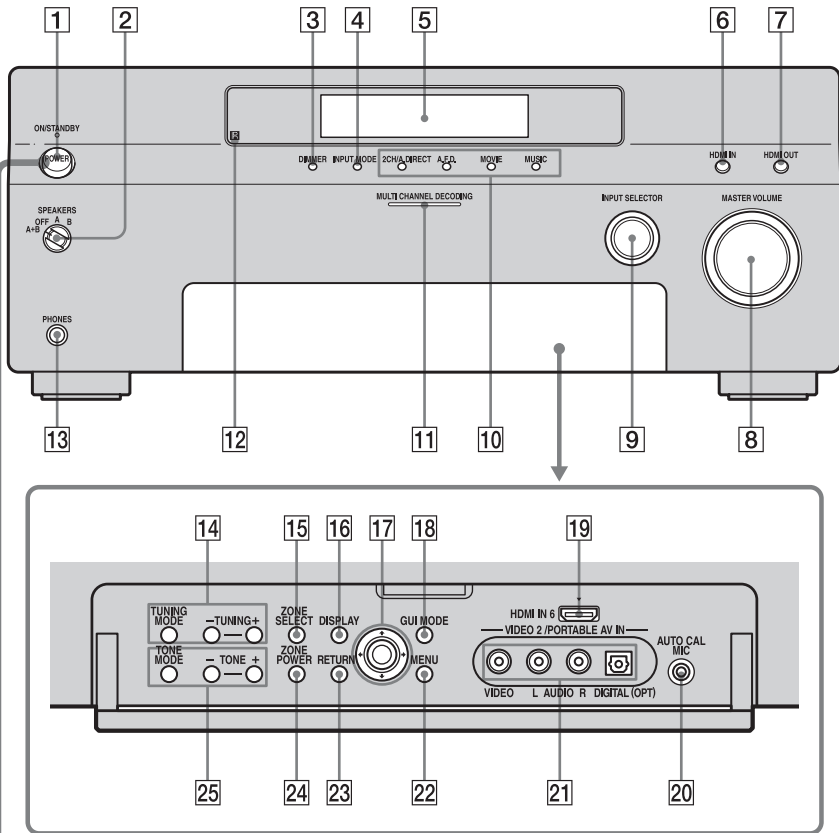

Status of the POWER button

Off

The receiver is turned off (initial setting).

Press POWER to turn the receiver on. You cannot turn the receiver on using the remote.







On/Standby

Press on the remote to turn the receiver on or set it to the standby mode.

When you press POWER on the receiver, the receiver will be turned off.

Name	Function
1 POWER	Press to turn the receiver on or off.
2 SPEAKERS (OFF/A/B/A+B)	Switch to OFF, A, B, A+B of the front speakers (page 48).
3 DIMMER	Press repeatedly to adjust brightness of the display.
4 INPUT MODE	Press to select the input mode when the same components are connected to both digital and analog jacks (page 102).
5 Display window	The current status of the selected component or a list of selectable items appears here (page 11).
6 HDMI IN	Press to select the input signal from the component connected to the HDMI IN jacks (page 34).
7 HDMI OUT	Press to select output signal to the component connected to the HDMI OUT jacks (page 34).
8 MASTER VOLUME	Turn to adjust the volume level of all speakers at the same time.

Name	Function
9 INPUT SELECTOR	Turn to select the input source to play back. To select the input source for zone 2 or zone 3, press ZONE/SELECT (16) to select zone 2 or zone 3 first (“ZONE 2 INPUT” or “ZONE 3 INPUT” appears on the display), then turn INPUT SELECTOR to select the input source.
10 2CH/A.DIRECT A.F.D. MOVIE MUSIC	Press to select sound field (page 78, 79, 82, 84).
11 MULTI CHANNEL DECODING lamp	Lights up when multi-channel audio signals are decoded.
12 Remote sensor	Receives signals from remote commander.
13 PHONES jack	Connects to headphones.
14 TUNING MODE TUNING +/-	Press to operate a tuner (FM/AM) and satellite radio (XM/SIRIUS).
15 ZONE SELECT	Press SELECT repeatedly to select zone 2, zone 3, or the main zone.
16 DISPLAY	Press repeatedly to select information displayed on the display.

Name	Function
17 	Press  /  /  /  to select the menu items. Then press  to enter the selection.
18 GUI MODE	Press to switch the display mode of the menu between GUI MODE (to display the menu on the TV screen) and DISPLAY MODE (to display the menu in the display window).
19 HDMI IN 6	Connect to a camcorder. The video and sound from your camcorder is input (page 34).
20 AUTO CAL MIC jack	Connects to the supplied optimizer microphone for the Digital Cinema Auto Calibration function (page 49).
21 VIDEO 2 IN/ PORTABLE AV IN jacks	Connect to a portable audio/video component such as a camcorder or video game.
22 MENU	Press to display the menu of the receiver.
23 RETURN	Press to return to the previous menu or exit the current menu of the receiver.
24 ZONE POWER	Each time you press ZONE POWER, the output signals for the selected zone will be turned on or off (page 88).

Name	Function
25 TONE MODE TONE +/-	Adjusts FRONT/CENTER/SURROUND/SURROUND BACK BASS and TREBLE. Press TONE MODE repeatedly to select BASS or TREBLE, then press TONE +/- to adjust the level.

Indicators on the display

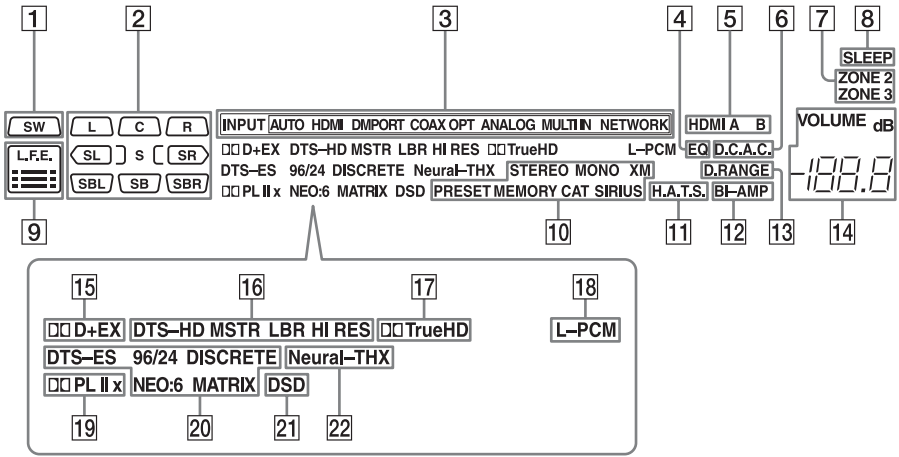



Name	Function
1 SW	Lights up when subwoofer is connected and the audio signal is output from the SUBWOOFER jack. While this indicator lights up, the receiver creates a subwoofer signal based on the L.F.E. signal in the disc being played back or the low frequency components of the front channels.

Name	Function
2 Playback channel indicators	The letters (L, C, R, etc.) indicate the channels being played back. The boxes around the letters vary to show how the receiver downmixes the source sound (based on the speaker settings).
L	Front Left
R	Front Right
C	Center (monaural)
SL	Surround Left
SR	Surround Right
S	Surround (monaural or the surround components obtained by Pro Logic processing)
SBL	Surround Back Left
SBR	Surround Back Right
SB	Surround Back (the surround back components obtained by 6.1 channel decoding)
	Example: Recording format (Front/ Surround): 3/2.1 Output channel: Surround speakers are set to "NO." Sound Field: A.F.D. AUTO
	

Name	Function
3 Input indicators	Light up to indicate the current input.
INPUT	Lights up constantly with either following the corresponding indicators that indicate the current input status.
HDMI	The receiver recognizes a component connected via an HDMI IN jack.
DMPort	The DIGITAL MEDIA PORT adapter is connected and "DMPort" is selected.
MULTI IN	The multi-channel input is selected.
NETWORK	The input of the network function (Server/ SHOUTcast/Rhapsody) is selected.
AUTO	Lights up with the corresponding indicators that indicate the current input when INPUT MODE is set to "Auto."
COAX	Digital signal is input through the COAXIAL jack.
OPT	Digital signal is input through the OPTICAL jack.
ANALOG	No digital signal is being input. When INPUT MODE is set to "Analog," or when the "2ch Analog Direct" is being selected, it also lights up.
4 EQ	Lights up when the equalizer is activated.
5 HDMI A B	Lights up when the signals are output from the HDMI OUT A or B jack.

Name	Function
6] D.C.A.C.	Lights up when auto calibration is activated.
7] ZONE 2/ ZONE 3	Lights up while operation in zone 2/zone 3 is being enabled.
8] SLEEP	Lights up when the sleep timer is activated.
9] L.F.E.	Lights up when the disc being played back contains an L.F.E. (Low Frequency Effects) channel and the L.F.E. channel signal is actually being reproduced, the bars underneath the letters light up to indicate the level. Since the L.F.E. signal is not recorded in all parts of the input signal the bar indication will fluctuate (and may turn off) during playback.
10] Tuning indicators	Lights up when the receiver tunes in radio stations, or satellite radio stations.
STEREO	Stereo broadcast
MONO	Monaural broadcast
XM	The XM Mini Tuner and Home Dock are connected and "XM" is selected.
SIRIUS	The SiriusConnect Home tuner is connected and "SIRIUS" is selected.
CAT	The category mode is selected during the satellite radio operation.
PRESET	The tuning mode is set to the preset mode.
MEMORY	A memory function, such as Name Input, etc., is activated.

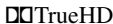
Name	Function
11] H.A.T.S.	Lights up when the H.A.T.S. (High quality digital Audio Transmission System) function is activated.
12] BI-AMP	Lights up when surround back speakers selection is set to "BI-AMP."
13] D.RANGE	Lights up when dynamic range compression is activated.
14] VOLUME	Displays the current volume.
15] Dolby Digital Surround indicators	Lights up one of the respective indicators when the receiver is decoding the corresponding Dolby Digital format signals.
	Dolby Digital
	Dolby Digital Plus
	Dolby Digital Surround EX
	Note When playing a Dolby Digital format disc, be sure that you have made digital connections and that INPUT MODE is not set to "Analog."
16] DTS-HD indicators	Light up when the receiver is decoding DTS-HD.
DTS-HD	Lights up constantly with the one of the following indicators.
MSTR	DTS-HD Master Audio
LBR	DTS-HD Low Bit Rate Audio
HI RES	DTS-HD High Resolution Audio
17] 	Lights up when the receiver is decoding Dolby TrueHD.

continued

Name	Function
18 L-PCM	Lights up when Linear PCM (Pulse Code Modulation) signals are input.
19 Dolby Pro Logic indicators	Lights up one of the respective indicators when the receiver applies Dolby Pro Logic processing to 2 channel signals in order to output the center and surround channel signals.
□□PL	Dolby Pro Logic
□□PLII	Dolby Pro Logic II
□□PLIIX	Dolby Pro Logic IIX Note This indicator does not light when either the center speaker and surround speaker is not connected.
20 DTS(-ES) indicators	Light up when DTS or DTS-ES signals are input.
DTS	Lights up when the receiver is decoding DTS signals. Either 96/24 or NEO:6 also lights up depending on the input signal format or decoding format.
96/24	DTS 96/24 (96 kHz/24 bit) decoding
NEO:6	DTS Neo:6 Cinema/Music
DTS-ES	Lights up with the either following indicator depending on the input signal decoding format.
DISCRETE	DTS-ES Discrete 6.1
MATRIX	DTS-ES Matrix 6.1 Note When playing a DTS format disc, be sure that you have made digital connections and that INPUT MODE is not set to "Analog."

Name	Function
21 DSD	Lights up when the receiver is receiving DSD (Direct Stream Digital) signals.
22 Neural-THX	Lights up when the receiver applies Neural-THX processing to input signals.

Rear panel

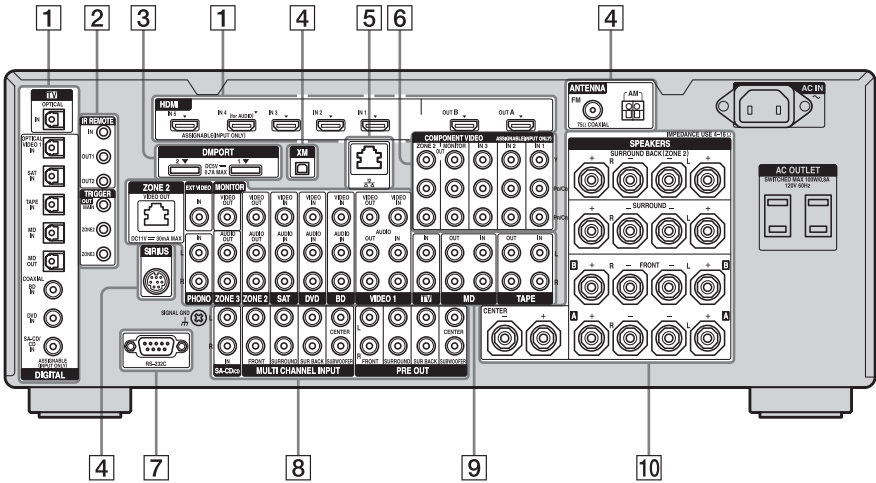

1 DIGITAL INPUT/OUTPUT section

 OPTICAL IN/OUT jacks Connect to a DVD player, Super Audio CD player, etc. (page 26, 29, 35, 38, 39).

 COAXIAL IN jacks

 HDMI IN/OUT* jacks Connect to a DVD player, Blu-ray Disc Player, or a satellite tuner. An image and the sound are output to TV or a projector (page 26, 34).

2 Control jacks for Sony equipment and other external components

 IR REMOTE IN/OUT jacks Connect an IR repeater (page 88) or an IR Blaster (page 146).

 TRIGGER OUT jacks Connect to interlock on/off of the power supply of other 12V TRIGGER compliant components, or the amplifier/receiver of zone 2 or zone 3 (page 120).

3 DMPORT

 Connect to a Sony DIGITAL MEDIA PORT adapter (page 29).

4 ANTENNA section

 FM ANTENNA jack Connects to the FM wire antenna (aerial) supplied with this receiver (page 43).

 AM ANTENNA jack Connects to the AM loop antenna (aerial) supplied with this receiver (page 43).

 XM jack Connects to the XM Mini Tuner and Home Dock (not supplied) (page 70).

 SIRIUS jack Connects to a SiriusConnect Home tuner (not supplied) (page 70).

5 LAN port



Connects to the router when you want to connect the receiver to your network.

6 COMPONENT VIDEO INPUT/OUTPUT section



Y, P_B/C_B, P_R/C_R IN/OUT* jacks
Connect to a DVD player, TV, or a satellite tuner (page 26, 38, 39).

7 RS-232C port



Used for maintenance and service.

8 AUDIO INPUT/OUTPUT section



AUDIO IN/OUT jacks
Connect to a tape deck or MD deck, etc (page 32).

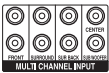

MULTI CHANNEL INPUT jacks
Connect to a Super Audio CD player or DVD player with an analog audio jack for 7.1 channel or 5.1 channel sound (page 31).



PRE OUT jacks
Connect to an external power amplifier.

9 VIDEO/AUDIO INPUT/OUTPUT section



AUDIO IN/OUT jacks
Connect to a VCR or a DVD player etc. (page 26, 38, 39, 40).



VIDEO IN/OUT* jacks



AUDIO OUT jacks
VIDEO OUT jack
Connect to the component in zone 2 or zone 3 (page 88).



ZONE 2 VIDEO OUT jack



An RJ-45 jack used to send a video signal to the component in zone 2. Use a CAT5 cable for the connection. Used for custom installation. For information on how to use this jack, consult your dealer.
Attention
Do not use this jack for an Ethernet LAN connection. Doing so may cause a malfunction.



EXT VIDEO IN jack
Connects to the component when you want to watch in PIP (Picture in Picture) window.

10 SPEAKERS section

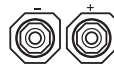

Connects to speakers (page 24).

* You can watch the selected input image when you connect the HDMI OUT or MONITOR OUT jacks to a TV (page 26). You can operate this receiver using a GUI (Graphical User Interface) (page 45).

Remote commander

You can use the supplied remote to operate the receiver and to control the Sony audio/video components that the remote is assigned to operate.





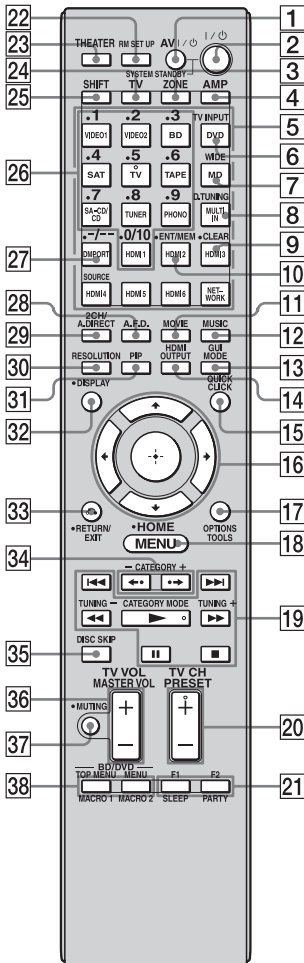

Main remote commander (RM-AAL012)

The RM-AAL012 remote is used for illustration purpose.



Name	Function
1 AV I/O (on/standby)	Press to turn on or off the audio/video components that the remote is assigned to operate (page 137). If you press I/O (2) button at the same time, it will turn off the receiver and other Sony components (SYSTEM STANDBY). Note The function of the AV I/O switch changes automatically each time you press the input button (5).
2 I/O (on/standby)	Press to turn the receiver on or off. If zone 2 or zone 3 is selected, only the main receiver is turned on or off with this button. To turn off all components including an amplifier in zone 2 or zone 3, press I/O and AV I/O (1) at the same time (SYSTEM STANDBY).
3 ZONE	Press to switch the zone 2 or zone 3 operation (page 88).
4 AMP	Press to enable the receiver operation (page 45).
5 Input buttons	Press one of the buttons to select the component you want to use. When you press any of the input buttons, the receiver turns on. The buttons are factory assigned to control Sony components (page 58). You can program the remote to control non-Sony components following the steps in "Programming the remote" (page 137).
6 TV INPUT	Press TV (24), then press TV INPUT to select the input signal of a TV.
7 WIDE	Press TV (24), then press WIDE repeatedly to select the wide picture mode.

continued

Name	Function
8 D.TUNING	Press SHIFT (25), then press to enter direct tuning mode (page 66, 72).
9 CLEAR	Press SHIFT (25), then press to <ul style="list-style-type: none"> – clear a mistake when you press the incorrect numeric button. – return to continuous playback, etc. of the satellite tuner or DVD player.
10 ENT/MEM	Press SHIFT (25), then press ENT/MEM to enter the value after selecting a channel, disc, or track using the numeric buttons, or to store a station during tuner operation.
11 MOVIE	Press to select sound field for movies (page 84).
12 MUSIC	Press to select sound field for music (page 82).
13 GUI MODE	Press to switch the display mode of the menu between GUI MODE (to display the menu on the TV screen) and DISPLAY MODE (to display the menu in the display window).
14 HDMI OUTPUT	Press to select an HDMI jack you want to output HDMI video signals to (page 34).
15 QUICK CLICK	Press to display the on-screen remote on the TV the screen.
16 	Press  /  /  /  to select the menu items. Then press  to enter the selection.
17 OPTIONS TOOLS	Press to display and select items from option menus for receiver, DVD player, TV, or Blu-ray Disc Player, etc.
18 MENU HOME	Press to display the menu used to operate audio/video components or a TV.

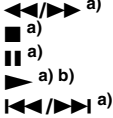
Name	Function
19 	Press to operate the DVD player, Blu-ray Disc Player, CD player, MD deck, tape deck, or component connected to the DIGITAL MEDIA PORT adapter etc.
CATEGORY MODE	Press to select the category mode for satellite tuner.
TUNING +/-	Press to select station.
20 PRESET + b)/-	Press to register FM/AM/satellite tuner stations or to select preset stations.
TV CH + b)/-	Press TV (24), then press TV CH +/- to operate the TV, satellite tuner, VCR, etc.
21 F1/F2	Press BD or DVD (5), then press F1 or F2 to select a component to operate. <ul style="list-style-type: none"> • HDD/DISC combo <ul style="list-style-type: none"> F1: HDD F2: DVD disc, Blu-ray Disc • DVD/VHS combo <ul style="list-style-type: none"> F1: DVD disc, Blu-ray Disc F2: VHS
PARTY	Press to display confirmation screen to start party mode (page 96).
SLEEP	Press AMP (4), then press SLEEP to activate the sleep timer function and the duration which the receiver turns off automatically (page 105).
22 RM SET UP	Press to set up the remote (page 108).
23 THEATER	Press to turn the Theater mode on and off when connecting the receiver to products featuring “BRAVIA” Sync.
24 TV	Press to enable the TV operation.
25 SHIFT	Press to light up the button. It changes the remote button function to activate the buttons with pink printing.

Name	Function
26 Numeric buttons	Press SHIFT (25), then press to <ul style="list-style-type: none"> – preset/tune to preset stations. – select track numbers of the CD player, DVD player, Blu-ray Disc Player or MD deck. Press +/- (27) to select track number 10. – select channel numbers of the VCR or satellite tuner. – After pressing TV (24), press the numeric buttons to select the TV channels.
27 -/+	Press to <ul style="list-style-type: none"> – select track numbers over 10 of the CD player, DVD player, Blu-ray Disc Player, or MD deck. – select channel numbers over 10 of the TV, Satellite tuner or the VCR.
28 A.F.D.	Press to select sound field (page 79).
29 2CH/ A.DIRECT	Press to select sound field or to switch the audio of the selected input to analog signal without any adjustment (page 78).
30 RESOLUTION	Press RESOLUTION repeatedly to change the resolution of signals output from the HDMI OUT or COMPONENT VIDEO MONITOR OUT jack.
31 PIP	Press PIP to switch the image of the PIP (Picture in Picture) window. The image of the PIP window is the one from the EXT VIDEO IN jack. You can swap the position of the main screen and the PIP window by pressing (16) (16). Note When the HDMI input is selected on the main screen, you cannot swap the position of the main screen and the PIP window.
32 DISPLAY	Press to display the current status of or information on components connected to the receiver. Note In the GUI MODE, press the button to display the menu on the TV screen.

Name	Function
33 RETURN/ EXIT ↶	Press to return to the previous menu or exit the menu while the menu or on-screen guide of the VCR, DVD player, or satellite tuner is displayed on the TV screen.
34 CATEGORY +/-	Press to select the category for satellite tuner.
↵/↶	Press to select an album.
35 DISC SKIP	Press to skip a disc when using a multi-disc changer.
36 MASTER VOL +/-	Press to adjust the volume level of all speakers at the same time.
TV VOL +/-	Press TV (24), then press TV VOL +/- to adjust the volume level of the TV.
37 MUTING	Press to turn off the sound temporarily. Press the button again to restore the sound.
38 BD/DVD/ TOP MENU, MENU	Press to display the menus of the DVD player on the TV screen. Then use ↵/↶/↷/↵ and (16) to perform a menu operations.
MACRO1, MACRO2	Press AMP (4), then press MACRO 1 or MACRO 2 to set up the macro function (page 141).

a) See the table on page 135 for information on the buttons that you can use to control each component.

b) The tactile dot is attached to these buttons (TV/5, ►, PRESET +/TV CH +). Use as a mark of operation.

Notes







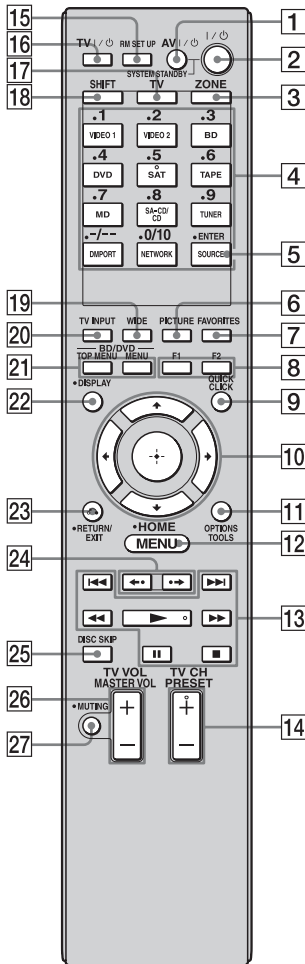



- Some functions explained in this section may not work depending on the model.
- The above explanation is intended to serve as an example only. Therefore, depending on the component, the above operation may not be possible or may operate differently than described.







Zone 2/Zone 3 remote commander (RM-AAP026)

This remote is for zone 2/zone 3 operations (page 88).



Name	Function
1 AV I/⏻ (on/standby)	Press to turn on or off the audio/video components that the remote is assigned to operate (page 137). Press I/⏻ (2) at the same time, to turn off the receivers in the main zone, zone 2 and zone 3, and any other Sony components (SYSTEM STANDBY). Note The function of the AV I/⏻ switch changes automatically each time you press the input button (4).
2 I/⏻ (on/standby)	Press to turn the receiver on or off in zone 2 or zone 3. Press AV I/⏻ (1) at the same time to turn off the receivers in the main zone, zone 2 and zone 3, and any other Sony components (SYSTEM STANDBY).
3 ZONE	Press to enable the zone 2 or zone 3 operation (page 88).
4 Input buttons	Press one of the buttons to select the component you want to use. Press a pink-labeled button after pressing SHIFT (18). When you press any of the input buttons, the receiver turns on. The buttons are factory assigned to control Sony components (page 95). You can program the remote to control non-Sony components following the steps in "Programming the remote" (page 137).
5 ENTER	Press to enter the value after selecting a channel, disc or track using the numeric buttons.
6 PICTURE	Press repeatedly to cycle through the available picture modes of TV.
7 FAVORITES	Press once to display the stored favorite channel list of TV.

Name	Function
8 F1/F2	Press BD or DVD (4), then press F1 or F2 to select a component to operate. <ul style="list-style-type: none"> HDD/DISC combo <ul style="list-style-type: none"> F1: HDD F2: DVD disc, Blu-ray Disc DVD/VHS combo <ul style="list-style-type: none"> F1: DVD disc, Blu-ray Disc F2: VHS <p>Note The F1/F2 function does not work for video components that have no recording function.</p>
9 QUICK CLICK	Press to display the on-screen remote on the TV the screen.
10 	Press  /  /  /  to select the menu items for zone 2/zone 3. Then press  to enter the selection.
11 OPTIONS TOOLS	Press to display and select items from option menus for receiver, DVD player, TV, or Blu-ray Disc Player, etc.
12 MENU HOME	Press to display the menu used to operate audio/video components or a TV.
13  a)  a)  a)  a) b)  a)	Press to operate the DVD player, Blu-ray Disc Player, CD player, MD deck, tape deck, or component connected to the DIGITAL MEDIA PORT adapter etc.
14 PRESET + b)/-	Press to register FM/AM/satellite tuner stations or to select preset stations.
TV CH + b)/-	Press TV (17), then press TV CH +/- to operate the TV, satellite tuner, VCR, etc.
15 RM SET UP	Press to set up the remote.
16 TV I/C	Press to turn the TV on or off.
17 TV	Press to enable the TV operation.
18 SHIFT	Press to light up the button. It changes the remote button function to activate the buttons with pink printing.
19 WIDE	Press repeatedly to select the wide picture mode.

Name	Function
20 TV INPUT	Press TV (17), then press TV INPUT to select the input signal of a TV.
21 BD/DVD TOP MENU, MENU	Press to display the menus of the DVD player on the TV screen. Then use  /  /  /  and  to perform a menu operations.
22 DISPLAY	Press to display the current status of or information on components connected to the receiver. <p>Note In the GUI mode, press the button to display the menu on the TV screen.</p>
23 RETURN/EXIT 	Press to return to the previous menu or exit the menu while the menu or on-screen guide of the VCR, DVD player, or satellite tuner is displayed on the TV screen.
24 	Press to select an album.
25 DISC SKIP	Press to skip a disc when using a multi-disc changer.
26 MASTER VOL +/-	Press to adjust the volume level of all speakers in zone 2/zone 3 at the same time.
TV VOL +/-	Press TV (17), then press TV VOL +/- to adjust the volume level of the TV in zone 2/zone 3.
27 MUTING	Press to turn off the sound temporarily. Press the button again to restore the sound.

a) See the table on page 136 for information on the buttons that you can use to control each component.

b) The tactile dot is attached to these buttons (SAT/5, , PRESET +/-/TV CH +/-). Use as a mark of operation.

1: Installing speakers

This receiver allows you to use a 7.1 channel system (7 speakers and one subwoofer).

Enjoying a 5.1/7.1 channel system

To fully enjoy theater-like multi-channel surround sound requires five speakers (two front speakers, a center speaker, and two surround speakers) and a subwoofer (5.1 channel system).

Example of a 5.1 channel speaker system configuration

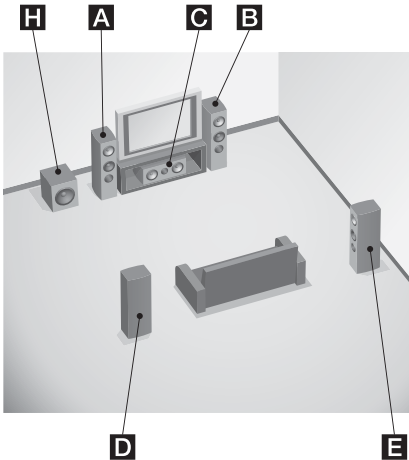

- A** Front left speaker
- B** Front right speaker
- C** Center speaker
- D** Surround left speaker
- E** Surround right speaker
- H** Subwoofer

You can enjoy high fidelity reproduction of DVD or Blu-ray Disc software recorded sound in the Surround EX format if you connect one additional surround back speaker (6.1 channel system) or two surround back speakers (7.1 channel system.)

Example of a 7.1 channel speaker system configuration

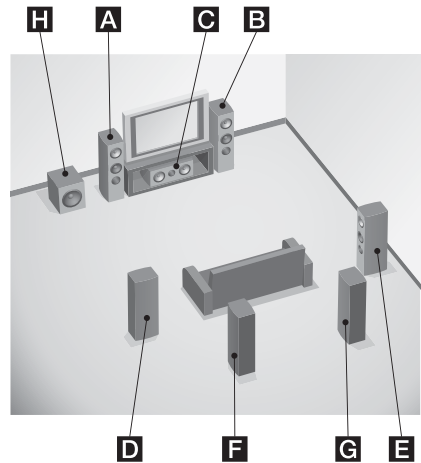

- A** Front left speaker
- B** Front right speaker
- C** Center speaker
- D** Surround left speaker
- E** Surround right speaker
- F** Surround back left speaker
- G** Surround back right speaker
- H** Subwoofer

Tips

- The angle **A** should be the same.

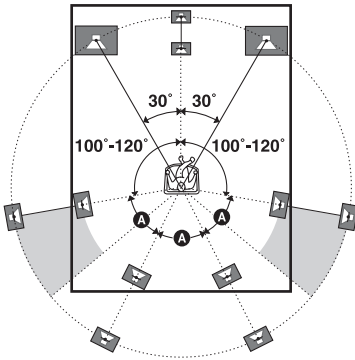

- When you connect a 6.1 channel speaker system, place the surround back speaker behind the seating position.

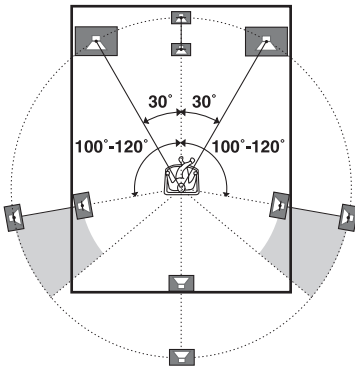

- Since the subwoofer does not emit highly directional signals, you can place it wherever you want.

2: Connecting speakers

Before connecting cords, make sure to disconnect the AC power cord (mains lead).

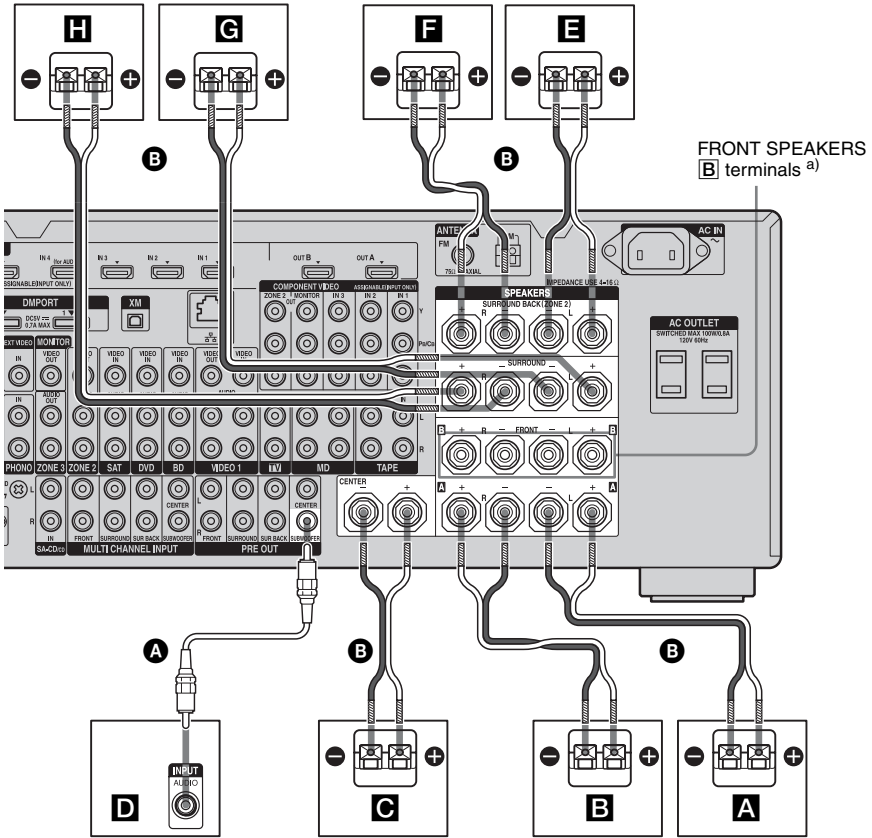

- A** Monaural audio cord (not supplied)
- B** Speaker cords (not supplied)

- A** Front speaker **A** (L)
- B** Front speaker **A** (R)
- C** Center speaker
- D** Subwoofer^{b)}
- E** Surround back speaker (L)^{c)}
- F** Surround back speaker (R)^{c)}
- G** Surround speaker (L)
- H** Surround speaker (R)

^{a)} If you have an additional front speaker system, connect them to the FRONT SPEAKERS **B** terminals. You can select the front speaker system you want to use with the SPEAKERS switch (OFF/A/B/A+B) on the front panel (page 48).

- b) When you connect a subwoofer with an auto standby function, turn off the function when watching movies. If the auto standby function is set to on, it turns to standby mode automatically based on the level of the input signal to a subwoofer, then sound may not be output.
- c) If you connect only one surround back speaker, connect it to the SURROUND BACK SPEAKERS L terminals.

Notes

- When you connect all the speakers with a nominal impedance of 8 ohms or higher, set “Impedance” in the Speaker settings menu to “8 Ω.” In other connections, set it to “4 Ω.” For details, see “8: Setting the speakers” (page 46).
- Before connecting the AC power cord (mains lead), make sure that metallic wires of the speaker cords are not touching each other between the SPEAKERS terminals.

Tip

To connect certain speakers to another power amplifier, use the PRE OUT jacks. The same signal is output from both the SPEAKERS terminals and the PRE OUT jacks. For example, if you want to connect just the front speakers to another amplifier, connect that amplifier to the PRE OUT FRONT L and R jacks.

ZONE 2 connection

You can assign the SURROUND BACK SPEAKERS terminals **E** and **F** to the speakers of the zone 2. Set “Sur Back Assign” to “ZONE2” in the Speaker settings menu. See “Using Multi-zone Features” (page 88) for details on connection and operation in zone 2.

3: Connecting the monitor

You can watch the selected input image when you connect the HDMI OUT or MONITOR OUT jacks to a TV. You can operate this receiver using a GUI (Graphical User Interface). It is not necessary to connect all the cables. Connect audio and video cords according to the jacks of your components.

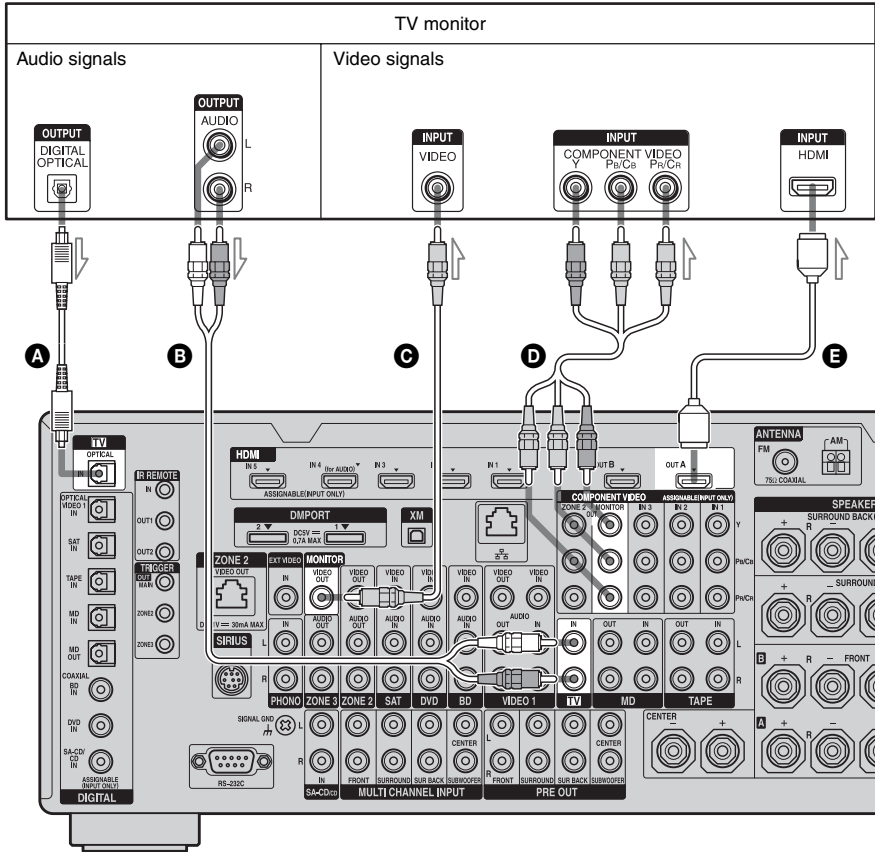

- A** Optical digital cord (not supplied)
- B** Audio cord (not supplied)
- C** Video cord (not supplied)
- D** Component video cord (not supplied)
- E** HDMI cable (not supplied)

Notes

- Before connecting cords, make sure to disconnect the AC power cord (mains lead).
- Connect image display components such as a TV monitor or a projector to the MONITOR VIDEO OUT jack on the receiver. You may not be able to record, even if you connect recording components.
- Turn on the receiver when the video and audio of a playback component are being output to a TV via the receiver. If the power supply of the receiver is not turned on, neither video nor audio is transmitted.
- Depending on the status of the connection between the TV and the antenna (aerial), the image on the TV screen may be distorted. In this case, place the antenna (aerial) farther away from the receiver.

Tips

- The receiver has a video conversion function. For details, see “Notes on converting video signals” (page 42).
- The sound of the TV is output from the speakers connected to the receiver if you connect the audio output jack of the TV and the TV IN jacks of the receiver. In this configuration, set the sound output jack of the TV to “Fixed” if it can be switched between either “Fixed” or “Variable.”
- The screen saver is activated when the GUI menu is displayed on the TV screen and there has been no operation attempted for 15 minutes.

4a: Connecting the audio components

How to hook up your components

This section describes how to hook up your components to this receiver. Before you begin, refer to “Component to be connected” below for the pages which describe how to connect each component.

After hooking up all your components, proceed to “5: Connecting the antennas (aerials)” (page 43).

Component to be connected		Page
Super Audio CD player/ CD player	With digital audio output	29
	With multi-channel audio output	31
	With analog audio output only	32
MD player	With digital audio output	29
	With analog audio output only	32
Tape deck, Analog disc turntable		32

Connecting components with digital audio input/output jacks

The following illustration shows how to connect a Super Audio CD player, CD player, an MD deck and DIGITAL MEDIA PORT adapter.

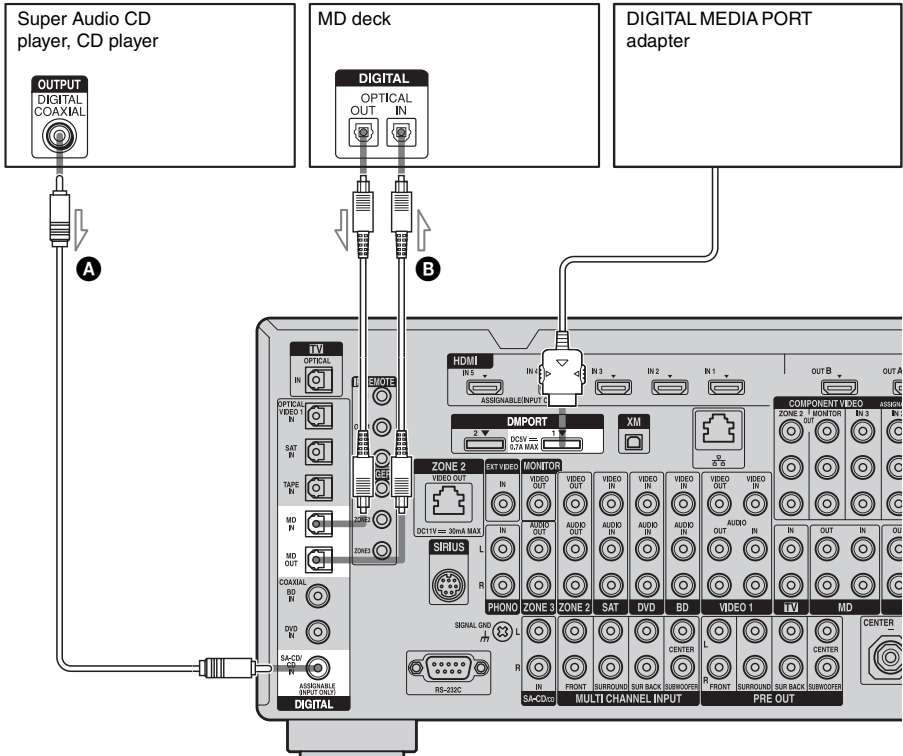

- A** Coaxial digital cord (not supplied)
- B** Optical digital cord (not supplied)

Notes

- When connecting optical digital cords, insert the plugs straight in until they click into place.
- Do not bend or tie optical digital cords.
- Before connecting cords, make sure to disconnect the AC power cord (mains lead).
- To disconnect the DIGITAL MEDIA PORT adapter, observe the following precautions.
 - Remove the DIGITAL MEDIA PORT adapter after removing the cord when cords are connected to the COMPONENT VIDEO jack.
 - Remove the DIGITAL MEDIA PORT adapter by squeezing the sides of the connector, since the connector is locked in place.

Tip

All the digital audio jacks are compatible with 32 kHz, 44.1 kHz, 48 kHz, 88.2 kHz and 96 kHz sampling frequencies.

continued

Notes on playing a Super Audio CD on a Super Audio CD player

- No sound is output when playing a Super Audio CD on a Super Audio CD player connected to only the COAXIAL SA-CD/CD IN jack on this receiver. When you play a Super Audio CD, connect the player to the MULTI CHANNEL INPUT or SA-CD/CD IN jacks. Refer to the operating instructions supplied with the Super Audio CD player.
- Connect a player which can output DSD signals from the HDMI jack to the receiver using an HDMI cable.
- You cannot make digital recordings of a Super Audio CD.
- When connecting optical digital cords, insert the plugs straight in until they click into place.

If you want to connect several digital components, but cannot find an unused input

See “Enjoying the sound/images from other inputs (Input Assign)” (page 103).

Connecting components with multi-channel output jacks

If your DVD player, Blu-ray Disc Player or Super Audio CD player is equipped with multi-channel output jacks, you can connect them to the MULTI CHANNEL INPUT jacks of this receiver to enjoy multi-channel sound. Alternatively, the multi-channel input jacks can be used to connect an external multi-channel decoder.

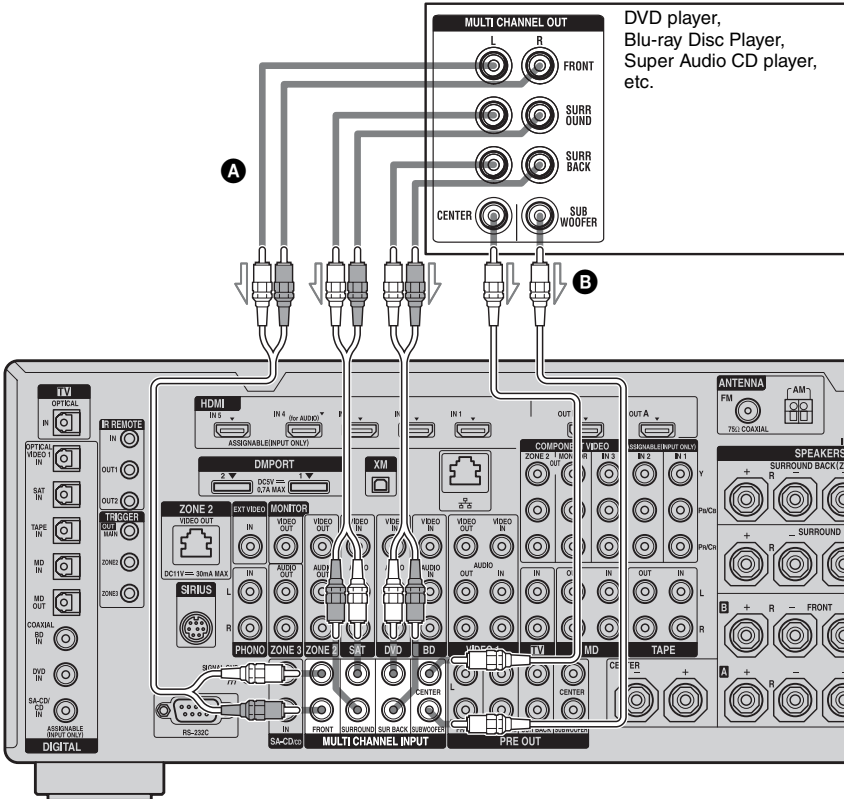

- A** Audio cord (not supplied)
- B** Monaural audio cord (not supplied)

Notes

- Before connecting cords, make sure to disconnect the AC power cord (mains lead).
- DVD player, Blu-ray Disc Player and Super Audio CD players may not have the SURROUND BACK jacks.
- When “Sur Back Assign” is set to “BI-AMP” or “ZONE2” in the Speaker settings menu, the input to the SUR BACK jacks is invalid.

- Audio input signals from MULTI CHANNEL INPUT jacks are not output to any audio output jacks. The signals cannot be recorded.

4b: Connecting the video components

How to hook up your components

This section describes how to hook up your components to this receiver. Before you begin, refer to “Component to be connected” below for the pages which describe how to connect each component.

After hooking up all your components, proceed to “5: Connecting the antennas (aerials)” (page 43).

Component to be connected	Page
TV monitor	26
With HDMI jack	34
DVD player, Blu-ray Disc Player	38
Satellite tuner, Set-top box	39
DVD recorder, VCR	40
Camcorder, video game, etc.	40

Video input/output jacks to be connected

The image quality depends on the connecting jack. Refer to the illustration that follows. Select the connection according to the jacks on your components.

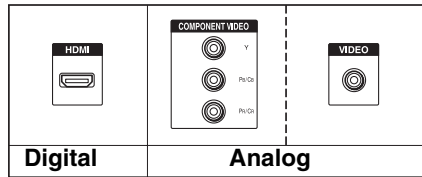

← High quality image

Connecting components with HDMI jacks

HDMI is the abbreviated name for High-Definition Multimedia Interface. It is an interface which transmits video and audio signals in digital format.

HDMI features

- A digital audio signals transmitted by HDMI can be output from the speakers and the PRE OUT jacks on this receiver. This signal supports Dolby Digital, DTS, DSD, and linear PCM.
- Linear PCM (sampling frequency less than 192 kHz) with digital audio signals of up to 8 channels can be received with this receiver using the HDMI IN jack.
- Analog video signals input to the VIDEO jack, or COMPONENT VIDEO jacks can be output as HDMI signals. Audio signals are not output from an HDMI OUT jack when the image is converted.
- This receiver supports DSD transmission (Super Audio CD), extended by HDMI ver1.2.
- This receiver supports High Bitrate Audio (DTS-HD Master Audio, Dolby TrueHD), Deep Color and xvYCC transmission, extended by HDMI ver1.3.
- The HDMI jacks of this receiver support the Control for HDMI function. The HDMI OUT B jack, however, does not support the Control for HDMI function.
- HDMI IN 4 is input which is considered sound quality. Input IN 4 when you need higher quality sound. You can also use IN 4 jack in the same manner as the HDMI IN 1 to IN 3 and IN 5.
- The HDMI IN 6 jack is used for connecting a camcorder. Use the HDMI IN 6 jack when you connect a camcorder to the receiver.

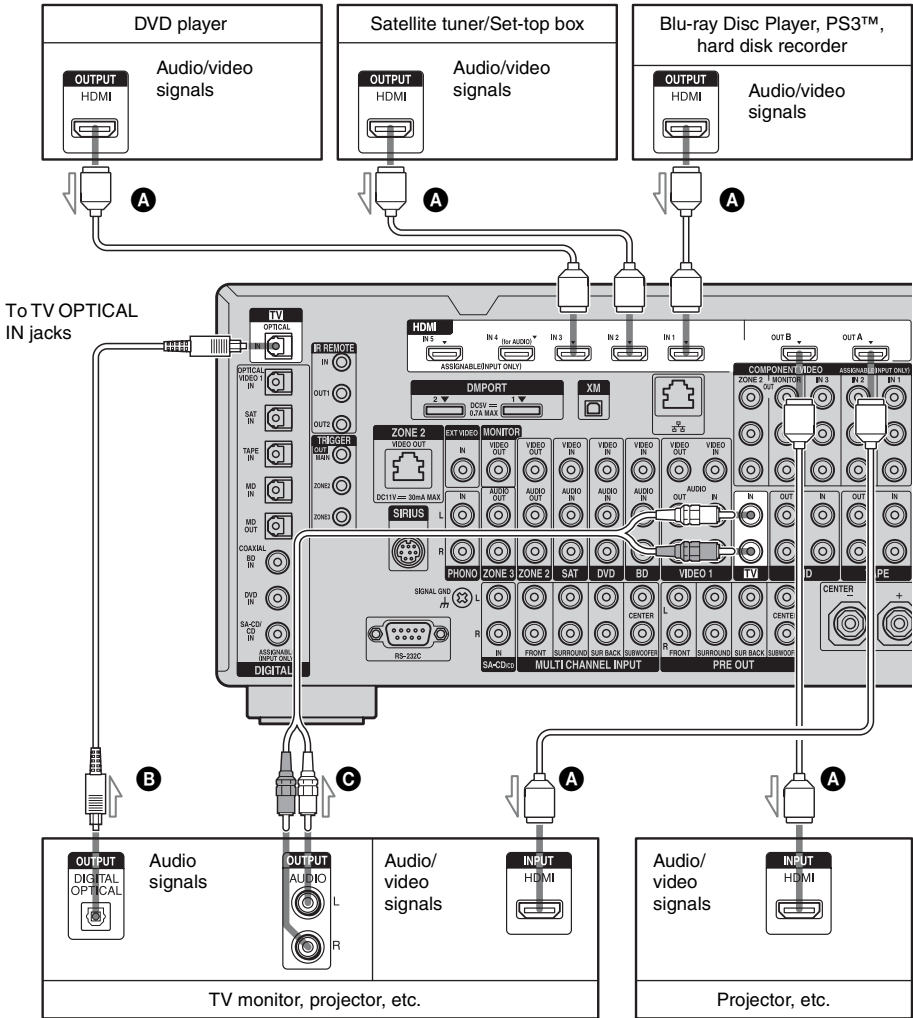

A HDMI cable (not supplied)

We recommend that you use a Sony HDMI cable.

B Optical digital cord (not supplied)

C Audio cord (not supplied)

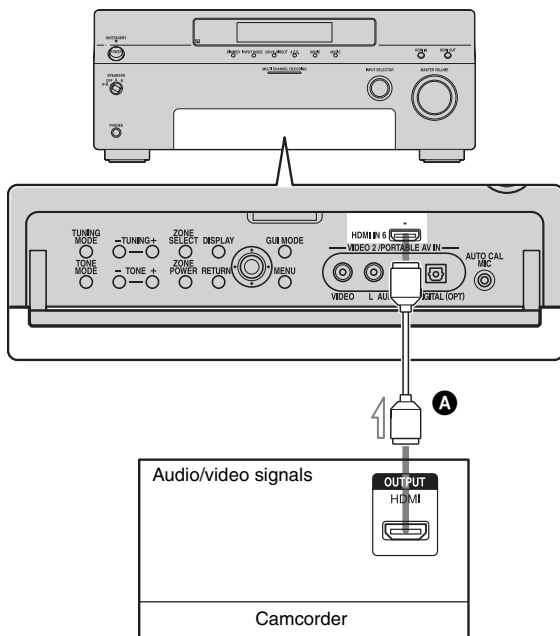

- A** HDMI cable (not supplied)
We recommend that you use a Sony HDMI cable.

To enjoy TV multi channel surround sound broadcasting

You can listen to TV multi channel surround sound broadcasting from the speakers connected to the receiver.
Connect the OPTICAL output jack of the TV to the OPTICAL IN jack of the receiver.

Tips

- Connect to at least one of the audio cords (**B** or **C**).
- You can watch the image of the camcorder easily with connecting your camcorder to the HDMI IN 6 jack (page 100).

Notes on connecting cables

- We recommend that you use an HDMI cable with the HDMI logo (made by Sony) for the HDMI jack corresponding to high speed (an HDMI version 1.3a, category 2 cable) when you view images or listen to sound during a Deep Color transmission or when you watch a video image of 1080p or higher.
- We do not recommend using an HDMI-DVI conversion cable. When you connect an HDMI-DVI conversion cable to a DVI-D component, the sound and/or the image may not be output. Connect other audio cords or digital connecting cords, then set “Input Assign” in the Input Option menu when the sound is not output correctly.
- Before connecting cables, make sure to disconnect the AC power cord (mains lead).

Notes on HDMI connections

- Check the setup of the connected component if an image is poor or the sound does not come out of a component connected via the HDMI cable.
- An audio signal input to the HDMI IN jack is output from the speaker output jacks, HDMI OUT jack and PRE OUT jacks. It is not output from any other audio jacks.
- A video signal input to the HDMI IN jack can only be output from the HDMI OUT jack. The video input cannot be output from the VIDEO OUT jacks or MONITOR VIDEO OUT jacks.
- When you want to listen to the sound from the TV speaker, set “Audio Out” to “TV+AMP” in the HDMI settings menu. If set to “AMP,” the sound is not output from the TV speaker.
- Be sure to turn on the receiver when video and audio signals of a playback component are being output to a TV through this receiver. Unless the power is on, neither video nor audio signals will be transmitted.

- Audio signals (sampling frequency, bit length, etc.) transmitted from an HDMI jack may be suppressed by the connected component. Check the setup of the connected component if an image is poor or the sound does not come out of a component connected via the HDMI cable.
- Sound may be interrupted when the sampling frequency, the number of channels or audio format of audio output signals from the playback component is switched.
- When the connected component is not compatible with copyright protection technology (HDCP), the image and/or the sound from the HDMI OUT jack may be distorted or may not be output. In this case, check the specification of the connected component.
- Refer to the operating instructions of each component connected for details.
- You can enjoy High Bitrate Audio (DTS-HD Master Audio, Dolby TrueHD), DSD, multi-channel Linear PCM only with an HDMI connection.
- Set the image resolution of the player to more than 720p/1080i to enjoy High Bitrate Audio (DTS-HD Master Audio, Dolby TrueHD).
- The image resolution of player may need certain settings be made before you can enjoy DSD and multi-channel Linear PCM. Refer to the operating instructions of the player.
- Not every HDMI component supports all functions that are defined by the specified HDMI version. For example, components that support HDMI, ver. 1.3a, may not support Deep Color.

Connecting a DVD player, Blu-ray Disc Player

The following illustration shows how to connect a DVD player, Blu-ray Disc Player. It is not necessary to connect all the cables. Connect audio and video cords according to the jacks of your components.

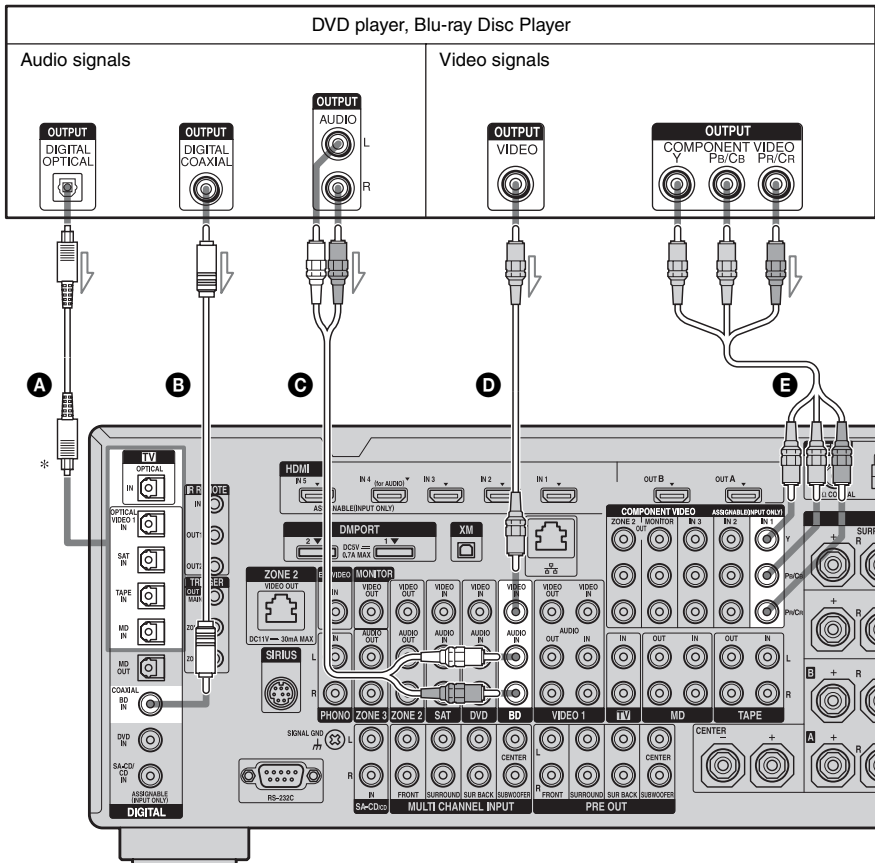

- A** Optical digital cord (not supplied)
- B** Coaxial digital cord (not supplied)
- C** Audio cord (not supplied)

- D** Video cord (not supplied)
- E** Component video cord (not supplied)

* When you connect a component equipped with an OPTICAL jack, set "Input Assign" in the Input menu.

Notes

- To output multi-channel digital audio, set the digital audio output setting on the DVD player, Blu-ray Disc Player. Refer to the operating instructions supplied with the DVD player, Blu-ray Disc Player.
- Before connecting cords, make sure to disconnect the AC power cord (mains lead).

Connecting a satellite tuner, Set-top box

The following illustration shows how to connect a satellite tuner, Set-top box.

It is not necessary to connect all the cables. Connect audio and video cords according to the jacks of your components.

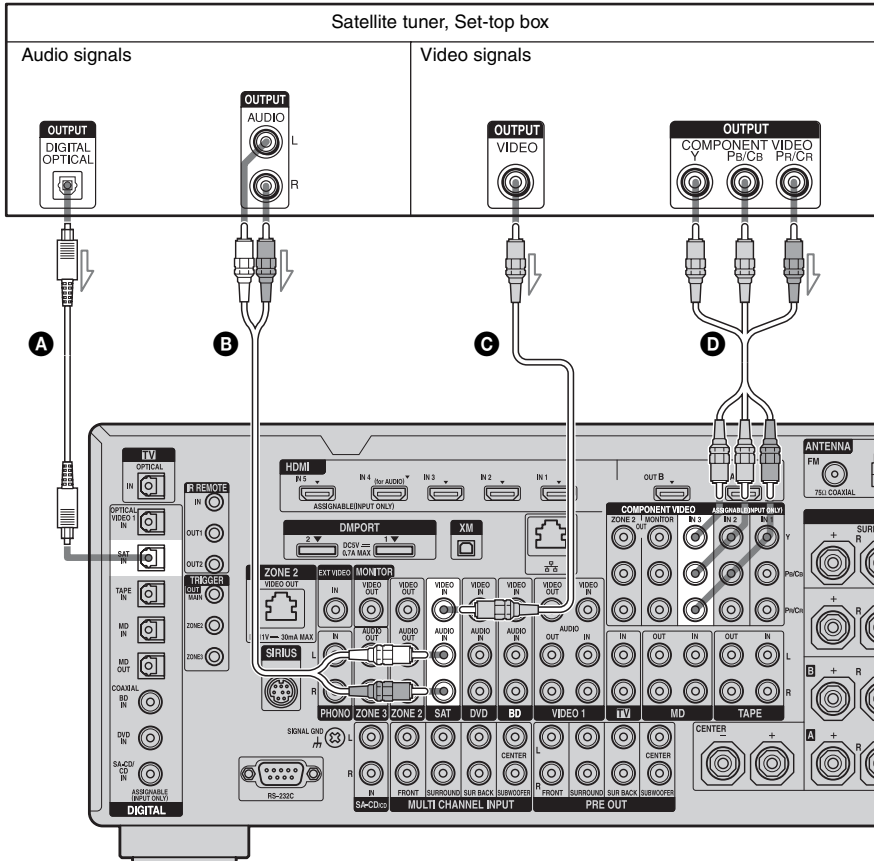

- A** Optical digital cord (not supplied)
- B** Audio cord (not supplied)
- C** Video cord (not supplied)
- D** Component video cord (not supplied)

Note

Before connecting cords, make sure to disconnect the AC power cord (mains lead).

Connecting components with analog video and audio jack

The following illustration shows how to connect a component which has analog jacks such as a DVD recorder or VCR, etc.

It is not necessary to connect all the cables. Connect audio and video cords according to the jacks of your components.

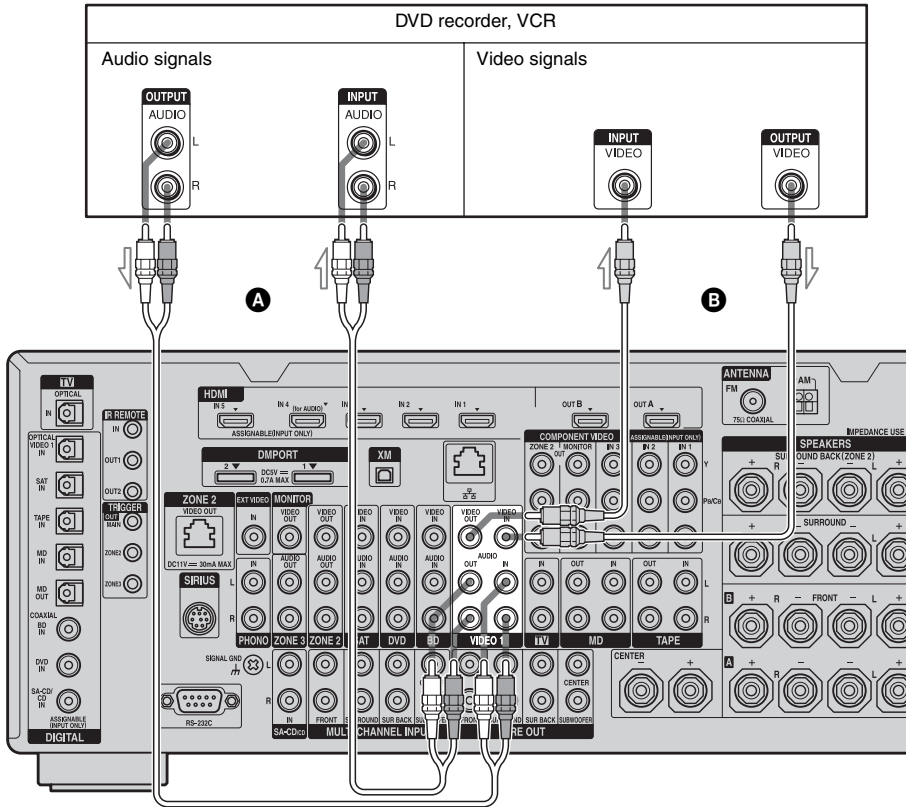

- A** Audio cord (not supplied)
- B** Video cord (not supplied)

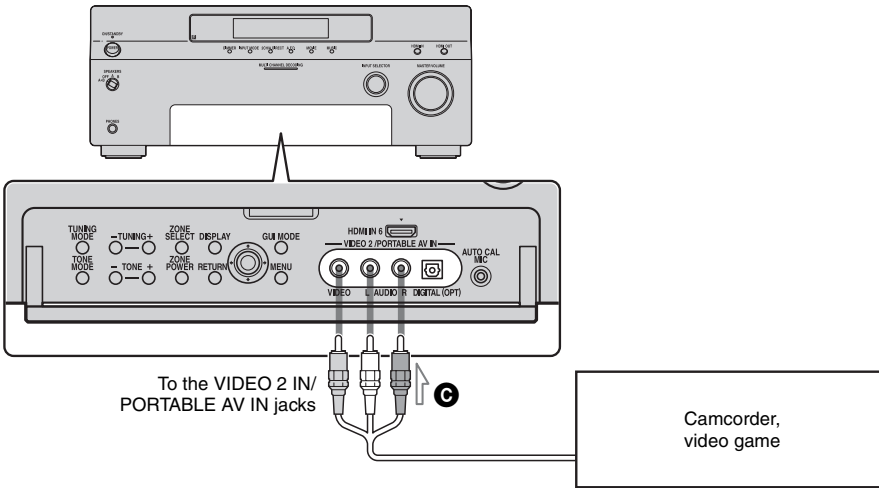

Ⓒ Audio/video cord (not supplied)

Note

Before connecting cords, make sure to disconnect the AC power cord (mains lead).

Function for conversion of video signals

This receiver is equipped with a function for converting video signals.

- Composite video signals can be output as HDMI video and component video signals.
- Component video signals can be output as HDMI video and video signals.

As the initial setting, video signals input from the connected component are output to the HDMI OUT or MONITOR OUT jacks as shown in the table below.

We recommend you set the video conversion function to match the resolution of the monitor you are using.

For details on the video converting function, see “ Video settings” (page 123).

OUTPUT jack \ INPUT jack	HDMI OUT A B	COMPONENT VIDEO MONITOR OUT	MONITOR VIDEO OUT
HDMI IN 1/2/3/4/5/6	○	—	—
VIDEO IN	○	○	○
COMPONENT VIDEO IN	○	○	○

○ : Video signals are output.

— : Video signals are not output.

Notes on converting video signals

- When video signals from a VCR, etc., are converted on this receiver and then output to your TV, depending on the status of the video signal output, the image on the TV screen may appear distorted horizontally or no image may be output.
- HDMI video signals cannot be converted to component video signals and video signals.
- The converted video signals are not output from the VIDEO OUT 1 jack.
- When you play a VCR with an image improvement circuit, such as TBC, the images may be distorted or may not be output. In this case, set the image improvement circuit function to off.
- The resolution of the signals output to the COMPONENT VIDEO MONITOR OUT jacks is converted up to 1080i. The resolution of the signals output to the HDMI OUT jack is converted up to 1080p.
- COMPONENT VIDEO MONITOR OUT jacks have restrictions on resolution when the resolution of video signals protected by copyright technology is converted. Resolution of up to 480p can be output to the COMPONENT VIDEO MONITOR OUT jacks. The HDMI OUT jack has no restriction on resolution.
- Video signals for which the resolution has been converted cannot be output from either the COMPONENT VIDEO MONITOR OUT jacks or the HDMI OUT jack. The video signals are output from the HDMI OUT jack when both are connected.
- Set “Resolution” to “AUTO” or “480i/576i” in the Video settings menu to output the video signals from the MONITOR VIDEO OUT, COMPONENT VIDEO MONITOR OUT jacks when both are connected.

To display Closed Caption

Set “Resolution” to “DIRECT” in the Video settings menu when receiving a signal that supports Closed Captions.

Use the same kind of cords for the input/output signals.

Note

Closed Caption is not displayed in zone 2.

To connect a recording component

When recording, connect the recording component to the VIDEO OUT jacks of the receiver. Connect cords for input and output signals to the same type of jack, as VIDEO OUT jacks do not have an up-conversion function.

Note

Signals output from the HDMI OUT or MONITOR OUT jacks may not be recorded properly.

5: Connecting the antennas (aerials)

Connect the supplied AM loop antenna (aerial) and FM wire antenna (aerial).

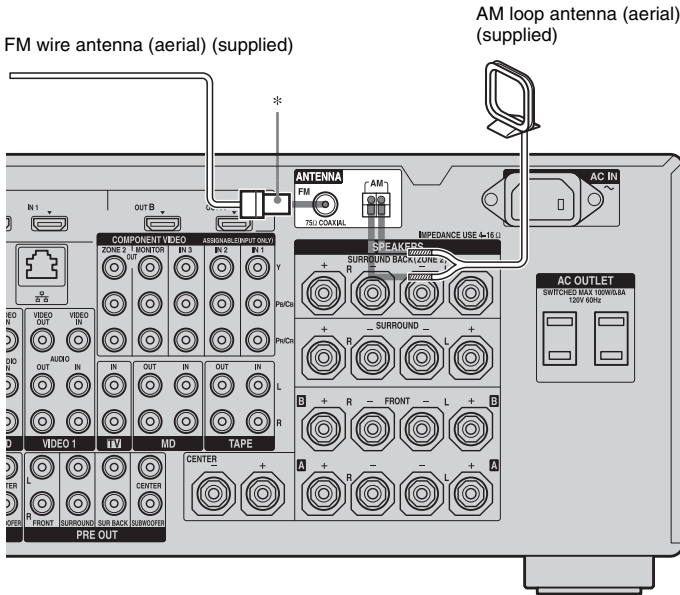

* The shape of the connector varies depending on the area.

Notes

- To prevent noise pickup, keep the AM loop antenna (aerial) away from the receiver and other components.
- Be sure to fully extend the FM wire antenna (aerial).
- After connecting the FM wire antenna (aerial), keep it as horizontal as possible.
- Before connecting cords, make sure to disconnect the AC power cord (mains lead).

6: Preparing the receiver and the remote

Connecting the AC power cord (mains lead)

Connect the supplied AC power cord (mains lead) to the AC IN terminal on the receiver, then connect the AC power cord (mains lead) to a wall outlet.

Notes

- Before connecting the AC power cord (mains lead), make sure that metallic wires of the speaker cords are not touching each other between the SPEAKERS terminals.
- Connect the AC power cord (mains lead) firmly.

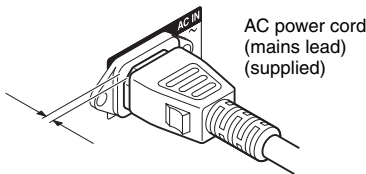
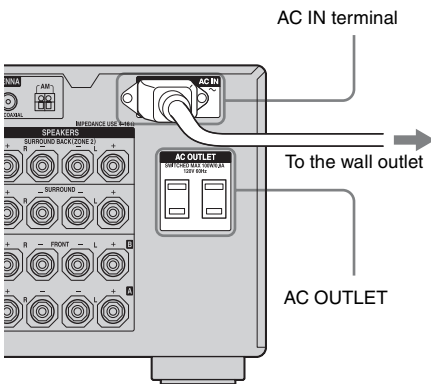

A several space is left between the plug and the rear panel even when the power cord (mains lead) is inserted firmly. The cord is supposed to be connected this way. This is not malfunction.

Notes

- The AC OUTLET(s) on the rear of the receiver is a switched outlet, which supplies power to the connected component only while the receiver is turned on.
- Make sure that the total power consumption of the component(s) connected to the receiver's AC OUTLET(s) does not exceed the wattage stated on the rear panel. Do not connect high-wattage electrical home appliances such as electric irons, fans, or TVs to this outlet. This may cause a malfunction.

Performing initial setup operations

Before using the receiver for the first time, initialize the receiver by performing the following procedure. This procedure can also be used to return settings you have made to their factory defaults.

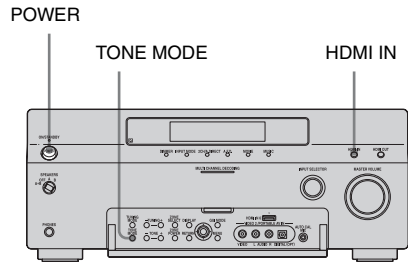

- 1 Press POWER to turn off the receiver.**
- 2 Hold down POWER while pressing TONE MODE and HDMI IN to turn on the receiver.**
- 3 Release the TONE MODE and HDMI IN after a few seconds.**

After “MEMORY CLEARING...” appears on the display for a while, “MEMORY CLEARED.” appears. All the settings you have changed or adjusted are reset to the initial settings.

Inserting batteries into the remote

Insert two R6 (size-AA) batteries in the main and the zone 2/zone 3 remote commanders. Observe the correct polarity when installing batteries.

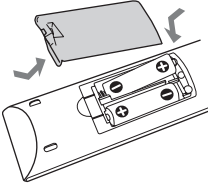

Notes

- Do not leave the remote in an extremely hot or humid place.
- Do not use a new battery with old ones.
- Do not mix manganese batteries and other kinds of batteries.
- Do not expose the remote sensor to direct sunlight or lighting apparatuses. Doing so may cause a malfunction.
- If you do not intend to use the remote for an extended period of time, remove the batteries to avoid possible damage from battery leakage and corrosion.
- When you replace the batteries, the programmed remote codes may be cleared. If this happens, program the remote codes again (page 137).

Tip

When the remote no longer operates the receiver, replace all the batteries with new ones.

7: Displaying the GUI menu on the TV screen

You can select the functions or change the settings of the receiver by using the GUI menu on the TV screen. Follow the procedure below to make the settings so that the GUI menu appears on the TV screen.

Tip

Refer to “Operating without connecting to a TV” (page 129) if you want to operate the receiver without connecting to a TV.

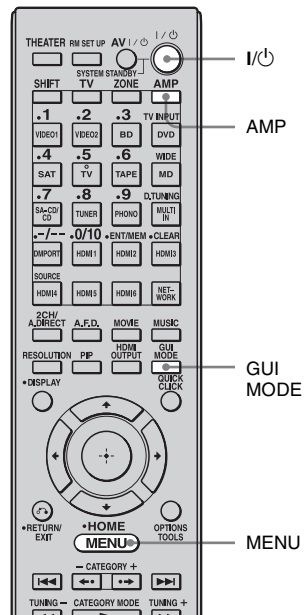

1 Connect a TV monitor to this receiver.

Refer to “3: Connecting the monitor” (page 26).

2 Turn on the receiver and the TV.

3 Press AMP.

The receiver can be operated using the remote.

4 Press GUI MODE.

After “GUI MODE ON” has appeared in the display window of the receiver, “GUI MODE” appears.



The receiver menu is displayed on the TV screen.

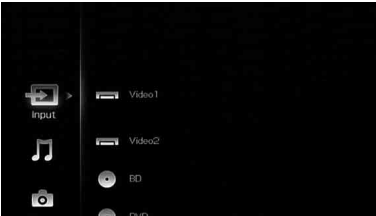

Tip

You can select the language to be used for messages on the GUI menu on the TV screen from English, Spanish, French and German. For details, see “ System settings” (page 128).

To exit the menu

Press MENU.

8: Setting the speakers

Setting the speaker impedances

Set the appropriate speaker impedance for the speakers you are using.

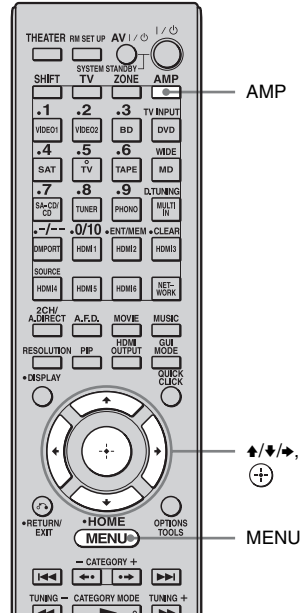

1 Press AMP.

The receiver can be operated using the remote.

2 Press MENU.

The menu is displayed on the TV screen.



- 3** Press \uparrow/\downarrow repeatedly to select “Settings,” then press \oplus or \rightarrow .

The Settings menu list appears on the TV screen.

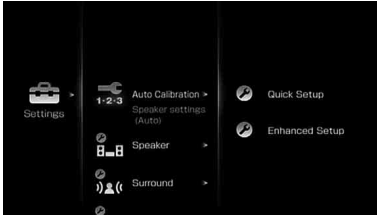

- 4** Press \uparrow/\downarrow repeatedly to select “Speaker,” then press \oplus or \rightarrow .

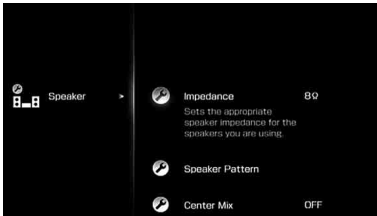

- 5** Press \uparrow/\downarrow repeatedly to select “Impedance,” then press \oplus .

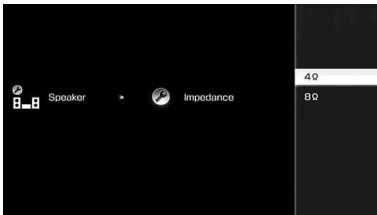

- 6** Press \uparrow/\downarrow repeatedly to select “4 Ω” or “8 Ω” depending on the speakers you are using, then press \oplus .

The parameter you have selected is entered.

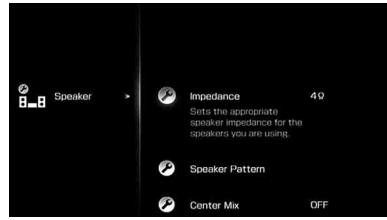

To exit the menu

Press MENU.

Notes

- If you are not sure of the impedances of the speakers, refer to the operating instructions supplied with your speakers. (This information is often on the back of the speaker.)
- When you connect all speakers with a normal impedance of 8 ohms or higher, set “Impedance” to “8 Ω.” When connecting other types of speakers, set it to “4 Ω.”
- When you connect front speakers to both the SPEAKERS A and B terminals, connect the speakers with a normal impedance of 8 ohms or higher.
 - When you connect speakers with impedance of 16 ohms or higher in both “A” and “B” configuration:
Set “Impedance” to “8 Ω” in the Speaker settings menu.
 - For other types of speakers in other configurations:
Set “Impedance” to “4 Ω” in the Speaker settings menu.

Selecting the front speakers

You can select the front speakers you want to drive.

SPEAKERS switch

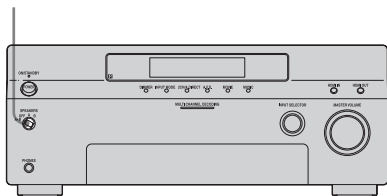

Set the SPEAKERS switch to select the front speaker system you want to drive.

Note

This setting is not available when headphones are connected.

Set to	To select
A	The speakers connected to the FRONT SPEAKERS A terminals.
B	The speakers connected to the FRONT SPEAKERS B terminals.
A+B	The speakers connected to both the FRONT SPEAKERS A and B terminals (parallel connection).
OFF	No audio signals are output from any speaker terminals, or the PRE OUT jacks.

9: Calibrating the appropriate speaker settings automatically (Auto Calibration)

The DCAC (Digital Cinema Auto Calibration) function allows you to perform automatic calibration, such as checking the connection between each speaker and the receiver, adjusting the speaker level, and measuring the distance of each speaker from your seating position automatically.

Before you perform the auto calibration

Before you perform the auto calibration, set up and connect the speakers (page 22-25).

- The AUTO CAL MIC jack is used for the supplied optimizer microphone only. Do not connect other microphones. Doing so may damage the receiver and the microphone.
- During the measurement, the sound that comes out of the speakers is very loud. The volume of the sound cannot be adjusted. Pay attention to the presence of children or to the effect on your neighborhood.
- Perform the measurement in a quiet environment to avoid the effect of noise and get a more accurate measurement.
- If there are any obstacles in the path between the optimizer microphone and the speakers, the calibration cannot be performed correctly. Remove any obstacle from the measurement area to avoid measurement error.
- When you use a bi-amplifier connection, set “Sur Back Assign” to “BI-AMP” in the Speaker settings menu before you perform auto calibration.

Notes

- The auto calibration function does not work if headphones are connected.
- Cancel MUTING if it is set to on.

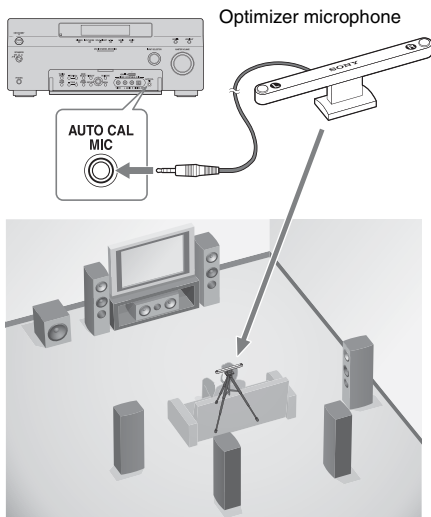

- If you connect a subwoofer with the crossover frequency function, set the value to maximum.
- If you connect a subwoofer with an auto standby function, set it to off (deactivated).

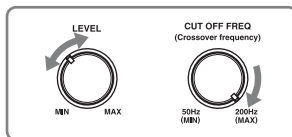

Note

Depending on the characteristics of the subwoofer you are using, the setup distance value may be further away from the actual position.

To use the receiver as a pre-amplifier

You can use the auto calibration function when you use the receiver as a pre-amplifier. In this case, the distance value shown on the display may differ from the actual distance value. However, there will be no problems even if you continue to use the receiver with that value.

1 Connect the supplied optimizer microphone to the AUTO CAL MIC jack.

2 Set up the optimizer microphone.

Place the optimizer microphone at your seating position. Use a stool or tripod so that the optimizer microphone remains at the same height as your ears. Orient the L end of the optimizer microphone toward the front left speaker and the R end of the optimizer microphone toward the front right speaker.

Note

When you position the optimizer microphone at the center of the two speakers, if the angle between the two speakers is too narrow, the optimizer microphone cannot measure the left and right speakers properly.

On setting up the active subwoofer

- When a subwoofer is connected, turn on the subwoofer and turn up the volume beforehand. Turn the MASTER VOLUME knob to just before the mid-point.

Performing auto calibration

The auto calibration function allows you to measure the following:

- Speaker connections^{a)}
- Polarity of speakers
- Speaker distance^{b)}
- Speaker angle^{b)}
- Speaker size^{b)}
- Speaker level
- Frequency characteristics^{c)}

- This receiver corrects signals by analog downmix processing only for the center speaker and subwoofer when the multi-channel input is selected. The correction is invalid for other speakers.
- The measurement result is not utilized when the multi-channel input is selected.
- Signals with a sampling frequency of higher than 96 kHz are always played back at either 44.1 kHz or 48 kHz.

continued

- The measurement result is not utilized in the following cases.
 - The multi-channel input is selected.
 - “2ch Analog Direct” is being used.
- The measurement result is not utilized when Dolby TrueHD signals with a sampling frequency of higher than 96 kHz are being received.

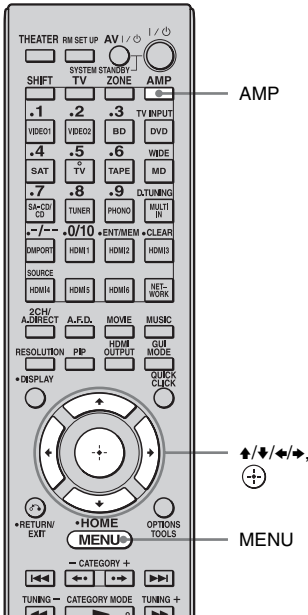

1 Press AMP.

The receiver can be operated using the remote.

2 Press MENU.

The menu is displayed on the TV screen.



3 Press \uparrow/\downarrow repeatedly to select “Settings,” then press \oplus or \rightarrow .

The Settings menu list appears on the TV screen.

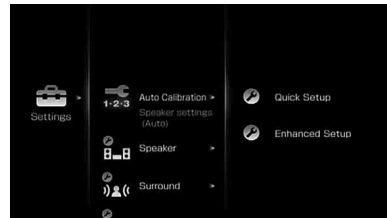

4 Press \uparrow/\downarrow repeatedly to select “Auto Calibration,” then press \oplus or \rightarrow .

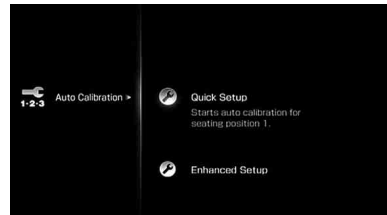

5 Press \uparrow/\downarrow repeatedly to select “Quick Setup,” then press \oplus .

The screen on which you can select the item to be measured appears.

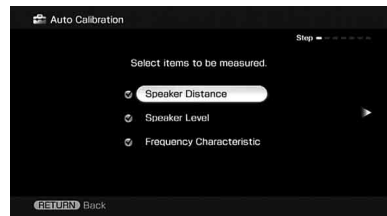

6 Press \uparrow/\downarrow repeatedly and \oplus to un-check the items you do not want to measure, then press \rightarrow .

The confirmation screen, asking whether you are ready to start measurement, appears.

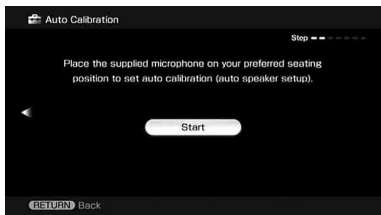

7 Press \oplus to select “Start.”

The measurement starts in five seconds. When the measurement ends, a beep sounds and the measurement result appears on the TV screen.

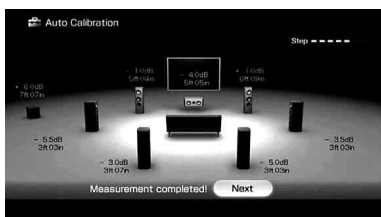

8 Press \oplus to select “Next.”

“Save auto calibration (auto speaker setup)?” appears. To save the measurement results, follow the steps in “Saving the measurement results” (page 52).

If a warning message or error code appears on the screen, see “Message list after auto calibration measurement” (page 53).

Note

When the speaker(s) is (are) out of the phase, “Out Phase” is displayed on the TV screen. The “+” and “-” terminals of the speaker may be connected the other way around. However, depending on the speakers, “Out Phase” appears on the TV screen even though the speakers are connected properly. This is because of the speakers’ specifications. In this case, you can continue to use the receiver.

Tips

- Operations other than turning the receiver on or off are deactivated during the measurement.
- In the following situations, the measurements have not been performed correctly or auto calibration cannot be performed.
 - when connecting special speakers, such as dipole speakers.
 - when using the zone 2/zone 3 function in zone 2/zone 3.
- You can change the unit of distance use in “Distance Unit” in the Speaker settings menu.

To cancel the measurement

The measurement is cancelled when you change the volume, switch functions, change the setting of the SPEAKERS switch, or connect headphones.

Saving the measurement results

To save the measurement results obtained in “Performing auto calibration” (page 49), proceed with the following steps.

- 1 Press \leftarrow/\rightarrow to select “Yes” in step 8 in “Performing auto calibration,” then press \oplus .**

The selecting screen of the calibration type appears.

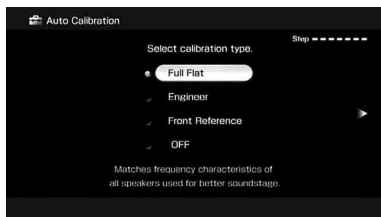

- 2 Press \uparrow/\downarrow repeatedly to select the auto calibration type, then press \oplus .**

Parameter	Explanation
Full Flat	Makes the measurement of frequency from each speaker flat.
Engineer	Sets the frequency to one that matches that of the Sony listening room standard.
Front Reference	Adjusts the characteristics of all the speakers to match the characteristics of the front speaker.
OFF	Sets the auto calibration EQ to off.

The measurement results are saved.

- 3 Press \rightarrow .**

The exit screen appears.



- 4 Press \oplus .**

Notes

- After reflecting the results of a compensation for a frequency characteristic, signals with a sampling frequency of higher than 96 kHz are always played back at either 44.1 kHz or 48 kHz.
- The frequency response measurement result is not utilized in the following cases.
 - The multi-channel input is selected.
 - “2ch Analog Direct” is being used.
- The measurement result is not utilized when Dolby TrueHD signals with a sampling frequency of higher than 96 kHz are being received.

Tip

The size of a speaker (LARGE/SMALL) is determined by the low characteristics. The measurement results may vary, depending on the position of the optimizer microphone and speakers, and the shape of the room. It is recommended that you follow the measurement results. However, you can change those settings in the Speaker settings menu. Save the measurement results first, then try to change the settings if you want.

Checking the auto calibration results

If a warning message or error code appears in step 8 of “Performing auto calibration” (page 49), check the problem of the error and perform auto calibration again.

- 1 Press **↔** to select “Yes,” then press **+** when “Error occurred during calibration, press to investigate.” appears on the screen.

Confirm the details of the measurement results, then proceed with the appropriate remedy.

- 2 Press **↔** to select “Retry,” then press **+**.

- 3 Repeat steps 6 to 8 in “Performing auto calibration” (page 49).

To save measurement results that caused an error without taking a remedy

- 1 Press **↔** to select “No”, then press **+** when “Error occurred during calibration, press to investigate.” appears on the screen.
- 2 Follow the steps in “Saving the measurement results” (page 52) to save the measurement results.

Message list after auto calibration measurement

Display	Explanation
Code 30	Headphones are connected. Remove the headphones and perform the auto calibration again.
Code 31	SPEAKERS (OFF/A/B/A+B) is set to OFF. Set it to others and re-perform the measurement.
Code 32	None of the speakers were detected. Make sure that the optimizer microphone is connected properly and reperform the measurement. If the optimizer microphone is connected properly but the error code appears, the optimizer microphone cable may be damaged or improperly connected.
Code 33	<ul style="list-style-type: none"> • None of the front speakers are connected or only one front speaker is connected. • The optimizer microphone is not connected. • Either the left or right surround speakers is not connected. • Surround back speakers are connected even though surround speakers are not connected. Connect the surround speaker(s) to the SURROUND terminals. • The surround back speaker is connected only to the SURROUND BACK SPEAKERS R terminals. When you connect only one surround back speaker, connect it to the SURROUND BACK SPEAKERS L terminals.
Code 34	Speakers are not placed in the proper position. Speakers or an optimizer microphone on the right or left may be placed wrongly. See “1: Installing speakers” (page 22) and check the speaker position.
Warning 40	The measurement has completed. However, the noise level is high. You may be able to perform the measurement properly if you try it again, even though the measurement cannot be performed in all environments. Try to perform the measurement in a quiet environment.
Warning 41	The input from the microphone is too big.
Warning 42	<ul style="list-style-type: none"> • It may be too close the distance between the speaker and the microphone. Retry the measurement after setting apart from each other. <ul style="list-style-type: none"> • It may be that the volume is too big when you use the receiver as a preamp.
Warning 43	The distance and position of a subwoofer cannot be detected. Or the angle of the speaker position cannot be detected. This may be caused by noise. Try to perform the measurement in a quiet environment.

continued

Display	Explanation
Warning 44	Measurement has been completed. However the speakers are not placed in the proper position with respect to each other. See "1: Installing speakers" (page 22) and check the relative positions of the speakers.
NO WARNING	There is no warning information.
-----	No speakers are connected.

Tip

Depending on the position of the subwoofer, the measurement results for polarity may vary.

However, there will be no problems even if you continue to use the receiver with that value.

Guide to on-screen display operation

You can display the menu of the receiver on the TV screen and select the function you want to use on the TV screen by pressing $\uparrow/\downarrow/\leftarrow/\rightarrow$ and \oplus on the remote.

To display the menu of the receiver on the TV screen, make sure that the receiver is in “GUI MODE” following the steps in “7: Displaying the GUI menu on the TV screen” (page 45).

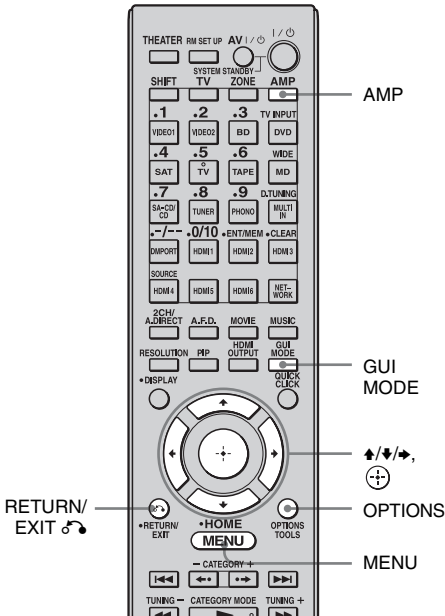

AMP

GUI MODE

 $\uparrow/\downarrow/\leftarrow/\rightarrow$
 \oplus

OPTIONS

MENU

RETURN/
EXIT \hookrightarrow

Using the menu

1 Press AMP.

The receiver can be operated using the remote.

2 Press MENU.

The menu is displayed on the TV screen.



3 Press \uparrow/\downarrow repeatedly to select the menu you want, then press \oplus or \rightarrow to enter the menu mode.

The menu item list appears on the TV screen.

Example: When you select “Input”



4 Press \uparrow/\downarrow repeatedly to select the menu item you want to adjust, then press \oplus to enter the menu item.

5 Repeat steps 3 and 4 to select the parameter you want.

To return to the previous screen

Press RETURN/EXIT \hookrightarrow .









To exit the menu

Press MENU.

To exit “GUI MODE”

Press GUI MODE. “GUI MODE OFF” appears and you can operate the receiver using the menu in the display window of the receiver.

Overview of the main menus

Menu icon	Description
 Input	Selects the input source component connected to the receiver (page 58).
 Music	Selects the music from the audio component connected to the DIGITAL MEDIA PORT adapter (page 60) or server on the home network.
 Photo	Select the photos from the server on the home network.
 Video	Select the images from the video component connected to the DIGITAL MEDIA PORT adapter (page 60) or server on the home network.
 Rhapsody	Selects the Rhapsody radio service. Refer to the “Using Network Features” supplied with these operating instructions.
 SHOUTcast	Selects the SHOUTcast radio service. Refer to the “Using Network Features” supplied with these operating instructions.
 FM/AM/XM/SIRIUS	Selects the built-in FM/AM radio or satellite tuner connected (page 65, 68).
 Settings	You can adjust the settings of the speakers, the surround effect, equalizer, audio, video and other inputs connected to the HDMI jacks (page 111).

Using the option menus

When you press OPTIONS, the option menus for the selected main menu are displayed. You can select a related function without reselecting the menu.

1 Press AMP.

The receiver can be operated using the remote.

2 Press MENU.

The menu is displayed on the TV screen.

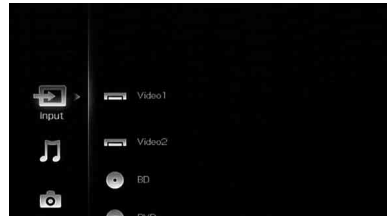

3 Press \uparrow/\downarrow repeatedly to select a menu you want, then press \oplus or \rightarrow to enter the menu mode.

The menu item list appears on the TV screen.

Example: When you select “ Input”

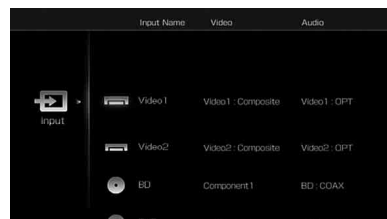

4 Press OPTIONS while the menu item list is displayed.

The option menu appears.

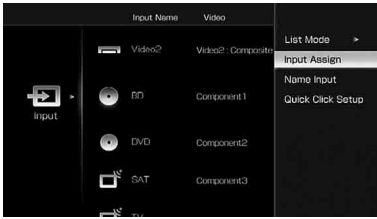

5 Press \uparrow/\downarrow repeatedly to select the option menu item you want, then press \odot .

6 Press \uparrow/\downarrow repeatedly to select the parameter you want, then press \odot .

To exit the menu

Press MENU.

Playback

Enjoying sound/images from the component connected to the receiver

Refer to “Using Network Features” supplied with these operating instructions for details on playing back content on your home network.

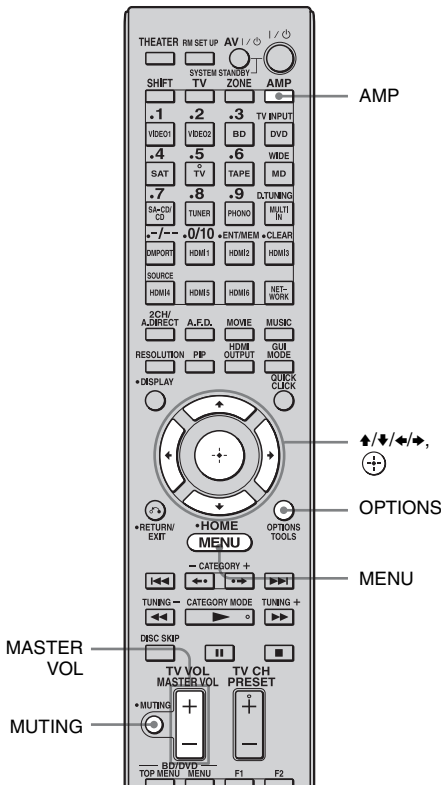

2 Press MENU.

The menu is displayed on the TV screen.

3 Press \uparrow/\downarrow repeatedly to select “Input,” then press \oplus or \rightarrow .

The menu item list appears on the TV screen.

4 Press \uparrow/\downarrow repeatedly to select the component you want, then press \oplus .

The menu screen disappears and the playback screen of the external input appears.

Selected input	Components that can be used
Video1, Video2	VIDEO 1, 2 VCR, etc., connected to the VIDEO 1 or VIDEO 2 jack.
BD	Blu-ray Disc Player, etc., connected to the BD jack.
DVD	DVD player, etc., connected to the DVD jack.
SAT	Satellite tuner, etc., connected to the SAT jack.
TV	TV connected to the TV jack.
TAPE	Tape deck, etc., connected to the TAPE jack.
MD	MD deck, etc., connected to the MD jack.
SA-CD/CD	Super Audio CD or CD player, etc., connected to the SA-CD/CD jack.
Phono	Turntable, etc., connected to the PHONO jack.
MULTI IN	Component connected to the MULTI CHANNEL INPUT jack.

1 Press AMP.

The receiver can be operated using the remote.

Selected input	Components that can be used
 HDMI1, 2, 3, 4, 5, 6	HDMI components connected to the HDMI1, HDMI2, HDMI3, HDMI4, HDMI5, or HDMI6 jack.

- 5 Turn on the component and start playback.**
- 6 Press MASTER VOL +/- to adjust the volume.**

Tips

- You can adjust the volume differently depending on the speed with which you turn the MASTER VOLUME knob.
To turn the volume up or down quickly: turn the knob quickly.
To make fine adjustment: turn the knob slowly.
- You can adjust the volume differently depending on the length of time you press and hold the MASTER VOL +/- button on the remote.
To turn the volume up or down quickly: press and hold the button.
To make a fine adjustment: press the button and release it immediately.

To activate the muting function

Press MUTING on the remote. To cancel, press MUTING on the remote again or press MASTER VOL + to raise the volume.

To avoid damaging your speakers

Before you turn off the receiver, be sure to turn down the volume level.

Naming the input (Name Input)

You can enter a name of up to 8 characters for inputs and display it.

This is convenient for labeling the jacks with the names of the connected components.

- 1 Press \uparrow/\downarrow repeatedly on the “ Input” screen to select the input you want to name.**

- 2 Press OPTIONS.**

The option menu appears.

- 3 Press \uparrow/\downarrow repeatedly to select “Name Input,” then press \oplus .**

The soft keyboard appears on the screen.

- 4 Press $\uparrow/\downarrow/\leftarrow/\rightarrow$ and \oplus to select a character one by one to enter the name.**

- 5 Press $\uparrow/\downarrow/\leftarrow/\rightarrow$ to select “Finish,” then press \oplus .**

The name you entered is registered.

To cancel naming input

Press $\uparrow/\downarrow/\leftarrow/\rightarrow$ to select “Cancel,” then press \oplus .

Changing the display items (List Mode)

When you select “ Input,” you can change the items to be displayed.

- 1 Press \uparrow/\downarrow repeatedly on the “ Input” screen to select the input you want.**

- 2 Press OPTIONS.**

The option menu appears.

- 3 Press \uparrow/\downarrow repeatedly to select “List Mode,” then press \oplus .**

- 4 Press \uparrow/\downarrow repeatedly to select the item you want to display, then press \oplus .**

- Input Assign
Input name and audio/video input jack assigned to the input are displayed in a list.
- Sound Field
Input name and the sound field selected for the input are displayed in a list.

- A/V Sync
Input name and the delay set on the “A/V Sync” menu for the input are displayed in a list.

Enjoying sound/images from the components connected to the DIGITAL MEDIA PORT

The DIGITAL MEDIA PORT is for enjoying sound/images from a portable audio source or computer by connecting a DIGITAL MEDIA PORT adapter.

Available DIGITAL MEDIA PORT adapters vary in each area.

For details on connecting the DIGITAL MEDIA PORT adapter, see “Connecting components with digital audio input/output jacks” (page 29).

You can use the following Sony DIGITAL MEDIA PORT adapters:

- TDM-BT1 Bluetooth™ Wireless Audio Adapter
- TDM-NW1/NW10 DIGITAL MEDIA PORT Adapter
- TDM-iP1/iP10/iP50 DIGITAL MEDIA PORT Adapter
- TPM-MP10 DIGITAL MEDIA PORT Adapter

The DIGITAL MEDIA PORT adapter is an optional product.

Notes

- Do not connect an adapter other than the DIGITAL MEDIA PORT adapter.
- Before disconnecting the DIGITAL MEDIA PORT adapter, make sure to turn the receiver off using the remote.
- Do not connect or disconnect the DIGITAL MEDIA PORT adapter to/from the receiver while the system is turned on.
- Depending on the type of DIGITAL MEDIA PORT adapter, the images are also output.
- Do not connect to the receiver a DIGITAL MEDIA PORT adapter that uses a network function such as TDM-NC1 Wireless Network Audio Client.
You can use the network function of the receiver without using a DIGITAL MEDIA PORT adapter. Refer to “Using Network Features” supplied with this manual for details of the network function.

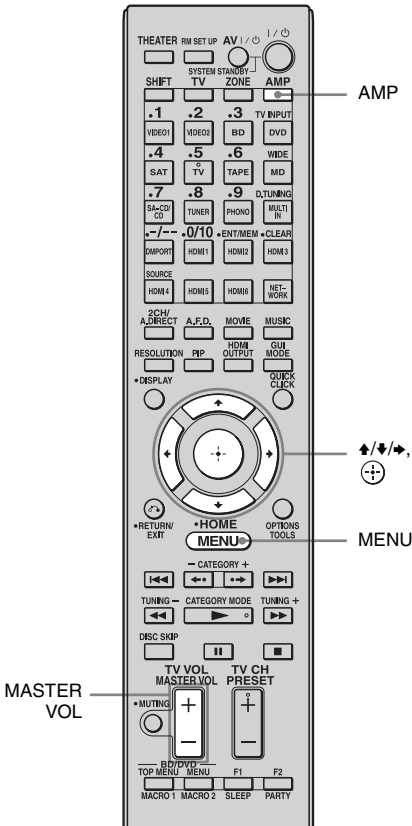

The component connected to the DIGITAL MEDIA PORT adapter is recognized and “DMPORT1” and “DMPORT2” on the screen will change to the respective component’s name with an icon. If the adapter connected cannot be recognized, “DMPORT1” or “DMPORT2” is displayed on the TV screen.

Icon	Component that is connected
	DMPORT A component other than one of the following is connected.
	iPod The iPod model recognized is connected.
	Walkman The Network Walkman recognized is connected.
	Bluetooth The Bluetooth drive recognized is connected.
	Mobile Phone The Mobile Phone recognized is connected.

- 1 Press AMP.**
The receiver can be operated using the remote.
- 2 Press MENU.**
The menu is displayed on the TV screen.
- 3 Press \uparrow/\downarrow repeatedly to select “ Music” or “ Video,” then press \oplus or \rightarrow .**
- 4 Press \uparrow/\downarrow repeatedly to select “DMPORT1,” “DMPORT2,” or a component connected to the DIGITAL MEDIA PORT adapter, then press \oplus .**

- 5 Select a track you want to play using the component connected to the DIGITAL MEDIA PORT adapter.**
- 6 Press MASTER VOL +/- to adjust the volume.**

Operating the TDM-iP1/iP50 using the GUI menu of the receiver

Make sure that “System GUI” is selected in step 4 in “Changing the operation screen using the DIGITAL MEDIA PORT” (page 63).

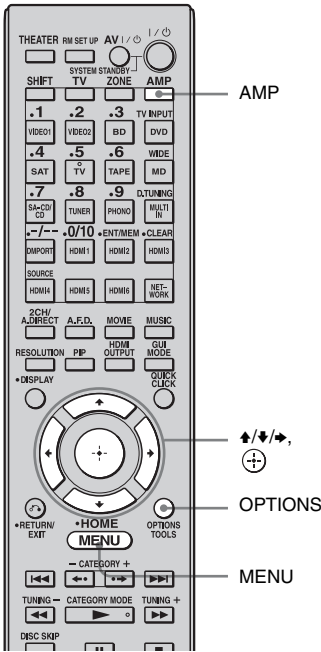

- 1 Press AMP.**
The receiver can be operated using the remote.
- 2 Press MENU.**
The menu is displayed on the TV screen.
- 3 Press \uparrow/\downarrow repeatedly to select “Music” or “Video,” then press \oplus or \rightarrow .**

- 4 Press \uparrow/\downarrow repeatedly to select the component connected to the DIGITAL MEDIA PORT adapter you want to play, then press \oplus .**

The contents list appears.

- 5 Press $\uparrow/\downarrow/\leftarrow/\rightarrow$ and \oplus to select track or content from the contents list.**

The following content lists are just examples. They may vary depending on the components connected to the receiver.

In case of iPod

- Music
 - Playlists > Playlist > Track
 - Artists > Artist > Album > Track
 - Albums > Album > Track
 - Songs > Track
 - Genres > Genre > Artist > Album > Track
 - Composers > Composer > Album > Track
 - Audiobooks > Track

- Video
 - Movies > Content
 - TV Shows > Episode > Content
 - Music Videos > Artist > Content
 - Video Podcast > Episode > Content

- 6 Press MASTER VOL +/- to adjust the volume.**

Selecting the playback mode

- 1 Play back the track you want to listen to following the steps outlined in “Operating the TDM-iP1/iP50 using the GUI menu of the receiver” (page 62).**

- 2 Press OPTIONS.**

The option menu appears.

3 Press **▲/▼** repeatedly to select “Shuffle,” “Repeat,” or “Audiobook Speed,” then press **⊕**.

4 Press **▲/▼** repeatedly to select the mode you want to select from the following, then press **⊕**.

■ Shuffle (TDM-iP1/iP50 only)

Plays all the tracks in random order.

- Off
Deactivates the shuffle play mode.
- Albums
Plays all the tracks on an album in random order.
- Songs
Plays all the tracks in “Songs” in random order.

■ Repeat (TDM-iP1/iP50 only)

Plays one or all the tracks repeatedly.

- Off
Deactivates the repeat play mode.
- One
Plays one track repeatedly.
- All
Plays all the tracks repeatedly.

■ Audiobook Speed (TDM-iP50 only)

Selects the display speed of the Audiobook.

- Low
Slows the display speed.
- Normal
Sets the display speed to standard.
- High
Increases the display speed.

DIGITAL MEDIA PORT message list

Message appears	Explanation
No Adapter	The adapter is not connected.
No Device	There is no device connected to the adapter.
No Audio	No audio file was found.
Loading	The data is being read.
No Item	No item was found.

Changing the operation screen using the DIGITAL MEDIA PORT

You can change the operation screen using the GUI menu. The DMPORT Control mode is supported by the DIGITAL MEDIA PORT adapters like TDM-iP1/iP50. This mode is not supported by other adapters.

1 Press **▲/▼** repeatedly on the “**♪ Music**” or “**📺 Video**” screen to select the **DIGITAL MEDIA PORT** adapter you want, then press **⊕** or **➡**.

2 Press **OPTIONS**.

The option menu appears.

3 Press **▲/▼** to select “**DMPORT Control**,” then press **⊕**.

If “DMPORT Control” is not displayed, see the operating instructions supplied with component for details on operating that component.

4 Press **▲/▼** repeatedly to select the mode you want, then press **⊕**.

You can select the following modes in this menu;

- System GUI
This mode is for the TDM-iP1/iP50. The list of tracks will be displayed on the GUI screen of the receiver. You can select a track you want and play back it on each GUI screen.

continued

- **Adapter GUI**
This mode is for the TDM-iP1/iP50.
The menu of the adapter will be displayed on the TV screen.
- **iPod**
This mode can be selected only when the TDM-iP1/iP50 is connected.

To operate the TDM-iP1/iP50 using the adapter menu

Make sure that “Adapter GUI” is selected in step 4 in “Changing the operation screen using the DIGITAL MEDIA PORT” (page 63).

For details on operating the adapter using the adapter GUI menu, refer to the operating instructions supplied with the adapter you are using.

To operate the TDM-iP1/iP50 using the iPod menu

Make sure that “iPod” is selected in step 4 in “Changing the operation screen using the DIGITAL MEDIA PORT” (page 63).

For details on operating the iPod, refer to the operating instruction supplied with the iPod.

Tuning into a station directly (Direct Tuning)

Enter the frequency of a station directly by using the numeric buttons.

1 Press AMP.

The receiver can be operated using the remote.

2 Press MENU.

The menu is displayed on the TV screen.

3 Press \uparrow/\downarrow repeatedly to select “FM FM” or “AM AM,” then press \oplus or \rightarrow .

4 Press \uparrow/\downarrow to select “Direct Tuning,” then press \oplus .

5 Press SHIFT, then press the numeric buttons to enter the frequency, then press \oplus .

Example 1: FM 102.50 MHz

Select 1 \rightarrow 0 \rightarrow 2 \rightarrow 5

Example 2: AM 1,350 kHz

Select 1 \rightarrow 3 \rightarrow 5 \rightarrow 0

Tip

If you have tuned in an AM station, adjust the direction of the AM loop antenna (aerial) for optimum reception.

If you cannot tune in a station

“---.--- MHz” appears and then the display returns to the current frequency.

Make sure you have entered the right frequency. If not, repeat step 5. If you still cannot tune in a station, the frequency is not used in your area.

Changing the AM tuning scale

You can change the AM tuning scale to either 9 kHz or 10 kHz on the receiver.

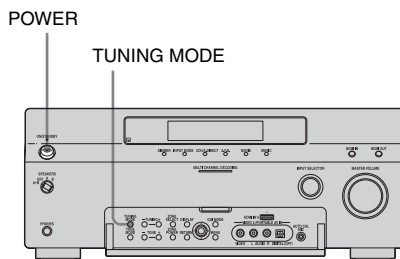

1 Press POWER to turn off the receiver.

2 While holding down TUNING MODE, press POWER on the receiver.

3 Change the current AM tuning scale to 9 kHz (or 10 kHz).

To reset the scale to 10 kHz (or 9 kHz), repeat the procedure above.

Note

All preset stations will be erased when you change the tuning scale.

Presetting FM/AM radio stations

You can preset up to 30 FM and 30 AM stations. Then you can easily tune in the stations you often listen to.

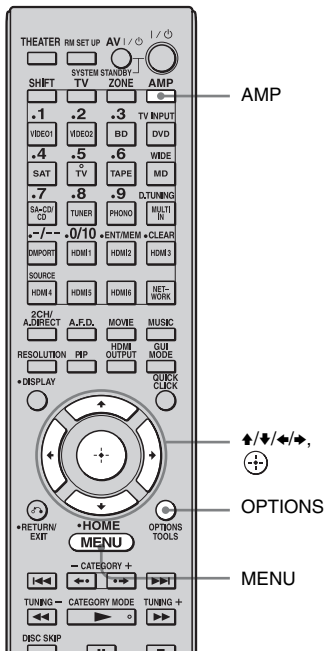

1 Tune in the station that you want to preset using Auto Tuning (page 65) or Direct Tuning (page 66).

In case of poor FM stereo reception, switch the FM reception mode (page 65).

2 Press **OPTIONS**.
The option menu appears.

3 Press **↑/↓** to select “Memory,” then press **+/-**.

4 Press **↑/↓** to select a preset number, then press **+/-**.

The station is stored as the selected preset number.

5 Repeat steps 1 to 4 to preset another station.

You can store stations as follows:

- AM band: AM1 to AM30
- FM band: FM1 to FM30

Tuning to preset stations

1 Press **AMP**.

The receiver can be operated using the remote.

2 Press **MENU**.

The menu is displayed on the TV screen.

3 Press **↑/↓** repeatedly to select “**FM** FM” or “**AM** AM,” then press **+/-** or **→**.

4 Press **↑/↓** to select the preset number station you want.

Preset numbers from 1 to 30 are available.

Naming preset stations (Name Input)

1 On “**FM** FM” or “**AM** AM” screen, press **↑/↓** to select the preset number on which you have stored the station and which you want to name.

2 Press **OPTIONS**.
The option menu appears.

3 Press **↑/↓** repeatedly to select “Name Input,” then press **+/-**.
The soft keyboard appears on the screen.

4 Press **▲/▼/◀/▶** and **⊕** to select a character one by one to enter the name.

5 Press **▲/▼/◀/▶** to select “Finish,” then press **⊕**.

The name you entered is registered.

To cancel naming input

Press **▲/▼/◀/▶** to select “Cancel,” then press **⊕**.

Listening to satellite radio

You can listen to XM Radio and SIRIUS Satellite Radio by connecting a satellite tuner, not supplied, to the receiver.

XM Radio service

About XM Radio

XM is North America’s number one satellite radio company, offering an extraordinary variety of commercial-free music, plus the best in premier sports, news, talk radio, comedy, children’s and entertainment programming, broadcast in superior digital audio quality coast to coast. For more information, or to subscribe, U.S. customers visit xmradio.com or call XM Listener Care at 1-800-XMRADIO (1-800-967-2346); Canadian customers visit xmradio.ca or call XM Listener Care at 1-877-GETXMSR (1-877-438-9677).

XM Ready® Legal

XM monthly service subscription sold separately. XM Mini-Tuner and Home Dock required (each sold separately) to receive XM service. It is prohibited to copy, decompile, disassemble, reverse engineer, hack, manipulate or otherwise make available any technology or software incorporated in receivers compatible with the XM satellite Radio System. Installation costs and other fees and taxes, including a one-time activation fee may apply. All fees and programming subject to change. Channels with frequent explicit language are indicated with an XL. Channel blocking is available for XM radio receivers by calling 1-800-XMRADIO (U.S. residents) and 1-877-GETXMSR (Canadian residents). Only available in the 48 contiguous United States and Canada. ©2008 XM Satellite Radio Inc. All rights reserved.

XM Ready® Subscription

Once you have installed the XM Mini-Tuner Home Dock, inserted the XM Mini-Tuner, connected the XM Mini-Tuner Home Dock to your XM Ready® audio system, and installed the antenna, you are ready to subscribe and begin receiving XM programming. There are three places to find your eight character XM Radio ID: On the XM Mini-Tuner, on the XM Mini-Tuner package, and on XM Channel 0. Record the Radio ID below for reference.

Note

The XM Radio ID does not use the letters “I”, “O”, “S” or “F”.

Activate your XM Satellite Radio service in the U.S. online at <http://activate.xmradio.com> or call 1-800-XMRADIO (1-800-967-2346). Activate your XM Satellite Radio service in Canada online at <https://activate.xmradio.ca> or call 1-877-GETXMSR (1-877-438-9677).

You will need a major credit card. XM will send a signal from the satellites to activate the full channel lineup. Activation normally takes 10-15 minutes, but during peak busy periods you may need to keep your XM Ready audio system on for up to an hour. When you can access the full lineup on your XM Ready audio system you are done.

SIRIUS Satellite Radio service

SIRIUS Satellite Radio: The Best Radio On Radio

SIRIUS brings all your favorite entertainment including 100% commercial-free music, plus superior sports coverage, uncensored talk and comedy, world-class entertainment, news, weather and more for your car, home or office. Sirius is available in the US for subscribers with addresses in the continental US and is available in Canada for subscribers with a Canadian address. Required subscription plus compatible SiriusConnect Home Tuner with antenna are required and sold separately. SIRIUS

Programming is subject to change. Visit sirius.com or siriuscanada.ca for the most complete and up-to-date channel lineup and product information. “ SIRIUS” and the SIRIUS dog logo and related marks are trademarks of SIRIUS Satellite Radio Inc. All rights reserved.

To Subscribe to SIRIUS Satellite Radio

Purchase and connect a SiriusConnect Home Tuner to your Sirius Ready home audio system.

You are then ready to activate and subscribe to Sirius by either calling 1.888.539.SIRIUS (7474) or log on to sirius.com (US), siriuscanada.ca (Canada). It is that easy.

Connecting a satellite radio tuner

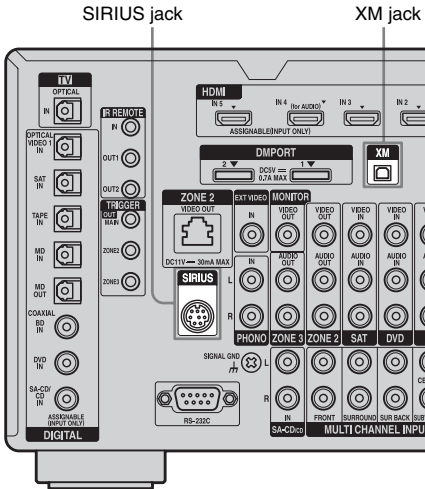

To connect to the XM jack

Before operating the system, connect the XM Mini-Tuner and Home Dock to the XM jack.

Note

To ensure optimal reception of XM's satellite signal, move your antenna to various window locations around your home to see where the best reception will be received. Most XM customers place the antenna in a south-facing window with a clear view to the sky.

To connect to the SIRIUS jack

Connect the SiriusConnect Home tuner. When you use the SiriusConnect Home tuner with this receiver, be sure to connect the AC power adaptor supplied with the tuner to a wall outlet. Keep the SiriusConnect Home tuner, antenna, and AC power adaptor away from the speaker cords and the power cord to avoid picking up noise.

Preparing to listen to a satellite radio

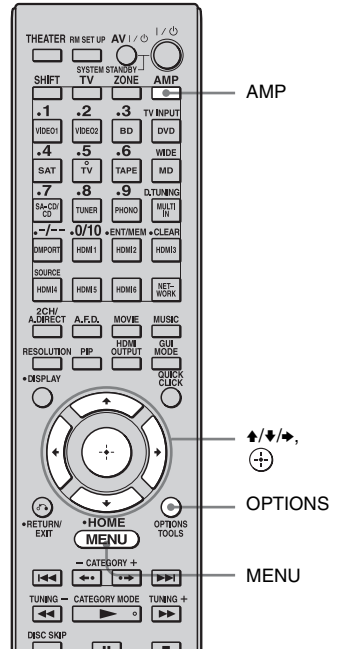

Checking the ID number

- 1 **Press AMP.**
The receiver can be operated using the remote.
- 2 **Press MENU.**
The menu is displayed on the TV screen.
- 3 **Press \uparrow/\downarrow repeatedly to select “XM XM” or “SR SIRIUS,” then press \oplus or \rightarrow .**

- 4** Press \uparrow/\downarrow to select “ALL,” then press \oplus or \rightarrow .

When the Preset Mode screen is displayed, change the tuning mode to “Category Mode,” then select “ALL.” Press OPTIONS, then press \uparrow/\downarrow repeatedly to select “Category Mode.”

- 5** Press \uparrow/\downarrow to select the channel 0, then press \oplus .

- 6** Check the XM Radio ID or Sirius ID on the TV screen and write it in the space provided here.

XM Radio ID: _____

Sirius ID: _____

You can also check the XM Radio ID and Sirius ID using the display on the receiver.

- 6** While checking the quality of the reception, adjust the direction of the antenna to obtain the best reception.

To exit the menu

Press MENU.



Checking receiving conditions (Antenna Aiming)

- 1** Press AMP.

The receiver can be operated using the remote.

- 2** Press MENU.

The menu is displayed on the TV screen.

- 3** Press \uparrow/\downarrow repeatedly to select “ XM” or “ SIRIUS,” then press \oplus or \rightarrow .

- 4** Press OPTIONS.

The option menu appears.

- 5** Press \uparrow/\downarrow repeatedly to select “Antenna Aiming,” then press \oplus .

The Antenna Aiming screen appears.

Selecting a channel of the satellite radio

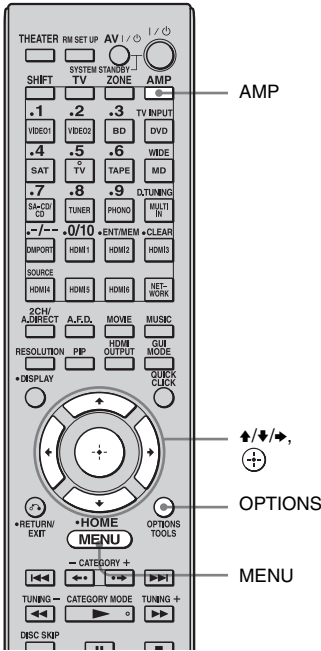

Selecting a channel by category (Category Mode)

You can select a channel from one category or all the categories.

- 1 Press AMP.**
The receiver can be operated using the remote.
- 2 Press MENU.**
The menu is displayed on the TV screen.
- 3 Press \uparrow/\downarrow repeatedly to select “**XM XM**” or “**SR SIRIUS**,” then press \oplus or \rightarrow .**
- 4 Press OPTIONS.**
The option menu appears.

- 5 Press \uparrow/\downarrow repeatedly to select the category, then press \oplus .**
 - ALL: You can select a channel from all the categories.
 - (category name): You can select a channel from one category.When the “Preset Mode” screen is displayed, press OPTIONS, then press \uparrow/\downarrow repeatedly to select “Category Mode.”

- 6 Press \uparrow/\downarrow to select the channel, then press \oplus .**
The selected channel is being received. The channel information is displayed on the TV screen.

Note

When you select a channel in the “Category Mode,” the channel you selected may not be the one in the category you want. This is because one channel may belong to more than one category.

Selecting a channel by inputting the channel number directly (Direct Tuning)

- 1 Press AMP.**
The receiver can be operated using the remote.
- 2 Press MENU.**
The menu is displayed on the TV screen.
- 3 Press \uparrow/\downarrow repeatedly to select “**XM XM**” or “**SR SIRIUS**,” then press \oplus or \rightarrow .**
- 4 Press OPTIONS.**
The option menu appears.
- 5 Press \uparrow/\downarrow to select “Direct Tuning,” then press \oplus .**
- 6 Press the numeric buttons to enter the channel number.**

7 Press .

The selected channel is tune in.

Presetting satellite radio channels

You can select the channels you want directly by presetting them using the preset numbers. You can preset up to 30 XM Radio channels and 30 SIRIUS Satellite Radio channels.

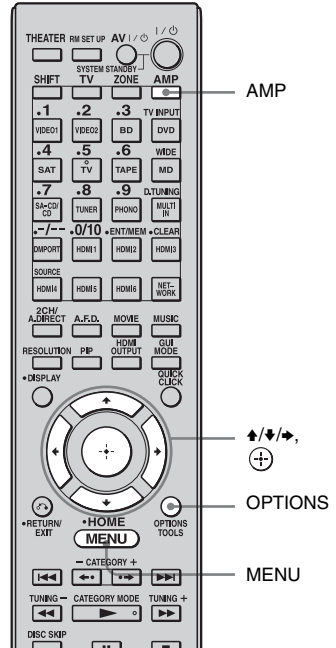

1 Select a channel you want to preset using **Category Mode** (page 72) or **Direct Tuning** (page 72).

2 Press **OPTIONS**.

The option menu appears.

3 Press **↑/↓** to select “Memory,” then press **+**.

The preset number selection screen appears.

- Press \uparrow/\downarrow repeatedly to select the preset number you want to use as the preset channel, then press \oplus .

Preset channels from 1 to 30 are available, and a default channel is preset for all the preset channels when you purchase the receiver.

The selected channel is registered as the preset channel you selected in step 1.

- Repeat steps 1 to 4 to preset another channel.

You can store channels from 1 to 30.

Selecting preset channels

- Press AMP.

The receiver can be operated using the remote.

- Press MENU.

The menu is displayed on the TV screen.

- Press \uparrow/\downarrow repeatedly to select “XM XM” or “SR SIRIUS,” then press \oplus or \rightarrow .

- Press \uparrow/\downarrow to select the preset number from the preset list, then press \oplus .

You can select stored preset channels from 1 to 30.

Notes

- The channel information you have preset may be changed if XM Satellite Radio Inc. or SIRIUS Satellite Radio Inc. change their channel programming.
- When the “Category Mode” screen is displayed, press OPTIONS, then press \uparrow/\downarrow to select “Preset Mode.”

Restricting access to specific channels (Parental Lock) (SIRIUS only)

You can restrict access to certain channels using your own lock code. The lock code is set to “0000” as the default.

Change the lock code before you use this function for the first time. See “To change the lock code (Lock Code)” (page 75).

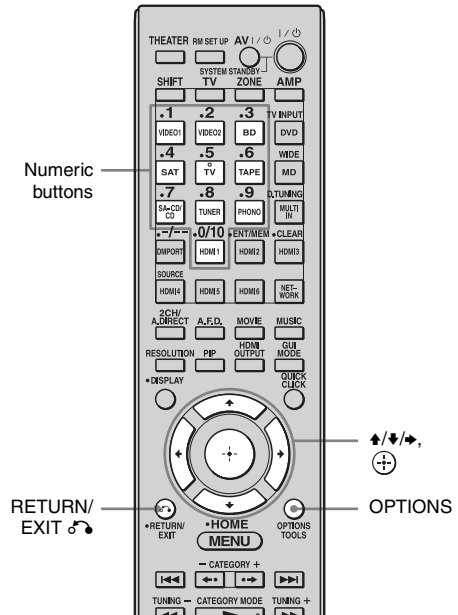

- Select a channel you want to lock using Category Mode (page 72) or Direct Tuning (page 72).

- Press OPTIONS.

The option menu appears.

- Press \uparrow/\downarrow to select “Parental Lock,” then press \oplus or \rightarrow .

- 4** Press **▲/▼** repeatedly to select “ON,” then press **⊕**.

“Enter your 4-digit lock code.” appears.

- 5** Enter your 4-digit lock code using the numeric buttons.

“The channel has been locked.” appears and the Parental Lock is set.

To delete the numbers you have entered, go back to step 2 by pressing RETURN/EXIT **↵**, and then repeat the procedure above from step 2.

To change the lock code (Lock Code)

- 1** Select a channel you want to change the lock code using Category Mode (page 72) or Direct Tuning (page 72).
- 2** Press **OPTIONS**.
The option menu appears.
- 3** Press **▲/▼** to select “Lock Code,” then press **⊕**.
“Enter your 4-digit lock code.” appears.
- 4** Enter your 4-digit lock code using the numeric buttons.
“Enter a new lock code.” appears.
- 5** Enter a new 4-digit lock code using the numeric buttons.
“To confirm, enter your new lock code again.” appears.
- 6** Reenter the new lock code with the numeric buttons.
“The lock code has been changed.” appears.

To listen to the locked channels

- 1** Select a locked channel you want to listen to using Category Mode (page 72) or Direct Tuning (page 72).
“The channel is locked. Enter your 4-digit lock code.” appears.

- 2** Enter your 4-digit lock code using the numeric buttons.

The channel is tuned in.

To cancel the Parental Lock

- 1** Select a channel you want to unlock using Category Mode (page 72) or Direct Tuning (page 72).
- 2** Press **OPTIONS**.
The option menu appears.
- 3** Press **▲/▼** to select “Parental Lock,” then press **⊕** or **➔**.
- 4** Press **▲/▼** repeatedly to select “OFF,” then press **⊕**.
“Enter your 4-digit lock code.” appears.
- 5** Enter your 4-digit lock code using the numeric buttons.
“The channel has been unlocked.” appears and the channel is unlocked.

Notes

- When you select a channel using Category Mode, locked channels are skipped.
- When the receiver is reset to the factory settings, the lock code returns to the default (0000), but the Parental Lock settings are not removed.
- You cannot preset locked channels. If you set the Parental Lock for a preset channel, the preset information for that channel returns to the default.
- You cannot set the Parental Lock for channel 0 or channel 184.

Message list

SIRIUS Satellite Radio message list

Message appears	Explanation	Remedies
Antenna Error	The antenna is not connected properly.	Check the connection between the SiriusConnect Home tuner and the antenna.
Acquiring Signal	The receiving condition is not good.	Try moving the antenna to another location. For details about the antenna location, see the instructions supplied with the SiriusConnect Home tuner.
Call 888-539-SIRI	You have not subscribed for the selected channel.	—
Check Sirius Tuner	The SiriusConnect Home tuner is not connected properly.	Check all the connections, and then turn the system on again. Also make sure if the AC adaptor supplied with the SiriusConnect Home tuner is connected to a wall socket.
Invalid Channel	You have entered an invalid channel number.	The channel to be tuned-in is void due to the change by the broadcast service, or the receiving condition is not good.
Locked Channel	The selected channel is locked.	—
Subscription Updated	The subscription information has been updated.	—
Updating Channels ■■% Completed (■■ are for integers)	Channel information is being updated.	—
Firmware Updating	The SiriusConnect Home tuner firmware is being updated.	—
-----	There is no text information in the channel.	This is not an error. The text information may not be displayed depending on the system condition, for example, right after the system has received a channel.

XM Radio message list

Message appears	Explanation	Remedies
Check Antenna	The XM antenna is not connected to the XM Mini-Tuner Dock or the XM antenna cable is damaged.	Check that the XM antenna is securely connected to the XM Mini-Tuner Dock and check the antenna cable for damage. Replace the XM antenna if the cable is damaged.

Message appears	Explanation	Remedies
CH Unauthorized	You selected an XM channel that is blocked or cannot be received with your XM subscription package.	Consult the latest channel guide at www.xmradio.com for the current list of channels. For information on receiving this channel, visit www.xmradio.com or contact XM Satellite Radio at 1-800-967-2346.
No Signal	The XM Mini-Tuner is not receiving the XM satellite signal. Something may be blocking the XM antenna's view of the satellites or the antenna is not properly aimed.	Check for antenna obstructions and reposition the XM antenna to get better signal reception. Use the Antenna Aiming option to optimize the antenna position (page 71). See instructions supplied with the XM Mini-Tuner and Home Dock for antenna installation information.
Loading	The XM Mini-Tuner is acquiring audio or program information from the XM satellite signal. This message can also occur in weak XM signal conditions. Note that the receiver may not respond to some buttons while this message is displayed.	This message should disappear in a few seconds in good signal conditions. If you see this message often, reposition the XM antenna for better signal reception. Use the Antenna Aiming option to optimize the antenna position (page 71).
Off Air	You selected an XM channel is not currently broadcasting.	Check back later; in the mean time, select another channel.
(space)----	No artist name or song title is available for this selection.	No action required.
CH Unavailable	The selected channel is not available. The channel may have been reassigned to a different channel number. This message may occur initially with a new radio or a radio that has not received XM's signal for an extended period.	Consult the latest channel guide at www.xmradio.com for the current list of channels. For cases of a new radio or a radio that has not received XM's signal for an extended period, allow the radio to receive the XM satellite signal for at least 5 minutes and then try to select the channel again.
Check XM Tuner	The XM Mini-Tuner is not installed or not fully seated in the XM Mini-Tuner Dock or the XM Mini-Tuner dock is not connected to the receiver.	Confirm the XM Mini-Tuner is fully seated in the dock and check the XM Mini-Tuner dock cable is connected to the receiver.

Playing back with 2-channel sound

You can switch the output sound to 2-channel sound regardless of the recording formats of the software you are using, the playback component connected, or the sound field settings of the receiver.

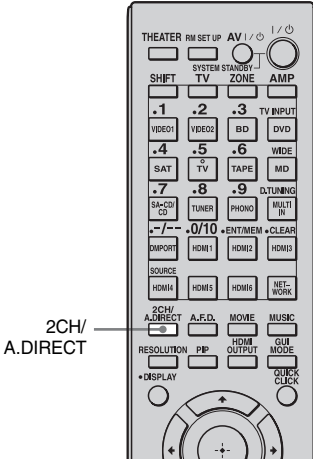

Press 2CH/A.DIRECT repeatedly to select the 2-channel sound mode of the sound output you want.

2CH mode	Effect
2ch Stereo	The receiver outputs the sound from the front left/right speakers only. There is no sound from the subwoofer. Standard 2 channel stereo sources completely bypass the sound field processing and multi-channel surround formats are downmixed to 2 channel.
2ch Analog Direct	You can switch the audio of the selected input to 2 channel analog input. This function enables you to enjoy high quality analog sources. When using this function, only the volume and front speaker balance can be adjusted.

Note

No sound is output from the subwoofer in the 2ch Stereo mode. To listen to 2 channel stereo sources using the front left/right speakers and a subwoofer, select “A.F.D. Auto.”

When you select “A.F.D. Auto,” the receiver will generate a low frequency signal for output to the subwoofer from a 2 channel signal, even if there is no L.F.E. signal.

Playing back with multi-channel surround

The Auto Format Direct (A.F.D.) mode allows you to listen to higher fidelity sound and select the decoding mode for listening to a 2 channel stereo sound as multi-channel sound.

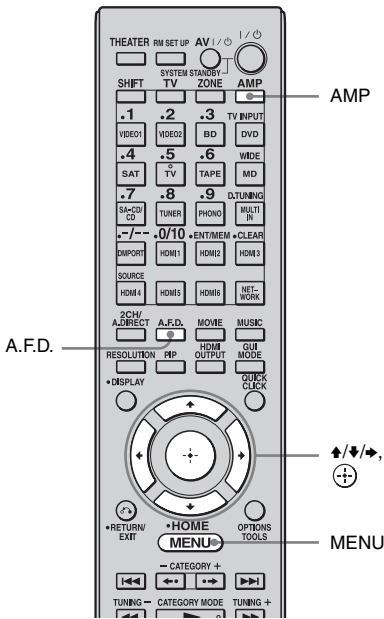

Press A.F.D. repeatedly to select the A.F.D. mode you want.

A.F.D. mode	Multi-channel audio after decoding	Effect
A.F.D. Auto	(Detecting automatically)	Presets the sound as it was recorded/encoded without adding any surround effects.
Multi Stereo	(Multi Stereo)	Outputs 2 channel left/right signals from all speakers.
Enhanced Surround	–	You can select the surround sound effect you want. For details on available surround sound effects and how to set one, see “Setting a multi-channel surround sound effect” (page 80).

Setting a multi-channel surround sound effect

1 Start playing a sound source you want to listen to (CD, DVD, etc.).

2 Press AMP.

The receiver can be operated using the remote.

3 Press MENU.

The menu is displayed on the TV screen.

4 Press \uparrow/\downarrow repeatedly to select “Settings,” then press \oplus or \rightarrow .

The Settings menu list appears on the TV screen.

5 Press \uparrow/\downarrow repeatedly to select “Surround,” then press \oplus or \rightarrow .

6 Press \uparrow/\downarrow repeatedly to select “Enhanced Sur Mode,” then press \oplus .

The menu for surround sound effect appears.

7 Press \uparrow/\downarrow repeatedly to select the A.F.D. mode you want, then press \oplus or \rightarrow .

A.F.D. mode	Multi-channel audio after decoding	Effect
PLII*	5-channel signals	Performs Dolby Pro Logic II mode decoding. A source recorded in 2 channel format is decoded into 5.1 channels. This setting is ideal for movies encoded in Dolby Surround. In addition, this mode can reproduce sound in 5.1 channel system for watching videos of overdubbed or old movies.
PLIIX*	7-channel signals	Performs Dolby Pro Logic IIX mode decoding. A source recorded in 2 channel or 5.1 channel format is decoded into 7.1 channels. This setting is ideal for movies encoded in Dolby Surround. In addition, this mode can reproduce sound in 7.1 channel system for watching videos of overdubbed or old movies.
Neo:6 Cinema	7-channel signals	Performs DTS Neo:6 Cinema mode decoding. A source recorded in 2 channel format is decoded into 7 channels.
Neo:6 Music	7-channel signals	Performs DTS Neo:6 Music mode decoding. A source recorded in 2 channel format is decoded into 7 channels. This setting is ideal for normal stereo sources such as CDs.
Neural-THX	7-channel signals	Next generation of Neural-THX® Surround. In addition to stereo enhancement processing and pure discrete 5.1 surround sound, now capable of full 360° 7.1 surround sound playback from Neural-THX® Surround encoded content.

* You can select “PLII” when there is no surround back speaker on the Speaker Pattern menu, or you can select “PLIIX” when there is a surround back speaker. You cannot select both settings at the same time.

Notes

- This function does not work when the multi-channel input is selected.
- This function does not work when DTS-HD signals with a sampling frequency of higher than 48 kHz are being received.
- This function does not work when Dolby TrueHD signals with a sampling frequency of higher than 96 kHz are being received.
- If you set up the sound field effect while the receiver is receiving signals with a sampling frequency of higher than 48 kHz, the signals will always be played back at either 44.1 kHz or 48 kHz.
- If you set up the sound field during DTS 96/24 signal reception, the signal will be played back only at 48 kHz.
- The beginning of the sound stream may be dropped out when Neural-THX processing is turned on or off.

Tips

- We usually recommend "A.F.D. Auto."
- You can identify the encoding format of DVD software, etc., by looking at the logo on the package.
- Dolby Pro Logic IIx decoding is effective, when 2 channel or 5.1 channel signals are input.
- Neural-THX is effective when 2 channel or 5.1 channel signals are input.

Enjoying a surround effect for music

You can take advantage of surround sound simply by selecting one of the receiver's pre-programmed sound fields. They bring the exciting and powerful sound of concert halls into your home.

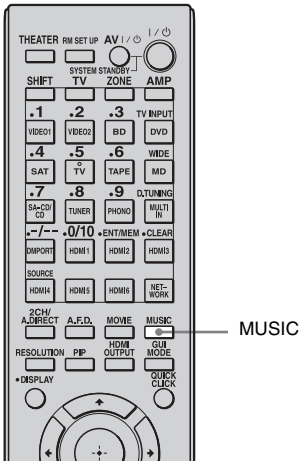

Press MUSIC repeatedly to select the surround effect you want for music.

Sound field	Effect
D.Concert Hall A	Uses 3D sound imaging to reproduce the sound characteristics of a concert hall, which simulates a large sound stage produced by reflectivity.
D.Concert Hall B	Uses 3D sound imaging to reproduce the sound characteristics of a concert hall, which simulates resonant and unique reverberative sound.
Jazz Club	Reproduces the acoustics of a jazz club.
Live Concert	Reproduces the acoustics of a 300-seat live house.
Stadium	Reproduces the feeling of a large open-air stadium.
Sports	Reproduces the feeling of sports broadcasting.
Portable Audio	Reproduces a clear enhanced sound image from your portable audio device. This mode is ideal for MP3 and other compressed music.

To listen to music through headphones connected to the receiver

Sound field	Effect
Headphone (2ch)	This mode is selected automatically if you use headphones when “2ch Stereo” mode or A.F.D. mode is selected. Standard 2 channel stereo sources completely bypass the sound field processing and multi-channel surround formats are downmixed to 2 channels.
Headphone Theater DCS	This mode is selected automatically when you use headphones when sound field is selected for movie/music. It allows you to experience a theater-like environment while listening through a pair of headphones.
Headphone (Direct)	Outputs the analog signals without processing by the tone, sound field, etc.
Headphone (Multi)	This mode is selected automatically if you use headphones when the multi-channel input is selected. Outputs the front analog signals from the MULTI CHANNEL INPUT jacks.

To turn off the surround effect for MUSIC

Press 2CH/A.DIRECT or A.F.D.

Notes

- The sound fields for music do not work when the multi-channel input is selected.
- The sound fields for music do not work when DTS-HD signals with a sampling frequency of higher than 48 kHz are being received.
- The sound fields for music do not work when Dolby TrueHD signals with a sampling frequency of higher than 96 kHz are being received.
- If you set up the sound field during DTS 96/24 signal reception, the signal will be played back only at 48 kHz.
- If you set up the sound field effect while the receiver is receiving signals with a sampling frequency of higher than 48 kHz, the signals will always be played back at either 44.1 kHz or 48 kHz.
- When one of the sound fields for music is selected, no sound is output from the subwoofer if all the speakers are set to “LARGE” in the Speaker settings menu. However, the sound will be output from the subwoofer if the digital input signal contains L.F.E. signals, or if the front or surround speakers are set to “SMALL,” the sound field for movie is selected, or “Portable Audio” is selected.

Enjoying a surround effect for movies

You can take advantage of surround sound simply by selecting one of the receiver's pre-programmed sound fields. They bring the exciting and powerful sound of movie theaters into your home.

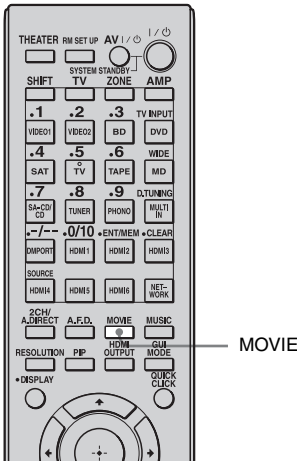

Press MOVIE repeatedly to select the surround effect you want for movies.

Sound field	Effect
Cinema Studio EX A DCS	Reproduces the sound characteristics of the Sony Pictures Entertainment “Cary Grant Theater” cinema production studio. This is a standard mode, great for watching almost any type of movie.
Cinema Studio EX B DCS	Reproduces the sound characteristics of the Sony Pictures Entertainment “Kim Novak Theater” cinema production studio. This mode is ideal for watching science-fiction or action movies with lots of sound effects.
Cinema Studio EX C DCS	Reproduces the sound characteristics of the Sony Pictures Entertainment scoring stage. This mode is ideal for watching musicals or films where orchestra music is featured in the soundtrack.
V.Multi Dimension DCS	Creates many virtual speakers from a single pair of actual surround speakers.

To turn off the surround effect for MOVIE

Press 2CH/A.DIRECT or A.F.D.

Notes

- The sound fields for movies do not work when the multi-channel input is selected.
- The sound fields for movies do not work when DTS-HD signals with a sampling frequency of higher than 48 kHz are being received.
- The sound fields for movies do not work when Dolby TrueHD signals with a sampling frequency of higher than 96 kHz are being received.
- If you set up the sound field during DTS 96/24 signal reception, the signal will be played back only at 48 kHz.
- If you set up the sound field effect while the receiver is receiving signals with a sampling frequency of higher than 48 kHz, the signals will always be played back at either 44.1 kHz or 48 kHz.
- The effects provided by the virtual speakers may cause increased noise in the playback signal.
- When listening with sound fields that employ the virtual speakers, you will not be able to hear any sound coming directly from the surround speakers.









Tips

- Sound fields with **DCS** marks use DCS technology. See “Glossary” (page 161).
- When the sound field’s **DCS** mark is selected, the Digital Cinema Sound lamp lights up on the display.

Digital audio formats supported by the receiver

Digital audio formats that this receiver can decode depend on digital audio input jacks for the components connected.

This receiver supports the following audio formats.

Audio format	Maximum number of channels	Connection of the playback component and the receiver	
		COAXIAL/OPTICAL	HDMI
Dolby Digital 	5.1ch	○	○
Dolby Digital EX 	6.1ch	○	○
Dolby Digital Plus ^{a)} 	7.1ch	×	○
Dolby TrueHD ^{a)} 	7.1ch	×	○
DTS 	5.1ch	○	○
DTS-ES 	6.1ch	○	○
DTS 96/24 	5.1ch	○	○
DTS-HD High Resolution Audio ^{a)} 	7.1ch	×	○
DTS-HD Master Audio ^{a) b)} 	7.1ch	×	○

Audio format	Maximum number of channels	Connection of the playback component and the receiver	
		COAXIAL/OPTICAL	HDMI
DSD ^{a)} DSD Direct Stream Digital	5.1ch	×	○
Multi channel Linear PCM ^{a)}	7.1ch	×	○

a) Audio signals are output in another format if the playback component does not correspond to the format. For details, refer to the operating instructions of the playback component.

b) Signals with a sampling frequency of higher than 96 kHz are played back at 96 kHz or 88.2 kHz.

What you can do with the Multi-zone function

You can enjoy images and sounds from a component connected to the receiver in a zone (zone 2 or zone 3) other than the main zone. For example, you can watch the DVD in the main zone and listen to the CD in zone 2 or zone 3.

When using an IR repeater (not supplied), you can operate both a component in the main zone and Sony receiver in zone 2 or zone 3 from zone 2 or zone 3.

To operate the receiver from zone 2 or zone 3

You can operate the receiver without pointing the remote toward the IR repeater of the receiver if you connect an IR repeater (not supplied) to the IR REMOTE jack.

Use an IR repeater when you install the receiver in a place where signals from the remote cannot reach.

Making a multi-zone connection

1:Zone 2 connections

- ① Outputs sound from speakers in zone 2 using the SURROUND BACK SPEAKERS terminals of the receiver.

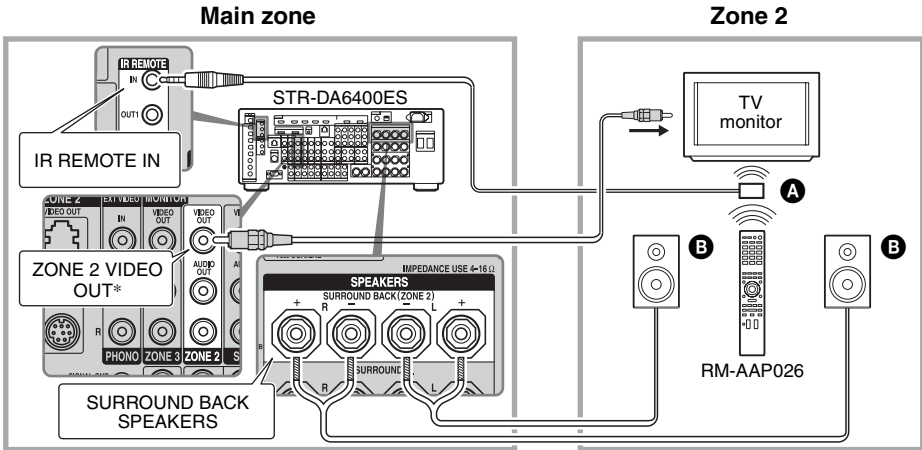

- ② Outputs sound from speakers in zone 2 using the receiver and another amplifier.

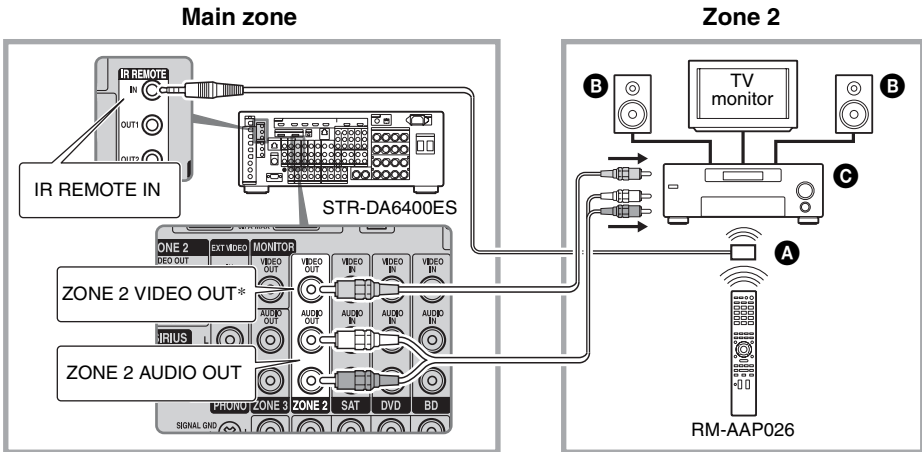

- A** IR repeater (not supplied)
- B** Speakers
- C** Sony Amplifier/Receiver

* You can also connect to the COMPONENT VIDEO ZONE 2 OUT jack.

2:Zone 3 connections

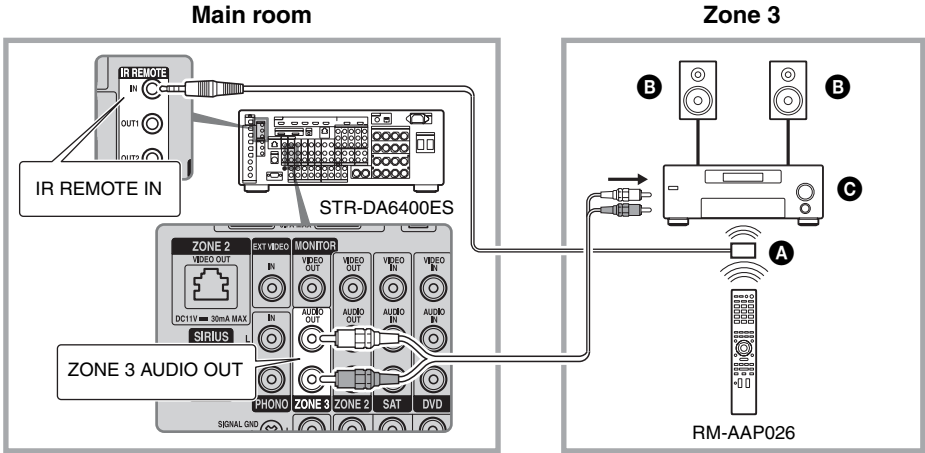

- A** IR repeater (not supplied)
- B** Speakers
- C** Sony Amplifier/Receiver

Making a zone 2 configuration using ZONE 2 VIDEO OUT (RJ45 jack)

ZONE 2 VIDEO OUT (RJ45 jack) is used only for custom installation by a qualified person. ZONE 2 VIDEO OUT (RJ45 jack) is a jack that sends a source video signal to the component video input for zone 2. For details, consult your dealer.

Note

This jack is not for an Ethernet LAN connection.

ZONE 2 VIDEO OUT (RJ45 jack) connection

The RJ45 pinouts use the T568B standard.

Refer to the illustration below.

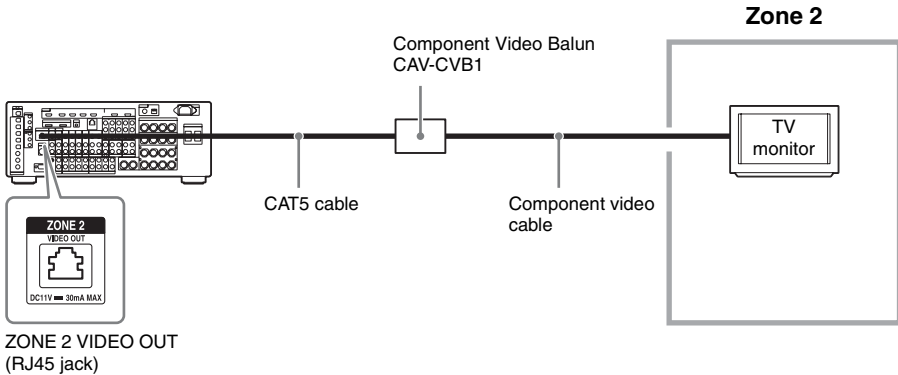

Note

CAV-CVB1 (Component Video Balun) must be used. Other types will cause trouble and may void your warranty.

RJ45 Video Pinout

The RJ45 pinouts use the T568B standard.

Refer to the illustration below.

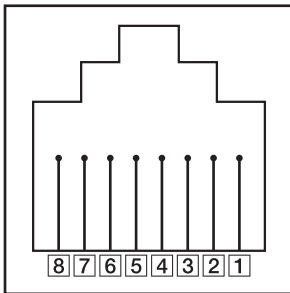

Pinout	Wire color
1 Pin 1	BLUE/Pb (R) White/Orange
2 Pin 2	BLUE/Pb (T) Orange
3 Pin 3	GREEN/Y (R) White/Green
4 Pin 4	GND Blue
5 Pin 5	+11V White/Blue
6 Pin 6	GREEN/Y (T) Green
7 Pin 7	RED/Pr (R) White/Brown
8 Pin 8	RED/Pr (T) Brown

CAT5 cable

Be sure to verify the CAT5 wiring connection is correct.

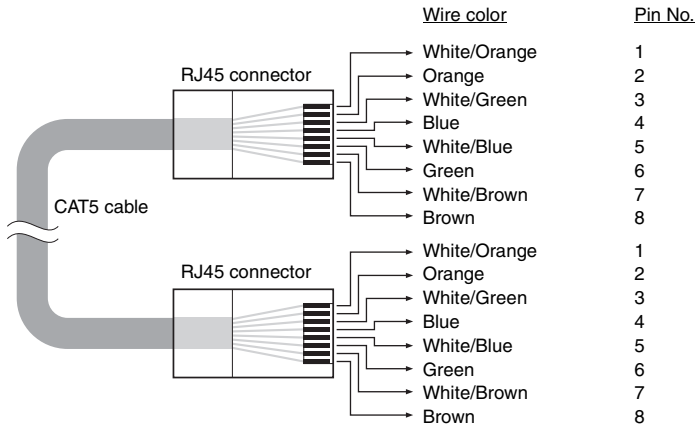

Use Category 5e or Category 6 cable.



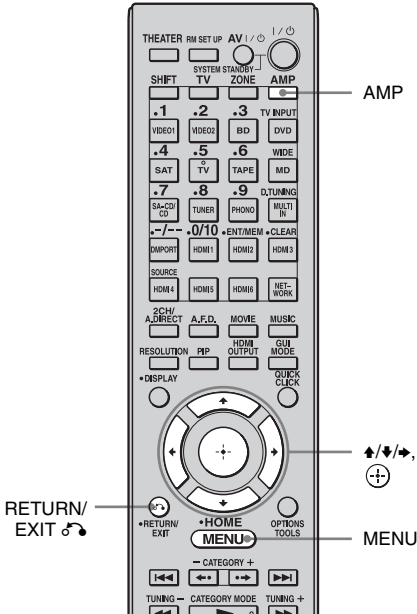

Setting the speakers in zone 2

When the speakers in zone 2 are connected to the SURROUND BACK SPEAKERS terminals of the receiver (page 89), make the setting so that the sound selected in zone 2 is output from the speakers connected to the SURROUND BACK SPEAKERS terminals.



- 5** Press **▲/▼** to select “Speaker Pattern,” to select the pattern that has no surround back speakers.
- 6** Press **RETURN/EXIT** .
- 7** Press **▲/▼** repeatedly to select “Sur Back Assign,” then press .
- 8** Press **▲/▼** to select “ZONE2,” then press .

To exit the menu
Press **MENU**.

- 1** Press **AMP**.
The receiver can be operated using the remote.
- 2** Press **MENU**.
The menu is displayed on the TV screen.
- 3** Press **▲/▼** repeatedly to select “Settings,” then press  or **➡**.
- 4** Press **▲/▼** repeatedly to select “Speaker,” then press  or **➡**.

Switching the zone setting of the remote

The remote commanders are initially set to be used in zone 2. If you want to use them in zone 3, switch the zone setting of the remote.

Main remote

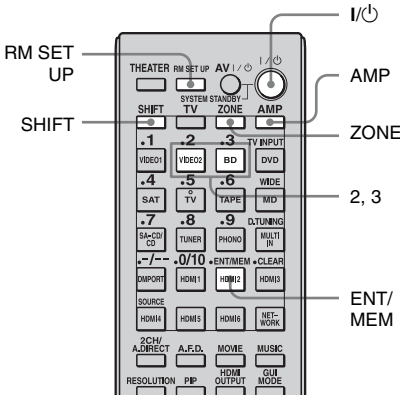

- Press the numeric button 2 for the zone 2, or 3 for the zone 3 while the ZONE button is flashing. The ZONE button lights up.

- Press ENT/MEM. The ZONE button flashes twice and the remote switches to zone 2 or zone 3 mode.

On the zone 2/zone 3 remote commander

- Press I/⏻ while pressing RM SET UP. The RM SET UP button flashes and the SHIFT button lights up.
- Press the numeric button 2 for the zone 2, or 3 for the zone 3 while the RM SET UP button is flashing. The RM SET UP button lights up.
- Press ENTER. The RM SET UP button flashes twice and the remote switches to zone 2 or zone 3 mode.

Zone 2/Zone 3 remote

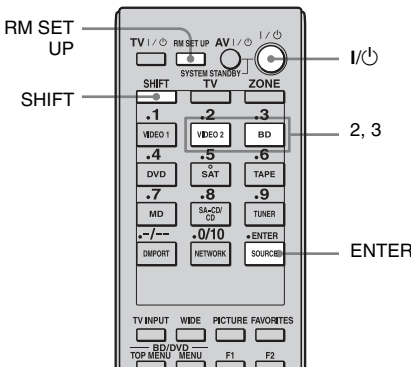

On the main remote commander

- Press I/⏻ while pressing RM SET UP. The AMP and ZONE buttons flash.
- Press ZONE. The AMP button goes off, the ZONE button keeps flashing and the SHIFT button lights up.

Operating the receiver from another zone (ZONE 2/ZONE 3 operations)

The following operations are described for connecting an IR repeater and operating the receiver in zone 2 or zone 3. When an IR repeater is not connected, use this receiver in the main zone.

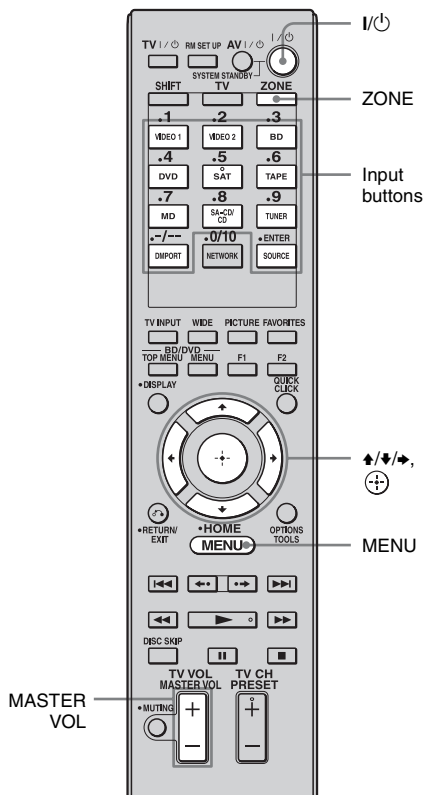

Operating the receiver from zone 2

- 1 Turn on the main receiver (this receiver).
- 2 In the case of illustration 1-② (page 89), turn on the amplifier in zone 2.

3 Press ZONE.

The remote switches to zone 2.

4 Press I/O.

The zone function is activated.

5 Press MENU.

The menu is displayed on the TV screen.

6 Press \uparrow/\downarrow to select "Input," then press \oplus or \rightarrow .

7 Press \uparrow/\downarrow to select the input source you want, then press \oplus .

For zone 2, analog video and audio signals are output. When you select SOURCE, the signals of the current input of the main zone are output to the ZONE 2 OUT jack.

8 Adjust to a suitable volume.

- In the case of illustration 1-① (page 89), adjust the volume using MASTER VOL +/- on the remote.
- In the case of illustration 1-② (page 89), adjust the volume using the receiver in zone 2.

To finish the zone 2 operation

Press I/O after pressing ZONE.

Operating the receiver from zone 3

1 Turn on the main receiver (this receiver) and the amplifier in zone 3.

2 Press ZONE.

The remote switches to zone 3. Change the zone setting of the remote to zone 3 in advance (page 94).

3 Press I/⏻.

The zone function is activated.

4 Press one of the input buttons on the remote to select the source signals you want to output.

For zone 3, only analog audio signals are output. When you select SOURCE, the signals of the current input are output.

5 Adjust to a suitable volume using the receiver in zone 3.

To finish the zone 3 operation

Press I/⏻ after pressing ZONE.

Tips

- Even when this receiver is standby mode (press I/⏻ on the remote to turned off this receiver), the receiver in zone 2 or zone 3 remains turned on. To turn off all receivers, press I/⏻ and AV I/⏻ on the main remote at the same time (SYSTEM STANDBY).
- Only signals from components connected to the analog input jacks are output through the ZONE 2 or ZONE 3 jacks. No signals are output from components connected to only the digital input jacks.
- When SOURCE is selected, the signals input to the MULTI CHANNEL INPUT jacks are not output from the ZONE 2 OUT or ZONE 3 OUT jacks even when the multi-channel input is selected. The analog audio signals of the current function are output.

Listening to the same music in different zone (Party Mode)

You can enjoy listening to the same music in different zone.

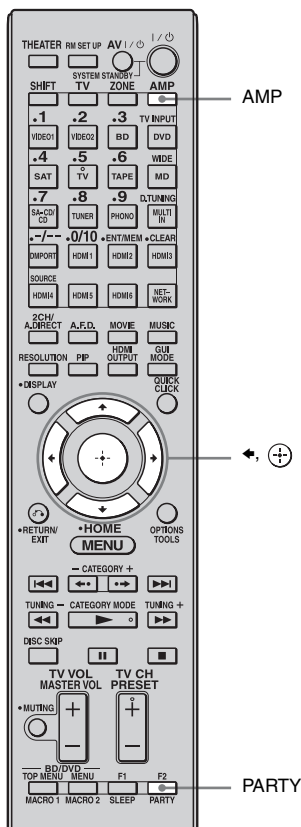

1 Start playback in the main zone.

2 Press AMP.

3 Press PARTY.

The party mode screen appears on the TV screen.

4 Press ← to select “Start,” then press .

The same sound of the input selected in main zone is output in the zone selected in party mode (page 121).

To exit the party mode

Select other input in zone 2 or zone 3.

Refer to “Operating the receiver from another zone (ZONE 2/ZONE 3 operations)” (page 95) for details of the operation of zone2 /zone 3.

Using Other Features

Using “BRAVIA” Sync features

What is “BRAVIA” Sync?

“BRAVIA” Sync is compatible with a Sony TV, Blu-ray Disc/DVD player, AV amplifier, etc., that is equipped with the Control for HDMI function.

By connecting Sony components that are compatible with the “BRAVIA” Sync with a HDMI cable (not supplied), operation is simplified as below:

- **One-Touch Play:** When you play back a component such as a DVD/Blu-ray Disc Player, the receiver and the TV are turned on automatically and switch to the appropriate HDMI input.
- **System Audio Control:** While watching TV, you can select to output the sound from the TV speaker or the speakers connected to the receiver.
- **System Power Off:** When you turn off the TV, the receiver and connected components are also turned off simultaneously.

Control for HDMI is a mutual control function standard used by HDMI CEC (Consumer Electronics Control) for HDMI (High-Definition Multimedia Interface).

The Control for HDMI function does not work in the following cases:

- When you connect the receiver to a component which is not correspond with Sony’s Control for HDMI function.
- When you connect the receiver and components using other than HDMI connection.

We recommend that you connect the receiver to products featuring “BRAVIA” Sync.

Note

Depending on the connected component, the Control for HDMI function may not work. See the operating instructions of the component.

Preparing for the “BRAVIA” Sync

To use the “BRAVIA” Sync, turn the Control for HDMI function on for both the receiver and the connected component. The receiver is compatible with the “Control for HDMI-Easy Setting” function.

When your TV is compatible with the “Control for HDMI-Easy Setting” function

When you connect a Sony TV with the “Control for HDMI-Easy Setting” function, the Control for HDMI function of the receiver can be turned on simultaneously by turning the Control for HDMI function of the TV on.

- 1** Make sure that the receiver, TV, and playback components are connected using an HDMI cable (not supplied). (The respective components must be compatible with the Control for HDMI function.)
- 2** Turn on the receiver, TV and playback components.
- 3** Turn the Control for HDMI function of the TV on.
The Control for HDMI function of the receiver and all the connected components are simultaneously turned on. During setup, “SCANNING” appears in the display window of the receiver, and once setting is completed, “COMPLETE” will appear. Wait until the setup is complete.

For details on setup of the TV, refer to the operating instructions of your TV.

Notes

- When you pull out the HDMI cable or change the connection, perform the steps given in “When your TV is compatible with the “Control for HDMI-Easy Setting” function” (page 98) or “When your TV is not compatible with the “Control for HDMI-Easy Setting” function.”

However, you do not need to perform these steps when you use an HDMI IN 6 jack.

- When you assign the component video input to the HDMI input using the Input Assign function, you cannot set “Control for HDMI” to “ON.”
- While “Control for HDMI-Easy Setting” is being set, you cannot use functions such as One-Touch Play or System Audio Control.
- When you set up the receiver using the “Control for HDMI-Easy Setting” from a TV, turn on the TV, the receiver and the playback components beforehand.
- When you set up the receiver using the “Control for HDMI-Easy Setting” from a TV, before you make the “Control for HDMI-Easy Setting” function effective, make the Control for HDMI function of the components that are not compatible with the “Control for HDMI-Easy Setting” function effective.

When your TV is not compatible with the “Control for HDMI-Easy Setting” function

Turn the Control for HDMI function of the receiver and the connected component on individually.

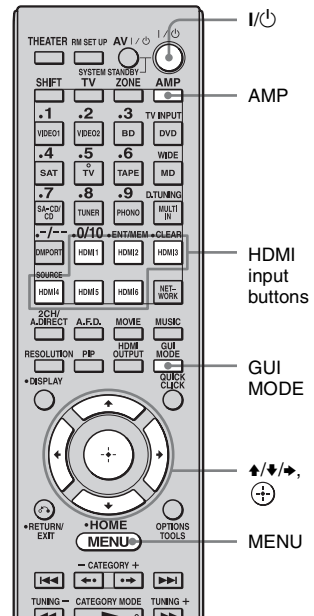

- 1 Perform the steps given in “When your TV is compatible with the “Control for HDMI-Easy Setting” function” (page 98).
- 2 Press AMP.
The receiver can be operated using the remote.
- 3 Press MENU.
The menu is displayed on the TV screen.
- 4 Press \uparrow/\downarrow repeatedly to select “Settings,” then press \oplus or \rightarrow .
- 5 Press \uparrow/\downarrow repeatedly to select “HDMI,” then press \oplus or \rightarrow .
- 6 Press \uparrow/\downarrow repeatedly to select “Control for HDMI,” then press \oplus or \rightarrow .

- 7 Press $\blacktriangle/\blacktriangledown$ repeatedly to select “ON,” then press \oplus .
The Control for HDMI function of the receiver is activated.
- 8 Press GUI MODE to exit the GUI menu. If the GUI menu is displayed, the Control for HDMI function of the playback components will not work properly.
- 9 Press one of the HDMI input buttons to display the image of the playback components for which you want to set the Control for HDMI function.
- 10 Turn the Control for HDMI function of the connected component on.
For details on setting the connected component, refer to its operating instructions.
- 11 Repeat steps 9 and 10 to set the Control for HDMI function and to display the image of all the playback components you want to use.

Playing back components with one-touch operation (One-Touch Play)

By a simple operation (one-touch), components connected to the receiver with HDMI connections start automatically. You can enjoy the sound/image using connected components.

Play back a connected component.

The receiver and TV are turned on simultaneously, and sound and image are output from the receiver and TV.

To use the One Touch Play of the camcorder

- 1 Turn the Control for HDMI function on for both the receiver and your camcorder.
- 2 Connect your camcorder to the HDMI IN 6 jack (page 34).

The receiver and TV are turned on simultaneously, and sound and image are output from the receiver and TV.

Note

- Connect your camcorder to the HDMI IN 6 jack.
The camcorder may not work correctly if you connect it to the HDMI IN jack on the rear panel.
- Depending on the TV, the start of the content may not be output.

Enjoying the TV sound from the speakers connected to the receiver (System Audio Control)

You can enjoy the TV sound from the speakers connected to the receiver by a simple operation.

Depending on the TV settings, while you are watching the TV, the receiver turns on and switches to the “TV” function automatically. TV sound is output from the speakers connected to the receiver, and the volume of the TV is minimized simultaneously.

You can use the System Audio Control function as follows.

- The sound of the TV is output from the speakers connected to the receiver when you turn the receiver on while the sound is being output from the TV speaker.
- You can adjust the receiver’s volume when you adjust the TV volume.

You can also operate this function using the TV menu. For details, see the operating instructions of the TV.

Notes

- When “Control for HDMI” is set to “ON,” the “Audio Out” settings in the HDMI settings menu will set automatically depending on the System Audio Control settings.
- When you connect a TV that does not have System Audio Control function, the System Audio Control function does not work.
- If the TV is turned on before turning on the receiver, the TV sound will not be output for a moment.

Turning off the receiver with the TV (System Power Off)

When you turn the TV off by using the power button on the TV's remote, the receiver and the connected components turn off automatically.

You can also use the receiver's remote to turn off the TV.

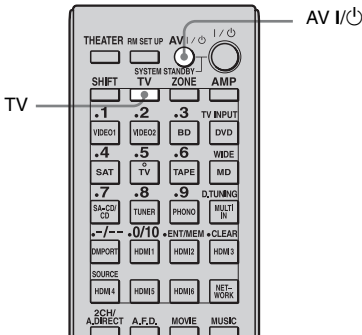

Press TV, then press AV I/O.

The TV, receiver and connected components are turned off.

Notes

- Set the TV power supply interlock function to on before using the System Power Off function. For details, see the operating instructions of the TV.
- Depending on the status, the connected components may not be turned off. For details, see the operating instructions of the connected components.

Switching the monitors that output the HDMI video signals

When you have two monitors connected to the HDMI OUT A and HDMI OUT B jacks, you can switch the output for these two monitors using the HDMI OUTPUT button.

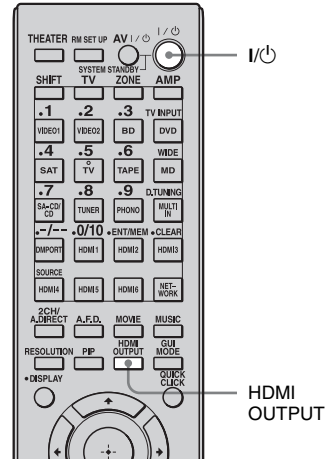

1 Turn on the receiver and the two monitors.

2 Press HDMI OUTPUT.

Each time you press the button, the output will be switched as follows:

HDMI A → HDMI B → HDMI A...

You can also use the HDMI OUT button on the receiver.

Switching between digital and analog audio

When you connect components to both digital and analog audio input jacks on the receiver, you can fix the audio input mode to either of them, or switch from one to the other, depending on the type of material you intend to watch.

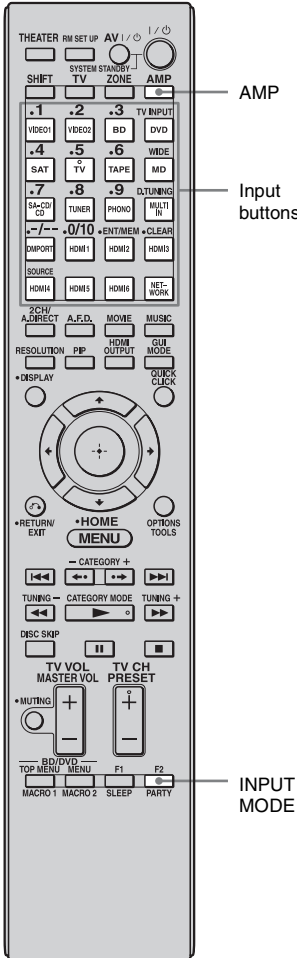

- 1 Press the input button.**
You can also use INPUT SELECTOR on the receiver.
- 2 Press AMP.**
- 3 Press INPUT MODE repeatedly to select the audio input mode.**

The selected audio input mode appears on the TV screen.

- Auto
Gives priority to digital audio signals when there are both digital and analog connections.
If there are no digital audio signals, analog audio signals are selected.
- Analog
Specifies the analog audio signals input to the AUDIO IN (L/R) jacks.

Notes

- Some audio input modes may not be set up depending on the input.
- When either HDMI input, satellite tuner or DIGITAL MEDIA PORT adapter is selected, “-----” appears on the display, and you cannot select other modes. Select an input mode other than the HDMI input, satellite tuner and DIGITAL MEDIA PORT adapter then set the audio input mode.
- When “2ch Analog Direct” is being used, or the multi-channel input is selected, audio input is set to “Analog.” You cannot select other modes.

Enjoying the sound/ images from other inputs (Input Assign)

You can reassign video and/or audio signals to another input.

Example) Connect the OPTICAL OUT jack of the DVD player to the OPTICAL VIDEO 1 IN jack of this receiver when you want to input the only digital optical audio signals from the DVD player.

Connect the component video jack of the DVD player to the COMPONENT VIDEO IN 1/ COMPONENT VIDEO IN 2, or COMPONENT VIDEO IN 3 jack of this receiver when you want to input the video signals from the DVD player. Assign video and/or audio signals to the DVD input jack using “Input Assign” in the Input menu.

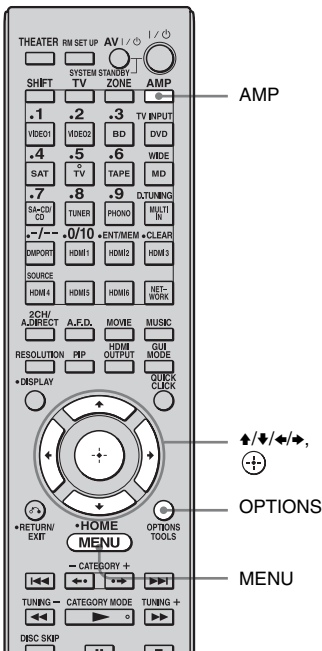

- 1 Press AMP.**
The receiver can be operated using the remote.
- 2 Press MENU.**
The menu is displayed on the TV screen.
- 3 Press \uparrow/\downarrow repeatedly to select “Input,” then press \oplus or \rightarrow .**
- 4 Press \uparrow/\downarrow to select the input name you want to assign.**
- 5 Press OPTIONS.**
The option menu appears.
- 6 Press \uparrow/\downarrow to select “Input Assign,” then press \oplus .**
- 7 Press $\uparrow/\downarrow/\leftarrow/\rightarrow$ to select the audio and/or video signals you want to assign to the input selected in step 4, then press \oplus .**

Input name		VIDEO1	VIDEO2	BD	DVD	SAT	TAPE	MD	SA-CD/ CD	MULTI IN	HDMI1	HDMI2	HDMI3	HDMI4	HDMI5	HDMI6	
Assignable video input jacks	Video1 Composite	○ ^{a)}	-	-	-	-	-	-	-	-	-	-	-	-	-	-	
	Video2 Composite	-	○ ^{a)}	-	-	-	-	-	-	-	-	-	-	-	-	-	
	BD Composite	-	-	○	-	-	-	-	-	-	-	-	-	-	-	-	
	DVD Composite	-	-	-	○	-	-	-	-	-	-	-	-	-	-	-	
	SAT Composite	-	-	-	-	○	-	-	-	-	-	-	-	-	-	-	
	Component1	○	○	○ ^{a)}	○	○	○	○	○	○	○ ^{b)}	○ ^{b)}	○ ^{b)}	○ ^{b)}	○ ^{b)}	○ ^{b)}	○ ^{b)}
	Component2	○	○	○	○ ^{a)}	○	○	○	○	○	○ ^{b)}	○ ^{b)}	○ ^{b)}	○ ^{b)}	○ ^{b)}	○ ^{b)}	○ ^{b)}
	Component3	○	○	○	○	○ ^{a)}	○	○	○	○	○ ^{b)}	○ ^{b)}	○ ^{b)}	○ ^{b)}	○ ^{b)}	○ ^{b)}	○ ^{b)}
	HDMI1	○	○	○	○	○	○	○	○	○	○ ^{a)}	-	-	-	-	-	
	HDMI2	○	○	○	○	○	○	○	○	○	-	○ ^{a)}	-	-	-	-	
	HDMI3	○	○	○	○	○	○	○	○	○	-	-	○ ^{a)}	-	-	-	
	HDMI4	○	○	○	○	○	○	○	○	○	-	-	-	○ ^{a)}	-	-	
HDMI5	○	○	○	○	○	○	○	○	○	-	-	-	-	○ ^{a)}	-		
HDMI6	○	○	○	○	○	○	○	○	○	-	-	-	-	-	○ ^{a)}		
Assignable audio input jacks	Video1 OPT	○ ^{a)}	-	○	○	-	-	-	○	-	-	-	-	-	-	-	
	Video2 OPT	-	○ ^{a)}	○	○	-	-	-	○	-	-	-	-	-	-	-	
	SAT OPT	-	-	○	○	○ ^{a)}	-	-	○	-	-	-	-	-	-	-	
	Tape OPT	-	-	○	○	-	○ ^{a)}	-	○	-	-	-	-	-	-	-	
	MD OPT	-	-	○	○	-	-	○ ^{a)}	○	-	-	-	-	-	-	-	
	BD COAX	○	○	○ ^{a)}	-	○	○	○	-	-	-	-	-	-	-	-	
	DVD COAX	○	○	-	○ ^{a)}	○	○	○	-	-	-	-	-	-	-	-	
SA-CD/CD COAX	○	○	-	-	○	○	○	○ ^{a)}	-	-	-	-	-	-	-		

^{a)}Initial setting

^{b)}When you assign a component video input to the HDMI input via the Input Assign menu, component video signals are not converted to HDMI video signals and are not output from the HDMI OUT jack. Component video signals are output from the COMPONENT VIDEO MONITOR OUT jack. In this case, the resolution of the GUI output is set to “480p” for both component video input and HDMI video input.

Notes

- You cannot assign optical signals from an input source to the optical input jacks on the receiver, and you cannot assign coaxial signals from the input source to the coaxial input jacks on the receiver.
- When you assign the digital audio input, the INPUT MODE setting may change automatically.
- You cannot reassign more than one HDMI input to the same input.

- You cannot reassign more than one digital audio input to the same input.
- You cannot reassign more than one component video input to the same input.
- When you assign a component video input to the HDMI input, set “Control for HDMI” to “OFF.”

Using the sleep timer

You can set the receiver to turn off automatically at a specified time.

0:30:00 → 1:00:00 → 1:30:00 → 2:00:00 → OFF

When sleep timer is being used, “SLEEP” lights up in the display window of the receiver.

Tip

To check the remaining time before the receiver turns off, press SLEEP. The remaining time appears on the display. If you press SLEEP again, the sleep timer will be changed.



- 1 Press AMP.**
- 2 Press SLEEP repeatedly.**

Each time you press SLEEP, the display changes cyclically as follows:

Enjoying the surround effect at low volume levels

This function allows you to retain a theater like environment at low volume levels. This function can be used with other sound fields. When watching a movie late at night, you will be able to hear the dialog clearly even at a low volume level.

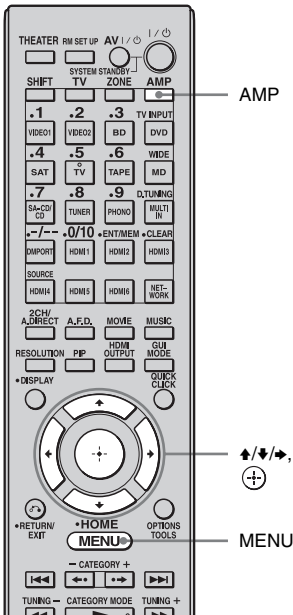

- 1 Press AMP.**
The receiver can be operated using the remote.
- 2 Press MENU.**
The menu is displayed on the TV screen.
- 3 Press \uparrow/\downarrow repeatedly to select “Settings,” then press \rightarrow .**

- 4 Press \uparrow/\downarrow repeatedly to select “Audio,” then press \oplus or \rightarrow .**
- 5 Press \uparrow/\downarrow repeatedly to select “Night Mode,” then press \oplus .**
- 6 Press \uparrow/\downarrow repeatedly to select “On,” then press \oplus .**

Notes

- This function does not work when the multi-channel input is selected.
- This function does not work when Dolby TrueHD signals with a sampling frequency of higher than 96 kHz are being received.
- If the Night Mode function is turned on while the receiver is receiving signals with a sampling frequency of higher than 96 kHz, the signals will always be played back at either 44.1 kHz or 48 kHz.

Tip

While this function is on, the Bass, Treble, and Effect Levels increase, and “D. Range Comp” is automatically set to “MAX.”

Recording using the receiver

You can record from a video/audio component using the receiver. Refer to the operating instructions supplied with your recording component.

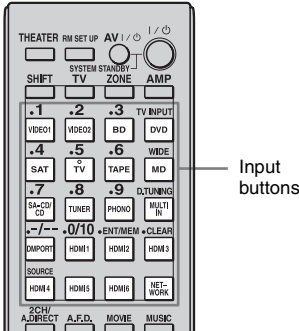

Recording onto a MiniDisc or audio tape

You can record onto a MiniDisc or audio tape using the receiver. See the operating instructions supplied with your MD deck or tape deck.

- 1 Press the input button of the playback component.**
- 2 Prepare the playback component for playing.**

For example, insert a CD into the CD player.
- 3 Prepare the recording component.**

Insert a blank MD or tape into the recording deck and adjust the recording level.

- 4 Start recording on the recording deck, then start playback on the playback component.**

Notes

- Sound adjustments do not affect the signal output from the MD OUT jacks.
- The audio input signals from the MULTI CHANNEL INPUT jacks are not output.

To record digital sound

Connect a component for playback to the digital audio input (OPTICAL IN) jack, and connect the recording component to the OPTICAL MD OUT jack.

Recording onto recording media

- 1 Press the input button of the playback component.**
- 2 Prepare the component for playing.**

For example, insert the video tape you want to copy into the VCR.
- 3 Prepare the recording component.**

Insert a blank video tape, etc., into the recording component (VIDEO 1) for recording.
- 4 Start recording on the recording component, then start playback on the playback component.**

Notes

- Some sources contain copy guards to prevent recording. In this case, you may not be able to record from the sources.
- The audio input signals from the MULTI CHANNEL INPUT jacks are not output.
- Only analog input signals are output from the analog output jack (for recording).

- Only digital input signals are output from the digital output jack (for recording).
- HDMI sound cannot be recorded.

Switching the command mode of the receiver and the remote

You can switch the command mode (COMMAND MODE AV 1 or COMMAND MODE AV 2) of the receiver and the remote. Switch the command mode from the initial setting to the appropriate setting, if other Sony component is operated accidentally by the same remote, when you are operating the receiver using the remote supplied with the receiver.

The command modes of both the receiver and the remote are those of the initial setting (COMMAND MODE AV 2).

The receiver and the remote, on the contrary, should use the same command mode. If the command modes of the receiver and the remote are different, you cannot use the remote to operate the receiver.

Switching the command mode of the receiver

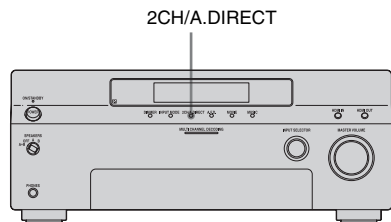

Turn on the receiver while pressing 2CH/A.DIRECT.

When the command mode is set to “AV2,” “COMMAND MODE [AV2]” appears on the display.

When the command mode is set to “AV1,” “COMMAND MODE [AV1]” appears on the display.

Switching the command mode of the main remote commander

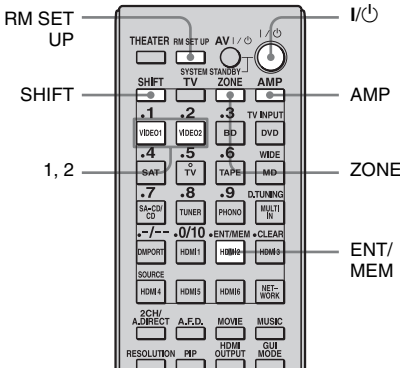

1 Press I/⏻ while pressing RM SET UP.

The AMP and ZONE buttons flash.

2 Press AMP.

The ZONE button goes off, the AMP button keeps flashing and the SHIFT button lights up.

3 Press the numeric button 1 or 2 while the AMP button is flashing.

When you press 1, the command mode is set to AV SYSTEM 1. When you press 2, the command mode is set to AV SYSTEM 2.

The AMP button lights up.

4 Press ENT/MEM.

The AMP button flashes twice, then the command mode setting process is completed.

Using a bi-amplifier connection

If you are not using surround back speakers, you can use the SURROUND BACK SPEAKERS terminals for the front speakers for use with a bi-amplifier connection.

To connect speakers

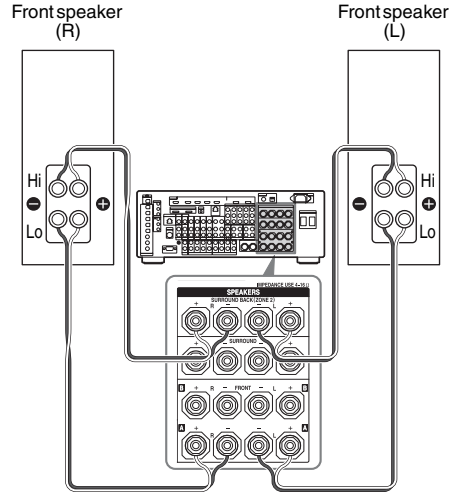

Connect the jacks on the Lo (or Hi) side of the front speakers to the FRONT SPEAKERS A terminals, and connect the jacks on the Hi (or Lo) side of the front speakers to the SURROUND BACK SPEAKERS terminals. Make sure that metal fittings of Hi/Lo attached to the speakers have been removed from the speakers. Not doing so may cause a malfunction of the receiver.



To set up speakers

1 Press AMP.

The receiver can be operated using the remote.

2 Press MENU.

The menu is displayed on the TV screen.

- 3 Press \uparrow/\downarrow to select “ Settings,” then press \oplus or \rightarrow .
- 4 Press \uparrow/\downarrow to select “Speaker,” then press \oplus or \rightarrow .
- 5 Press \uparrow/\downarrow to select “Speaker Pattern,” then press \oplus .
- 6 Press \uparrow/\downarrow to select the appropriate speaker pattern so that there are no surround back speakers.
- 7 Press RETURN/EXIT .
- 8 Press \uparrow/\downarrow to select “Sur Back Assign,” then press \oplus .
- 9 Press \uparrow/\downarrow to select “BI-AMP,” then press \oplus .
The same signals output from the FRONT SPEAKERS A terminals can be output from the SURROUND BACK SPEAKERS terminals.

Notes

- You cannot use the FRONT SPEAKERS B terminals for a bi-amplifier connection.
- When you use the auto calibration function, make the bi-amplifier settings before you perform auto calibration.
- If you make the bi-amplifier settings, the speaker level, balance, and equalizer settings of the surround back speakers become invalid, and those of the front speakers are used.
- Signals output from the PRE OUT jacks are used with the same settings as those of the SPEAKERS terminals.
- If the Speaker Pattern is set to the setting that there are surround back speakers, you cannot make the bi-amplifier settings.

Adjusting Settings

Using the setting menu

You can adjust the various settings for speakers, surround effects, multi zone, etc. using the setting menu.

To display the menu of the receiver on the TV screen, make sure that the receiver is in “GUI MODE” by following the steps in “7: Displaying the GUI menu on the TV screen” (page 45).

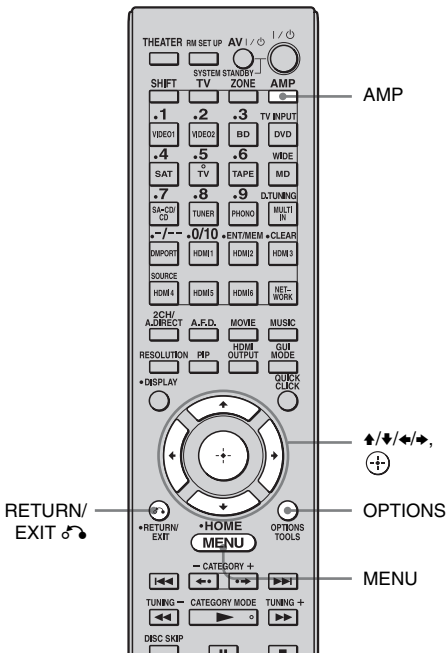

1 Press AMP.

The receiver can be operated using the remote.

2 Press MENU.

The menu is displayed on the TV screen.



3 Press \uparrow/\downarrow repeatedly to select “Settings,” then press \oplus to enter the menu mode.

The setting menu list appears on the TV screen.

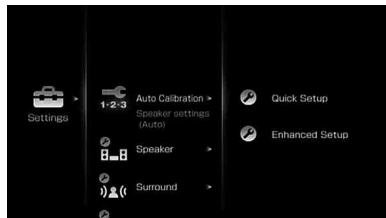

4 Press \uparrow/\downarrow repeatedly to select the menu item you want, then press \oplus to enter.

Example: When you select “Auto Calibration”

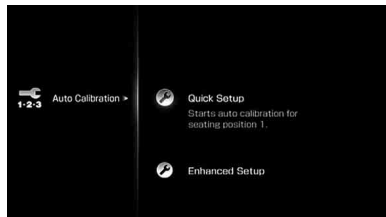

5 Press \uparrow/\downarrow repeatedly to select the parameter you want, then press \oplus to enter.











To return to the previous screen

Press RETURN/EXIT .

To exit the menu

Press MENU.

Setting menu list

Menu icon	Description
 Auto Calibration	Sets the speaker level or distance and makes the measurement automatically (page 112).
 Speaker	Sets the speaker position and impedance manually (page 114).
 Surround	Adjusts the sound field (surround effect) you choose (page 118).
 EQ	Adjusts the equalizer (bass/treble sound) (page 119).
 Multi Zone	Makes the settings for Multi Zone (page 120).
 Audio	Sets various sound items (page 121).
 Video	Adjusts the resolution of analog video signals (page 123).
 HDMI	Makes settings for sound/images from components connected to the HDMI jacks (page 126).
 Network	Makes the settings for the network (page 127).
 Quick Click	Controls components connected to the receiver using the on-screen remote (page 128).
 System	Sets the screen saver or language of the menu guide display (page 128).

Auto Calibration

Quick Setup

Performs Auto Calibration. For details, see “9: Calibrating the appropriate speaker settings automatically (Auto Calibration)” (page 48).

Note

The measurement results will be overwritten and saved on Position 1 in the Enhanced Setup menu.

Enhanced Setup

You can register three patterns for “Seating Position” depending on the seating positions, listening environment, and measurement conditions.

You can also select a calibration type to compensate the each speaker.

To register more than one set of settings for the listening environment

You can select the seating position you want and register the measurement results of the auto calibration for that seating position.

1 Press  repeatedly on the Enhanced Setup screen to select the “Seating Position” for which you want to register the measurement results.

- Pos. (Position) 1
- Pos. (Position) 2
- Pos. (Position) 3

2 Press  to perform auto calibration.

To set a compensation type for the speakers

You can select the compensation type to be used for the speakers for each Seating Position.

- 1 Press $\blacktriangle/\blacktriangledown$ repeatedly to select the “Seating Position” for which you want to set the speaker compensation type, then press (+) .
- 2 Press $\blacktriangle/\blacktriangledown$ repeatedly to select “Calibration Type” you want, then press (+) .
 - Full Flat
Makes the measurement of frequency from each speaker flat.
 - Engineer
Sets the frequency to match that of the Sony listening room standard.
 - Front Reference
Adjusts the characteristics of all the speakers to match the characteristics of the front speakers.
 - OFF
Sets the auto calibration EQ to off.

Note

You cannot set “Calibration Type” for “Seating Position” for which the measurement results have not been registered.

To confirm the equalizer setting for the Seating Position

- 1 Press $\blacktriangle/\blacktriangledown$ repeatedly to select the “Seating Position” for which you want to confirm the equalizer setting.
- 2 Press OPTIONS.
The option menu appears.
- 3 Press $\blacktriangle/\blacktriangledown$ repeatedly to select “EQ Curve,” then press (+) .
- 4 Press $\blacktriangleleft/\blacktriangleright$ repeatedly to select the speaker on the screen for which you want to confirm the equalizer setting.
 - FRONT
 - CENTER
 - SURROUND
 - SURROUND BACK

To name the Seating Position

- 1 Press $\blacktriangle/\blacktriangledown$ repeatedly to select the “Seating Position” for which you want to name.
- 2 Press OPTIONS.
The option menu appears.
- 3 Press $\blacktriangle/\blacktriangledown$ repeatedly to select “Name Input,” then press (+) .
The soft keyboard appears on the screen.
- 4 Press $\blacktriangle/\blacktriangledown/\blacktriangleleft/\blacktriangleright$ and (+) to select a character one by one.
- 5 Press $\blacktriangle/\blacktriangledown/\blacktriangleleft/\blacktriangleright$ to select “Finish,” then press (+) .

Speaker settings

You can adjust each speaker manually. You can also adjust the speaker levels after the auto calibration is completed.

Note

The Speaker settings are only for the current “Seating Position.”

Impedance

You can set the speaker impedance. For details, see “8: Setting the speakers” (page 46).







■ 4 Ω

■ 8 Ω

Speaker Pattern

Select “Speaker Pattern” according to the speaker system which you are using. You do not need to select the speaker pattern after auto calibration.

To select the speaker pattern

- 1 Press / repeatedly to select “Speaker Pattern,” then press .
- 2 Press / to select the speaker pattern you want, then press .
- 3 Press RETURN/EXIT .

Center Mix

You can set the analog downmix settings on or off.

■ OFF

If there is a center speaker connected, this setting is set to “OFF” automatically.

■ ON

We recommend you set “Center Mix” to “ON” to enjoy digital audio with high quality sound when you do not have a center speaker connected. Analog downmix works when you set “Center Mix” to “ON.” This setting is also effective to input signals from the MULTI CHANNEL INPUT jacks.

Sur Back Assign

You can make settings for the surround back speaker(s).

■ OFF

If you have not connected surround back speakers, select “OFF.”

■ BI-AMP

If you connect front speakers in a bi-amplifier configuration, select “BI-AMP” (page 109).

■ ZONE2

If you are using the surround back speakers in zone 2, select “ZONE2.” When you select “ZONE2,” the input to the SUR BACK jacks of the MULTI CHANNEL INPUT is invalid (page 93).

Note

Set “Sur Back Assign” to “OFF,” then connect the surround back speakers to this receiver when you want to change the connection from a bi-amplifier connection or a zone 2 connection to a surround back speakers connection. Re-set up the speakers after you connect the surround back speakers. Refer to “Auto Calibration” (page 48) or “Manual Setup” (page 115).

Manual Setup

You can adjust each speaker manually on the Manual Setup screen. You can also adjust the speaker levels after the auto calibration is completed.

To adjust the speaker level

You can adjust each speaker's level (center, surround left/right, surround back left/right, subwoofer).

- 1 Press **▲/▼/◀/▶** repeatedly to select the speaker on the screen for which you want to adjust the level, then press **⊕**.
- 2 Press **◀/▶** repeatedly to select "Level:," then press **⊕**.
- 3 Press **▲/▼** to set the level of the selected speaker, then press **⊕**.
You can adjust the level from -20 dB to +10 dB in 0.5 dB steps.
For the front left/right speakers, you can adjust the balance on either side. You can adjust the front left level from FL-10.0 dB to FL+10.0 dB in 0.5 dB steps. You can also adjust the front right level from FR-10.0 dB to FR+10.0 dB in 0.5 dB steps.

Note

When one of the sound fields for music is selected, no sound is output from the subwoofer if all the speakers are set to "LARGE." However, the sound will be output from the subwoofer if the digital input signal contains L.F.E. signals, or if the front or surround speakers are set to "SMALL," the sound field for movie is selected, or "Portable Audio" is selected.

To adjust the distance from the seating position to each speaker

You can adjust the distance from the seating position to each speaker (front left/right, center, surround left/right, surround back left/right, subwoofer.)

- 1 Press **▲/▼/◀/▶** repeatedly to select the speaker on the screen for which you want to adjust the distance from the seating position, then press **⊕**.
- 2 Press **◀/▶** repeatedly to select a "Distance:," then press **⊕**.
- 3 Press **▲/▼** to set the distance of the selected speaker, then press **⊕**.
You can adjust the distance from 3 feet 3 inches to 32 feet 9 inches (1.0 meter to 10.0 meters) in 1 inch (1 cm) steps.

To adjust the size of each speaker

You can adjust each speaker's (front left/right, center, surround left/right, surround back left/right) size.

- 1 Press **▲/▼/◀/▶** repeatedly to select the speaker on the screen for which you want to adjust the size, then press **⊕**.
- 2 Press **◀/▶** repeatedly to select a "Size:," then press **⊕**.
- 3 Press **▲/▼** to set the size of the selected speaker, then press **⊕**.
 - **LARGE**
If you connect large speakers that will effectively reproduce bass frequencies, select "LARGE." Normally, select "LARGE."
 - **SMALL**
If the sound is distorted, or you feel a lack of surround effects when using multi-channel surround sound, select "SMALL" to activate the bass redirection circuitry and output the bass frequencies of each channel from the subwoofer or other "LARGE" speakers.

continued

Tips

- The “LARGE” and “SMALL” settings for each speaker determine whether the internal sound processor will cut the bass signal from that channel.

When the bass is cut from a channel, the bass redirection circuitry sends the corresponding bass frequencies to the subwoofer or other “LARGE” speakers.

However, since bass sound has a certain amount of directionality, it is best not to cut it, if possible.

Therefore, even when using small speakers, you can set them to “LARGE” if you want to output the bass frequencies from that speaker. On the other hand, if you are using a large speaker, but prefer not to have bass frequencies output from that speaker, set it to “SMALL.”

If the overall sound level is lower than you prefer, set all speakers to “LARGE.” If there is not enough bass, you can use the equalizer to boost the bass levels.

- The surround back speakers will be set to the same setting as that of the surround speakers.
- When the front speakers are set to “SMALL,” the center, surround, and surround back speakers are also automatically set to “SMALL.”
- If you do not use the subwoofer, the front speakers are automatically set to “LARGE.”

Crossover Freq (Speaker crossover frequency)

Lets you set the bass crossover frequency of speakers that has been set to “SMALL” in the Speaker menu. Measured speaker crossover frequency is set for each speaker after the auto calibration.

- 1 Press \leftarrow/\rightarrow to select the speaker on the screen you want to adjust.**
- 2 Press \uparrow/\downarrow to adjust the value, then press \rightarrow .**

Test Tone

You can select the test tone type on the Test Tone screen.

Tips

- To adjust the level of all speakers at the same time, press MASTER VOL +/-.
- The adjusted value is shown on the display during adjustment.

To output a test tone from each speaker

You can output a test tone from the speakers in sequence.

- 1 Press \leftarrow/\rightarrow to select “Test Tone,” then press \oplus .**
The Test Tone screen appears.
- 2 Press \uparrow/\downarrow to adjust the parameter, then press \oplus .**
 - OFF
 - AUTO
The test tone is output from each speaker in sequence.
 - L, C, R, SR, SBR, SBL, SL, SW
You can select which speakers will output the test tone.
- 3 Press \uparrow/\downarrow to adjust “Level:,” then press \oplus .**

To output a test tone from adjacent speakers

You can output a test tone from adjacent speakers so that you can adjust the balance between the speakers.

- 1 Press \leftarrow/\rightarrow to select “Phase Noise,” then press \oplus .**
The Phase Noise screen appears.
- 2 Press \uparrow/\downarrow to adjust the parameter, then press \oplus .**
 - OFF
 - L/R, L/C, C/R, R/SL, R/SR, SR/SL, SR/SBR, SBR/SBL, SR/SB, SBL/SL, SB/SL, SL/L, L/SR
Lets you output the test tone sequentially

from adjacent speakers.
Some items may not be displayed,
depending on the setting of the speaker
pattern.

- 3 Press \uparrow/\downarrow to adjust “Level:,” then press \oplus .

To output the source sound from adjacent speakers

You can output the source sound from adjacent speakers so that you can adjust the balance between the speakers.

- 1 Press \leftarrow/\rightarrow to select “Phase Audio,” then press \oplus .
The Phase Audio screen appears.

- 2 Press \uparrow/\downarrow to adjust the parameter, then press \oplus .

- OFF
- L/R, L/C, C/R, R/SL, R/SR, SR/SL, SR/SBR, SBR/SBL, SR/SB, SBL/SL, SB/SL, SL/L, L/SR

Lets you output front 2 channel source sound (instead of the test tone) sequentially from adjacent speakers.
Some items may not be displayed, depending on the setting of the speaker pattern.

- 3 Press \uparrow/\downarrow to adjust “Level:,” then press \oplus .

When a test tone is not output from the speakers

- The speaker cords may not be connected securely. Check to see if they are connected securely and cannot be disconnected by pulling on them slightly.
- The speaker cords may have the short-circuit problem.

When a test tone is output from a different speaker than the speaker displayed on the screen

The speaker pattern to the connected speaker is not set up correctly. Make sure the speaker connection and the speaker pattern match.

D. Range Comp (Dynamic range compressor)

Lets you compress the dynamic range of the soundtrack. This may be useful when you want to watch movies at low volumes late at night. Dynamic range compression is possible with Dolby Digital sources only.

■ OFF

The dynamic range is not compressed.

■ AUTO

The dynamic range is compressed automatically.

■ STD

The dynamic range is compressed as intended by the recording engineer.

■ MAX

The dynamic range is compressed dramatically.

Tips

- Dynamic range compressor lets you compress the dynamic range of the soundtrack based on the dynamic range information included in the Dolby Digital signal.
- “STD” is the standard setting, but it only enacts light compression. Therefore, we recommend using the “MAX” setting. This greatly compresses the dynamic range and lets you view movies late at night at low volumes. Unlike analog limiters, the levels are predetermined and provide a very natural compression.

Distance Unit (Distance unit)

Lets you select the unit of measure for setting distances.

■ meter

The distance is displayed in meters.

■ feet

The distance is displayed in feet.

Surround settings

You can adjust the sound effect on the Sound Field Setup screen.

Note



The setup items you can adjust on each menu vary depending on the sound field.

Sound Field Setup



You can select the surround sound field and adjust the effect level on the Sound Field Setup screen.

For details on the sound field, see “Enjoying Surround Sound” (page 78).

To select the surround sound field

- 1 Press \uparrow/\downarrow repeatedly to select “Sound Field Select,” then press .
- 2 Press \uparrow/\downarrow repeatedly to select the surround sound you want, then press .

To adjust the effect level

- 1 Press \uparrow/\downarrow repeatedly to select “Sound Field Select,” then press .
- 2 Press \uparrow/\downarrow repeatedly to select the surround sound you want, then press .
- 3 Press \uparrow/\downarrow to select “Effect Level.”
 - 50%
 - 80%
 - 100%
 - 150%

Note

Effect Level adjustment is valid only when “Cinema Studio EX **DCS**” is selected.

Enhanced Sur Mode

You can select the decoding mode for the sound field.

For details on the decoding modes available, see “Setting a multi-channel surround sound effect” (page 80).

■ PLII

Performs Dolby Pro Logic II decoding. A source recorded in 2 channel format is decoded into 5.1 channels.

■ PLIIx

Performs Dolby Pro Logic IIx decoding. A source recorded in 2 channel or 5.1 channel format is decoded into 7.1 channels.

■ Neo:6 Cinema

Performs DTS Neo:6 Cinema mode decoding. A source recorded in 2 channel format is decoded into 7 channels.

■ Neo:6 Music

Performs DTS Neo:6 Music mode decoding. A source recorded in 2 channel format is decoded into 7 channels. This setting is ideal for normal stereo sources such as CDs.

■ NEURAL-THX

Next generation of Neural-THX[®] Surround. In addition to stereo enhancement processing and pure discrete 5.1 surround sound, now capable of full 360° 7.1 surround sound playback from Neural-THX[®] surround encoded content.

Note

You can select “PLII” when there is no surround back speaker on the Speaker Pattern menu, or you can select “PLIIx” when there is a surround back speaker. You cannot select both settings at the same time.

EQ settings

You can use following parameters to adjust the tonal quality (bass/treble level) of front, center and surround back speakers.

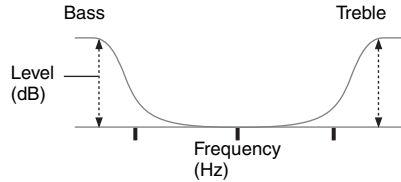

Notes

- This function does not work in the following cases.
 - The multi-channel input is selected.
 - Sound Field is set to “2ch Analog Direct.”
- This function does not work when Dolby TrueHD signals with a sampling frequency of higher than 96 kHz are being received.
- If the equalizer is adjusted while the receiver is receiving signals with a sampling frequency of higher than 96 kHz, the signals will always be played back at either 44.1 kHz or 48 kHz.

To adjust the equalizer on the EQ screen

- 1 Press \leftarrow/\rightarrow to select the speaker on the screen you want to adjust, then press \oplus .
- 2 Press \leftarrow/\rightarrow to select “Bass” or “Treble.”
- 3 Press \uparrow/\downarrow to adjust the gain, then press \oplus .

Multi Zone settings

You can make settings for the main zone, zone 2 or zone 3.

Multi Zone Setup

Turning the power on or off for zone 2/zone 3

You can turn zone 2 or zone 3 operation on or off. "Main" (this receiver) is always selected. You cannot turn it off.

- 1 Press **▲/▼** to select the zone you want to turn on or off, then press **⊕**.
- 2 Press **▲/▼** to select "ON" or "OFF," then press **⊕**.

■ ON

■ OFF

Selecting the output source for each zone

You can select the source that is output to the zone. Audio and video signals are output to zone 2, while only audio signals are output to zone 3.

- 1 Press **▲/▼** to select the zone to which you want to output audio/video signals, then press **⊕**.
- 2 Press **◀/▶** to select "Input," then press **⊕**.
- 3 Press **▲/▼** to select the input, then press **⊕**.

Adjusting the volume for zone 2/zone 3

You can adjust the volume in the main zone. If "Sur Back Assign" is set to "ZONE2" in the Speaker settings menu, you can also adjust the volume of zone 2.

- 1 Press **▲/▼** to select the zone for which you want to adjust the volume, then press **⊕**.
- 2 Press **◀/▶** to select "Volume," then press **⊕**.
- 3 Press **▲/▼** to adjust the volume, then press **⊕**.

Selecting the criteria for output of signals to control each zone

You can turn the receiver on or off in another zone, or select various options for use of the 12V Trigger function.

- 1 Press **▲/▼** to select the zone you want, then press **⊕**.
- 2 Press **◀/▶** to select "12V Trigger," then press **⊕**.
- 3 Press **▲/▼** to select the parameter, then press **⊕**.

■ OFF

Lets you turn off output of 12V triggers even when the main receiver is turned on.

■ CTRL

Lets you turn the output of 12V triggers on or off manually using the CIS command of the IR remote.

■ ZONE

Lets you turn the output of 12V triggers on or off based on whether the selected zone is turned on or off.

■ INPUT (for "Main" only)

Lets you turn on the output of 12V triggers when the preset input is selected. When you select "Input," the setting display which sets each input trigger to on/off appears.

Press **▲/▼** to select the input, then press **⊕** to check the box.

■ MAIN (for “Zone2” and “Zone3” only)

Lets you link operation of trigger in zone 2 or zone 3 to the main receiver.

Tips

- Even when this receiver is standby mode (press **I/⏻** on the remote to turned off this receiver), the receiver in zone 2 or zone 3 remains turned on. To turn off all receivers, press **I/⏻** and **AV I/⏻** on the RM-AAL012 remote at the same time (SYSTEM STANDBY).
- Only signals from components connected to the analog input jacks are output through the ZONE 2 OUT/ZONE 3 OUT jacks. No signals are output from components connected to only the digital input jacks.
- When SOURCE is selected, the signals input to the MULTI CHANNEL INPUT jacks are not output from the ZONE 2 OUT or ZONE 3 OUT jacks even when the multi-channel input is selected. The analog audio signals of the current function are output.
- When “Tuner” is selected; the same type of radio station (FM/AM) selected in the main zone is set in zone 2 and zone 3. However, you can select the input other than “Tuner” in zone 2 and zone 3.
- When the receiver in the main zone is turned off, or an input source other than “Tuner” is selected, you can select a radio station from AM or FM in zone 2. When the receiver in the main zone and zone 2 are turned off, you can select a radio station from AM or FM in zone 3.
When two of the receivers in the main zone, zone 2 or zone 3 are turned off, you can select a broadcast from FM/AM/XM/SIRIUS in one zone in which the receiver is turned on.

Party Setup

Lets you select the zone which plays back the same music as the main zone when you press the PARTY button to start the party mode.

■ ZONE2/3

■ ZONE2

■ ZONE3

🎵 Audio settings

You can make settings for the audio to suit your preference.

Digital Legato Linear (D.L.L.)

When you set this setting to “AUTO,” the receiver plays back the sound recorded using lossy compression with high quality sound. Even the CD sound will be linearized so that the CD sound quality level will be increased.

■ OFF

■ AUTO

A/V Sync (Synchronizes audio and video output)

Lets you delay the output of audio to minimize the time gap between audio output and visual display.

■ HDMI AUTO

The time gap between audio output and visual display for the monitor connected via an HDMI connection will be adjusted automatically based on the information for the TV. This feature is available only when the monitor supports the A/V Sync function.

■ 0 ms – 300 ms

You can adjust the delay from 0 ms to 300 ms in 10 ms steps.

Notes

- This function is useful when you use a large LCD or plasma monitor or a projector.
- This function does not work in the following cases.
 - The multi-channel input is selected.
 - “2ch Analog Direct” is being used.

Dual Mono (Digital broadcast language selection)

Lets you select the language you want to listen to during a digital broadcast. This feature only functions for Dolby Digital sources.

■ MAIN/SUB

Sound of the main language will be output through the front left speaker, and sound of the sub language will be output through the front right speaker simultaneously.

■ MAIN

Sound of the main language will be output.

■ SUB

Sound of the sub language will be output.

Decode Priority (Digital audio input decoding priority)

Lets you specify the input mode for the digital signal input to the DIGITAL IN jacks or HDMI IN jacks.

■ PCM

When signals from the DIGITAL IN jack are selected, PCM signals are given priority (to prevent interruption when playback starts). However, when other signals are input, there may be no sound, depending on the format.

In this case, set this item to "AUTO."

When signals from the HDMI IN jack are selected, only PCM signals are output from the connected player. When signals in any other format are received, set this item to "AUTO."

■ AUTO

Automatically switches the input mode between Dolby Digital, DTS, DSD or PCM.

Note

Even when "Decode Priority" is set to "PCM," the sound may be interrupted at the very beginning of the first track due to signals on the CD being played back.

Night Mode

Lets you to retain a theater-like environment at low volume levels. This function can be used with other sound fields. When watching a movie late at night, you will be able to hear the dialog clearly even at a low volume level.

■ ON

■ OFF

Video settings

Makes settings for video.

Resolution (Converting video signals)

Lets you convert the resolution of analog video input signals.

For details on video input/output conversion classified according to the Resolution menu settings, see Figure 1 on page 124.

■ AUTO

■ DIRECT

Lets you output analog video input signals without conversion.

■ 480i/576i

■ 480p/576p

■ 720p

■ 1080i

■ 1080p

Zone Resolution

Lets you convert the resolution of analog video input signal in zone 2.

For details on video input/output conversion classified according to the Zone Resolution menu settings, see Figure 2 on page 125.

■ 480i/576i

■ 480p/576p

■ 720p

■ 1080i

Figure 1

"Resolution" menu setting	Output from	HDMI OUT jacks	MONITOR COMPONENT VIDEO OUT jacks	MONITOR VIDEO OUT jack
	Input signals			
DIRECT	Component video	–	○	–
	Composite video	–	–	○
AUTO (initial setting)	Component video	● ^{a)}	● ^{b)}	● ^{b)}
	Composite video		● ^{b)}	● ^{b)}
480i/576i	Component video	● ^{c)}	●	●
	Composite video	● ^{c)}	●	●
480p/576p	Component video	●	●	–
	Composite video	●	●	○
720p, 1080i	Component video	●	● ^{d)}	–
	Composite video	●	● ^{d)}	○
1080p	Component video	●	○	–
	Composite video	●	–	○

● : Video signals are converted and output through the video converter.

○ : The same type of signal as that of the input signal is output. Video signals are not converted.

– : Video signals are not output.

a)The resolution is set automatically, depending on the connected monitor.

b)When the TV is connected to jacks other than the HDMI jacks, 480i/576i signals are output when "Resolution" is set to "AUTO."

c)480p/576p signals are output even if 480i/576i is set.

d)Video signals without copyright protection are output based on the settings menu. Video signals with copyright protection are output as 480p.

Notes

- Video signals are not output from the COMPONENT VIDEO MONITOR OUT or MONITOR VIDEO OUT jacks when the monitor, etc., is connected to HDMI OUT jacks.
- If you select a resolution that the connected TV does not support in the "Resolution" menu, the images from the TV cannot be output correctly.
- Converted HDMI image output signals do not support "x.v.Color."
- Converted HDMI image output signals do not support Deep Color.

Figure 2

“Zone Resolution” menu setting	Output from	ZONE 2 COMPONENT VIDEO OUT jacks	ZONE 2 VIDEO OUT jack	ZONE 2 COMPONENT VIDEO OUT (CAT5 RJ45) jack
	Input signals			
480i/576i (initial setting)	Component video	●	●	●
	Composite video	●	●	●
480p/576p	Component video	●	–	●
	Composite video	●	–	●
720p, 1080i	Component video	●	–	●
	Composite video	●	–	●

● : Video signals are converted and output through the video converter.

– : Video signals are not output.

HDMI settings

Makes the required settings for components connected to the HDMI jacks.

Control for HDMI

Lets you turn the function which controls components connected to the HDMI jack using an HDMI cable on or off.

■ OFF

■ ON

Note

When you set “Control for HDMI” to “ON,” “Audio Out” may be changed automatically.

Audio Out (Setting HDMI audio input)

Lets you set the HDMI audio signals output from the playback component connected to the receiver via an HDMI connection.

■ TV+AMP

The sound is output from TV’s speaker and the speakers connected to the receiver.

Notes

- The sound quality of the playback component depends on the TV’s sound quality, such as the number of channels, and the sampling frequency, etc. When the TV has stereo speakers, the sound output from the receiver is also stereo as that of the TV, even if you play multi-channel source.
- When you connect the receiver to a video component (projector, etc.), sound may not be output from the receiver. In this case, select “AMP.”
- When you select the input that you have assigned the HDMI input, sound does not output from the TV.

■ AMP

The HDMI audio signals from the playback component is only output to speakers connected to the receiver. The multi-channel sound can be played back as it is.

Note

Audio signals are not output from the TV’s speakers when “Audio Out” is set to “AMP.”

Subwoofer Level

Lets you set the level of the subwoofer to 0 dB or +10 dB when PCM signals are input via an HDMI connection. You can set the level for each HDMI input independently.

■ 0 dB

■ AUTO

Automatically sets the level to 0 dB or +10 dB depending on the frequency.

■ +10 dB

H.A.T.S.

Lets you turn the H.A.T.S. (High quality digital Audio Transmission System) function on or off. When the H.A.T.S. function is turned on, the sound quality is enhanced because there is no jitter (timing gaps when reading signals) when transmitting digital audio signals.

To activate the H.A.T.S. function, select “ON” for “CTRL FOR HDMI.”

■ OFF

■ ON

Notes

- It takes some time to output the sound after a playback operation is performed on the connected component (e.g., pressing the PLAY button, pressing the STOP button, pressing the PAUSE button) due to limitations of the H.A.T.S. system. The time lag depends on the sound source. This feature may be ineffective depending on the component and the sound source, even if you set it to ON.
- The components connected to the HDMI jack must support the H.A.T.S. feature.
- When “Audio Out” is set to “TV+AMP,” the H.A.T.S. function may not work depending on the component connected or the condition of that component. In this case, select “AMP” for “Audio Out.”
- The H.A.T.S. function of this receiver works when a Sony SCD-XA5400ES is connected to the receiver.

Stream information about the H.A.T.S. function available

Audio signal input	Sampling frequency
Linear PCM 2ch	44.1 kHz, 48 kHz, 88.2 kHz, 96 kHz, 176.4 kHz, 192 kHz
Linear PCM Multi	44.1 kHz, 48 kHz, 88.2 kHz, 96 kHz, 176.4 kHz, 192 kHz
DSD	2.8224 MHz

Video Direct

Lets you output the video input signals from the HDMI IN jack directly to the HDMI OUT jack.

■ OFF

The input signals from the HDMI IN jack are output through a video processor.

■ ON

The input signals from the HDMI IN jack are output directly.

Network Settings

Makes the settings for the network. Refer to “Using Network Features” supplied with these operating instructions for details.

Server Function Setup

Lets you activate the server function of the receiver.

■ OFF

■ ON

Network Setup

Lets you make the network settings.

■ Network Information

■ Network Setup

■ Proxy Setup

■ Cancel Network Setup

Rhapsody Account

Lets you enter the Rhapsody Account number to listen to the Rhapsody Internet radio service.

Quick Click settings

Controls components connected to the receiver using the on-screen remote.

Source Component

Selects the source component that is to be operated.

■ Preset Mode

Customizes the remote to match the source components connected to your receiver.

■ Learn Mode

Allows the remote learn codes.

■ Reset

Resets both programmed codes and learned codes.

Common Component

Selects the common component such as a TV, projector or lights that is to be operated.

■ Preset Mode

Customizes the remote to match the common components such as the TV, the projector and the lightings connected to your receiver.

■ Learn Mode

Allows the remote to learn codes.

■ Reset

Resets both programmed codes and learned codes.

Macro Setup

Sets several commands in a sequential order as a single command.

System settings

Customizes the settings of the receiver.

Screen Saver

Lets you activate the screen saver function for the GUI menu on the TV connected to the receiver.

■ OFF

The screen saver function is disabled.

■ ON

When there has been no operation attempted for 15 minutes, the screen saver function is activated automatically.

RS-232C Control

Lets you use this menu for the zone 2/zone 3 operation.

■ OFF

■ ON

Language

Selects the language for the messages on the screen.

■ English

■ Español

■ Français

■ Deutsch

System Update

Lets you upgrade the firmware of the receiver. Refer to “Using Network Features” supplied with these operating instructions for details.

Operating without connecting to a TV

You can operate the receiver using the display window of the receiver even if the TV is not connected to the receiver.

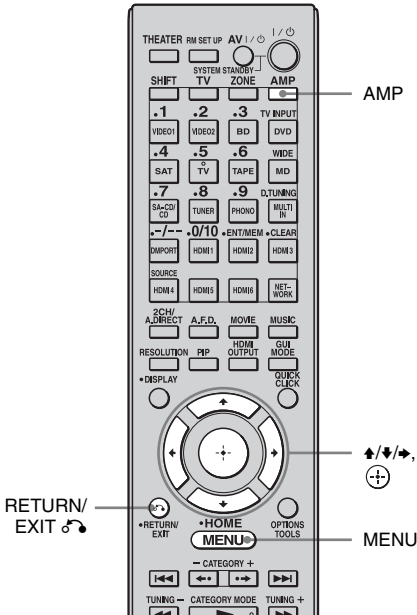

Using the menu in the display window

If “GUI MODE” is displayed in the display window of the receiver, press GUI MODE to switch the display mode of the menu to “DISPLAY MODE.”

- 1 Turn on the receiver.
- 2 Press AMP.

The receiver can be operated using the remote.

3 Press MENU.

The menu is displayed in the display window of the receiver.

Example: When you select “Level Settings”



4 Press ↑/↓ repeatedly to select the menu, then press (+) or →.

5 Press ↑/↓ repeatedly to select the menu item, then press (+) or →.

The parameter appears in brackets.

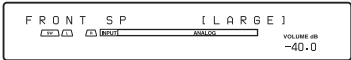

6 Press ↑/↓ repeatedly to select the parameter you want, then press (+).

The parameter is entered and the brackets disappear from the display.

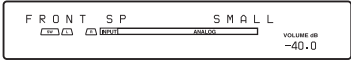

Tip

To return to the previous step, press RETURN/EXIT.

Menu list (in the display window)

The following options are available in each menu.

“■ ■...” in the table signifies the parameter for each item.

Menu	Item	Parameter	Initial setting
Auto Calibration	AUTO CAL START?		
	5 4 3 2 1		
	MEASURING: TONE		
	MEASURING: T.S.P.		
	MEASURING: WOOFER		
	COMPLETE [■■■■■■■■■■■■]	RETRY, SAVE EXIT, WRN CHECK, PHASE INFO, DIST. INFO, LEVEL INFO, EXIT	SAVE EXIT
	WARNING CODE [■■■■:4■]	FL, FR, C, SLA, SRA, SLB, SRB, SBL, SBR : 0, 1, 2, 3, 4	
	NO WARNING		
	ERROR CODE [■■■■:3■]	F, SR, SB : 0, 1, 2, 3, 4	
	RETRY? [■■■■]	YES, EXIT	YES
	CANCEL		
	CAL TYPE [■■■■■■■■■■■■]	ENGINEER, FULL FLAT, FRONT REF, OFF	FULL FLAT
	POSITION [■■■■■■■■■■]	POS.1, POS.2, POS.3	POS.1
	NAME IN ? [■■■■■■■■■■]		
	Level Settings	TEST TONE [■■■■■■■■■■]	OFF, L to SW (AUTO), L to SW (FIX)
PHASE NOISE [■■■■■■■■■■]		OFF, L/C, C/R, R/SL, R/SR, SR/SL, SR/SBR, SBR/SBL, SBL/SL, SL/L, L/SR	OFF
PHASE AUDIO [■■■■■■■■■■]		OFF, L/C, C/R, R/SL, R/SR, SR/SL, SR/SBR, SBR/SBL, SBL/SL, SL/L, L/SR	OFF
FRONT L [■■■■.■dB]		-10.0dB to +10.0dB (0.5dB step)	0dB
FRONT R [■■■■.■dB]		-10.0dB to +10.0dB (0.5dB step)	0dB
CENTER [■■■■.■dB]		-20.0dB to +10.0dB (0.5dB step)	0dB
SURROUND L [■■■■.■dB]		-20.0dB to +10.0dB (0.5dB step)	0dB
SURROUND R [■■■■.■dB]		-20.0dB to +10.0dB (0.5dB step)	0dB
SUR BACK [■■■■.■dB]		-20.0dB to +10.0dB (0.5dB step)	0dB
SUR BACK L [■■■■.■dB]		-20.0dB to +10.0dB (0.5dB step)	0dB
SUR BACK R [■■■■.■dB]		-20.0dB to +10.0dB (0.5dB step)	0dB
SUB WOOFER [■■■■.■dB]		-20.0dB to +10.0dB (0.5dB step)	0dB
D. RANGE COMP. [■■■■]		OFF, AUTO, STD, MAX	AUTO

Menu	Item	Parameter	Initial setting
Speaker Settings	SP PATTERN [■ ■ ■ ■ ■ ■]	2/0 to 3/4.1 (16 patterns)	3/4.1
	FRONT SP [■ ■ ■ ■ ■ ■]	SMALL, LARGE	LARGE
	CENTER SP [■ ■ ■ ■ ■ ■]	SMALL, LARGE	LARGE
	SURROUND SP [■ ■ ■ ■ ■ ■]	SMALL, LARGE	LARGE
	BI-AMP [■ ■ ■ ■]	OFF, ON	OFF
	ZONE2 SP [■ ■ ■ ■]	OFF, ON	OFF
	FRONT L [■ ■ ■ ■ ■ ■ ■ ■ ■ ■]		
	FRONT R [■ ■ ■ ■ ■ ■ ■ ■ ■ ■]		
	CENTER [■ ■ ■ ■ ■ ■ ■ ■ ■ ■]		
	SURROUND L [■ ■ ■ ■ ■ ■ ■ ■ ■ ■]		
	SURROUND R [■ ■ ■ ■ ■ ■ ■ ■ ■ ■]	3' 3" to 32' 9" (1 inch step)	9' 10"
	SUR BACK [■ ■ ■ ■ ■ ■ ■ ■ ■ ■]	1.0 to 10.0 (m) (0.1 m step)	3m
	SUR BACK L [■ ■ ■ ■ ■ ■ ■ ■ ■ ■]		
	SUR BACK R [■ ■ ■ ■ ■ ■ ■ ■ ■ ■]		
	SUB WOOFER [■ ■ ■ ■ ■ ■ ■ ■ ■ ■]		
	DISTANCE UNIT [■ ■ ■ ■ ■ ■]	meter, feet	feet
	FR CROSSOVER* [■ ■ ■ ■ ■ ■]	40 to 200 (10 Hz step)	120
	CNT CROSSOVER* [■ ■ ■ ■ ■ ■]	40 to 200 (10 Hz step)	120
	SUR CROSSOVER* [■ ■ ■ ■ ■ ■]	40 to 200 (10 Hz step)	120
	CNT A.DOWN MIX [■ ■ ■ ■]	OFF, ON	OFF
SP IMPEDANCE [■ohm]	4ohm, 8ohm	8ohm	

* You cannot choose this setting when the speaker is set to "LARGE."

Menu	Item	Parameter	Initial setting
HDMI Settings	CTRL FOR HDMI [■■■■]	OFF, ON	OFF
	AUDIO OUT [■■■■■■■■]	TV+AMP, AMP	AMP
	SW LEVEL [■■■■dB]	AUTO, +10dB, 0dB	AUTO
	H.A.T.S. [■■■■]*	OFF, ON	ON
	VIDEO DIRECT [■■■■]	OFF, ON	OFF
System Settings	NAME IN ? [■■■■■■■■■■]		
	PARTY SETUP [■■■■■■■■■■]	ZONE2/3, ZONE2, ZONE3	ZONE2/3
	12V TRIG. MAIN [■■■■■■■■]	OFF, CTRL, ZONE, INPUT	OFF
	12V TRIG. ZONE2 [■■■■■■■■]	OFF, CTRL, ZONE, MAIN	OFF
	12V TRIG. ZONE3 [■■■■■■■■]	OFF, CTRL, ZONE, MAIN	OFF
	RS-232C CONTROL [■■■■]	OFF, ON	ON
	SERVER [■■■■]	OFF, ON	OFF
	VERSION [■.■■■■]	-	-

* To activate the H.A.T.S. function, select "ON" for "CTRL FOR HDMI."

To change the display

You can check the sound field, etc., by changing the information on the display.

1 Press AMP.

The receiver can be operated using the remote.

2 Select the input for which you want to check the information.

3 Press DISPLAY repeatedly.

Each time you press DISPLAY, the display will change as follows.

Input you selected → Sound field type → Stream Information → Input name ...

When listening to FM and AM radio

Station name → Frequency → Sound field type → Volume...

Index name appears only when you have assigned one to the input or preset station.

Index name does not appear when only blank spaces have been entered.

When tuning in a channel from a satellite tuner

Channel name → Channel number → Category → Artist name → Song title → Composer name (SIRIUS only) → Signal strength → Sound field type

Using the Remote

Operating each component using the remote

You can control Sony or non-Sony components you are using with the remote supplied with the receiver.

The remote is initially set to control Sony components.

When you change the settings of the remote according to the components you are using, you can control non-Sony and other Sony components that the remote is initially unable control (page 137).

Operating the components connected to the receiver

- 1 Press the input button that matches the connected component that you want to operate.**
- 2 Press the appropriated buttons to use the function listed in the table below.**

Note

You may not be able to operate some functions for the components you are using.

Table of buttons used to control each component (Main remote commander)

Component	TV	VCR	DVD player, DVD/VHS combo	Blu-ray Disc Player	HDD Recorder	PSX	Video CD player, LD player	Digital CATV terminal	DSS	Tape deck A/B	DAT deck	CD player, MD deck	DIGITAL MEDIA PORT device
AV I/O	●	●	●	●	●	●	●	●	●		●	●	
Numeric buttons	●	●	●	●	●	●	●	●	●	●	●	●	●
TV INPUT, WIDE	●												
-/-	●	●	●	●	●	●	●	●	●	●		●	
ENT/MEM	●	●	●	●	●	●	●*1	●	●	●	●	●	
CLEAR			●	●	●	●			●			●	
OPTIONS/TOOLS	●		●	●	●	●		●	●				
DISPLAY	●	●	●	●	●	●	●	●	●			●	
RETURN/EXIT	●		●	●	●	●	●	●	●				●
↔/↔/↔/↔, ⊕, MENU, HOME	●	●	●	●	●	●		●	●				●
⏮/⏪/⏩/⏭	●	●	●	●	●	●	●	●		●*2	●	●	●
⏪/⏩	●		●	●	●	●		●					●
⏮/TUNING -, ⏭/TUNING +	●	●	●	●	●	●	●	●		●	●	●	●
DISC SKIP			●*3				●*4					●	
▶, II, ■	●	●	●	●	●	●	●	●		●	●	●	●
MUTING, MASTER VOL +/-, TV VOL +/-	●												
PRESET +/-, TV CH +/-	●	●	●	●	●		●*1	●	●				
BD/DVD TOP MENU, BD/DVD MENU			●	●		●							
F1, F2			●	●									

*1 LD player only.
 *2 Deck B only.
 *3 DVD only.
 *4 Video CD only.

Using the Remote

Table of buttons used to control each component (Zone 2/Zone 3 remote commander)

Component	TV	VCR	DVD player, DVD/VHS combo	Blu-ray Disc Player	HDD Recorder	PSX	Video CD player, LD player	Digital CATV terminal	DSS	Tape deck A/B	DAT deck	CD player, MD deck	DIGITAL MEDIA PORT device
AV I/O	●	●	●	●	●	●	●	●	●		●	●	
Numeric buttons	●	●	●	●	●	●	●	●	●	●	●	●	●
TV INPUT, WIDE, PICTURE, FAVORITES	●												
-/+	●	●	●	●	●	●	●	●	●	●		●	
ENTER	●	●	●	●	●	●	● ^{*1}	●	●	●	●	●	
OPTIONS/TOOLS	●		●	●	●	●		●	●				
DISPLAY	●	●	●	●	●	●	●	●	●			●	
RETURN/EXIT	●		●	●	●	●	●	●	●				●
⏪/⏩/⏴/⏵, (+), MENU, HOME	●	●	●	●	●	●		●	●				●
⏮/⏭/⏪/⏩	●	●	●	●	●	●	●	●		● ^{*2}	●	●	●
⏴/⏵	●		●	●	●	●		●					●
⏮/TUNING -, ⏭/TUNING +	●	●	●	●	●	●	●	●		●	●	●	●
DISC SKIP			● ^{*3}				● ^{*4}					●	
▶, II, ■	●	●	●	●	●	●	●	●		●	●	●	●
MUTING, MASTER VOL +/-, TV VOL +/-	●												
PRESET +/-, TV CH +/-	●	●	●	●	●		● ^{*1}	●	●				
BD/DVD TOP MENU, BD/DVD MENU			●	●		●							

*1 LD player only.

*2 Deck B only.

*3 DVD only.

*4 Video CD only.

Programming the remote

You can customize the remote to match the components connected to your receiver. You can even program the remote to control non-Sony components and also Sony components that the remote is normally unable to control. The procedure below uses as an example a case in which a VCR made by a company other than Sony is connected to the VIDEO 2 IN jacks on the receiver.

Main remote

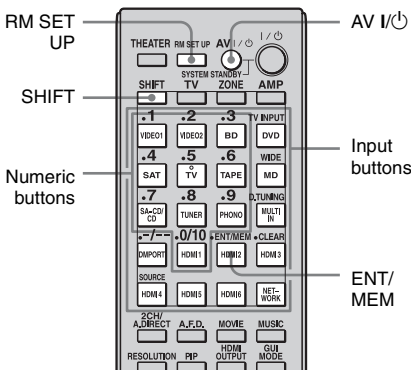

Zone 2/Zone 3 remote

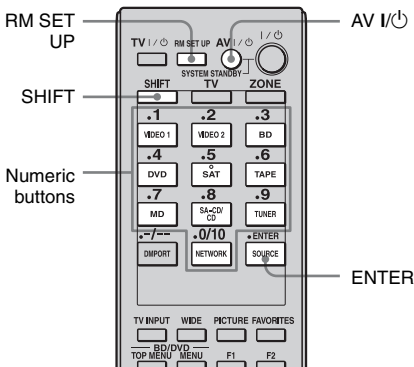

1 Press AV I/O while pressing RM SET UP.

The RM SET UP button flashes.

2 While the RM SET UP button is flashing, press the input button (including TV) for the component you want to control.

For example, if you are going to control a VCR connected to VIDEO 2 IN jack, press VIDEO 2.

RM SET UP and the input button light up. If you press the button for a component of which you cannot program the remote, such as TUNER, PHONO, DMPORT or SOURCE, etc., the RM SET UP button keeps flashing.

3 Press the numeric buttons to enter the numeric code (or one of the codes if more than one code exists) corresponding to the component and the maker of the component you want to control.

The input button lights up.

Note

For a TV remote code value, only numbers in the 500's are valid.

4 Press ENT/MEM or ENTER.

Once the numeric code has been verified, the RM SET UP button flashes twice and the remote automatically exits the programming mode. The input button also turns off.

To cancel programming

Press RM SET UP during any step.

The numeric codes corresponding to the component and the maker of the component

Use the numeric codes in the tables below to control non-Sony components and also Sony components that the remote is normally unable to control. Since the remote signal that a component accepts differs depending on the model and year of the component, more than one numeric code may be assigned to a component. If you fail to program your remote using one of the codes, try using other codes.

Notes

- The numeric codes are based on the latest information available for each brand. There is a chance, however, that your component will not respond to some or all of the codes.
- All of the input buttons on this remote may not be available when used with your particular component.

To control a CD player

Maker	Code(s)
SONY	101, 102, 103
DENON	104, 123
JVC	105, 106, 107
KENWOOD	108, 109, 110
MAGNAVOX	111, 116
MARANTZ	116
ONKYO	112, 113, 114
PANASONIC	115
PHILIPS	116
PIONEER	117
TECHNICS	115, 118, 119
YAMAHA	120, 121, 122

To control a DAT deck

Maker	Code(s)
SONY	203
PIONEER	219

To control a tape deck

Maker	Code(s)
SONY	201, 202
DENON	204, 205

Maker	Code(s)
KENWOOD	206, 207, 208, 209
NAKAMICHI	210
PANASONIC	216
PHILIPS	211, 212
PIONEER	213, 214
TECHNICS	215, 216
YAMAHA	217, 218

To control an MD deck

Maker	Code(s)
SONY	301
DENON	302
JVC	303
KENWOOD	304

To control an HDD recorder

Maker	Code(s)
SONY	307, 308, 309

To control a Blu-ray Disc Player

Maker	Code(s)
SONY	310, 311, 312

To control a PSX

Maker	Code(s)
SONY	313, 314, 315

To control a DVD player

Maker	Code(s)
SONY	401, 402, 403
BROKSONIC	424
DENON	405
HITACHI	416
JVC	415, 423
MITSUBISHI	419
ORITRON	417
PANASONIC	406, 408, 425
PHILIPS	407
PIONEER	409, 410
RCA	414
SAMSUNG	416, 422
TOSHIBA	404, 421
ZENITH	418, 420

To control a DVD/VIDEO COMBO (recorder)

Maker	Code(s)
SONY	411

To control a HDD/DVD COMBO (recorder)

Maker	Code(s)
SONY	401, 402, 403

To control a TV

Maker	Code(s)
SONY	501
AIWA	501, 536, 539
AKAI	503
AOC	503
CENTURION	566
CORONADO	517
CURTIS-MATHES	503, 551, 566, 567
DAYTRON	517, 566
DAEWOO	504, 505, 506, 507, 515, 544
FISHER	508, 545
FUNAI	548
FUJITSU	528
GOLDSTAR/LG	503, 512, 515, 517, 534, 544, 556, 568, 576
GRUNDIG	511, 533, 534
HITACHI	503, 513, 514, 515, 517, 519, 544, 557, 571
ITT/NOKIA	521, 522
J.C.PENNY	503, 510, 566
JVC	516, 552
KMC	517
MAGNVOX	503, 515, 517, 518, 544, 566
MARANTZ	527
MITSUBISHI/MGA	503, 519, 527, 544, 566, 568
NEC	503, 517, 520, 540, 544, 554, 566
NORDMENDE	530, 558
NOKIA	521, 522, 573, 575
PANASONIC	509, 524, 553, 559, 572
PHILIPS	515, 518, 557, 570, 571
PHILCO	503, 504, 514, 517, 518
PIONEER	509, 525, 526, 540, 551, 555
PORTLAND	503
QUASAR	509, 535

Maker	Code(s)
RADIO SHACK	503, 510, 527, 565, 567
RCA/PROSCAN	503, 510, 523, 529, 544
SAMSUNG	503, 515, 517, 531, 532, 534, 544, 556, 557, 562, 563, 566, 569
SAMPO	566
SABA	530, 537, 547, 549, 558
SANYO	508, 545, 546, 560, 567
SCOTT	503, 566
SEARS	503, 508, 510, 517, 518, 551
SHARP	517, 535, 550, 561, 565
SYLVANIA	503, 518, 566
THOMSON	530, 537, 547, 549
TOSHIBA	535, 539, 540, 541, 551
TELEFUNKEN	530, 537, 538, 547, 549, 558
TEKNIKA	517, 518, 567
WARDS	503, 517, 566
YORK	566
ZENITH	542, 543, 567
GE	503, 509, 510, 544
LOEWE	515, 534, 556

To control an LD player

Maker	Code(s)
SONY	601, 602, 603
PIONEER	606

To control a video CD player

Maker	Code(s)
SONY	605

To control a VCR

Maker	Code(s)
SONY	701, 702, 703, 704, 705, 706
AIWA*	710, 750, 757, 758
AKAI	707, 708, 709, 759
BLAUPUNKT	740
EMERSON	711, 712, 713, 714, 715, 716, 750
FISHER	717, 718, 719, 720
GENERAL ELECTRIC (GE)	721, 722, 730
GOLDSTAR/LG	723, 753
GRUNDIG	724
HITACHI	722, 725, 729, 741
ITT/NOKIA	717

Maker	Code(s)
JVC	726, 727, 728, 736
MAGNAVOX	730, 731, 738
MITSUBISHI/MGA	732, 733, 734, 735
NEC	736
PANASONIC	729, 730, 737, 738, 739, 740
PHILIPS	729, 730, 731
PIONEER	729
RCA/PROSCAN	722, 729, 730, 731, 741, 747
SAMSUNG	742, 743, 744, 745
SANYO	717, 720, 746
SHARP	748, 749
TELEFUNKEN	751, 752
TOSHIBA	747, 756
ZENITH	754

* If an AIWA VCR does not work even though you enter the code for AIWA, enter the code for Sony instead.

To control a satellite tuner (box)

Maker	Code(s)
SONY	801, 802, 803, 804, 824, 825, 865
AMSTRAD	845, 846
BskyB	862
GENERAL ELECTRIC(GE)	866
GRUNDING	859, 860
HUMAX	846, 847
THOMSON	857, 861, 864, 876
PACE	848, 849, 850, 852, 862, 863, 864
PANASONIC	818, 855
PHILIPS	856, 857, 858, 859, 860, 864, 874
NOKIA	851, 853, 854, 864
RCA/PROSCAN	866, 871
HITACHI/BITA	868
HUGHES	867
JVC/Echostar/Dish Network	873
MITSUBISHI	872
SAMSUNG	875
TOSHIBA	869, 870

To control a cable box

Maker	Code(s)
SONY	821, 822, 823

Maker	Code(s)
HAMLIN/REGAL	836, 837, 838, 839, 840
JERROLD/G.I./MOTOROLA	806, 807, 808, 809, 810, 811, 812, 813, 814, 819
JERROLD	830, 831
OAK	841, 842, 843
PANASONIC	816, 826, 832, 833, 834, 835
PHILIPS	830, 831
PIONEER	828, 829
RCA	805
SCIENTIFIC ATLANTA	815, 816, 817
TOCOM/PHILIPS	830, 831
ZENITH	826, 827

Performing several commands in sequence automatically (Macro Play)

The Macro Play function lets you link several commands in a sequential order as a single command.

The remote provides 2 macro lists (MACRO 1 and MACRO 2). You can specify up to 20 commands for each macro list.

Note

When setting up Macro Play, replace the batteries with new ones.

Program the sequence of the operation

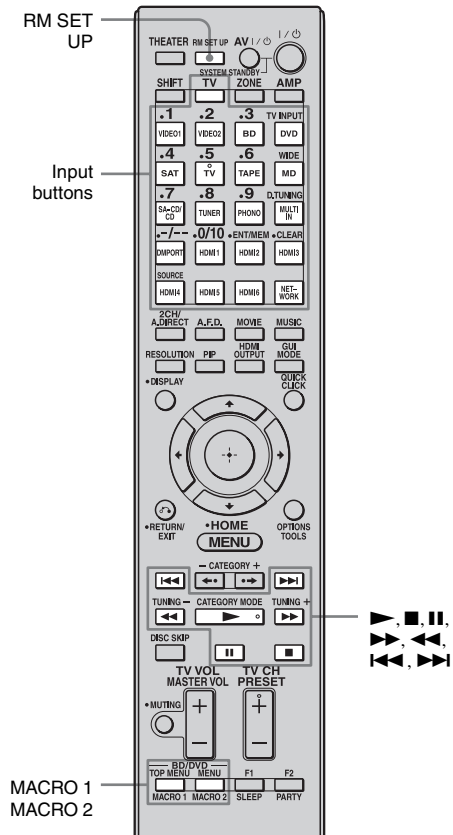

- 1** Press **MACRO 1** or **MACRO 2** for more than 1 second while pressing **RM SET UP**.
The **RM SET UP** button flashes and one of the input buttons lights up (as the initial setting, the **VIDEO1** button lights).
- 2** Press the input button for the component for which you want to program the sequence of operation(s).

Using the Remote

- 3** Press the buttons you want to program in the same sequence as you want the operation(s) to be performed.

Press	Operations to be programmed
▶, ■, , ▶▶, ◀◀, ◀◀, ▶▶▶	Performs the operation of the button.
The input button for more than 1 second	Switches inputs.
MACRO 1 or MACRO 2	Make a one second interval. When you want to make a longer interval, press MACRO 1 or MACRO 2 repeatedly.

The input button selected in step 2 flashes twice, then lights up again.

- 4** Repeat steps 2 and 3 when you want to program operations for other components.

- 5** Press RM SET UP to finish the programming process.

Tip

If the RM SET UP button flashes five times in step 1, and the macro programming process does not start, replace the batteries with new ones.

To cancel programming

Press RM SET UP. Also, not pressing any button for 60 seconds cancels the settings. The previous command remains valid.

Starting macro play

- 1** Press AMP.

The AMP button lights up, and then turns off.

- 2** Press MACRO 1 or MACRO 2 to start the macro.

The macro starts and execute the commands in the order you assigned them. While the commands are being sent, the AMP button flashes and the RM SET UP button lights up. When the commands have been sent, the RM SET UP and AMP buttons turn off.

To erase a programmed macro

- 1** Press MACRO 1 or MACRO 2 for more than 1 second while pressing RM SET UP to clear the stored macro.

The RM SET UP button flashes.

- 2** Press RM SET UP.

Settings stored as macro are cleared.

Setting remote commander codes that are not stored in the remote

Even if a remote commander code is not one of the presets stored in the remote, it is possible for the remote to learn the code using the learning function.

Note

When setting up the receiver to learn the remote command modes, replace the batteries with new ones.

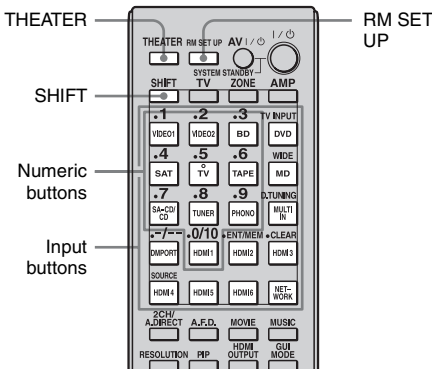

Example for storing a new commander code for the numeric button 1 when the VIDEO2 input is selected.

1 Press THEATER while pressing RM SET UP.

The RM SET UP button lights up.

2 Press the input button (VIDEO2 in the example) for the component you want to operate with the new command.

The input button flashes. (The RM SET UP button remains lit.)

3 Press SHIFT, then press the numeric buttons (button 1 in the example) you want to store the new command.

The input button you selected in step 2 lights up. (The RM SET UP button remains lit.)

4 Point the remote code receiver section of the remote toward the receiver/transmitter on the remote commander to be learned from.

While the second remote is receiving the signal, the input button selected in step 2 turns off.

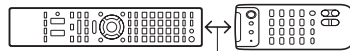

About 5 cm - 10 cm (2" - 4")

The RM SET UP button flashes twice, then the learning process is completed. When the learning process fails, the RM SET UP button flashes five times. Try to perform process again from step 2.

5 Press RM SET UP to finish the Learning function process.

Tips

- When the memory capacity for storing remote commander codes reaches a certain limit, the RM SET UP button flashes 10 times, and then the learning process ends.
- If the RM SET UP button flashes five times in step 1, and the learning process does not start, replace the batteries with new ones.

To cancel learning

Press RM SET UP. Also, not pressing any button for 60 seconds cancels the settings.

Using a command that has been learned

When selecting a learned input, press the button used to learn that function.

To erase the learned code

- 1 Press THEATER while pressing RM SET UP.
SET UP.
- 2 Press the input button (VIDEO2 in the example) for which you want to clear the setting.
The input button flashes. (The RM SET UP button remains lit.)
- 3 Press I/⏻ for more than 1 second.
The input button flashes twice, repeatedly.
- 4 Press SHIFT, then press numeric buttons (button 1 in the example) to clear the stored setting.
The RM SET UP button flashes twice, then the clearing process is completed.
When the clearing process fails, the RM SET UP button flashes five times. Try to perform process again from step 2.

Clearing all the contents of the remote's memory

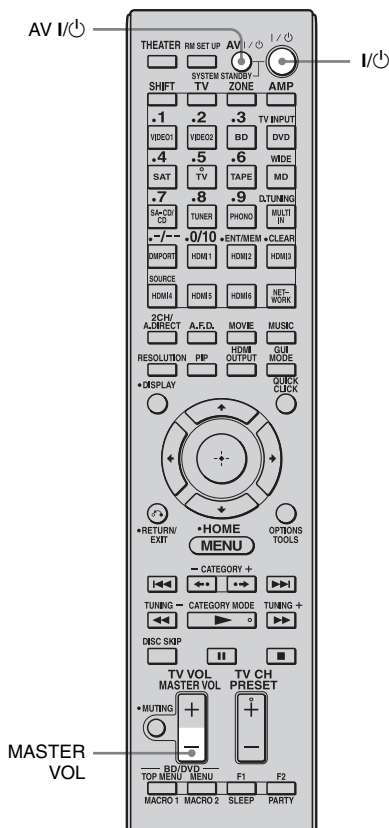

- 1 Press and hold MASTER VOL – first, then press I/⏻, then press AV I/⏻.
The RM SET UP button flashes three times.
- 2 Release all buttons.
All the contents of the remote's memory (e.g., all the programmed data) are cleared.

Using On-screen Remote (Quick Click)

Operating components or lighting connected to the receiver using the on screen remote (Quick Click)

You can control components connected to the receiver, a projector, and the light control unit using the on-screen remote on the TV screen.

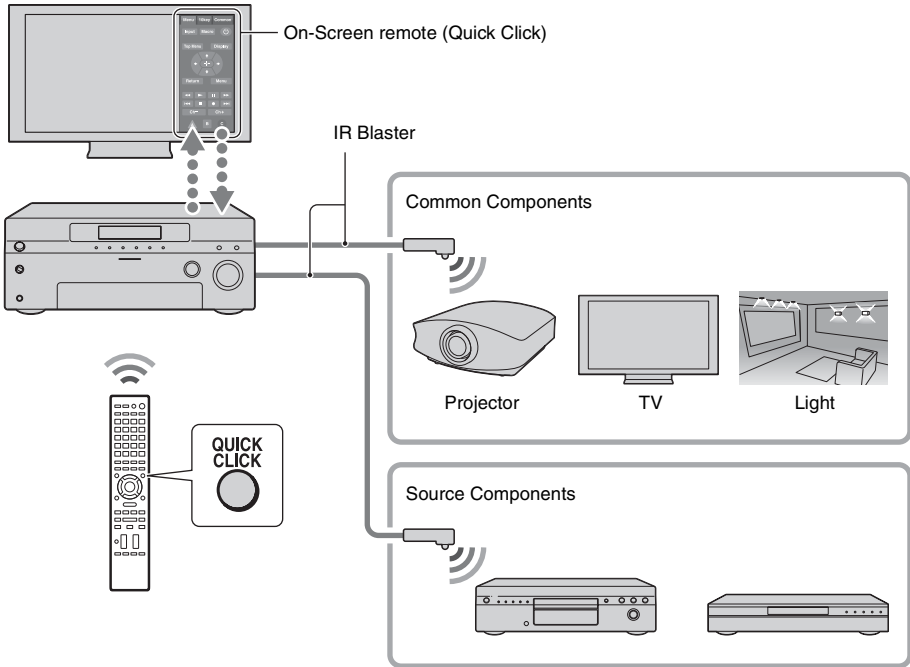



Preparing Quick Click

It is necessary to connect the IR Blaster to use Quick Click. Connect the IR Blaster according to following instructions.

Connecting the IR Blaster

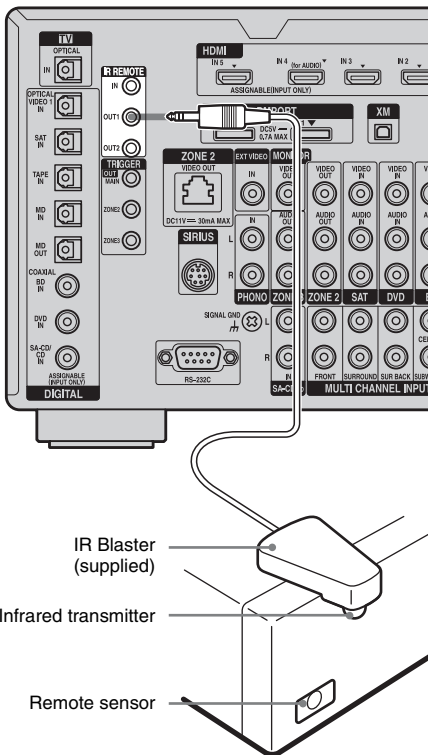
Attach the supplied IR Blaster to components connected to the receiver. You can control components connected to the receiver via the IR Blaster using the on-screen remote control.



After referring to the operating instructions of the components connected to the receiver make sure to place the IR Blaster just above or below the remote sensor. Remote sensors on Sony Recorders and other products are identified by the  symbol.

Note

Do not remove the backing paper from the IR Blaster yet.

After configuring the settings, remove the backing paper from the IR Blaster and fix it in place.

Place the components and the IR Blaster as follows when you want to operate two components with the IR Blaster.

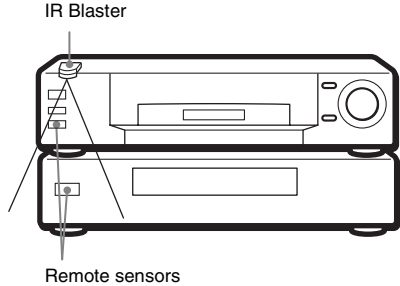

If the infrared receivers on the two components do not line up as shown in the illustration above, you must purchase an optional IR Blaster (VM-50, not supplied) and install it.

Note

For details on how to set up a component, refer to the operating instructions of the component.

Tip

If the IR Blaster cable is too short, use a 3.5 mm jack extension cable (not supplied).

Using Quick Click

You can control components connected to the receiver, a TV, projector, or lighting using the on-screen remote on the TV screen.

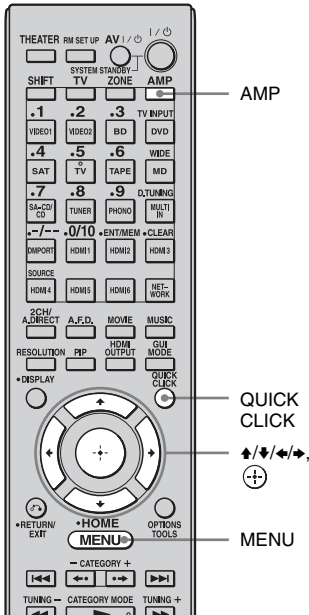

6 Press $\uparrow/\downarrow/\leftarrow/\rightarrow$ repeatedly to select the appropriated buttons on the on-screen remote to use the function listed in the table below, then press \oplus .

Note

You may not be able to operate some functions for the components you are using.

1 Press AMP.

The receiver can be operated using the remote.

2 Press MENU.

The menu is displayed on the TV screen.

3 Press \uparrow/\downarrow repeatedly to select “Input,” then press \oplus or \rightarrow .

4 Press \uparrow/\downarrow repeatedly to select the component you want, then press \oplus .

5 Press QUICK CLICK.

Table of buttons used to control each component (Quick Click)

Refer to “Operating the components connected to the receiver” for details on the buttons of the on-screen remote.

Category	TV	VCR	PROJECTOR	BD/DVD	LD	CD	MD	CABLE	SAT	TAPE	DVR	LIGHT
Button												
⏻	●	●	●	●	●	●	●	●	●	●	●	●
Numeric buttons	●	●	–	●	●	●	●	●	●	●	●	–
+10 (●)	●	–	–	●	●	●	●	●	●	–	●	–
Ent	●	●	–	●	●	●	●	●	●	●	●	–
Input	●	●	●	●	–	–	–	●	●	–	●	–
Display (Info)	●	●	●	●	●	●	●	●	●	●	●	–
Top Menu (Guide)	●	–	–	●	–	–	–	●	●	–	●	–
◀◀▶▶■/■	–	●	–	●	●	●	●	●	●	●	●	–
●	–	●	–	●	–	–	●	●	●	●	●	–
◀◀▶▶	–	–	–	●	●	●	●	●	●	●	●	–
↕/↔/↔/Menu/ Ⓢ/Exit/Return	●	●	●	●	–	–	–	●	●	–	●	–
Ch +/-	●	●	–	–	–	–	–	●	●	–	●	–
A/B/C	–	–	–	–	–	–	–	●	–	–	–	–
Scene 1-16	–	–	–	–	–	–	–	–	–	–	–	●
All On/Off	–	–	–	–	–	–	–	–	–	–	–	●
On/Off	–	–	–	–	–	–	–	–	–	–	–	●
Raise/Lower	–	–	–	–	–	–	–	–	–	–	–	●
Light Off	–	–	–	–	–	–	–	–	–	–	–	●
Toggle	–	–	–	–	–	–	–	–	–	–	–	●

Operating the components connected to the receiver

You can control components connected to the receiver using the “Menu” and “10key” features of Quick Click.

The following explanation provides examples of normal operation. The component may work differently, or may not work at all depending on the component.

Menu tab

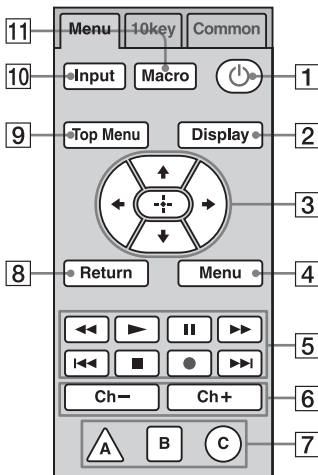

Button	Function
1	Select to turn components connected to the receiver on or off.
2 Display (Info)	Select to display the current status of or information on components connected to the receiver.
3	Select /// to select menu items. Then press to enter the selection.
4 Menu	Select to display the menu of components connected to the receiver.

Button	Function
5	Select to start playback or to record.
	Select to stop or pause playback or recording.
	Select to fast-forward or fast-backward.
	Select to jump to the next/previous track.
6 Ch+/Ch-	Select Ch +/- to select the channel of the TV, satellite tuner, VCR, etc.
7 A/B/C	Select when you operate a cableTV tuner.
8 Return (Exit)	Select to return to the previous menu or exit the menu.
9 Top Menu (Guide)	Select to display the top menu of the DVD player or Blu-ray Disc Player, etc or display the program guide of a TV, satellite tuner or hard disk recorder, etc.
10 Input	Select the input source of the components connected to the receiver.
11 Macro	Select to start a macro programmed with Quick Click.

10 key tab

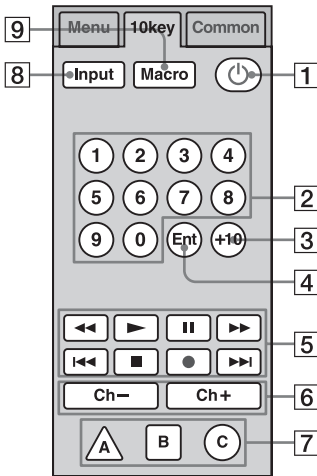

Button	Function
5	Select to start playback or to record. Select to stop or pause playback or recording. Select to fast-forward or fast-backward. Select to jump to the next/previous track.
6 Ch+/Ch-	Select Ch +/- to select the channel of the TV, satellite tuner, VCR, etc.
7 A/B/C	Select when you operate a cableTV tuner.
8 Input	Select the input source of components connected to the receiver.
9 Macro	Select to start a macro programmed with Quick Click.

Button	Function
1	Select to turn components connected to the receiver on or off.
2 10 key	Select to <ul style="list-style-type: none"> – select track numbers of the CD player, DVD player, Blu-ray Disc Player, or MD deck. – select channel numbers of the TV, Satellite tuner or the VCR.
3 +10 (.)	Select to <ul style="list-style-type: none"> – select track numbers over 10 of the CD player, DVD player, Blu-ray Disc Player, or MD deck. – select channel numbers over 10 of the TV, Satellite tuner or the VCR.
4 Ent	Press to enter the value after selecting a channel, disc or track using the numeric buttons.

Operating the TV, projector or lighting

To operate the TV, select (□) on Common tab

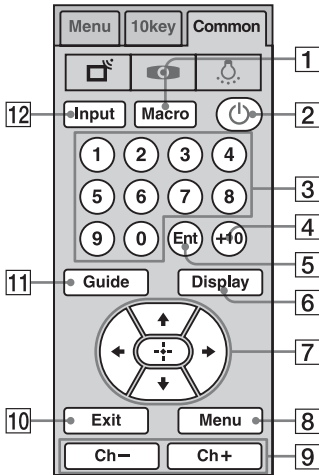



Button	Function
1 Macro	Select to start a macro programmed with Quick Click.
2	Select to turn components connected to the receiver on or off.
3 10 key	Select to select channel numbers of the TV, Satellite tuner or the VCR.
4 +10 (.)	Select to select channel numbers over 10 of the TV, Satellite tuner or the VCR.
5 Ent	Press to enter the value after selecting a channel, disc or track using the numeric buttons.
6 Display (Info)	Select to display the current status of or information on components connected to the receiver.
7	Select /// to select menu items. Then press to enter the selection.

Button	Function
8 Menu	Select to display the menu of the components connected to the receiver.
9 Ch+/Ch-	Select Ch +/- to select the channel of the TV, satellite tuner, VCR, etc.
10 Exit	Select to exit the menu.
11 Guide	Select to display the program guide of a TV, satellite tuner, hard disk recorder, etc.
12 Input	Select the input source of the components connected to the receiver.

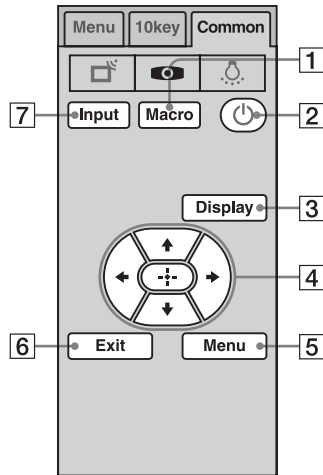
To operate the projector, select (👁) on Common tab



Button	Function
1 Macro	Select to start a macro programmed with Quick Click.
2	Select to turn components connected to the receiver on or off.
3 Display (Info)	Select to display the current status of or information on components connected to the receiver.

Button	Function
4 	Select  to select menu items. Then press  to enter the selection.
5 Menu	Select to display the menu of components connected to the receiver.
6 Exit	Select to exit the menu.
7 Input	Select the input source of the components connected to the receiver.

Button	Function
6 Toggle	Select to switch the preset lighting pattern.
7 Raise	Select to turn up the brightness of all the lights at the same time.
8 On	Select to turn on a single light.
9 All On	Select to turn up all the lights to maximum brightness.
10 Macro	Select to start a macro programmed with Quick Click.

To operate the lighting, select on Common tab

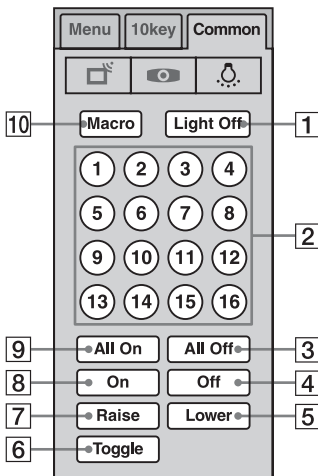

* A lighting control unit is a device which can adjust the brightness of two or more lights with a one-touch operation.
Consult your installation dealer about lighting control unit installation.

To make the on-screen remote disappear

Press QUICK CLICK or RETURN/EXIT .

Button	Function
1 Light Off	Select to turn off the power of the lighting control unit.*
2 Scene 1~16	Select to select a preset lighting pattern.
3 All Off	Select to turn down the brightness of all the lights to the minimum (putting out the lights).
4 Off	Select to turn off a single light.
5 Lower	Select to turn down the brightness of all the lights at the same time.

Setting components that are operated by the on-screen remote

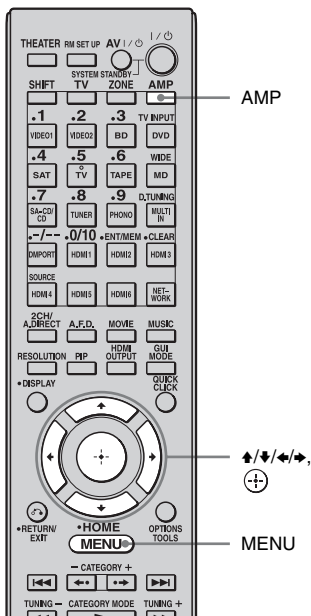

- 1 Press AMP.**
The receiver can be operated using the remote.
- 2 Press MENU.**
The menu is displayed on the TV screen.
- 3 Press \uparrow/\downarrow repeatedly to select “Settings,” then press \odot or \rightarrow .**
- 4 Press \uparrow/\downarrow repeatedly to select “Quick Click,” then press \odot or \rightarrow .**
- 5 Press \uparrow/\downarrow repeatedly to select “Source Component,” or “Common Component,” then press \odot .**

- 6 Press \uparrow/\downarrow repeatedly to select the component you want, then press \odot .**
- 7 Press \uparrow/\downarrow repeatedly to select “Preset Mode,” then press \odot .**
- 8 Press \uparrow/\downarrow repeatedly to select the input (including a TV) for the component you want to set up, then press \odot .**
- 9 Press \uparrow/\downarrow repeatedly to select the maker name, then press \odot .**
- 10 Press \uparrow/\downarrow repeatedly to select the code, then press \odot .**
If you want to have a test, select “Play” on the TV screen.
- 11 Press $\uparrow/\downarrow/\leftarrow/\rightarrow$ repeatedly to select “Finish,” then press \odot .**

To cancel the settings

Select “Cancel,” then press \odot in step 7.

The maker list of the corresponding component

TV

SONY	ABEX
ADMIRAL	ADVENT
ADVENTURA	AIWA
AKAI	A MARK
ANAM	AOC
APEX	ARCHER
AUDINAC	AUDIOVOX
BELL & HOWELL	BROKSONIC
CANDLE	CCE
CINERAL	CITIZEN
COBY	CRAIG
CROSLEX	CROWN
CTX	CURTIS MATHIS
DAEWOO	DAYTRON
DUKANE	DURABRAND

EMERSON	EMPREX
ESA	FISHER
FUJITSU	FUNAI
GE	GOLDSTAR
GRADIENTE	HAIER
HITACHI	HP
ILO	INSIGNIA
JANEIL	JC PENNEY
JENSEN	JVC
KLOSS	KLOSS NOVABEAM
KONKA	KTV
LG	LXI
MAGNAVOX	MARANTZ
MAXENT	MEGATRON
MEMOREX	MGA
MINUTZ	mitsubishi
MOTOROLA	NAD
NEC	NOBLEX
NORCENT	OLEVIA
OPTIMUS	OPTONICA
ORION	PANASONIC
PHILCO	PHILIPS
PIONEER	POLAROID
PORTLAND	PRINCETON
PROSCAN	PROTON
PROTRON	PROVIEW
QUASAR	RADIO SHACK
RCA	REALISTIC
RUNCO	SAMPO
SAMSUNG	SANSUI
SANYO	SCOTT
SEARS	SEMP TOSHIBA
SERIE DORADA	SHARP
SIGNATURE 2000	SOUNDESIGN
SPECTRICON	SUPREMACY
SVA	SYLVANIA
SYMPHONIC	SYNTAX BRILLIAN
TANDY	TATUNG
TECHWOOD	TEKNICA
TERA	TOSHIBA
TRUTECH	UNIVERSAL
VIDECH	VIEWSONIC
VIKING	VISCO
VIZIO	WARDS
WESTINGHOUSE	ZENITH
ZONDA	

Projector

SONY	EPSON
MITSUBISHI	OLYMPUS
OPTOMA	RUNCO
SHARP	

VCR

SONY	ADMIRAL
AIWA	AKAI
AUDIO DYNAMICS	BELL & HOWELL
BROKSONIC	CANON
CCE	CINERAL
CINEVISION	CITIZEN
CRAIG	CURTIS MATHIS
DAEWOO	DBX
DIMENSIA	EMERSON
FISHER	FUNAI
GE	GO VIDEO
GOLDSTAR	GRADIENTE
HITACHI	HQ
INSIGNIA	INSTANT REPLAY
JC PENNY	JVC
KENWOOD	LG
LITE-ON	LXI
MAGNAVOX	MARANTZ
MARTA	MEMOREX
MGA	MINOLTA
MITSUBISHI	MULTITECH
NEC	NOKIA
OLYMPIC	OPTIMUS
ORION	PANASONIC
PENTAX	PHILCO
PHILIPS	PIONEER
PROSCAN	QUASAR
RCA	REALISTIC
SAMSUNG	SANSUI
SANYO	SCOTT
SEARS	SEMP TOSHIBA
SENSORY SCIENCE	SHARP
SHINTOM	SIGNATURE 2000
SINGER	SYLVANIA
SYMPHONIC	TASHIRO
TATUNG	TEAC
TECHNICS	TOSHIBA
WARDS	YAMAHA
ZENITH	

BD/DVD player

SONY	ADVENT
AIWA	APEX
BROKSONIC	CINEVISION
CLASSIC	COBY
CYBER HOME	DAEWOO
DENON	EMERSON
FUNAI	GO VIDEO
GPX	HARMAN/KARDON
HITACHI	HUMAX
ILO	INSIGNIA
JVC	KENWOOD
KLH	KOSS
KRELL	LG
LITE-ON	MAGNAVOX
MARANTZ	MITSUBISHI
NORCENT TECHNOLOGY	ONKYO
OPTOMA	ORION
ORITRON	PANASONIC
PHILIPS	PIONEER
RCA	SAMSUNG
SANSUI	SANYO
SHARP	SHINCO
SYLVANIA	SYMPHONIC
TEAC	TERAPIN
THOMSON	TOSHIBA
YAMAHA	ZENITH

LD player

SONY	HITACHI
KENWOOD	MAGNAVOX
PANASONIC	PHILIPS
PIONEER	SANYO
SHARP	

CD player

SONY	ADMIRAL
AIWA	AKAI
B&O	CROWN
DAEWOO	DENON
EMERSON	FISHER
GOLDSTAR	HARMAN/KARDON
HITACHI	INSIGNIA
JENSEN	JVC
KENWOOD	LG
MAGNAVOX	MARANTZ

MCINTOSH	NAD
NAKAMICHI	ONKYO
OPTIMUS	PANASONIC
PHILIPS	PIONEER
RCA	SABA
SAMSUNG	SANSUI
SANYO	SCHNEIDER
SHARP	SHERWOOD
SOUNDESIGN	T+A
TECHNICS	TOSHIBA
YAMAHA	

MD deck

SONY	AIWA
AKAI	DENON
JVC	KENWOOD
MARANTZ	ONKYO
PANASONIC	PIONEER
SANSUI	SHARP
TEAC	YAMAHA

Cable box

SONY	ABC
ADELPHIA	ADVANCED NEWHOUSE
ALTRIO	AMERICAST
ATLANTIC BROADBAND	BELL SOUTH
BLUE RIDGE	BRIGHT HOUSE
CABLEVISION	CHARTER
COMCAST	COX
GENERAL INSTRUMENT	GNC
HAMLIN	ILLICO
JERROLD	MEMOREX
MOTOROLA	NET
OAK	PACE
PANASONIC	PARAGON
PHILIPS	PIONEER
PULSAR	REGAL
RODGERS	RUNCO
SCIENTIFIC ATLANTA	SEREN
SIGECOM	SUSQUEHANNA
TIME WARNER	TOCOM
TOSHIBA	VIDEOTRON
WIDEPENWEST	ZENITH

Satellite tuner (box)

SONY	CROSSDIGITAL
DIRECTV	DISH NETWORK
ECHOSTAR	GE
GENERAL INSTRUMENT	HITACHI
HUGHES	HUMAX
JVC	MAGNAVOX
MEMOREX	PANASONIC
PAYSAT	PHILIPS
PROSCAN	RCA
SAMSUNG	STAR SIGHT
SYLVANIA	TOSHIBA
UNIDEN	USDIGITAL

Lighting control

LUTRON(Grafik Eye)	LUTRON(HomeWorks)
LUTRON(RadioRA)	LUTRON(Sivoia Shades)
LUTRON(Spacer)	LUTRON(Spacer System)
X10	

Tape deck

SONY	AIWA
DENON	FISHER
GOLDSTAR	HARMAN/KARDON
JVC	KENWOOD
LG	MARANTZ
NAD	NAKAMICHI
ONKYO	PANASONIC
PHILIPS	PIONEER
RCA	SANSUI
SANYO	SHARP
TEAC	TECHNICS
YAMAHA	

Digital Video Recorder

SONY	HUMAX
LG	PANASONIC
PHILIPS	PIONEER
REPLAYTV	TIVO
TOSHIBA	

Performing several commands in sequence automatically with Quick Click (Macro Play)

You can use the macro function easily with Quick Click.

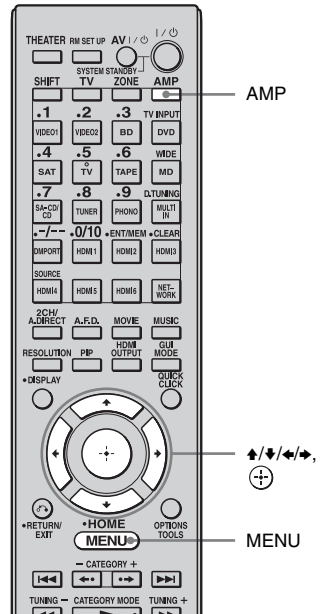

- 1 Press AMP.**
 The receiver can be operated using the remote.
- 2 Press MENU.**
 The menu is displayed on the TV screen.
- 3 Press \uparrow/\downarrow repeatedly to select “Settings,”** then press \oplus or \rightarrow .
- 4 Press \uparrow/\downarrow repeatedly to select “Quick Click,”** then press \oplus or \rightarrow .

- 5** Press **▲/▼** repeatedly to select “Macro Setup,” then press **⊕**.
- 6** Press **▲/▼** repeatedly to select the macro number for which you want to program the sequence of operation(s), then press **⊕**.
- 7** Press **▲/▼** repeatedly to select the step number you want to set, then press **⊕**.
- 8** Press **▲/▼** repeatedly to select the component you want, then press **➔**.
- 9** Press **▲/▼** repeatedly to select the key, then press **➔**.
- 10** Press **▲/▼** repeatedly to select the duration of time you want, then press **⊕**.
- 11** Repeat steps 7 to 10 when you want to program operations for other components.
- 12** Press **▲/▼** repeatedly to select the step interval time you want to set, then press **⊕**.
- 13** Press **▲/▼/◀/▶** repeatedly to select “Finish,” then press **⊕**.
The settings process is complete.

To cancel programming

Select “Cancel,” then press **⊕**.

Starting macro play

- 1** Press **AMP**.
The AMP button lights up, and then turns off.
- 2** Press **QUICK CLICK**.
The on-screen remote is displayed on the TV screen.
- 3** Press **▲/▼/◀/▶** to select **MACRO on on-screen remote**.
The macro list appears on the TV screen.
- 4** Press **▲/▼** to select the macro number you want to start.
The macro starts and executes the commands in the order you assigned them.

To input a macro name

- 1** Press **AMP**.
The receiver can be operated using the remote.
- 2** Press **MENU**.
The menu is displayed on the TV screen.
- 3** Press **▲/▼** repeatedly to select “**Settings**,” then press **⊕** or **➔**.
- 4** Press **▲/▼** repeatedly to select “Quick Click,” then press **⊕** or **➔**.
- 5** Press **▲/▼** repeatedly to select “Macro Setup,” then press **⊕**.
- 6** Press **OPTIONS**.
The option menu appears.
- 7** Press **▲/▼** repeatedly to select “Name Input,” then press **⊕**.
The soft keyboard appears on the TV screen.
- 8** Press **▲/▼/◀/▶** and **⊕** to select a character one by one.

- 9 Press $\uparrow/\downarrow/\leftarrow/\rightarrow$ to select “Finish,” then press \oplus .
The name you entered is registered.

To cancel naming input

Press $\uparrow/\downarrow/\leftarrow/\rightarrow$ to select “Cancel,” then press \oplus .

To erase a programmed macro

- 1 Press AMP.
The receiver can be operated using the remote.
- 2 Press MENU.
The menu is displayed on the TV screen.
- 3 Press \uparrow/\downarrow repeatedly to select “Settings,” then press \oplus or \rightarrow .
- 4 Press \uparrow/\downarrow repeatedly to select “Quick Click,” then press \oplus or \rightarrow .
- 5 Press \uparrow/\downarrow repeatedly to select “Macro Setup,” then press \oplus .
- 6 Press \uparrow/\downarrow repeatedly to select the macro number you want, then press \oplus .
- 7 Press \uparrow/\downarrow repeatedly to select the step number you want, then press \oplus .
- 8 Press \uparrow/\downarrow repeatedly to select “-” as a component name, then press \oplus .
- 9 Repeat steps 8 and 9 to clear the stored macro.
- 10 Press \uparrow/\downarrow repeatedly to select “Finish.”
Settings stored as a macro are cleared.

Setting remote control codes that are not stored in Quick Click

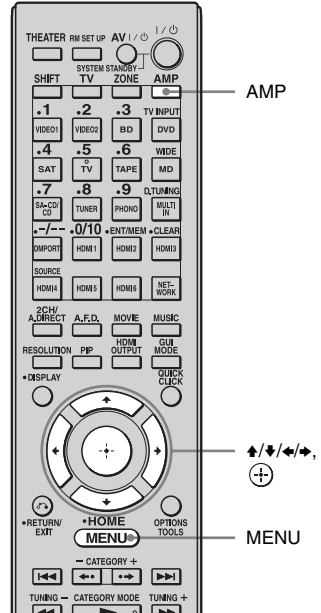

- 1 Press AMP.
The receiver can be operated using the remote.
- 2 Press MENU.
The menu is displayed on the TV screen.
- 3 Press \uparrow/\downarrow repeatedly to select “Settings,” then press \oplus or \rightarrow .
- 4 Press \uparrow/\downarrow repeatedly to select “Quick Click,” then press \oplus or \rightarrow .
- 5 Press \uparrow/\downarrow repeatedly to select “Source Component,” or “Common Component,” then press \oplus .

- 6** Press \uparrow/\downarrow repeatedly to select the component you want, then press \oplus .
- 7** Press \uparrow/\downarrow repeatedly to select “Learn Mode,” then press \oplus .
- 8** Press \uparrow/\downarrow repeatedly to select the code number you want to store as the new command, then press \oplus .
- 9** Keep pressing the corresponding button on the remote of the component to be programmed while pointing the remote towards the receiver’s remote sensor until “Complete” is displayed on the TV screen.

Remote sensor

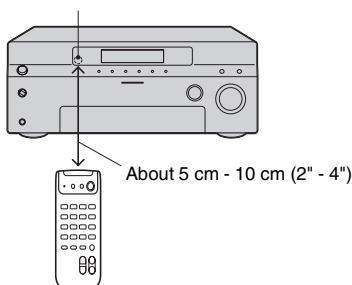

“Test” is selected automatically after few seconds when the registration of a new code is completed.

10 Press \oplus .

The operation test of the programmed code is started.

Proceed to step 11 if you will not perform the operation test.

11 Press $\uparrow/\downarrow/\leftarrow/\rightarrow$ repeatedly to select “Finish.”

Note

The display window is turned off while the receiver is registering the new code.

To cancel learning

Select “Cancel” on one of the screens displayed in step 8, 10 and 11, then press \oplus .

To use a command that has been learned

- 1** Press AMP.
The receiver can be operated using the remote.
- 2** Press MENU.
The menu is displayed on the TV screen.
- 3** Press \uparrow/\downarrow repeatedly to select “Input,” then press \oplus or \rightarrow .
- 4** Press \uparrow/\downarrow repeatedly to select the component you want, then press \oplus .
- 5** Press QUICK CLICK.
- 6** Press $\uparrow/\downarrow/\leftarrow/\rightarrow$ to select the button on the on-screen remote used to learn that function, then press \oplus .

Resetting the remote code for Quick Click

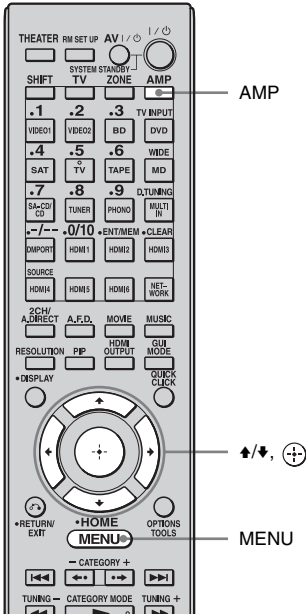

- 1 Press AMP.**
The receiver can be operated using the remote.
- 2 Press MENU.**
The menu is displayed on the TV screen.
- 3 Press \uparrow/\downarrow repeatedly to select “Settings,” then press \odot or \rightarrow .**
- 4 Press \uparrow/\downarrow repeatedly to select “Quick Click,” then press \odot or \rightarrow .**
- 5 Press \uparrow/\downarrow repeatedly to select “Source Component,” or “Common Component,” then press \odot .**

- 6 Press \uparrow/\downarrow repeatedly to select the component you want, then press \odot .**
- 7 Press \uparrow/\downarrow repeatedly to select “Reset,” then press \odot .**
The confirming message appears on the TV screen.
- 8 Press \uparrow/\downarrow repeatedly to select “Yes,” then press \odot .**
All the contents of the selected input (e.g., all the programmed data) are cleared.
- 9 Repeat steps 6 to 8 to clear all programmed data.**

Note
The macro itself is not cleared. A default code will be output when you have set a preset code or learned code in the macro step.

Glossary

■ Cinema Studio EX

A surround sound mode that can be regarded as the compilation of Digital Cinema Sound technology, delivers the sound of a dubbing theater using three technologies: “Virtual Multi Dimensions,” “Screen Depth Matching,” and “Cinema Studio Reverberation.” “Virtual Multi Dimensions,” the virtual speaker technology, creates a virtual multi-surround environment with actual speakers up to 7.1 channels, and brings the surround sound experience of a theater with the latest facilities into your home.

“Screen Depth Matching” reproduces treble attenuation, fullness, and depth of sound usually created in a theater using sound emission from behind the screen. This is then added to the front and center channels.

“Cinema Studio Reverberation” reproduces the sound characteristics of state-of-the-art dubbing theaters and recording studios, including Sony Pictures Entertainment’s dubbing studios. There are three modes, A/B/C, available according to the studio type.

■ Component video

A format for transmitting video signal information consisting of three separate signals: luminance Y, chrominance Pb, and chrominance Pr. High quality pictures, such as DVD video or HDTV pictures, are transmitted more faithfully. The three jacks are color-coded green, blue, and red.

■ Composite video

A standard format for transmitting video signal information. The luminance signal Y and chrominance signal C are combined and transmitted together.

■ Crossover frequency

The frequency at which two speaker’s frequencies intersect.

■ Deep Color

Video signals for which the color depth of signals passing through an HDMI jack have been raised.

The number of colors that could be expressed by 1 pixel was 24 bits (16,777,216 colors) with the current HDMI jack. However, the number of colors which can be expressed by 1 pixel will be 36, etc., bits when the receiver corresponds to Deep Color.

Since the gradation of the depth of a color can be expressed more finely with more bits, continuous color changes can be more smoothly expressed.

■ Digital Cinema Sound (DCS)

Unique sound reproduction technology for home theater developed by Sony, in cooperation with Sony Pictures Entertainment, for enjoying the exciting and powerful sound of movie theaters at home. With this “Digital Cinema Sound” developed by integrating a DSP (Digital Signal Processor) and measured data, the ideal sound field intended by filmmakers can be experienced at home.

■ Digital Concert Hall

“Digital Concert Hall” delivers richer sound for 2ch stereo sources such as CDs, etc. With the use of 5.1ch or 7.1ch speakers and virtual speaker technology, stereoscopic reverberation and reflected sound are reproduced, and music software can be enjoyed with richer sound and presence. The sound field in a concert hall is recreated by a geometrical analysis of the concert hall and precise modeling of reflected and reverberant sounds based on actual measured data. Tonal qualities such as sound strength and frequency response are taken into account and calculated on the DSP (Digital Signal Processor) to bring reverberation in. Sound is enjoyed with natural and comfortable resonance, as if listening to music in a concert hall.

■ Digital Legato Linear (D.L.L.)

This is Sony proprietary technology that allows low quality digital audio signals to be played back with high quality sound. Old recording or compressed audio often have noise on the waveform and out-of-frequency distortion, as well as harmonic distortion, in the audio frequency is generated. Therefore beat interference and ringing occur, and such phenomena degrade the sound quality. The D.L.L. feature eliminates these problems, and gives you rich sound for music and movies.

■ Dolby Digital

Digital audio encoding/decoding technology developed by Dolby Laboratories, Inc. It consists of front (left/right), center, surround (left/right) and subwoofer channels. It is a designated audio standard for DVD-video and also known as 5.1 channels surround.

■ Dolby Digital Plus

Dolby Digital Plus provides the flexibility and efficiency to deliver more channels of compelling surround sound for high-definition video media. Its superior coding efficiencies enable up to 7.1ch of high-quality multichannel audio without negatively impacting bit budgets allocated for video performance or additional feature sets.

■ Dolby Digital Surround EX

Acoustic technology developed by Dolby Laboratories, Inc. Surround back information is matrixed into regular left and right surround channels so that the sound can be reproduced in 6.1 channels. Active scenes, especially, are recreated with a more dynamic and realistic sound field.

■ Dolby Pro Logic II

This technology converts 2 channels stereo recorded audio into 5.1 channels for playback. Old movies encoded in the traditional stereo format can be enhanced with 5.1 channels surround sound.

■ Dolby Pro Logic IIx

Technology for 7.1 channels (or 6.1 channels) playback. Along with audio encoded in Dolby Digital Surround EX, 5.1 channels Dolby Digital encoded audio can be reproduced in 7.1 channels (or 6.1 channels). Furthermore, existing stereo recorded content can also be reproduced in 7.1 channels (or 6.1 channels).

■ Dolby Surround (Dolby Pro Logic)

Audio processing technology developed by Dolby Laboratories, Inc. Center and mono surround information is matrixed into two stereo channels. When reproduced, audio is decoded and output in 4 channels surround sound. This is the most common audio processing method for DVD-video.

■ Dolby TrueHD

Dolby TrueHD is Dolby's lossless audio technology developed for high-definition optical discs. Dolby TrueHD audio is bit-for-bit identical to the original studio masters and provides supreme-quality audio up to 8ch at 96 kHz/24 bit and up to 6ch at 192 kHz/24 bit. Together with high-definition video, it offers an unprecedented home theater experience.

■ DSD

Audio format used for a Super Audio CD. DSD converts analog signals to digital and records them directly, without adding any processing, so that no information is omitted. Recording and playback of high fidelity, quality sound is achieved.

■ DTS 96/24

A high sound quality digital signal format. It records audio at a sampling frequency and bit rate of 96 kHz/24 bit which is the highest possible for DVD-video. The number of playback channels varies depending on the software.

■ DTS Digital Surround

Digital audio encoding/decoding technology for theaters developed by DTS, Inc. It compresses audio less than Dolby Digital, delivering a higher quality sound reproduction.

■ DTS-ES

Format for 6.1 channels playback with surround back information. There are two modes, “Discrete 6.1” which records all channels independently, and “Matrix 6.1” which matrixes surround back channel into surround left and surround right channels. It is ideal for playback of motion picture soundtracks.

■ DTS-HD

Audio format which extends the conventional DTS Digital Surround format.

This format consists of a core and an extension, and the core part has DTS Digital Surround compatibility. There are two kinds of DTS-HD, DTS-HD High Resolution Audio and DTS-HD Master Audio. DTS-HD High Resolution Audio has a maximum transmission rate of 6 Mbps, with lossy compression (Lossy), and DTS-HD High Resolution Audio corresponds to a maximum sampling frequency of 96 kHz, and a maximum of 7.1 ch. DTS-HD Master Audio has a the maximum transmission rate of 24.5 Mbps, and uses lossless compression (Lossless), and DTS-HD Master Audio corresponds to a maximum sampling frequency of 192 kHz, and a maximum of 7.1 ch.

■ DTS Neo:6

This technology converts 2 channels stereo recorded audio for 7 channels playback. There are two modes to select according to the playback source or your preference, CINEMA for movies, and MUSIC for stereo sources such as music.

■ High quality digital Audio Transmission System (H.A.T.S.) for HDMI

H.A.T.S. for HDMI is a flow control playback system for HDMI transmission.

A master clock, important for audio quality, is provided by a crystal transmitter beside the DA converter of the receiver, and this master clock controls the playback speed of the components connected to the receiver using the HDMI CEC (Consumer Electronics Control) for HDMI (High-Definition Multimedia Interface) to match the playback rate. It gives you high quality sound with exceptional clarity, because, there is nearly no transmission jitter when transmitting the clock.

■ HDMI (High-Definition Multimedia Interface)

HDMI (High-Definition Multimedia Interface) is an interface that supports both video and audio on a single digital connection, allowing you to enjoy high quality digital picture and sound. The HDMI specification supports HDCP (High-bandwidth Digital Contents Protection), a copy protection technology that incorporates coding technology for digital video signals.

■ High Bitrate Audio

It refers to the audio formats of the compression method (DTS-HD Master Audio, Dolby TrueHD, etc.) which is a high bitrate format recorded mainly on Blu-ray Disc etc.

■ Interlace

A scanning method which completes a picture by displaying half of the lines on a tube surface of a TV or monitor each 1/60 second. First, all the odd-numbered lines are drawn, leaving spaces between each line, then all the even-numbered lines are drawn to fill the spaces. “i” of “480i” stands for “Interlace.”

■ L.F.E. (Low Frequency Effects)

Sound effects of low frequencies which are output from a subwoofer in Dolby Digital or DTS, etc. By adding a deep bass with a frequency between 20 to 120 Hz, audio becomes more powerful.

■ Neural THX

Neural Surround™, THX® Technologies has been chosen as the official surround sound broadcast format for XM Satellite Radio's "XM HD Surround" and other leading FM/HD radio stations in the USA and worldwide. Neural Surround, THX Technologies delivers the rich envelopment and discrete image detail of surround sound in a format 100% compatible with stereo.

■ PCM (Pulse Code Modulation)

A method of converting analog audio to digital audio for easy enjoyment of digital sound.

■ Progressive

A scanning method that draws all scanning lines sequentially, as opposed to interlaced scanning where all the odd and then all the even lines are drawn.

"p" of "480p" stands for "Progressive."

■ x.v.Color

"x.v.Color" enables the more faithful reproduction of various colors such as the brilliant colors of flowers and the turquoise blue of the southern ocean.

Precautions

On safety

Should any solid object or liquid fall into the cabinet, unplug the receiver and have it checked by qualified personnel before operating it any further.

On power sources

- Before operating the receiver, check that the operating voltage is identical with your local power supply.
The operating voltage is indicated on the nameplate on the back of the receiver.
- The unit is not disconnected from the AC power source (mains) as long as it is connected to the wall outlet, even if the unit itself has been turned off.
- If you are not going to use the receiver for a long time, be sure to disconnect the receiver from the wall outlet. To disconnect the AC power cord (mains lead), grasp the plug itself; never pull the cord.
- One blade of the plug is wider than the other for the purpose of safety and will fit into the wall outlet only one way. If you are unable to insert the plug fully into the outlet, contact your dealer.
- AC power cord (mains lead) must be changed only at a qualified service shop.

On heat buildup

Although the receiver heats up during operation, this is not a malfunction. If you continuously use this receiver at a large volume, the cabinet temperature of the top, side and bottom rises considerably. To avoid burning yourself, do not touch the cabinet.

On placement

- Place the receiver in a location with adequate ventilation to prevent heat buildup and prolong the life of the receiver.

- Do not place the receiver near heat sources, or in a place subject to direct sunlight, excessive dust, or mechanical shock.
- Do not place anything on top of the cabinet that might block the ventilation holes and cause malfunctions.
- Do not place the receiver near equipment such as a television, VCR, or tape deck. (If the receiver is being used in combination with a television, VCR, or tape deck, and is placed too close to that equipment, noise may result, and picture quality may suffer. This is especially likely when using an indoor antenna (aerial). Therefore, we recommend using an outdoor antenna (aerial).)

On operation

Before connecting other components, be sure to turn off and unplug the receiver.

On cleaning

Clean the cabinet, panel, and controls with a soft cloth slightly moistened with a mild detergent solution. Do not use any type of abrasive pad, scouring powder, or solvent, such as alcohol or benzine.

If you have any questions or problems concerning your receiver, please consult your nearest Sony dealer.

Troubleshooting

If you experience any of the following difficulties while using the receiver, use this troubleshooting guide to help you remedy the problem. Should any problem persist, consult your nearest Sony dealer.

Audio

There is no sound, no matter which component is selected, or only a very low-level sound is heard.

- Check that the speakers and components are connected securely.
- Check that all speaker cords are connected correctly.
- Check that both the receiver and all components are turned on.
- Check that MASTER VOLUME control is not set at $-\infty$ dB. Try to set it at about -40 dB.
- Check that SPEAKERS (OFF/A/B/A+B) is not set to OFF (page 48).
- Press MUTING on the remote to cancel the muting function.
- Check that you have selected the correct component with INPUT SELECTOR.
- Check that headphones are not connected.
- When only a very low-level sound is heard, check to see if Night Mode is activated (page 106).
- The protective device on the receiver has been activated. Turn off the receiver, eliminate the short-circuit problem, and turn on the power again.

There is no sound from a specific component.

- Check that the component is connected correctly to the audio input jacks for that component.
- Check that the cord(s) used for the connection is (are) fully inserted into the jacks on both the receiver and the component.

There is no sound from one of the front speakers.

- Connect a pair of headphones to the PHONES jack to verify that sound is output from the headphones. If only one channel is output from the headphones, the component may not be connected to the receiver correctly. Check that all the cords are fully inserted into the jacks on both the receiver and the component. If both channels are output from the headphones, the front speaker may not be connected to the receiver correctly. Check the connection of the front speaker which is not outputting any sound.
- Make sure you have connected both the L or R jack to an analog component and not just to either the L or R jack. Use a monaural-stereo cable (not supplied). However, there will be no sound from the center speaker when a sound field (Pro Logic, etc.) is selected. When the center speaker is not connected, sound is output only from the front left/right speakers.

There is no sound from analog 2 channel sources.

- Check to make sure the selected audio (digital) input jack is not assigned to other inputs in “Input Assign” in the Input menu (page 103).

There is no sound from digital sources (from COAXIAL or OPTICAL input jack).

- Check that the INPUT MODE is not set to “Analog.”
- Check that the “2ch Analog Direct” is not being used.
- Check to make sure the selected audio (digital) input jack is not assigned to other inputs in “Input Assign” in the Input menu (page 103).

The source sound input from the HDMI IN jack is not output from an amplifier or the TV speaker connected to the receiver.

- Check that the component is connected correctly to the HDMI IN jack for that component.
- Depending on the playback component, component may need to be set up. Refer to the operating instructions supplied with the each component.
- Be sure to use a connecting cable for the HDMI jack corresponding to high speed (an HDMI version 1.3a, category 2 cable) when you view images or listen to sound during a Deep Color transmission.

The left and right sounds are unbalanced or reversed.

- Check that the speakers and components are connected correctly and securely.
- Adjust the balance parameters using the Auto Calibration settings menu.

There is severe hum or noise.

- Check that the speakers and components are connected securely.
- Check that the connecting cords are away from a transformer or motor, and at least 10 feet (3 meters) away from a TV set or fluorescent light.
- Move your TV away from the audio components.
- Make sure you have grounded the \perp SIGNAL GND terminal (only when a turntable is connected).
- The plugs and jacks are dirty. Wipe them with a cloth slightly moistened with alcohol.

There is no sound, or only a very low-level sound is heard from the center/surround/surround back speakers.

- Select a “Cinema Studio EX” mode (page 84).
- Adjust the speaker level (page 115).

- Make sure the center/surround speaker (s) is (are) set to either “SMALL” or “LARGE.”

There is no sound from the surround back speakers.

- Some discs have no Dolby Digital Surround EX flag even though the packages have Dolby Digital Surround EX logos.

There is no sound from the subwoofer.

- Check that the subwoofer is connected correctly and securely.
- Make sure you have turned on your speaker.
- When all speakers are set to “LARGE” and “Neo:6 Cinema,” or “Neo:6 Music” is selected, there is no sound from the subwoofer.

The surround effect cannot be obtained.

- Make sure the sound field function is on (press MOVIE or MUSIC).
- Sound fields do not function only for signals with a sampling frequency of higher than 48 kHz.

Dolby Digital or DTS multi-channel sound is not reproduced.

- Check that the DVD, etc. you are playing is recorded in Dolby Digital or DTS format.
- When connecting the DVD player, etc., to the digital input jacks of this receiver, make sure the setting for the digital audio output of the connected component is available.

Recording cannot be carried out.

- Check that the components are connected correctly (page 28).
- Select the source component (page 58).

The MULTI CHANNEL DECODING lamp does not light up in blue.

- Check that the playback component is connected on a digital jack and the input is selected properly on this receiver.
- Check whether the input source of the software being played back corresponds to the multi-channel format.
- Check whether the setup on the playback component is set to multi-channel sound.
- Check to make sure the selected audio (digital) input jack is not assigned to other inputs in “Input Assign” in the Input menu (page 103).

There is no sound from the component connected to the DIGITAL MEDIA PORT adapter.

- Adjust the volume of this receiver.
- The DIGITAL MEDIA PORT adapter and/or component is not connected correctly. Turn off the receiver, then reconnect the DIGITAL MEDIA PORT adapter and/or component.
- Check the DIGITAL MEDIA PORT adapter and/or component device to make sure it supports this receiver.

Video

There is no picture or an unclear picture appears on the TV screen or monitor.

- Select the appropriate input on the receiver (page 58).
- Set your TV to the appropriate input mode.
- Move your TV away from the audio components.
- Assign the component video input correctly.
- The input signal should be same as input when you are up-converting an input signal with this receiver (page 41).

The image of the COMPONENT VIDEO OUT is corrupted.

- Video input signals other than 480p component are not received when signals are output from the VIDEO jack. Input 480i component video signals.
- When component input signals other than 480p are output, use the COMPONENT VIDEO OUT jack and set “Resolution” to “DIRECT.”

Images from the component connected to the HDMI jack are not output to the TV, are distorted, or are interrupted.

- Make sure that cables are correctly and securely connected to components.
- Depending on the playback component, component may need to be set up. Refer to the operating instructions supplied with the each component.
- Be sure to use a connecting cable for the HDMI jack corresponding to high speed (an HDMI version 1.3a, category 2 cable) when you view images or listen to sound during a Deep Color transmission.
- Images from the component connected to the HDMI jack may be distorted. In this case, set “Video Direct” to “ON” in the HDMI settings menu.
- Images or sound from the component connected to the HDMI jack may be interrupted when video signals are switched. In this case, set “Video Direct” to “ON” in the HDMI settings menu.

Recording cannot be carried out.

- Check that the components are connected correctly (page 33).
- Select the source component (page 58).

The GUI does not appear on the TV screen.

- Press GUI MODE to display “GUI MODE” on the display.
- Check the TV is connected correctly.

Images appear later than the associated sound is played when the HDMI input is selected.

- Depending on the component connected to the HDMI jack, or the source played back, images may appear later than the associated sound. In this case, set “Video Direct” to “ON” in the HDMI settings menu.

Tuner

The FM reception is poor.

- Use a 75-ohm coaxial cable (not supplied) to connect the receiver to an outdoor FM antenna (aerial) as shown on page 168. If you connect the receiver to an outdoor antenna (aerial), ground it against lightning. To prevent a gas explosion, do not connect the ground (earth) wire to a gas pipe.

Outdoor FM antenna (aerial)

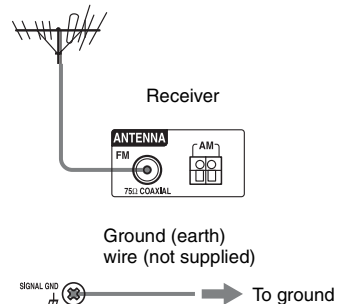

Radio stations cannot be tuned in.

- Check that the antennas (aerials) are connected securely. Adjust the antennas (aerials) and connect an external antenna (aerial), if necessary.
- Keep the satellite radio antenna, away from the speaker cords and the power cord to avoid picking up noise.
- The signal strength of the stations is too weak (when tuning in with automatic tuning). Use direct tuning.

- Make sure you set the tuning interval correctly (when tuning in AM stations with direct tuning).
- No stations have been preset or the preset stations have been cleared (when tuning by scanning preset stations). Preset the stations (page 67).
- Press DISPLAY so that the frequency appears on the display.

The system cannot receive satellite channels at all.

- The receiving condition is not good. Move the antenna to the place where the condition is good.
- Check that you subscribed to the desired satellite radio service (see page 68).

Control for HDMI

The Control for HDMI function does not work.

- Check the HDMI connection (page 34).
- Make sure “Control for HDMI” is set to “ON” in HDMI settings menu.
- Make sure the connected component is compatible with the Control for HDMI function.
- Check the Control for HDMI settings on the connected component. See the operating instructions of the connected component.
- If you change the HDMI connection, connect/disconnect the AC power cord, or there is a power failure, repeat the procedures of “Preparing for the “BRAVIA” Sync” (page 98).
- If you select HDMI B using the HDMI OUTPUT button, after you have selected HDMI A, the Control for HDMI function may not work properly for a while. This is because the component connected to the HDMI A jack must re-recognize the receiver that is equipped with the Control for HDMI function. If the Control for HDMI function does not work properly for a long time, perform the steps given in

“Preparing for the “BRAVIA” Sync” (page 98).

- When HDMI B is selected, the Control for HDMI function does not work.

No sound is output from the receiver and TV speaker while using the System Audio Control function.

- Make sure the TV is compatible with the System Audio Control function.
- If the TV does not have System Audio Control function, set the “Audio Out” settings in HDMI settings menu to
 - “TV+AMP” if you want to listen to the sound from the TV speaker and receiver.
 - “AMP” if you want to listen to the sound from the receiver.
- You cannot listen to the sound of a component connected to the receiver while a TV is selected as the input on the receiver.
 - Change the input of the receiver to HDMI when you want to watch a program on a component connected to the receiver.
 - Change the TV channel when you want to watch a TV broadcast.
 - Select the component or input you want to watch when you watch a program on the component connected to the TV. Refer to the operating instructions of the TV on this operation.
- When using the Control for HDMI function, you cannot control the connected component using TV’s remote.
 - Depending on the connected component and TV, you may need to set up the component and TV. Refer to the operation instructions supplied with each component and TV.
 - Change the input of the receiver to the HDMI input connected to the component.

Remote commander

The remote does not function.

- Point the remote at the remote sensor on the receiver.
- Remove any obstacles in the path between the remote and the receiver.
- Replace all the batteries in the remote with new ones, if they are weak.
- Make sure that the command modes of the receiver and the remote are the same. If the command mode of the receiver and the remote are different, you cannot operate the receiver with the remote (page 108).
- Make sure you select the correct input on the remote.
- When you operate a programmed non-Sony component, the remote may not function properly depending on the model and the maker of the component.

Error messages

If there is a malfunction, the display shows a code of two numbers and a message. You can check the condition of the system by the message. Refer to the following table to solve the problem. If any problem persists, consult your nearest Sony dealer.

PROTECTOR

Irregular current is output to the speakers, or the upper panel of the receiver is covered with something. The receiver will automatically turn off after a few seconds. Check the connection of speakers and turn on the power again.

For other messages, refer to “Message list after auto calibration measurement” (page 53), “XM Radio message list” (page 76), “SIRIUS Satellite Radio message list” (page 76) and “DIGITAL MEDIA PORT message list” (page 63).

Reference sections for clearing the memory

To clear	See
All memorized settings	page 44

Specifications

AUDIO POWER SPECIFICATIONS

POWER OUTPUT AND TOTAL HARMONIC DISTORTION:

With 8 ohm loads, both channels driven, from 20 – 20,000 Hz; rated 120 watts per channel minimum RMS power, with no more than 0.09% total harmonic distortion from 250 milliwatts to rated output.

Amplifier section

POWER OUTPUT

Rated Power Output at Stereo Mode¹⁾²⁾
(8 ohms 20 Hz – 20 kHz,
THD 0.09%):
130 W + 130 W

Reference Power Output at Stereo Mode
(4 ohms 20 Hz – 20 kHz,
THD 0.15%):
130 W + 130 W

Reference Power Output
(8 ohms 1 kHz, THD 0.7%)
FRONT²⁾:
140 W + 140 W
CENTER²⁾: 140 W
SURROUND²⁾:
140 W + 140 W
SURROUND BACK²⁾:
140 W + 140 W

Reference Power Output
(4 ohms 1 kHz, THD 0.7%)
FRONT²⁾:
130 W + 130 W
CENTER²⁾: 130 W
SURROUND²⁾:
130 W + 130 W
SURROUND BACK²⁾:
130 W + 130 W

¹⁾Depending on the sound field settings and the source, there may be no sound output.

²⁾Measured under the following conditions:
Power requirements: 120 V AC, 60 Hz

Frequency response

PHONO	RIAA equalization curve ± 0.5 dB
-------	----------------------------------

MULTI CHANNEL INPUT, SA-CD/CD, TAPE, MD, TV, VIDEO 1/2, BD, DVD, SAT	10 Hz – 100 kHz ± 3 dB
--	------------------------

Inputs (Analog)

PHONO	Sensitivity: 2.5 mV Impedance: 50 kohms S/N: 90 dB (A, 20 kHz LPF)
-------	--

MULTI CHANNEL INPUT, SA-CD/CD, TAPE, MD, TV, VIDEO 1/2, BD, DVD, SAT	Sensitivity: 150 mV Impedance: 50 kohms S/N: 100 dB (A, 20 kHz LPF)
--	---

Inputs (Digital)

BD, DVD, SA-CD/CD (Coaxial)	Impedance: 75 ohms S/N: 96 dB (A, 20 kHz LPF)
-----------------------------	--

VIDEO 1/2, TV, SAT, TAPE, MD (Optical)	S/N: 96 dB (A, 20 kHz LPF)
--	----------------------------

Outputs

TAPE (REC OUT), MD (REC OUT), VIDEO 1, ZONE 2, ZONE 3 (AUDIO OUT)	Voltage: 150 mV Impedance: 1 kohm
---	--------------------------------------

FRONT L/R, CENTER, SURROUND L/R, SURROUND BACK L/R, SUBWOOFER	Voltage: 2 V Impedance: 1 kohm
---	-----------------------------------

FM tuner section

Tuning range	87.5 – 108.0 MHz
Antenna (aerial)	FM wire antenna (aerial)
Antenna (aerial) terminals	75 ohms, unbalanced

AM tuner section

Tuning scale	10 kHz step	9 kHz step
Tuning range	530 – 1,710 kHz	531 – 1,710 kHz

Intermediate frequency

450 kHz

Antenna (aerial)

Loop antenna (aerial)

Video section

Inputs/Outputs

Video: 1 V_{p-p}, 75 ohms

COMPONENT VIDEO:

Y: 1 V_{p-p}, 75 ohms

P_B/C_B: 0.7 V_{p-p}, 75 ohms

P_R/C_R: 0.7 V_{p-p}, 75 ohms

80 MHz HD Pass Through

HDMI Video

Input/Output (HDMI Repeater block)

640 × 480p@60 Hz

720 × 480p@59.94/60 Hz

1280 × 720p@59.94/60 Hz

1920 × 1080i@59.94/60 Hz

1920 × 1080p@59.94/60 Hz

720 × 576p@50 Hz

1280 × 720p@50 Hz

1920 × 1080i@50 Hz

1920 × 1080p@50 Hz

1920 × 1080p@24 Hz

General

Power requirements 120 V AC, 60 Hz

Power output (DIGITAL MEDIA PORT)

DC OUT:5 V, 700 mA

Power output (ZONE 2 VIDEO OUT)

DC OUT:11 V, 30 mA

Power consumption 480 W/580 VA

Power consumption (during standby mode)

0.9 W (when “Control for

HDMI” and “RS-232C

Control” are set to “OFF”)

Dimensions

430 × 175 × 430 mm

(17 × 6 ⁷/₈ × 17 inches)

(width/height/depth)

including projecting parts
and controls

Mass (Approx.)

17.5 kg (38 lb 10 oz)

Supplied accessories

Operating Instructions (this manual)

Using Network Features (1)

Quick Setup Guide (1)

GUI Menu List (1)

Optimizer microphone ECM-AC1 (1)

FM wire antenna (aerial) (1)

AM loop antenna (aerial) (1)

AC power cord (mains lead) (1)

Main remote commander (1)

Zone 2/ Zone 3 remote commander (1)

R6 (size-AA) batteries (4)

IR Blaster (1)

ES Utility CD-ROM (1)

Design and specifications are subject to
change without notice.



- Standby power consumption 0.9 W.
- Halogenated flame retardants are not used in the printed wiring boards.

Index

Symbols

⌚ SIGNAL GND terminal 32

Numerics

2 channel 78
2ch Analog Direct 78
2ch Stereo Mode 78
4 Ω 47
5.1 channel 22
7.1 channel 22
8 Ω 47

A

A.F.D. (mode) 79
A/V Sync 60, 121, 132
AC power cord 44
AM 65
Antenna Aiming 71
Audio 121
AUDIO OUT 133
Audio Out 126
Auto Calibration 48, 112, 130
Auto Tuning 65

B

Bass 10, 119, 132
BI-AMP 114, 131
Bi-amplifier connection 109
Blu-ray Disc Player 35, 38, 58

C

Calibration Type Select 52, 130
Category Mode 72
CD player 29, 32
Center Mix 114, 131
Changing the display 133
Cinema Studio EX (mode) 84
Clear
 memory 44
 remote 144
Connections
 antennas 43
 audio components 28

 monitor 26
 speakers 24
 video components 33
Control for HDMI 126
Crossover Freq 116, 131

D

D. Range Comp (Dynamic range compressor)
 117, 130
DCAC (Digital Cinema Auto Calibration) 48
DCS 84
Decode Priority 122, 132
DIGITAL MEDIA PORT 15, 29, 60
Direct Tuning 66, 72
Display 11
Distance Unit 118, 131
DMPORT Control 63
Dolby Digital EX 86
DTS Neo:6 (Cinema, Music) 80
Dual Mono 122, 132
DVD player 35, 38
DVD recorder 40

E

Effect Level 118, 132
EQ 119

F

FM 65
FM Mode 65, 132

G

GUI (Graphical User Interface) 26, 45

H

HDMI 126
HDMI AUTO DETECT 100
HDMI IN button 9, 44
HDMI jacks 15, 34
HDMI OUT button 9, 101

I

Input 58
Input Assign 59, 103
INPUT MODE 102
iPod 62, 64

L

L.F.E. (Low Frequency Effect) 13
LARGE 115
Level 119
Lock Code 75, 132

M

MASTER VOLUME 9
Menu 45, 55, 111
Messages
 Auto Calibration 53
 DIGITAL MEDIA PORT 63
 Error 170
 SIRIUS 76
 XM 76
Movie 84
Multi Zone 88, 120
Music 61, 82
Muting 59

N

Name Input 59, 67, 113
Neural-THX 80
Night Mode 106, 122, 132

O

Option menu 56

P

Parental Lock 74, 132
Party Mode 96
Phase Audio 117, 130
Phase Noise 116, 130
PHONES 9
PIP (Picture in Picture) 19
PLII 80
PLIIx 80
Position (Auto Calibration) 112, 130
Preset channels 73
Preset Mode 74

Preset stations 67
PROTECTOR 170

Q

Quick Click 145
Quick Setup 50

R

Radio ID 71
Recording 107
Remote 17–21, 45, 134–144
Repeat 63
Resetting 44
Resolution 123, 132
RS-232C Control 128, 133

S

Satellite radio 68
Screen Saver 128
Setting menu 111
Settings 111
Shuffle 63
SIRIUS 68
SIRIUS Satellite Radio 69
Sleep timer 105
SMALL 115
Sound Field 59
Speaker 114
Speaker Impedance 46, 131
Speaker Pattern 114, 131
SPEAKERS (OFF/A/B/A+B) 9, 48
Subwoofer Level 126, 133
Super Audio CD player 29, 31, 32
Sur Settings 132
Surround 80, 118
System 128

T

Test Tone 116, 130
TONE MODE 44
Treble 10, 119, 132
Tuner 65
Tuning 65, 66, 67

U

Up converting 41

V

VCR 40

Video 61, 123

VIDEO 2 IN/PORTABLE AV IN jacks 41

X

XM 68

XM Radio 68

Z

Zone 12V Trigger 120, 133

ZONE 2 114