

SONY®



# Public Displays

[sony.com/publicdisplays](http://sony.com/publicdisplays)

# Bringing a New Level of Quality, Versatility, and Reliability into Public Displays



Ruggedized Model  
GXD-L52H1



Slim-bezel Model  
FWD-S47H1



Slim-bezel Model  
FWD-S42H1



Based on decades of expertise in professional display technology and today's stunning advancements in LCD panel technology - which has seen the introduction of 1080 Full HD (high-definition) television systems to both the professional and consumer markets - Sony provides a range of public display products to fulfill customers' different demands.

Four product ranges are available to suit different applications, locations, and operational needs. The ruggedized models are extremely robust, durable, and reliable, extending installation opportunities to even more harsh environments.

The slim-bezel models are highly sophisticated and stylish, and look good in any installation location, offering a sleek appearance for digital signage audiences.

The basic models offer amazing quality-per-cost balance for digital signage applications.

And finally, the all-in-one models offer both cost efficiency and high performance in a wide range of visual communication applications thanks to their built-in stand and speakers.

This variety of product choices, coupled with the outstanding features and functionality only available from Sony, brings a new level of quality, versatility, and reliability into professional public display applications.



Basic Model  
FWD-40LX2F



Basic Model  
FWD-32LX2F



All-in-one Model  
KLH-40X1



All-in-one Model  
KLH-W32



# LINEUP

---

Ruggedized Model

## GXD-L52H1

52-inch 1080 Full HD LCD Public Display



GXD-L52H1

### A New Level of Robustness for 1080 Full HD Digital Signage

Sony's ruggedized LCD public display is extremely robust, durable, and reliable, extending installation opportunities to even more harsh environments.

The 52-inch\* GXD-L52H1 LCD public display offers excellent picture quality in Full HD (1920 x 1080) resolution. In addition, it offers a range of features and functionality that system integrators demand. Combining an aluminum frame bezel and an LCD protection panel made of tempered glass, the GXD-L52H1 is extremely robust and durable. It has a unique cooling system that circulates air inside the unit and dissipates the heat generated through its advanced heat sinks. This eliminates the need for ventilation holes, which can often let in dust that causes mechanical failure. Plus, Sony's original backlight system eliminates the common problem of a complete display failure when just a single cold cathode fluorescent lamp (CCFL) malfunctions.

With all the unique features and functionality of Sony's professional public displays, the GXD-L52H1 offers dynamic and brilliant Full HD digital signage in locations ranging from retail shops, enterprises, schools, and hospitals to shopping mall entrances, train stations, and factories.

\*Viewable area, measured diagonally.

#### Main Features

---

- 1080 Full HD - High Resolution of 1920 x 1080
- 1080p Capable - Top-quality HD Images by 1080 Progressive Scan
- Robust Aluminum Frame Bezel
- Impact Resistant Front Panel - Protects the surface from being damaged
- Unique Cooling System - IP30-rated Dust Resistant Design
- Digital Signage System with the VSP-NS7 Network Player or the BKM-FW50 Digital Signage Adaptor
- Exchangeable Front Panel
- Intelligent Backlight System - Fail-safe Design by Advanced CCFL Control
- Portrait Mode - Mounted Vertically

#### Other Features

---

- High-performance Scalar
- HDMI™ (High Definition Multimedia Interface™) Input
- DVI/HDCP Input
- HD-SDI Input (optional)
- RS-232C and Control S (optional)
- Network Port
- Option Slot
- Picture-in-Picture
- Picture-and-Picture
- Multi-display
- On/Off Timer
- Conference Mode
- Control Panel Lock
- Illumination of Sony Logo
- Control via a Network
- Monitoring via a Network

### Slim-bezel Model

# FWD-S47H1

47-inch 1080 Full HD LCD Public Display

# FWD-S42H1

42-inch 1080 Full HD LCD Public Display



FWD-S47H1



FWD-S42H1

## High Sophistication and Style for 1080 Full HD Digital Signage

Sony's slim-bezel models are highly sophisticated and stylish, and look good in any installation location, offering a sleek appearance for digital signage audiences.

Incorporating a high-quality, professional 47-inch\* and 42-inch\* LCD panel, respectively, the FWD-S47H1 and FWD-S42H1 LCD public displays offer excellent picture quality in Full HD (1920 x 1080) resolution and high brightness of 700 cd/m<sup>2</sup> (typical).

These models support a variety of analog interfaces for video, audio, and computer signals, and also a DVI/HDCP digital interface, as standard.

In addition, they are equipped with a network port for remote control and monitoring.

Furthermore, an option slot is available to accept a range of optional adaptors for the versatility of the display.

Sony's slim-bezel professional public displays provide brilliant and dynamic digital signage that attracts invaluable customers with impressive Full HD visuals in locations ranging from enterprises, hospitals, and schools to retail shops and shopping malls.

\* Viewable area, measured diagonally.

### Main Features

- 1080 Full HD - High Resolution of 1920 x 1080
- 1080p Capable - Top-quality HD Images by 1080 Progressive Scan
- High Brightness of 700 cd/m<sup>2</sup> (typical) - Allowing for Use in Bright Light Conditions
- DICOM Gamma - Allows for Simple Picture Viewing in Medical Applications
- Highly Sophisticated and Stylish Slim-bezel Design - Ideal for Wall-mount Applications Using a Multi-display Function
- Digital Signage System with the VSP-NS7 Network Player or the BKM-FW50 Digital Signage Adaptor
- Portrait Mode - Mounted Vertically

### Other Features

- High-performance Scalar
- HDMI Input (optional)
- DVI/HDCP Input
- HD-SDI Input (optional)
- RS-232C and Control S (optional)
- Network Port
- Option Slot
- Picture-in-Picture
- Picture-and-Picture
- On/Off Timer
- Conference Mode
- Control Panel Lock
- Illumination of Sony Logo
- Control via a Network
- Monitoring via a Network

# LINEUP

---

## Basic Model

### FWD-40LX2F

40-inch WXGA LCD Public Display

### FWD-32LX2F

32-inch WXGA LCD Public Display



FWD-40LX2F



FWD-32LX2F

## Perfect for High-quality, Cost-efficient Digital Signage

Sony's basic LCD public display models offer a great quality-per-cost balance for digital signage applications.

The FWD-40LX2F and FWD-32LX2F LCD public displays incorporate a high-quality, professional 40-inch\* and 32-inch\* LCD panel, respectively, which offer superb picture quality in WXGA resolution. Both models support an HD15 analog interface and two HDMI or DVI/HDCP digital interfaces, as standard. In addition, they are pre-installed with a BKM-FW10 Video Input Adaptor and a monitor control adaptor in their option slots to accept a variety of analog video and audio signals, and they also offer external control capabilities via RS-232C and Control S interfaces. If required, these adaptors can be swapped with a range of optional adaptors.

Furthermore, these displays offer versatile features ideal for digital signage applications, such as picture-and-picture and multi-display functions, and portrait mode.

Sony's basic professional public display models can be widely used in digital signage applications thanks to their outstanding display performance and cost-efficiency.

\*Viewable area, measured diagonally.

### Main Features

---

- Two HDMI or DVI/HDCP Input - High-quality Digital Interface
- RS-232C and Control S
- Picture-and-Picture - Two Pictures Side by Side
- Multi-display - up to 16 Display Units
- Portrait Mode - Mounted Vertically
- Digital Signage System with the VSP-NS7 Network Player or the BKM-FW50 Digital Signage Adaptor

### Other Features

---

- WXGA
- High-performance Scalar
- BBE® and SRS WOW® High-quality Sound
- Network Port (optional)
- Option Slots
- On/Off Timer
- Control Panel Lock
- Special Hotel Menu
- Control via a Network (optional)
- Monitoring via a Network (optional)

## All-in-one Model

# KLH-40X1

40-inch WXGA LCD Public Display

# KLH-W32

32-inch WXGA LCD Public Display



KLH-40X1



KLH-W32

## Simple, Affordable, Dynamic Visual Communications Are Here

Incorporating a display stand and stereo speakers into a compact and stylish body, Sony's all-in-one LCD public displays offer both cost efficiency and high performance for a wide range of visual communication applications.

The KLH-40X1 and KLH-W32 incorporate a high-quality WXGA 40-inch\* and 32-inch\* LCD panel, respectively, to offer superb picture quality.

As standard, they support an HD15 analog interface and two HDMI or DVI/HDCP digital interfaces. The KLH-40X1 also accepts a variety of analog video and audio signals, and offers external control capabilities via RS-232C and Control S interfaces, as standard - satisfying customer demands for various video sources and device control.

The KLH-W32 is equipped with an option slot to support a range of optional adaptors, further enhancing the versatility of the display.

Sony's all-in-one professional public displays offer simple, affordable, yet extremely attractive visual communications for locations ranging from retail shops and enterprises to hospitality venues.

\*Viewable area, measured diagonally.

### Main Features

- All-in-one Design - Built-in Display Stand and Stereo Speakers
- HDMI or DVI/HDCP Input - High-quality Digital Interface
- RS-232C and Control S  
(standard for KLH-40X1 and optional for KLH-W32)
- Picture-and-Picture - Two Pictures Side by Side (KLH-40X1 only)
- BBE and SRS WOW High-quality Sound

### Other Features

- WXGA
- High-performance Scalar
- On/Off Timer (KLH-40X1 only)
- Sleep Timer (KLH-W32 only)
- Control Panel Lock (KLH-40X1 only)
- Special Hotel Menu
- Digital Signage System with the VSP-NS7 Network Player
- Digital Signage System with the BKM-FW50 Digital Signage Adaptor\*

\* For use of the BKM-FW50, please contact your nearest Sony office or authorized dealer.



# FEATURE COMPARISON

Sony's range of public displays offers high-quality images and sound, and the wide variety of features and functionality that professionals demand.

	Ruggedized Model	Slim-bezel Model		Basic Model		All-in-one Model	
	GXD-L52H1	FWD-S47H1	FWD-S42H1	FWD-40LX2F	FWD-32LX2F	KLH-40X1	KLH-W32
<b>High-quality Image and Sound</b>							
Panel Size (diagonal)	52-inch*1	47-inch*1	42-inch*1	40-inch*1	32-inch*1	40-inch*1	32-inch*1
1080 Full HD	●	●	●				
1080p Capable	●	●	●				
WXGA				●	●	●	●
High Brightness of 700 cd/m <sup>2</sup> (Typical)		●	●				
DICOM Gamma		●	●				
High-performance Scalar	●	●	●	●	●	●	●
BBE and SRS WOW High-quality Sound				●	●	●	●
<b>Flexibility and Reliability</b>							
Robust Aluminum Frame Bezel	●						
Impact Resistant Front Panel	●						
Unique Cooling System - IP30-rated Dust Resistant Design	●						
Slim-bezel Design		●	●				
All-in-one Design						●	●
Digital Signage System with the VSP-NS7	●	●	●	●	●	●	●
Digital Signage System with the BKM-FW50	●	●	●	●	●	▲*5	▲*5
<b>Interface Versatility</b>							
HDMI Input	x1	x1*2	x1*2	x2*3	x2*3	x2*3	x2*3
DVI/HDCP Input	x1						
HD-SDI Input	Optional	Optional	Optional				
RS-232C and Control S	Optional	Optional	Optional	●	●	●	Optional
Network Port	●	●	●	Optional	Optional		
Option Slots	x1	x1	x1	x2*4	x2*4		x1
<b>Operational Convenience</b>							
Picture-in-Picture	●	●	●				
Picture-and-Picture	●	●	●	●	●	●	
Multi-display	●	●	●	●	●		
Portrait Mode	●	●	●	●	●		
Illumination of Sony Logo	●	●	●				
On/Off Timer	●	●	●	●	●	●	
Sleep Timer							●
Conference Mode	●	●	●				
Control Panel Lock	●	●	●	●	●	●	
Special Hotel Menu				●	●	●	●
<b>Easy Operation and Maintenance</b>							
Exchangeable Front Panel	●						
Control via a Network	●	●	●	Optional	Optional		
Monitoring via a Network	●	●	●	Optional	Optional		
Intelligent Backlight System	●						

\*1 Viewable area, measured diagonally.

\*2 The display is equipped with a DVI connector to accept video signals from DVI-based devices. This connector can also accept video signals from HDMI-based devices via a DVI-to-HDMI cable, but cannot accept audio signals.

\*3 The display is equipped with an HDMI connector to accept video and audio signals from HDMI-based devices. This connector can also accept video signals from DVI-based devices via an HDMI-to-DVI cable.

\*4 The option slots are pre-installed with a BKM-FW10 Video Input Adaptor and a monitor control adaptor.

\*5 For use of the BKM-FW50, please contact your nearest Sony office or authorized dealer.



## High-quality Image and Sound

### 1080 Full HD

**GXD-L52H1** **FWD-S47H1** **FWD-S42H1**

The display incorporates a newly developed professional Full HD LCD panel with a 16:9 aspect ratio. This high-quality LCD panel offers excellent picture quality thanks to a native resolution of 1920 x 1080.

### 1080p Capable

**GXD-L52H1** **FWD-S47H1** **FWD-S42H1**

The display offers 1080p (progressive scan) images at 60 frames per second and 50 frames per second, which are top-quality images in HD formats. These 1080p signals can be input via HDMI and component/RGB connectors.

### WXGA

**FWD-40LX2F** **FWD-32LX2F** **KLH-40X1** **KLH-W32**

The display incorporates a high-quality LCD panel with a resolution of WXGA (1360 x 768), offering extremely high-quality images.

### High Brightness of 700 cd/m<sup>2</sup> (Typical)

**FWD-S47H1** **FWD-S42H1**

The display offers a high brightness of 700 cd/m<sup>2</sup> (typical), allowing for use in bright light conditions.

### DICOM Gamma

**FWD-S47H1** **FWD-S42H1**

The display can select a gamma curve compliant with the DICOM (Digital Imaging and Communication in Medicine) GSDF (Greyscale Standard Display Function) standard. With this gamma setting, the display can be used for simple picture viewing in medical applications such as conferences and education.

## High-performance Scalar

**GXD-L52H1** **FWD-S47H1** **FWD-S42H1** **FWD-40LX2F** **FWD-32LX2F**

**KLH-40X1** **KLH-W32**

The display integrates a high-performance scalar that can provide accurate pixel-by-pixel image reproduction, offering optimum image quality whatever the signal format.

## BBE and SRS WOW High-quality Sound

**FWD-40LX2F** **FWD-32LX2F** **KLH-40X1** **KLH-W32**

The display can provide high-quality sound, thanks to BBE and SRS WOW technologies.



## Flexibility and Reliability

### Robust Aluminum Frame Bezel

**GXD-L52H1**

The adoption of an aluminum frame bezel makes the display extremely robust, and provides a classic, sophisticated appearance.

### Impact Resistant Front Panel

**GXD-L52H1**

The display is equipped with a protection panel made of tempered glass that is situated in front of the LCD panel to protect the surface from being damaged. In addition, anti-reflection (AR) coating on the glass protection panel reduces light reflection for clear, high-contrast picture viewing.

# GLOSSARY

## Unique Cooling System - IP30-rated Dust Resistant Design

**GXD-L52H1**

The display adopts a unique cooling system that increases its reliability and versatility. Whereas conventional systems bring cold air in from outside to cool the unit, and then feed warm air back out, the display adopting this system uses multiple fans to circulate air inside the processor unit, so that all heat generated in the unit is effectively dissipated through advanced heat sinks situated at the rear of the display. Because the unit is completely sealed from external air and there are no air intake filters to be cleaned, the life of the LCD display is greatly extended. This allows the display to be deployed in environments where dust can be a concern (IP30 rated) - such as train stations, shopping mall entrances, and factories - where conventional displays can often malfunction due to a build-up of dust on their cooling fans. This feature also opens up additional installation opportunities. For example, the display can be tilted - something that is not possible with conventional displays, as tilting reduces the suction efficiency needed for effective cooling.

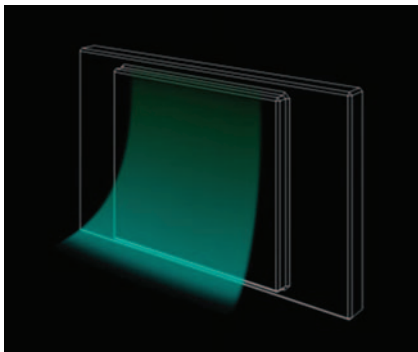

Conventional System

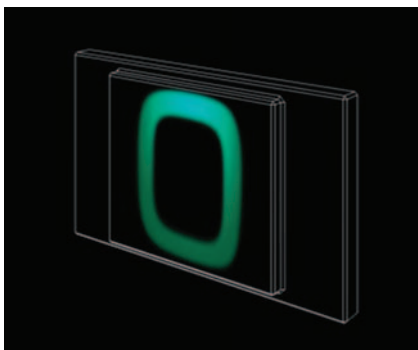

Sony System

### FEATURE COMPARISON

## Slim-bezel Design

**FWD-S47H1 FWD-S42H1**

The adoption of a slim-bezel design with a bezel width of just 19 mm (0.75 inches) makes the display look very sophisticated and stylish. This is ideal for wall-mount applications using a multi-display function, because the slim bezels are less conspicuous when one large image is presented across multiple display units.



Simulated Image  
The illumination of Sony logo can be turned off.

## All-in-one Design

**KLH-40X1 KLH-W32**

The display comes with a built-in display stand and built-in stereo speakers. This compact and stylish all-in-one design allows the display to fit well in any installation location.

## Digital Signage System with the VSP-NS7 Digital Signage Player

GXD-L52H1 FWD-S47H1 FWD-S42H1 FWD-40LX2F FWD-32LX2F  
KLH-40X1 KLH-W32

The VSP-NS7 Digital Signage Player incorporates a high-capacity HDD of 120 GB and offers a variety of features and functionality for digital signage applications.

The versatile VSP-NS7 can receive content of up to five image layers, including graphics, video, and text, from a PC via a network, store them on its HDD, and present them on the screen of the connected display. It can also accept live streaming video and audio from a Sony SNC-RZ50N/RZ50P network camera, which can be played out with other content layers. Furthermore, an extra audio channel is available for playout of music and narration independent of the playlist.

The VSP-NS7 allows operators to control a number of settings and functions of the connected display. These include power ON/OFF, input selection, picture mode selection, and audio level settings, and a picture-in-picture function (GXD-L52H1 / FWD-S47H1 / FWD-S42H1 only).

The user-friendly VSPA-D7 Digital Signage Player Management Software (sold separately and required for operation) makes managing the VSP-NS7 extremely easy. From content management to authoring, and scheduling to distribution, the operation of this software application was created with the most effective workflow in mind.

With the combination of the VSP-NS7 and a display, it is possible to create a simple, yet highly advanced digital signage system.

## Digital Signage System with the BKM-FW50 Digital Signage Adaptor

GXD-L52H1 FWD-S47H1 FWD-S42H1 FWD-40LX2F FWD-32LX2F  
KLH-40X1 KLH-W32

The BKM-FW50 Digital Signage Adaptor is equipped with a slot for a CompactFlash memory card. Attaching the BKM-FW50 to the option slot of a display creates a very simple and easy-to-use digital signage system.

This system offers the following functions:

- The display will play out still images automatically and sequentially from a CompactFlash memory card (sold separately) inserted to the memory card slot of the BKM-FW50. This allows for a very simple digital signage system without using a PC connected to a network.
- The BKM-FW50 can receive digital signage content from a PC via a network and store it on a CompactFlash memory card. This content can be easily played out on the attached display.

All the settings necessary for these digital signage functions, such as auto play mode, and scheduled download and playback of content can be easily set up from a PC via a network. The display settings such as power ON/OFF, input selection, picture mode selection, and brightness/contrast are also available from the same PC.

# GLOSSARY

## Interface Versatility

### HDMI Input

GXD-L52H1 FWD-S47H1 FWD-S42H1 FWD-40LX2F FWD-32LX2F  
 KLH-40X1 KLH-W32

The display is equipped with an HDMI (High-Definition Multimedia Interface) that is the latest standard for digitally connecting to high-definition devices.



### DVI/HDCP Input

GXD-L52H1 FWD-S47H1 FWD-S42H1 FWD-40LX2F FWD-32LX2F  
 KLH-40X1 KLH-W32

The display supports DVI (Digital Visual Interface), which is a video interface for digitally connecting to display devices. It also supports HDCP (High-bandwidth Digital Content Protection), which is a digital copy protection standard for audio and video content.

### HD-SDI Input

GXD-L52H1 FWD-S47H1 FWD-S42H1

With the optional BKM-FW16 HD-SDI Input Adaptor attached to its option slot, the display can accept digital video in both HD and SD (standard-definition) formats via an HD-SDI/SD-SDI interface.

### RS-232C and Control S

GXD-L52H1 FWD-S47H1 FWD-S42H1 FWD-40LX2F FWD-32LX2F  
 KLH-40X1 KLH-W32

The display supports an RS-232C interface, allowing for full control of the display from external devices. In addition, it can receive command signals from its built-in IR receiver and output these to external devices connected to it via a Control S interface. This allows IR remote controllers to operate the devices wirelessly.

### Network Port

GXD-L52H1 FWD-S47H1 FWD-S42H1 FWD-40LX2F FWD-32LX2F

The display offers versatile network capabilities such as remote control and monitoring via a network port.

### Option Slots

GXD-L52H1 FWD-S47H1 FWD-S42H1 FWD-40LX2F FWD-32LX2F  
 KLH-W32

The display is equipped with option slots that allow the use of optional adaptors to enhance the versatility of the display.

### Available Optional Adaptors

Optional Adaptors	Ruggedized Model	Slim-bezel Model		Basic Model		All-in-one Model	
	GXD-L52H1	FWD-S47H1	FWD-S42H1	FWD-40LX2F	FWD-32LX2F	KLH-40X1	KLH-W32
BKM-FW10				Pre-installed	Pre-installed		●
BKM-FW11	●	●	●	●	●		
BKM-FW12				●	●		●
BKM-FW15	●	●	●				
BKM-FW16	●	●	●				
BKM-FW21	●	●	●				●
BKM-FW32				●	●		
BKM-FW50	●	●	●	●	●	▲	▲

▲: For use of the BKM-FW50, please contact your nearest Sony office of authorized dealer.

## Operational Convenience

### Picture-in-Picture

GXD-L52H1 FWD-S47H1 FWD-S42H1

The picture-in-picture function allows the picture from a secondary source to be displayed within the main picture. The secondary picture is variable in size and position.



Simulated images

### Picture-and-Picture

GXD-L52H1 FWD-S47H1 FWD-S42H1 FWD-40LX2F FWD-32LX2F KLH-40X1

The picture-and-picture function allows the pictures from separate sources to be displayed side by side. Each picture is variable in size.



Simulated images

# GLOSSARY

## Multi-display

**GXD-L52H1** **FWD-S47H1** **FWD-S42H1** **FWD-40LX2F** **FWD-32LX2F**

The multi-display function can present one dynamic large-screen image by combining up to 16 display units. There are two display modes to choose from:

### Window Mode

When making one large image using multiple displays in this mode, each display unit calculates the image part that is hidden by its frame bezel, and then displays each segmented portion of the image. As a result, the one large image looks to be partially masked with multiple frame bezels.

### Tile Mode

When making one large image using multiple displays in this mode, each display unit does not calculate the image part that is hidden by its frame bezel, but rather displays each segmented portion of the image, as it is. As a result, the one large image looks to be split by multiple frame bezels.

### Portrait Mode

**GXD-L52H1** **FWD-S47H1** **FWD-S42H1** **FWD-40LX2F** **FWD-32LX2F**

The display can be mounted horizontally and vertically, so it can be used for digital signage in either landscape or portrait modes.

## Illumination of Sony Logo

**GXD-L52H1** **FWD-S47H1** **FWD-S42H1**

The Sony logo can be shown on the frame of the display by illuminating a built-in LED. The position of the logo can be automatically selected from two positions, thanks to a built-in position sensor. This allows the logo to be properly oriented, depending on whether the display is mounted horizontally or vertically. Furthermore, the built-in LED can be turned off manually to suit user preference.



Simulated images



Simulated images

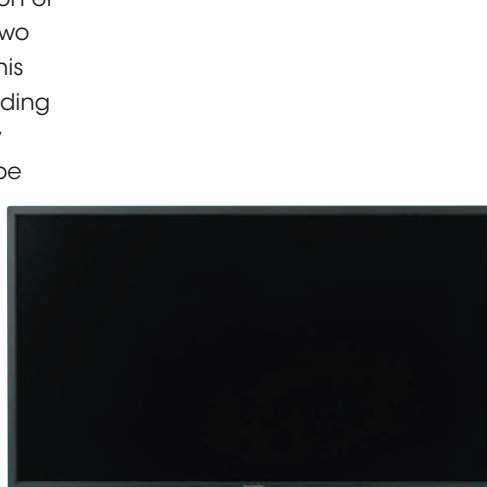

Landscape mode



Portrait mode



## On/Off Timer

GXD-L52H1 FWD-S47H1 FWD-S42H1 FWD-40LX2F FWD-32LX2F  
KLH-40X1

The display can be programmed to turn on or off at a precise time (hh:mm) - either every day or on specified days of the week.

## Sleep Timer

KLH-W32

The display can be set to turn off automatically after a predetermined period of time (15, 30, 45, 60, 90, or 120 minutes).

## Conference Mode

GXD-L52H1 FWD-S47H1 FWD-S42H1

The conference mode is suitable mainly for videoconferencing. This mode highlights the facial expressions of videoconference participants more clearly by reducing the green ingredient of office fluorescent lights for more natural color reproduction.

## Control Panel Lock

GXD-L52H1 FWD-S47H1 FWD-S42H1 FWD-40LX2F FWD-32LX2F  
KLH-40X1

The control panel lock function can disable the control panel of a display to prevent unauthorized changes to the display settings.

## Special Hotel Menu\*

FWD-40LX2F FWD-32LX2F KLH-40X1 KLH-W32

The settings menu of a display includes a special menu for hotel installation that offers advanced settings such as volume limitation.

\* For detailed information, please contact your nearest Sony office or authorized dealer.

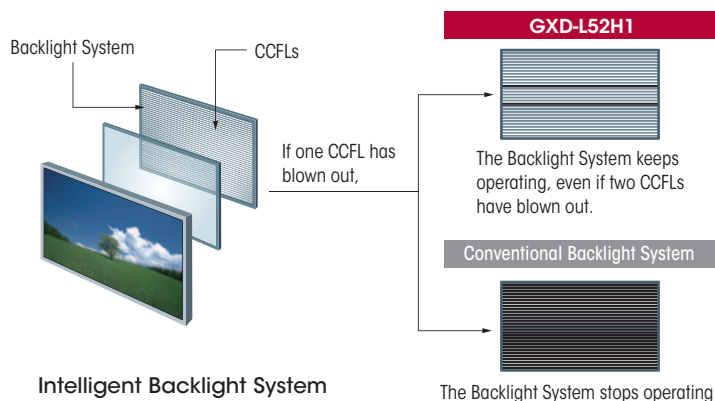

## Easy Operation and Maintenance

### Exchangeable Front Panel

GXD-L52H1

The front protection panel made of tempered glass can be conveniently replaced\* with a new one, if required, without having to dismount\*\* the whole display unit.

\* If a protection panel does need to be replaced, please contact your nearest Sony office or authorized dealer.

\*\* The whole display unit may have to be dismounted in some instances, depending on the mounting location.

### Control via a Network

GXD-L52H1 FWD-S47H1 FWD-S42H1 FWD-40LX2F FWD-32LX2F

The display settings, such as power ON/OFF and selection of input signals, can be controlled from a PC via a network.

### Monitoring via a Network

GXD-L52H1 FWD-S47H1 FWD-S42H1 FWD-40LX2F FWD-32LX2F

The display status, such as power ON/OFF and selection of input signals, can be monitored from a PC via a network.

## Intelligent Backlight System

GXD-L52H1

Conventional backlight systems comprising multiple cold cathode fluorescent lamps (CCFL) have a weakness in that the whole system stops operating, even if just one CCFL has blown out. The backlight system of Sony's display solves this problem with an advanced CCFL control function. Even if two CCFLs have blown out, Sony's backlight system allows the display to maintain stable operations. And if such a malfunction occurs, it can be easily detected - in the case of networked displays, through the PC that monitors the status of the displays, or if standalone, by a control device connected to the display via an RS-232C interface.



# PRESET SIGNALS

## ■ Preset Video Signals

Input Signal Formats	Ruggedized Model	Slim-bezel Model		Basic Model		All-in-one Model	
	GXD-L52H1	FWD-S47H1	FWD-S42H1	FWD-40LX2F	FWD-32LX2F	KLH-40X1	KLH-W32
NTSC	●	●	●	●	●	●	●
PAL	●	●	●	●	●	●	●
NTSC4.43	●	●	●	●	●	●	●
PAL60	●	●	●	●	●	●	●
PAL-M	●	●	●	●	●	●	●
PAL-N	●	●	●	●	●	●	●
575/50i	●	●	●	●	●	●	●
480/60i	●	●	●	●	●	●	●
576/50p	●	●	●	●	●	●	●
480/60p	●	●	●	●	●	●	●
1080/50i	●	●	●	●	●	●	●
1080/60i	●	●	●	●	●	●	●
720/50p	●	●	●	●	●	●	●
720/60p	●	●	●	●	●	●	●
1080/50p	●	●	●	●	●	●	●
1080/60p	●	●	●	●	●	●	●
1080/24psf	●	●	●				

## ■ Preset Computer Signals

Input Signal Formats (RGB)	fH (kHz)	fV (Hz)	Resolution (Active Pixels)	Ruggedized Model	Slim-bezel Model		Basic Model		All-in-one Model	
				GXD-L52H1	FWD-S47H1	FWD-S42H1	FWD-40LX2F	FWD-32LX2F	KLH-40X1	KLH-W32
VGA-1 (VGA 350)	31.5	70	640 x 350	●	●	●	●	●	●	●
640 x 480 @ 60 Hz (VESA STD)	31.5	60	640 x 480	●	●	●	●	●	●	●
Mac 13"	35.0	67	640 x 480	●	●	●	●	●	●	●
VGA (VGA TEXT)	31.5	70	720 x 400	●	●	●	●	●	●	●
800 x 600 @ 60 Hz (VESA STD)	37.9	60	800 x 600	●	●	●	●	●	●	●
Mac 16"	49.7	75	832 x 624	●	●	●	●	●	●	●
1024 x 768 @ 60 Hz (VESA STD)	48.4	60	1024 x 768	●	●	●	●	●	●	●
1024 x 768 @ 75 Hz (VESA STD)	60.0	75	1024 x 768	●	●	●	●	●	●	●
1024 x 768 @ 85 Hz (VESA STD)	68.7	85	1024 x 768	●	●	●	●	●	●	●
1152 x 864 @ 75 Hz (VESA STD)	67.5	75	1152 x 864	●	●	●	●	●	●	●
Mac 21"	68.7	75	1152 x 870	●	●	●	●	●	●	●
1280 x 960 @ 60 Hz (VESA STD)	60.0	60	1280 x 960	●	●	●	●	●	●	●
1280 x 1024 @ 60 Hz (VESA STD)	64.0	60	1280 x 1024	●	●	●	●	●	●	●
1600 x 1200 @ 60 Hz (VESA STD)	75.0	60	1600 x 1200	●	●	●	●	●	●	●
1920 x 1200 @ 60 Hz (VESA, Reduced Blanking)	74.0	60	1920 x 1200	●	●	●	●	●	●	●
800 x 600 @ 60 Hz (CVT)	37.4	60	800 x 600	●	●	●	●	●	●	●
848 x 480 @ 60 Hz (CVT)	29.8	60	848 x 480	●	●	●	●	●	●	●
848 x 480 @ 60 Hz (CVT)	29.5	60	848 x 480	●	●	●	●	●	●	●
848 x 480 @ 75 Hz (CVT)	37.7	75	848 x 480	●	●	●	●	●	●	●
848 x 480 @ 85 Hz (CVT)	43.0	85	848 x 480	●	●	●	●	●	●	●
1280 x 720 @ 60 Hz (CVT)	44.8	60	1280 x 720	●	●	●	●	●	●	●
1280 x 768 @ 60 Hz (CVT)	47.8	60	1280 x 768	●	●	●	●	●	●	●
1280 x 768 @ 60 Hz (CVT)	47.4	60	1280 x 768	●	●	●	●	●	●	●
1280 x 768 @ 75 Hz (CVT)	60.3	75	1280 x 768	●	●	●	●	●	●	●
1280 x 960 @ 60 Hz (CVT)	59.7	60	1280 x 960	●	●	●	●	●	●	●
1360 x 768 @ 60 Hz (CVT)	47.7	60	1360 x 768	●	●	●	●	●	●	●
1360 x 768 @ 60 Hz (CVT)	47.4	60	1360 x 768	●	●	●	●	●	●	●
1024 x 768 @ 60 Hz (CVT)	47.8	60	1024 x 768	●	●	●	●	●	●	●
1280 x 1024 @ 60 Hz (CVT)	63.7	60	1280 x 1024	●	●	●	●	●	●	●
1400 x 1050 @ 60 Hz (CVT)	65.3	60	1400 x 1050	●	●	●	●	●	●	●
1600 x 1200 @ 60 Hz (CVT)	74.5	60	1600 x 1200	●	●	●	●	●	●	●
1920 x 1080 @ 60 Hz (CVT, Reduced Blanking)	66.6	60	1920 x 1080	●	●	●	●	●	●	●

# SIGNAL COMBINATIONS

For Picture-in-Picture and Picture-and-Picture Functions

## ■ Ruggedized Type: GXD-L52H1

		VIDEO		HD 15		DVI	HDMI	OPTION			
		S-Video	Composite	RGB	Component			RGB	Component	HDMI	HD-SDI/SD-SDI
VIDEO	S-Video			●	●	●	●	●	●	●	●
	Composite			●	●	●	●	●	●	●	●
HD 15	RGB	●	●			●	●	●	●	●	●
	Component	●	●			●	●	●	●	●	●
DVI		●	●	●	●			●	●		
HDMI		●	●	●	●			●	●		

## ■ Slim-bezel Type: FWD-S47H1 and FWD-S42H1

		VIDEO		HD 15		DVI	OPTION			
		S-Video	Composite	RGB	Component	DVI/HDMI*	RGB	Component	HDMI	HD-SDI/SD-SDI
VIDEO	S-Video			●	●	●	●	●	●	●
	Composite			●	●	●	●	●	●	●
HD 15	RGB	●	●			●	●	●	●	●
	Component	●	●			●	●	●	●	●
DVI	DVI/HDMI*	●	●	●	●		●	●		

\*The display equips a DVI connector to accept video signals from DVI-based devices. It can also accept video signals without audio from HDMI-based devices via this connector with a DVI-to-HDMI cable.

## ■ Basic Type: FWD-40LX2F and FWD-32LX2F

		HD 15		HDMI 1	HDMI 2	OPTION 1 & 2			
		RGB	Component	HDMI/DVI*	HDMI/DVI*	RGB	Component	Composite	S-Video
HD 15	RGB			●	●				
	Component			●	●				
HDMI 1	HDMI/DVI*	●	●			●	●	●	●
HDMI 2	HDMI/DVI*	●	●			●	●	●	●
OPTION 1 & 2	RGB			●	●				
	Component			●	●				
	Composite			●	●				
	S-Video			●	●				

\*The display equips an HDMI connector to accept video and audio signals from HDMI-based devices. It can also accept video signals from DVI-based devices via this connector with an HDMI-to-DVI cable.

## ■ All-in-one Type: KLH-40X1

		HD 15		HDMI 1	HDMI 2	VIDEO	
		RGB	Component	HDMI/DVI*	HDMI/DVI*	S-Video	Composite
HD 15	RGB			●	●		
	Component			●	●		
HDMI 1	HDMI/DVI*	●	●			●	●
HDMI 2	HDMI/DVI*	●	●			●	●
VIDEO	S-Video			●	●		
	Composite			●	●		

\*The display equips an HDMI connector to accept video and audio signals from HDMI-based devices. It can also accept video signals from DVI-based devices via this connector with an HDMI-to-DVI cable.

# CONNECTORS

## ■ Connector Panels of Displays

### GXD-L52H1

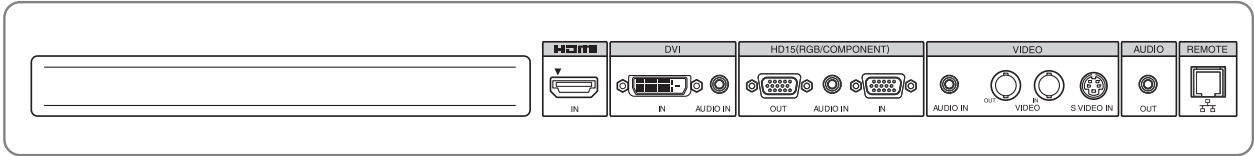

### FWD-S47H1 / FWD-S42H1

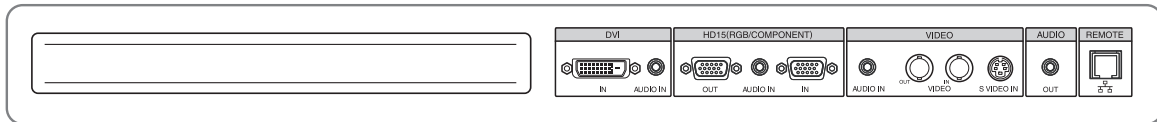

### FWD-40LX2F / FWD-32LX2F

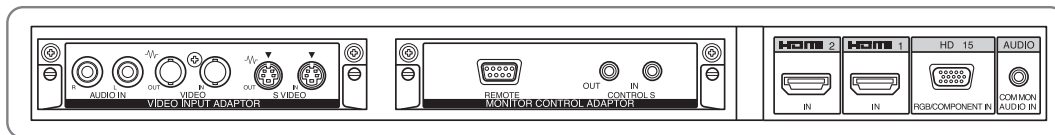

### KLH-40X1

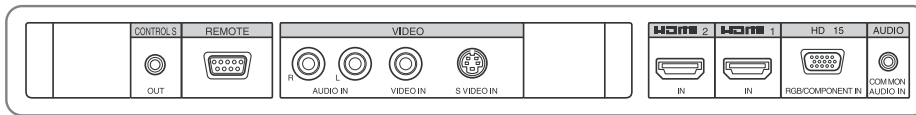

### KLH-W32

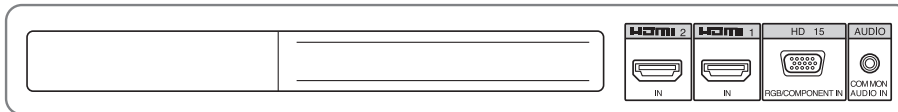

## ■ Optional Adaptors

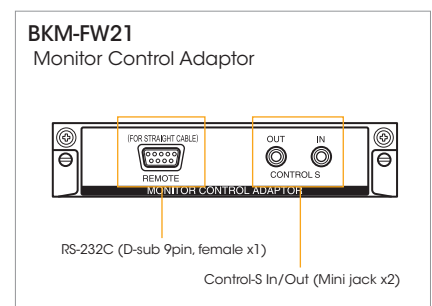
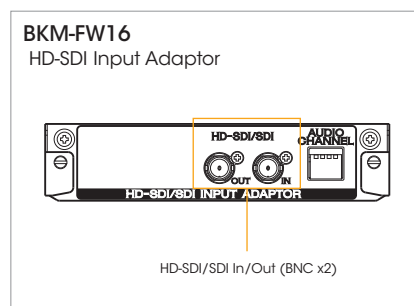
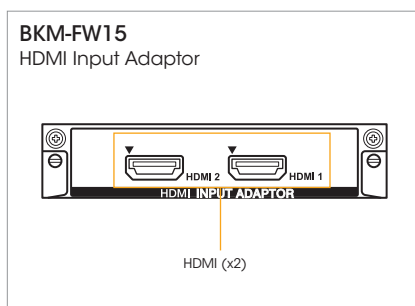
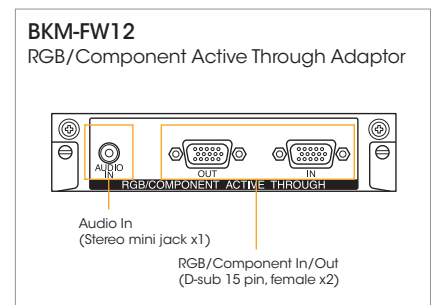
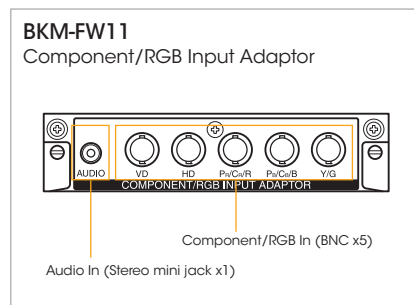
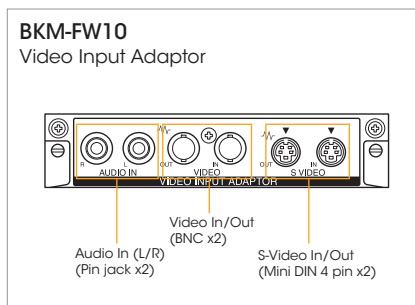

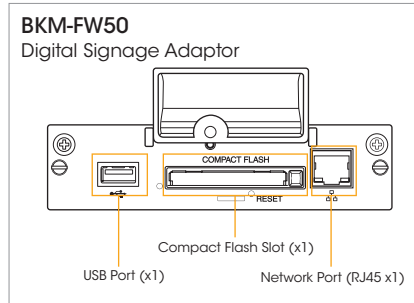
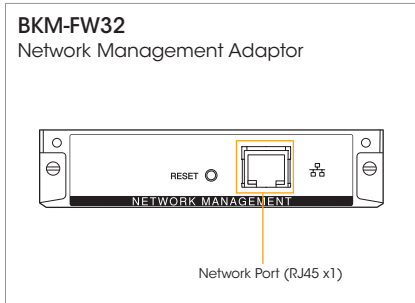

## OPTIONAL ACCESSORIES



**BKM-FW10**  
Video Input Adaptor

KLH-W32



**BKM-FW11**  
Component /RGB Input Adaptor

GXD-L52H1 FWD-S47H1 FWD-S42H1  
FWD-40LX2F FWD-32LX2F



**BKM-FW12**  
RGB/Component Active  
Through Adaptor

FWD-40LX2F FWD-32LX2F KLH-W32



**BKM-FW15**  
HDMI Input Adaptor

GXD-L52H1 FWD-S47H1 FWD-S42H1



**BKM-FW16**  
HD-SDI Input Adaptor

GXD-L52H1 FWD-S47H1 FWD-S42H1



**BKM-FW21**  
Monitor Control Adaptor

GXD-L52H1 FWD-S47H1 FWD-S42H1



**BKM-FW32**  
Network Management Adaptor

FWD-40LX2F FWD-32LX2F



**BKM-FW50**  
Digital Signage Adaptor

GXD-L52H1 FWD-S47H1 FWD-S42H1  
FWD-40LX2F FWD-32LX2F KLH-40X1  
KLH-W32



**VSP-NS7**  
Digital Signage Player

GXD-L52H1 FWD-S47H1 FWD-S42H1  
FWD-40LX2F FWD-32LX2F KLH-40X1  
KLH-W32



**SS-SPG01**  
Speaker System

GXD-L52H1 FWD-S47H1 FWD-S42H1



**SS-SP40FW**  
Speaker System

FWD-40LX2F



**SS-SP32FW**  
Speaker System

FWD-32LX2F

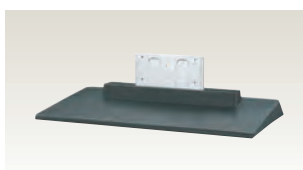

**SU-S01**  
Display Stand

FWD-S47H1 FWD-S42H1

# SPECIFICATIONS

		Ruggedized Model
		GXD-L52H1
<b>Picture Performance</b>		
Panel	Panel size (diagonal)	52-inch*
	Resolution (H/V)	1920 x 1080 pixels, Full HD
	Pixel pitch	1/40 x 1/40 inches (0.6 x 0.6 mm)
	Picture size (H/V)	45 1/2 x 25 5/8 inches (1,152 x 648 mm)
	Panel drive	RGB 10 bit
	Contrast ratio	800:1 (typical)
	Brightness	500 cd/m2 (typical)
	Viewing angle**	178° (typical)
	Response Time	9 ms (typical)
	Type	a-Si TFT Active Matrix LCD
Acceptable signals	Refer to "Preset Video Signals" and "Preset Computer Signals"	
Color system	NTSC, PAL, PAL-M, PAL-N, NTSC4.43, PAL60	
Sampling rate	13.5 to 140 MHz	
<b>Input and Output</b>		
REMOTE	Network port	RJ45 (x1), 10BASE-T/100BASE-TX
AUDIO	Audio out	Stereo mini jack (x1), 500 mV rms, high impedance
VIDEO	S-Video in	Mini DIN 4-pin (x1) Y: 1.0 Vp-p ±2 dB, sync negative, 75 Ω terminated C: 0.286 (NTSC)/0.3 (PAL) Vp-p ±2 dB, sync negative, 75 Ω terminated
	Video in/out	BNC (x2), composite video, 1.0 Vp-p ±2 dB, sync negative, 75 Ω, loop-through (automatic termination)
	Audio in	Stereo mini jack (x1), 500 mV rms, high impedance
HD15 (RGB/COMPONENT)	Video in/out	D-sub 15-pin (female, x2)
	Audio in	Stereo mini jack (x1), 500 mV rms, high impedance
DVI	DVI in	DVI Specification Rev. 1.0 compliant
	Audio in	Stereo mini jack (x1), 500 mV rms, high impedance
HDMI	HDMI in	HDMI (1,080p)
SPEAKER	Speaker out (L/R)	Grp connector (x4), 7 W + 7 W, 6Ω
<b>General</b>		
Power requirements	AC 100 to 240 V, 50/60 Hz, 4.6 A (maximum)	
Power consumption	380 W (typical)/460 W (maximum)	
Operating temperature	32 to 95 °F (0 to 35 °C)	
Storage temperature	14 to 104 °F (-10 to 40 °C)	
Humidity	20 to 90%, no condensation	
Dimensions (W/H/D)	Approx. 50 5/8 x 30 1/8 x 6 inches (1,281 x 764 x 152 mm) (excluding protruding parts)	
Weight	Approx. 143 lb 5 oz (65 kg)	
<b>Supplied Accessories</b>		
AC power cord (1), LAN Cable (1), AC plug holder (2), Cable holder (8), Remote Commander RM-FW002 (1), Size AA (R6) batteries (2), Operating instructions (1)		
<b>Regulation Compliance</b>		
UL1950, CSA No.950 (c-UL), CE LVD (EN60950), FCC Class-B, IC Class-B, VCCI Class-B, CE EMC (EN55022 Class-B, EN55024, EN61000-3-2, EN61000-3-3), C-Tick, IP30		

\* Viewable area, measured diagonally.

\*\* Measured at the contrast ratio more than 10:1.

## Dimensions

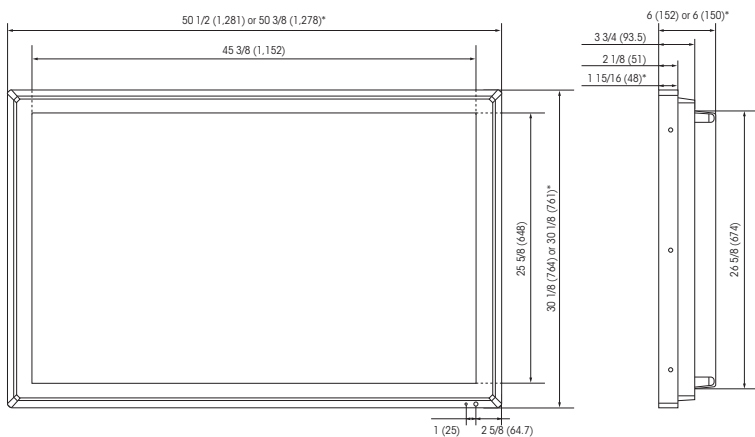

Unit: inches (mm)

\*Excluding corner protection covers

		Slim-bezel Model	
		FWD-S47H1	FWD-S42H1
<b>Picture Performance</b>			
Panel	Panel size (diagonal)	47-inch*	42-inch*
	Resolution (H/V)	1920 x 1080 pixels, Full HD	
	Pixel pitch	1/46 x 1/46 inches (0.54 x 0.54 mm)	1/52 x 1/52 inches (0.48 x 0.48 mm)
	Picture size (H/V)	41 x 23 1/8 inches (1,040 x 585 mm)	36 3/4 x 20 5/8 inches (930 x 523 mm)
	Panel drive	RGB : 8 bit + FRC (Frame Rate Control), color number : 1.06 billion	
	Contrast ratio	1000:1 (typical)	
	Brightness	700 cd/m <sup>2</sup> (typical)	
	Viewing angle***	178° (typical)	
	Response Time	9 ms (typical)	
	Type	α-Si TFT Active Matrix LCD	
Acceptable signals		Refer to "Preset Video Signals" and "Preset Computer Signals"	
Color system		NTSC, PAL, PAL-M, PAL-N, NTSC4.43, PAL60	
Sampling rate		13.5 to 162 MHz	
<b>Input and Output</b>			
REMOTE	Network port	RJ45 (x1), 10BASE-T/100BASE-TX	
AUDIO	Audio out	Stereo mini jack (x1), 500 mV rms, high impedance	
VIDEO	S-Video in	Mini DIN 4-pin (x1) Y: 1.0 Vp-p ± 2 dB, sync negative, 75 Ω terminated C: 0.286 (NTSC)/0.3 (PAL) Vp-p ± 2 dB, sync negative, 75 Ω terminated	
	Video in/out	BNC (x2), composite video, 1.0 Vp-p ± 2 dB, sync negative, 75 Ω, loop-through (automatic termination)	
	Audio in	Stereo mini jack (x1), 500 mV rms, high impedance	
HD15	Video in/out	D-sub 15-pin (female, x2)	
(RGB/COMPONENT)	Audio in	Stereo mini jack (x1), 500 mV rms, high impedance	
DVI	DVI in	DVI (x1), DVI Specification Rev. 1.0 compliant/HDMI (available by using a DVI-to-HDMI cable)**	
	Audio in	Stereo mini jack (x1), 500 mV rms, high impedance	
SPEAKER	Speaker out (L/R)	Grip connector (x4), 7W + 7W, 6Ω	
<b>General</b>			
Power requirements		AC 100 to 240 V, 50/60 Hz, 3.3 A (maximum)	AC 100 to 240 V, 50/60 Hz, 2.9 A (maximum)
Power consumption		240W (typical) / 320W (maximum)	210 W (typical) / 280 (maximum)
Operating temperature		32 to 95 °F (0 to 35 °C)	
Storage temperature		14 to 104 °F (-10 to 40 °C)	
Humidity		20 to 90%, no condensation	
Dimensions (W/H/D)		42 5/8 x 24 3/4 x 5 1/8 inches (1082 x 627 x 129 mm)	38 3/8 x 22 3/8 x 5 inches (973 x 566 x 125 mm)
Weight		Approx. 67 lb 2 oz (30.5 Kg)	Approx. 56 lb 2 oz (25.5 Kg)
<b>Supplied Accessories</b>			
		AC power cord (1), AC plug holder (2), Cable holder (9), LAN cable (1), Remote Commander RM-FW002 (1), Size AA (R6) batteries (2), Operating instructions (1)	
<b>Regulation Compliance</b>			
		UL60950-1, CSA No.60950-1-03 (c-UL), FCC Class B, IC Class B, EN 60950-1 (NEMKO), CE, C-Tick	

\* Viewable area, measured diagonally.

\*\* Audio signals are not supported.

\*\*\* Measured at the contrast ratio more than 10:1.

## Dimensions

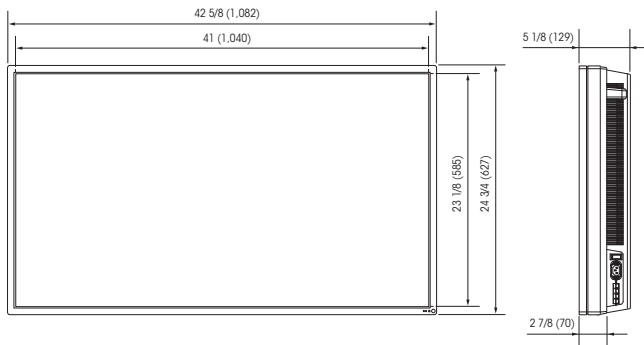

FWD-S47H1

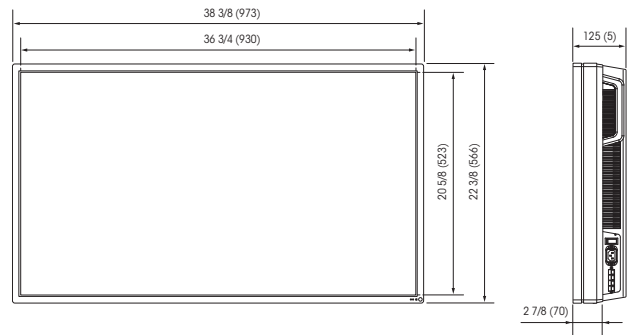

FWD-S42H1

Unit: inches (mm)

# SPECIFICATIONS

		Basic Model	
		FWD-40LX2F	FWD-32LX2F
<b>Picture Performance</b>			
Panel	Panel size (diagonal)	40-inch*	32-inch*
	Resolution (H/V)	1,366 x 768 pixels, WXGA	
	Pixel pitch	1/40 x 1/40 inches (0.6 x 0.6 mm)	1/50 x 1/50 inches (0.5 x 0.5 mm)
	Picture size (H/V)	34 7/8 x 19 5/8 inches (885 x 498 mm)	27 1/2 x 15 1/2 inches (698 x 392 mm)
	Panel drive	RGB: 8 bit	
	Contrast ratio	1300 : 1 (typical)	
	Brightness	500 cd/m <sup>2</sup> (typical)	
	Viewing angle	178° (typical)	
	Response Time	8 ms (typical)	
	Type	a-Si TFT Active Matrix LCD	
Acceptable signals		Refer to "Preset Video Signals" and "Preset Computer Signals"	
Color system		NTSC, PAL, SECAM, PAL-M, PAL-N, NTSC4.43, PAL60	
Sampling rate		13.5 to 140 MHz	
<b>Input and Output**</b>			
AUDIO	Common audio in	Stereo mini jack (x1), 500 mV rms, high impedance	
HD15	RGB/Component in	D-sub 15-pin (female, x1)	
HDMI 1/HDMI 2	HDMI in	HDMI (x2)/DVI (available by using an HDMI-to-DVI cable)	
CONTROL S	Control S in/out	Mini jack (x2)	
REMOTE	RS-232C	D-sub 9-pin (x1)	
VIDEO	S-Video in	Mini DIN 4-pin (x1) Y: 1.0 Vp-p ±2 dB, sync negative, 75 Ω terminated C: 0.286 (NTSC)/0.3 (PAL) Vp-p ±2 dB, sync negative, 75 Ω terminated	
	S-Video out	Mini DIN 4-pin (x1), loop-through	
	Video in	BNC (x1), composite video, 1.0 Vp-p ±2 dB, sync negative, 75 Ω	
	Video out	BNC (x1), loop-through	
	Audio in (L/R)	Pin jack (x2), 500 mV rms, high impedance	
SPEAKER	Speaker out (L/R)	Grip connector (x4), 7 W + 7 W, adequate load impedance: 6 to 16 Ω	
<b>General</b>			
Power requirements		AC 100 to 240 V, 50/60 Hz, 2.3 A	AC 100 to 240 V, 50/60 Hz, 1.3 A
Power consumption		200 W	120 W
Operating temperature		32 to 95 (0 to 35 °C)	
Storage temperature		14 to 104 °F (-10 to 40 °C)	
Humidity		20 to 90%, no condensation	
Dimensions (W/H/D)		39 x 23 3/8 x 5 inches (988 x 591 x 125 mm)	31 3/8 x 19 1/4 x 4 1/4 inches (796 x 486 x 107 mm)
Weight		Approx. 55 lb 2 oz (25.0 kg)	Approx. 35 lb 5 oz (16.0 kg)
<b>Supplied Accessories</b>			
		AC power cord (1), AC plug holder (2), Cable holder (4), HD15-component cable (1), BNC-RCA adaptor (1), Remote Commander RM-FW001 (1), Size AA (R6) batteries (2), Operating instructions (1)	AC power cord (1), AC plug holder (2), Cable holder (6), HD15-component cable (1), BNC-RCA adaptor (1), Remote Commander RM-FW001 (1), Size AA (R6) batteries (2), Operating instructions (1)
<b>Regulation Compliance</b>			
		UL60950-1, CSA No.60950-1-03 (c-UL), FCC Class B, IC Class B, EN 60950-1 (NEMKO), CE, C-Tick	

\* Viewable area, measured diagonally.

\*\* A BKM-FW10 Video Input Adaptor and a monitor control adaptor are pre-installed in the display's optional adaptor slots.

## Dimensions

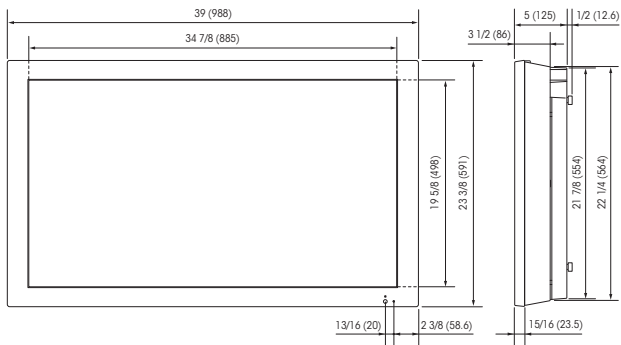

FWD-40LX2F

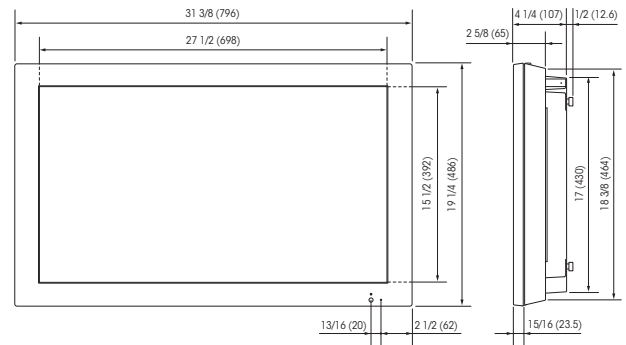

FWD-32LX2F

Unit: inches (mm)



		All-in-one Model	
		KLH-40X1	KLH-W32
<b>Picture Performance</b>			
Panel	Panel size (diagonal)	40-inch*	32-inch*
	Resolution (H/V)	1,366 x 768 pixels, WXGA	
	Pixel pitch	1/40 x 1/40 inches (0.6 x 0.6 mm)	1/32 x 1/32 inches (0.51 x 0.51 mm)
	Picture size (H/V)	34 7/8 x 19 5/8 inches (885 x 498 mm)	27 1/2 x 15 1/2 inches (698 x 392 mm)
	Panel drive	RGB 8 bit	RGB 8 bit
	Contrast ratio	1300:1 (typical)	
	Brightness	500 cd/m2 (typical)	
	Viewing angle**	178° (typical)	
	Response Time	8 ms (typical)	
	Type	α-Si TFT Active Matrix LCD	
Acceptable signals		Refer to "Preset Video Signals" and "Preset Computer Signals"	
Color system		NTSC, PAL, SECAM, PAL-M, PAL-N, NTSC4.43, PAL60	
Sampling rate		13.5 to 140 MHz	
<b>Input and Output</b>			
AUDIO	Common audio in	Stereo mini jack (x1), 500 mV rms, high impedance	
HD15	RGB/Component in	D-sub 15-pin (female, x1)	
HDMI 1/HDMI 2	HDMI in	HDMI (x2)/DVI (available by using an HDMI-to-DVI cable)	
VIDEO	S-Video in	Mini DIN 4-pin (x1) Y: 1.0 Vp-p ±2 dB, sync negative, 75 Ω terminated C: 0.286 (NTSC)/0.3 (PAL) Vp-p ±2 dB, sync negative, 75 Ω terminated	
	Video in	RCA pin jack (x1), composite video, 1.0 Vp-p ±2 dB, sync negative, 75 Ω	
	Audio in (L/R)	Pin jack (x2), 500 mV rms, high impedance	
REMOTE	RS-232C	D-sub 9-pin (x1)	
CONTROL S	Control S out	Mini jack (x1)	
<b>Speaker</b>			
Speaker output	Built-in speaker	Stereo Model, 10 W + 10 W, adequate load impedance: 8 to 16 Ω	10 W + 10 W, adequate load impedance: 6 to 16 Ω
<b>General</b>			
Power requirements		AC 90 to 264 V, 50/60 Hz, 2.3 A	AC 100 to 240 V, 50/60 Hz, 1.3 A
Power consumption		220 W	120 W
Operating temperature		32 to 95 °F (0 to 35 °C)	
Storage temperature		-4 to 140 °F (-20 to 60 °C)	14 to 104 °F (-10 to 40 °C)
Humidity		20 to 90%, no condensation	
Dimensions (W/H/D)		39 x 27 x 10 5/8 inches (989 x 685 x 270 mm) (excluding protruding parts)	31 1/2 x 22 7/8 x 8 3/4 inches (798 x 581 x 220 mm) (excluding protruding parts)
Weight		Approx. 61 lb 12 oz (28.0 kg)	Approx. 36 lb 10oz (16.6 kg)
<b>Supplied Accessories</b>			
		AC power cord (1), Cable holder (1), HD15-component cable, Remote Commander RM-FW001 (1), Size AA (R6) batteries (2), Operating instructions (1)	AC power cord (1), Cable holder (1), Remote Commander RM-YA004 (1), Size AA (R02) batteries (2), Operating instructions (1)
<b>Regulation Compliance</b>			
		UL60950-1, CSA No.60950-1-03 (c-UL), FCC Class B, IC Class B, EN 60950-1 (NEMKO), CE, C-Tick	

\* Viewable area, measured diagonally.

\*\* Measured at the contrast ratio more than 10:1.

## Dimensions

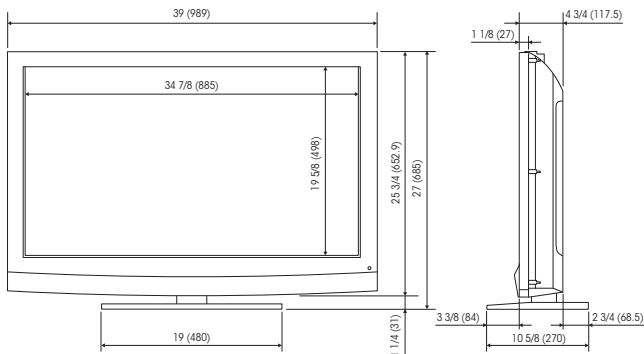

KLH-40X1

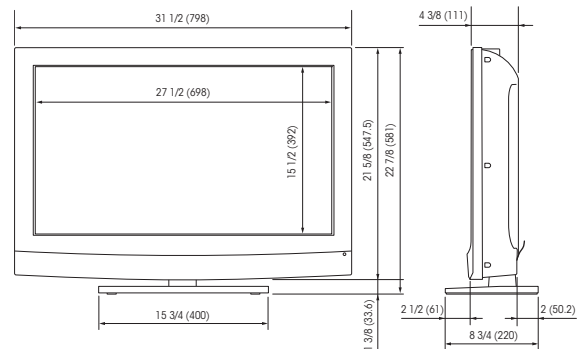

KLH-W32

Unit: inches (mm)

**SONY**<sup>®</sup>

Sony Electronics Inc.  
1 Sony Drive  
Park Ridge, NJ 07656  
[sony.com/publicdisplays](http://sony.com/publicdisplays)  
DI-0165 (MK10503V1)

© 2008 Sony Electronics Inc. All rights reserved.

Reproduction in whole or in part without permission is prohibited.  
Features and specifications are subject to change without notice.

All non-metric weights and measurements are approximate.

Sony is a trademark of Sony. SRS WOW and (●) symbol are registered trademarks of SRS Labs, Inc.

BBE and BBE symbol are registered trademarks of BBE Sound Inc.

HDMI, the HDMI logo, and High-Definition Multimedia Interface are trademarks or registered trademarks of HDMI Licensing LLC.

All other trademarks are the property of their respective owners.

Printed in USA (9/08)