

# ULTRAZONE

# ZMX8210

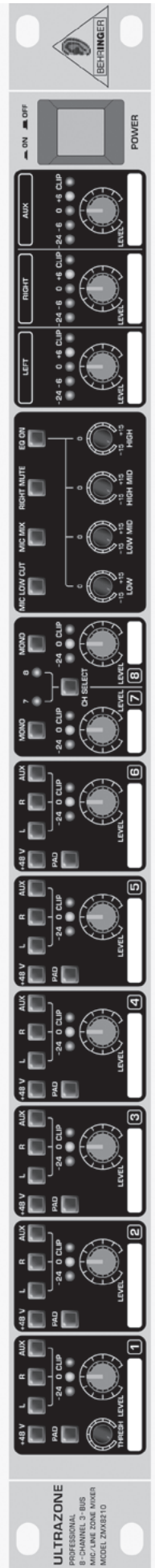

[www.behringer.com](http://www.behringer.com)

## User Manual

A50-17433-00002

en



## Important safety instructions





This symbol, wherever it appears, alerts you to the presence of uninsulated dangerous voltage inside the enclosure - voltage that may be sufficient to constitute a risk of shock.



This symbol, wherever it appears, alerts you to important operating and maintenance instructions in the accompanying literature. Please read the manual.

### Caution

-  To reduce the risk of electric shock, do not remove the top cover (or the rear section). No user serviceable parts inside. Refer servicing to qualified personnel.
-  To reduce the risk of fire or electric shock, do not expose this appliance to rain and moisture. The apparatus shall not be exposed to dripping or splashing liquids and no objects filled with liquids, such as vases, shall be placed on the apparatus.
-  These service instructions are for use by qualified service personnel only. To reduce the risk of electric shock do not perform any servicing other than that contained in the operation instructions. Repairs have to be performed by qualified service personnel.



- 1) Read these instructions.
- 2) Keep these instructions.
- 3) Heed all warnings.
- 4) Follow all instructions.
- 5) Do not use this apparatus near water.
- 6) Clean only with dry cloth.
- 7) Do not block any ventilation openings. Install in accordance with the manufacturer's instructions.
- 8) Do not install near any heat sources such as radiators, heat registers, stoves, or other apparatus (including amplifiers) that produce heat.
- 9) Do not defeat the safety purpose of the polarized or grounding-type plug. A polarized plug has two blades with one wider than the other. A grounding-type plug has two blades and a third grounding prong. The wide blade or the third prong are provided for your safety. If the provided plug does not fit into your outlet, consult an electrician for replacement of the obsolete outlet.
- 10) Place the power cord so that it is protected from being walked on and sharp edges. Be sure that the power cord is protected particularly at plugs, convenience receptacles and the point where it exits from the apparatus.
- 11) The apparatus shall be connected to a MAINS socket outlet with a protective earthing connection.
- 12) Where the MAINS plug or an appliance coupler is used as the disconnect device, the disconnect device shall remain readily operable.
- 13) Only use attachments/accessories specified by the manufacturer.
- 14) Use only with the cart, stand, tripod, bracket, or table specified by the manufacturer, or sold with the apparatus. When a cart is used, use caution when moving the cart/apparatus combination to avoid injury from tip-over.



- 15) Unplug this apparatus during lightning storms or when unused for long periods of time.
- 16) Refer all servicing to qualified service personnel. Servicing is required when the apparatus has been damaged in any way, such as power supply cord or plug is damaged, liquid has been spilled or objects have fallen into the apparatus, the apparatus has been exposed to rain or moisture, does not operate normally, or has been dropped.

# ULTRAZONE

## Professional 8-Channel 3-Bus Mic/Line Zone Mixer with Remote Control and Link Ports

- ▲ Ultra-flexible and easy-to-use zone mixer with remote control ports for commercial sound systems and fixed installation applications
- ▲ 6 ultra-low noise Mic/Line inputs with Gain control, -20 dB Pad, Level/Clip indicator, +48 V phantom power and bus-assign switches
- ▲ 2 selectable high-headroom stereo inputs with mono/stereo switch
- ▲ Channel 1 provides variable threshold to enable automatic bus mute for announcements, etc.
- ▲ 3 assignable outputs (Left, Right and Aux) with individual Master controls and 5-segment LED meters
- ▲ Ultra-musical 4-band master EQ and global microphone low-cut filter for perfect sound adjustment
- ▲ Left, Right, Aux and Mute bus links available including Master/Slave switch for connecting multiple units
- ▲ Remote master Left/Right level control port for ultimate flexibility
- ▲ Select switch for routing microphone bus post remote control
- ▲ Integrated channel muting system with Priority select
- ▲ All inputs/outputs on Euro-type connectors
- ▲ High-quality components and exceptionally rugged construction ensure long life
- ▲ Conceived and designed by BEHRINGER Germany

ZMX8210

## Foreword



Dear Customer,

Welcome to the team of ULTRAZONE users, and thank you very much for expressing your confidence in BEHRINGER by purchasing this rack mixer.

Writing this foreword for you gives me great pleasure because it represents the culmination of many months of hard work delivered by engineering team to achieve a very ambitious goal: to present an outstanding rack mixer whose amazing functions offer a maximum on flexibility and performance. The task of designing our new

ZMX8210 certainly meant a great deal of responsibility, which we assumed on you, the discerning user and musician. Meeting your expectations also meant a lot of work and night shifts. But it was fun, too. Developing a product usually brings a lot of people together, and what a great feeling it is when all who participated in such a project can be proud of what they've achieved.

It is our philosophy to share our enjoyment with you, because you are the most important member of the BEHRINGER team. With your highly competent suggestions for new products you've made a significant contribution to shaping our company and making it successful. In return, we guarantee you uncompromising quality as well as excellent technical and audio properties at an extremely reasonable price. All of this will let you give free rein to your creativity without being hampered by budget constraints.

We are often asked how we manage to produce such high-quality equipment at such unbelievably low prices. The answer is quite simple: it's you, our customers! Many satisfied customers mean large sales volumes enabling us to get better purchasing terms for components, etc. Isn't it only fair to pass these benefits on to you? Because we know that your success is our success too!

I would like to thank all of you who have made the ULTRAZONE possible. You have made all your own personal contributions, from the developers and the many other employees at this company to you, the BEHRINGER user.

*My friends, it's been worth the effort!*

Thank you very much,

Uli Behringer

## Table of contents

<b>1. Introduction.....</b>	<b>5</b>
1.1 Before getting started.....	5
1.1.1 Shipment.....	5
1.1.2 Initial operation .....	5
1.1.3 Online registration.....	5
<b>2. Controls and connectors .....</b>	<b>5</b>
2.1 Front panel .....	5
2.2 Rear panel.....	6
<b>3. Application .....</b>	<b>7</b>
3.1 Examples of application .....	7
3.1.1 Directing public address to up to three zones.....	7
3.1.2 Using multiple ZMX8210s.....	7
3.1.3 Remote control of the ZMX8210.....	7
3.2 Basic operation .....	8
<b>4. Installation.....</b>	<b>8</b>
4.1 Rack mounting .....	8
4.2 Audio connections.....	8
<b>5. Specifications .....</b>	<b>10</b>
<b>6. Warranty .....</b>	<b>11</b>

## 1. Introduction

Thank you for purchasing the ULTRAZONE ZMX8210. The ZMX8210 is a professional rack mixer which is especially suitable for fixed installation applications and allows public address to be directed to up to three zones (rooms). The eight input channels process Line and Microphone signals. Further inputs are added by connecting a second ZMX8210. All channels have high-quality preamplifiers to ensure the highest level of sound quality. The input signals can flexibly be routed to three output buses as well as effectively be processed with the integrated 4-band equalizer. Several functions of the ZMX8210 can be controlled remotely by using simple control elements. Thanks to its intuitive control panel, the unit can also be employed by inexperienced users after a short while unlike conventional mixers.

The ZMX8210 gives you full control in no time to direct public address into every setting.

*Have fun with your new mixer.*

### 1.1 Before getting started

#### 1.1.1 Shipment

Your ZMX8210 was carefully packed at the factory, and the packaging was designed to protect the unit from rough handling. Nevertheless, we recommend that you carefully examine the packaging and its contents for any signs of physical damage that may have occurred during transit.

- 👉 **If the unit is damaged, please do NOT return it to BEHRINGER. Instead, notify your dealer and the shipping company immediately. Otherwise, claims for damage or replacement may not be honored.**
- 👉 **Always use the original packing carton to prevent damage during storage or transport.**
- 👉 **Make sure that no children are left unsupervised with the unit or its packaging.**
- 👉 **Please ensure proper disposal of all packing materials.**

#### 1.1.2 Initial operation

Be sure that there is enough space around the unit for cooling. To avoid overheating, please do not place the ZMX8210 near radiators and other equipment emanating heat.

- 👉 **Blown fuses must be replaced by fuses of the same type and rating! The correct value is specified in "Specifications." Unplug the unit before replacing the fuse!**

The mains connection is made using the enclosed power cord and a standard IEC receptacle. It meets all of the international safety certification requirements.

- 👉 **Please make sure that all units have a proper ground connection. For your own safety, never remove or disable the ground conductor from the unit or of the AC power cord. The unit shall always be connected to the mains socket outlet with a protective ground connection.**
- 👉 **Please ensure that only qualified people install and operate the unit. During installation and operation, the user must have sufficient electrical contact to the ground, otherwise electrostatic discharges might affect the operation of the unit.**
- 👉 **The sound quality may diminish within the range of powerful broadcasting stations and high-frequency sources. Increase the distance between the transmitter and the device and use shielded cables for all connections.**

### 1.1.3 Online registration

Please remember to register your new BEHRINGER equipment right after your purchase by visiting [www.behringer.com](http://www.behringer.com) (alternatively [www.behringer.de](http://www.behringer.de)) and read the terms and conditions of our warranty carefully.

Should your BEHRINGER product malfunction, our goal is to have it repaired as quickly as possible. Please contact the retailer from whom the equipment was purchased. Should your BEHRINGER dealer not be located in your vicinity, you may directly contact one of our subsidiaries. Corresponding contact information is included in the original equipment packaging (Global Contact Information/European Contact Information). Should your country not be listed, please contact the distributor nearest you. A list of distributors can be found in the support area of our website ([www.behringer.com/support](http://www.behringer.com/support)).

Registering your purchase and equipment with us helps us process your repair claims quicker and more efficiently.

*Thank you for your cooperation!*

## 2. Controls and connectors

### 2.1 Front panel

The controls of channels 1 – 6 and 7 – 8 are largely identical as well as the controls of the LEFT, RIGHT and AUX buses. Channels 1 and 7 plus the LEFT bus are described exemplarily.

Pressing the switch controls, unless otherwise noted, activates the described functions, but are deactivated when not pressed.

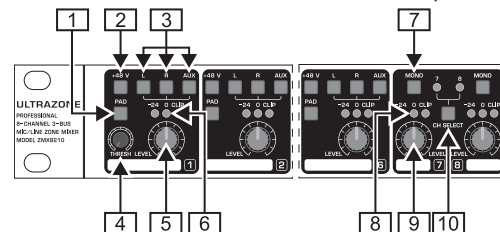

Fig. 2.1: Controls of the ZMX8210

#### Channels 1 – 6

- 1 **PAD:** The switch attenuates the input level of loud signal sources by 20 dB.
- 2 **+48 V:** The switch activates the phantom power for capacitor microphones.
- 3 **L, R, AUX:** The three switches route the channel signals to one or more output buses.
- 4 **THRESH (only Channel 1):** The knob selects the level at which the signal is muted. When the level of the input signal exceeds the specified value, the signal of channels 2 – 8 on the LEFT/RIGHT bus is muted. Apply the Mute function to fade out music signals as soon as a microphone on channel 1 is talked into.
- 5 **LEVEL:** This knob adjusts the preamplification and the level with which the input signal is sent to the selected buses.
- 6 **LEDs:** The LEDs show the input levels. When the CLIP LED lights up, the input level needs to be attenuated by using the LEVEL knob 5 to prevent clipping. In case the attenuation is insufficient, use PAD switch 1 to attenuate the signal further.

#### Channels 7 – 8

- 7 **MONO:** This switch selects the configuration of the stereo channels:
  - ▲ In mono mode (switch pressed), the channel's L/R inputs are mixed together and sent to the LEFT, RIGHT and AUX buses. In this way, a mono signal is sent to all output buses at the same time.

# ULTRAZONE ZMX8210

▲ In stereo mode (switch not pressed), the signal of the L input is sent to the LEFT bus, the R input is sent to the RIGHT bus and a mixed L/R signal is sent to the AUX bus.

- 8 LEDs: These have the same function as the control 6. In stereo mode, the LEDs show the summed level of the input signals L and R.
- 9 LEVEL: This has the same function as the control 5. In stereo mode, the control adjusts the volume level of the L/R signal.
- 10 CH SELECT: This switch is used either to activate channel 7 or 8. The active channel is indicated by the glowing of the corresponding LED.

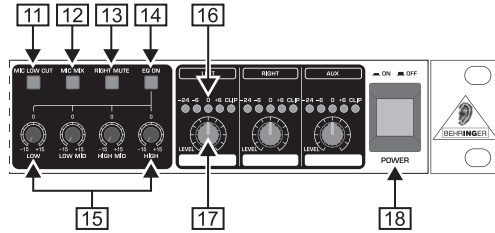

Fig. 2.2: Controls of the ZMX8210

## Main section

- 11 MIC LOW CUT: This switch cuts low-frequency rumble below 100 Hz
- 12 MIC MIX: This switch removes the signal of channels 1 – 6 from the remote control function, allowing only the output volume of channels 7/8 on the LEFT/RIGHT bus to be remote controlled. When the switch is not pressed, the total volume of all channels fed to the LEFT/RIGHT bus are remote controlled.
- 13 RIGHT MUTE: This switch excludes the RIGHT bus from the Mute function. This is helpful when using the RIGHT and LEFT buses for different zones (rooms).
  - ▲ When the switch is pressed, the signal of channels 1 – 8, which is dependent on the signal level of channel 1, is muted on both the LEFT and RIGHT bus. This occurs when the input level of channel 1 drops below the specified threshold value (THRESH 4).
  - ▲ When the switch is not pressed, only the LEFT bus is muted while the RIGHT bus continues to transmit a signal, provided the individual channels have been routed accordingly.
- 14 EQ ON: The switch activates the equalizer 15 for the LEFT and RIGHT bus.
- 15 LOW/LOW MID/HIGH MID/HIGH: This knob adjusts the boost/cut of factory-preset frequencies as follows:
  - ▲ LOW: This boosts/cuts frequencies below 70 Hz by a maximum of ±15 dB.
  - ▲ LOW MID: This boosts/cuts frequencies around 300 Hz by a maximum of ±15 dB.
  - ▲ HIGH MID: This boosts/cuts frequencies around 3 kHz by a maximum of ±15 dB.
  - ▲ HIGH: This boosts/cuts frequencies above 10 kHz by a maximum of ±15 dB.

## Buses

- 16 LEDs: When the CLIP LED lights up, attenuate the output level by using the LEVEL knob 17 to avoid clipping.
- 17 LEVEL: This knob adjusts the output level of the bus outputs OUT L, OUT R and AUX.

## Mains

- 18 POWER: The POWER switch powers up the mixer. The POWER switch should be in the Off position when connecting the unit to the mains.

⚠ To disconnect the unit from the mains, please pull the mains plug. When using the unit, make sure that the mains plug is readily accessible. When using the unit mounted in a rack, please make sure that you can easily disconnect the unit from the mains by using a plug or a circuit breaker on the backside.

⚠ Please note: The POWER switch does not entirely disconnect the unit from the mains when turned off. For this reason, disconnect the cable from the mains plug when the unit is not used for a long period.

SERIAL NUMBER: The serial number is found on the rear panel. It is required for online registration.

## 2.2 Rear panel

The BUS LINKS connector as well as the channel inputs 7 and 8 are unbalanced. The other PCB inputs and outputs are balanced. To use balanced connectors for unbalanced connections, insert a jumper wire between the ground pin (m) and the negative pin (-).

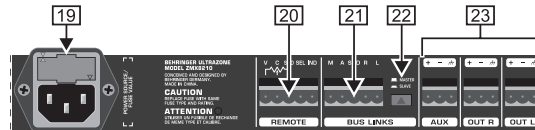

Fig. 2.3: Connections of the ZMX8210

- 19 FUSEHOLDER/IEC power receptacle: The connection to the mains is established through an IEC connector. It meets all of the international safety certification requirements. A fitting power cord is included. When replacing the fuse, you need to use the same type.
- ⚠ Before you change the fuse, switch off the device and pull the plug to avoid electric shock or damage to the device.
- 20 REMOTE: This connector is used for connecting components to remote control the ZMX8210.
  - ▲ It is possible to connect a simple potentiometer to remote control the volume of the LEFT and RIGHT buses (see Chapter 3.1.3).
  - ▲ Connect a push-button switch and two control diodes to remote control the CH SELECT switch 10 of channels 7 and 8 (see Chapter 3.1.3).
- 21 BUS LINKS: Use this connector to link two ZMX8210s together to provide additional inputs (signals). The three output buses LEFT/RIGHT/AUX are linked together using the connector. The mute signal of the ZMX8210 which is set to be the master is also transmitted so that the mute function of the master is also able to mute the buses of the slave.
- 22 SLAVE/MASTER: The switch places the ZMX8210 in the master or slave mode of operation.
  - When the switch
    - ▲ is pressed, the ZMX8210 is placed in the slave mode of operation.
    - ▲ is not pressed, the ZMX8210 is placed in the master mode of operation.
- ⚠ The ZMX8210 needs to be used in master mode when no additional units are connected!
- ⚠ When more than one ZMX8210 are connected, only one unit is allowed to be in master mode. The other units need to be placed in the slave mode of operation.
- 23 AUX/OUT R/OUT L: Balanced signal outputs for buses AUX, RIGHT and LEFT.

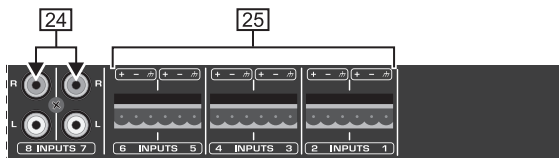

Fig. 2.4: Connections of the ZMX8210

- 24 INPUTS 7 – 8: Unbalanced signal inputs for channels 7 – 8. The connections are RCA connectors.
- 25 INPUTS 1 – 6: Balanced signal inputs for channels 1 – 6.

## 3. Application

The ZMX8210 is a user-friendly rack mixer which is principally used for fixed installations to direct public address in different zones or facilities, such as cafés, practices and houses of worship. With one unit, you can provide a maximum of three zones with different signals.

In case you need to use further signals, simply link to units together. The ZMX8210 can handle line-level sources, dynamic microphones and phantom-powered capacitor microphones as input signals.

### 3.1 Examples of application

In comparison to conventional rack mixers, the ZMX8210 offers several advantages for fixed installations and PA equipment that is being used by laymen. With the Euro-type connectors and the easy usability, the ZMX8210 optimally fulfills the requirements of these kind of applications.

#### 3.1.1 Directing public address to up to three zones

The following application example shows a typical cabling of three zones in mono mode. Distribute the signal to zones 1 – 3 by using the routing switches (L, R, AUX) of the particular input channel. Instead of three independent mono zones, it is also possible to have one stereo zone (LEFT / RIGHT bus) and one mono zone (AUX bus).

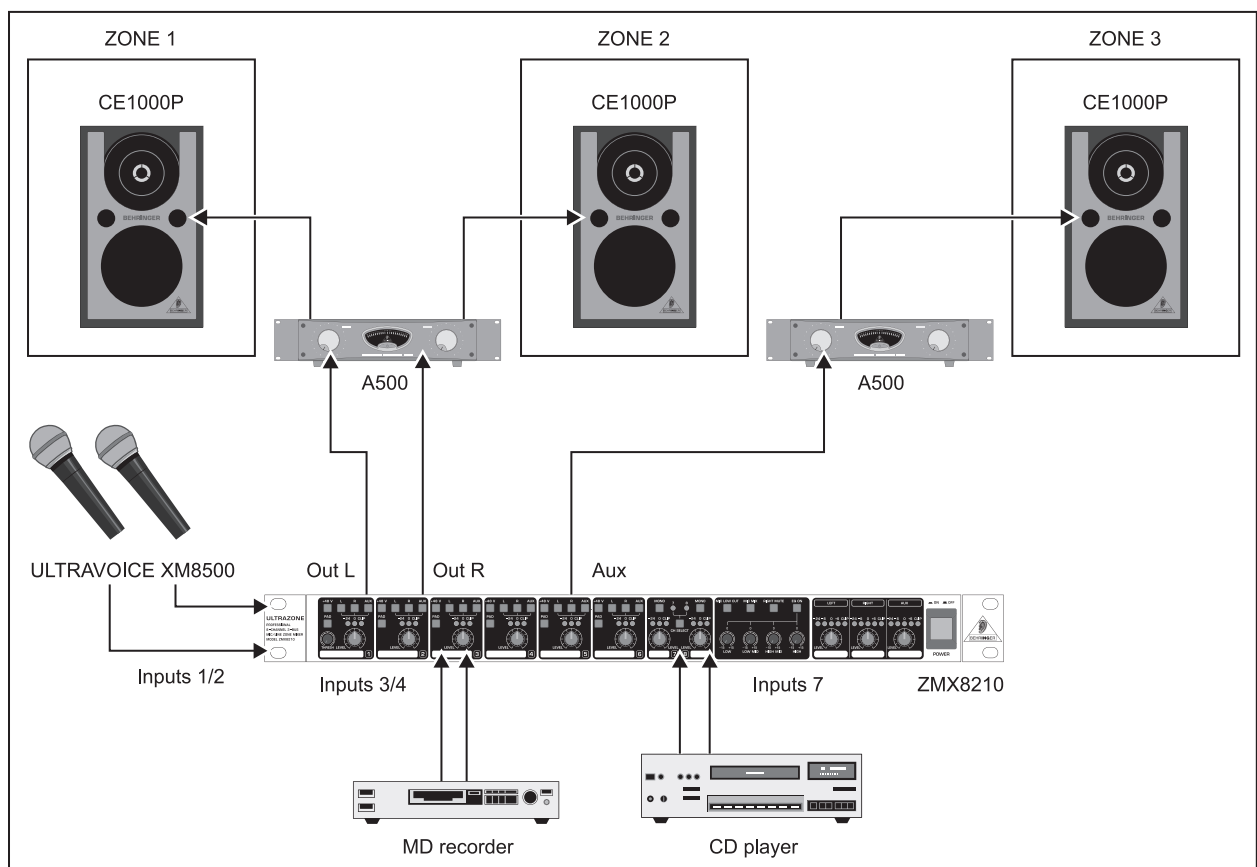

Fig. 3.1: Example of using three zones

#### 3.1.2 Using multiple ZMX8210s

In case the eight input channels of the ZMX8210 are not enough, you can link two units together by using the BUS LINKS connectors. The output buses of the two units are connected by routing the input signals of both units to the output buses. This gives you additional inputs.

The output signal can be on both units. To use two units together, please complete the following steps:

- 1) Set one unit to master mode and the second to slave mode by using the SLAVE/MASTER switch [22].
- 2) Using a shielded, 4-pin conductor cable to connect the BUS LINKS connector of the MASTER unit to the corresponding connector of the SLAVE unit.

#### 3.1.3 Remote control of the ZMX8210

The ZMX8210 provides a 5-pin REMOTE connector to remote control

- ▲ the volume level of the LEFT and RIGHT buses.
- ▲ channel selection of channels 7 and 8.

The remote control can be realized by using simple components.

##### Volume level of the LEFT and RIGHT buses

To be able to remote control the volume level of the LEFT and RIGHT buses, you need a potentiometer. Use a

- ▲ 10 kΩ potentiometer to achieve a maximum attenuation of 30 dB.
- ▲ 100 kΩ potentiometer to achieve a maximum attenuation of 60 dB.

# ULTRAZONE ZMX8210

Connect the potentiometer to pins V and SHD. Connect the mid tap to pin C (see Fig. 3.2).

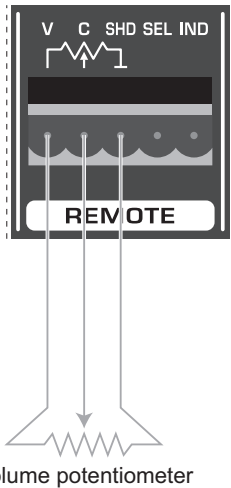

Fig. 3.2: Remote volume control connection with potentiometer

Alternatively, you can control the volume by using a positive control voltage of max. 11 V DC. The voltage needs to be inserted between the pins SHD and C.

**When using a voltage source to remote control the volume level, make sure that the control voltage does not exceed 11 V DC or else your unit could be damaged.**

### Selecting stereo channels 7 and 8

To select the stereo channels 7 and 8, you need a push-button switch and optionally two LEDs.

Connect the push-button switch to pins SHD and SEL. You can add two LEDs to indicate the selected channel. They have to be connected in parallel with a reverse polarity between the pins IND and SHD (see Fig. 3.3).

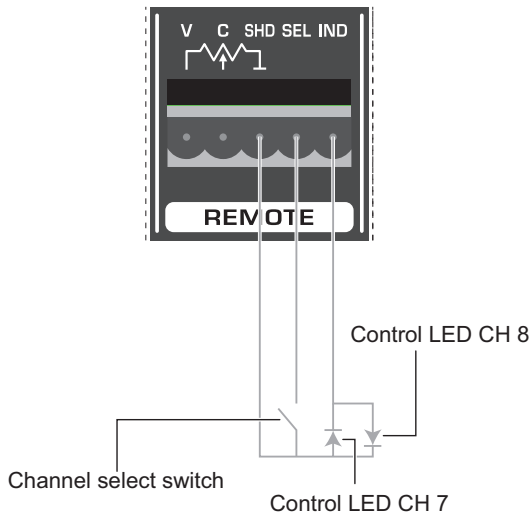

Fig. 3.3: Connection with push-button switch and two LEDs for channel selection

## 3.2 Basic operation

Using the ZMX8210 is easy to learn and is very similar to using a standard mixer. Complete the following steps:

- 1) Hook up the unit as described in Chapter 3.1.
- 2) Adjust the LEFT, RIGHT and AUX LEVEL knobs [17] to center position and turn the LEVEL knobs [5] of each channel fully to the left.
- 3) Turn on the ZMX8210 and the other devices you want to use (amplifier and loudspeakers last).
- 4) Apply an audio signal (line or microphone signal) to an input channel.
- 5) Press the +48 V push-button switch [2] in case you want to use a capacitor microphone.
- 6) Press the push-button switches L, R and AUX [3] to select the buses to which the input signals are sent.
- 7) Turn the LEVEL knob of the corresponding channel to the right until

- ▲ you have reached the required volume level
- ▲ or the 0 db LED glows continuously.

If the CLIP LED lights up, you need to adjust the level by slowly turning the knob to the left. For especially strong input signals, use the PAD push-button switch [1] to attenuate the signal further.

- 8) Repeat steps 4 to 7 with additional signal sources. Use channels 7 or 8 for stereo signal sources.
- 9) In case you are using a microphone, press the MIC LOW CUT push-button switch [11] to reduce low-frequency rumble such as subsonic noise.
- 10) Press the EQ ON push-button switch [14] and adjust the LOW, LOW MID, HIGH MID and HIGH knobs of the equalizer section [15] to modify the sound.
- 11) Use the LEVEL knobs of the LEFT, RIGHT and AUX buses [17] to adjust the volume level of the OUT L, OUT R and AUX outputs (zones).

## 4. Installation

### 4.1 Rack mounting

The unit requires the height of 1 U to fit within a 19" rack. Please make sure to provide approximately 4" of space for the connectors on the rear panel. Please use M6 rack screws and nuts when rack-mounting the unit.

### 4.2 Audio connections

The ZMX8210 connections are Euro-type connectors. You require special PCB connectors for the cabling. You can purchase the connectors at well-assorted electronics retailers. The ZMX8210 connectors' pin assignment is printed on the rear panel of the unit. Alternatively, refer to the following diagrams.

#### INPUTS / AUX / OUT R / OUT L

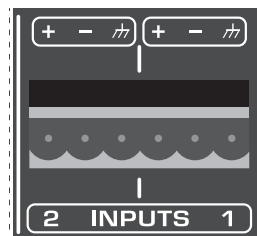

Fig. 4.1: Pin assignment of the INPUTS connectors



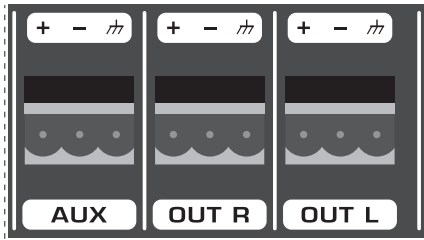

Fig. 4.2: Pin assignment of the output bus connectors

- +**: Signal (positive / balanced)
- : Signal (negative / balanced)
- m**: Ground

Use all three pins for a balanced connection.

For an unbalanced connection, use pins *m* and *+* and insert a jumper wire between pins *m* and *-*.

**BUS LINKS**

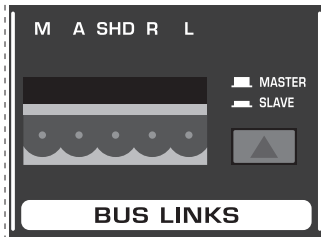

Fig. 4.3: Pin assignment of the BUS LINKS connector

- M**: M(UTE) bus signal link
- A**: A(UX) bus signal link (unbalanced)
- SHD**: SH(IEL)D signal link (shield)
- R**: R(IGHT) bus signal link (unbalanced)
- L**: L(EFT) bus signal link (unbalanced)

**REMOTE**

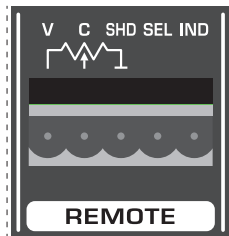

Fig. 4.4: Pin assignment of the REMOTE connector

- V**: V(OLUME) connection to the potentiometer (potential)
- C**: C(ONTROL) connection to the potentiometer (mid tap)
- SHD**: SH(IEL)D connection (shield)
- SEL**: SEL(ECT) connection to the push-button switch
- IND**: IND(ICATOR) connection to the LEDs

## 5. Specifications

<b>INPUTS 1 – 6</b>	
Type	Euro-type connector, electronically balanced
Impedance	3 k $\Omega$ balanced, 1.5 k $\Omega$ unbalanced (with PAD)
Max. input level	+ 12 dBu (with PAD)
Max. gain	40 dB
Crosstalk	> 63 dB @ 1 kHz
Common-mode rejection ratio (CMRR)	> 75 dB @ 1 kHz, 22 Hz – 22 kHz
Equivalent input noise (EIN)	-116 dBu A-weighted; terminated with 150 $\Omega$
<b>INPUTS 7 – 8</b>	
Type	RCA connectors, unbalanced
Impedance	10 k $\Omega$ , unbalanced
Max. input level	+ 15 dBu
Max. gain	15 dB
<b>OUT L, OUT R, AUX</b>	
Type	Euro-type connector, balanced
Max. gain	22 dB
Max. gain (input/output)	62 dB (without PAD)
Impedance	60 $\Omega$ , unbalanced, 120 $\Omega$ , balanced
Max. output level	+ 21 dBu unbalanced/balanced
Crosstalk (output/output)	> 63 dB @ 1 kHz
Noise (all level controls down)	-105 dBu A-weighted
Signal-to-noise ratio	87 dB @ 0 dB A-weighted
<b>BUS LINKS</b>	
Type	Euro-type connector, unbalanced
Impedance	approx. 150 $\Omega$
Max. output level	+ 21 dBu
<b>REMOTE</b>	
Type	Euro-type connector
Volume control	30 dB attenuation with 10 k $\Omega$ potentiometer (not included) 60 dB attenuation with 100 k $\Omega$ potentiometer (not included)
Channel select 7/8	Push-button switch (1 pin) required (not included)
<b>EQ</b>	
MIC LOW CUT	High-pass filter; Cutoff frequency: 100 Hz
LOW	$\pm$ 15 dB @ 70 Hz
LOW MID	$\pm$ 15 dB @ 300 Hz
HIGH MID	$\pm$ 15 dB @ 3 kHz
HIGH	$\pm$ 15 dB @ 10 kHz
<b>SYSTEM SPECIFICATIONS</b>	
Frequency response	20 Hz – 22 kHz $\pm$ 0.5 dB
Distortion (THD+N)	< 0.05 %
<b>POWER SUPPLY</b>	
Power consumption	max. 25 W
Fuse	T 630 mA H 250 V (100 – 120 V $\sim$ , 50/60 Hz) T 315 mA H 250 V (220 – 230 V $\sim$ , 50/60 Hz)
<b>DIMENSIONS/WEIGHT</b>	
Dimensions	approx. 1 3/4" x 19" x 8 1/2" (approx. 44.5 mm x 482.6 mm x 217 mm)
Weight	approx. 4.9 lb. (2.2 kg)

BEHRINGER is constantly striving to maintain the highest professional standards. As a result of these efforts, modifications may be made from time to time to existing products without prior notice. Specifications and appearance may differ from those listed or illustrated.

## 6. Warranty

### § 1 Other warranty rights and national law

1. This warranty does not exclude or limit the buyer's statutory rights provided by national law, in particular, any such rights against the seller that arise from a legally effective purchase contract.
2. The warranty regulations mentioned herein are applicable unless they constitute an infringement of national warranty law.

### § 2 Online registration

Please do remember to register your new BEHRINGER equipment right after your purchase by visiting [www.behringer.com](http://www.behringer.com) (alternatively [www.behringer.de](http://www.behringer.de)) and kindly read the terms and conditions of our warranty carefully. Registering your purchase and equipment with us helps us process your repair claims quicker and more efficiently.

*Thank you for your cooperation!*

### § 3 Warranty

1. BEHRINGER (BEHRINGER International GmbH including all BEHRINGER subsidiaries, except BEHRINGER Japan) warrants the mechanical and electronic components of this product to be free of defects in material and workmanship for a period of one (1) year<sup>1</sup> from the original date of purchase, in accordance with the warranty regulations described below. If the product shows any defects within the specified warranty period that are not excluded from this warranty as described under § 5, BEHRINGER shall, at its discretion, either replace or repair the product using suitable new or reconditioned parts. In the case that other parts are used which constitute an improvement, BEHRINGER may, at its discretion, charge the customer for the additional cost of these parts.
2. If the warranty claim proves to be justified, the product will be returned to the user freight prepaid.
3. Warranty claims other than those indicated above are expressly excluded.

### § 4 Return authorization number

1. To obtain warranty service, the buyer (or his authorized dealer) must call BEHRINGER during normal business hours BEFORE returning the product. All inquiries must be accompanied by a description of the problem. BEHRINGER will then issue a return authorization number.
2. Subsequently, the product must be returned in its original shipping carton, together with the return authorization number to the address indicated by BEHRINGER.
3. Shipments without freight prepaid will not be accepted.

### § 5 Warranty regulations

1. Warranty services will be furnished only if the product is accompanied by a copy of the original retail dealer's invoice. Any product deemed eligible for repair or replacement under the terms of this warranty will be repaired or replaced.

2. If the product needs to be modified or adapted in order to comply with applicable technical or safety standards on a national or local level, in any country which is not the country for which the product was originally developed and manufactured, this modification/adaptation shall not be considered a defect in materials or workmanship. The warranty does not cover any such modification/adaptation, irrespective of whether it was carried out properly or not. Under the terms of this warranty, BEHRINGER shall not be held responsible for any cost resulting from such a modification/adaptation.
3. Free inspections and maintenance/repair work are expressly excluded from this warranty, in particular, if caused by improper handling of the product by the user. This also applies to defects caused by normal wear and tear, in particular, of faders, crossfaders, potentiometers, keys/buttons, tubes, guitar strings, illuminants and similar parts.
4. Damage/defects caused by the following conditions are not covered by this warranty:
  - ▲ improper handling, neglect or failure to operate the unit in compliance with the instructions given in BEHRINGER user or service manuals;
  - ▲ connection or operation of the unit in any way that does not comply with the technical or safety regulations applicable in the country where the product is used;
  - ▲ damage/defects caused by force majeure or any other condition that is beyond the control of BEHRINGER.
5. Any repair or opening of the unit carried out by unauthorized personnel (user included) will void the warranty.
6. If an inspection of the product by BEHRINGER shows that the defect in question is not covered by the warranty, the inspection costs are payable by the customer.
7. Products which do not meet the terms of this warranty will be repaired exclusively at the buyer's expense. BEHRINGER will inform the buyer of any such circumstance. If the buyer fails to submit a written repair order within 6 weeks after notification, BEHRINGER will return the unit C.O.D. with a separate invoice for freight and packing. Such costs will also be invoiced separately when the buyer has sent in a written repair order.

### § 6 Warranty transferability

This warranty is extended exclusively to the original buyer (customer of retail dealer) and is not transferable to anyone who may subsequently purchase this product. No other person (retail dealer, etc.) shall be entitled to give any warranty promise on behalf of BEHRINGER.

### § 7 Claim for damage

Failure of BEHRINGER to provide proper warranty service shall not entitle the buyer to claim (consequential) damages. In no event shall the liability of BEHRINGER exceed the invoiced value of the product.

<sup>1</sup> Customers in the European Union please contact BEHRINGER Germany Support for further details.

Technical specifications and appearance are subject to change without notice. The information contained herein is correct at the time of printing. BEHRINGER accepts no liability for any loss which may be suffered by any person who relies either wholly or in part upon any description, photograph or statement contained herein. Colors and specifications may vary slightly from product. Products are sold through our authorized dealers only. Distributors and dealers are not agents of BEHRINGER and have absolutely no authority to bind BEHRINGER by any express or implied undertaking or representation. No part of this manual may be reproduced or transmitted in any form or by any means, electronic or mechanical, including photocopying and recording of any kind, for any purpose, without the express written permission of BEHRINGER International GmbH.

## FEDERAL COMMUNICATIONS COMMISSION COMPLIANCE INFORMATION

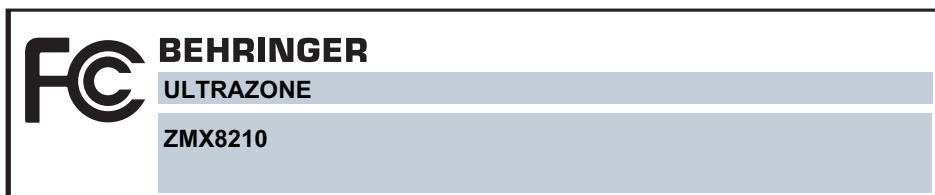

Responsible party name: **BEHRINGER USA, Inc.**

Address: **18912 North Creek Parkway, Suite 200  
Bothell, WA 98011, USA**

Phone/Fax No.: **Phone: +1 425 672 0816,  
Fax: +1 425 673 7647**

hereby declares that the product(s)



**ULTRAZONE ZMX8210**

complies/comply with the FCC rules as mentioned in the following paragraph:

This device complies with Part 15 of the FCC rules. Operation is subject to the following two conditions: (1) this device may not cause harmful interference, and (2) this device must accept any interference received, including interference that may cause undesired operation.

**Note:** This equipment has been tested and found to comply with the limits for a Class B digital device, pursuant to part 15 of the FCC Rules. These limits are designed to provide reasonable protection against harmful interference in a residential installation. This equipment generates, uses and can radiate radio frequency energy and, if not installed and used in accordance with the instructions, may cause harmful interference to radio communications. However, there is no guarantee that interference will not occur in a particular installation. If this equipment does cause harmful interference to radio or television reception, which can be determined by turning the equipment off and on, the user is encouraged to try to correct the interference by one or more of the following measures:

- ▲ Reorient or relocate the receiving antenna.
- ▲ Increase the separation between the equipment and receiver.
- ▲ Connect the equipment into an outlet on a circuit different from that to which the receiver is connected.
- ▲ Consult the dealer or an experienced radio/TV technician for help.

### **Important information:**

Changes or modifications to the equipment not expressly approved by BEHRINGER USA can void the user's authority to use the equipment.

[www.behringer.com](http://www.behringer.com)

