

User's Manual

MAXIDRIVE3.4 PC

3 – WAY STEREO
DIGITAL CROSSOVER

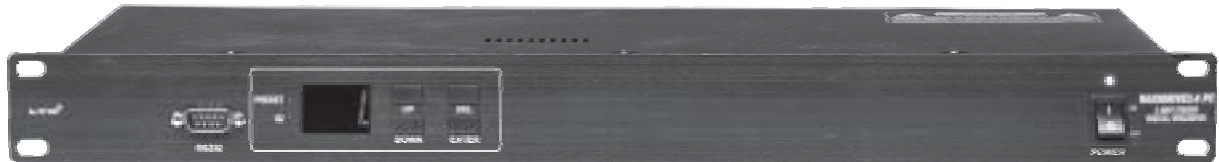

www.altoproaudio.com
Version 1.5 February 2006

— English —

SAFETY RELATED SYMBOLS



This symbol, wherever used, alerts you to the presence of un-insulated and dangerous voltages within the product enclosure. These are voltages that may be sufficient to constitute the risk of electric shock or death.



This symbol, wherever used, alerts you to important operating and maintenance instructions. Please read.



Protective Ground Terminal



AC mains (Alternating Current)



Hazardous Live Terminal

ON: Denotes the product is turned on.

OFF: Denotes the product is turned off.

WARNING

Describes precautions that should be observed to prevent the possibility of death or injury to the user.

CAUTION

Describes precautions that should be observed to prevent damage to the product.



Disposing of this product should not be placed in municipal waste and should be separated for separate collection.

WARNING

• Power Supply

Ensure that the mains source voltage (AC outlet) matches the voltage rating of the product. Failure to do so could result in damage to the product and possibly the user.

Unplug the product before electrical storms occur and when unused for long periods of time to reduce the risk of electric shock or fire.

• External Connection

Always use proper ready-made insulated mains cabling (power cord). Failure to do so could result in shock/death or fire. If in doubt, seek advice from a registered electrician.

• Do Not Remove Any Covers

Within the product are areas where high voltages may present. To reduce the risk of electric shock do not remove any covers unless the AC mains power cord is removed.

Covers should be removed by qualified service personnel only.

No user serviceable parts inside.

• Fuse

To prevent fire and damage to the product, use only the recommended fuse type as indicated in this manual. Do not short-circuit the fuse holder. Before replacing the fuse, make sure that the product is OFF and disconnected from the AC outlet.

• Protective Ground

Before turning the product ON, make sure that it is connected to Ground. This is to prevent the risk of electric shock.

Never cut internal or external Ground wires. Likewise, never remove Ground wiring from the Protective Ground Terminal.

• Operating Conditions

Always install in accordance with the manufacturer's instructions.

To avoid the risk of electric shock and damage, do not subject this product to any liquid/rain or moisture. Do not use this product when in close proximity to water.

Do not install this product near any direct heat source.

Do not block areas of ventilation. Failure to do so could result in fire.

Keep product away from naked flames.

IMPORTANT SAFETY INSTRUCTIONS

Read these instructions

Follow all instructions

Keep these instructions. Do not discard.

Heed all warnings.

Only use attachments/accessories specified by the manufacturer.

• Power Cord and Plug

Do not tamper with the power cord or plug. These are designed for your safety.

Do not remove Ground connections!

If the plug does not fit your AC outlet seek advice from a qualified electrician.

Protect the power cord and plug from any physical stress to avoid risk of electric shock.

Do not place heavy objects on the power cord. This could cause electric shock or fire.

• Cleaning

When required, either blow off dust from the product or use a dry cloth.

Do not use any solvents such as Benzol or Alcohol. For safety, keep product clean and free from dust.

• Servicing

Refer all servicing to qualified service personnel only.

Do not perform any servicing other than those instructions contained within the User's Manual.

PREFACE

Dear Customer:

Thanks for choosing MAXIDRIVE3.4 PC 3 - Way Stereo Digital Crossover and thanks for choosing one of the results of ▲LTO AUDIO TEAM job and researches.

For our ▲LTO AUDIO TEAM, music and sound are more than a job...are first of all passion and let us say our obsession!

We have been designing professional audio products for a long time in cooperation with some of the major brands in the world in the audio field.

The ▲LTO line presents unparalleled analogue and digital products made by Musicians for Musicians in our R&D centers in Italy, Netherlands, United Kingdom and Taiwan. The core of our digital audio products is a sophisticated DSP (Digital Sound Processor) and a large range of state of the art algorithms which have been developed by our Software Team for the last 8 years.

Because we are convinced you are the most important member of ▲LTO AUDIO TEAM and the one confirming the quality of our job, we would like to share with you our work and our dreams, paying attention to your suggestions and your comments.

Following this idea we create our products and we will create the new ones! From our side, we guarantee you and we will guarantee you also in future the best quality, the best fruits of our continuous researches and the best prices.

Our MAXIDRIVE3.4 PC 3 - Way Stereo Digital Crossover is the result of many hours of listening and tests involving common people, area experts, musicians and technicians. The results of this effort is a DSP hi-performance equalizer that can be used in applications as musical performances, Installation and sound reinforcement. Besides we offer to you a number of factory EQ curves that we collected and transformed in presets now available in our small, efficient and easy to use MAXIDRIVE3.4 PC.

Nothing else to add, but that we would like to thank all the people that made the MAXIDRIVE3.4 PC a reality available to our customers, and thank our designers and all the ▲LTO staff, people who make possible the realization of products containing our idea of music and sound and are ready to support you, our Customers, in the best way, conscious that you are our best richness.

Thank you very much

▲LTO AUDIO TEAM

TABLE OF CONTENTS

1. INTRODUCTION	4
2. FEATURES	4
3. CONTROL ELEMENTS	4
3.1 The Front Panel	
3.2 The Rear Panel	
4. GETTING STARTED	6
4.1 Configuration of the System	
4.2 Memory Initialization	
4.3 Communication	
4.4 First Steps with the PC Editor	
4.5 Edit Mode	
4.6 Help File	
4.7 Introduction to the PC Editor	
5. PARAMETER MENUS DESCRIPTION	9
6. WORKING WITH PRESETS	12
7. CONNECTIONS	12
8. APPLICATION	13
8.1 Factory Preset Configuration	
8.2 Organization	
9. TECHNICAL SPECIFICATIONS	19
10. WARRANTY	20

1. INTRODUCTION

Your MAXIDRIVE3.4 PC is a 3-Way Stereo Digital Crossover and it is a powerful versatile signal processor. The apparatus will provide 3, 4, 5 or 6-way mono X-over with 6 outputs. Thanks to the use of selected and expensive components, the performances of MAXIDRIVE3.4 PC are worth much more than its price: you can set the input and output routing configuration through recalling one of the presets included in the internal memory or PC editor software. For further detail, please read the user manual carefully.

2. FEATURES

- Single rack unit
- Easy to operate front panel controls
- 2 input connectors are compatible with balanced XLR and JACK
- 6 outputs are balanced XLR-M connector
- A/D and D/A converters for a 117dB dynamic range
- Delay lines up to 2.5s for each input and up to 300ms for each output
- 10 factory presets and 64 user presets by large memory capacity
- Switching power supply
- Remote control
- Manufactured under QS9000, VDA6.1 certified management system

3. CONTROL ELEMENTS

3.1 The Front Panel

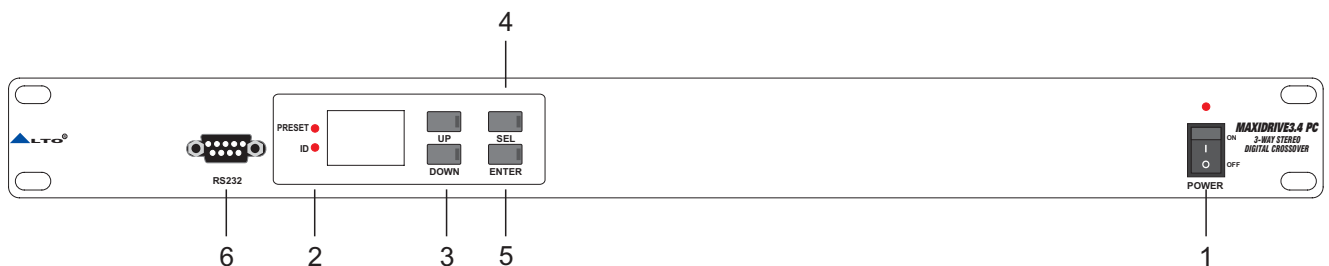

1. Power Switch

The switch is used to turn the main POWER on and off.

Note: Before turning on the unit, please make sure the amplifiers of sound system are off to avoid the annoying and sometimes dangerous signal peaks.

2. LEDs Display

The both LEDs indicate the selecting status; one is for PRESET, another for ID.

3. UP/DOWN Keys

There are 10 factory presets, 64 user presets and 32 ID selections. The both keys are used to allow you to turn over the variable presets or ID selections for achieving the proper one.

4. SEL Key

Activate the SEL key to select required PRESET LOAD or SET COMM. ID functions.

5. ENTER Key

The key allows you to access to the selected preset or ID selection.

6. RS232 Serial Communication Port

The RS232 port allows incoming and outgoing communication between the MAXIDRIVE3.4 PC and a PC.

Via connecting the MAXIDRIVE3.4 PC to a PC, all the processor functions is possible to be control remotely by ALTO editing software.

- 1>. Ensure that power to the MAXIDRIVE3.4 PC and the computer is switch off.
- 2>. Connect the MAXIDRIVE3.4 PC to the PC's RS232 serial port using a data cable with 9-pin female plugs. The required data cable is known as a 'null modem' (also data transfer) type serial interface cable. Attach the other end to the 9-pin socket situated next to the audio output terminals of the MAXIDRIVE3.4 PC.
- 3>. Turn on your audio system, including the MAXIDRIVE3.4 PC. Now boot up your computer and run the PC editor (see "Configuration of the system").

Note: MAXIEDITOR software, which is used in the unit , accepts these four COM1-COM4 connectors of PC only. So when you use USB port for connecting, please operate it as follows:

Please go to control section -> system -> DEVICE MANAGER -> advance -> COM connecting number, please select one.

Then go to the tool bar of MAXIEDITOR -> Choose "OPTION -> USB to COM" and select the right COM. Then it should be OK to link.

3.2 The Rear Panel

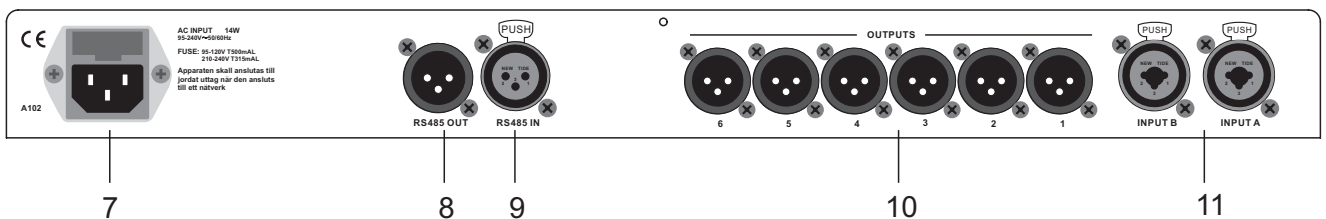

7.AC inlet and fuse holder

Use it to connect your MAXIDRIVE3.4 PC to the supplied AC cord. Please check the Voltage in your country and what voltage for your MAXIDRIVE3.4 PC is configured before attempting to connect the unit for the main AC. The fuse can protect the AC supplies circuit of the equipment.

CAUTION: If there is something wrong with the fuse or the fuse needs to change, please refer to a qualified technician. If the fuse continues to blow after replacing, discontinue using of this unit before being repaired.

8.RS485 OUT

This is the standard serial communication interface. It allows outgoing communication between a MAXIDRIVE 3.4 PC and other MAXIDRIVE3.4 PC units. The RS485 interface is very suitable for remote control over long distances (difficult with RS232 standard ports) and daisy-chaining several MAXIDRIVE3.4 PC.

9.RS485 IN

The function of the RS485 IN interface is opposite to RS485 OUT. It allows incoming communication between a MAXIDRIVE3.4 PC and other MAXIDRIVE3.4 PC units. The RS485 interface is very suitable for remote control over long distances (Difficult with RS232 standard ports) and for daisy-chaining several MAXIDRIVE3.4 PC.

10.OUTPUTS

These (Outputs1~6) are balanced XLR-M connectors. The high quality, low noise, 20 bit converters can make A/D conversion.

11.INPUTS

INPUT A and INPUT B are compatible with balanced XLR and JACK. They are audio connectors of the respective sections. The high quality, low noise, 20 bit converters can make A/D conversion.

4. GETTING STARTED

4.1 Configuration of the System

At first, switch off the equipment, carry out the audio and power connection from the various components of your sound system.

Then, connect the main cord and only switch on the MAXIDRIVE3.4 PC. The display will show the data regarding with the operating system release for a few seconds.



1.0

Meanwhile, the system will restore the exact operating conditions at the time of switching off.

- Click the SEL key to select proper PRESET or ID status.
- When PRESET LED lit, you can use the UP and DOWN keys to select factory PRESETs (1 ~ 10) or user PRESETs (1. ~ 64.), then you will find the data on LCD twinkling all the while.

The factory programmed, cannot be permanently changed. These include all the system's usable configurations. For further detail, please refer the "Factory Preset Configuration" on application section.

Via the PC editor software, the user PRESETs can be programmed by users.



1

(Example: Factory PRESET)



64.

(Example: User PRESET)

- When ID LED lit, the LCD will display the ID number, there are total 32 IDs, and the data twinkling all the while.
- Press ENTER, the display shows the PRESET/ID loaded in the units memory.

4.2 Memory Initialization

- 1>. To activate the MEMORY PUFF function the SEL & UP keys must be activated and kept down during turn-on.
- 2>. At turn-on the display shows AL. With both the PRESET and ID LEDs on while a complete memory initialization is in progress.



AL.

- 3>. If a power failure occurred while the machine was saving some data to memory, the memory is partially initialized to avoid inconsistent data that could cause the machine to behave improperly.
- 4>. In this case the display show S. with the ID LED on if the machine is initializing the SETUP memory area, if the display shows nn. with both the PRESET and ID LEDs on the machine is initializing the SETUP and PRESET nn memory areas.



S.



nn.

4.3 Communication

- 1>. When the MAXIDRIVE3.4 PC is connected by its RS232 port to a PC running the MAXIDRIVE3.4 editor, the display shows CG (Comm. Gateway).



CG

- 2>. When the MAXIDRIVE3.4 PC is connected by its RS485 port to another MAXIDRIVE3.4 PC running as a gateway the display shows CS (Comm. Slave).



4.4 First Steps with the PC Editor

To avoid accidentally overwriting an existing PRESET, it is important that you follow the correct routine when initiating a session between the MAXIDRIVE3.4 PC and your computer.

- 1>. With the MAXIDRIVE3.4 PC powered up and connected to your PC's serial port as described, *Run* the PC Editor program by selecting the *MAXI EDITOR* icon in the Windows *PROGRAMS* menu.
- 2>. The PC Editor should now load. A welcome screen will appear. This closes after 5 seconds (or click on it). Select *NEW* from the *FILE* menu. A window will open showing several different model names, because the same software is used for some of our pro audio models. Select MAXIDRIVE3.4 PC and click *OK*. You will then be presented with 2 options *NEW UNIT* and *NETWORK SCAN*.

If your MAXIDRIVE3.4 PC has already been installed and set-up and you now wish to view and/or modify some parameters, do the following:

Select *NETWORK SCAN*. The program will scan your PC's serial ports. When *Done*, it will present a list of IDs. The **ID number** of the MAXIDRIVE3.4 PC is **1** (this cannot be changed). The ID list will show if the MAXIDRIVE 3.4 PC (ID 1) is correctly connected or not. Pressing *OK* will prompt the system to retrieve (upload) all the parameters and all previously saved USER PRESETS from the MAXIDRIVE3.4 PC to your computer. A window will automatically open on your computer screen. You can now view the settings and edit them (depending on the *Lock* mode).

If your MAXIDRIVE3.4 PC has not been set-up yet, or if you want to replace the existing set-up, you can create a new named profile (*NEW UNIT*) within the PC Editor. Here's how:

Select *NEW* from the *FILE* menu, then MAXIDRIVE3.4 PC and click *OK*. Select *NEW UNIT*. In the window that appears, type a new name for the unit you are creating (this is optional). The Input/Output *GANGING* (* *more Information follows*) options should generally be left at their default settings (unchecked).

Press *OK* and a window corresponding to the unit you have just named will open up with the factory default set-up configuration and the block diagram.

Choose *ONLINE* from the *ACTIONS* menu and the PC will scan the serial port to verify that the MAXIDRIVE3.4 PC is correctly connected. The *NETWORK SCAN* window should show the system status (*UNIT CONNECTED* or *NOT CONNECTED*). Pressing *OK* will cause all the parameters set in the PC Editor to be downloaded to the MAXIDRIVE3.4 PC. An *ONLINE* icon will appear to show that the MAXIDRIVE3.4 PC and PC are now ready to transfer control data in real-time.

* **Ganging:** The inputs and/or each pair of outputs may be "ganged" (linked together) as stereo pairs, so that changes are simultaneously applied to both channels. This is achieved via the *MODIFY UNIT* option in the *ACTIONS* menu of the PC Editor. However, if you intend to use the channel delay function for speaker 'time alignment' then you should NOT gang the channels.

Every time a *download* is made to the MAXIDRIVE3.4 PC, the user presets in the internal memory (and any unsaved set-up you were working on) are overwritten. Selecting *OFFLINE* from the *ACTIONS* menu will cause the PC to be disconnected from the MAXIDRIVE3.4 PC. **Be aware** that immediately selecting *ONLINE* again will prompt the PC Editor to perform a new scan of the network and automatically download the settings from the PC to the MAXIDRIVE3.4 PC.

If you do not wish this to happen (i.e. if you do not wish to overwrite the current data in the MAXIDRIVE3.4 PC), then you must initiate a new session by closing the current window and then selecting *NETWORK SCAN* (*File > New > MAXIDRIVE3.4 PC > Network Scan*) so that the MAXIDRIVE3.4 PC uploads to the PC.

Every time an *upload* is made, all the USER PRESETS stored in the MAXIDRIVE3.4 PC are transferred to the corresponding numbered presets within the PC Editor.

4.5 Edit Mode (Password Protection)

MAXIDRIVE3.4 PC incorporates a password system and your installer may have set a password to ensure that vital settings are not altered. In this case you will NOT be able to alter all of the parameters via the PC Editor. In the PC Editor, select *FILE > OPTIONS* and then the *LOCK* tab. This will present you with a menu:

Full Edit:

This is the DEFAULT mode. No password is set at the factory. From here you can lock the unit by clicking within the empty *Partial Lock* or *Total Lock* buttons. A text box will open, allowing you to enter a password of your own choice. Click *OK*. It is important that you remember this password.

Partial Lock:

In this mode, only the INPUT parameters may be edited. This is useful since it allows critical settings such as the crossover points to be locked, while still allowing the user access to some overall EQ adjustment.

To enable *Partial Lock*, a new password must be entered as above. To disable the lock, click within the empty *Full Edit* button. A text box will open. Type the password that was used to set lock mode. Press *OK*.

Total Lock:

No editing is possible in this mode. To enable *Total Lock*, a new password must be entered as above. To disable the lock, follow the same instructions for disabling *Partial Lock*.

4.6 Help File

The *HELP* file accessible from within the PC Editor will be updated as necessary. Since software updates after the printing of this manual may affect the instructions provided here, please check the Help File for any later remarks.

4.7 Introduction to the PC editor

When you launch the editor on your PC, you will see the opening screen following (later software versions may differ). Each of the numbered sections is explained in the following pages - just look for the number icons within the text.

Please note that a Windows compatible PC Editor is available for free download our web site. To get a copy, go to <http://www.proaudio.com>.

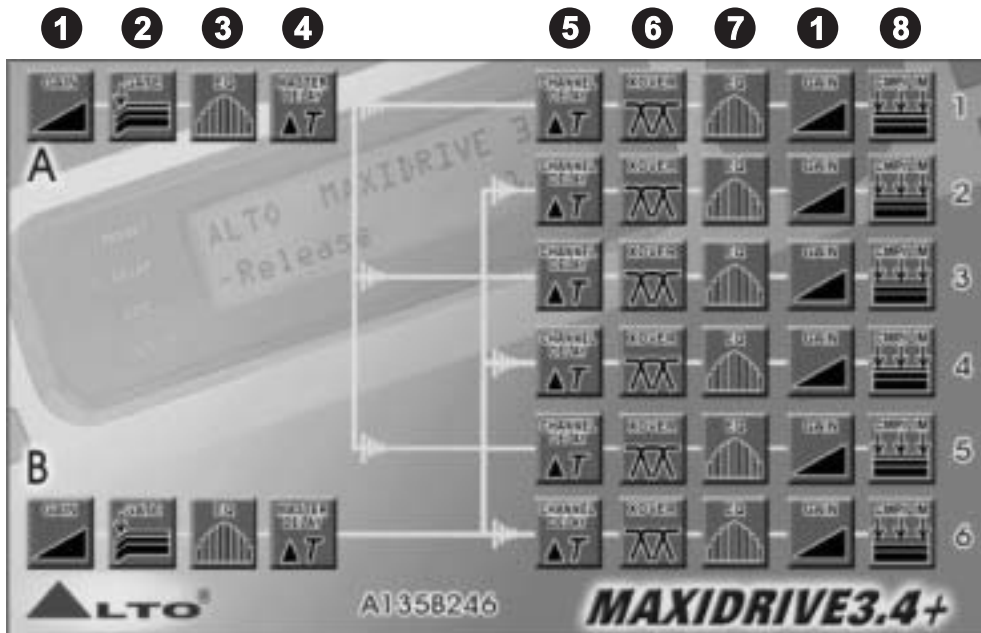

Click on one of the icons on the PC editor, a window will appear showing one of several "pages" where you can set the parameters using virtual knobs and sliders or by typing the values. Here is a brief overview of the various functions that make up the MAXIDRIVE3.4 PC editor (community software). Each is explained in more detail in the next section.

1 GAIN control section

This page presents 8 virtual slide controls, similar to what you would see on a professional sound mixing desk. From here you can adjust the input/output *LEVELS* and output channel *MUTE* and *PHASE*.

2 NOISE GATE

You can set the MAXIDRIVE3.4 PC to cut the signal if it falls below a certain level. Most often used to cut the background noise between music tracks.

3 PARAMETRIC EQUALIZATION (EQ)

Each of the channels (both inputs and outputs) has a fully variable 5-band parametric equalizer.

4 MASTER DELAY

Allows a delay to be applied to the signal fed from one or both of the input channels.

5 CHANNEL DELAY

Allows a delay to be applied in order to "time align" each individual output channel. Includes a graphical interface of 6 virtual speakers.

6 CROSSOVER (XOVER)

The MAXIDRIVE3.4 PC is equipped with independent HIGH-PASS and LOW-PASS filters on each of the 6 output channels. For each filter there are 10 different filter type/slope options.

7 PARAMETRIC EQUALIZATION (EQ)

Each of the channels (both inputs and outputs) has a fully variable 5-band parametric equalizer.

8 DYNAMIC GAIN CONTROL (CMP/LIM)

Each output channel has its own independent COMPRESSOR/LIMITER. Careful setting of the parameters will help to maintain a more consistent and pleasurable listening level and extend the performance of your speakers.

GLOBAL: Within the PC Editor's tabbed menu view, you will see a tab labelled "Global" on the far right. This window shows the response curves of all channel outputs and provides a convenient overview of your settings.

PRINT: Not a tabbed 'page' like those above, but an important function worth highlighting here. From the *FILE* menu, selecting *PRINT* provides a print-out of all the parameters of the MAXIDRIVE3.4 PC, together with the GLOBAL graph. View it before printing by selecting *PRINT PREVIEW*.

5. PARAMETER MENUS DESCRIPTION

1 GAIN control section

The MAXIDRIVE3.4 PC has no analog input or output gain controls - level adjustment is handled entirely in the digital domain. The input stage will accept a maximum input level of 2.2V rms.

Click on one of the virtual level slide controls with your PC's left mouse button and hold the button down as you move the virtual slider up or down with your cursor control. Alternatively, you can enter a dB value directly into the text box below the slider (type a value and then press *ENTER* on your PC keyboard).

Clicking on a *MUTE* button (it will then turn red) will switch out that channel (useful during fault finding and system set-up). Channel signal *PHASE* (polarity) can be set to 0 or 180 degrees. This can sometimes improve stereo imaging where speakers are mounted substantially off-axis. It can also provide a "quick fix" if you find you have wired speakers out of phase!

2 NOISE GATE

This acts rather like a water-tight valve, allowing signal to pass or not pass through it. Every audio system, especially a complex one, produces some background noise. By setting the point (level threshold) below which the gate closes, it is possible to minimize noise at those times when it is most likely to be audible, such as during the pauses between tracks on a CD.

The Noise Gate cuts signal output whenever it drops below a selectable *THRESHOLD*. The *RANGE* setting dictates the level range through which the gate will remain closed (usually this will be set to 80dB). The *ATTACK* and *RELEASE* times relate to the speed with which the Gate closes and opens. The default settings will usually be fine and provide gating that works transparently, but you can use these settings to optimize the results if you hear any side-effects.

Each gate can be switched in or out of the audio circuit by clicking on the *OFF/ON* button. The button will turn red when the Noise Gate is selected.

3 7 PARAMETRIC EQUALIZATION (EQ)

5-band full parametric equalization is provided on each of the Input and Output channels. The Center Frequency, Gain and Bandwidth are all variable. In addition, the MAXIDRIVE3.4 PC allows you to select from a list of different EQ contours.

Freq: The center frequency of each band can be set between approximately 16Hz and 16,000Hz.

Gain: The level at the chosen center frequency can be increased or reduced by 15dB.

Band: This dictates how the frequencies next to the center frequency will be affected during Gain boost or cut. With a narrow bandwidth (minimum 0.05 octave), frequencies other than the center frequency and its immediate neighbours will be largely unaltered. With a broad bandwidth (maximum 3 octaves), gain changes will be spread more widely. The effect can be seen on the PC Editor's real-time graph.

Type: This section allows several types of EQ contour to be applied. Depending on the EQ Type selected, certain parameters (Gain, Bandwidth) are automatically set (they become greyed out).

- *Peaking* - This default setting is the traditional parametric mode, allowing gain cut or boost at and around the chosen center frequency.
- *LowSh6* - This creates a shelved response with a 6dB/octave slope, with the frequency shift occurring towards the lower end of the frequency scale. Bandwidth adjustment is disabled in this mode.
- *LowSh12* - A shelved response as above but with a 12dB/octave slope.
- *HiSh6* - This creates a shelved response with a 6dB/octave slope, with the frequency shift occurring towards the higher end of the frequency scale. Bandwidth adjustment is disabled in this mode.
- *HiSh12* - A shelved response as above but with a 12dB/octave slope.
- *Notch* - The Notch filter effectively removes a slice of the signal and is useful for targeting very localised problems. It can, for example, be used as an aid to tracing spurious noises caused by vibrating panels being excited at a certain frequency. Gain adjustment is disabled in this mode.

4 5 MASTER & CHANNEL DELAY

A wide ranging amount of delay, from as little as 21 microseconds (that's 0.021ms, equivalent to a distance of a little over 7mm), can be set on each of the input and output channels. This allows the signal transmission from the various speaker drive units to be aligned to the listening position (a process known as "time alignment"). Values can be input as distance (millimetres/meters) or time (microseconds/milliseconds).

Channel (Output) Delay:

A small amount of delay can be applied to the signal from each output channel. The amount of delay is usually calculated from physical measurements of the distances between the various speakers and the driver's ears. The delay compensates for the difference in speaker mounting positions, with the speaker furthest away (commonly the woofer in the trunk) being the reference point to which all other speakers are aligned (i.e. delayed). When applied correctly to all speakers in the system, the result is an improvement in the apparent stage position, height and depth, and the location and focus of the performers on the 'virtual stage' that should extend across the dashboard. Ideally there should also be the feeling that the low bass is coming from ahead of you, even where the woofer is physically behind you.

Master (Input) Delay:

From here you can delay an input signal before it is sent to the channel routing stage, so that all the outputs fed by that input are delayed by the same amount. This feature is more applicable to PA applications, where it is used to compensate for the distance between blocks of speakers in large concert halls and stadiums, but it has applications in the car too.

For example, if you are *not* feeding your subwoofer(s) through the MAXIDRIVE3.4 PC, then you could use the Input Delays to time align your mid-woofers (for example) to the subwoofer(s) and then use the Output Delays to time align the remaining speaker drive units (i.e. the mids and tweeters) to the mid-woofers. This would ease the job of fine-tuning the alignment of the subwoofer(s) to bring the bass forward, by only having to adjust the Input Delay settings.

Alternatively, you may like to try a creative use for the Input Delay. Apply a very small amount of delay on one channel only - this can give an added sense of stereo width that, while artificial, can provide quite a striking effect.

6 CROSSOVER (XOVER)

The MAXIDRIVE3.4 PC is equipped with independent High-Pass and Low-Pass filters on each of the 6 output channels. For each filter there are 10 filter type/slope options:

- *Butterworth* type with 6dB, 12dB, 18dB or 24dB per octave slope
- *Bessel* type with 12dB, 18dB or 24dB per octave slope
- *Linkwitz-Riley* type with 12dB, 24dB or 48dB per octave slope

The different filter characteristics can be seen on the PC Editor's graphical display. For each of the filters, the crossover point can be set between approximately 16Hz and 16kHz. The filter can be bypassed by selecting *THRU*.

Using both the High-Pass and Low-Pass filters together creates what is known as a Band-Pass filter, most often used for optimizing the signal destined for midrange and mid-bass speakers. Also for subwoofers, by using the High-Pass as a subsonic filter typically in the range 16-30Hz.

Please note that choosing the Linkwitz-Riley 48dB/octave filter will reduce the number of EQ bands available on that channel.

Which filter type, slope and crossover frequency you should choose will depend on the speakers you are using. Since it is important to set-up filter points carefully to maximise speaker power handling and avoid damage, this is usually best left to a professional car audio installer.

Phase Adjustment: When using the Low-Pass filter, it is possible to adjust the phase of the signal in the low band in 5 degree steps. Combined with the 180 degrees polarity switch, it is possible to adjust the phase in the bass region through a full 360 degrees.

When making fine adjustments to signal phase in the bass region, bear in mind that phase is related to frequency. You cannot "phase-align" the entire low-frequency band, but you can align the phase of two woofers at 50Hz, for example, or whatever frequency you choose. Where dual woofers are causing some cancellation at a frequency "sweet spot" because of different mounting positions and/or mounting angles and/or vent characteristics, aligning their phase can substantially improve SPL (sound pressure level) and clarity of bass.

8 DYNAMIC GAIN CONTROL (CMP/LIM)

Each output channel has its own independent COMPRESSOR/LIMITER, allowing you to determine the amount of level gain (i.e. increase in volume) above a threshold point that you set. This helps maintain a more consistent listening level and both protects and extends the performance of your speakers. Input and Output levels and the amount of gain reduction are displayed on the PC screen in real-time as an aid to system set-up.

Threshold: Allows setting of the level above which the Comp/Limiter intervenes (compressing or limiting the signal). If the music stays below this threshold setting, the level is unchanged.

Atk/Rel: There is a choice of 3 reaction speeds combining attack and release times. You can choose whether the Comp/Limiter reacts more rapidly or slower than the default *NORMAL* setting when the signal exceeds or drops below the threshold. Set faster for high frequencies (tweeters), slower for bass frequencies. For midrange or full-range speakers, the *NORMAL* setting will generally be the optimum one. For Subwoofers, the *SLOW* setting will usually be best.

Ratio: The value selected here dictates how strongly the level is controlled when it exceeds the Threshold point you set. The range is 1.1 to 20.0, plus an additional *LIMITER* setting.

The numerical values are dB values representing the amount of level increase at the input that will result in a 1dB increase at the output of that channel. So for example, selecting a value of 6.0 will mean that for every 6dB increase at the input, the output will rise by approximately 1dB.

LIMITER is a very hard compression setting. It prevents the channel output from increasing by more than 1dB no matter how much the level rises at its input.

There are two things we are trying to achieve when we add compression or limit the signal. Firstly we want to protect the speakers (and to a lesser degree the power amps) from exceeding their capabilities. They will sound better (less distortion) and live longer.

The second thing is that we want to be able to free ourselves from having to constantly tweak the volume level.

What our processor allows us to do is set our preferred upper level it's like having your own DJ poised with her hand over the volume control, ready to turn it down when the music gets uncomfortably loud. And because we have this to automatically control things for us at the top end, we can raise the overall volume level, which increases the level of the softer musical passages.

If you would like more information on Dynamic Gain Control and compressor/limiting, including set-up advice, please visit our website support forum where you will find a technical paper available for download.

6. Working with Presets

At the lower edge of the PC Editor window is a series of commands for recalling and storing PRESETS.

To load a PRESET:

Click on *RECALL* and then on one of the numbered red (FACTORY) or green (USER) PRESET buttons. The selected PRESET will be loaded and its name displayed in the text box.

To save a PRESET:

Click on *STORE* and then on one of the grey or green buttons (USER PRESETS). The grey color means it is an empty PRESET. The green color means there is already a set-up stored at that position (which will be overwritten if you proceed). In the window that appears, type a new PRESET NAME, then press *OK*. The new set-up is now saved as a PRESET, with its name displayed in the text box. But you still need to save to a file, as follows:

Save All Settings:

You must now save your MAXIDRIVE3.4 PC settings (which may include several different PRESET set-ups) as a **Maxi Editor File** (*.mxe) on your computer. Go To *FILE*, and then *SAVE AS*. A window will open for you to select a destination folder for the file. You can keep the default filename or type one of your own.

When you have done this, take the MAXIDRIVE3.4 PC offline (click on the icon) and then online again. This will force the PC Editor to do a network scan. Press *OK* and the full system settings, including your latest PRESET, will now be downloaded and stored in the unit's internal memory.

Remember that every time you download from your PC to the MAXIDRIVE3.4 PC, the USER PRESETS in the internal memory are replaced.

7. CONNECTIONS

The following diagrams show the schemes of the recommended cables and some connection examples referred to various system configurations.

Inputs A & B, RS485 IN

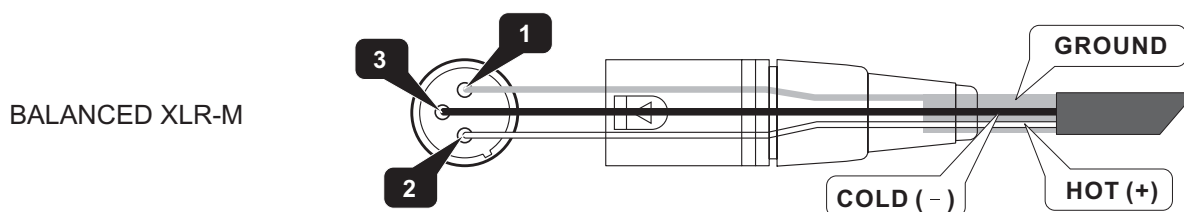

Inputs A & B

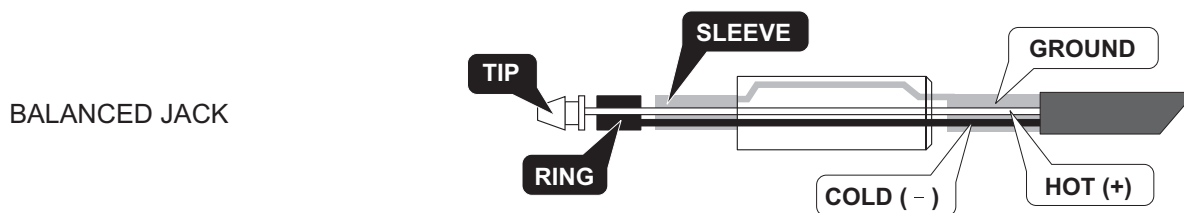

8.2 Organization

The following examples will help you well use and connect the unit.

a. A13 B24 S56 2-WAY STEREO + 2 MONO AUX [2X2W+2MAX]

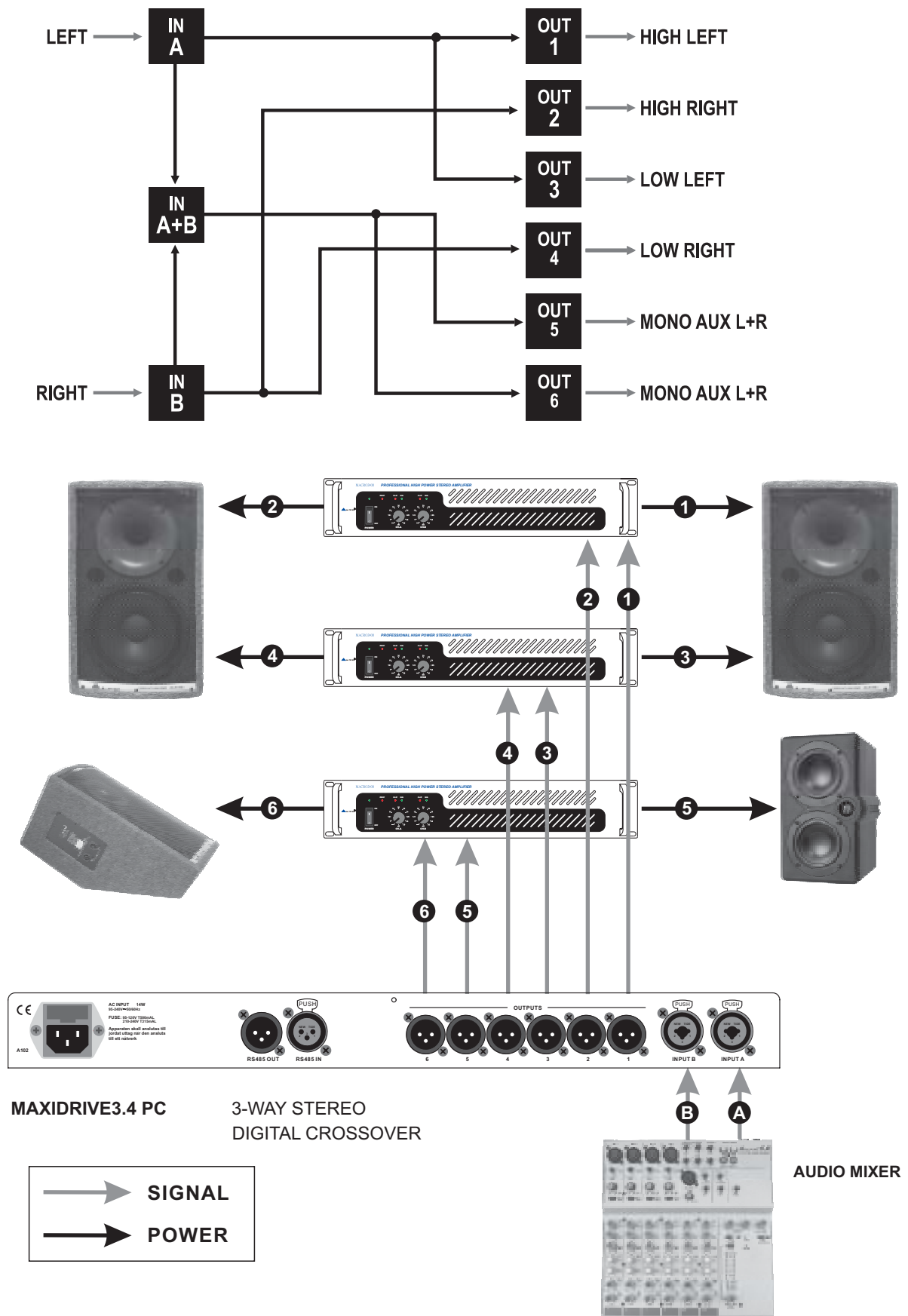

b. A135 B246 3-WAY STEREO [2X2W]

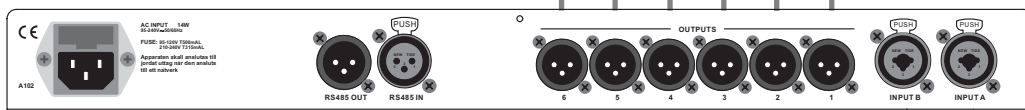
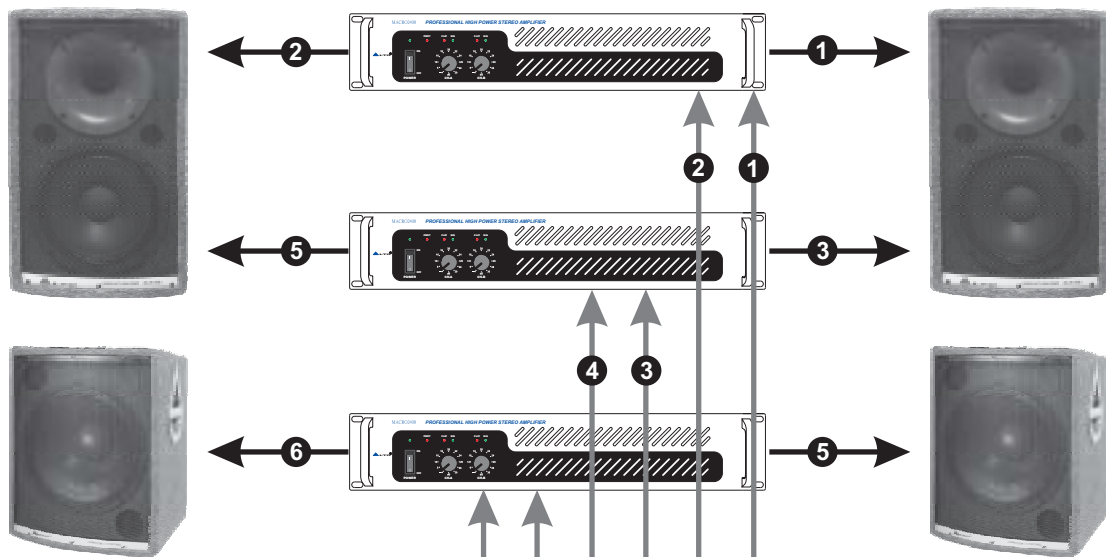
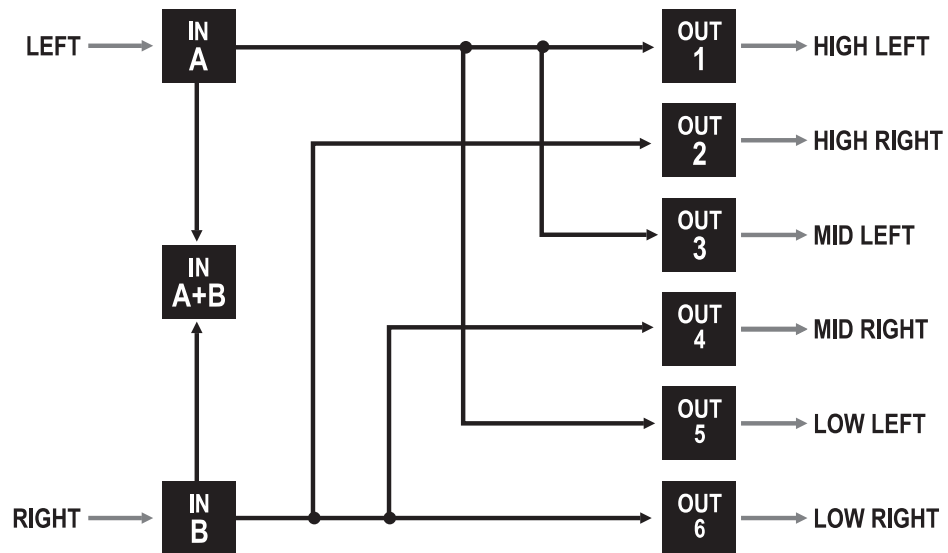

MAXIDRIVE3.4 PC

3-WAY STEREO
DIGITAL CROSSOVER

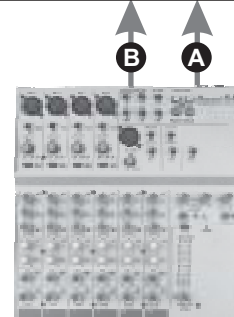

AUDIO MIXER

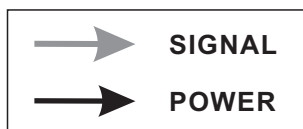

c. A13 B24 S56 3-WAY STEREO with MONO SUB+MONO AUX [2X3W+MSB+MAX]

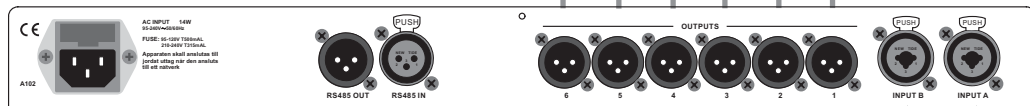
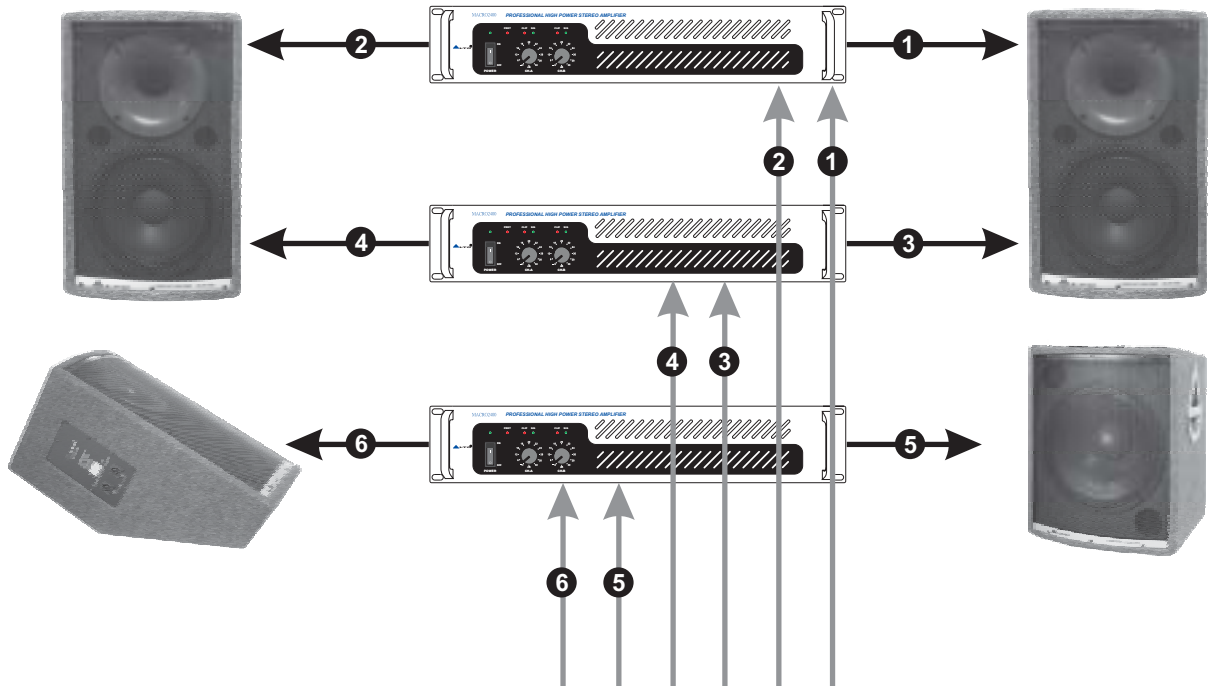
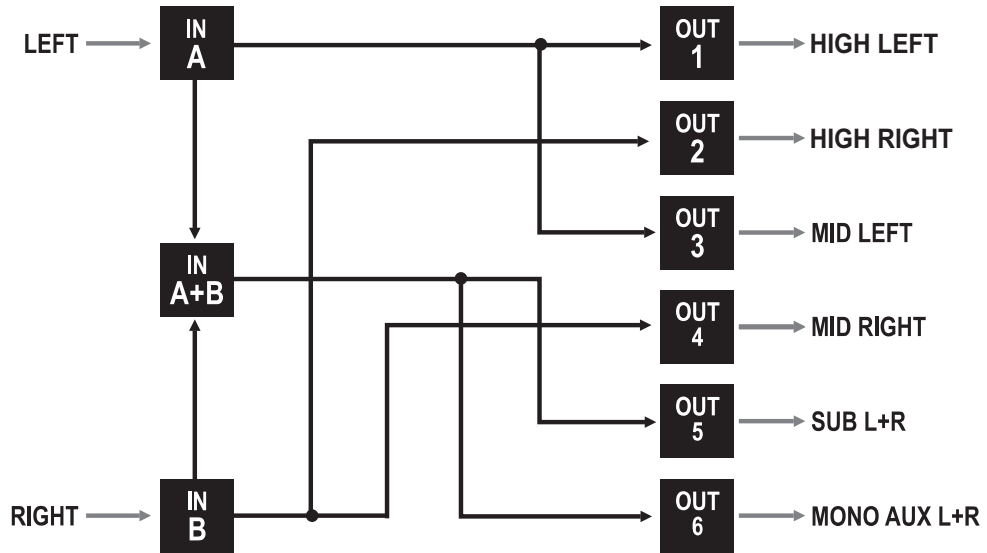

MAXDRIVE3.4 PC

3-WAY STEREO
DIGITAL CROSSOVER

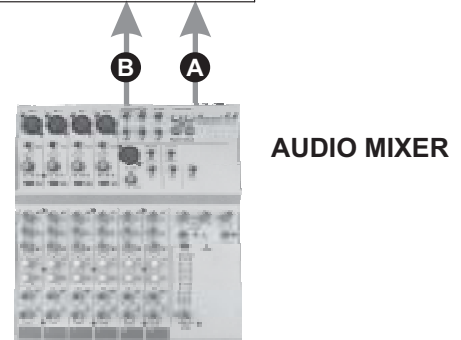
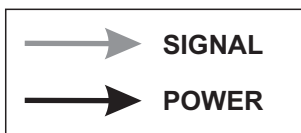

d. A1324 S56 4-WAY4 MONO + 2 MONO AUX [4W+2MAX]

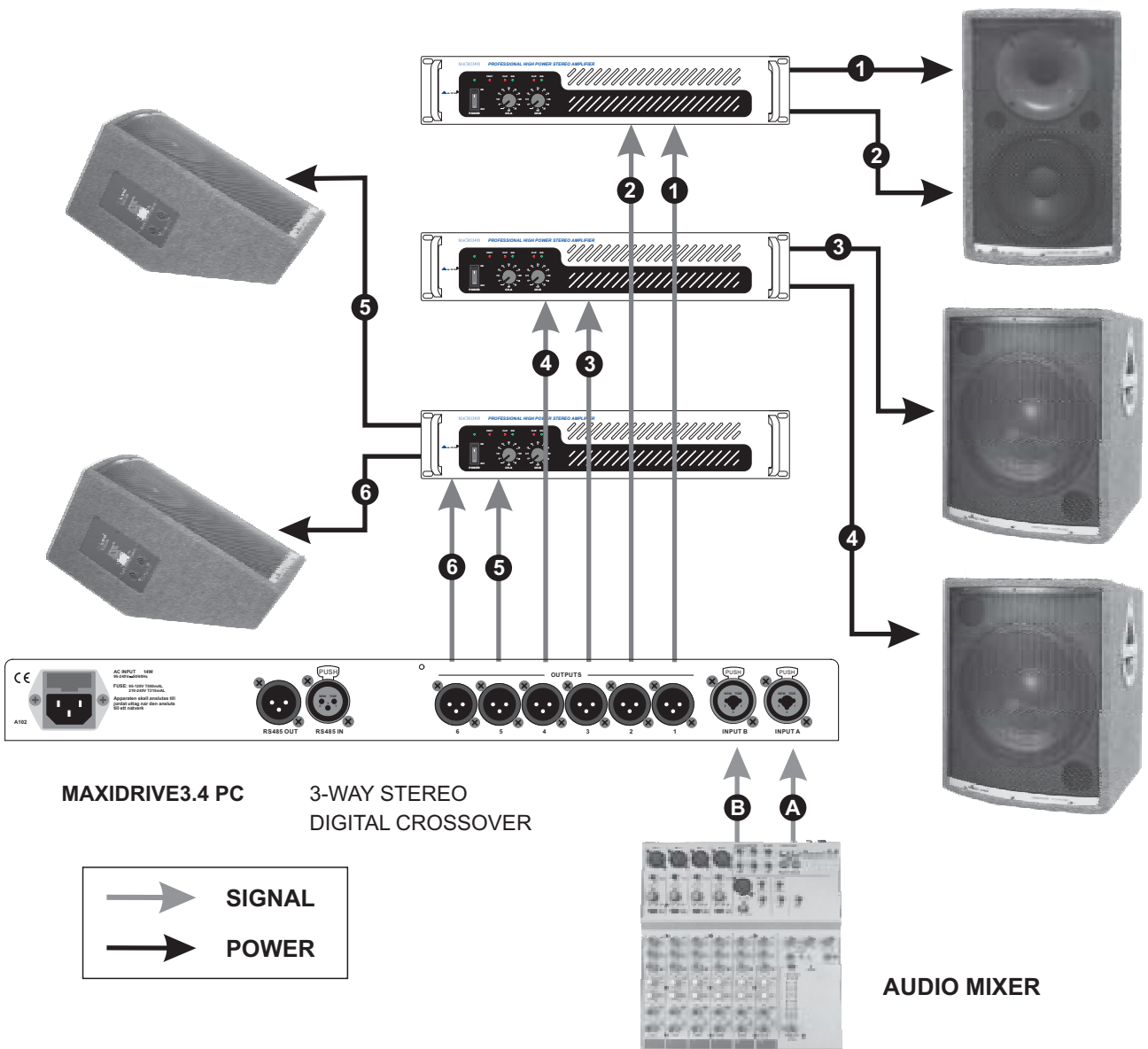
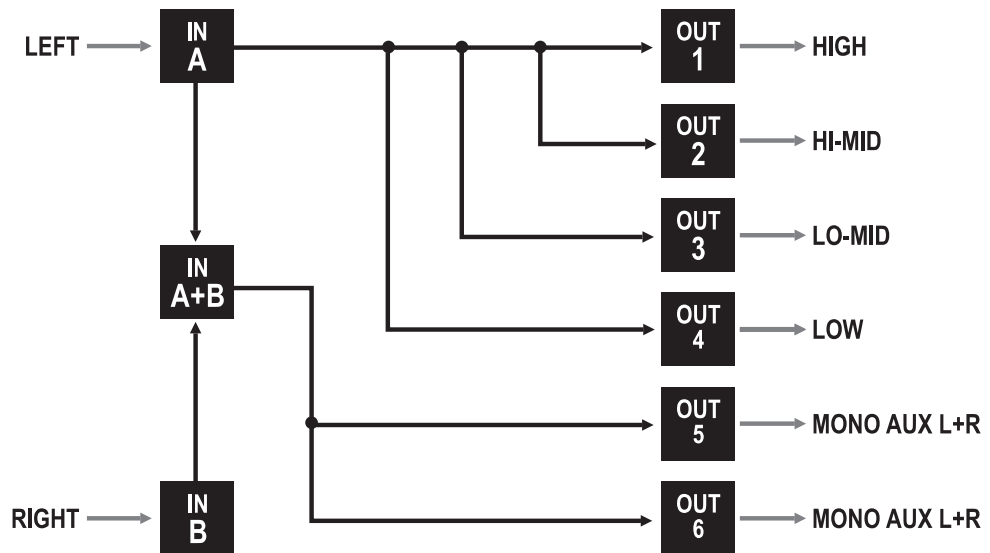

e. Communications: PC & one or more MAXIDRIVE3.4 PC connection

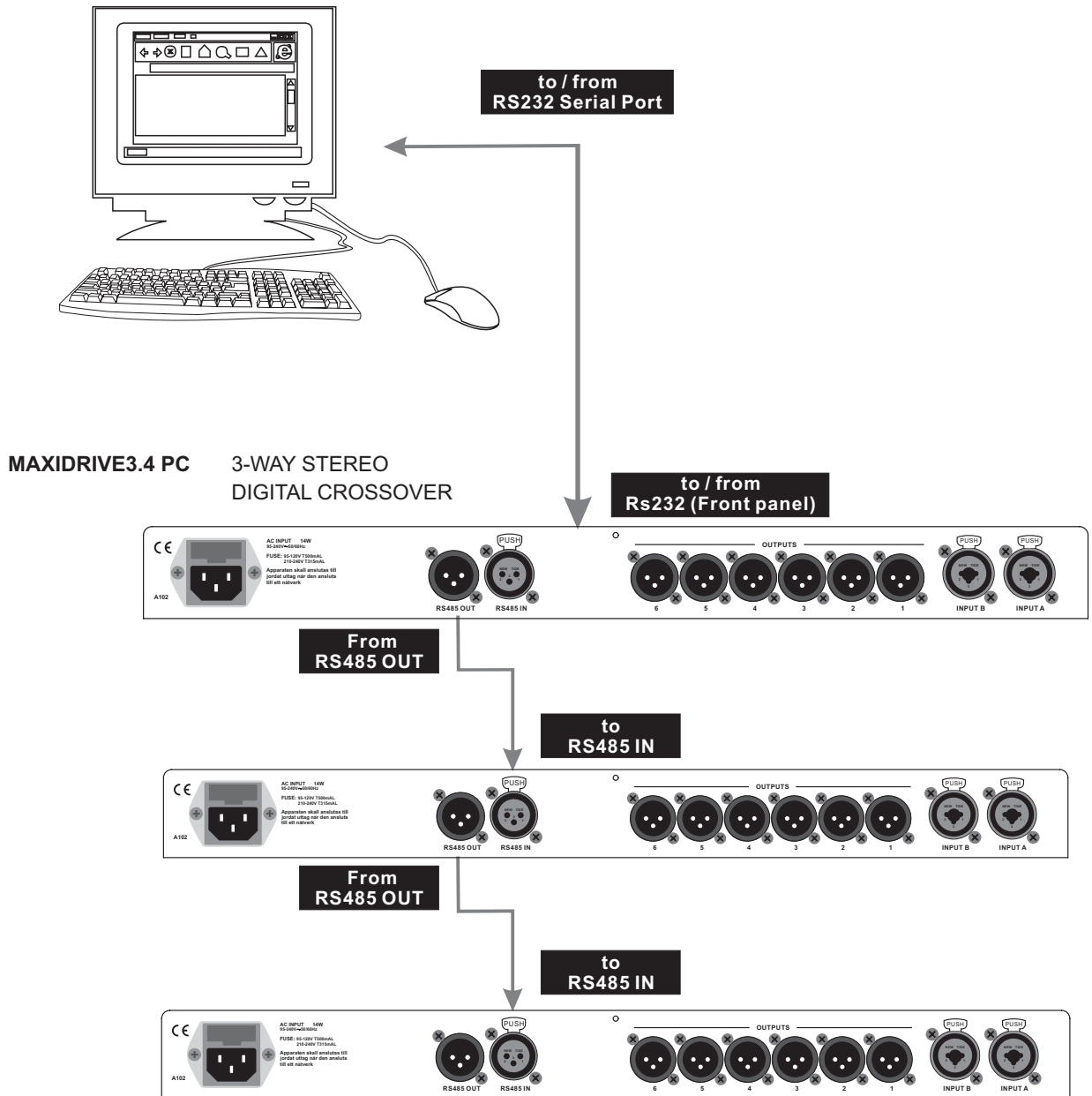

9. TECHNICAL SPECIFICATIONS

INPUT section		
	Connectors	2 x COMBO
	Nominal input sensitivity	0 dB (0.775 V)
	Input Impedance	30kOhm, electronically balanced
	Maximum Input Level	+20dBu
	Input Gain	-30 / +6 dB variable in 0.5 dB steps
Output Section		
	Connectors	6 x XLR-M
	Output Impedance	600 Ohms, electronically balanced
	Nominal Output Level	0 dBu
	Maximum Output Level	+20 dBu
	Output Gain	-30 / +6 dB variable in 0.5 dB steps
DSP Section		
	A/D converters	20 bit
	D/A converters	20 bit
	Internal dynamics	40 bit
	Sampling frequency	48 kHz
Features		
	Configuration	2-WAY STEREO, 3-WAY STEREO, 2,3,4,5,6-WAY MONO
	Crossover Filters Type	Bessel, Butter worth or Linkwitz- Riley
	Crossover Filters Slope	6, 12, 18, 24, or 48dB per octave
	Delay Step	21 microseconds minimum
	Max Delay time	2621 ms (inputs), 291 ms (outputs)
	EQ filters	Up to 40 maximum (depending on the crossover slope)
	EQ Type	Peak, 6dB Lo-Shelf, 12dB Lo-Shelf, 6dB Hi-Shelf, 12dB Lo-Shelf, Notch
	EQ Gain	+15dB, variable in 0.5dB steps
	EQ Bandwidth	0.05 to 3.00 octaves, variable in 0.05 steps
	EQ freq	15.6 Hz to 16 kHz
	Dynamics	Digital limiter on all the output
	Memories	FACTORY PRESETS are 10 + 64 USER PRESETS
	Communications	9-pin RS232, XLR-F RS485 IN, XLR-M RS485 OUT
General Performance		
	Frequency Response	20Hz - 20kHz, 0.25dB
	Dynamic range	>117dB 20Hz to 20kHz
	Channel Separation	>100dB 20Hz to 20kHz
	Distortion (THD)	0.05%, 20Hz to 20kHz
General		
	Dimensions	483x44x300 mm
	Weight	4.0 Kg
	Power supply	see label on the unit

10. WARRANTY

1. WARRANTY REGISTRATION CARD

To obtain Warranty Service, the buyer should first fill out and return the enclosed Warranty Registration Card within 10 days of the Purchase Date.

All the information presented in this Warranty Registration Card gives the manufacturer a better understanding of the sales status, so as to purport a more effective and efficient after-sales warranty service.

Please fill out all the information carefully and genuinely, miswriting or absence of this card will void your warranty service.

2. RETURN NOTICE

2.1 In case of return for any warranty service, please make sure that the product is well packed in its original shipping carton, and it can protect your unit from any other extra damage.

2.2 Please provide a copy of your sales receipt or other proof of purchase with the returned machine, and give detail information about your return address and contact telephone number.

2.3 A brief description of the defect will be appreciated.

2.4 Please prepay all the costs involved in the return shipping, handling and insurance.

3. TERMS AND CONDITIONS

3.1 ▲LTO warrants that this product will be free from any defects in materials and/or workmanship for a period of 1 year from the purchase date if you have completed the Warranty Registration Card in time.

3.2 The warranty service is only available to the original consumer, who purchased this product directly from the retail dealer, and it can not be transferred.

3.3 During the warranty service, ▲LTO may repair or replace this product at its own option at no charge to you for parts or for labor in accordance with the right side of this limited warranty.

3.4 This warranty does not apply to the damages to this product that occurred as the following conditions:

- Instead of operating in accordance with the user's manual thoroughly, any abuse or misuse of this product.
- Normal tear and wear.
- The product has been altered or modified in any way.
- Damage which may have been caused either directly or indirectly by another product / force / etc.
- Abnormal service or repairing by anyone other than the qualified personnel or technician.

And in such cases, all the expenses will be charged to the buyer.

3.5 In no event shall ▲LTO be liable for any incidental or consequential damages. Some states do not allow the exclusion or limitation of incidental or consequential damages, so the above exclusion or limitation may not apply to you.

3.6 This warranty gives you the specific rights, and these rights are compatible with the state laws, you may also have other statutory rights that may vary from state to state.

SEIKAKU TECHNICAL GROUP LIMITED
No. 1, Lane 17, Sec. 2, Han Shi West Road, Taichung 40151, Taiwan
<http://www.altoproaudio.com> Tel: 886-4-22313737
email: alto@altoproaudio.com Fax: 886-4-22346757

All rights reserved to ALTO. All features and content might be changed without prior notice. Any photocopy, translation, or reproduction of part of this manual without written permission is forbidden. Copyright © 2005 SEIKAKU GROUP