

Quick Start Guide CobraLink

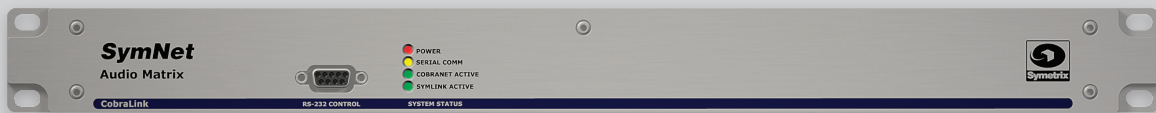

Quick Start Guide CobraLink

To download the latest version of SymNet Designer, the Windows application that controls all SymNet hardware go to: www.symnetradio.com

Before You Begin

What Ships in the Box

- ✓ A CobraLink hardware device.
- ✓ SymNet Designer CD-ROM (Windows)
- ✓ A SymLink patch cable.
- ✓ A ferrite clamp
- ✓ One PS-4 switching power supply which provides 6 volts DC @ 3.3 amperes. NOTE: The PS-4 will accept a 100-240V AC input. A power cable for domestic use is supplied for the PS-4. Export customers should supply the appropriate substitute cable for their locale.
- ✓ This Quick Start Guide.

What You Need to Provide

- ✓ A Windows PC with 300MHz or higher Pentium and:
 - WIN 98SE or WIN 2000.
 - 10-15MB free storage space.
 - 1024x768 graphics capability
 - 16 bit or higher colors
 - CD ROM drive or Internet connection
 - 64MB RAM (WIN 98SE), 128MB RAM (WIN 2000).
- ✓ An available serial port capable of operating at 57.6 or 115.2 kilobaud.
- ✓ A cable to connect the RS-232 serial port of your PC to SymNet's front panel RS-232 input. The SymNet RS-232 input is a female DB-9 connector.
- ✓ Shielded CAT-5 cables as necessary

Getting Help

SymNet Designer, the Windows application that controls all SymNet hardware, includes a help module which acts as a complete user's guide for both hardware and software.

If you have questions beyond the scope of the help module, contact our Customer Support Group in the following ways:

Tel (425) 778-7728
8:00 am to 4:30 pm
Monday through Friday,
Pacific Time
Web support.symnetradio.com

This device complies with part 15 of the FCC Rules. Operation is subject to the following two conditions: (1) This device may not cause harmful interference, and (2) this device must accept any interference received, including interference that may cause undesired operation.

This Class A Digital apparatus meets all requirements of the Canadian Interference-Causing Equipment Regulations
Cet appareil numérique de la classe A respecte toutes les Exigences du Règlement sur le matériel brouilleur du Canada.

Important Safety Instructions.

1. Read these instructions.
2. Keep these instructions.
3. Heed all warnings.
4. Follow all instructions.
5. Do not use this apparatus near water. Do not place liquids or objects filled with water on top of it, or where it may be exposed to dripping, splashing or steam.
6. Clean only with dry cloth.
7. Do not block any ventilation openings. Install only in accordance with the manufacturer's instructions.
8. Do not install near any heat sources such as radiators, heat registers, stoves, or other apparatus (including amplifiers) that produce heat.
9. This apparatus shall be connected to a mains socket outlet with a protective earthing connection. Do not defeat the safety purpose of the polarized or grounding-type plug. A polarized plug has two blades with one wider than the other. A grounding type plug has two blades and a third grounding prong. The wide blade or the third prong are provided for your safety. If the provided plug does not fit into your outlet, consult an electrician for replacement of the obsolete outlet.
10. Protect the power cord from being walked on or pinched particularly at plugs, convenience receptacles, and the point where they exit from the apparatus.
11. Only use attachments/accessories specified by the manufacturer.
12. Use only with the cart, stand, tripod, bracket, or table specified by the manufacturer, or sold with the apparatus. When a cart is used, use caution when moving the cart/apparatus combination to avoid injury from tip-over.
13. Unplug this apparatus during lightning storms or when unused for long periods of time.
14. Refer all servicing to qualified service personnel. Servicing is required when the apparatus has been damaged in any way, such as power-supply cord or plug cord is damaged, liquid has

been spilled or objects have fallen into the apparatus, the apparatus has been exposed to rain or moisture, does not operate normally, or has been dropped.

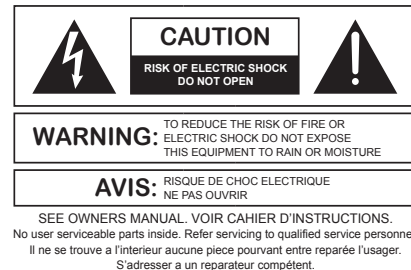

The lightning flash with arrowhead symbol within an equilateral triangle is intended to alert the user of the presence of uninsulated "dangerous voltage" within the product's enclosure that may be of sufficient magnitude to constitute a risk of electric shock to persons. The exclamation point within an equilateral triangle is intended to alert the user of the presence of important operating and maintenance (servicing) instructions in the literature accompanying the product (i.e. this User's Guide).

CAUTION To prevent electric shock, do not use the polarized plug supplied with the unit with any extension cord, receptacle, or other outlet unless the prongs can be fully inserted.

Power Source. SymNet CobraLink hardware uses a switching power supply that automatically adjusts to the applied voltage. Ensure that your AC mains voltage is somewhere between 100-240 VAC, 50-60 Hz. Use only the power cord and connector specified for the product and your operating locale. A protective ground connection, by way of the grounding conductor in the power cord, is essential for safe operation. The appliance inlet and coupler shall remain readily operable once the apparatus has been installed.

User Serviceable Parts. There are no user serviceable parts inside the SymNet CobraLink. In case of failure, customers inside the U.S. should refer all servicing to the Symetrix factory. Customers outside the U.S. should refer all servicing to an authorized Symetrix distributor. Distributor contact information is available online at: www.symnetradio.com.



WARNING!

NEVER connect the RJ-45 connector (CAT-5) on an ARC, ARC-PS or Control I/O to any SymNet audio device's SymLink connector (also an RJ-45 connector). The RJ-45 connectors on SymNet products labeled as "SymLink" (Transmit or Receive) should only be connected to other RJ-45 connectors labeled as "SymLink" (Transmit or Receive). The RJ-45 connectors on the ARC, ARC-PS and Control I/O can carry anywhere from 6 to 15 VDC which can damage SymLink circuitry.

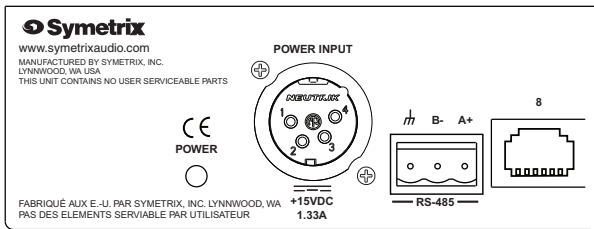
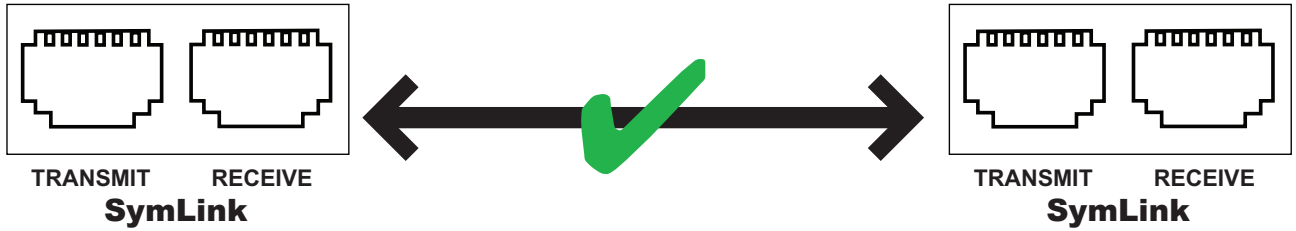

ARC-PS or Control I/O

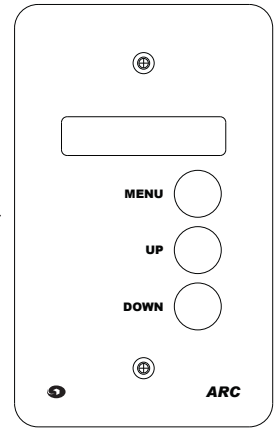

ARC

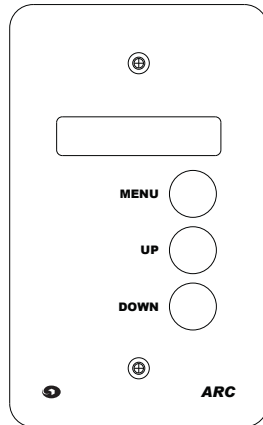

ARC

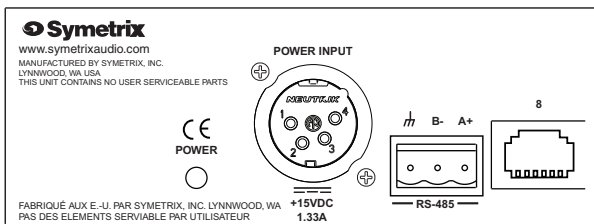
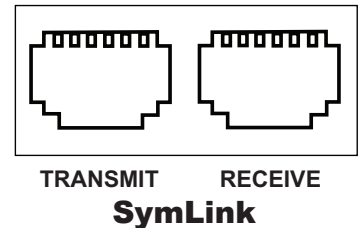

ARC-PS or Control I/O

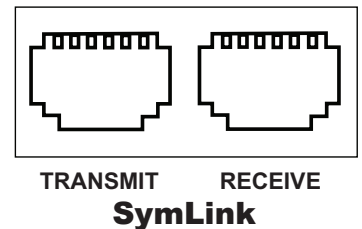

To download the latest version of SymNet Designer, the Windows application that controls all SymNet hardware go to: www.symetrixaudio.com

Hardware Connections And Switch Settings

1/4

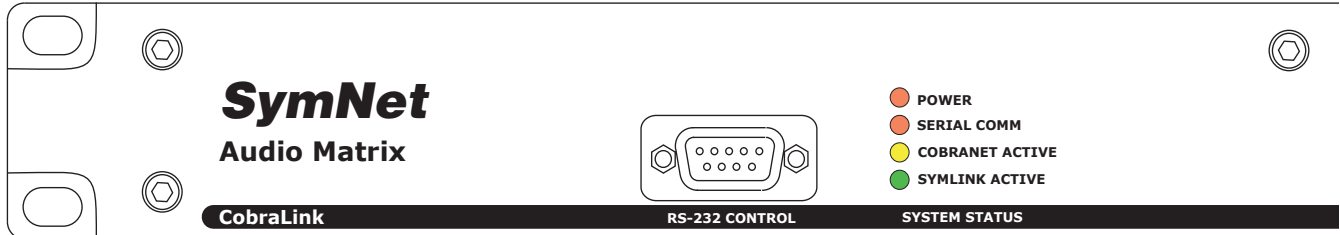

Connection	Description	What It Does
RS-232 Control	DB-9 (d-sub) Female	Default serial communications interface for SymNet Designer on the host PC. Wired straight-through, only pins 2, 3 and 5 are required. <u>Port Settings:</u> 115 or 57.6 kbaud, 8 data bits, 1 stop bit, no parity, no flow control. Baud rate determined by DIP switch #1 which must match SymNet Designer's communications preferences.

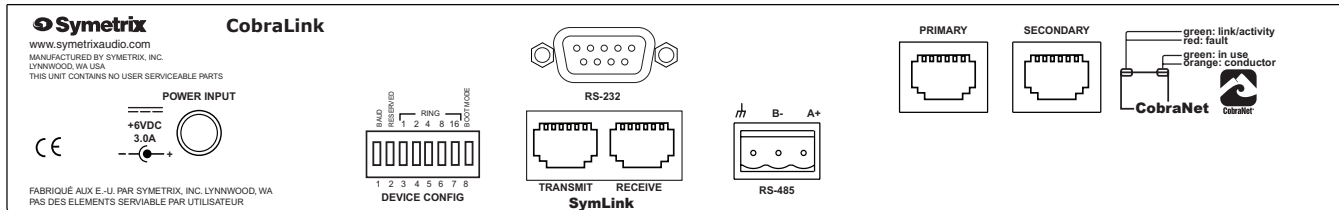

Connection	Description	What It Does
POWER INPUT	2.0 mm Jack	Accepts power from Symetrix PS-4 (or equivalent) power supply only.
Device config	8 position DIP switch	1 (BAUD) - Sets front panel RS-232 baud rate. Default = UP = 115,200, DOWN = 57,600. 2 (not used) 3-7 (RING) - Sets ring number of the SymNet ring. In a system with more than one CobraLink unit, each unit must be given a unique ring number. Exactly one unit must be assigned to ring number 1, that is switch 3=DOWN, switches 4-7= UP. 8 (BOOT MODE) - Default = UP. Set to DOWN only if instructed to do so by a Symetrix Customer Support.
SymLink	RJ-45	Low-latency 64-channel audio and data bus. TRANSMIT connects to the next downstream SymLink device's receive port. RECEIVE connects to the previous SymLink device's transmit port. This forms the "SymLink Ring". Use shielded CAT-5 cables less than 10 meters in length, standard straight-through wiring.
RS-232	DB-9 (d-sub) Female	Default serial communications interface for a 3rd party accessory controller. Wired straight-through, only pins 2, 3 and 5 are required. <u>Port Settings:</u> 38.4 kbaud (default), 8 data bits, 1 stop bit, no parity, no flow control.
RS-485	Detachable Euroblock	Connects to a Control I/O, ARC-PS, ARC or other Symetrix SymNet family RS-485 controller, wired in parallel (A to A, B to B and GND to GND) using shielded twisted pair. <u>Port Settings:</u> 38.4 kbaud (default), 8 data bits, 1 stop bit, no parity, no flow control.
CobraNet	RJ-45	Connects the SymNet ring to a CobraNet network. Use the connector labelled PRIMARY The connector labelled SECONDARY is redundant and can be used if the CobraNet device you are connecting to has a SECONDARY port.

NOTE Included in the CobraLink packaging is a ferrite clamp. In order to maintain CE compliance, this clamp should be installed on the TRANSMIT side of each SymLink cable.

To download the latest version of SymNet Designer, the Windows application that controls all SymNet hardware go to: www.symetrixaudio.com

Common Problems and Solutions

2/4

Dancing Lights. If any of your SymNet units power on and seem to suffer from Dancing Lights Syndrome, never fear. This simply means that there is no active configuration loaded. When designing your site, it is necessary to designate a particular configuration to be loaded at power on. This is done by opening your Site File in SymNet Designer and choosing “Triggers and Power On Default...” from the “Hardware” menu. In the dialog box that opens, click the “Change Power On Default...” button. Now choose which configuration (1 through 8 or None) you would like to be the power on default and click “OK”. You must now download your Site File to the hardware (F4) in order for the settings to be stored.

Serial Communications. Be sure that you use a *straight-through* RS-232 cable connected to the *front* DB-9 port labeled RS-232 CONTROL. You must connect to whichever unit is master for a given ring. It is permissible to connect to any ring provided that you connect to the master unit (the unit with an Address of 1). By default, SymNet Designer communicates with the hardware units at a baud rate of 115,200 bps. This is how the baud DIP switch (number 1) is configured in the examples on page 2. However, if you have a PC that is incapable of operating at this speed, a setting of 57,600 bps is available. DIP switch 1 will be opposite of the examples on page 2 and the speed of 57,600 bps must be selected in SymNet Designer’s Preferences dialog accessible from the File menu.

SymLink Communications. The SymLink bus uses industry standard CAT-5 shielded Ethernet cable. The SymNet units are interconnected in a Token Ring network fashion. The transmit of the first unit is connected to the receive of the second unit and so on. The last unit in the chain should then have its transmit connected to the first units receive to complete the ring. All SYMLINK ACTIVE green LEDs should be lit on the front of each SymNet device.

Example:

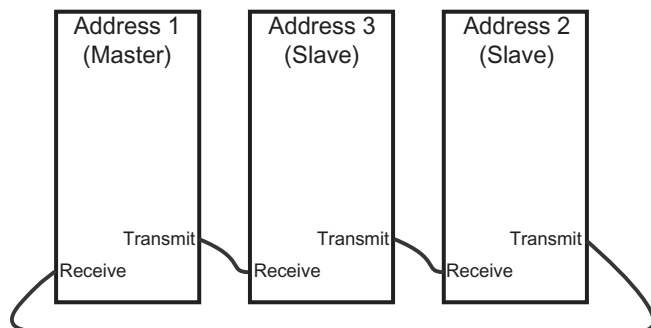

Firmware. IMPORTANT: Your hardware devices must be running the firmware that complements the version of SymNet Designer in use. If you are receiving this software with a new SymNet device from the factory, then the firmware versions should already be correct. However, if you are using it with an existing SymNet device, then the firmware must be upgraded. It is always wise to double check the versions on all units as a first step to troubleshooting communications errors.

SymNet Designer 1.2 and later features a “Verify” button in the Upgrade Firmware dialog. This makes it easier to verify that you have the correct Microprocessor firmware file for the currently running version of SymNet Designer. However, it does not check for the correct version of the FPGA firmware file. This must still be done manually.

Upgrading Firmware:

1. Install the latest version of SymNet Designer. The latest version is always available at www.symetrixaudio.com. The correct firmware version is included and installed with the SymNet Designer software.
2. Launch SymNet Designer.
3. Connect your hardware devices as they would be for normal operation. It is recommended you disconnect or power down all audio sources connected to SymNet during the upgrade.
4. In SymNet Designer, choose Hardware -> Upgrade Firmware. The dialog that appears will tell you the current version of the firmware in your hardware devices.
5. Click the Upgrade button under SymNet Microprocessor file. An open file dialog will appear allowing you to navigate for firmware files. By default it should take you into the C:\Program Files\Symetrix\SymNet Designer X.X\Upgrade folder. Select the most recent SNMvXXXX.bin file and click Open.
6. After this finishes, click the Upgrade button under SymNet FPGA file. Select the SDFvXXXX.bit file and click Open. (If you are upgrading a CobraLink device, select the CLFvXXXX.bit file instead.)
7. If you have more than one SymNet device, select each device using the address drop down at the top of the dialog box and repeat steps 5-6.
8. If you are using CobraLink and have more than one ring, also repeat for all devices on all rings using the Ring drop down at the top of the dialog box.
9. When finished, click Close.

To download the latest version of SymNet Designer, the Windows application that controls all SymNet hardware go to: www.symetrixaudio.com

DIP Switch Reference

SymNet Family DIP Switch Settings

NOTE: As of SymNet Designer software version 2.0, a maximum of 32 Rings, each having 16 Addresses, are possible. For the sake of space, only switch settings for the first 8 Rings or Addresses are pictured.

SymNet DSP (8x8, 8in and 8out)

NOTE: Only one Master is allowed on the Ring and it should be Address 1.

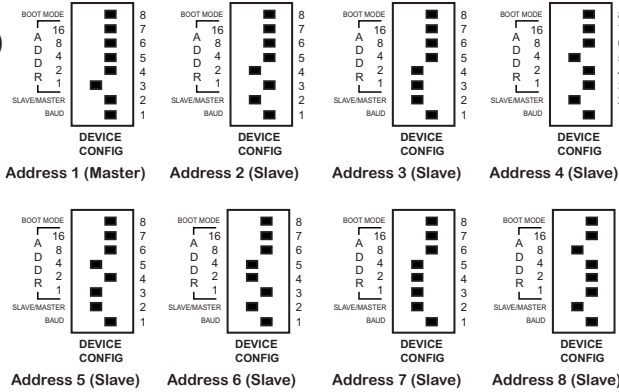

SymNet CobraLink

NOTE: The DIP switches on a CobraLink device configure its Ring number. A CobraLink device is always at Address 1 and is the Master of its ring.

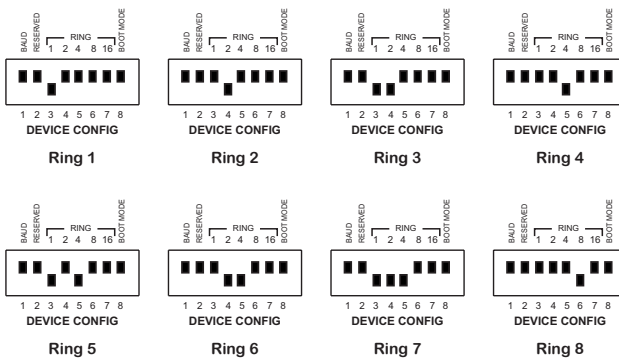

SymNet BreakIn12 & BreakOut12

NOTE: An Address of 1 is not valid on the BreakIn12 or BreakOut12 since these devices can not be the Master on a Ring.

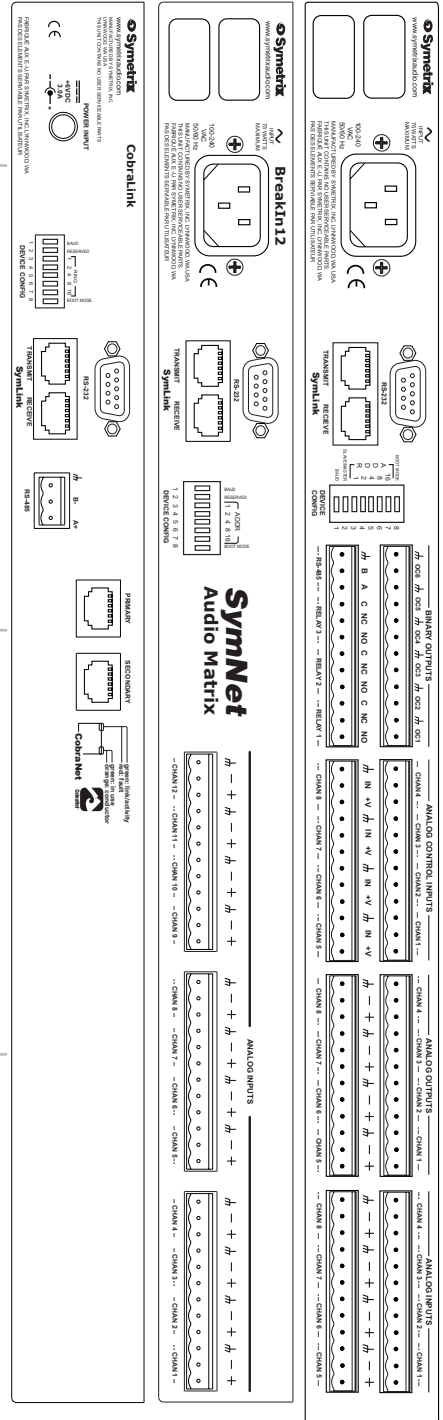
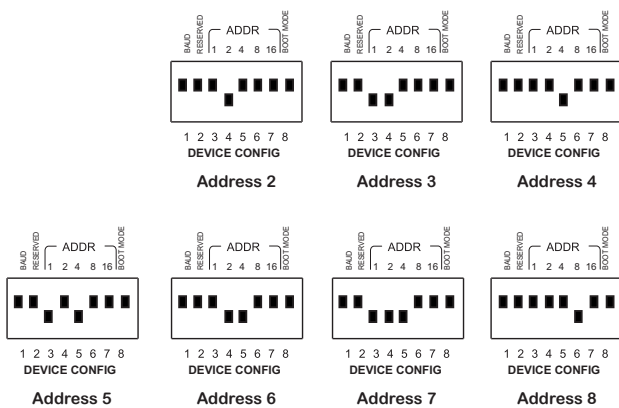

The Symetrix Limited Warranty

Symetrix, Inc. expressly warrants that the product will be free from defects in material and workmanship for eighteen (18) months from the date the product is shipped from the factory. Symetrix's obligations under this warranty will be limited to repairing or replacing, at Symetrix's option, the part or parts of the product which prove defective in material or workmanship within eighteen (18) months from the date the product is shipped from the factory, provided that the Buyer gives Symetrix prompt notice of any defect or failure and satisfactory proof thereof. Products may be returned by Buyer only after a Return Authorization number (RA) has been obtained from Symetrix. Buyer will prepay all freight charges to return the product to the Symetrix factory. Symetrix reserves the right to inspect any products which may be the subject of any warranty claim before repair or replacement is carried out. Symetrix may, at its option, require proof of the original date of purchase (dated copy of original retail dealer's invoice). Final determination of warranty coverage lies solely with Symetrix. Products repaired under warranty will be returned freight prepaid via United Parcel Service by Symetrix, to any location within the Continental United States. Outside the Continental United States, products will be returned freight collect.

The foregoing warranties are in lieu of all other warranties, whether oral, written, express, implied or statutory. Symetrix, Inc. expressly disclaims any IMPLIED warranties, including fitness for a particular purpose or merchantability. Symetrix's warranty obligation and buyer's remedies hereunder are SOLELY and exclusively as stated herein.

This Symetrix Lucid product is designed and manufactured for use in professional and studio audio systems and is not intended for other usage. With respect to products purchased by consumers for personal, family, or household use, **Symetrix expressly disclaims all implied warranties, including but not limited to warranties of merchantability and fitness for a particular purpose.**

This limited warranty, with all terms, conditions and disclaimers set forth herein, shall extend to the original purchaser and anyone who purchases the product within the specified warranty period.

Symetrix does not authorize any third party, including any dealer or sales representative, to assume any liability or make any additional warranties or representation regarding this product information on behalf of Symetrix.

This limited warranty gives the buyer certain rights. You may have additional rights provided by applicable law.

Note: Some Symetrix Lucid products contain embedded software and may also be accompanied by control software intended to be run on a personal computer. Said software is specifically excluded from this warranty.

Limitation of Liability

The total liability of Symetrix on any claim, whether in contract, tort (including negligence) or otherwise arising out of, connected with, or resulting from the manufacture, sale, delivery, resale, repair, replacement or use of any product will not

exceed the price allocatable to the product or any part thereof which gives rise to the claim. In no event will Symetrix be liable for any incidental or consequential damages including but not limited to damage for loss of revenue, cost of capital, claims of customers for service interruptions or failure to supply, and costs and expenses incurred in connection with labor, overhead, transportation, installation or removal of products, substitute facilities or supply houses.

Servicing the CobraLink

If you have determined that your CobraLink requires repair services and you live outside of the United States please contact your local SymNet dealer or distributor for instructions on how to obtain service. If you reside in the U.S. then proceed as follows.

Return authorization

At the Symetrix factory, Symetrix will perform in-warranty or out-of-warranty service on any product it has manufactured for a period of three (3) years from date of discontinued manufacture.

Before sending anything to Symetrix, please contact our Customer Service Department for a return authorization (RA) number. The telephone number is (425) 778-7728. Additionally support is available via the web site: support.symetrixaudio.com.

In-warranty repairs

To get your CobraLink repaired under the terms of the warranty:

1. Call us for an RA number (have the serial number, shipping and contact information and description of the problem ready).
2. Pack the unit in its original packaging materials.
3. Include your name, address, daytime telephone number, and a brief statement of the problem.
4. Write the RA number on the **outside** of the box.
5. Ship the unit to Symetrix, freight prepaid. We do not accept freight collect shipments.

Just do these five things, and repairs made in-warranty will cost you only one way freight charges. We'll pay the return freight.

If you don't have the factory packaging materials, we recommend using an oversize box. Wrap the unit in a plastic bag, surround it with bubble-wrap, and place it in the box surrounded by Styrofoam peanuts. Be sure there is enough clearance in the box to protect the rack ears. We won't return the unit in anything but Symetrix packaging for which we will have to charge you. If the problem is due to operator misuse or error, you will have to pay for both parts and labor. In any event, if there are charges for the repair, you will pay for the return freight. All charges will be COD unless you have made other arrangements (prepaid, Visa or Mastercard).

Out-of-warranty repairs

If the warranty period has passed, you'll be billed for all necessary parts, labor, packaging materials, and freight charges. Please remember, you must call for an RA number before sending the unit to Symetrix.

 **SymNet** | Network Audio Solutions
Engineered by Symetrix

6408 216th St. SW, Mountlake Terrace, WA, USA • Tel +1 (425) 778-7728 • Fax +1 (425) 778-7727 • Web www.symnetaudio.com

© 2006, Symetrix, Inc. All rights reserved. Printed in the United States of America. Symetrix Part Number 53COBR1A03. The information in this Quick Start Guide is subject to change without notice. Symetrix, Inc. shall not be liable for technical or editorial errors or omissions contained herein; nor is it liable for incidental or consequential damages resulting from the furnishing, performance, or use of this material. Mention of third-party products is for informational purposes only and constitutes neither an endorsement nor a recommendation. Symetrix assumes no responsibility with regard to the performance or use of these products. Under copyright laws, no part of this Quick Start Guide may be reproduced or transmitted in any form or by any means, electronic or mechanical, without permission in writing from Symetrix, Inc. If, however, your only means of access is electronic, permission to print one copy is hereby granted. Product names mentioned herein may be trademarks and/or registered trademarks of their respective owners.