

Description

The TTM 54i Performance Mixer is a precision instrument designed for the most demanding DJ. This ain't no toy! The Rane TTM 54i offers more features, higher performance and better reliability than any Performance Mixer, from any manufacturer, at any price. This Mixer moves the art form to a new level.

New "i" Features

- *Lexan® face plate insures sharp appearance for years to come*
- *Improved Transform (Phono/Line) switches*

Unique Features

- A precision *Active Crossfader™* with continuously adjustable Contour and "Hamster" reversal controls, provides the lowest feed-through, lowest noise, and most responsive control in the industry, all with unprecedented reliability (see Fig. 1).
- Front panel "Hamster" reversal and switchable Contour controls give *Active Program Faders* ultimate flexibility (see Fig. 2).
- High performance *Accelerated-Slope™*, band-split 24 dB per octave tone controls provide more than 40 dB of Bass and Treble cut without affecting the vocal midrange (see Fig. 4).
- A proprietary, assignable Effects Loop allows a stereo effect to be inserted in Pre-Fader Program 1, Pre-Fader Program 2, or Master at the press of a switch.
- Independent 18 dB per octave Rumble filters for *each* phono input.

Other Features

- Two Phono and two Line inputs with high quality, long-life *clickless* transform selector switches.
- Balanced Mic input with Bass and Treble tone controls and independent Effects Loop.
- Balanced 1/4" TRS and Unbalanced RCA Master outputs.
- Dual mono 10-segment level meters with peak hold, indicate level for Programs 1 and 2.
- Headphone monitor for Master program allows performance rehearsal with Master level turned down.
- Stereo Headphone Cue pans between Program 1 and Program 2.

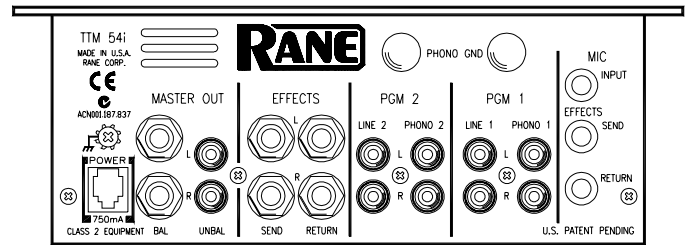

Rear View

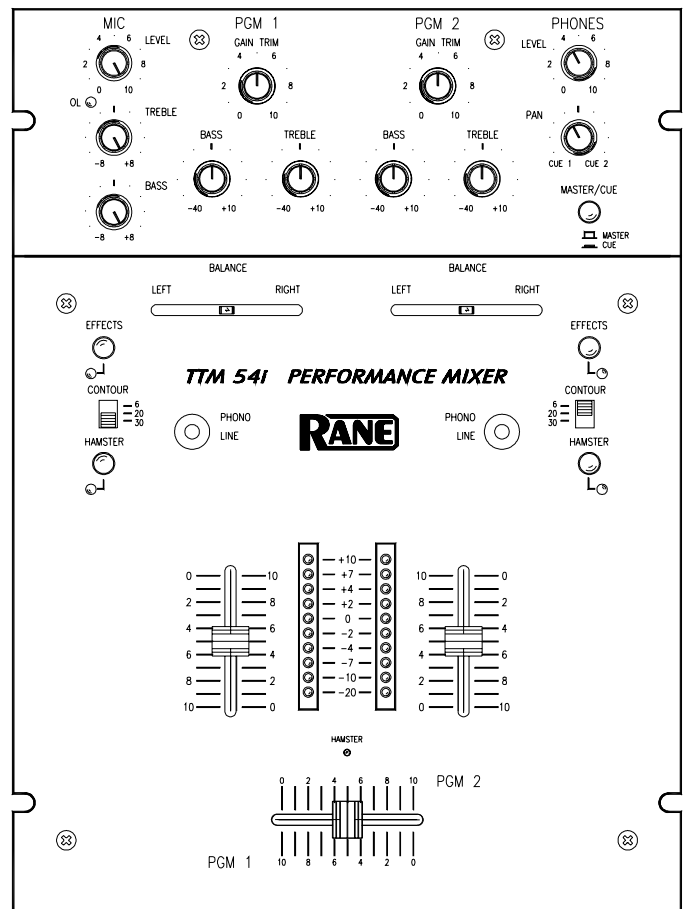

Top View

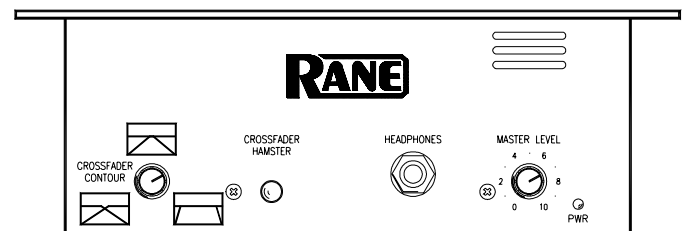

Front View

TTM 54i

PERFORMANCE MIXER

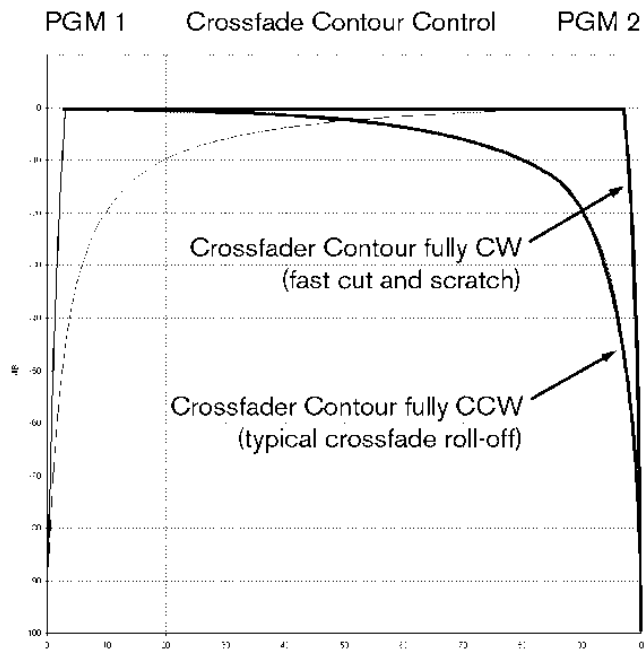
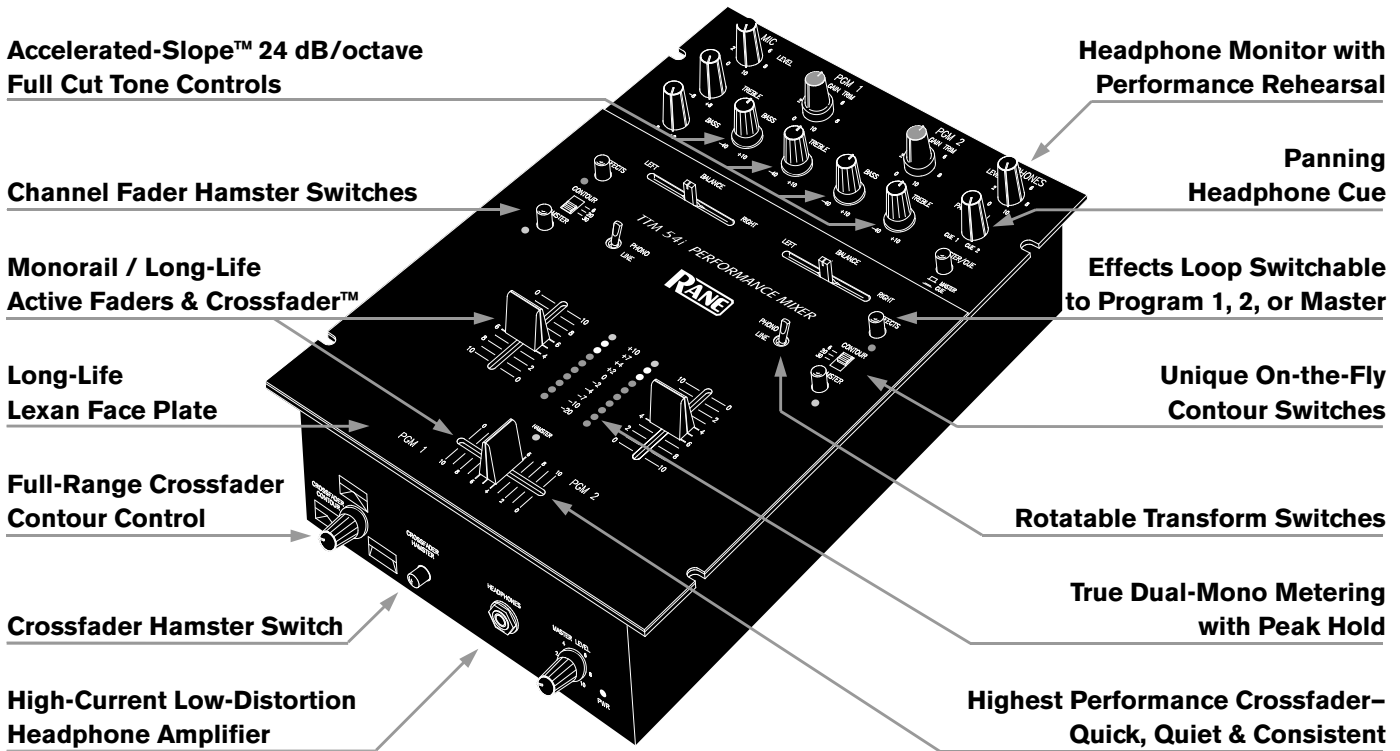

Figure 1. Crossfader Contour control

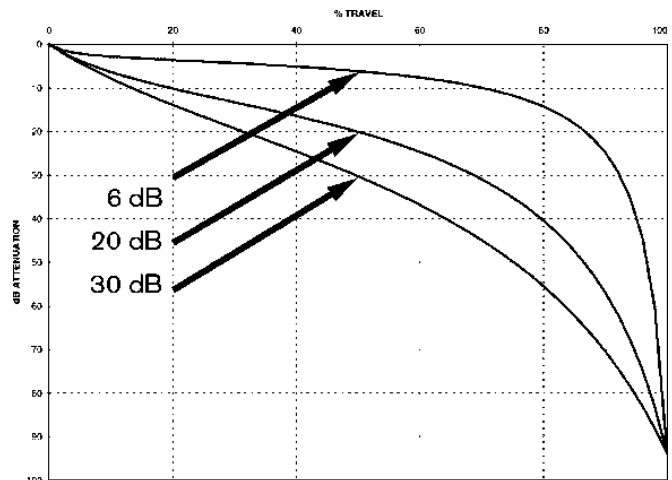

Figure 2. Input Fader Contour control switch positions at -6, -20 and -30 dB down points at the 50% fader position.

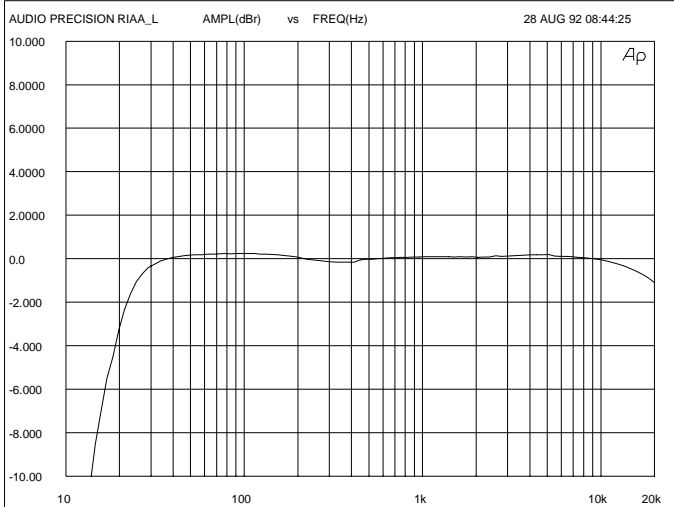

Fig. 3: Phono Response (using inverse RIAA)

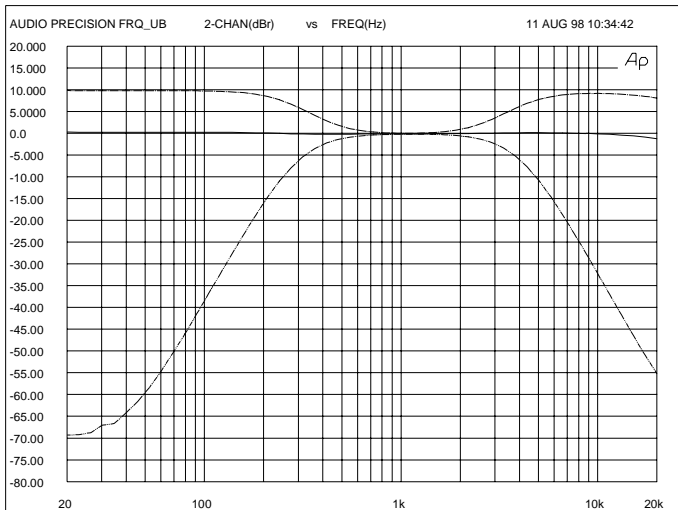

Fig. 4: Program Tone Controls

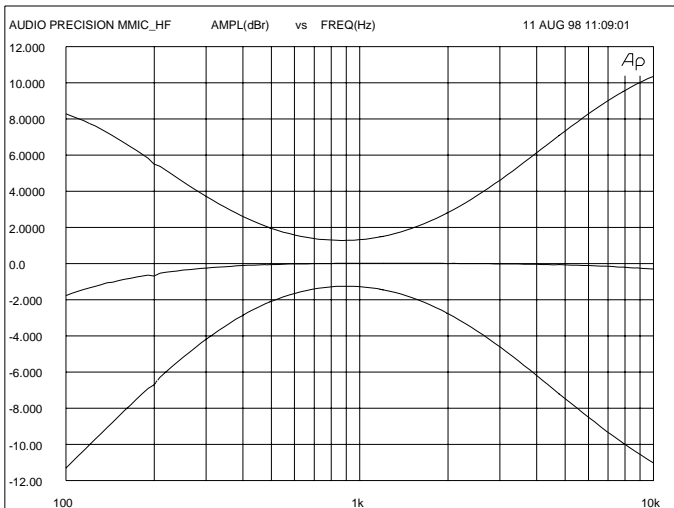
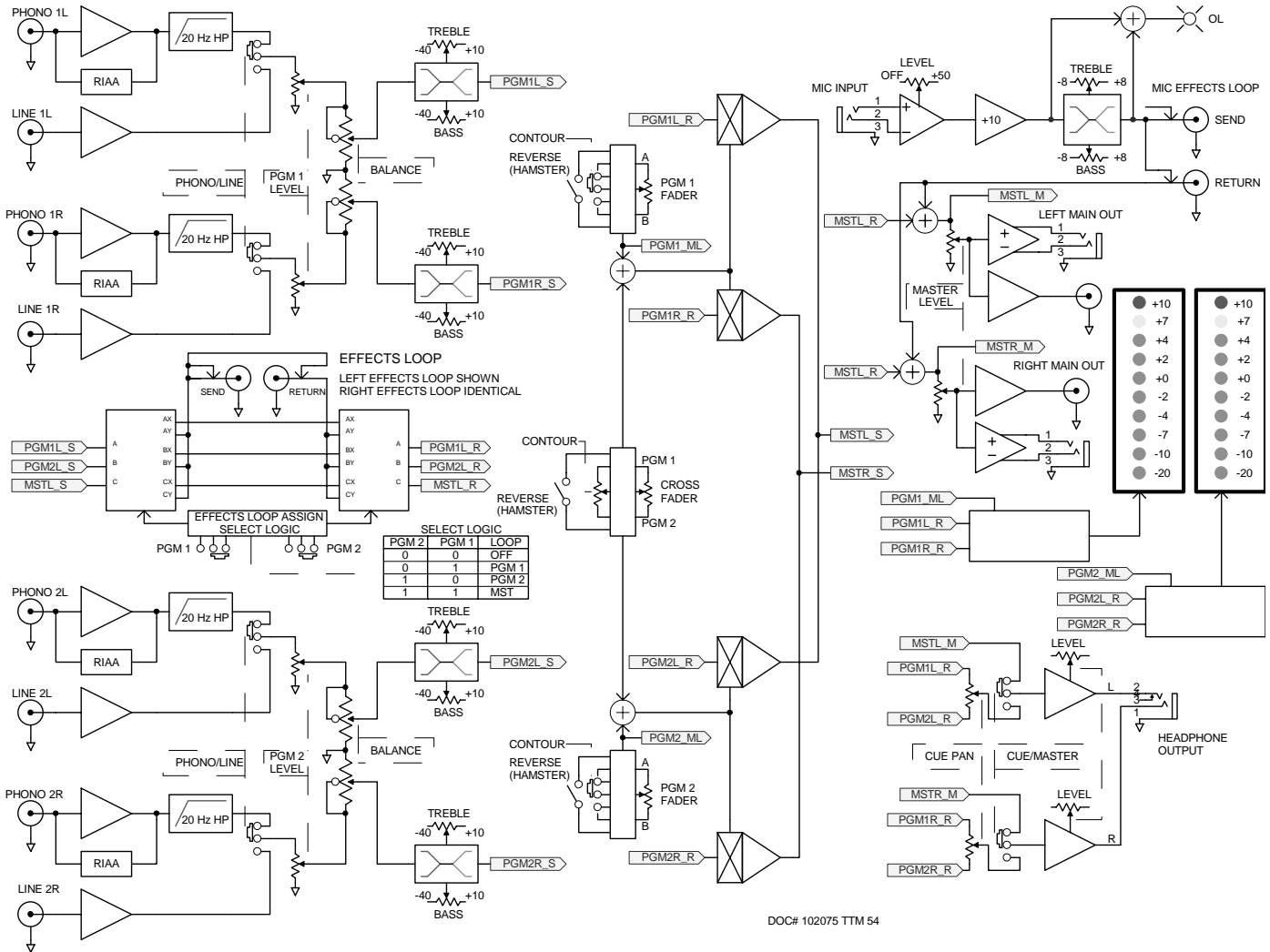

Fig. 5: Mic Tone Controls and Overall Response

Parameter	Specification	Conditions
Phono Inputs:	RIAA	See Fig. 3
...Number	2 Stereo	1 kHz
...Gain	40 dB	18 dB/oct. Butterworth, See Fig. 3
...Rumble Filter	20 Hz	
Line Inputs:	2 Stereo	
...Gain	12 dB	unbalanced out
...Gain	18 dB	balanced out
...Frequency Resp.	10 Hz-30 kHz	+0, -3 dB
...Noise	-98 dB	re +4 dBu, 20 kHz BW, unity gain
	-87 dB	re +4 dBu, 20 kHz BW, Max. gain
...THD+N	<0.1% typical	re 0 dBu, 20-20k Hz, 80 kHz BW
...Control Feed-through	<-80 dB	re +4 dBu, all controls
...Crosstalk	<-70 dB	re +4 dBu, 1 kHz
Mic:	Balanced	1/4" TRS
...Gain	60 dB	balanced output maximum gain
...Response & EQ	See Fig. 6	
...Noise	-70 dB	re +4 dBu, 20 kHz BW, Max. gain
...CMRR	>40 dB	re +4 dBu, 1 kHz
...Effects Loop	Independent, Non-Switched	
PGM Tone Controls:	Accelerated-Slope™ 24 dB/octave Band Split	
...Response	See Fig. 4	
PGM Assignable Effects Loop:	Effects Switch Select Logic — PGM 1/PGM 2	
	Off/Off	Off
	On/Off	Pre-Fader PGM 1
	Off/On	Pre-Fader PGM 2
	On/On	Master
Metering:	Dual Mono, 10 Segment	
	Post Program Fader; 1 sec. peak hold	
	Indicator Turn-on Blanking	
Max. Current:	750 mA RMS from remote supply	
Unit: Agency List		
...120 VAC model	Class 2 Equipment UL CSA	National Electrical Exempt Class 2 Exempt Class 2
...230 VAC model	CE-EMC CE-Safety exempt art. 1 LV 73/23/EEC	EMC 89/336/EEC
Power Supply: Agency List		
...120 VAC model	UL CSA	File E88261 File LR58948
...230 VAC model	CE-EMC CE-Safety	EMC 89/336/EEC LV 73/23/EEC
Unit: Size	3"H x 9"W x 11.75"D (7.6 x 23 x 30 cm)	
Shipping: Size	7.5" x 20" x 10.5"	(19 x 51 x 27 cm)
...Weight	11 lb	(5 kg)

Note: All specifications are typical unless otherwise stated.

Block Diagram



FEATURE

- Accelerated-Slope™ 40 dB Cut Tone Controls
- Assignable Effects Loop
- Highpass Rumble Filters
- Long-Life, Low-Noise Active Input Faders
- Front Panel Input Fader Contour Control
- Hamster Reversal Sw. For Input Faders
- Long-Life, Low-Noise Crossfader
- Crossfader Contour Control
- Crossfader Hamster Reversal Switch
- High Output, Low Distortion Headphone Amp
- True L+R Dual Mono Metering With Peak Hold
- High Resolution Meter Display
- Mic Effects Loop
- Greater Than 110 dB Dynamic Range
- High-Quality, Glass Epoxy PCBs
- Made In the USA

RANE TTM 54i PERFORMANCE MIXER

- YES (+10, -40)
- YES (PGM 1, PGM 2 or Master)
- YES (18 dB/Oct., each phono input)
- YES
- YES
- YES
- YES (VCA)
- YES (high accuracy, active)
- YES
- YES (200 mW @ .1% THD+N, 150 Ω)
- YES
- YES (10 segment)
- YES
- YES
- YES (double-sided)
- YES

RANE TTM 52i PERFORMANCE MIXER

- NO (±12 dB)
- NONE
- YES (18 dB/Oct., each phono input)
- YES
- NO
- YES
- YES (VCA)
- YES (high accuracy, active)
- YES
- YES (200 mW @ .1% THD+N, 150 Ω)
- YES
- YES (10 segment)
- YES
- YES
- YES (single-sided)
- YES

BRAND X PERFORMANCE MIXER

- NO (±15 dB)
- NONE
- NONE
- NO (passive)
- NO (internal 3-position)
- NO
- YES (light-driven resistor)
- YES
- NO
- NO (25 mW @ 1.2% THD+N, 150 Ω)
- NO (left channel only/no peak hold)
- NO (7 segment)
- NO
- NO (<100 dB)
- NO (single-sided phenolic)
- NO