

LIMITED WARRANTY

This product is warranted to the original consumer purchaser to be free from defects in materials and workmanship under normal installation, use and service for a period of one (1) year from the date of purchase as shown on the purchaser's receipt.

The obligation of Rolls Corporation under this warranty shall be limited to repair or replacement (at our option), during the warranty period of any part which proves defective in material or workmanship under normal installation, use and service, provided the product is returned to Rolls Corporation, TRANSPORTATION CHARGES PREPAID. Products returned to us or to an authorized Service Center must be accompanied by a copy of the purchase receipt. In the absence of such purchase receipt, the warranty period shall be one (1) year from the date of manufacture.

This warranty shall be invalid if the product is damaged as a result of defacement, misuse, abuse, neglect, accident, destruction or alteration of the serial number, improper electrical voltages or currents, repair, alteration or maintenance by any person or party other than our own service facility or an authorized Service Center, or any use violative of instructions furnished by us.

This one-year warranty is in lieu of all expressed warranties, obligations or liabilities. ANY IMPLIED WARRANTIES, OBLIGATIONS, OR LIABILITIES, INCLUDING BUT NOT LIMITED TO THE IMPLIED WARRANTIES OF MERCHANTABILITY AND FITNESS FOR A PARTICULAR PURPOSE, SHALL BE LIMITED IN DURATION TO THE ONE YEAR DURATION OF THIS WRITTEN LIMITED WARRANTY. Some states do not allow limitations on how long an implied warranty lasts, so the above limitation may not apply to you.

IN NO EVENT SHALL WE BE LIABLE FOR ANY SPECIAL, INCIDENTAL OR CONSEQUENTIAL DAMAGES FOR BREACH OF THIS OR ANY OTHER WARRANTY, EXPRESSED OR IMPLIED, WHATSOEVER. Some states do not allow the exclusion or limitation of special, incidental or consequential damages so the above limitation or exclusion may not apply to you. This warranty gives you specific legal rights, and you may also have other rights which vary from state to state.



ROLLS CORPORATION
SALT LAKE CITY, UTAH
4/02



GCi404 Audio Computer Interface

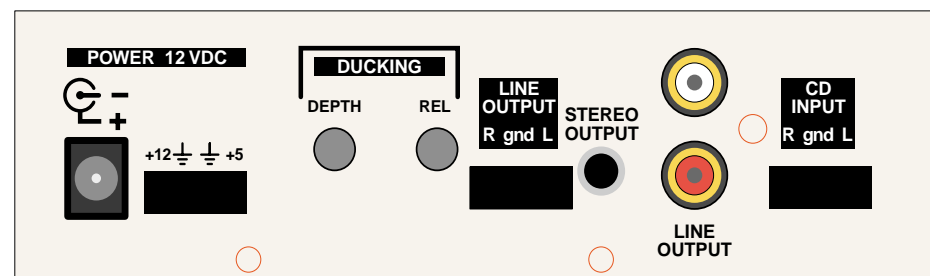
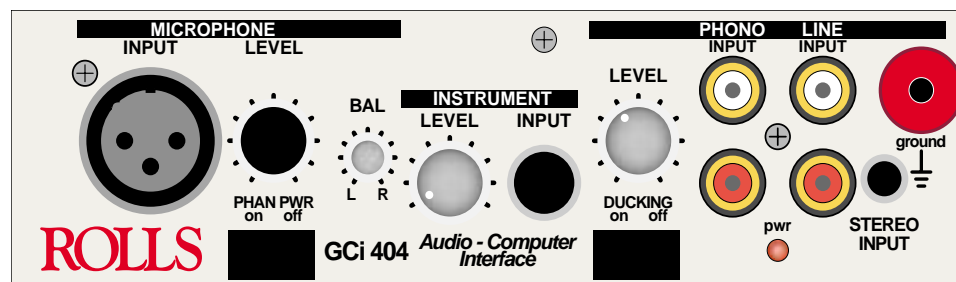

OWNERS MANUAL

Thank you for your purchase of the GCi404 Audio Computer Interface. The GCi404 mixes a balanced XLR Microphone signal with a 1/4" Instrument signal and a group of stereo Line Input signals to connect to any standard computer sound-card.

A ducking feature has been included in the GCi404 which, when engaged and a signal is present at the microphone, will duck the remaining input signals under the mic signal.

Uses for the GCi404 include commercial audio production, produce your own "commercial" on your computer, phonograph record to computer recording, etc.

FEATURES:

- Microphone input with 12 volt phantom power
- Instrument input
- RCA Line Input, Stereo 1/8" Line Input, RCA Phono Input with Ground post and RIAA equalization and Rumble Filter
- Individual Level controls for Mic, Instrument and Line Inputs
- Switchable automatic "Ducking" or talkover feature for Mic Input
- Stereo RCA, 1/8" TRS stereo, or 4-pin header connector Outputs

INSPECTION

1. Unpack and inspect the GCi404 box and package. Your GCi404 was carefully packed at the factory in a protective carton. Nonetheless, be sure to examine the unit and the carton for any signs of damage that may have occurred during shipping. If obvious physical damage is noticed, contact the carrier immediately to make a damage claim. We suggest saving the shipping carton and packing materials for safely transporting the unit in the future.
2. Please complete the Warranty Registration Card and return it to the factory.

TABLE OF CONTENTS

Introduction	1
Features	1
Inspection	1
Table of Contents	1
Description	2
Front Panel	
Rear Panel	
Connection	3
Operation	4
Computer Mounting	
Signal Level Adjust.	
Ducking	
Specifications	5
Schematic	6
Warranty	Back cover

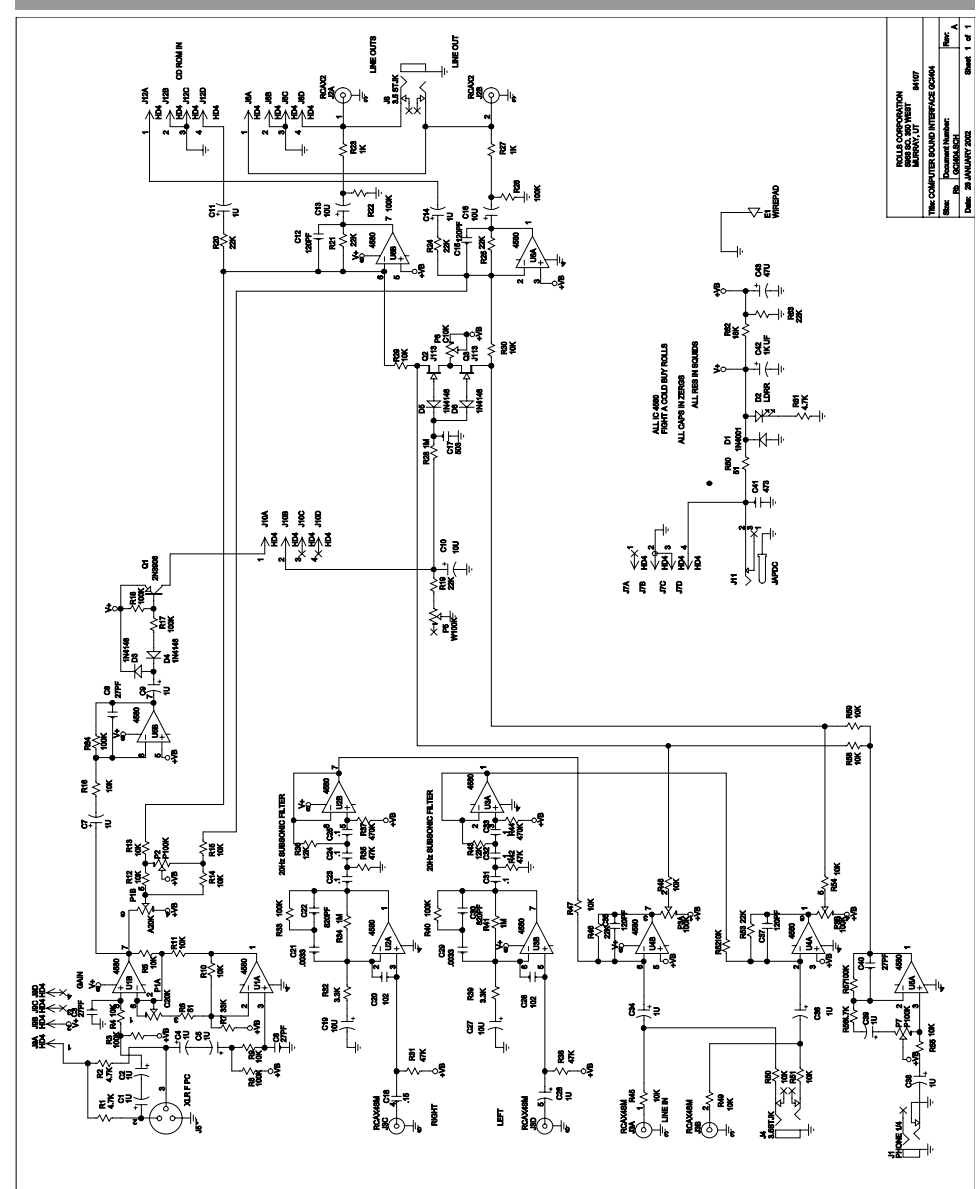

SPECIFICATIONS

MIC INPUT

Input Impedance:	10K Ω bal, unbal.
Max Input Level:	+4 dBV XLR bal, +10 dBV unbal.
Max Gain:	60 dB/XLR, 54 dB 1/4"
EIN:	-108 dB max.
THD:	<.01%
Phantom Power:	+12 Volts, 6 mA

INSTRUMENT INPUT

Input Impedance:	50k Ω
Max Gain:	30dB

LINE INPUTS

Input Connectors:	RCA, 1/8" TRS Stereo
Input Sensitivity:	30 dB gain @ 1kHz, 47k Ω Input Z
Input Impedance:	50k Ω

PHONO PREAMP

Input Impedance:	50k Ω
Equalization:	RIAA, +/- 2dB
Ref. Gain:	+20 dB @ 1 kHz

LINE OUTPUTS

Output Impedance:	100 Ω
Max Output Level:	+12 dB
Frequency Response:	+ / - 1.5dB 15 Hz - 30 kHz
THD:	.02% @ 1KHz
S/N Ratio:	>80 dB unweighted

Output Connectors: RCA, 1/8" TRS - Stereo, 4-pin hdr.

Dimensions: 1.7"H x 5.9" W x 3.7" D

Weight: 1 lb.

Power: 12VDC (Rolls PS27 Incl.)

DESCRIPTION

FRONT PANEL

MICROPHONE

INPUT: Balanced XLR jack for connection to low impedance dynamic or condenser microphone.

LEVEL: Adjusts the amount of signal in the microphone preamp.

PHANTOM PWR: Header connector - connects the 12VDC phantom power for the XLR Microphone Input.

BAL: Varies the relative amount of microphone signal sent to the Right and Left Outputs.

INSTRUMENT

LEVEL: Adjusts the amount of signal in the instrument circuitry.

INPUT: 1/4" unbalanced jack for connection to instruments such as guitars, keyboards, etc.

PHONO/LINE

LEVEL: Adjusts the level of all devices connected to the Phono or Line Inputs.

INPUT (Phono): Two RCA jacks for connection specifically to the output of a phono turntable.

INPUT (Line): Two RCA jacks for connection to line or consumer product outputs such as a CD or cassette player.

STEREO INPUT: 1/8" (3.5mm) TRS stereo jack for connection to a stereo line source such as a portable CD player or MP3 player.

GROUND: For connection to the grounding cable of a phono tuner.

DUCKING: Header connector - connects the Ducking function.

PWR: Indicates the GCi404 is properly connected to a power source.

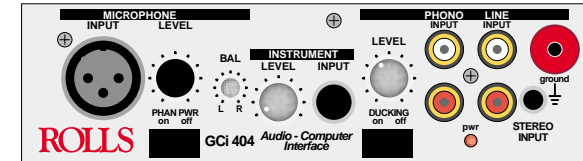

REAR PANEL

POWER: 12VDC, 150mA. 2.1 x 5.5mm barrel jack and header port - for connection to the Rolls PS27 AC adapter, or to the computer's 3 1/2 inch floppy drive power cable.

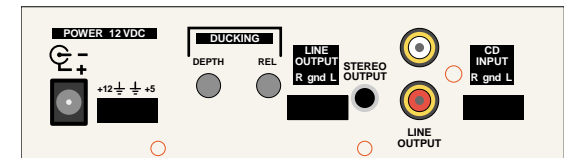

DUCKING

DEPTH: Adjusts the amount of LINE signal allowed to pass to the Outputs when ducking is occurring.

RELEASE: The amount of time taken for the ducked LINE signal to return to its normal level after the signal at the Mic Input stops.

CD INPUT Port: 4-pin header for connecting to a CD rom output port. A CD Rom audio cable is required.

LINE OUTPUTS:

STEREO OUTPUT: (1/8" (3.5mm) jack)

LINE OUTPUT (RCA):

LINE OUTPUT (Header Port):

Each of these outputs contain the Right and Left output signals.

Shown here is an example of possible input connections to the GCi404.

- If the microphone connected to the Mic Input is a condenser microphone, move the Phantom Power jumper to the ON position.
- The guitar signal may also be connected to a guitar preamp or processor before being connected to the GCi404.
- Turntables must use all three connections; the Right, Left, AND the Ground terminals are required for proper operation.
- Standard CD players may be connected to the RCA LINE INPUT in the same manner as the Portable CD Player.

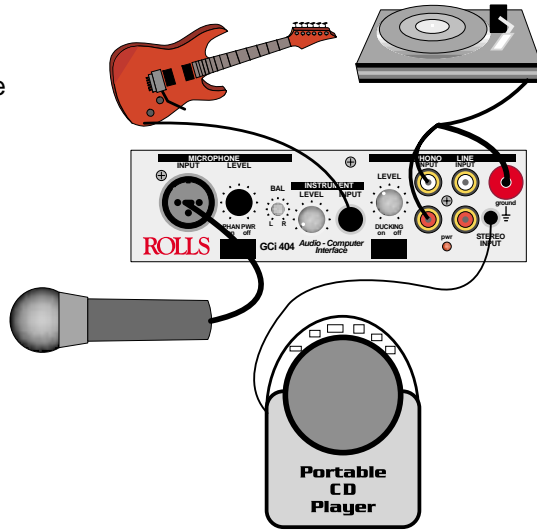

Shown here is an example of possible output connections from the GCi404 to your computer.

- The unit is powered via the included Rolls PS27, or connected to a 3-1/2" floppy drive power cable.
- The CD Input connects via a 4-pin connector to your CD Rom drive.
- The Stereo Output connects directly to your sound-card Input via a stereo Tip-Ring-Sleeve 1/8" (3.5mm) cable.
- The Line Output port uses a 4-pin header cable to connect to your sound-card Input header connector (if available).

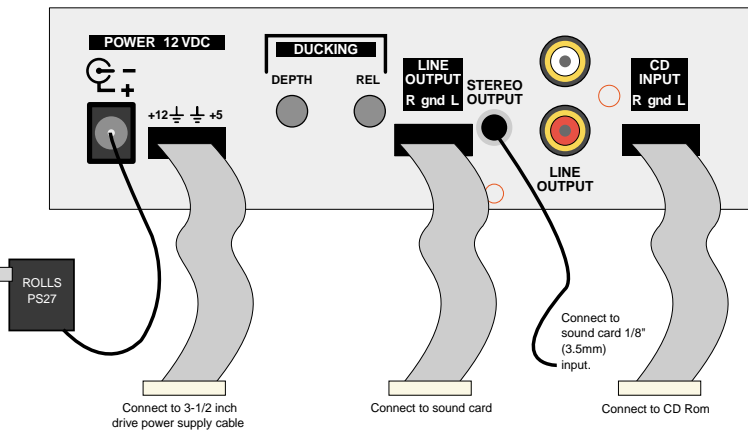

MOUNTING

Make sure the computer is off, and the AC power cord is unplugged.

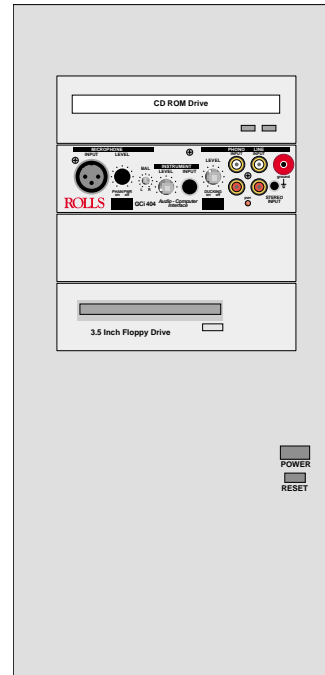

Select the drive bay you wish to mount the GCi404 into. Remember that you will have cords hanging down from the unit, so below a CD Rom drive is recommended. Remove the drive bay cover and gain access to the inside of your computer. Place the GCi404 into the open drive bay and secure it to the computer's internal mounting brackets using the enclosed mounting screws.

Connect all Power and Output cables. Plug the computer back into an AC outlet, and start it up.

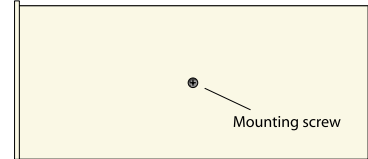

LEVEL ADJUSTEMENT

Connect the microphone, instrument, and line/phono sources. If the microphone being used is a condenser type, move the Phantom Power jumper to the ON position.

Bring up the software you will be using for recording. Set the LINE LEVEL control to approximately 12 O'Clock.

Send a signal from the line sources (CD players, turntables, cassette players etc.) first and adjust the Recording Control levels for a maximum input signal without clipping. You may need to refer to your operating system Help menus or owners manual for assistance in adjusting input recording levels.

Once you have a desired signal level, send signals from your instrument and microphone and adjust the Levels on the GCi404 front panel for appropriate levels.

DUCKING

NOTE: Adjustements for the Ducking function are made on the rear panel of the GCi404. You will need access to the inside of the computer if it is mounted in a drive bay.

To automatically mute all signals under your microphone, move the DUCKING jumper to the ON position.

Send program material such as music to the Line Inputs. Speak normally into the microphone and adjust the DEPTH control until the desired amount of Line signal is heard under your voice. If you want the Line signal muted completely, set the DEPTH control fully clockwise. Set the RELEASE control for the desired amount of time taken to return the level of Line signal back to normal after you stop speaking. When the RELEASE control is set fully counterclockwise, the time is at its longest. As the RELEASE control is adjusted clockwise, the release time gets shorter (faster).