

Rev. 3.0.4  
Item no. OM-D SERIES-LAKE

# D SERIES

## High-Power installation platform



### Lake Variants:

- D 200:4L
- D 120:4L
- D 80:4L
- D 40:4L
- D 20:4L
- D 10:4L

Incorporating technologies from



# LAB.GRUPPEN

## Operation Manual

## 1. Important safety instructions

Before using the device, be sure to carefully read the Safety Instructions. Keep this document with the device at all times.

1. Read these instructions.
2. Keep these instructions
3. Heed all warnings.
4. Follow all instructions.
5. Do not use this apparatus near water.
6. Clean only with a dry cloth.
7. Do not block any ventilation openings. Install in accordance with the manufacturer's instructions.
8. Do not install near any heat sources such as radiators, heat registers, stoves, or other apparatus (including amplifiers) that produce heat.
9. Do not defeat the safety purpose of the polarized or grounding-type plug. A polarized plug has two blades with one wider than the other. A grounding-type plug has two blades and a third grounding prong. The wide blade or the third prong is provided for your safety. If the provided plug does not fit into your outlet, consult an electrician for replacement of the obsolete outlet.
10. Protect the power cord from being walked on or pinched, particularly at plugs, convenience receptacles, and the point where they exit from the apparatus.
11. Only use attachments/accessories specified by the manufacturer.
12. Use only with a cart, stand, tripod, bracket, or table specified by the manufacturer, or sold with the apparatus. When a cart is used, use caution when moving the cart/apparatus combination to avoid injury from tip-over.
13. Unplug this apparatus during lightning storms or when unused for long periods of time.
14. Refer all servicing to qualified service personnel. Servicing is required when the apparatus has been damaged in any way, such as power-supply cord or plug is damaged, liquid has been spilled or objects have fallen into the apparatus, the apparatus has been exposed to rain or moisture, does not operate normally, or has been dropped.
15. Use the mains plug to disconnect the apparatus from the mains.
16. **WARNING:** To reduce the risk of fire or electric shock, do not expose this apparatus to rain or moisture.
17. Do not expose this equipment to dripping or splashing and ensure that no objects filled with liquids, such as vases, are placed on the equipment.
18. The mains plug of the power supply cord shall remain readily operable.
19. Do not connect the unit's output to any other voltage source such as battery, mains source, or power supply, regardless of whether the unit is turned on or off.
20. Do not remove the top (or bottom) cover. Removal of the cover will expose hazardous voltages. There are no user serviceable parts inside and removal may void the warranty.
21. An experienced user shall always supervise this professional audio equipment, especially if inexperienced adults or minors are using the equipment.
22. The US National Differences clause 16.3 requires that network cables must be flame rated VW-1.



## 2. Approvals



This equipment conforms to the requirements of the EMC Directive 2014/30/EU and the requirements of the Low Voltage Directive 2014/35/EU.

Standards applied: EMC Emission EN55103-1, E4  
EMC Immunity EN55103-2, E5, with S/N below 1% at normal operation level.  
Electrical Safety EN60065, Class I



This equipment is tested and listed according to the U.S. safety standard ANSI/UL 60065 and Canadian safety standard CSA C22.2 NO. 60065. Intertek made the tests and they are a Nationally Recognized Testing Laboratory (NRTL).

## 3. Warnings

### 3.1. Explanation of warning symbols



The lightning bolt triangle is used to alert the user to the presence of un-insulated "dangerous voltages" within the unit's chassis that may be of sufficient magnitude to constitute a risk of electric shock to humans.



The exclamation point triangle is used to alert the user to presence of important operating and service instructions in the literature accompanying the product.

### 3.2. Warnings

To prevent electric shock do not remove top or bottom covers. No user serviceable parts inside, refer servicing to qualified service personnel.

*Français:* À prévenir le choc électrique n'enlevez pas les couvercles. Il n'y a pas des parties serviceable à l'intérieur, tous reparations doit être faire par personnel qualifié seulement.



 To completely disconnect this equipment from the AC mains, disconnect the power supply cord plug from the AC receptacle. The mains plug of the power supply cord shall remain readily operable.

*Français:* Pour démonter complètement l'équipement de l'alimentation générale, démonter le câble d'alimentation de son réceptacle. La prise d'alimentation restera aisément fonctionnelle.

 To reduce risk of fire or electric shock, do not expose this apparatus to rain or moisture.

*Français:* Pour réduire les risques d'incendie ou de choc électrique, n'exposez pas l'appareil à la pluie ou à l'humidité.

 Do not expose this system/apparatus to dripping or splashing and ensure that no objects filled with liquids, such as vases, are placed on the apparatus.

*Français:* N'exposez pas ce système/appareil au ruissellement ni aux éclaboussures et assurez-vous qu'aucun objet contenant du liquide tel qu'un vase n'est placé sur l'appareil.

 This apparatus must be connected to a mains socket outlet with a protective earthing connection.

*Français:* Cet appareil doit être raccordé à une prise secteur avec terre de protection.

 The mains plug is used as a disconnect device and shall remain readily operable.

*Français:* Lorsque la prise du réseau d'alimentation est utilisée comme dispositif de déconnexion, ce dispositif doit demeurer aisément accessible.

### 3.3. Caution

 To reduce the risk of fire or electric shock, do not remove screws. No user-serviceable parts inside. Refer servicing to qualified service personnel.

*Français:* Pour réduire le risque d'incendie ou de choc électrique, ne pas retirer les vis. Aucune pièce réparable par l'utilisateur. Confier l'entretien à personnel qualifié.

## 3.4. User responsibility

### 3.4.1. Mains connection grounding

Your amplifier must be connected to a grounded socket outlet.

### 3.4.2. Speaker output hazard on amplifiers

Amplifiers are capable of producing hazardous output voltages. To avoid electrical shock, do not touch any exposed speaker wiring while the amplifier is operating. The external wiring connected to the speaker terminals shall be installed by a qualified person, or ready-made leads or cords of appropriate capacity shall be used.

As the power output channels on amplifiers produce high voltage, do not connect or disconnect speaker cables when the mains power is on.

### 3.4.3. Radio interference

A sample of this product has been tested and complies with the limits for the European Electro Magnetic Compatibility (EMC) directive. This equipment has also been tested and found to comply with the limits for a Class A digital device, pursuant to Part 15 of the FCC Rules. These limits are designed to provide reasonable protection against harmful interference from electrical equipment. This product uses radio frequency energy and if not used or installed in accordance with these operating instructions, may cause interference to other equipment, such as radio receivers.

This Class A digital apparatus complies with Canadian ICES-003.  
Cet appareil numérique de la classe A est conforme à la norme NMB-003 du Canada.

However, there is no guarantee that interference will not occur in a particular installation. If this equipment does cause harmful interference to radio or television reception, which can be determined by turning the equipment on and off, the user is encouraged to try to correct the interference by one or more of the following measures:

- Reorient or relocate the antenna.
- Increase the separation between the equipment and receiver.
- Connect the equipment to an outlet on a circuit different from that to which the receiver is connected.
- Check if the affected unit complies with the EMC limits for immunity, (CE-labeled). If not, address the problem with the manufacturer or supplier. All electrical products sold in the EC must be approved for immunity against electromagnetic fields, high voltage flashes, and radio interference.
- Consult the dealer or an experienced radio/TV technician for help.

### 3.4.4. Speaker damage

Amplifier apparatus is very powerful and can be potentially dangerous to both loudspeakers and humans alike. Many loudspeakers can be easily damaged or destroyed by overpowering them. Always check the speaker's continuous and peak power capabilities. Although the amplifiers attenuators can be used to reduce the overall gain, an increase of the input signal can result in full output power, which may cause damage to connected speakers.

### 3.4.5. Maintenance

For safe and reliable operation, the dust filters on both sides of the front panel, behind the grilles, should be removed and cleaned regularly to ensure maximum airflow through the device.

If the dust filters are not maintained there will be safety risks; for example, high internal temperatures could ignite the dust and start a fire. There is also a risk that the unit will malfunction since it is dependent on constant airflow from front to rear. If the dust filters are not clean and the unit malfunctions, any resulting problems will not be covered by the warranty.

# 4. Table of Contents

- 1. Important safety instructions ..... 2**
- 2. Approvals ..... 2**
- 3. Warnings ..... 2**
  - 3.1. Explanation of warning symbols ..... 2
  - 3.2. Warnings ..... 2
  - 3.3. Caution ..... 3
  - 3.4. User responsibility ..... 3
- 5. Introduction ..... 6**
  - 5.1. Welcome ..... 6
  - 5.2. D Series: Two versions available ..... 6
  - 5.3. Feature summary ..... 7
- 6. Installation ..... 8**
  - 6.1. Unpacking ..... 8
  - 6.2. Mounting ..... 9
  - 6.3. Cooling and fan operation ..... 10
  - 6.4. Operating voltage ..... 10
  - 6.5. Grounding ..... 11
- 7. Product overview ..... 12**
  - 7.1. Front panel ..... 12
  - 7.2. Rear panel ..... 13
- 8. Signal flow, routing and mute points ..... 14**
  - 8.1. Signal flow ..... 14
  - 8.2. Level Adjustments & Mute Points ..... 14
- 9. Front panel interface ..... 15**
  - 9.1. Frame status and control ..... 15
  - 9.2. Channel status and control ..... 15
  - 9.3. Frame select and ID ..... 16
  - 9.4. Additional front panel operations and indications ..... 17



<b>10. Rear panel interface</b> .....	<b>18</b>
<b>11. Operation and performance</b> .....	<b>19</b>
11.1. Operation precautions .....	19
11.2. Power output performance .....	19
11.3. Amplifier and Load Protection Systems .....	21
11.4. Power Supply .....	28
11.5. Auto power down .....	29
11.6. LoadPilot Load Monitoring .....	30
<b>12. Lake Processing and Lake Controller</b> .....	<b>33</b>
12.1. Introduction .....	33
12.2. Modules and Frames .....	33
12.3. Lake LoadLibrary™ and Fingerprints .....	34
12.4. Loudspeaker Processor Overview .....	34
12.5. Module, System and Sub-System Configuration Files .....	34
12.6. Frame and System Presets .....	34
<b>13. System configuration tutorial</b> .....	<b>35</b>
13.1. Network setup .....	35
13.2. Software installation and firmware update .....	36
13.3. System setup .....	37
13.4. Additional Software Reference Material .....	40
<b>14. Appendix</b> .....	<b>41</b>
14.1. Faults and warnings .....	41
14.2. Current draw and thermal dissipation .....	43
14.3. Maintenance .....	49
<b>15. Technical Specifications</b> .....	<b>50</b>
<b>16. Warranty and support</b> .....	<b>54</b>
16.1. General .....	54
16.2. Technical assistance and service .....	54

# 5. Introduction

## 5.1. Welcome

Thank you for choosing the Lab.gruppen D Series for your sound reinforcement needs. We are confident that you will be pleased with the performance, unique features, configuration flexibility, reliability, and long-term durability offered by this product.

For fast installation and use of this product, your welcome package includes a printed copy of the D Series Quick Start Guide (QSG). It provides a brief introduction to the features and functionality of the D Series and it also contains the information required to safely install the product and place it in service. Please read through the QSG thoroughly to become acquainted with the basic configuration and control options available. It is recommended that you also review all other product documentation to ensure familiarity with the various configuration and control options.

Thank you again for placing your confidence in Lab.gruppen products.

## 5.2. D Series: Two versions available

D Series is an advanced, high-power installation amplifier platform designed for demanding applications, primarily in performance venues. For the utmost flexibility in processing and networking, the D Series is available in two versions: the Lake version, with a full slate of Lake processing algorithms, Dante and AES67 audio networking; and the Tesira by Biamp version for full integration in a Tesira system and with Ethernet AVB audio transport. D-series Tesira versions are available in three output power levels, whereas the D-series lake versions are available in six output models. The six Lake power output models come in two form factors. Three high power models in a standard form factor and three lower powered models in a slimline, single rack unit, form factor.

This operation manual is for use with Lake processing versions only, and applies to models at all six output power levels. The models D 200:4L, D 120:4L, D 80:4L, D 40:4L, D 20:4L and D 10:4L will further on only be referred to as D200, D120, D80, D40, D20 and D10.

## 5.3. Feature summary

### 5.3.1. Features common to both D Series variants

- Four channels with six levels of total available frame power output: 20000 W, 12000 W, 8000 W, 4000 W, 2000 W and 1000 W
- Rational Power Management (RPM)
  - True flexibility in allocating power output across each channel to match requirements, for more efficient use of amplifier inventory
  - Any channel is capable of being significantly scaled up to match power requirements.
- Dedicated on-board surveillance and load monitoring for voice alarm applications
- Advanced universal power supply
  - Regulated Switch-Mode Power Supply (R.SMPST<sup>™</sup>) maintains stability through fluctuations in mains voltage
  - Best-in-class Power Factor Correction (PFC)
  - Current Draw Modeling (CDM<sup>™</sup>) reduces peak mains draw
  - Breaker Emulation Limiter (BEL<sup>™</sup>) responds to available mains distribution
  - Under-Voltage Limiting (UVL<sup>™</sup>) allows continued operation through mains voltage drop
- CAFÉ (Configuring Amplifiers For the Environment) software incorporates ESP<sup>™</sup> (Equipment Specification Predictor) to assist in design, equipment specification and commissioning
- Features controlled by on-board DSP
  - Amplifier gain is set in the digital domain and controlled via the Lake Controller software.
  - ISVPL<sup>™</sup> – The Inter-Sample Voltage Peak Limiter (ISVPL) tailors each channel's power output to the characteristics of the connected load
  - Load Verification & Performance Monitoring – A comprehensive set of proprietary DSP-based tools enables load verification and real-time performance monitoring



NOTE: The D200, D120 and D80 models have the possibility to bridge two power outputs to further increase scalability. This feature is not available on the D40, D20 and D10 models.

### 5.3.2. Features unique to Lake variant

- Lake's exclusive classic/linear-phase/FIR speaker processing platform with four throughputs
- Group control with Raised Cosine<sup>™</sup> MESA EQ<sup>™</sup> asymmetric filters
- LimiterMax<sup>™</sup> peak and RMS limiters
- Extensive loudspeaker preset database (Lake LoadLibrary<sup>™</sup>)
- Comprehensive clocking management system with low latency sample rate conversion
- Full support for Dante Controller
- Multiple and redundant inputs with programmable failover
  - Four "Lake Class" analog inputs with Iso-Float<sup>™</sup> ground isolation
  - Two AES3 digital inputs (4 audio channels)
  - Eight dual-redundant Dante network audio inputs with AES67 support
- Comprehensive 3rd party protocol for integration potential with third party matrix systems via purpose-developed middleware

### 5.3.3. Other Documentation

This Operation Manual is intended to serve as a guide and reference to the operation and maintenance of the D Series Lake hardware platform. Comprehensive information is given regarding installation, connection and operation of the front panel interface.

D Series Lake amplifiers are designed for configuration and operation using the Lake Controller and CAFÉ software programs. This manual includes a brief tutorial on how to put an amplifier into service using Lake Controller, and it also includes an overview of some features that are implemented via CAFÉ.

For complete information on DSP configuration and operation using Lake Controller, please refer to the Lake Controller Manual, available online at [www.labgruppen.com/support](http://www.labgruppen.com/support).

For detailed information on configuration and operation of the power platform using CAFÉ, please refer to the guide embedded in the software or to the CAFÉ Coach video series available on the Lab.gruppen YouTube channel or via a link on the Lab.gruppen web site.

## 6. Installation

### 6.1. Unpacking

Carefully open the shipping carton and check for any damage to the device or the supplied accessories. Every Lab.gruppen product is tested and inspected before leaving the factory and should arrive in perfect condition. If any damage is discovered, please notify the shipping company immediately. Only the consignee may initiate a claim with the carrier or their insurers for damage incurred during shipping. Save the carton and packing materials for the carrier's inspection.

#### 6.1.1. Included in the box

In addition to the D Series device, the shipping carton includes the following items:

- D Series Lake Quick Start Guide
- AC mains lead (power cable) with Neutrik powerCON connector (D200, D120 and D80) or IEC connector (D40, D20 and D10) and AC socket plug according to ordering selection
- Rear brackets for additional rear rack support (pair) along with associated mounting hardware
- Connector kit including all needed connectors
- Front grille and dust filter assembly



NOTE: Depending on the model, the connector kit might include more connectors than applicable for the product you have. Select those connectors required for your unit and application.

Please keep the original carton and associated packaging to facilitate shipping of the device should the need arise.

## 6.2. Mounting

D Series is made for mounting in 19 inch racks. Four screw holes are available for attachment of the amplifier to the racks front rack rail. This device has no top or bottom vents; therefore, units may be stacked directly on top of one another. Sufficient space should be available at the rear to accommodate connectors and cables. In addition, allowance must be made for cable or loom bends within a rack.

### 6.2.1. Rear Mounting

Two rear support brackets, along with associated mounting hardware, are included with the D Series device. It is strongly recommended that these are used wherever possible. Fit the brackets to the vertical rails at the rear of the rack. The following diagrams show the fitting options for fixed and removable installation. The support brackets are reversible and may be fitted to point either to the front or rear of the rack; the proper orientation depends on the rack depth and position of the rear rack rails.

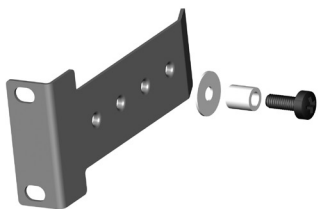

**Figure 6.1: Rear support bracket with mounting hardware**

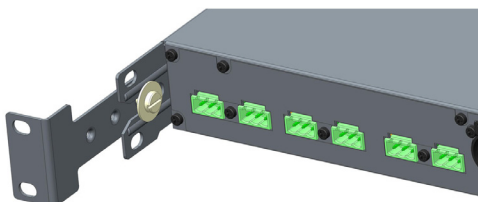
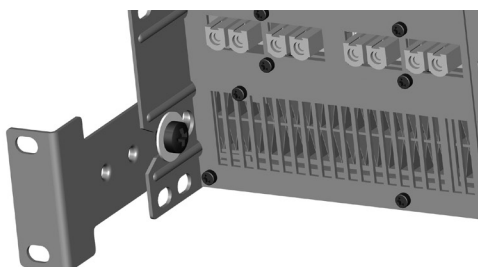

**Figure 6.2: Rear support bracket mounted for fixed installation and bracket pointing forward**

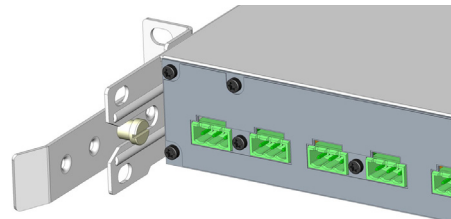
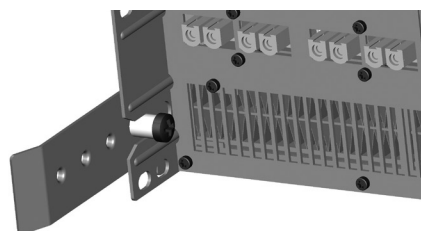

**Figure 6.3: Rear support bracket mounted for removable installation and bracket pointing towards rear**

### 6.2.2. Mounting front grille

The front grille is shipped on top of the amplifier inside the box to protect it during shipping. The front grille adheres to the amplifier with magnets. Hold the front grille with your fingers in each of the side cutouts and slide it gently into place straight from the front.



**NOTE:** Always ensure the dust filters behind the detachable front panel are clean to ensure maximum possible airflow. The exterior front panel is held in place by powerful magnets but is easy to detach by using your fingers in the openings at the each side. To clean the foam filter, detach it from the exterior front and gently use a vacuum cleaner or gently shake it. Remount with the opposite procedure. Never operate the amplifier without the dust filter installed.

### 6.3. Cooling and fan operation

D Series devices use a forced-air cooling system with airflow from front to rear, allowing high continuous power levels without thermal problems. To facilitate maximum air flow, ensure that no objects such as rack doors or lids are placed at the front or rear of the rack. Never attempt to reverse the airflow. Make sure an adequate air supply is provided in front of the D Series device, and that the rear of the device has sufficient space to allow air to escape. It is recommended to keep the ambient temperature around the device as cool as possible. An increased temperature can have a significant negative impact on the expected lifetime on the components inside the D Series device.

**NOTE:** Fit solid blanks (not ventilation blanks) to unused rack spaces to ensure effective air circulation. Leaving gaps in between items of equipment degrades the effectiveness of forced-air cooling.

If installing one or more D Series devices in a rack with other fan-cooled equipment, confirm that all other equipment also uses front-to-rear airflow for cooling. If this precaution is not observed, there is a risk of overheating, as units with the reverse airflow will be drawing in air which has already been heated by the D Series devices.

The D Series device is equipped with a sophisticated temperature sensing system which protects it from any overheating which may occur as a result of inadequate ventilation.

### 6.4. Operating voltage

D Series has a universal power supply and its mains nominal and operating voltages are specified in the Technical Specifications. D Series can be ordered with a variety of mains plugs. If the mains plug (AC plug) fitted to the mains cable (AC cord) is not appropriate for your country it can be removed and a locally-sourced one fitted instead. If you are not 100% confident of your competence to replace the mains plug (AC plug), the task should be carried out by qualified personnel.



**NOTE:** In-rush current is controlled and limited during the soft-start sequence. This enables multiple D Series Devices on the same AC mains circuit to be turned on simultaneously.



### 6.4.1. Low voltage country considerations

Although the D Series has a wide range of operating mains voltage, some considerations can be applicable for low voltage regions. D Series performs well throughout the specified nominal voltage range but has slightly better efficiency at higher voltages. For regions with nominal voltage below 140 V, one could consider connecting the amplifier in a three phase delta or two phase split-phase configuration, especially applicable for the bigger models, (D200, D120 and D80).



NOTE: Following connections applicable only for resulting voltage inside the amplifiers nominal voltage range.

#### Connecting the amplifier in three phase delta configuration

In three-phase configuration where the phases are 120 degrees apart, one can connect three balanced loads in a delta configuration. The connection is made between the phases instead of between the neutral and a phase.

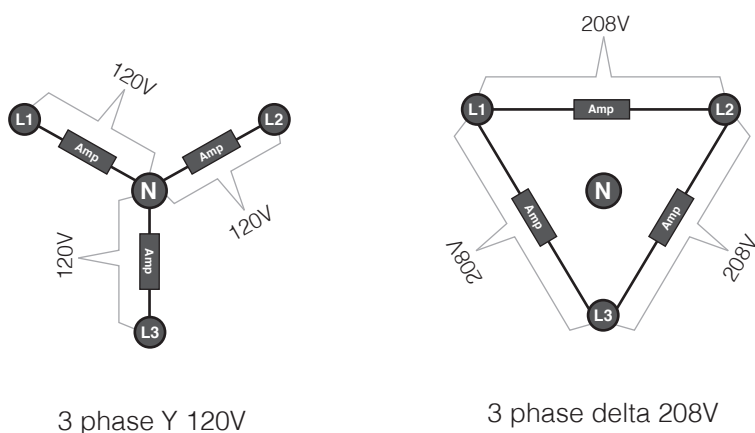

Figure 6:4: Three phase delta configuration

#### Connecting the amplifier in a split phase configuration

In two phase split-phase configuration there are two phases separated by 180 degrees. Connecting between the phases gives double the line voltage.



Figure 6:5: Two phase split-phase configuration

## 6.5. Grounding

D Series must be grounded (earthed) with the safety ground pin to the mains distribution system. NEVER disconnect the earth (ground) pin on the mains cable (AC power cord). Use correctly-shielded balanced audio input connections to minimize hum and interference.

# 7. Product overview

## 7.1. Front panel

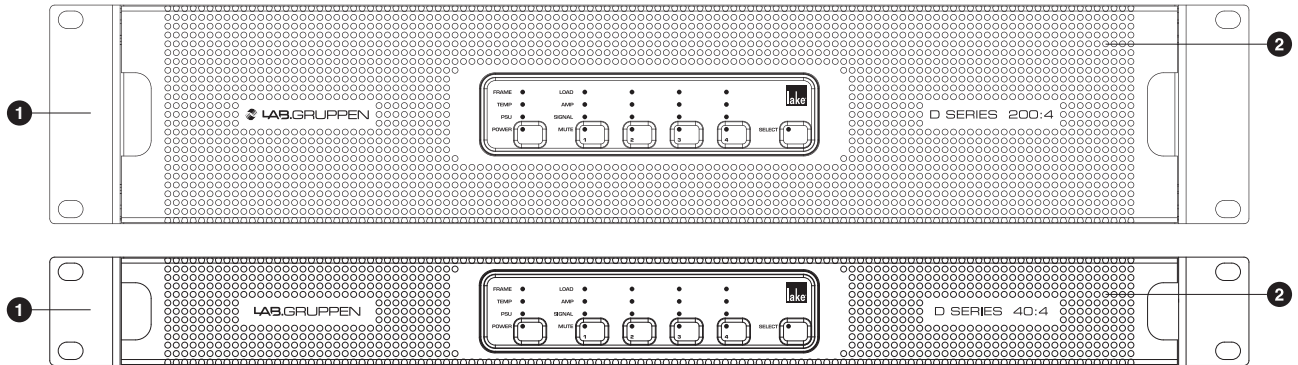

The front panel consists of an outer front with air intake and a centered user interface. The user interface has LEDs for monitoring and six recessed touch buttons for control.

- ❶ **Rack ears** for 19 inch rack mount
- ❷ **Exterior front grille** (also air intake and dust filter holder)

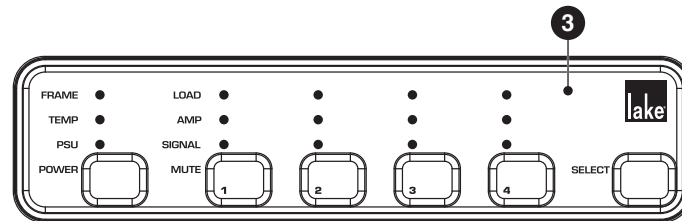

- ❸ **Touch and LED panel** – See section 9.1 for further information.

## 7.2. Rear panel

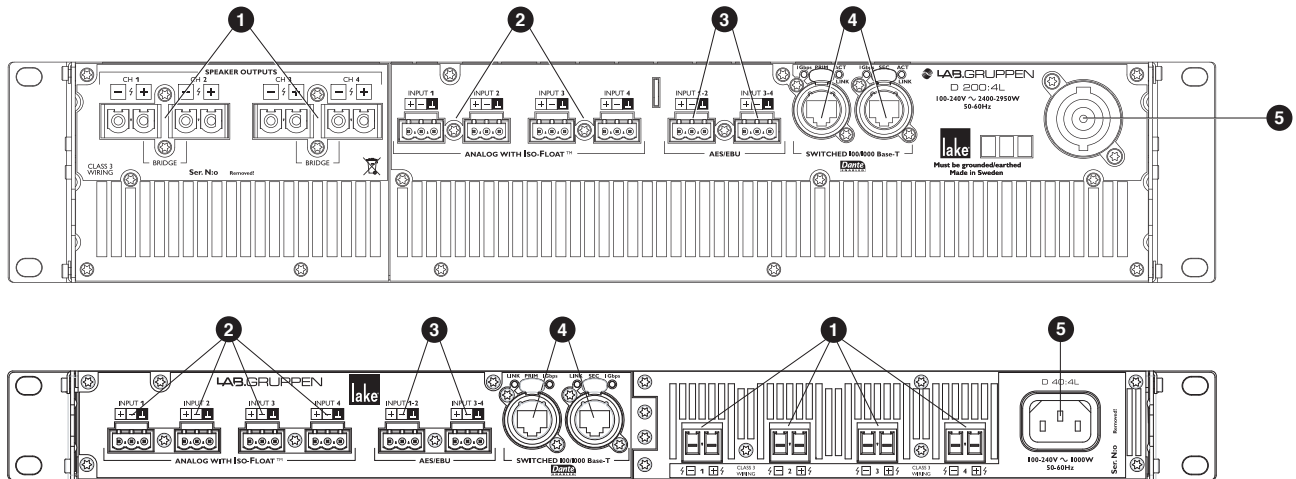

- ❶ **Amplifier Outputs** - The amplifier output connectors are sturdy terminal block connectors. See Technical Specifications (Section 15) for connector rating. Channels are located from left to right. Each channel has a clearly marked hot (+) and cold (-) terminal
- ❷ **Analog Inputs** - Analog inputs are available on terminal block connectors with clearly marked hot (+), cold (-) and ground terminals
- ❸ **AES3 Inputs** - AES3 inputs are available on terminal block connectors with clearly marked hot (+), cold (-) and ground terminals
- ❹ **RJ-45 Ethernet connectors** for control, Dante and AES67 digital audio network
- ❺ **Mains connector** - Detachable Neutrik powerCON (for D 200, D 120 and D 80) or locking IEC connector (for D 40, D 20 and D 10). See Technical Specifications (Section 15) for connector rating

## 8. Signal flow, routing and mute points

### 8.1. Signal flow

The figure below depicts the audio signal flow for a D Series Lake device. It is worth noting that this sophisticated device provides seven points in the signal chain where the signal level can be adjusted, muted or disconnected.

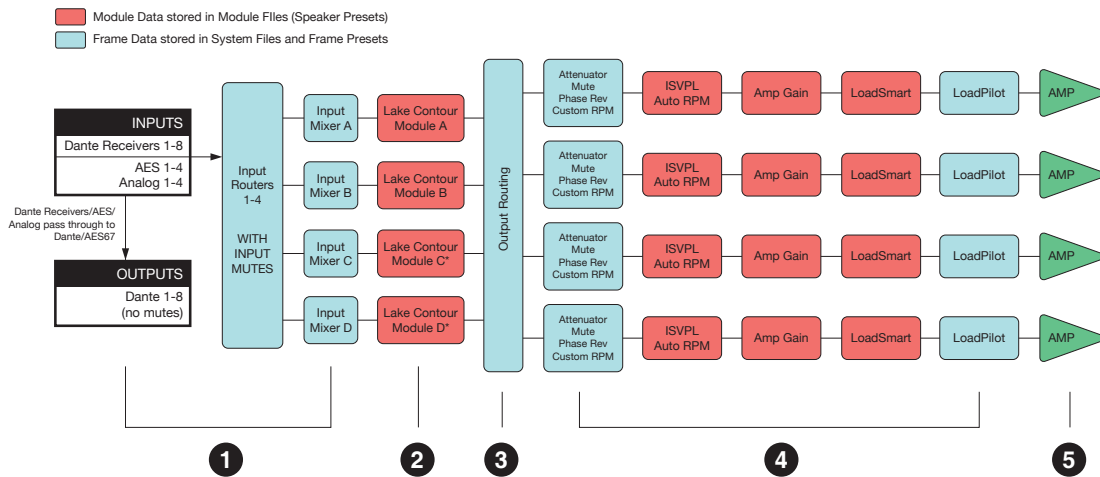

**Figure 8.1: D Series Lake Signal Flow Diagram**

- ❶ The input section (inputs, input router and input mixer) allows for mixing capabilities as well as redundant and prioritized inputs with automatic switch-over in case of signal failure
- ❷ Up to four Lake Processing modules provide user EQ and loudspeaker processing, including LimiterMax limiting
- ❸ The Output router allows free routing between module outputs and power output channels
- ❹ Each power output channel provides individual channel processing, including ISVPL limiter, RPM and load monitoring
- ❺ Power amplifier

### 8.2. Level Adjustments & Mute Points

The following points in the signal flow can adjust level or mute the signal:

- |                              |  |
|------------------------------|--|
| <b>1 Input Router Stage</b>  | Input selection and MUTE                             |
| <b>2 Input Mixer Stage</b>   | Router on /off connection to mixer and gain settings |
| <b>3 Module Input Stage</b>  | Mute and gain settings                               |
| <b>4 Module Output Stage</b> | Mute and gain settings                               |
| <b>5 Output Router Stage</b> | Output on /off routing connections                   |
| <b>6 Attenuation Stage</b>   | Power output channel mute and attenuation settings   |
| <b>7 Amp Gain Stage</b>      | Amplifier gain control                               |



NOTE: If the required audio signal is not passing correctly, verify the connection, mute and gain settings at all seven stages.

## 9. Front panel interface

### 9.1. Frame status and control

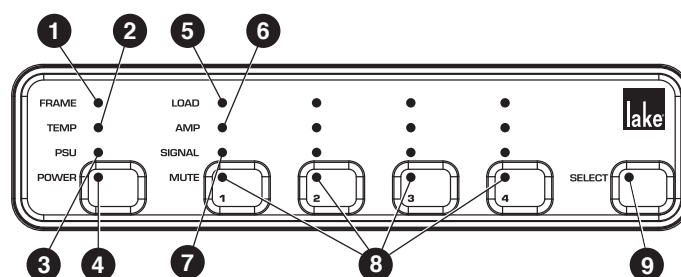

NOTE: General status indication shown in Table 9.1. For detailed information on warning and fault indication, please refer to the Faults and Warnings table in Section 14.1.

- ❶ **FRAME LED** – Provides status indication for a number of functions affecting the amplifier frame
- ❷ **TEMP LED** – Provides status indication for internal temperatures sensed at multiple points, including power supply, DSP and output channels
- ❸ **PSU LED** – Provides status indication on functionality of Power Supply Unit and mains supply, including under- and over-voltage, power supply faults, and unstable mains supply
- ❹ **POWER LED and TOUCH BUTTON** – Provides power state indication and control. Press and hold button to toggle the amplifier between ON and STANDBY state. LED indication given in Table 9.1.

### 9.2. Channel status and control

- ❺ **LOAD LED** – Provides load related status indication for monitoring functionality of LoadSmart and LoadPilot. Warnings and faults indicate problems or anomalies detected in the connected loudspeakers and/or cabling
- ❻ **AMP LED** – Provides amplifier related status indication, including faults and warnings related to temperature, over-current, clipping and very high frequency
- ❼ **SIGNAL LED** – Provides signal related status indication, including no signal and input signal clipping
- ❽ **MUTE LED and TOUCH BUTTON** – Provides mute status indication and control. The LED is indicating both Lake mutes and power channel mute. A single touch on the mute button toggles the power channel mute between mute and unmuted states
- ❾ **SELECT LED and TOUCH BUTTON** – for selection and indication control between computer software and unit

	OFF	Green	Amber	Red
<b>Frame</b>	N/A	Frame OK	Frame warning	Frame fault
<b>Temp</b>	N/A	Temp OK	Temp warning	Temp fault
<b>PSU</b>	N/A	PSU OK	Power supply/ Mains warning	Power supply/ Mains fault
<b>Power</b>	No mains power	Fixed: ON Blinking: Turning ON	Button pressed. Hold for transition	Fixed: STANDBY Blinking: Turning to STANDBY
<b>Load</b>	No LoadPilot active	LoadPilot active and LoadOK	Load warning	Load fault
<b>Amp</b>	N/A	Power channel OK	Power channel warning	Power channel fault
<b>Signal</b>	Output below signal present threshold (-60 dB)	Output above signal present threshold (-60 dB)	Input signal approaching input clip (-2 dB)	Input signal clip or limit/fault active
<b>Mute</b>	Inactive channel in bridge operation	Unmuted	Lake module is muting the signal chain at either input router, module input or module output	Power channel muted
<b>Select</b>	Frame not selected	Frame selected	Waiting for more touches	N/A

**Table 9.1: LED/category chart**

### 9.3. Frame select and ID

- SELECT LED and TOUCH BUTTON** – Selects mode and indicates control between computer software and unit. A single touch on the button will select the unit in supported computer software views. Multiple consecutive touches will select the corresponding Lake module (one touch for module A, 2 for module B etc.). In the other direction, when selecting the unit in a supported computer software view, the LED will indicate the unit is selected with steady green illumination.



NOTE: The touch buttons use capacitive touch technology and might be sensitive to large temperature and humidity variations.



## 9.4. Additional front panel operations and indications

### 9.4.1. Frame reset

A factory reset and soft reset can be performed from the front panel. A factory reset will restore all settings to original defaults, including network settings, frame presets and current settings. A soft reset reverts only the current settings to default. Network settings and frame presets are not changed with a soft reset.

6. Place the frame in standby mode.
7. Press and hold Select and channel 3 mute button. Then press the power button.
8. User interface will illuminate available options. Choose from the options below
  - a. Press channel 1 mute button (red LED) to initiate the factory reset sequence.
  - b. Press channel 2 mute button (amber LED) to initiate the soft reset sequence.
  - c. To cancel, press channel 4 mute button (green LED).
9. Wait state indication is present while either reset is performed.
10. To complete the factory reset process, cycle the mains power by completely removing the power plug and reinserting it.

### 9.4.2. Wait indication

Wait indication is displayed when the frame is performing an operation. All LEDs except power are unlit and a circling amber light is displayed on channels 1 and 2.

### 9.4.3. Power cycle required indication

After an operation that requires a subsequent power cycle to complete, the power LED blinks alternately red and green. A Power cycle requires that the mains is completely removed from the device and not connected again until the device has powered off.

### 9.4.4. Front panel lock

The front panel can be disabled from the Lake Controller. When the front panel is disabled, LEDs 4, 8 and 9 (all buttons on the lowest row) flash in amber when hitting any touch button.

## 10. Rear panel interface

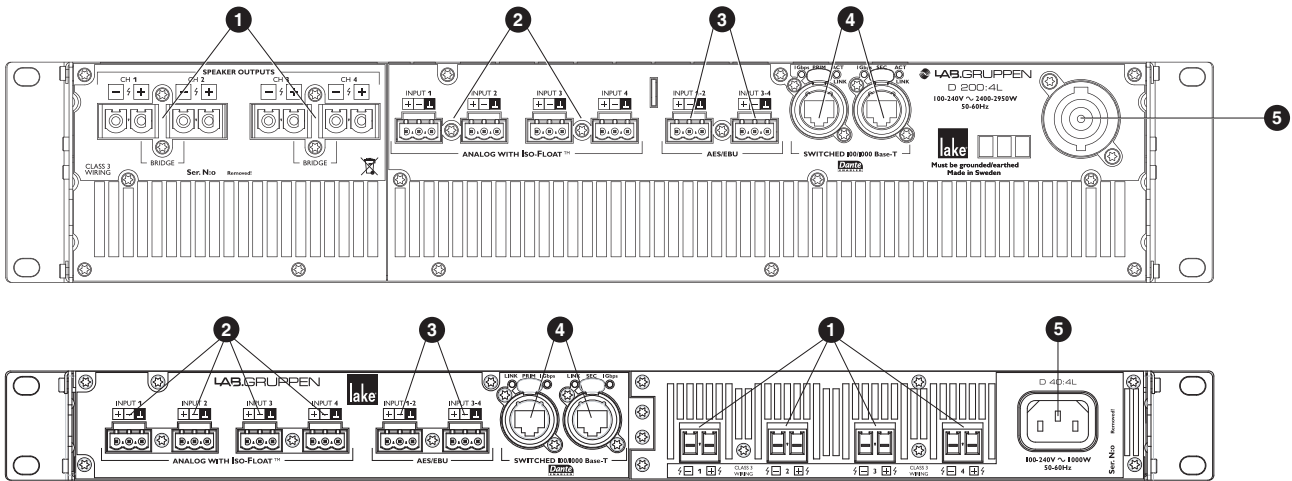

For electrical specifications on inputs and outputs, please refer to Technical Specifications in Section 15.

- ❶ **Amplifier Outputs** – The amplifier outputs utilize mating Phoenix-type connectors. Connect loudspeaker cables to the mating plug-in connectors observing polarity (including bridge mode option for D200, D120 and D80) as marked on the rear panel
- ❷ **Analog Inputs** – Analog inputs are available on terminal block connectors with clearly marked hot (+), cold (–) and ground terminals. The inputs are electronically balanced and feature Lake Iso-Float circuitry
- ❸ **AES3 Inputs** – AES3 inputs are available on terminal block connectors with clearly marked hot (+), cold (–) and ground terminals
- ❹ **RJ-45 Ethernet connectors** for control, Dante and AES67 digital audio network. Neutrik etherCON connectors accept either mating etherCON connector or a standard RJ-45 connector.

**Primary Network Connector** – The primary connection provides integration into an Ethernet control network which may include other Lake Processors and the Lake Controller software. Network connection permits full control of all functions along with real-time metering from a remote position.

This device supports the Dante audio networking protocol, which allows transmission of multichannel, high-definition digital audio over the same Ethernet connection. AES67 audio flows are also supported.

Use the primary connector when using a star network topology, consisting of individual Cat-5e connections between the devices and an Ethernet switch. Alternatively this connection can be used to daisy chain directly to another Lake Processor. The daisy chain topology should not be used with Dante.

Additional information is also available in the Lake Network Configuration Guide.



NOTE: The Ethernet ports operate at the Ethernet data rate of up to 1 Gbps and allow straight or crossed network cables. LEDs above each port indicate network activity (ACT) and Gigabit network connections (Gbps). If Gbps LED is unlit, speed is 100 Mbps.

**Secondary Connector** – The secondary network connector can be used to create a Dante dual-network topology by connecting all secondary network connectors to a separate Ethernet switch, ensuring full redundancy in the event of a network component failure. Alternatively, the secondary network connector can be used to daisy-chain multiple Lake devices (LM, PLM, PLM+ or D Series), if Dual Redundancy is Disabled from the Lake Controller. When the device is in Dual Redundancy, it is possible to connect a Lake Controller to the Secondary Connector as long as the IP address on the computer is on the 172.31.x.x subnet.

If the device has dual redundancy enabled, any AES67 audio must be on the primary network (i.e. AES67 cannot be transmitted or received on the secondary connector).



NOTE: Additional processor configuration is required for daisy-chain network set-up. The device may be configured via Lake Controller. See the Lake Controller Operation Manual for further details.



NOTE: When connecting multiple devices to an Ethernet network, care must be taken NOT to create a closed loop which causes network malfunction.

**Mains connector** – Detachable Neutrik powerCON (for D 200/120/80) or locking IEC connector (D 40/20/10). For more information, please refer to Section 6.4.

## 11. Operation and performance

### 11.1. Operation precautions

Make sure that the Standby button on the unit's front panel is either unlit (OFF), or red (STANDBY), before making any input or output connections. Ensure the AC voltage is within the range printed on the label adjacent to the AC mains connector. Ensure no input signal is present when powering on the unit to reduce the risk of any inadvertent bursts of high level audio.

### 11.2. Power output performance

The standard form factor D Series units (D200, D120 and D80) uses Lab.gruppen's patented Class TD technology (Tracking Class D) in the output stages, which couples the efficiency of Class D topologies to the sonic purity of Class A/B designs. The slimline D Series units (D40, D20 and D10) uses a newly developed Class D technology design with increased efficiency and sustained sonic performance. All D Series models works perfectly under all load conditions and the output maintains its flat frequency response even into complex loads with very low nominal impedances. Reliability is very high, and there is no interference with nearby RF equipment. The superior efficiency of all D Series amplifiers allows for great power density with minimized cooling requirements.

## 11.2.1. Symmetrical power

D Series models can deliver power as shown in Table 11.1 when all channels are driven equally.

Load Impedance (ohms)	2 ohms (per channel)	2.67 ohms (per channel)	4 ohms (per channel)	8 ohms (per channel)	16 ohms (per channel)	Hi-Z 70 V (per channel)	Hi-Z 100 V (per channel)
D 200:4L	4400 W	5000 W	4400 W	2300 W	1150 W	3300 W	4700 W
D 120:4L	3000 W	3000 W	3000 W	1900 W	950 W	3000 W	3000 W
D 80:4L	2000 W	2000 W	2000 W	1500 W	750 W	2000 W	2000 W
D 40:4L	800 W	1000 W	1000 W	1000 W	700 W	1000 W	1000 W
D 20:4L	500 W	500 W	500 W	500 W	425 W	500 W	250 W
D 10:4L	250 W	250 W	250 W	250 W	250 W	250 W	175 W

**Table 11.1: Symmetrical Load Power Ratings**

## 11.2.2. Rational Power Management™

Rational Power Management™ (RPM) is a unique Lab.gruppen feature that allows for flexible allocation of power across channels of a D Series unit. Power that is not used by one output channel is free for use by another output channel with greater demands. Unique to this series is that all models in the range have amplifier channels that can produce higher outputs than the average 25% of the total power, see the Technical Specifications for the maximum single channel power capacity. RPM automatically allocates power up to the total limits of the specific amplifier model and helps minimize unused power in the installation.

Via the CAFÉ Software, desired power can be specified in several domains: burst and peak power; peak and RMS voltage; and also the speaker's AES power rating. By specifying the nominal impedance of the load, the RPM algorithms have all input data required to calculate resulting RPM settings. If the desired RPM settings results in a total power output higher than the capabilities of the amplifier, RPM will reduce the actual RPM configuration evenly based on a proportional reduction in dB. Once applied, the RPM functionality will ensure that all channels are capable of delivering the specified power, and limits efforts to take out more than the designed maximum power. The limitation, if needed, is performed with the ISVPL limiter algorithm. As default the RPM configuration allocates the power equally cross the channels at a voltage (default voltage limitation) given in the Technical Specifications. RPM can be configured in two modes.

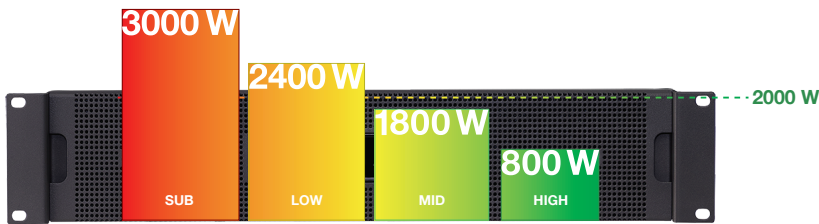

**Figure 11.2: Amp channels power adjusted to match the loudspeaker requirements on a D 80:4**

**Auto RPM:** The frame will automatically allocate power per output channel according to the ISVPL settings in the speaker preset (per module output) in Lake Controller. Auto RPM assumes a nominal impedance of the Load and applies an approximate power allocation. Auto RPM is default for D Series Lake.



**Custom RPM:** The CAFÉ software allows users to create an advanced custom power allocation scheme. Switching to Custom mode disables the Automatic mode. Additional information is available in documentation supplied with the CAFÉ software download.

**Custom RPM using CAFÉ with ESP:** CAFÉ (Configuring Amplifiers For the Environment) is a dedicated software application for Windows and OSX that provides tools for system planning, specification and commissioning. CAFÉ incorporates the Equipment Specification Predictor (ESP), a software module that examines SPL and speaker requirements for a project and generates requirements for output power on an amplifier and system level. ESP will generate a custom RPM configuration optimizing the power allocation within the frame. For more information on CAFÉ and ESP, please consult the documentation supplied with the CAFÉ software download.

### 11.3. Amplifier and Load Protection Systems

The D Series is equipped with a comprehensive set of protection circuits. If operating conditions become sufficiently extreme that any of these circuits become active, indication is provided by amber or red LEDs on the front panel, and by text notifications in the Lake Controller and CAFÉ software. Refer to Section 14.1 for more information on warnings and faults.

### 11.3.1. Inter-Sample Voltage Peak Limiter (ISVPL)

The ISVPL is a high quality voltage limiter that can deliver seamless limitation to any desired level. It ensures that the voltage at the output terminals never exceeds the defined threshold. It operates on these principles:

- The signal is delayed slightly to allow the ISVPL to look-ahead and reduce the gain before voltage in excess of the threshold can appear at the output. This results in zero voltage overshoot at the output with a rounded limitation up to the threshold.
- The amplitude of the output signal between digital samples is predicted which permits the ISVPL to respond to analog peaks that may occur at the digital to analog converter.
- The release time of gain reduction is adaptive depending on the dynamics of the signal. It is possible to select different ISVPL profiles for limiting optimization for a specific frequency band and personal preference. The profiles are divided into two categories, with one category optimized for low distortion and the other focusing on producing high sound pressure level (SPL). Within each category there are profiles optimized for the different frequency bands.

#### 11.3.1.1. Low Distortion Profiles

- Universal – The universal profile is a soft limiter that can be used for all frequencies and is conservative in its action upon VCL and CPL.
- Sub/LF – The Sub/LF profile is tuned for frequency bands below 600 Hz. It has longer attack and release times and is less conservative when it comes to acting upon VCL and CPL.

#### 11.3.1.2. High SPL Profiles

High SPL profiles do not use the adaptive release time feature. High SPL profiles optimized for high frequencies use less of the look-ahead delay peak-rounding feature; this feature is used most in the Sub profile and least the HF profile.

- Sub – The Sub profile is optimized for frequencies between 20 – 200 Hz
- LF – The LF profile is optimized for frequencies between 20 – 1200 Hz
- MF – The MF profile is optimized for frequencies between 300 – 6000 Hz
- HF – The HF profile is optimized for frequencies above 1 kHz

#### 11.3.1.3. ISVPL Voltage Settings

The ISVPL threshold may be set at any level between 17.8 V and 600 V in the Lake Controller software. For further details, please refer to the Lake Controller User Manual.

Lake-enabled amplifier devices (D Series Lake, PLM+, PLM) that have a smaller peak output voltage capability still allow ISVPL speaker threshold settings up to 600 V. When a threshold is set above the current maximum capability of a power output channel, the actual ISVPL will automatically be set to the maximum ISVPL for that channel. Therefore, the ISVPL threshold can be set at the Module for the speaker's maximum capability, and the Module file remains cross-compatible with all Lake-enabled amplifier devices.

Table 11.3 shows the theoretical maximum output power based on only the load impedance and the ISVPL setting. See the Technical Specifications, or use CAFÉ, to find the available power for a specific amplifier and load.



Max. Sinewave Burst Power (Watts)					
Load Impedance (ohms)	2	2.67	4	8	16
ISVPL SETTING (V peak)					
194	4489	5993	4705	2352	1176
193	4489	5993	4656	2328	1164
181	4489	5993	4095	2048	1024
167	4489	5223	3486	1743	872
153	4489	4384	2926	1463	732
121	3660	2742	1830	915	458
101	2550	1910	1275	638	319
83	1722	1290	861	431	215
70	1225	918	613	306	153
56	784	587	392	196	98
47	552	414	276	138	69
38	361	270	181	90	45
17.8	79	59	40	20	10

**Table 11.3: ISVPL-to-output examples**

### 11.3.2. Current Peak Limiter (CPL)

The output Current Peak Limiter (CPL) ensures that the power output section will not be damaged by forcing it to deliver current levels at the outputs that exceed the maximum current ratings of the output transistors. The CPL keeps the output transistors within their Safe Operating Area (SOA). The CPL is non-adjustable.

This condition indicates an attempt to draw excessive current at the output. The output is attenuated until the output current falls below the maximum current rating. Limiting is performed by the ISVPL limiter in conjunction with the selected ISVPL profile.

CPL activity is shown by amber or red indication on Amp LED of the affected output channel and a corresponding text description in Lake Controller and CAFÉ software programs. Refer to Section 14.1 for more information on warnings and faults.



**NOTE:** If excessive current is indicated, check the output cables and examine the loudspeaker. If impedance appears normal, you may rectify the condition by altering the ISVPL settings or lowering input levels. CPL indication can be triggered by excessively low load impedance, possibly the result of too many loudspeaker cabinets connected in parallel.

### 11.3.3. Power Average Limiter (PAL)

The Power Average Limiter Active warning (PAL Active) will be displayed when the power supply is operating at the maximum average input power allowed for the PSU design. When this warning is displayed, gain limiting is being applied to the signal by a lowering of the ISVPL threshold.

PAL activity is shown by PSU amber LED indication and a corresponding text description in Lake Controller and CAFÉ software programs. Refer to Section 14.1 for more information on warnings and faults.

### 11.3.4. Breaker Emulation Limiter (BEL™)

D Series amplifiers are powerful devices that can draw a considerable amount of current from the mains supply. The BEL models the temperature in the external breaker and limits the mains current to prevent the breaker from tripping. On all D Series models the BEL can be configured with both a breaker profile and a nominal current value (the D 20:4L and D 10:4L models can only apply the Universal profile, but supports the others to be selected for Frame Replace support). The desired nominal current value can be set from 1 to 32 Arms. The resulting actual current value is model limited; according to the Technical Specifications. When the nominal models current is set above, or below, the model's capabilities, the actual current is automatically adjusted into the specified range. Therefore, the nominal current can be set for the application and the configuration remains cross-compatible with all the models. The three different profiles available for selection are:

- Conservative – The conservative profile allows no momentary current above the configured threshold.
- Fast – The fast profile models the time constant of the trip–curve corresponding to a fast breaker. It momentarily allows current above the threshold to pass for a short time, leading to an increased modeled temperature. For the limiter to disengage, the current must reduce below the threshold to enable the breaker to cool down.
- Universal – The universal profile models the time constant of the trip–curve corresponding to a slow breaker. It momentarily allows current above the threshold for a longer time, leading to an increased modeled temperature. For the limiter to disengage, the current has to reduce below the configured current for the breaker to cool down.

The BEL is configured manually with the Lake Controller and CAFÉ software. CAFÉ's ESP design aid can also predict the current consumption, with the exact speaker requirements, and propose a safeguarding BEL configuration.

### 11.3.5. Under Voltage Limiter (UVL™)

The larger D Series devices (not D 20:4L and D 10:4L) are equipped with an under voltage limiter. With multiple, powerful devices on a mains distribution line, heavy current loads risk the reduction of voltage below that required for devices to function. The UVL reduces the mains current draw when voltage drops below 80 V. The amount of reduction applied increases as mains voltage drops towards 65 V; at 65 V the power supply is shut down. The mains supply is continually monitored and when sufficient voltage returns the power supply automatically restarts.

### 11.3.6. Current Average Limiter (CAL™)

The Current Average Limiter (CAL) monitors the RMS current drawn from each power output channel to ensure that the power output stages are not overloaded. When activated, it regulates the current to a safe level to protect the channel. The CAL should not be activated in normal usage. If activated, this is shown by amber or red indication on the Amp LED of the affected output channel and a corresponding text description in Lake Controller and CAFÉ software programs. Refer to Section 14.1 for more information on warnings and faults



NOTE: For Slimline models, to optimize the CAL's behavior when playing into a low impedance load, manually set the desired ISVPL to reflect the real peak voltage output to allow for a higher average current.

### 11.3.7. Voltage Clip Limiter (VCL)

If current draw from the unit's power supply is too high, the PSU's regulation capability may be exceeded and the internal voltage rails may drop and cause clipping. If this occurs, the VCL acts rapidly to prevent clipping on the subsequent peaks. Limiting is performed by the ISVPL limiter in conjunction with the selected ISVPL profile. Indication of this condition is shown on the output LEDs. Refer to Section 14.1 for more information on warnings and faults.

### 11.3.8. Temperature Protection

D Series devices are equipped with a sophisticated temperature sensing system that provides protection from overheating which may occur as a result of inadequate ventilation or excessive power output. Thermal measurements are made at several points within each power output channel along with measurements in the power supply and DSP areas. The temperature protection scheme is designed to let the amplifier to operate continuously, with the highest possible output, and prevent shutting down. If temperature in any area reaches a critical level, a warning is displayed. The warning is issued at approximately 80% of the maximum allowable temperature. If the temperature continues to increase, a limiter (ATL or PTL) is engaged that limits signal peaks to reduce further heat accumulation. Limiting is accomplished by gradual reduction of the ISVPL thresholds. In the extreme case where the limiter cannot reduce heat accumulation and temperature reaches a dangerous level, a fault is displayed and audio is muted.

Each power output channel, the power supply, and DSP area have separate indications. For all temperature faults, temperature monitoring will continue at 0.5 second intervals, with the output remaining muted. When the area has cooled below the dangerous threshold, the fault condition is cleared and audio is restored.

#### 11.3.8.1. Power Output Channels

A power output channel temperature warning or fault is indicated by the Amp LED for that channel and the Temp LED for the frame.

- A warning is indicated by a static amber LED
- Amplifier Temperature Limit (ATL) is indicated by an amber LED
- A fault is indicated with a static red LED

An event report is sent to the Lake Controller software for both the warning and the fault. If a temperature fault condition arises on a power channel, the output of that channel will be muted.

## 11. Operation and performance

If the amplifier output channel temperature keeps rising after reaching the temperature warning threshold, the Amp channel Temperature Limiter (ATL) will engage at approximately 95% of the maximum allowable temperature. When ATL is engaged, it will try to reduce the power output to avoid that the amp channel goes into temp fault, i.e. muting. Limiting is removed when temperature falls below the ATL threshold.

### 11.3.8.2. Power Supply / DSP

A power supply (PSU) or DSP temperature warning or fault is indicated by the Temp LED.

- A warning is indicated by static amber LEDs
- Power supply Temperature Limit (PTL) is indicated by an amber LED
- A fault is indicated with static red LEDs

If the power supply temperature keeps rising after reaching the temperature warning threshold, the Power supply Temperature Limiter (PTL) will engage at approximately 95% of the maximum allowable temperature. When PTL is engaged, it will try to reduce the total amplifier output power to avoid that the power supply goes into temp fault, i.e. muting of all channels. Limiting is removed when the temperature falls below the PTL threshold.

### 11.3.9. DC Protection

The DC protection is implemented, individually, on each power output to prevent damage to connected loudspeakers or any D Series components. DC present at the output will cause the unit's power output module breaker to blow, causing a permanent hardware fault that prevents signal throughput. In this instance the channel's Amp LED will illuminate red and a service channel fault will be registered in the Lake Controller and CAFÉ status views (D200, D120, D80 only). For the D40, D20 and D10, no audio will be heard from the outputs.



NOTE: A blown breaker in the power output module is not a user serviceable fault condition and the unit should be returned for repair.

### 11.3.10. VHF Protection

The D Series includes protection circuits that detect Very High Frequency (VHF) content in the input signal. The detection is amplitude-, frequency- and time-dependent. It is initiated from 10 kHz upwards and, if continuous VHF signals are detected above the threshold for more than the attack time, the output for a D200, D120 and D80 will attenuate the gain until the signal is below the VHF threshold. When this is done, VHF Warning is displayed. If the signal is above the VHF threshold and the maximum of -12 dB of gain reduction is not enough to take the signal below the VHF threshold, the signal will mute after 15 seconds, and retest the signal after 6 seconds. Note that the D40, D20 and D10 will go directly to mute upon VHF detection. When continuous VHF signal stops, the output unmutes and the amplifier returns to normal operation.

This protection system recognizes only continuous VHF signals at high levels that will not appear in speech or music. Any such content can therefore be considered as a fault condition. VHF protection is essential to avoid damage to HF drivers. VHF protection is dependent on a combination of output power level and frequency. Figure 11.4 shows a decreasing power threshold, from approximately 10 kHz upwards, which illustrates increasing sensitivity of the protection system with frequency. When continuous output power above the threshold line is detected, VHF protection becomes active.

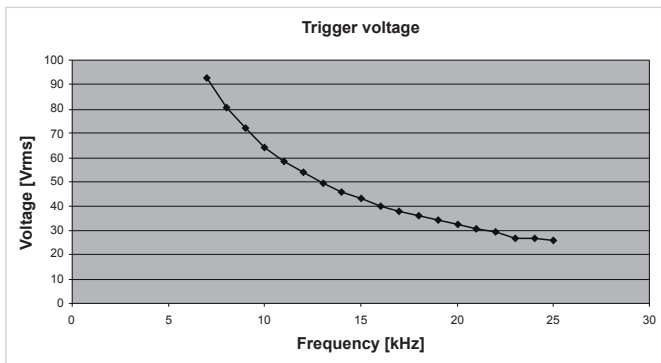

**Fig 11.4: VHF Protection Frequency Sensitivity**

The attack time of the VHF protection circuitry also changes with frequency, becoming shorter at higher frequencies. This is shown in Figure 11.5.

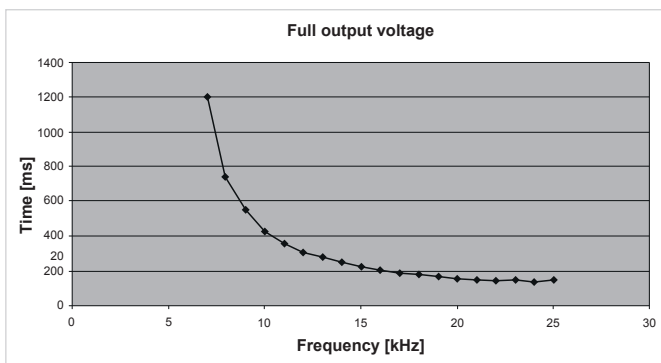

**Fig 11.5: VHF Protection Attack Time Variations**

The VHF protection circuit does not alter the amplifier's frequency response. It is implemented solely to detect continuous VHF content. HF content of normal music or speech signals at peak levels will be passed in full. Operation of the VHF protection circuits is indicated by the channel's AMP LED that will illuminate yellow and display VHF Warning when the max of -12 dB of gain reduction is applied (only applicable for D200, D120 and D80) and light red for a VHF FAULT. Both of these will be registered in the Lake Controller and CAFÉ status views.

### 11.3.11. Short Circuit Protection

A low impedance or short circuit at the power output terminals is detected when the output current is high (Current Peak Limiter is active) and, simultaneously, the peak output voltage is below a predetermined threshold. When this situation occurs, the output stage is muted to protect it from damage.

Operation of the short circuit protection system is indicated by Amp channel LED showing steady red and a corresponding text description will register in Lake Controller and CAFÉ software programs. Refer to Section 14.1 for more information on warnings and faults.

The presence of a short circuit (or low impedance) is re-tested every six seconds, and the output remains muted until the fault clears.

### 11.3.12. Power supply protection

The power supply is very advanced and has several internal control and monitoring functions. Should any of these fail, the power supply will shut down to prevent damage or limit severity of the failure. If the power supply shuts down audio will be muted. Power supply faults, or power supply needs service faults, are indicated by a red LED and associated error messages registered in Lake Controller and CAFÉ software programs.

In the extreme event of simultaneous low mains voltage supply and high power demand, the amount of incoming energy may not be sufficient for continued operation. The power supply will then be forced to shut down. This condition is a power protect fault, indicated with a red LED and associated error messages registered in Lake Controller and CAFÉ software programs.

#### 11.3.12.1. Mains anomaly protection

D Series amplifiers incorporate several features to ensure continuous operation in case of irregularities in the AC mains service.

**Over-voltage** – If the power supply detects mains voltage above 400 V peak or 270 V RMS, it will enter protective shut down mode. The amplifier will auto-restart if the condition clears. Will be indicated by a red LED and associated error messages will register in Lake Controller and CAFÉ software programs.

**Under-voltage** – If the power supply detects mains voltage of less than 65 V, it will enter protective shut down mode. The amplifier will auto-restart if the condition clears. Will be indicated by a red LED and associated error messages will register in Lake Controller and CAFÉ software programs.

**Mains instability** – If the power supply detects protracted instability in the AC mains, it will enter protective shut down mode (D 200:4L, D 120:4L and D 80:4L only). The amplifier will auto-restart if the condition clears. Will be indicated by a red LED and associated error messages will register in Lake Controller and CAFÉ software programs.

**Mains glitch** – If the power supply detects a momentary mains glitch (missing cycles) at the AC inlet, a warning indication will be reported with a yellow LED and associated error messages will register in Lake Controller and CAFÉ software programs (D 200:4L, D 120:4L and D 80:4L only). The power supply and product continue operation throughout a mains glitch.

## 11.4. Power Supply

The R.SMPS (Regulated Switch Mode Power Supply) is designed to keep supply voltage rails at optimum levels. Thus the R.SMPS can deliver full rail voltage to the output stage at all times, allowing the amplifier to exhibit consistent transient response and a clean LF response.



D Series features a universal power supply with power factor correction (PFC). The device can accept any mains voltage, from 65 V to 265 V, allowing it to function worldwide in many different configurations. The PFC reduces current peaks on the lines and reduces the requirements placed on the mains distribution system. D Series units offer an unparalleled power factor extremely close to one.

#### 11.4.1. Low Inrush Current

High power amplifiers with inadequate inrush current limiting can draw considerable current from the mains at turn-on, sometimes tripping a fast-acting mains breaker. The D Series, however, has very low inrush current to prevent tripping of breakers. Several units can, under normal conditions, be powered up simultaneously. If you do experience problems powering up multiple units simultaneously, they must either be turned on manually in an ordered manner, or sequenced remotely using the Lake Controller software's Global Control feature. Alternatively, the capacity of the mains supply should be increased.



**NOTE:** If insufficient power is available to allow simultaneous power-up, then there is probably insufficient capacity for full power output during operation. It is recommended that additional capacity is added to the mains power distribution system.

#### 11.4.2. Adaptive rail control

The D Series slimline models have Adaptive rail control available in Performance (default) and Green mode. In Green mode, this feature further increase the slimline models green credentials by lowering the idle consumption. This is achieved by lowering power supply's supply voltage, to the amplifier modules, when no signal has been present for a predefined time. The supply voltage is automatically raised, to allow for full power outtake, as soon as the signal returns. This feature is user controlled via the Lake Controller, where it can be turned on or off.

### 11.5. Auto power down

The D Series models have been equipped with a Auto Power Down function. If Auto Power Down is enabled, the D Series amplifier will automatically go into standby mode (after the defined user-defined number of minutes) if there is no audio passing and there is no user interaction via the Lake Controller, CAFÉ or 3rd party controllers. When the amplifier enters standby mode, it remembers that the expected power state is ON and thereby after a power cycle the frame will turn on again.



**NOTE:** There is no Auto Power On feature on the return of signal, the device will need to be actively turned on after entering the standby mode via the Auto Power Down feature. This can be done from the network via the Lake Controller or the 3rd party protocol or via the front panel button.

### 11.6. LoadPilot Load Monitoring

#### 11.6.1. Introduction

LoadPilot is a feature in D Series amplifiers that can continually monitor the integrity of loudspeakers and cables connected to the outputs to ensure that they are functioning properly and free from major anomalies or faults. By implementing LoadPilot, systems incorporating D Series amplifiers can be certified in compliance with voice evacuation standards such as EN54-16 and NFPA72.

LoadPilot functions by automatically superimposing low-level pilot tones on the input signal (if any present) to the amplifier. One tone is below the range of human hearing (approximately 10–20 Hz) and the other above (24 kHz), so the activity of LoadPilot is inaudible regardless of whether the system is currently reproducing program content. High-resolution current sensing on the outputs can calculate the impedance of the load at the frequency of the tones. Hence a stable measurement of the impedance of the load can be obtained and potential anomalies or faults can be detected that would indicate impaired loudspeaker function or total inoperability due to failure of the loudspeaker or faults in connected wiring. The superimposition of pilot tones and analysis is interleaved across the amplifier's output channels with a maximum total cycle time of around 20 seconds.

LoadPilot is implemented and configured in the CAFÉ software. Monitoring status and fault indication are displayed on the front panel and both in CAFÉ and Lake Controller.

LoadPilot may be configured with the automatic calibration or through a manual advanced mode, depending on monitoring requirements and characteristics of the connected loudspeaker loads.

#### 11.6.2. Automatic calibration

##### 11.6.2.1. Functional description

Automatic calibration is suitable for the following applications and requirements for error detection:

- If one or two low-impedance loudspeakers are connected; if two in parallel is default, it will warn if one is missing.
- If there are one or two “spurs” with 70V loudspeakers connected; if two in parallel is default, it will warn if one is missing.
- If there is a short circuit in the load.
- If there is an open circuit (all loudspeakers missing).
- For passive 2- and 3-way loudspeakers, if one or two LF drivers are connected and working; if two in parallel is default, it will warn if one is missing.
- For some passive 2-way designs, if one HF driver is disconnected. (However, with some loudspeakers the HF impedance is dominated by a passive component i.e. crossover filter and the anomaly will not be detected.)



NOTE: LoadPilot is enabled only when the amplifier is On. It does not function while the amplifier is in Standby.

### 11.6.3. Manual configuration

#### 11.6.3.1. Functional description

Manual configuration can be used in special cases where proper functioning requires setting of custom measurement frequencies, custom measurement levels, custom warning thresholds, or combinations of the three. Manual configuration addresses the following issues:

**Speakers with non stable impedance** – For the LoadPilot feature to function the load itself needs to have a stable impedance at the frequency of the tone. Resonances in the speaker or other non linear phenomena can make the impedance at a certain frequency unstable. Stability needs to be verified by examining the impedance response to make sure it is relatively flat at the tone frequencies and by verifying LoadPilot readings when playing signal through the speaker at the most extreme expected level. The frequency of the pilot tones can be changed within certain ranges and a tone can be disabled. If a frequency where the speaker is stable can not be found one tone can be disabled and LoadPilot relies solely on the remaining tone.

**High noise levels** – To obtain accurate impedance measurements, it is necessary to drive a current sufficiently above the noise floor. However, it is important to keep the level low in order to prevent audible artifacts from cone travel. At very high impedances, the drive current may be insufficient. In the automatic mode, level is set around 60 mV which produces usable results for impedance up to 660 ohms.

**Inductance in loudspeaker cables** – Loudspeaker cable inductance at higher frequencies is very high relative to passive resistance, and the inductance increases linearly with length. Consequently, monitoring at the 24 kHz pilot tone frequency can be problematic with very long cables. The automatic mode will estimate cable impedance for 24 kHz and allow it to be used as long as it is less than 33% of total impedance presented by the load and as long as the total impedance is below about 440 ohms.

**DC blocking capacitors in loudspeakers** – Some loudspeakers incorporate a capacitor designed to block damaging voltages at very low frequencies. This may inhibit accurate measurements when using the 10 Hz pilot tone. In automatic mode, LoadPilot will disable the 10 Hz tone if total impedance is above about 440 ohms.

**Constant voltage loudspeakers** – Loudspeakers driven via transformers in 70V/100V solutions are more likely to exhibit wide variations in measured impedance as music and/or pilot tones are reproduced by the system. Also, most constant voltage systems operate more than two loudspeakers in parallel. Therefore, in addition to manual configuration of LoadPilot, additional step may be required. These include:

- Insertion of a series capacitor in each loudspeaker to block the 10 Hz LF tone – This will defeat measuring the loudspeakers with the LF tone, but will allow the LF tone to propagate through the entire cable run.
- Insertion of EOL (end-of-line) resistors – This enables LoadPilot to detect cable faults in a spur of the system.
- Insertion of EOL (end-of-line) inductor – This is not mandatory, but it will avoid the loss of level at mid and high frequencies due to the EOL resistor.



NOTE: Manual configuration of LoadPilot is implemented in CAFÉ versions 1.1.0. and later. For detailed information on manual configuration of LoadPilot, please refer to the integrated guide in the software program and to the CAFÉ Coach videos posted on the Lab.gruppen web site and on the Lab.gruppen channel on YouTube.

### 11.6.4. Indication

The LoadPilot feature constantly monitors the impedances at the two given pilot tone frequencies and compares to the measured thresholds. The following faults and warnings can be triggered.

- Speaker shorted warning – Both tones below lower threshold. Corresponds to a distant short circuit that can either be in the cabling or in the speaker.
- Speaker damaged warning – One of the tones is below or above thresholds. Corresponds to an unexpected impedance deviation of one of the tones, most likely a damage to the speaker.
- Under speaker count warning – Both tones above upper threshold. Corresponds to an impedance increase across the impedance response and most likely a loss of speaker(s) in a parallel speaker connection.
- No load fault – At least one tone above measurable area or significantly above upper threshold. Most likely corresponding to loss of the load.
- Short circuit fault – LoadPilot analysis below short circuit threshold.

## 11.7. Audio over Ethernet

D Series Lake devices include Dante and AES67 digital audio networking as standard. Utilizing the latest advances in Ethernet technology, Dante offers simplified system configuration and extremely low latency while delivering very high quality uncompressed digital audio across the Lake network. The Zen™ automatic configuration feature enables plug-and-play setup without third-party DHCP or DNS servers. Dante is compatible with high-bandwidth networks, allowing large numbers of audio channels to be distributed alongside control and analyzer data.

AES67 is a new open standard making it possible connect more devices together and share audio.

The D Series Lake also have a feature to convert between AES67 and Dante, and can accordingly work as a bridge between the two different network protocols. It can input 8 channels of AES67 and transmit them out again as 8 Dante channels or vice versa and in any combination of Dante and AES67 channels.

The D Series Lake support 8 x 8 Inputs and Outputs on Dante/AES67. The networked audio channels' inputs are routed to the Dante receivers and are shared between both Dante and AES67. The total number of networked audio inputs available is 8 (Dante + AES67).

On the output side, the device has 8 channels in total – and it is possible to configure the channel as Dante only (Unicast or Multicast) or have it as an AES67 flow as well. Up to 8 channels can be included in an AES67 transmit flow.

In order for the device to be able to input networked audio, “Dante” must be enabled in Lake Controller. See Lake Controller Operation Manual for further details.

### 11.7.1. Dante

D Series devices support dual redundant inputs and outputs on Dante, in either 48 or 96 kHz, with receive latency as low as 0.25 ms and up to 5 ms.

Dante devices and channels can be given “friendly” names, meaning audio can be routed without having to use or remember complex numbers.

Dante channels can be routed in both Dante Controller or in Lake Controller.

### 11.7.2. AES67

When the device is in AES67 enable mode, the device is in 48 kHz only (also for Dante subscriptions/transmissions). The receiver latency for AES67 subscriptions is 2 ms. Transmission flows are Multicast only.

AES67 subscriptions can only be configured in Dante Controller. The AES67 transmitter must support the SAP (Session Announcement Protocol). This is one of four device discovery methods referenced in the AES67 standard. Check if the transmitting non-Dante AES67 device supports SAP. Otherwise Dante Controller cannot discover the audio flows coming from the device. Dante devices support SAP if their AES67 mode is enabled.

Multicast IP addresses must be in the range of 239.69.0.0 - 239.69.255.255. If dual redundancy is enabled on the device, the AES67 flow only works on the primary network. It is still possible to utilize Dante on primary and secondary networks at the same time, as an AES67 flow is present on the primary.

## 12. Lake Processing and Lake Controller

### 12.1. Introduction

D Series Lake integrates seamlessly into the Lake Processing environment, providing all features, functionality and connectivity associated with all Lake Processors. The internal Lake Processing, which includes programmable crossovers, EQ, dynamics and other functions, is fully controllable via Lake Controller software with a version number of v6.3 for D 200:4L, D 120:4L and D 80:4L, v6.5.0 for D 20:4L and D 10:4L and v6.5.1 for D 40:4L. All models are compatible with newer versions of the Lake Controller.

Additional information is available in the Lake Controller Operation Manual and Lake Network Configuration Guide, both available on [www.labgruppen.com](http://www.labgruppen.com). Also, additional documentation is available from the Start Menu after software installation.

Visit <http://labgruppen.com> to download the latest software, firmware and documentation for your devices.

### 12.2. Modules and Frames

A Frame represents one physical Lake Processor device (e.g. a D 200:4L). A maximum of four Modules are contained within each Frame; these are referred to as Module A, B, C and D. The number of Modules shown in a given Frame is dependent upon the signal processing configuration of that Frame.

Each Module can be configured as a Classic Crossover (Bessel, Butterworth, Linkwitz–Riley), as a Linear Phase Crossover, or as multiple full bandwidth Auxiliary Outputs. The default configuration for D Series Lake is 4 x Contour Classic 1 Way (CL1–Way) Output Modules, providing a total of four Module outputs that can be routed to any of the four power outputs, but default is one to one (input 1 -> output 1 etc.). Please refer to the Lake Controller Operation Manual for further information.

### 12.3. Lake LoadLibrary™ and Fingerprints

In addition to the standard loudspeaker presets (Module files), the Lake Controller also includes a set of enhanced Module files specifically for use with Lake models. These supplementary Module files, known as SpeakerPresets are available in the Lake LoadLibrary, incorporate both Lake DSP parameters along with amplifier specific data. LoadLibrary Module files include parameter settings for the Amplifier Gain and ISVPL limiter.

Additionally, Lake LoadLibrary loudspeaker types may also include data relating to the electrical characteristics of a particular loudspeaker. Electrical characteristic data is used to enable load verification (LoadSmart) to be performed on the device. This data set is termed a Fingerprint. When a specific loudspeaker type is loaded, its Fingerprint load characteristics are included. These load characteristics are stored in a file with a “.mdl” suffix and are loaded simultaneously with the module file.

### 12.4. Loudspeaker Processor Overview

The Lake Processing system within D Series Lake devices may be configured with up to four processing Modules containing a total of up to twelve processing Module outputs that can be routed to any of the four power output channels. Each set of processing elements is referred to as a Module and can be configured as crossovers, full bandwidth auxiliary outputs, or a combination of the two. The relationship between inputs and outputs is defined via the Lake Controller.

The Lake Processing system provides two distinct categories of crossovers:

- Infinite Impulse Response filters (IIR) such as the classic Bessel, Butterworth or Linkwitz–Riley types; these are available with slopes ranging from 6 dB/octave to 48 dB/octave.
- Finite Impulse Response filters (FIR) providing zero phase shift with steep transition slopes at the crossover frequencies. These are also referred to as Linear Phase Crossovers.

### 12.5. Module, System and Sub–System Configuration Files

Module, System and Sub–System Configuration files are stored on the Lake Controller PC, and data is passed across the network when recalling or storing these types of files. See Figure 8.1 where Module data is highlighted in Red and Frame data in Blue.

- A Module file is the smallest set of data that can be stored and recalled; it contains crossover, gain, delay, and limiter information for an individual loudspeaker. A Module file may be recalled into other Lake devices. It is not possible to store a Module File directly on the hardware device.
- A System or Sub–System Configuration File contains a set of Module file information in addition to Frame related information such Group data and I/O configuration.

### 12.6. Frame and System Presets

The entire processor configuration can be stored as a Frame Preset on this hardware device. Presets can be recalled) via the Lake Controller software or Preset Manager utility; presets can be stored using the Lake Controller software or Preset Manager utility. A maximum of 100 Frame Presets can be stored on this device. The data within a Frame Preset encompasses the configurations of all Modules in the Frame, including levels, crossover, EQ, input mixer, routing, and all other parameters. As Frame Presets are stored in the hardware device, recall is available without using a PC.

Using the System Presets function in the Lake Controller, entire system configurations can be stored and recalled across a network of Lake devices, including D Series Lake, LM, PLM and PLM+ Series devices. This enables fast retrieval and switching of entire system configurations as minimal data is being sent between the Controller and Processors.

## 13. System configuration tutorial

This section will describe how to get started with associated software and set up a basic system for operation.

### 13.1. Network setup

#### 13.1.1. Network connections/topology

Each frame has two network ports; a primary and a secondary. See the below diagram for a typical network topology using the primary ports.

By default, the secondary ports are configured in dual redundancy mode to support a second redundant network. The alternate configuration for the two ports is a switch mode which allows daisy-chaining devices in a single network. Daisy chain mode is not recommended for more than a few devices, and for not more than two if running Dante audio along with control data.

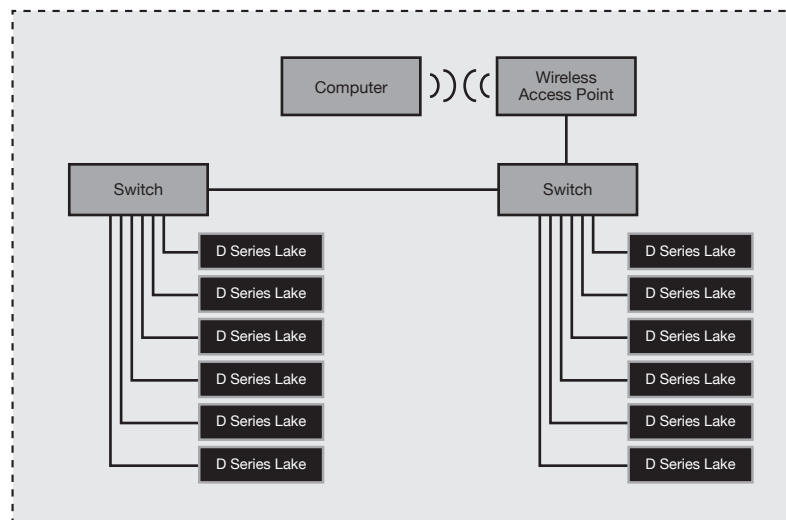

NOTE: If using Dante audio in the network, the audio traffic needs to be filtered from reaching the wireless links.

#### 13.1.2. Network configuration

Frames are configured by default to obtain IP addresses automatically. The frame will assign itself an IP address in the link local range (169.254.1.0 through 169.254.254.255). If a computer is configured the same way

(which should be default on modern operating systems), it will reside in the same subnet as the devices and communication can be established. Alternate configurations would be DHCP for a managed network or fixed IP. To connect to the secondary network in dual redundancy mode the computer shall be configured with an IP address in the 172.31.0.0 – 172.31.255.255.

### 13.2. Software installation and firmware update

#### 13.2.1. Lake Controller software suite

1. The Lake controller software suite includes the Lake controller and accompanying utilities: Lake LoadLibrary, Dante discovery services and documentation. Download the Lake Controller installation from [www.labgruppen.com](http://www.labgruppen.com).
2. Execute the installer and follow the on–screen instructions. This is a typical software installation where the default settings are acceptable for the vast majority of users.

#### 13.2.2. CAFÉ software

1. The CAFÉ software is available as a separate installer on [www.labgruppen.com](http://www.labgruppen.com).
2. Execute the installer and follow the on–screen instructions. This is a typical software installation where the default settings are acceptable for the vast majority of users.

#### 13.2.3. Firmware update

The latest firmware for the product is included in the Lake controller installation. It is likely that firmware installed on the new product is older and requires updating. The firmware bundle includes all internal components (so no separate update for Dante etc. are needed).

1. Make sure all frames are powered on and connected through a wired network.
2. Launch the Lake firmware update utility LakeUpdate.exe.
3. Select the appropriate product range.
4. If more than one network adapter is enabled, a prompt will appear requiring selection of the adapter connected to the frames.
5. If prompted, allow the application access through the Firewall.
6. Latest firmware is preselected.
7. Discovered frames are listed. Tap Select Old and Update to initiate firmware update of all outdated frames. Frames already up to date will not be selected.
8. Read warning message and tap OK.
9. Wait for all updates to be completed. A wait indication will display on the unit(s) during updating.
10. Follow the on screen instructions. Amplifiers with firmware associated with Lake Controller 6.5.0 or later will automatically power cycle the mains power, whereas amplifiers with older firmware will display a message that a manual power cycle is required. (Note: A manual power cycle requires the mains plug to be completely removed, the standby button does not complete the firmware update.)
11. If internal updates are needed, these will be performed by the frame after the power cycle. A wait indication is displayed.
12. Tap Exit to close the update utility.



### 13.3. System setup

This tutorial provides a step-by-step guide for configuration of a typical professional loudspeaker system and provides an overview of the basic features and operation of the frame. This tutorial describes how to configure 4-channel frame for use with a generic 3-way loudspeaker system (with separate HF, MF and LF drivers), plus a separate subwoofer. It assumes that the system is fed with analog outputs from a mixing console with one fullrange main output and a separate sub feed.

1. Connect the loudspeakers to the four power output channels:
  - a. Channel 1 – Low Frequency Driver
  - b. Channel 2 – Mid Range Driver
  - c. Channel 3 – High Frequency Driver
  - d. Channel 4 – Subwoofer
2. Connect the main output of the mixing console to analog input 1 of the frame and the sub feed to input 2. While configuring, it is a good practice to make sure the volume is turned down on the console.
3. Ensure the frame is powered on and is in its default state, and that the computer has established an active Ethernet connection.
4. On the Tablet PC, launch the Lake Controller software application. Select the appropriate network adapter if more than one is enabled, and tap NO to the dialog asking whether to load the previous configuration.
5. Tap MODULES button on the menu bar at the bottom of the screen to access the Module Menu and scroll bar.
6. On the Module scroll bar, the frame is represented with a frame containing four discs. These are labeled A, B, C and D, each representing one of the four Lake processing modules.
7. Tap the frame to select it, then tap again in the MAIN area of the screen to place all modules of the frame in the current system configuration. The Lake Controller uploads settings from the frame.



8. Tap the icon for Module A; its border will turn yellow to confirm selection and an LED on the front panel of the associated device will illuminate.
9. Tap the Module Store/Recall button on the Modules Menu; the menu will change to show additional options.
10. Double-tap the Default Modules folder, then double-tap the Contour Classic Crossovers folder. A set of loudspeaker symbols will be displayed.
11. Tap CL3way, and then tap the RECALL button. This configures the DSP for the Module A as a 3-way crossover for the 3 way speaker.
12. Tap Yes when asked to confirm that all data will be overwritten.
13. An Output configuration dialog will pop up to allow for routing of module outputs to power channels. Tap the orange number buttons in the matrix to un-route, freeing up a power channel. Tap a blue number button at the intersection of the appropriate module output and power channel, routing the module output to the power channel. Proceed until you have routing according to the picture below and tap the bottom right return button to exit the dialog.

## 13. System configuration tutorial

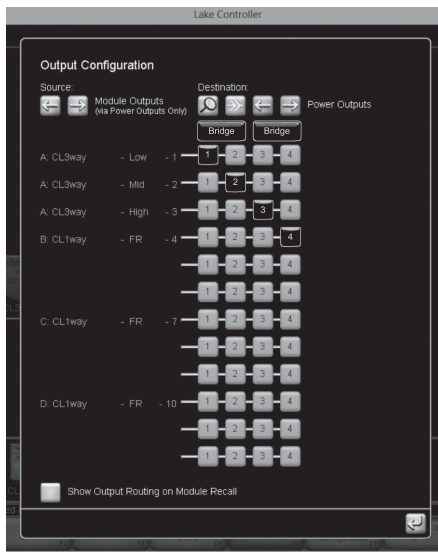

14. The B module is already a CL1way as default and can be used to drive the sub.
15. Tap Store/Recall EXIT to return to the Modules Menu.
16. Ensuring Module A (or any other module that you want to control) is selected (yellow border), tap I/O Config.



17. The right side of the I/O CONFIG screen displays a block diagram for the Modules. Tapping the different blue blocks will access the configuration screens for Input mixer, Levels, Input EQ, Delay and Output EQ/Crossover respectively. The magnifying glass at the far right end accesses the output configuration. (NOTE: Tapping the blue return button (left arrow), or the EQ/Levels EXIT button in the menu bar returns to the I/O Config screen from the various configuration screens.)

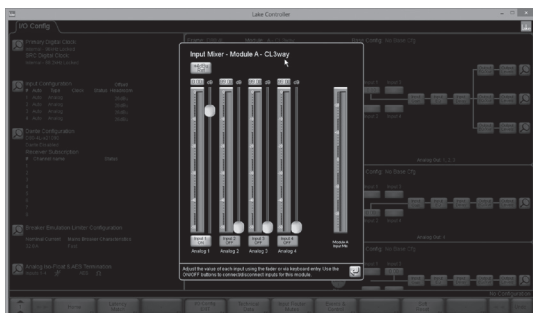

**Input Mixer Configuration** – Drag sliders and tap ON/OFF buttons to control input mixer settings.

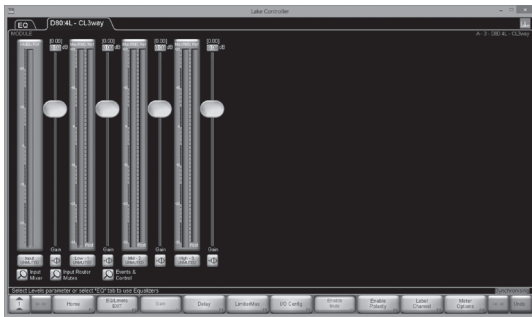

**Levels Control** – Drag sliders and tap mute buttons for module input and output channels.

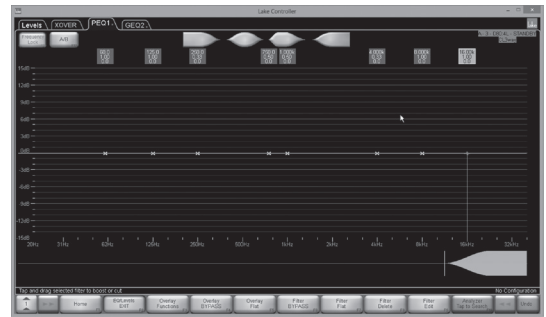

**Parametric EQ control** – Select filter on the top squares and adjust filter properties by dragging the controls. Sliders at the bottom control center frequency and Q (bandwidth). Gain is controlled in the main window area. Additional filters can be added by tapping the top filter objects and placing new filters on the main area.

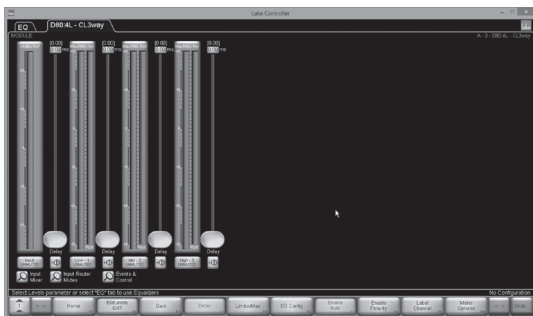

**Delay Control** – Drag sliders to control input and output delay

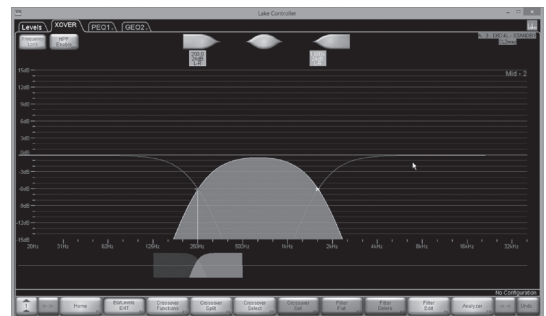

**Crossover control** – Select filters and drag on the bottom frequency bar to adjust crossover frequency. Crossover types may be changed by selecting the Crossover Functions button.

18. Tap the Input Gain button in the block diagram and unmute the Module Input Mute. Tap EQ/Levels Exit to return to IO Config.
19. The left side of the IO config screen holds frame configuration and summary for Clock configuration, Input configuration, Dante configuration, Breaker Emulation Limiter configuration and Analog Iso-Float & AES Termination configuration. All these configurations should be correct by default for this example.
20. From I/O config, tap Amplifier Events & Control and navigate to the Status tab. Unmute the power channels and slowly increase the volume on the appropriate feed from the mixing console. Audio should now be active at the outputs and heard through the loudspeakers. Close the Amplifier Events & Control dialog with the return button and return to the main area by tapping the I/O Config EXIT button.

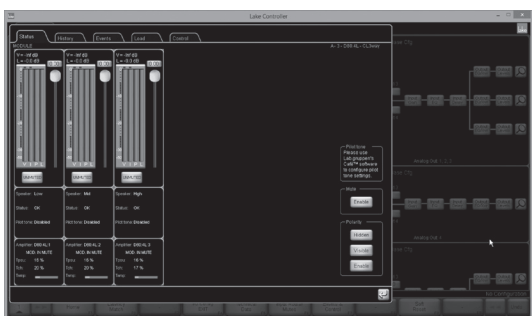

**Amplifier Events & Control, Status tab** – Drag sliders to adjust power channel attenuation and tap mute buttons to control power channel mute. Metering and Status monitoring is available for each power channel.

## 13. System configuration tutorial

- Repeat step 16 and 20 for the B module. On the Output EQ/Crossover, tap the Aux Output Functions button on the menu bar and then tap LPF Enable button. Drag the Low pass filter control object on the frequency slider just above the menu bar to an appropriate crossover frequency for the sub, e.g. 100 Hz.

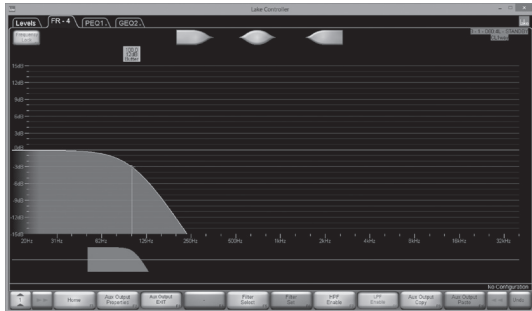

- Use the control options mentioned in 17 to tune your loudspeakers. For larger systems, modules can be placed in groups (Groups menu from the MAIN page) for control of multiple units.
- Some features like RPM can only be configured from within CAFÉ software. Return to AMPLIFIER EVENTS & CONTROL; from the main area hit MODULES button, select a module (e.g. Module A), tap I/O Config, tap AMPLIFIER EVENTS & CONTROL, and navigate to the Control tab. The CAFÉ button (next to bottom) opens the CAFÉ application and imports and highlights the current amplifier and its RPM view.

ID	Expected load	Input method	Desired power	Desired output	Headroom	Resulting RPM	RPM vs Desired	Usage	Desired average	Post
5	4.0 Ω	Burst power	4400 W	187.6 V 47 A 4400 W	0.3 dB	186.1 V 47 A 4328 W	-0.1 dB	LF (15 dB)	274 W	
6	4.0 Ω	Burst power	4400 W	187.6 V 47 A 4400 W	0.3 dB	186.1 V 47 A 4328 W	-0.1 dB	LF (15 dB)	274 W	
7	4.0 Ω	Burst power	2200 W	132.7 V 33 A 2200 W	3.3 dB	131.6 V 33 A 2164 W	-0.1 dB	MF or MF+HF (16 dB)	109 W	
8	4.0 Ω	Burst power	1200 W	98.0 V 24 A 1200 W	5.9 dB	97.2 V 24 A 1180 W	-0.1 dB	HF (16 dB)	37 W	
Mains voltage			230 VAC	12200 W	-0.1 dB	12000 W			694 W	
Maximum "2 minute" thermal dissipation: 2311 BTU/h										
Maximum "2 minute average" mains current: 6 A <sub>max</sub>										

**CAFÉ, RPM view** – Enter power requirements and impedances for the channels to configure RPM.

### 13.4. Additional Software Reference Material

Additional information regarding configuration of Lake Controller for specific loudspeaker systems is available in the Lake Controller Operation Manual, available for download in PDF format at [www.labgruppen.com/support](http://www.labgruppen.com/support).

Additional information on configuration of CAFÉ software is available in an integrated guide in the software program and in the CAFÉ Coach videos posted on the Lab.gruppen web site and on the Lab.gruppen channel on YouTube.

# 14. Appendix

## 14.1. Faults and warnings

Category/Type	Name	On screen text	Description	Action
<b>FRAME</b>				
<b>Warning</b>	Lake Controller offline	CTRL OFFLINE	Frame unable to find Lake controller on the network	Check network cabling/ network if controller expected on the network
<b>Warning</b>	AES / Dante clock slipping	CLOCK SLIPPING	Frame not able to lock to incoming AES stream or Dante clock slipping.	Check AES sender and clock configuration or Dante clock settings
<b>Warning</b>	Dante device name conflict	NAME CONFLICT	Two or more devices on the network with the same Dante name	Review Dante configuration
<b>Warning</b>	Dante module not detected	DANTE NEEDS SERVICE	Lake cannot detect a functioning Dante module	Restart device; if not cleared it needs service to operate Dante
<b>Warning</b>	Dante module with incompatible firmware	DANTE FW INVALID	Dante module not loaded with correct FW	Retry updating the firmware with LakeUpdate
<b>Warning</b>	Dante module disabled	DANTE DISABLED	Dante module not communicated correctly or other internal configuration fault	Restart device; if not cleared it needs service
<b>Warning</b>	Sense fault DSP	SENS FLT:DSP	Voltage and current sensing on amplifier output faulty. Audio continues but protection might be compromised. No load monitoring	Restart device; if not cleared it needs service
<b>Warning</b>	A/D converter power supply fault	A/D PSU FAULT	Voltage supply to the analog input converters faulty	Restart device; if not cleared it needs service for analog input to work
<b>Fault</b>	Audio Fault	AUDIO FAULT	Internal audio interface not functioning	Restart device; if not cleared it needs service
<b>Fault</b>	DICO communication fault	DICO COMM FAULT	Communication fault between host and amplifier platform	Restart device; if not cleared it needs service
<b>TEMP</b>				
<b>Warning</b>	Temperature warning power supply	TEMP WARN:PSU	Power supply temperature approaching critical levels	Improve cooling or reduce output power to avoid temperature becoming critical
<b>Warning</b>	Temperature warning DSP area	TEMP WARN:DSP	DSP area temperature approaching critical levels	Improve cooling or reduce output power to avoid temperature becoming critical
<b>Warning</b>	Power supply Temperature Limit	PTL ACTIVE	Amplifier is reducing output power to avoid power supply temp fault protection	Improve cooling or reduce output power to avoid limiting
<b>Warning</b>	Amp channel Temperature Limit	ATL ACTIVE	Amplifier channel is reducing output power to avoid amplifier channel temp fault protection	Improve cooling or reduce output power to avoid limiting

Category/Type	Name	On screen text	Description	Action
<b>Warning</b>	Under speaker count	UNDER SPKR CNT	Both LoadPilot tones above thresholds or LoadSmart detected fewer speakers than expected	Check load, cabling and calibration
<b>Warning</b>	More speakers	OVR SPKR COUNT	LoadSmart detected more speakers than expected	Check load and cabling or fingerprint
<b>Warning</b>	Uncertain about load	UNCERTAIN LOAD	LoadSmart uncertain about load	Check load and cabling or fingerprint
<b>Fault</b>	No load	NO LOAD	At least one LoadPilot tone above measurable area or significantly above thresholds	Check load or calibration
<b>Fault</b>	Wrong load	WRONG LOAD	LoadSmart detected impedance response output model	Check load and cabling or fingerprint
<b>Fault</b>	Short circuit	SHORT CIRCUIT	LoadPilot or full frequency analysis below short threshold or hardware short protection	Check load and cabling
<b>AMP</b>				
<b>Warning</b>	Temp warning amplifier channel	TEMP WARN	Amplifier channel is approaching critical temperature	Improve cooling or reduce output power to avoid temperature becoming critical
<b>Warning</b> (D200, D120, D80 only)	Very high frequency warning	VHF WARNING	Amplifier channel gain reduction due to VHF content	Check input signal
<b>Fault</b>	Temp Fault amplifier channel	TEMP FAULT	Amplifier channel has reached internal protection limit	Automatically unmutes when cooled down
<b>Fault</b>	Service channel	SERVICE CH.	Amplifier channel is damaged	Restart device; if not cleared it needs service
<b>Fault</b>	Very high frequency fault	VHF FAULT	Amplifier channel protection	Check input signal
<b>Fault</b>	Current average limiter	CAL ACTIVE	Average current on amplifier above safe operating level	Reduce output power to avoid limiting
<b>Clip</b>	Current clip	CURRENT CLIP	Amplifier channel reached current limit	Reduce output power to avoid limiting
<b>Clip</b>	Voltage clip	VOLTAGE CLIP	Amplifier reached voltage limit	Reduce output power to avoid limiting
<b>Clip</b>	Module clip	MOD. CLIP	Module output signal clipped	Review gain structure. Module gain vs AmpGain
<b>SIGNAL</b>				
<b>Fault</b>	No input source	NO INPUT	Input router has no valid input source	Review input router settings/connections
<b>Clip</b>	Analog/AES input clip	INPUT CLIP	The signal on the analog/AES input is above inputs capability	Lower the signal on the feed to the amplifier

## 14.2. Current draw and thermal dissipation

D SERIES 10:4								
Level	Load	Rated power per channel	Line Current	Measured Power (W)			Thermal Dissipation	
				(A)	In	Out	Dissipated	BTU/hr
<b>Mains Voltage 100 VAC</b>								
<b>Standby</b>			0.1	7	0	7	24	6
<b>Power On, Idling, Green Mode</b>			0.5	45	0	45	153	38
<b>Power On, Idling, Performance Mode</b>			0.7	71	0	71	241	61
<b>Pink Pseudo Noise</b>	16 Ω / Ch.	250 x 4	2.3	229	125	104	355	89
	8 Ω / Ch.	250 x 4	2.4	240	125	115	391	98
	4 Ω / Ch.	250 x 4	2.6	254	125	129	439	111
	2 Ω / Ch.	250 x 4	2.8	279	125	154	527	133
	100 V / Ch.	175 x 4	1.8	179	88	92	313	79
	70 V / Ch.	250 x 4	2.3	230	125	105	358	90
<b>Mains Voltage 120 VAC</b>								
<b>Standby</b>			0.1	7	0	7	24	6
<b>Power On, Idling, Green Mode</b>			0.4	44	0	44	152	38
<b>Power On, Idling, Performance Mode</b>			0.6	70	0	70	238	60
<b>Pink Pseudo Noise</b>	16 Ω / Ch.	250 x 4	1.9	228	125	103	350	88
	8 Ω / Ch.	250 x 4	2.0	238	125	113	386	97
	4 Ω / Ch.	250 x 4	2.1	252	125	127	433	109
	2 Ω / Ch.	250 x 4	2.3	277	125	152	519	131
	100 V / Ch.	175 x 4	1.5	179	88	91	311	78
	70 V / Ch.	250 x 4	1.9	229	125	103	353	89
<b>Mains Voltage 208 VAC</b>								
<b>Standby</b>			0.1	7	0	7	24	6
<b>Power On, Idling, Green Mode</b>			0.3	42	0	42	142	36
<b>Power On, Idling, Performance Mode</b>			0.4	66	0	66	225	57
<b>Pink Pseudo Noise</b>	16 Ω / Ch.	250 x 4	1.1	221	125	96	328	83
	8 Ω / Ch.	250 x 4	1.1	228	125	103	353	89
	4 Ω / Ch.	250 x 4	1.2	245	125	120	408	103
	2 Ω / Ch.	250 x 4	1.3	269	125	144	493	124
	100 V / Ch.	175 x 4	0.9	174	88	86	294	74
	70 V / Ch.	250 x 4	1.1	222	125	97	332	84
<b>Mains Voltage 230 VAC</b>								
<b>Standby</b>			0.1	7	0	7	25	6
<b>Power On, Idling, Green Mode</b>			0.3	41	0	41	141	36
<b>Power On, Idling, Performance Mode</b>			0.3	65	0	65	222	56
<b>Pink Pseudo Noise</b>	16 Ω / Ch.	250 x 4	1.0	218	125	93	317	80
	8 Ω / Ch.	250 x 4	1.0	225	125	100	342	86
	4 Ω / Ch.	250 x 4	1.1	238	125	113	387	97
	2 Ω / Ch.	250 x 4	1.2	263	125	138	472	119
	100 V / Ch.	175 x 4	0.8	168	88	81	275	69
	70 V / Ch.	250 x 4	1.0	216	125	91	311	78

D SERIES 20:4								
Level	Load	Rated power per channel	Line Current	Measured Power (W)			Thermal Dissipation	
				(A)	In	Out	Dissipated	BTU/hr
<b>Mains Voltage 100 VAC</b>								
<b>Standby</b>			0.2	7	0	7	24	6
<b>Power On, Idling, Green Mode</b>			0.5	46	0	46	157	39
<b>Power On, Idling, Performance Mode</b>			0.7	71	0	71	243	61
<b>Pink Pseudo Noise</b>	16 Ω / Ch.	425 x 4	2.9	348	213	136	463	117
	8 Ω / Ch.	500 x 4	3.5	418	250	168	573	144
	4 Ω / Ch.	500 x 4	3.7	444	250	194	662	167
	2 Ω / Ch.	500 x 4	4.1	492	250	242	825	208
	100 V / Ch.	250 x 4	1.9	230	125	105	360	91
	70 V / Ch.	500 x 4	3.5	410	250	160	546	138
<b>Mains Voltage 120 VAC</b>								
<b>Standby</b>			0.1	7	0	7	23	6
<b>Power On, Idling, Green Mode</b>			0.4	45	0	45	155	39
<b>Power On, Idling, Performance Mode</b>			0.6	71	0	71	241	61
<b>Pink Pseudo Noise</b>	16 Ω / Ch.	425 x 4	2.9	346	213	134	457	115
	8 Ω / Ch.	500 x 4	3.5	411	250	161	550	139
	4 Ω / Ch.	500 x 4	3.7	441	250	190	650	164
	2 Ω / Ch.	500 x 4	4.1	487	250	237	810	204
	100 V / Ch.	250 x 4	2.0	231	125	106	361	91
	70 V / Ch.	500 x 4	3.4	408	250	158	540	136
<b>Mains Voltage 208 VAC</b>								
<b>Standby</b>			0.1	7	0	7	24	6
<b>Power On, Idling, Green Mode</b>			0.3	43	0	43	147	37
<b>Power On, Idling, Performance Mode</b>			0.4	67	0	67	229	58
<b>Pink Pseudo Noise</b>	16 Ω / Ch.	425 x 4	1.5	336	213	124	422	106
	8 Ω / Ch.	500 x 4	1.8	398	250	148	506	127
	4 Ω / Ch.	500 x 4	1.9	426	250	176	600	151
	2 Ω / Ch.	500 x 4	2.1	471	250	221	753	190
	100 V / Ch.	250 x 4	1.0	224	125	99	339	85
	70 V / Ch.	500 x 4	1.8	395	250	145	496	125
<b>Mains Voltage 230 VAC</b>								
<b>Standby</b>			0.2	7	0	7	24	6
<b>Power On, Idling, Green Mode</b>			0.3	43	0	43	146	37
<b>Power On, Idling, Performance Mode</b>			0.4	67	0	67	227	57
<b>Pink Pseudo Noise</b>	16 Ω / Ch.	425 x 4	1.5	333	213	120	411	104
	8 Ω / Ch.	500 x 4	1.8	394	250	144	493	124
	4 Ω / Ch.	500 x 4	1.9	419	250	169	577	145
	2 Ω / Ch.	500 x 4	2.1	467	250	217	741	187
	100 V / Ch.	250 x 4	1.0	222	125	97	331	83
	70 V / Ch.	500 x 4	1.8	392	250	142	484	122



D SERIES 40:4								
Level	Load	Rated power per channel	Line Current	Measured Power (W)			Thermal Dissipation	
				(A)	In	Out	Dissipated	BTU/hr
<b>Mains Voltage 100 VAC</b>								
<b>Standby</b>			0.2	7	0	7	24	6
<b>Power On, Idling, Green Mode</b>			0.6	59	0	59	201	51
<b>Power On, Idling, Performance Mode</b>			0.8	78	0	78	267	67
<b>Pink Pseudo Noise</b>	16 Ω / Ch.	700 x 4	5.1	502	350	152	518	131
	8 Ω / Ch.	1000 x 4	7.2	709	500	209	714	180
	4 Ω / Ch.	1000 x 4	7.6	754	500	254	868	219
	2 Ω / Ch.	800 x 4	7.0	689	400	289	986	249
	100 V / Ch.	1000 x 4	7.1	701	500	200	684	172
	70 V / Ch.	1000 x 4	7.5	738	500	238	812	205
<b>Mains Voltage 120 VAC</b>								
<b>Standby</b>			0.2	7	0	7	24	6
<b>Power On, Idling, Green Mode</b>			0.5	59	0	59	200	50
<b>Power On, Idling, Performance Mode</b>			0.7	77	0	77	263	66
<b>Pink Pseudo Noise</b>	16 Ω / Ch.	700 x 4	4.2	497	350	147	503	127
	8 Ω / Ch.	1000 x 4	5.9	700	500	199	681	172
	4 Ω / Ch.	1000 x 4	6.3	743	500	243	829	209
	2 Ω / Ch.	800 x 4	5.7	679	400	279	953	240
	100 V / Ch.	1000 x 4	5.8	690	500	190	648	163
	70 V / Ch.	1000 x 4	6.1	726	500	226	772	195
<b>Mains Voltage 208 VAC</b>								
<b>Standby</b>			0.3	7	0	7	25	6
<b>Power On, Idling, Green Mode</b>			0.5	58	0	58	198	50
<b>Power On, Idling, Performance Mode</b>			0.5	77	0	77	263	66
<b>Pink Pseudo Noise</b>	16 Ω / Ch.	700 x 4	2.2	486	350	136	464	117
	8 Ω / Ch.	1000 x 4	3.1	681	500	181	617	155
	4 Ω / Ch.	1000 x 4	3.3	723	500	223	759	191
	2 Ω / Ch.	800 x 4	3.0	662	400	261	892	225
	100 V / Ch.	1000 x 4	3.0	673	500	173	589	148
	70 V / Ch.	1000 x 4	3.2	707	500	207	707	178
<b>Mains Voltage 230 VAC</b>								
<b>Standby</b>			0.3	7	0	7	25	6
<b>Power On, Idling, Green Mode</b>			0.4	58	0	58	197	50
<b>Power On, Idling, Performance Mode</b>			0.5	77	0	77	263	66
<b>Pink Pseudo Noise</b>	16 Ω / Ch.	700 x 4	2.2	474	350	124	423	106
	8 Ω / Ch.	1000 x 4	3.0	664	500	164	558	141
	4 Ω / Ch.	1000 x 4	3.2	705	500	205	701	176
	2 Ω / Ch.	800 x 4	3.0	649	400	249	850	214
	100 V / Ch.	1000 x 4	3.0	659	500	159	544	137
	70 V / Ch.	1000 x 4	3.2	694	500	194	661	166

D SERIES 80:4									
Level	Load	Rated power per channel	Line Current	Power Factor	Measured Power (W)			Thermal Dissipation	
			(A)	(%)	In	Out	Dissipated	BTU/hr	kCal/hr
<b>Mains Voltage 100 VAC, 30 A</b>									
Standby			0.3	43	11	0	11	36	9
Power on, Idling			2.1	99	204	0	204	696	175
Pink Pseudo Noise	16 Ω / Ch.	750	10.1	99	981	375	607	2070	522
	8 Ω / Ch.	1500	15.3	99	1492	749	743	2534	639
	4 Ω / Ch.	2000	14.9	99	1502	652	850	2900	731
	2.67 Ω / Ch.	2000	15.3	99	1539	625	914	3120	787
	2 Ω / Ch.	2000	15.2	99	1538	560	978	3337	841
LoadPilot Sine 20 kHz	8 Ω / Ch.		2.2	98	211	0	211	720	181
<b>Mains Voltage 120 VAC, 30 A</b>									
Standby			0.3	35	11	0	11	37	9
Power on, Idling			1.8	98	202	0	202	689	174
Pink Pseudo Noise	16 Ω / Ch.	750	8.0	99	954	375	579	1977	499
	8 Ω / Ch.	1500	12.6	99	1476	749	727	2480	625
	4 Ω / Ch.	2000	14.4	99	1739	817	923	3148	794
	2.67 Ω / Ch.	2000	14.7	99	1780	766	1014	3461	873
	2 Ω / Ch.	2000	15.2	99	1839	739	1101	3755	947
LoadPilot Sine 20 kHz	8 Ω / Ch.		1.8	98	211	0	211	719	181
<b>Mains Voltage 208 VAC, 17.3 A</b>									
Standby			0.3	17	11	0	11	39	10
Power on, Idling			1.1	91	197	0	197	673	170
Pink Pseudo Noise	16 Ω / Ch.	750	4.6	99	927	375	552	1884	475
	8 Ω / Ch.	1500	7.1	99	1436	749	687	2345	591
	4 Ω / Ch.	2000	9.3	100	1955	1000	955	3260	822
	2.67 Ω / Ch.	2000	9.8	100	2087	1003	1084	3698	933
	2 Ω / Ch.	2000	10.3	100	2182	1001	1181	4030	1016
LoadPilot Sine 20 kHz	8 Ω / Ch.		1.1	92	204	0	204	695	175
<b>Mains Voltage 230 VAC, 16 A</b>									
Standby			0.3	17	12	0	12	39	10
Power on, Idling			1.0	89	193	0	193	660	166
Pink Pseudo Noise	16 Ω / Ch.	750	4.2	99	948	375	573	1957	493
	8 Ω / Ch.	1500	6.4	99	1443	749	694	2369	597
	4 Ω / Ch.	2000	8.1	99	1907	1000	906	3092	780
	2.67 Ω / Ch.	2000	8.7	100	2052	1003	1049	3580	903
	2 Ω / Ch.	2000	9.4	100	2200	1000	1201	4096	1033
LoadPilot Sine 20 kHz	8 Ω / Ch.		1.0	89	204	0	204	695	175

D SERIES 120:4										
Level	Load	Rated power per channel	Line Current	Power Factor	Measured Power (W)			Thermal Dissipation		
					In	Out	Dissipated	BTU/hr	kCal/hr	
Mains Voltage 100 VAC, 30 A										
Standby			0.3	43	12	0	12	40	10	
Power on, Idling			2.3	98	219	0	219	749	189	
Pink Pseudo Noise	16 Ω / Ch.	950	10.8	99	1059	475	584	1994	503	
	8 Ω / Ch.	1900	19.2	99	1868	949	919	3136	791	
	4 Ω / Ch.	3000	24.6	99	2389	1200	1189	4057	1023	
	2.67 Ω / Ch.	3000	25.7	99	2551	1151	1400	4776	1204	
	2 Ω / Ch.	3000	25.8	99	2576	1113	1463	4992	1259	
LoadPilot Sine 20 kHz			8 Ω / Ch.	2.4	98	231	0	231	789	199
Mains Voltage 120 VAC, 30 A										
Standby			0.3	36	11	0	11	39	10	
Power on, Idling			1.9	98	215	0	215	734	185	
Pink Pseudo Noise	16 Ω / Ch.	950	8.8	99	1035	475	560	1910	482	
	8 Ω / Ch.	1900	15.1	99	1765	949	815	2783	702	
	4 Ω / Ch.	3000	24.0	99	2817	1502	1315	4487	1131	
	2.67 Ω / Ch.	3000	24.5	99	2894	1437	1456	4969	1253	
	2 Ω / Ch.	3000	25.1	99	2980	1361	1619	5524	1393	
LoadPilot Sine 20 kHz			8 Ω / Ch.	2.0	97	226	0	226	773	195
Mains Voltage 208 VAC, 17.3 A										
Standby			0.3	18	12	0	12	42	11	
Power on, Idling			1.1	91	211	0	211	720	182	
Pink Pseudo Noise	16 Ω / Ch.	950	4.9	99	1001	475	526	1795	453	
	8 Ω / Ch.	1900	8.7	99	1766	949	816	2786	702	
	4 Ω / Ch.	3000	13.3	99	2687	1501	1186	4046	1020	
	2.67 Ω / Ch.	3000	14.0	99	2847	1500	1346	4594	1158	
	2 Ω / Ch.	3000	14.8	99	3046	1500	1546	5276	1330	
LoadPilot Sine 20 kHz			8 Ω / Ch.	1.2	93	221	0	221	754	190
Mains Voltage 230 VAC, 16 A										
Standby			0.3	18	13	0	13	43	11	
Power on, Idling			1.0	90	205	0	205	698	176	
Pink Pseudo Noise	16 Ω / Ch.	950	4.7	99	1003	475	529	1803	455	
	8 Ω / Ch.	1900	7.7	99	1734	949	784	2676	675	
	4 Ω / Ch.	3000	11.4	99	2562	1501	1061	3620	913	
	2.67 Ω / Ch.	3000	12.8	99	2873	1499	1374	4688	1182	
	2 Ω / Ch.	3000	13.1	99	2993	1500	1493	5095	1285	
LoadPilot Sine 20 kHz			8 Ω / Ch.	1.0	90	214	0	214	730	184

**D SERIES 200:4**

Level	Load	Rated power per channel	Line Current	Power Factor	Measured Power (W)			Thermal Dissipation			
			(A)	(%)	In	Out	Dissipated	BTU/hr	kCal/hr		
<b>Mains Voltage 100 VAC, 30 A</b>											
Standby			0.3	52	17	0	17	58	15		
Power on, Idling			2.4	97	235	0	235	802	202		
Pink Pseudo Noise	16 Ω / Ch.	1150	12.1	99	1192	588	604	2061	520		
	8 Ω / Ch.	2300	22.3	99	2198	1174	1024	3493	881		
	4 Ω / Ch.	4400	29.2	99	2853	1478	1375	4691	1183		
	2.67 Ω / Ch.	5000	29.2	99	2862	1399	1463	4991	1259		
	2 Ω / Ch.	4400	29.1	99	2826	1355	1472	5022	1266		
<b>Mains Voltage 120 VAC, 30 A</b>											
Standby			0.3	48	17	0	17	58	15		
Power on, Idling			2.0	97	227	0	227	775	195		
Pink Pseudo Noise	16 Ω / Ch.	1150	12.0	99	1180	588	593	2023	510		
	8 Ω / Ch.	2300	18.4	99	2144	1174	970	3310	835		
	4 Ω / Ch.	4400	30.0	99	3457	1896	1561	5326	1343		
	2.67 Ω / Ch.	5000	29.5	99	3439	1752	1687	5756	1451		
	2 Ω / Ch.	4400	29.9	99	3495	1665	1830	6245	1575		
<b>Mains Voltage 208 VAC, 17.3 A</b>											
Standby			0.3	27	18	0	18	60	15		
Power on, Idling			1.2	92	222	0	222	757	191		
Pink Pseudo Noise	16 Ω / Ch.	1150	5.7	99	1151	588	564	1923	485		
	8 Ω / Ch.	2300	10.2	99	2055	1174	881	3005	758		
	4 Ω / Ch.	4400	16.2	99	3286	1948	1338	4565	1151		
	2.67 Ω / Ch.	5000	15.6	99	3171	1752	1419	4843	1221		
	2 Ω / Ch.	4400	16.0	99	3253	1665	1589	5420	1367		
<b>Mains Voltage 230 VAC, 16 A</b>											
Standby			0.3	23	18	0	18	61	15		
Power on, Idling			1.2	92	222	0	222	757	191		
Pink Pseudo Noise	16 Ω / Ch.	1150	5.1	98	1134	588	546	1863	470		
	8 Ω / Ch.	2300	9.2	99	2053	1174	879	2999	756		
	4 Ω / Ch.	4400	15.9	99	3529	2109	1420	4845	1222		
	2.67 Ω / Ch.	5000	16.0	99	3564	1935	1630	5561	1402		
	2 Ω / Ch.	4400	16.0	99	3577	1856	1722	5875	1481		
<b>Mains Voltage 230 VAC, 16 A</b>											
LoadPilot Sine 20 kHz			8 Ω / Ch.		1.1	90	228	0	228	777	196

### 14.3. Maintenance

During normal operation a D Series device provides trouble-free service. If the front panel display requires cleaning, use a soft cloth only; do not use solvent cleaners.

The dust filters on both sides of the front panel, behind the grilles, should occasionally be removed and cleaned to ensure maximum airflow through the device. Disconnect the unit from mains power prior to removing dust the filter, and ensure the dust filter is replaced prior to turning the unit back on.

In extreme cases it may be necessary to clean the inside of the device. This procedure should only be carried out by qualified service personnel. Internal cleaning may be necessary if the device has had prolonged operation in an extreme environment such as one where cracked oil smoke machines are in use. If the device is used in extreme conditions, it is recommended to have it serviced every three years as a preventative measure.

## 15. Technical Specifications

	D 200:4L	D 120:4L	D 80:4L
<b>General</b>			
Processing / Network	Lake / Dante	Lake / Dante	Lake / Dante
Number of amplifier channels	4	4	4
Total burst power all channels (share among channels with RPM)	20000 W	12000 W	8000 W
<b>Max. Output Power (all ch.'s driven) <sup>1)</sup></b>			
2 ohms	4400 W	3000 W	2000 W
2.67 ohms	5000 W	3000 W	2000 W
4 ohms	4400 W	3000 W	2000 W
8 ohms	2300 W	1900 W	1500 W
16 ohms	1150 W	950 W	750 W
Hi-Z 70 V	3300 W	3000 W	2000 W
Hi-Z 100 V	4700 W	3000 W	2000 W
<b>Max. Output power bridged mode (all ch.'s driven) <sup>1)</sup></b>			
4 ohms	8800 W	6000 W	4000 W
8 ohms	8800 W	6000 W	4000 W
16 ohms	4600 W	3800 W	3000 W
<b>Max output power single channel (all models) <sup>1)</sup></b>			
2 ohms	4400 W		
2.67 ohms	5900 W		
4 ohms	4600 W		
8 ohms	2300 W		
16 ohms	1150 W		
Hi-Z 70 V	3300 W		
Hi-Z 100 V	4700 W		
<b>Amplifier output modules (all models, all channels)</b>			
Peak output voltage	194 V		
Max output current	67 A		
Rational Power Management (RPM)	Share "total burst power" of the product freely among channels. Any channel can scale up to the "Max. output power single channel"		
Default voltage limitation (can be lifted with RPM configuration)	194 V	175 V	155 V
Protection features	Current Average Limiter (CAL), Very High Frequency Protection (VHF), Direct Current Protection (DC), Short Circuit Protection, Current-Clip Limiter, Voltage Clip Limiter, Temperature protection		
<b>Amplifier platform</b>			
Inter Sample Voltage Peak Limiter (ISVPL)	Configurable Peak voltage threshold and profile		
Amplifier gain	Digital configurable amplifier gain 22 - 44 dB		
Pilot tone generation and analysis	LoadPilot		
Load impedance analysis	Yes		
Temperature control	Regulated fans and show must go on limitation (ATL, PTL)		
<b>Audio Performance (Amplifier platform with digital input)</b>			
THD + N 20 Hz - 20 kHz for 1 W	< 0.05 %		
THD + N at 1 kHz and 1 dB below clipping	< 0.04 %		
Dynamic range	> 114 dB		
Channel separation (Crosstalk) at 1 kHz	> 70 dB		
Frequency response (1 W into 8 ohm, 20 Hz - 20 kHz)	+/- 0.05 dB		
Internal sample rate / Data path	48 / 96 kHz / 32 bit floating point		
Product propagation delay AES 96 kHz / analog input	1.61 / 1.68 ms		
<b>Lake processing</b>			
Loudspeaker processing	Up to 4 modules of Classic/linear-phase/FIR crossover, EQ, delay, LimiterMax™ - peak and RMS limiters		
System tuning	Group control with Raised Cosine™ MESA EQ™ asymmetric filters		
Input redundancy / Matrix	Automatic 4 level input redundancy / 4 input mixers		
System integration	Comprehensive 3rd party protocol over UDP Ethernet		
<b>Dante Audio Network</b>			
Dante I/O	8 x 8 (shared with AES67)		
Network topology / redundancy	Flexible topology / Supports daisy-chained and Dual redundant networks		
Sample rates / transport	48, 96 kHz / Uni + Multicast		
Network latency	0.25, 0.5, 1.0, 2.0, 5.0 ms		
<b>AES67 Audio Network</b>			
I/O	8 x 8 (shared with Dante)		
Network topology / redundancy	Flexible topology / Supports daisy-chained networks		
Sample rates / transport	48 kHz / Multicast		
Network latency	2 ms		

	D 200:4L	D 120:4L	D 80:4L
<b>Analog inputs</b>			
Inputs	4 high quality inputs with Iso-Float ground isolation		
Maximum input / digital reference	+ 26 dBu / +21 dBu		
Sampling rate / resolution	96 kHz / 24 bit		
Input impedance balanced / unbalanced	20 / 10 kOhm		
THD + N (typical at 1 kHz unweighted)	0.00022 %		
THD + N (typical at 20 Hz and 20 kHz unweighted)	0.00033 %		
<b>AES Inputs</b>			
Inputs	2 AES inputs (4 audio channels)		
Supported sample rates / resolution	44.1, 48, 88.2, 96, 176.4, 192 kHz / up to 24 bit		
Sample rate conversion THD + N 20 Hz - 20 kHz unweighted	0.00003 %		
<b>Rear panel interface</b>			
Analog inputs	4 x Terminal block connectors along input with +, - and ground		
AES inputs	2 x Terminal block connectors		
Output connectors	4 x 2 pole Terminal block connectors rated at 1000 V / 76 A (exceeding amplifier capacity) Can take up to 16 mm <sup>2</sup> (6 AWG) cables		
Ethernet ports	2 x EtherCon RJ45 100/1000 Base-T for the Lake Controller, Dante controller and/or DLM (3rd party protocol)		
Detachable mains cord	Neutrik PowerCon rated at 250 V / 32 A		
<b>Front panel user interface</b>			
System status indication	3 x tri-color LED. FRAME, TEMP, PSU for device status indication		
Channel status indication	3 x tri-color LED per channel. Status indication separated for channel LOAD, AMP, SIGNAL status		
Mute	Per channel touch button for MUTE control and tri-color LED for indication		
Power	Touch button for ON/STANDBY control and tri-color LED for power state indication		
Select	Touch button and LED for bi-directional device software select functionality		
<b>Mains Power</b>			
Nominal voltage	100 – 240 V AC 50 – 60 Hz		
Operating voltage	70 – 265 V AC 45 – 66 Hz		
Mains wall plug	Selectable on order CEE 7/7 "Schuko" 230 V / 16 A, NEMA L5-30 "Twistlock" 125 V / 30 A, NEMA 5-15P 125 V / 15 A (D 80:4 only), NEMA 5-20P 125 V / 20 A (D120:4 only), NEMA 6-20P 250 V / 20 A, AS/NZS 3112 230 V / 15 A (Aus/Nz), BS 546 230 V / 16 A (India), C-30P 125V / 30A (Japan)		
<b>Power supply features</b>			
Soft start / Inrush power	Yes / Max 8 A		
Power factor correction	> 0.98 for mains power > 400 W		
Regulated switch mode power supply (R.SMPS)	Yes		
Breaker Emulation Limiter (BEL)	Configurable current threshold and breaker profile		
BEL max current threshold	32 A	25 A	15 A
Power Average Limiter (PAL)	Yes		
Under Voltage Limiter (UVL)	Yes		
Mains undervoltage and overvoltage protection and mains glitch tolerance	Yes		
<b>Dimensions</b>			
Rack rail to rear panel	W: 483 mm (19"), H: 88 mm (2 U), D: 424 mm (16")		
Overall all depth front-rear support	D: 463 mm		
<b>Weight</b>			
	16.5 kg (36 lbs)	15.8 kg (35 lbs)	14.5 kg (32 lbs)
<b>Finish</b>			
	Black painted steel chassis with grey painted steel front with detachable grille		
<b>Approvals</b>			
	CE, ETL (ANSI/UL, CSA), PSE, RCM		

**Note 1):** Lab.gruppen burst power (1 kHz, 25 ms burst power @ 150 BPM, 12 dB Crest factor)

**All specifications are subject to change without notice.**

# 15. Technical Specifications

	D 40:4L	D 20:4L	D 10:4L
<b>General</b>			
Processing / Network	Lake / Dante	Lake / Dante	Lake / Dante
Number of amplifier channels	4	4	4
Total burst power all channels (share among channels with RPM)	4000 W	2000 W	1000 W
<b>Max. Output Power (all ch.'s driven) <sup>1)</sup></b>			
2 ohms	800 W	500 W	250 W
2.67 ohms	1000 W	500 W	250 W
4 ohms	1000 W	500 W	250 W
8 ohms	1000 W	500 W	250 W
16 ohms	700 W	425 W	250 W
Hi-Z 25 V	500 W	500 W	250 W
Hi-Z 70 V	1000 W	500 W	250 W
Hi-Z 100 V	1000 W	250 W	175 W
<b>Max output power single channel <sup>1)</sup></b>			
2 ohms	850 W	850 W	850 W
2.67 ohms	1150 W	1150 W	1000 W
4 ohms	1750 W	1600 W	1000 W
8 ohms	1350 W	1100 W	1000 W
16 ohms	700 W	600 W	600 W
Hi-Z 25 V	500 W	500 W	500 W
Hi-Z 70 V	1450 W	1400 W	1000 W
Hi-Z 100 V	2000 W	1000 W	700 W
<b>Amplifier output modules (all channels)</b>			
Peak output voltage	150 Vpk	142 Vpk	142 Vpk
Max output current	30 Apk	30 Apk	30 Apk
Rational Power Management (RPM)	Share "Total burst power" of the product freely among channels. Any channel can scale up to the "single channel max power"		
Default voltage limitation (can be lifted with RPM configuration)	145 Vpk	100 Vpk	65 Vpk
Protection features	Current Average Limiter (CAL), Very High Frequency Protection (VHF), Direct Current Protection (DC), Short Circuit Protection, Current-Clip Limiter, Voltage Clip Limiter, Temperature protection		
<b>Amplifier platform</b>			
Inter Sample Voltage Peak Limiter (ISVPL)	Configurable Peak voltage threshold and profile		
Amplifier gain	Digital configurable amplifier gain 22 - 44 dB		
Pilot tone generation and analysis	Yes		
Load impedance analysis	Yes		
Temperature control	Temperature regulated fans (front-to-rear airflow) and show must go on limitation (ATL, PTL)		
<b>Audio Performance (Amplifier platform with digital input)</b>			
THD + N 20 Hz - 20 kHz for 1 W	< 0.05 %		
THD + N at 1 kHz and 1 dB below clipping	< 0.04 %		
Dynamic range	> 112 dB		
Channel separation (Crosstalk) at 1 kHz	> 70 dB		
Frequency response (1 W into 8 ohm, 20 Hz - 20 kHz)	+/- 0.05 dB		
Internal sample rate / Data path	96 kHz / 32 bit floating point		
Product propagation delay AES 96 kHz / analog input	1.61 / 1.68 ms		
<b>Lake processing</b>			
Loudspeaker processing	Up to 4 modules of Classic/linear-phase/FIR crossover, EQ, delay, LimiterMax™ - peak and RMS limiters		
System tuning	Group control with Raised Cosine™ MESA EQ™ asymmetric filters		
Input redundancy / Matrix	Automatic 4 level input redundancy / 4 input mixers		
System integration	Comprehensive 3rd party protocol over UDP Ethernet		
<b>Dante Audio Network</b>			
Dante I/O	8 x 8 (shared with AES67)		
Network topology / redundancy	Flexible topology / Supports Daisy-chained and Dual redundant networks		
Sample rates / transport	48, 96 kHz / Uni + Multicast		
Network latency	0.25, 0.5, 1.0, 2.0, 5.0 ms		
<b>AES67 Audio Network</b>			
I/O	8 x 8 (shared with Dante)		
Network topology / redundancy	Flexible topology / Supports daisy-chained networks		
Sample rates / transport	48 kHz / Multicast		
Network latency	2 ms		
<b>Analog inputs</b>			
Inputs	4 high quality inputs with Iso-Float™ ground isolation		
Maximum input / digital reference	+ 26 dBu / +21 dBu		
Sampling rate / resolution	96 kHz / 24 bit		
Input impedance balanced / unbalanced	20 / 10 kOhm		
THD + N (typical at 1 kHz unweighted)	0.00022 %		
THD + N (typical at 20 Hz and 20 kHz unweighted)	0.00033 %		



	D 40:4L	D 20:4L	D 10:4L
<b>AES Inputs</b>			
Inputs	4 AES inputs		
Supported sample rates / resolution	44.1, 48, 88.2, 96, 176.4, 192 kHz / up to 24 bit		
Sample rate conversion THD + N 20 Hz - 20 kHz unweighted	0.00003 %		
<b>Back panel interface</b>			
Analog inputs	4 x Terminal block connectors analog input with +, - and ground		
AES inputs	4 x Terminal block connectors analog input with +, - and ground		
Output connectors	4 x 2 pole Terminal block connectors rated at 1000 V / 41 A (exceeding amplifier capacity) Can take up to 8 mm <sup>2</sup> (8.2 AWG) cables		
Ethernet ports	2 x EtherCon RJ45 Lake Controller, Dante controller and/or DLM (3rd party protocol)		
Detachable mains cord	Detachable locking 3-pin IEC rated at 250 V / 16 A		
<b>Front panel user interface</b>			
System status indication	3 x tri-color LED. FRAME, TEMP, PSU for device status indication		
Channel status indication	3 x tri-color LED per channel. Status indication separated for channel LOAD, AMP, SIGNAL status		
Mute	Per channel touch button for MUTE control and tri-color LED for indication		
Power	Touch button for ON/STANDBY control and tri-color LED for power state indication		
Select	Touch button and LED for bi-directional device software select functionality		
<b>Mains Power</b>			
Nominal voltage	100 - 240 V AC 50 - 60 Hz		
Operating voltage	70 - 265 V AC 45 - 66 Hz		
Mains wall plug	Selectable on order CEE 7/7 "Schuko" 230 V / 16 A, NEMA 5-15 125 V / 15 A, BS1363-A 250 V / 13 A, IA16A3 250 V / 16 A, AU/NZ 250 V / 10 A, JP 125 V / 15 A, CPCS-CCC 250 V / 10 A		
<b>Power supply features</b>			
Soft start / Inrush power	Yes		
Power factor correction	> 0.98 for mains power > 300 W		
Regulated switch mode power supply (R.SMPS)	Yes		
Breaker Emulation Limiter (BEL)	Yes		
BEL max current threshold	15 A	7 A	7 A
Power Average Limiter (PAL)	Yes		
Under Voltage Limiter (UVL)	Yes	No	No
Mains undervoltage and overvoltage protection and mains glitch tolerance	Yes		
<b>Dimensions</b>			
Rack rail to rear panel	W: 483 mm (19"), H: 44 mm (1 U), D: 425 mm (16.7")		
Overall depth front-rear support	D: 463 mm		
<b>Weight</b>			
	8.3 kg (18.3 lbs)	7.9 kg (17.3 lbs)	7.8 kg (17.1 lbs)
<b>Finish</b>			
	Black painted steel chassis with grey painted steel front with detachable grille		
<b>Approvals</b>			
	CE, ETL (ANSI/UL, CSA), PSE, RCM, BIS, CCC		

**Note 1):** Lab.gruppen burst power (1 kHz, 25 ms burst power @ 150 BPM, 12 dB Crest factor)

All specifications are subject to change without notice.

# 16. Warranty and support

## 16.1. General

This product is manufactured by Lab.gruppen, and it is warranted to be free from any defects caused by components or factory workmanship, under normal use and service, for a period of ten (10) years from date of purchase from an authorized Lab.gruppen dealer. If the product fails to perform as specified during the warranty period, Lab.gruppen will undertake to repair, or at its option, replace this product at no charge to its owner, provided the unit is returned undamaged, shipping prepaid, to an authorized service facility or to the factory. This warranty shall be null and void if the product is subjected to: repair work or alteration by a person other than those authorized by us; mechanical damage including shipping accidents; war, civil insurrection, misuse, abuse, operation with incorrect AC voltage; incorrect connections or accessories; operation with faulty associated equipment; or exposure to inclement weather conditions. Damage due to normal wear and tear is not covered by the warranty. Units on which the serial number has been removed or defaced will not be eligible for warranty service. Lab.gruppen shall not be responsible for any incidental or consequential damages. Lab.gruppen's responsibility is limited to the product itself. Lab.gruppen takes no responsibility for any loss due to cancellation of any events, or rent of replacement equipment or costs due to a third party's or customer's loss of profit, or any other indirect cost or losses however incurred. Lab.gruppen reserves the right to make changes or improvements in design or manufacturing without assuming any obligation to change or improve products previously manufactured. This warranty is exclusive, and no other warranty is expressed or implied. This warranty does not affect the customer's statutory rights.

### **International Warranties**

Please contact your supplier or distributor for this information, as rights and disclaimers may vary from country to country.

## 16.2. Technical assistance and service

### 16.2.1. International service

If your Lab.gruppen product requires repair, contact your Lab.gruppen dealer or distributor, visit <http://labgruppen.com/support> or contact Lab.gruppen by phone or email to obtain details for the nearest authorized service center.

### 16.2.2. Factory service

In the event a Lab.gruppen product requires factory service, you may contact Lab.gruppen's service department for return instructions and a Return Authorization number.

Please note for product return:

1. Use the original packing.
2. Include a copy of the sales receipt, your name, return address, phone and fax number, email address and description of the defect.
3. Mark the Return Authorization number on the outside of the packing.

Ship the product prepaid to:

Music Tribe Brands Sweden AB Faktorvägen 1  
SE-434 37 Kungsbacka  
Sweden  
Phone: +46 300 56 28 00

**[service@labgruppen.com](mailto:service@labgruppen.com) [www.labgruppen.com](http://www.labgruppen.com)**

# Notes

# Notes

labgruppen.com

Lab.gruppen adopts a policy of continuous improvement and product specification is subject to change.  
RPM, R.SMPS, PFC, CDM, BEL, UVL, CAFÉ, ESP, ISVPL, Iso-Float, Raised Cosine, MESA EQ, LimiterMax and  
LoadLibrary are trademarks of Lab.gruppen AB. All other trademarks remain the property of their respective owners.  
Copyright © 2018 Tribe Brands Innovation Sweden AB. All rights reserved.