

# User's Manual

## S-8

## 8-CHANNEL MIXING CONSOLE

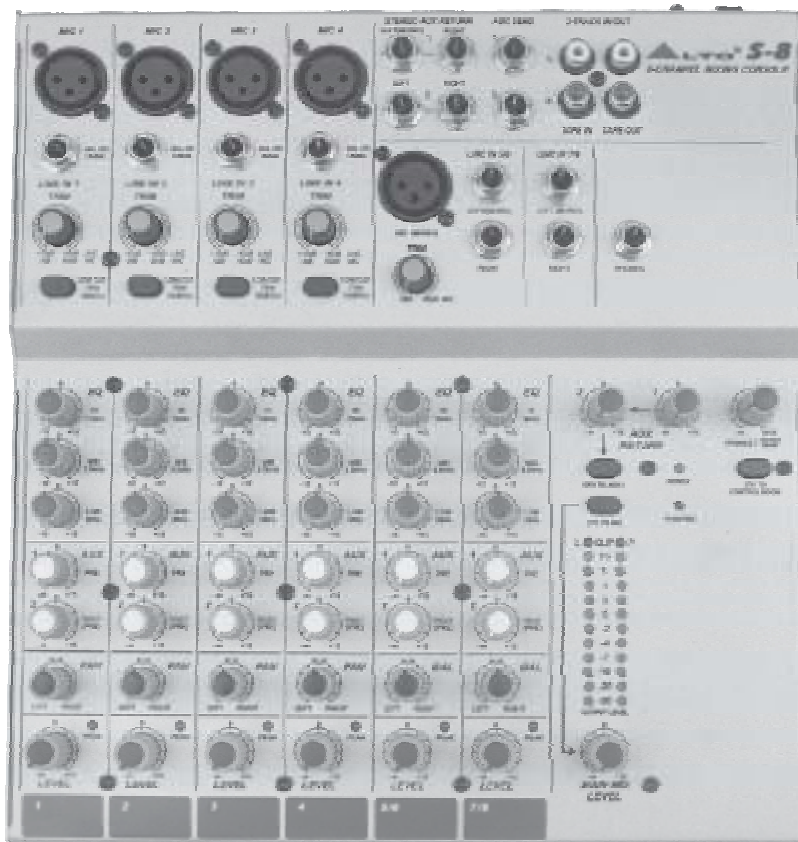

[www.altoproaudio.com](http://www.altoproaudio.com)

Version 2.0 Dec. 2002

— English —

## SAFETY RELATED SYMBOLS



This symbol, wherever used, alerts you to the presence of un-insulated and dangerous voltages within the product enclosure. These are voltages that may be sufficient to constitute the risk of electric shock or death.



This symbol, wherever used, alerts you to important operating and maintenance instructions. Please read.



Protective Ground Terminal



AC mains (Alternating Current)



Hazardous Live Terminal

**ON:** Denotes the product is turned on.

**OFF:** Denotes the product is turned off.

### WARNING

Describes precautions that should be observed to prevent the possibility of death or injury to the user.

### CAUTION

Describes precautions that should be observed to prevent damage to the product.

## WARNING

### • Power Supply

Ensure that the mains source voltage (AC outlet) matches the voltage rating of the product. Failure to do so could result in damage to the product and possibly the user.

Unplug the product before electrical storms occur and when unused for long periods of time to reduce the risk of electric shock or fire.

### • External Connection

Always use proper ready-made insulated mains cabling (power cord). Failure to do so could result in shock/death or fire. If in doubt, seek advice from a registered electrician.

### • Do Not Remove Any Covers

Within the product are areas where high voltages may present. To reduce the risk of electric shock do not remove any covers unless the AC mains power cord is removed.

**Covers should be removed by qualified service personnel only.**

No user serviceable parts inside.

### • Fuse

To prevent fire and damage to the product, use only

the recommended fuse type as indicated in this manual. Do not short-circuit the fuse holder. Before replacing the fuse, make sure that the product is OFF and disconnected from the AC outlet.

### • Protective Ground

Before turning the product ON, make sure that it is connected to Ground. This is to prevent the risk of electric shock.

Never cut internal or external Ground wires. Likewise, never remove Ground wiring from the Protective Ground Terminal.

### • Operating Conditions

Always install in accordance with the manufacturer's instructions.

To avoid the risk of electric shock and damage, do not subject this product to any liquid/rain or moisture. Do not use this product when in close proximity to water.

Do not install this product near any direct heat source.

Do not block areas of ventilation. Failure to do so could result in fire.

Keep product away from naked flames.

## IMPORTANT SAFETY INSTRUCTIONS

Read these instructions

Follow all instructions

Keep these instructions. Do not discard.

Heed all warnings.

Only use attachments/accessories specified by the manufacturer.

### • Power Cord and Plug

Do not tamper with the power cord or plug. These are designed for your safety.

Do not remove Ground connections!

If the plug does not fit your AC outlet seek advice from a qualified electrician.

Protect the power cord and plug from any physical stress to avoid risk of electric shock.

Do not place heavy objects on the power cord. This could cause electric shock or fire.

### • Cleaning

When required, either blow off dust from the product or use a dry cloth.

Do not use any solvents such as Benzol or Alcohol.

For safety, keep product clean and free from dust.

### • Servicing

Refer all servicing to qualified service personnel only. Do not perform any servicing other than those instructions contained within the User's Manual.

## PREFACE

Dear Customer:

Thank you for choosing the ▲LTO S-8 8-Channel Mixing Console, which is the result of our ▲LTO AUDIO TEAM's endeavours.

For the ▲LTO AUDIO TEAM, music and audio is more than a profession, it is a passion and an obsession!

We have, in fact, been designing professional audio products for a number of years in cooperation with many of the world's major brands.

The ▲LTO line represents unparalleled analogue and digital products made by musicians, for musicians. With our design centres in Italy, the Netherlands, and the United Kingdom we provide you with world-class designs, while our software development teams continue to develop an impressive range of audio specific algorithms.

By purchasing our ▲LTO products you become the most important member of our ▲LTO AUDIO TEAM. We would like to share with you our passion for what we design and invite you to make suggestions, which will aid us in developing future products for you. We guarantee you our commitment for quality, continual research and development, and of course the best prices.

The ▲LTO S-8 is an extremely flexible, ultra-low noise 8-channel console, configured with 4 mono and 2 stereo input channels, each channel is equipped with a variety of key features including a warm, natural sounding EQ, Peak LEDs and PAN/BAL control etc..

We would like to thank all the people who made the ▲LTO S-8 8-Channel Mixing Console possible, especially to our designers and ▲LTO staff. It is their passion for music and professional audio that has made it possible for us to offer you, our most important team member, our continued support.

Thank you very much  
▲LTO AUDIO TEAM

# TABLE OF CONTENTS

1.INTRODUCTION.....	4
2.FEATURES.....	5
3.READY TO START?.....	6
4.CONTROL ELEMENTS.....	7
4.1 The mono MIC/LINE channels.....	8
4.2 INPUT LEVEL setting.....	8
4.3 LOW CUT FILTER.....	8
4.4 STEREO INPUT .....	9
4.5 The 3 BANDS EQUALISER.....	9
4.6 AUX SENDS.....	10
4.7 PAN.....	10
4.8 PEAK.....	10
4.9 LEVEL.....	10
4.10 INSERT.....	10
4.11 MASTER SECTION .....	11
-MAIN MIX LEVEL	
-LED METER	
-2 TRACK signal path	
-AUX RETURN	
-PHONES/CONTROL ROOM	
-PHANTOM	
-POWER	
-2-TRACK IN/OUT	
-STEREO AUX RETURN	
-AUX SEND 1 and 2	
-PHONES	
4.12 REAR PANEL DESCRIPTION.....	13
-POWER	
-PHANTOM	
-AC INLET WITH FUSE HOLDER	
-MAIN MIX OUTPUT	
-CONTROL ROOM OUTPUT	
5.INSTALLATION AND CONNECTION.....	14
6.FOR THE EXPERTS WHO WANT TO KNOW MORE.....	17
7.SYSTEM BLOCK DIAGRAMS.....	18
8.TECHNICAL SPECIFICATION.....	19
9.WARRANTY.....	20

## 1. INTRODUCTION

Your S-8 is a 8-channel mixer and it is one of the most popular compact mixing consoles in the world. In fact it has been sold already in terms of thousands of units worldwide. Despite its compact dimensions, great performances and sound quality are insured thanks to the specification of the components used and the building quality.

Your S-8 is packed with features that can not be found in other consoles of its size: 5 Mono (these are provided with Ultra Low Noise microphone preamplifiers and Phantom Power at +48 Volt) and 2 stereo input channels are provided, and each of them is provided with a 3 bands graphic equaliser for LOW, MID and HI controls, as well as 2 Auxiliary Bus. There is even a stereo input available to be assigned directly to the main MIX or to the other outputs: Control Room and Headphone. So, in total you have 14 inputs on you S-8.

Your S-8 is very easy to operate but we advise you to go through each Section of this Manual carefully. In this way you will get the best out of your S-8.

## 2. FEATURES

Your S-8 is provided with 4 mono Line/Mic input, 1 stereo Line/Mic input and an additional stereo Line input to be used with keyboards, Midi Instruments, etc. We have even included a 2-track input/output for recording and playback. Ultra low noise microphone preamplifiers, 3 bands eq on all input channels, pre and post Auxiliary bus and phantom power complete the picture.

- 5 Input for Microphone and line provided with balanced 1/4" jack and XLR. Channel 5 features stereo Line input
- 1 additional input for Line level signal provided with balanced TRS 1/4" jacks
- The Microphone preamplifiers are Ultra Low Noise and are provided with +48 Volt Phantom Power
- Precise 3 bands graphic equaliser (LOW, MID and HI) on each input channel
- Pre-fader and post-fader Auxiliary bus
- Single Led indicating signal Peaks on each input channel
- Low-cut filter on all mono MIC channels
- 2-track input featuring RCA sockets assignable alternatively to each output group
- 12 Segments Led Meter for optimum reading of the output signal
- Main Output and Control Room outputs are unbalanced type

### 3. READY TO START?

- 3.1 Please check the AC Voltage available in your Country before connecting your S-8 to the AC socket.
- 3.2 Be sure that the main power switch is turned off before connecting the Mixer to the AC socket. Also, you should make sure that all Input and Output Controls are turned down. This will avoid damages to your speakers and avoid excessive noise.
- 3.3 Before turning on the S-8 you shall connect it to a power amplifier and turn-on the mixer BEFORE the power amplifier. Once you have finished your working session you shall turn the mixer off AFTER the power amplifier.
- 3.4 Before disconnecting the S-8 always turn-off the Power switch.
- 3.5 Do not use solvents to clean your S-8. A dry and clean cloth will be OK.

# 4. CONTROL ELEMENTS

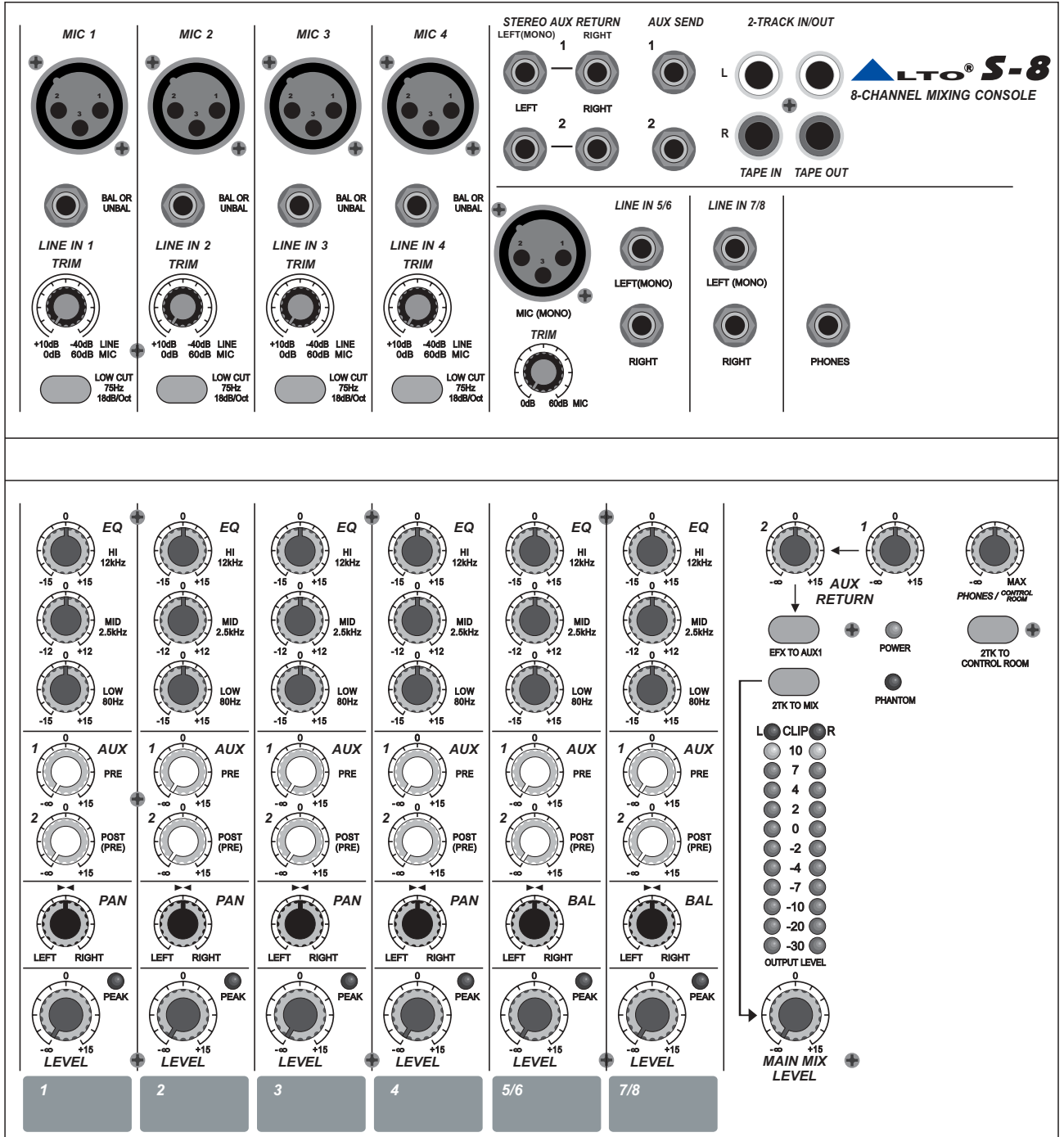

## 4. CONTROL ELEMENTS

### 4.1 The mono MIC/LINE channels 1

These are Channel 1 through Channel 4. You can connect balanced, low impedance microphones to the XLR socket. On the 1/4" phone jack you can connect either a microphone or a line level instrument. You shall never connect an unbalanced microphone to the XLR socket if you do not want to damage both the Microphone and the Mixer.

### 48 Volt phantom power 4

It is available only to the XLR Mic sockets. Never plug in a microphone when phantom power is already on. Before turning phantom power on, make sure that all faders are all the way down. In this way you will protect your Stage Monitors and Main Loudspeakers.

### 4.2 INPUT LEVEL setting 2

This Control is provided with 2 different indication rings: One is for the Microphone and the other for the Line levels. When you use a microphone you shall read the OUTSIDE ring (0-60 dB), When you use a Line level instrument you shall read the INSIDE ring (+15~-45 dB). For optimum operation you shall set this control in a way that the peak LED will blink also occasionally in order to avoid distortion on the input channel.

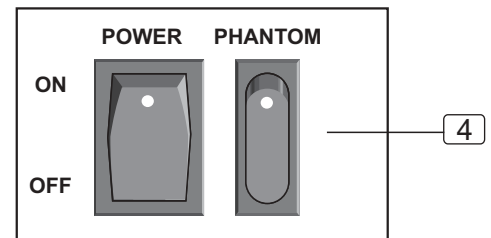
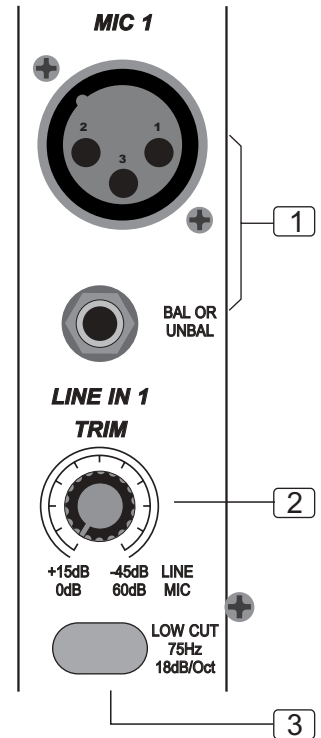

### 4.3 LOW-CUT FILTER 3

By pressing this button you will activate a 75 Hz low frequency filter with a slope of 18 dB per octave. You can use this function to reduce hum and stage rumble when using microphones.

## 4.4 STEREO INPUTS

5

These are Channel 5 through 8. They are organised in stereo pair (5&6 pair also features XLR Mic Input) and they are provided with 1/4" TRS phone sockets.

If you connect only the left jack, the input will operate in mono mode.

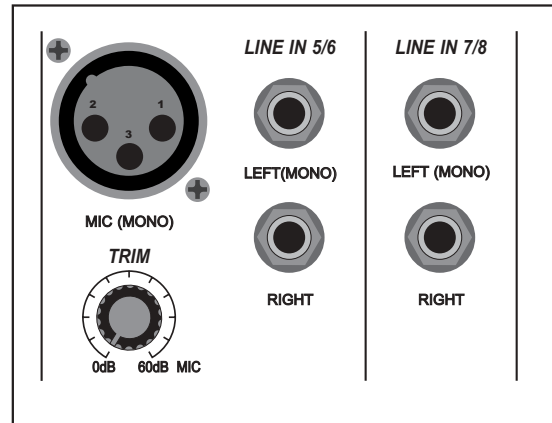

## 4.5 The 3 BANDS EQUALISER

A 3-band equaliser is provided for all input channels with a wide range of frequency adjustment.

### 4.5.1 HI

6

This is the Treble control. You can use it to get rid of high frequency noises or to boost the sound of cymbals or the high harmonics of the human voice. The gain range goes from -15dB to +15dB with a center frequency of 12 kHz.

### 4.5.2 MID

7

This is the Midrange control. It can affect most fundamental frequencies of all musical instruments and human voice. An attentive use of this control will give you a very wide panorama of sound effects. The gain range goes from -12dB to +12dB and the center frequency is 2.5 kHz.

### 4.5.3 LOW

8

This is the Bass control. Boost male voice or kickdrum and bass guitar. Your system will sound much bigger than what it is. The gain range goes from -15dB to +15dB and the center frequency is 80 Hz.

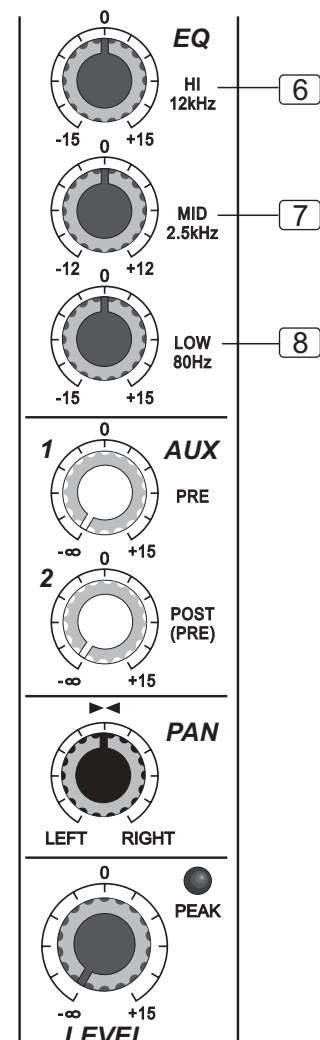

#### 4.6 AUX SENDS 9

These two controls will send the audio signal out to Auxiliary busses. AUX 1 is configured as PRE-FADER. It means that the signal is sent out before reaching the main Fader. This will be used for stage monitors. AUX 2 is configured as POST-FADER; therefore, the audio signal will be affected by the Main Channel Fader. This will be used for effects and sound processors. However, Aux 2 can also be configured as Pre-Fader through any internal modification. (Please see "MODIFICATIONS" later in this Manual.)

#### 4.7 PAN 10

This is the PANORAMA control, or balance control. You can adjust the stereo image of the signal via this Control. Keep this control in center position and your signal will be positioned in the middle of stage. Turn this control fully counterclockwise and the signal will be present only on the left speaker and vice-versa. Of course a wide number of intermediate positions is available.

#### 4.8 PEAK 11

Inside your S-8 the audio signal is monitored in several different stages and then sent to the PEAK Led. When this Led blinks, it warns you that you are reaching signal saturation and possible distortion. The PEAK Led will blink with a level that is 6dB before actual clipping.

#### 4.9 LEVEL 12

This Control will adjust the overall level of this channel and set the amount of signal sent to the Main output.

#### 4.10 INSERT 13

Insert points are provided for the Mono Mic Channels. When you insert a jack in the insert socket, the signal will be taken out after the Input Gain Control (Trim), sent to an external processor such a compressor-limiter, and returned into the channel strip immediately before the EQ section. Of course, these jacks used must be stereo (Tip Send/ Ring Return).

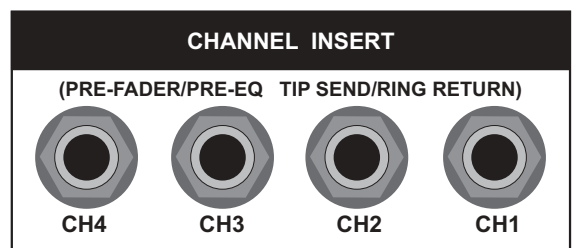
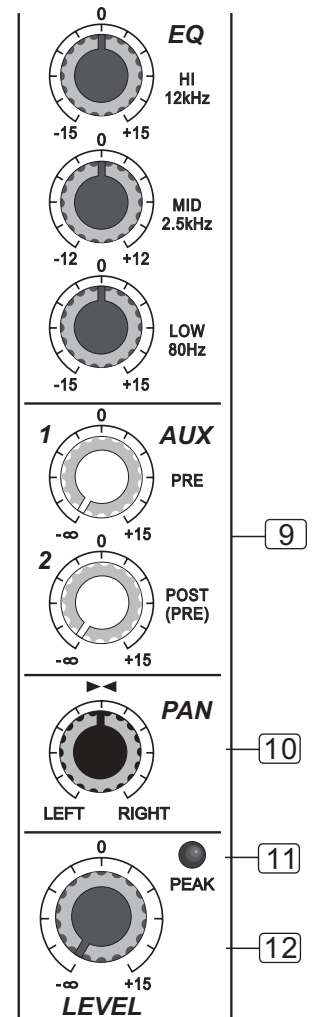

13

## 4.11 MASTER SECTION

### - MAIN MIX LEVEL 14

This Control sets the amount of signal sent either to the Main Out socket or to the Tape Output.

### - LED METER 15

This stereo 12 segments Led Meter will indicate the level of the overall output signal.

### - 2 TRACK signal path 16

If you push down the 2TK TO CONTROL ROOM button, the 2 TRACK IN signal will be routed into the Control Room output and the level will be adjusted in level by the Control Room knob.

If you push down the 2TR TO MIX button, the 2 TRACK IN signal will be routed into the MAIN output and will be adjusted in level by the MAIN MIX LEVEL knob.

### - AUX RETURN 17

The Auxiliary Return 1 and 2 are in fact two additional stereo Line inputs.

AUX RETURN 1 is configured to be assigned permanently to the Main Mix. (It operates in Mono Mode if you connect only the left jack).

The EFX TO AUX1 button is used to switch the signal from AUX RETURN 2 between MAIN MIX and AUX SEND 1.

If a signal is routed to AUX RETURN 1 and no signal is connected to AUX RETURN 2, depressing the EFX TO AUX 1 will route the signal to AUX SEND 1, which level will be controlled by AUX RETURN 2.

Without doubt, this feature will be very useful for you.

### - PHONES/CONTROL ROOM 18

This Control sets the amount of signal sent to the Control Room and headphone.

### - PHANTOM 19

This LED indicates when the Phantom Power is switched on.

### - POWER 20

This LED indicates when the Power is on in your S-8.

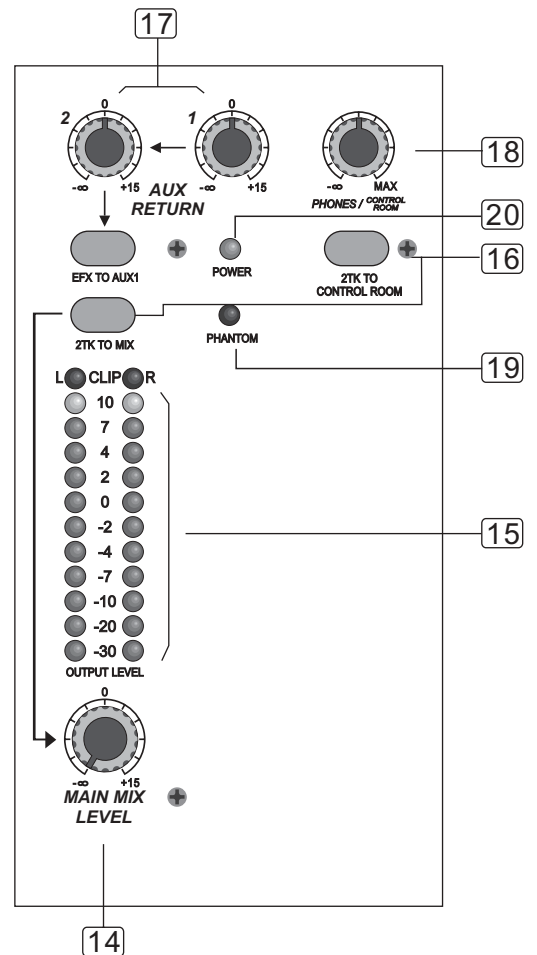

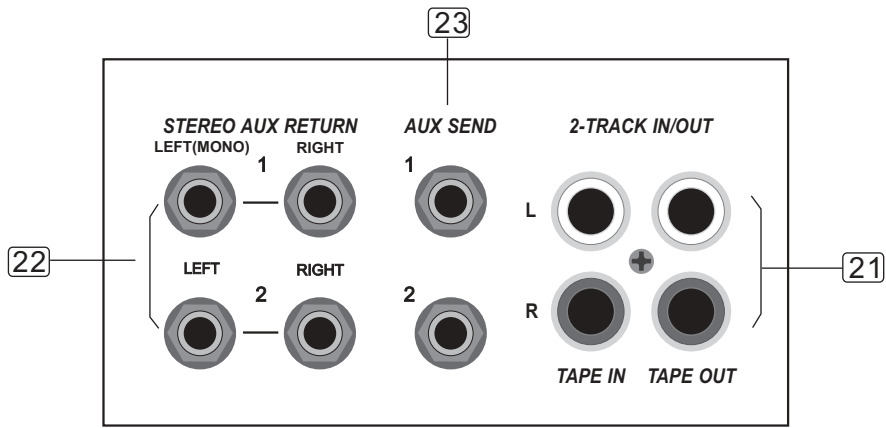

**- 2-TRACK IN/OUT** 21

**Input**

Use the Tape input if you wish to listen to your Mix from a Taper Recorder or DAT, You can assign the signal coming form the Taper Recorder either to a pair of studio monitor using the Control Room assignment on the front panel or you can also send the signal directly to the Main Mix.

**Output**

These 1/4" TRS sockets will route the main mix into a tape recorder.

**- STEREO AUX RETURN** 22

Use these stereo 1/4" phone socket to return the sound of an effect unit or sound processor to the Main Mix. Alternatively you can use them as an extra auxiliary input.

**- AUX SEND 1 and 2** 23

These 1/4" phone sockets are used to send out the signal from the AUX Bus to external devices such as effects and sound processors.

**- PHONES** 24

This socket will send out the signal mix to a pair of headphones.

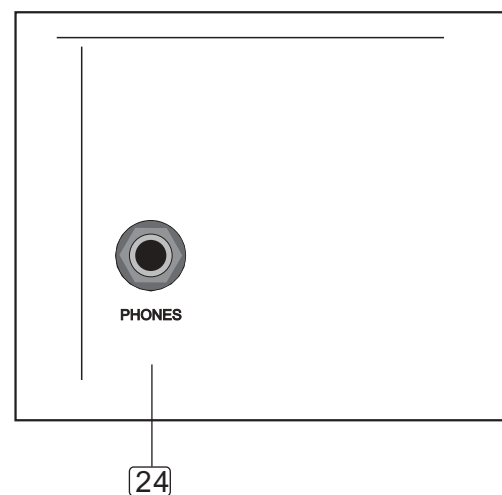

## 4.12 REAR PANEL DESCRIPTION

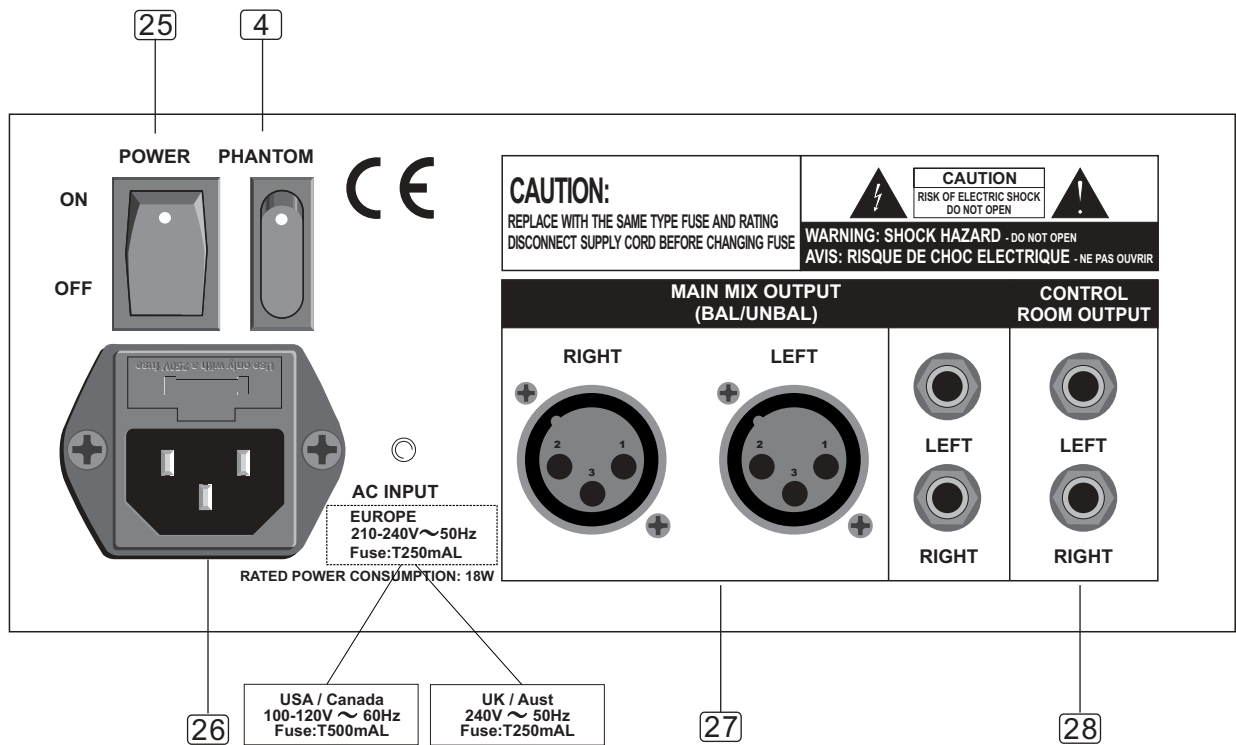

### - POWER **25**

This switch is used to turn the Main Power ON and OFF.

### - PHANTOM **4**

This switch will apply +48 Volt Phantom Power only to the 5 XLR microphone inputs. Never connect microphones when the Phantom Power is on already.

### - AC INLET WITH FUSE HOLDER **26**

Use it to connect your S-8 to the Main AC with the supplied AC cord. Please check the Voltage available in your Country and make sure the voltage is identical to the values marking on the product. Replace the fuse with the same type by the qualified personnel only

### - MAIN MIX OUTPUT **27**

This stereo output is supplied both with XLR and 1/4" jack socket and it is controlled by the Main Mix Level on the front panel. It will send the audio signal to an amplifier. The output level can be varied from  $-\infty$  to +15dB.

### - CONTROL ROOM OUTPUT **28**

These 1/4" phone sockets will be used to send the signal to Studio Monitor speakers or to a second set of PA.

## 5. INSTALLATION AND CONNECTION

Ok, you have got to this point you are now in the position to successfully operate your S-8. However, we advise you to read carefully the following section to be the real Master of your own Mix. Not paying attention enough to the Input signal level, to the routing of the signal and the assignment of the signal will result in unwanted distortion, a corrupted signal or no sound at all. So you should follow this procedure for every single channel:

- Turn down all Input and Output Gain Controls.
- Connect phantom powered microphones before switching on the +48Volt Phantom Power switch.
- If you have a power amplifier connected to your S-8 set the Level of the amplifier at no more than 70%.
- Now, set the CONTROL ROOM/PHONES level at no more than 50%. In this way you will be able to hear later what you are doing connecting a pair of headphones or a pair of powered studio monitor speakers.
- Position HI, MID and LOW eq controls on middle position.
- Position panoramic (PAN) control on center position.
- With a headphone or studio monitor speakers connected apply a Line Level input signal so that the PEAK Led does not light up.
- At this point increase the input gain so that the PEAK led will blink occasionally. In this way you will maintain good headroom and ideal dynamic range.
- Now connect a microphone and ask the singer to sing loud into the microphone. Turn slowly the Gain Control clockwise and have the PEAK Led blink only occasionally.
- Now repeat the same sequence for all input channels. The Main Led Meter could move up into the red section. In this case you can adjust the overall output level through the MAIN MIX control.

## 5.1 SOME FINAL TIPS ON WIRING CONFIGURATION

You can connect unbalanced equipment to balanced inputs and outputs. Simply follow these schematics.

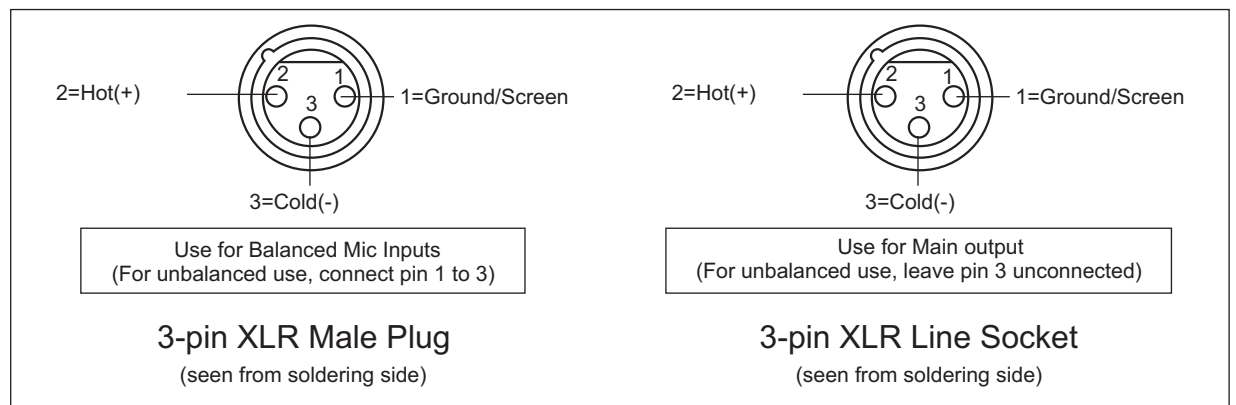
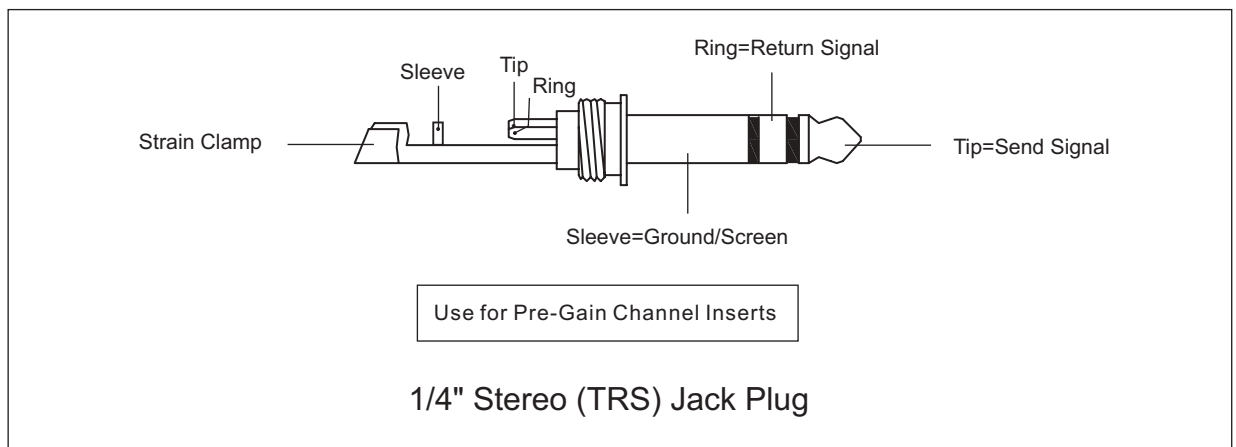
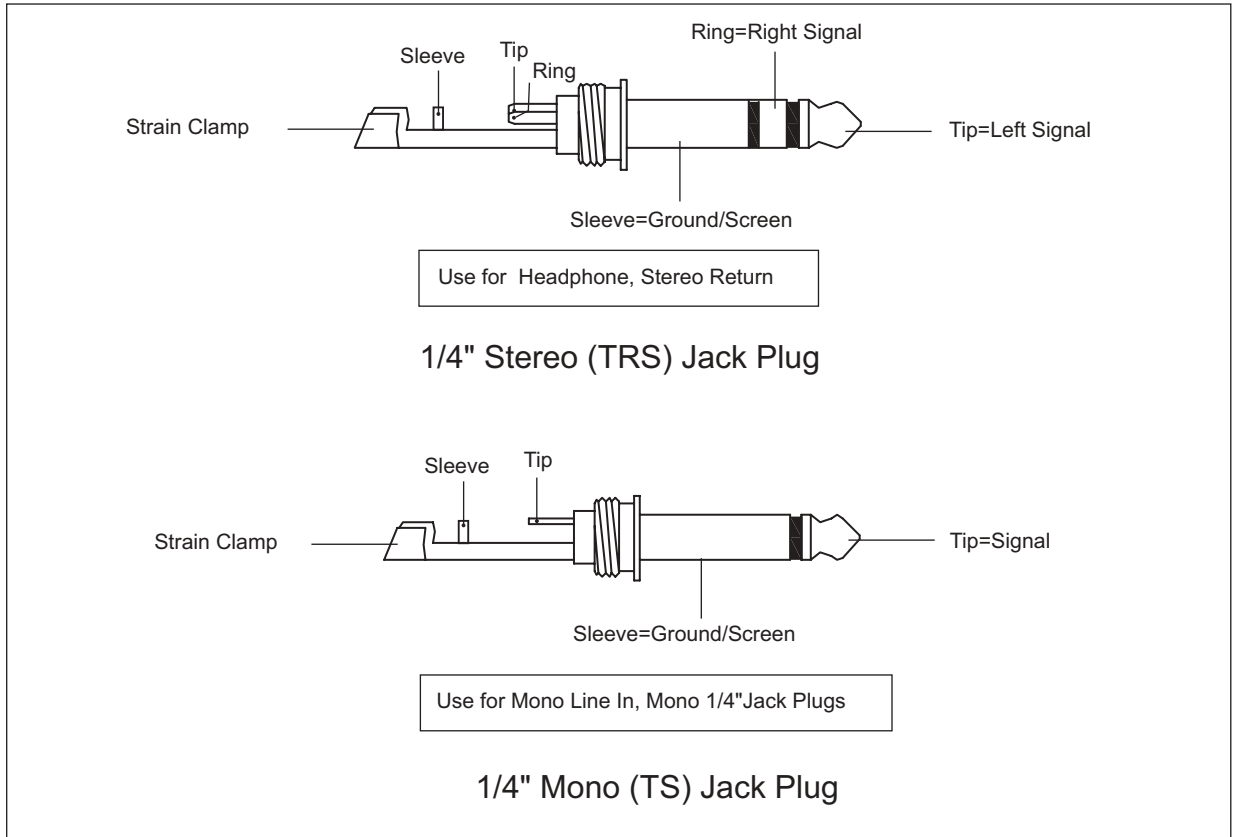

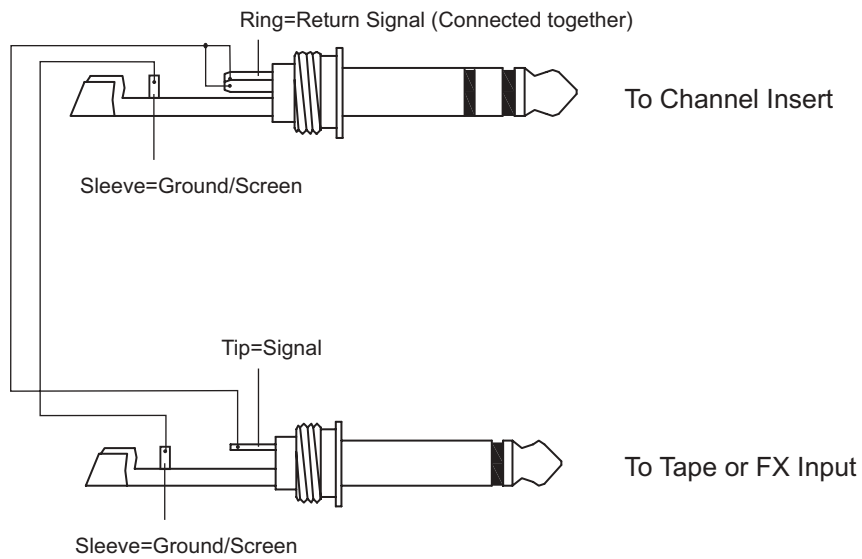

**'Tapped' Connection Direct Output Lead**

(Enables the Insert to be used as a Direct Output while maintaining the channel signal flow)

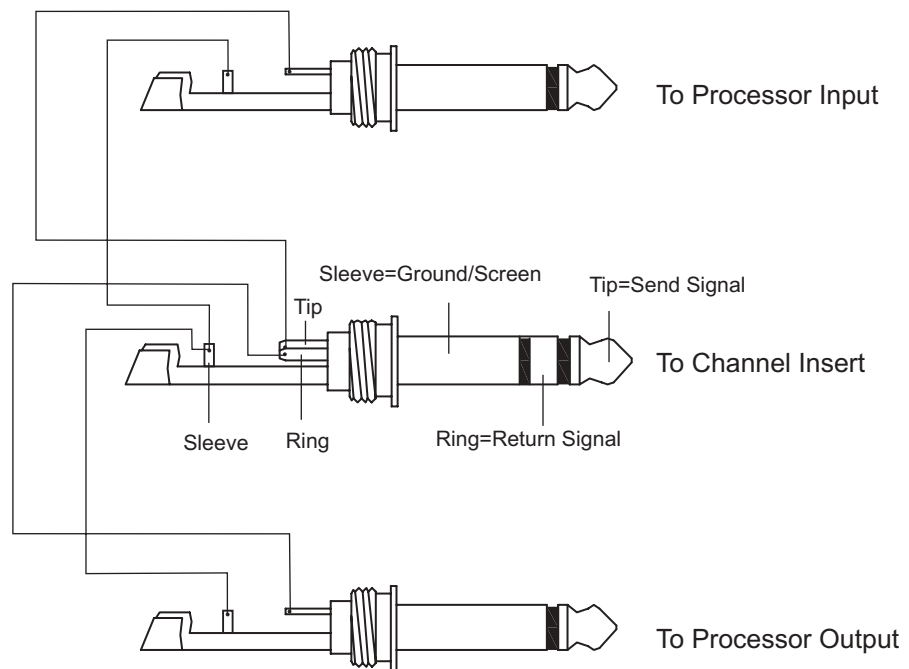

**Y -Stereo lead for insert Connection**

(To be used when the processor does not employ a single jack connection for the In/Out Connections)

## 6. FOR THE EXPERTS WHO WANT TO KNOW MORE

As we have told you previously in this Manual, the Aux Send 2 Control both on Mono and stereo channels is factory wired as POST-FADER. If you have some skill in electronic components soldering you can modify this setting and have all your AUX sends configured as PRE-FADER.

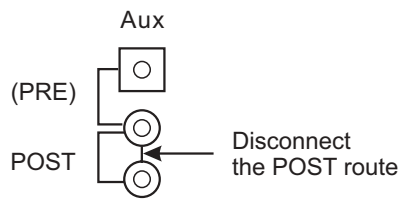

**Before**

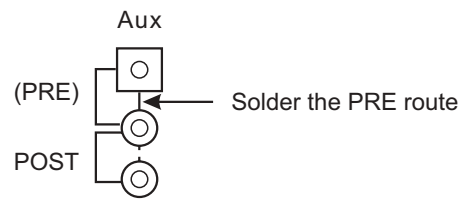

**After**

**Modification on mono and stereo channels**

# 7. SYSTEM BLOCK DIAGRAMS

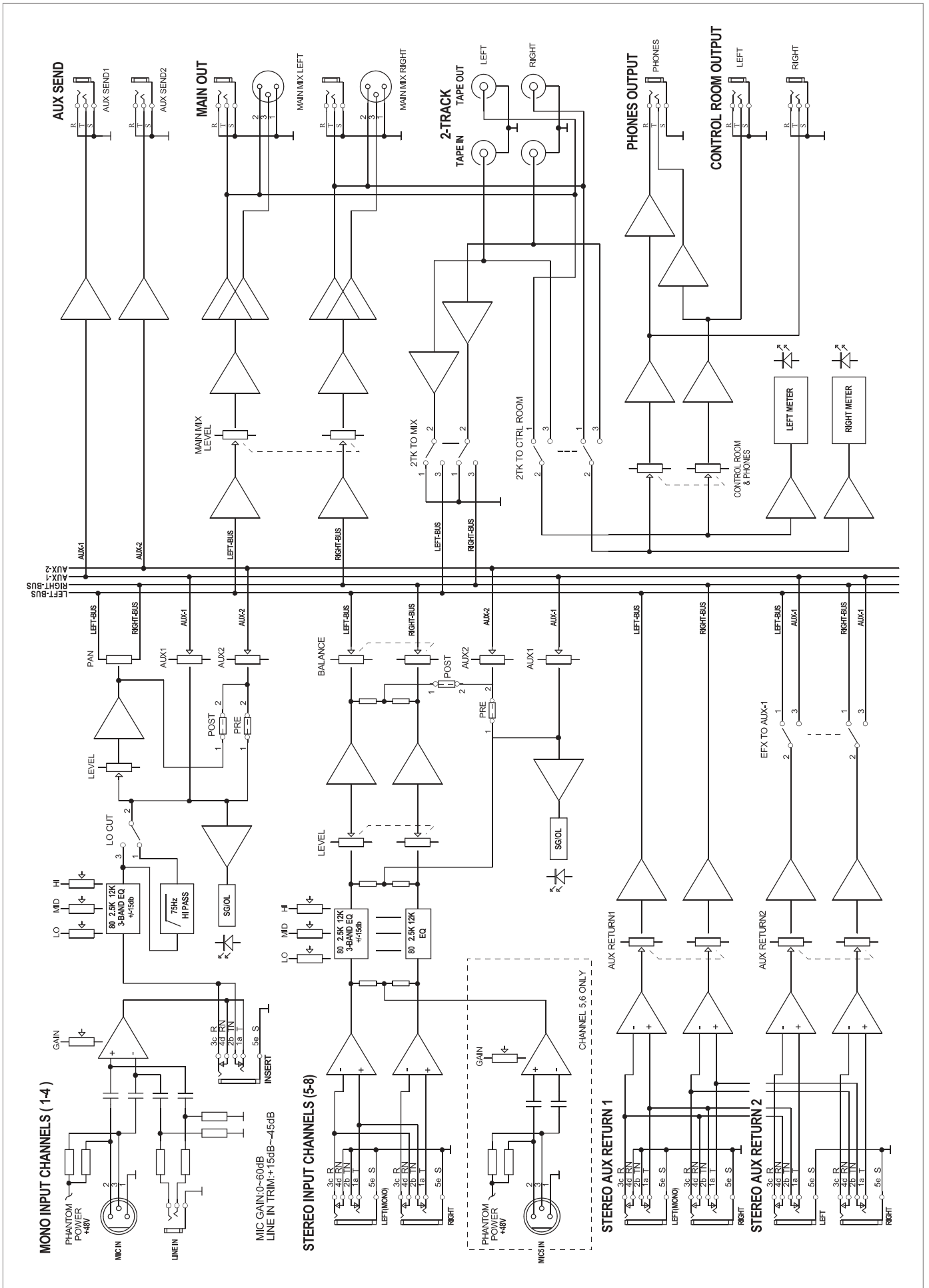

## 8. TECHNICAL SPECIFICATION

<b>Mono input channels</b>		
	Microphone input	electronically balanced, discrete input configuration
	Frequency response	10Hz to 55kHz, +/- 3dB
	Distortion (THD & N)	0.005% at +4dBu, 1kHz
	Gain range	0dB to 60dB (MIC)
	SNR (Signal to Noise Ratio)	115dB
	Line input	electronically balanced
	Frequency response	10Hz to 55kHz, +/- 3dB
	Distortion (THD & N)	0.005% at +4dBu, 1kHz
	Sensitivity range	+15dBu to - 45dBu
<b>Stereo input channels</b>		
	Line input	Balanced
	Frequency response	10Hz to 55kHz, +/- 3dB
	Distortion (THD & N)	0.005% at +4dBu, 1kHz
<b>Impedances</b>		
	Microphone input	1.4kOhm
	Channel Insert return	2.5kOhm
	All other inputs	10kOhm or greater
	Tape out	1kOhm
	All other output	120Ohm
<b>Equalization</b>		
	Hi shelving	+/- 15dB @12kHz
	Mid bell	+/- 12dB @2.5kHz
	Low shelving	+/- 15dB @80Hz
	Low Cut filter	75Hz, 18dB/oct.
<b>Main Mix Section</b>		
	Noise (Bus noise)	Fader 0 dB, channels muted: - 100dBr (ref.:+4dBu) Fader 0dB, all input channels assigned and set to UNITY gain: - 90dBr (ref.:+4dBu)
	Max output	+22dBu balanced XLR, +22dBu unbalanced, 1/4" jacks
	AUX Return gain range	-∞ to +15dB
	AUX Sends max out	+22dBu
<b>Power supply</b>		
	Main voltage	USA/Canada 100 - 120V~, 60Hz Europe 210 - 240V~, 50Hz U.K./Australia 240V~, 50Hz
	Power Consumption	18W
	Fuse	100- 120V~ : T500mAL 210 - 240V~ : T250mAL
	Main connection	Standard IEC receptacle
<b>Physical</b>		
	Dimension (W × D × H)	245mm × 268mm × 24/73mm (9.64" × 10.54" × 0.94"/2.87")
	Net weight	2.4Kg (5.29lb)
	Shipping weight	3.5Kg (7.72lb)

## 9. WARRANTY

### 1. WARRANTY REGISTRATION CARD

To obtain Warranty Service, the buyer should first fill out and return the enclosed Warranty Registration Card within 10 days of the Purchase Date.

All the information presented in this Warranty Registration Card gives the manufacturer a better understanding of the sales status, so as to purport a more effective and efficient after-sales warranty service.

Please fill out all the information carefully and genuinely, miswriting or absence of this card will void your warranty service.

### 2. RETURN NOTICE

2.1 In case of return for any warranty service, please make sure that the product is well packed in its original shipping carton, and it can protect your unit from any other extra damage.

2.2 Please provide a copy of your sales receipt or other proof of purchase with the returned machine, and give detail information about your return address and contact telephone number.

2.3 A brief description of the defect will be appreciated.

2.4 Please prepay all the costs involved in the return shipping, handling and insurance.

### 3. TERMS AND CONDITIONS

3.1 ▲LTO warrants that this product will be free from any defects in materials and/or workmanship for a period of 1 year from the purchase date if you have completed the Warranty Registration Card in time.

3.2 The warranty service is only available to the original consumer, who purchased this product directly from the retail dealer, and it can not be transferred.

3.3 During the warranty service, ▲LTO may repair or replace this product at its own option at no charge to you for parts or for labor in accordance with the right side of this limited warranty.

3.4 This warranty does not apply to the damages to this product that occurred as the following conditions:

- Instead of operating in accordance with the user's manual thoroughly, any abuse or misuse of this product.
- Normal tear and wear.
- The product has been altered or modified in any way.
- Damage which may have been caused either directly or indirectly by another product / force / etc.
- Abnormal service or repairing by anyone other than the qualified personnel or technician.

And in such cases, all the expenses will be charged to the buyer.

3.5 In no event shall ▲LTO be liable for any incidental or consequential damages. Some states do not allow the exclusion or limitation of incidental or consequential damages, so the above exclusion or limitation may not apply to you.

3.6 This warranty gives you the specific rights, and these rights are compatible with the state laws, you may also have other statutory rights that may vary from state to state.

**SEIKAKU TECHNICAL GROUP LIMITED**  
**No. 1, Lane 17, Sec. 2, Han Shi W. Road, Taichung, 401 Taiwan**  
**<http://www.altomobile.com> Tel: 886-4-22313737**  
**email: [info@altomobile.com](mailto:info@altomobile.com) Fax: 886-4-22346757**

All rights reserved to ALTO Mobile. Due to continued development in response to customer feedback, product features, specifications and/or internal/external design may be changed without prior notice. No photocopying, translation or reproduction of any part of this user manual is allowed without prior written permission. Copyright © 2004 Seikaku Technical Group Limited.