

DriveCore Install DA Series Operation Manual

- DCi 8|600DA
- DCi 4|1250DA



Product Registration: Register your new product at <http://warranty.harmanpro.com>.

Obtaining Other Language Versions: To obtain information in another language about the use of this product, please contact your local Crown Distributor. If you need assistance locating your local distributor, please contact Crown at 574-294-8000 or visit www.crownaudio.com.

This manual does not include all of the details of design, production, or variations of the equipment. Nor does it cover every possible situation which may arise during installation, operation or maintenance.

The information provided in this manual was deemed accurate as of the publication date. However, updates to this information may have occurred. To obtain the latest version of this manual, please visit the Crown website at www.crownaudio.com.

Trademark Notice: Com-Tech, BCA, Crown, Crown Audio, Amcron and Multi-Mode are registered trademarks of Crown International. DriveCore, DriveCore Install, IQwic, PIP and PIP2 are trademarks of Crown International. Other trademarks are the property of their respective owners.

Some models may be exported under the name Amcron®

Important Safety Instructions

1. Read these instructions.
2. Keep these instructions.
3. Heed all warnings.
4. Follow all instructions.
5. Do not use this apparatus near water.
6. Clean only with a dry cloth.
7. Do not block any ventilation openings. Install in accordance with the manufacturer's instructions.
8. Do not install near any heat sources such as radiators, heat registers, stoves, or other apparatus (including amplifiers) that produce heat.
9. Do not defeat the safety purpose of the polarized or grounding-type plug. A polarized plug has two blades with one wider than the other. A grounding-type plug has two blades and a third grounding prong. The wide blade or the third prong are provided for your safety. If the provided plug does not fit into your outlet, consult an electrician for replacement of the obsolete outlet.
10. Protect the power cord from being walked on or pinched, particularly at plugs, convenience receptacles, and the point where they exit from the apparatus.



11. Use only with the cart, stand, tripod, bracket, or table specified by the manufacturer, or sold with the apparatus. When a cart is used, use caution when moving the cart/apparatus combination to avoid injury from tip-over.
12. Unplug this apparatus during lightning storms or when unused for long periods of time.
13. Refer all servicing to qualified service personnel. Servicing is required when the apparatus has been damaged in any way, such as power-supply cord or plug is damaged, liquid has been spilled or objects have fallen into the apparatus, the apparatus has been exposed to rain or moisture, does not operate normally, or has been dropped.
14. Use the mains plug to disconnect the apparatus from the mains.
15. WARNING: TO REDUCE THE RISK OF FIRE OR ELECTRIC SHOCK, DO NOT EXPOSE THIS APPARATUS TO RAIN OR MOISTURE.
16. "DO NOT EXPOSE THIS APPARATUS TO DRIPPING OR SPLASHING AND ENSURE THAT NO OBJECTS FILLED WITH LIQUIDS, SUCH AS VASES, ARE PLACED ON THE APPARATUS" AND "NE PAS EXPOSER CET APPAREIL À DES ÉCLABOUSSURES OU GOUTTELETTES D'UN LIQUIDE. AUCUN OBJET REMPLI DE LIQUIDE COMME PAR EXEMPLE UN VASE NE DOIT ÊTRE PLACÉ SUR L'APPAREIL".
17. THE MAINS PLUG OF THE POWER SUPPLY CORD SHALL REMAIN READILY ACCESSIBLE. LA PRISE DU RÉSEAU D'ALIMENTATION DOIT DEMEURER AISÉMENT ACCESSIBLE.



TO PREVENT ELECTRIC SHOCK DO NOT REMOVE TOP COVER. NO USER SERVICEABLE PARTS INSIDE. REFER SERVICING TO QUALIFIED SERVICE PERSONNEL.



TO COMPLETELY DISCONNECT THIS APPARATUS FROM THE AC MAINS, DISCONNECT THE POWER SUPPLY CORD PLUG FROM THE AC RECEPTACLE. POUR DÉCONNECTER COMPLÈTEMENT L'APPAREIL DU RÉSEAU D'ALIMENTATION, DÉCONNECTER LE CORDON D'ALIMENTATION DE LA PRISE MURALE.

WARNING:

- Apparatet må tilkoples jordet stikkontakt.
- Apparaten skall anslutas till jordat uttag.
- Laite on liitettävä suojakoskettimilla varustettuun pistorasiaan.
- Apparatet skal tilsluttes jordet stikkontakt.

WATCH FOR THESE SYMBOLS:



The lightning bolt triangle is used to alert the user to the risk of electric shock.



The exclamation point triangle is used to alert the user to important operating or maintenance instructions.

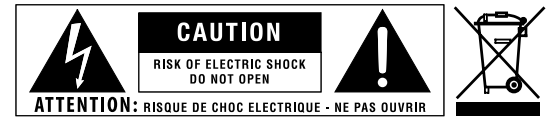

IMPORTANT

Class 2 output wiring permitted.

MAGNETIC FIELD

CAUTION! Do not locate sensitive high-gain equipment such as preamplifiers or tape decks directly above or below the unit. Because this amplifier has a high power density, it has a strong magnetic field which can induce hum into unshielded devices that are located nearby. The field is strongest just above and below the unit.

If an equipment rack is used, we recommend locating the amplifier(s) in the bottom of the rack and the preamplifier or other sensitive equipment at the top.

FCC COMPLIANCE NOTICE

This device complies with part 15 of the FCC rules. Operation is subject to the following two conditions: (1) This device may not cause harmful interference, and (2) this device must accept any interference received, including interference that may cause undesired operation.

CAUTION: Changes or modifications not expressly approved by the party responsible for compliance could void the user's authority to operate the equipment.

NOTE: This equipment has been tested and found to comply with the limits for a Class B digital device, pursuant to part 15 of the FCC Rules. These limits are designed to provide reasonable protection against harmful interference in a residential installation. This equipment generates, uses, and can radiate radio frequency energy and, if not installed and used in accordance with the instruction manual, may cause harmful interference to radio communications. However, there is no guarantee that interference will not occur in a particular installation. If this equipment does cause harmful interference to radio or television reception, which can be determined by turning the equipment off and on, the user is encouraged to try to correct the interference by one or more of the following measures:

- Reorient or relocate the receiving antenna.
- Increase the separation between the equipment and receiver.
- Connect the equipment into an outlet on a circuit different from that to which the receiver is connected.
- Consult the dealer or an experienced radio/TV technician for help.

Declaration of Conformity

Manufacturer:
HARMAN International
 1718 West Mishawaka Road
 Elkhart IN 46517 USA
 ☎ +1.574.294.8000

European Representative:
HARMAN International
 Salisbury House
 London Wall
 ☎ +44 207 562 9450

Brand: Crown
Equipment Type: Commercial Audio Power Amplifiers
Family Name: DCi DA Family
Model Names: 4|1250, 8|600

We, Harman International, declare under our sole responsibility that the product, to which this declaration relates, is in conformity with the relevant Union harmonizes legislation:

2014/35/EU	Low Voltage Directive (LVD)
2014/30/EU	Electromagnetic compatibility directive (EMCD)
2009/125/EC	as amended by 2012/27/EU Ecodesign directive (ErP)
2011/65/EU	Restriction of the use of certain hazardous substances (RoHS)
2012/19/EU	Waste electrical and electronic equipment directive (WEEE)
1907/2006/EC amended by 2015/282/EU	Registration, evaluation and authorization of chemicals (REACH)

The following harmonized standards and technical specifications have been applied:

EMC Standards:	Description
EN 55032:2015, CISPR 32:2015	EMC Compatibility of multimedia equipment – Emissions requirements
EN 55022:2010 +AC:2011	Limits and Methods of Measurement of Radio Disturbance Characteristics of ITE: Radiated, Class B Limits; Conducted, Class B
EN 55103-2:2009	EMC Compatibility – Product Family Standard for Audio, Video, Audio-Visual and Entertainment Lighting Control Apparatus for Professional Use, Part 2: Immunity
EN 61000-3-2:2014	Limits for Harmonic Current Emissions (equipment input current less than or equal to 16A
EN 61000-3-3:2013	Limitation of Voltage Fluctuations and Flicker in Low-Voltage Supply systems Rated Current less than or equal to 16A
EN 61000-4-2:2009	Electrostatic Discharge Immunity (Environment E2-Criteria B, 4k V Contact, 8k V Air Discharge)
EN 61000-4-3:2006+ A2:2010	Radiated, Radio-Frequency, EMC Immunity (Environment E2, Criteria A)
EN 61000-4-4:2012	Electrical Fast Transient/Burst Immunity (Criteria B)
EN 61000-4-5:2014	Surge Immunity (Criteria B)
EN 61000-4-6:2004	Immunity to Conducted Disturbances Induced by Radio-Frequency Fields (Criteria A)
EN 61000-4-11:2004	Voltage Dips, Short Interruptions and Voltage Variation
Safety Standard:	
EN 60065:2014 8 th Ed	Audio, Video, and Similar Electronic Apparatus – Safety Requirements
UL 60065:2015 8 th Ed	Audio, Video, and Similar Electronic Apparatus – Safety Requirements
CAN/CSA 60065:2016 8 th Ed	Audio, Video, and Similar Electronic Apparatus – Safety Requirements

Copies of all technical documentation can be obtained by contacting Sue Whitfield at sue.whitfield@harman.com.

October 21, 2016
 Elkhart, Indiana, USA

Jeff Denman,
 SR. Director, Operations-ABU & SPBU



.....
 (Place and Date of issue)

.....
 (Name, signature and function of authorized person)

Table of Contents

Welcome	1	Advanced Operation	31
Features	1	Introduction	31
How to Use This Manual	1	Amplifier Presets and Speaker Tunings	31
Installation	2	User Presets	31
Unpacking	2	Speaker Tunings	32
Additional Materials	2	Speaker Tuning Panel	32
Installing the Amplifier	2	Speaker Tuning Libraries	33
Proper Cooling	2	Working Library	33
Front Panel Features	3	Channel Levels and Mutes	35
Back Panel Features	3	Software-Controllable Onboard DSP	36
Hardware Setup and Configuration	4	Input Signal Router	37
Wiring Input Connectors	4	Source Routing/Configuration	38
Wiring Output Connectors	4	Input Delay and Driver/Output Delay	39
Connecting Network Cables	5	Input/Output Equalization	39
Connecting to AC Mains	5	Crossover Filters	40
Startup Procedure	5	LevelMax™ Suite	41
Precautions	5	Transducer Thermal Limiter	41
Software Setup	6	Signal Path Block Diagram	42
Configuring the Network using NetSetter	7	Protection System	43
The NetSetter Grid	9	Thermal Indicator	43
Offline/Online Operation Explained	13	Fault	43
Setup and System Configuration	15	Auto Insertion High-Pass Filters	43
Amplifier Mode Settings	15	AC Under/Over Voltage Protection	43
Hi-Z/Low-Z	15	Breaker	43
Cascading Inputs	16	Fan-Cooled Chassis	43
Bridge Mono Operation	17	Universal Switching Power Supply	43
Application Examples	18	Troubleshooting	44
Dual Mode Low-Z (8Ω, 4Ω or 2Ω) Output Operation	18	DCi DA Specifications	47
Bridge Mode Low-Z (16Ω, 8Ω, or 4Ω) Output Operation	19	Dual Mode — All Channels Driven	47
Dual Mode Hi-Z (70Vrms/100Vrms) Mode	20	Bridge Mono Mode — All Channels Driven	47
Bridge Mode Hi-Z (140Vrms/200Vrms)	21	Input Sensitivity	47
General Purpose In/Out Control Port	22	Dimensions	47
Hardware Specification	22	Performance Specifications	48
Configuring the Control Port Inputs	22	AC Power Draw and Thermal Dissipation	49
Software Parameters	22	Warranty (United States Only)	51
Configuring the Control Port Outputs	25	Service	52
Aux Port/Sleep/Amp Status	27	Worldwide Service	52
AUX Port	27	US and Canada Service	52
Sleep	27	Service at a US or Canada Service Center	52
Amp Status	27	Factory Service	52
Dante	28	Factory Service Shipping Instructions	52
Dante Introduction	28	Packing Instructions	53
Dante Specifications	28	Estimate Approval	53
Hardware Configuration	28	Payment of Non-Warranty Repairs	53
Fault Tolerance	28	Service Return Authorization Request	54
Mastership	28		
Dante LED indicators	29		
Dante Routing	29		

Welcome

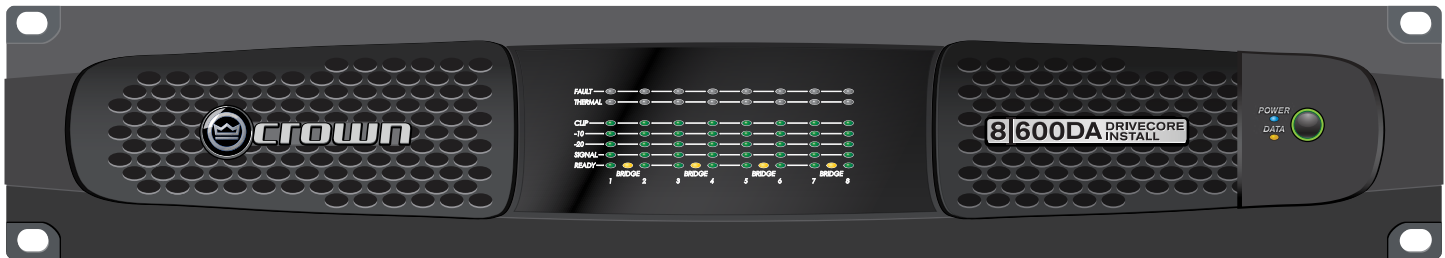

Thank you for purchasing a new Crown DriveCore™ Install DA Series installation amplifier, one in a complete line of high-performance amplifiers based on exclusive DriveCore technology. DriveCore Install DA Series amplifiers are designed, engineered and manufactured to the industry's highest quality standards, and provide system integrators with the advanced features and flexibility required for challenging 21st century installed sound applications. Versatile, compact, and highly energy-efficient, DCi DA Series amplifiers continue the unbroken Crown tradition of leadership in professional and commercial power amplifier technology.

Features

- Exclusive multi-patented DriveCore™ Technology – The patented DriveCore integrated circuit combines hundreds of discrete circuits into one chip for better performance, lower power consumption, and improved reliability.
- Dante™ Digital Audio Transport
- Configuration in HiQnet® Audio Architect™
- Programmable General Purpose Input/Output Control Port
- Digital Signal Processing (Input/Output EQ Filters, Crossover, Input/Output Delay, LevelMAX™ Limiters)
- Priority Input Router
- Universal power supply with PFC for reduced current draw and industry-leading efficiency
- Monitoring and Control over TCP/IP
- Real time Continuous Loading Monitoring
- Power Saving Modes – Power consumption in sleep mode is less than 1W.
- Adjustable Auto Standby
- Remote Power Off – Sleep mode activated via AUX port
- 70Vrms/100Vrms Direct Drive – Each channel individually selectable for low-Z or high-Z operation
- Advanced Protection Circuits – Amplifier and loads are protected against shorted outputs, DC, mismatched loads, overheating, over/under-voltage, and high-frequency overload
- Three Year, No-Fault Transferable Warranty – Your investment is fully protected
- Complies with GreenEdge™ by HARMAN – Environmentally friendly practices in design, manufacturing, and packaging complement energy-efficient operation

How to Use This Manual

This manual provides you with the necessary information to safely and correctly setup and operate your Crown product. It does not cover every aspect of installation, setup, or operation that might occur under every condition. For additional information, please contact technical support, your system installer, or retailer.

We strongly recommend you read all instructions, warnings, and cautions contained in this manual. Also, for your protection, please register your product at www.warranty.harmanpro.com. And save your bill of sale—it's your official proof of purchase.

Installation

Unpacking

Unpack your amplifier and inspect for any damage that may have occurred during transit. If damage is found, notify the shipping company immediately. Only you can initiate a claim for shipping damage, though Crown will be happy to help as needed. If the product arrived showing signs of damage, save the shipping carton for the shipper's inspection.

We also recommend that you save all packing materials for use if you ever need to transport the unit. Never ship the unit without the factory carton and packing materials.

Additional Materials

For installation, you will need the following (not supplied):

- Input wiring cables
- Output wiring cables
- Flathead screwdriver
- Phillips screwdriver
- Rack for mounting amplifier (or a stable surface for stacking)
- Category 5e or higher cabling



WARNING: Before you start to set up your amplifier, read and observe the Important Safety Instructions included in the box. These instructions can also be downloaded from the product page at www.crownaudio.com.

Installing the Amplifier



CAUTION: Before you begin, make sure your amplifier is disconnected from the power source.

The DCi DA Series amplifiers are 3.5 in. (8.9 cm) high, 19 in. (48.3 cm) wide, and 17 in. (43.2 cm) deep (See **Figure 1**).

Mount the unit in a standard 19-inch (48.3 cm) equipment rack (EIA RS-310B). You can also place a single amp on a solid, stable surface or stack multiple amps.

NOTE: Amplifiers should be supported at both the front and rear of the rack.

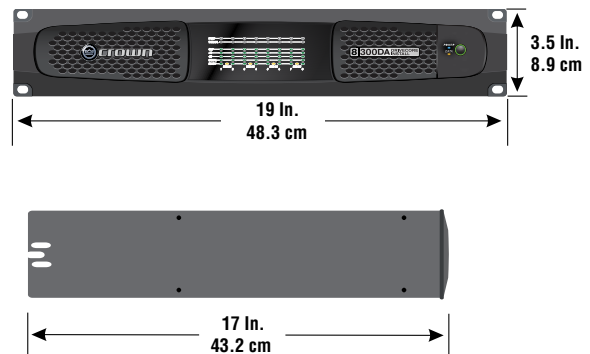

Figure 1: Dimensions

Proper Cooling

When using an equipment rack, mount units directly on top of each other. Close any open spaces in the rack with blank panels. (Open spaces will reduce cooling efficiency.) DO NOT block front or rear air vents.

The rack should be a minimum of two inches (5.1 cm) away from the amplifier, and the back of the rack should be a minimum of four inches (10.2 cm) from the amplifier back panel.

Air flow is front to back as illustrated in **Figure 2**.

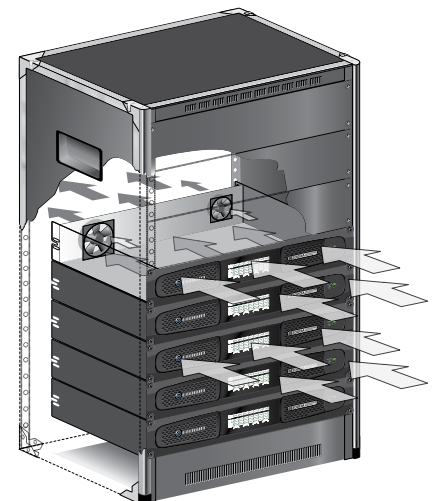

Figure 2: Proper rack venting

Front Panel Features

Indicators:

Fault Indicator (red): Flashes when the amplifier output channel has stopped operating.

Thermal Indicator (red): Illuminates when the channel reaches 80 degrees Celsius, indicating the onset of protection compression. If the temperature continues to rise, the amplifier output will shut off at 98 degrees Celsius and remain off until a safe operating temperature is present.

Clip Indicator (red): Illuminates when any of the following conditions are present: Onset of audible clipping, clipped signal detected at input, clipped signal detected at output, engagement of protection circuits.

Level and Signal Indicators (green): Three LEDs indicate signal presence and level as follows: -10 = 10 dB below rated output, -20 = 20 dB below rated output, Signal = -40dBu input level.

Ready Indicator (green): When this indicator is activated, the amplifier is ready to pass audio.

Power Indicator (blue)

Illuminates when the amplifier is ON and acceptable AC line voltage is present.

Blinks when AC line voltage is outside $\pm 10\%$ range.

Flashes for 4 seconds if Power button pressed when amplifier is in sleep mode.

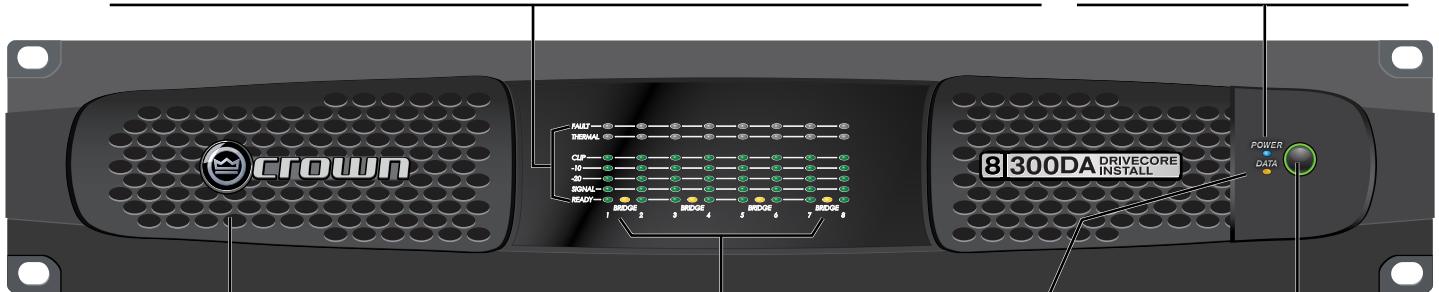

Cooling Vent Grille
Provides cooling air flow. Do not block or cover these vents.

Bridge Mode Indicator (yellow)
Illuminates when Bridge Mode is activated for the channel pair, only odd number channel will be active.

Data Indicator (yellow)
Illuminates when data present on the data network only. Dante connectivity is not a part of this indicator.

Power Button
Power Ring Indicator (Green) - Illuminates when the amplifier is plugged into a wall outlet with acceptable power. NOTE: Power Button is disabled when AUX port Sleep circuit is used.

Note: DCi 8I600DA (8-channel) model shown. Indications per channel pair are identical for 4-channel models.

Back Panel Features

Reset Switch/Circuit Breaker

If the current draw of the amplifier exceeds safe limits, this breaker automatically disconnects the power supply from the AC mains. The switch resets the circuit breaker.

Ethernet*

For monitoring and control of the amplifier over Cat5e wiring through the Audio Architect software.

Dante*

Connect to a Dante audio network using Cat5e or higher wiring. (Cat5 wiring can be used for purely 100Mbps networks.)

Data LED

Data LED indicates HiQNet data activity.

Preset LED

Preset LED blinks successively to indicate preset number (e.g., if the LED blinks 5 times, pauses, then repeats, the amp is on preset 5).

Input Connectors

One 6-pin plug-in connector per input pair. High impedance balanced.

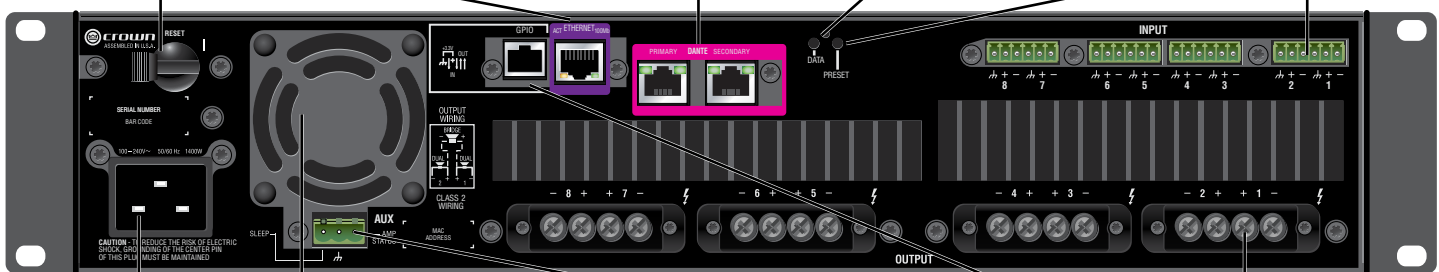

AC Power Inlet
20A IEC inlet for detachable connector; 100–240 V~.

Cooling Fan Outlet
Outlets for cooling air flow. Do not block or cover these outlets.

Auxiliary Connector
3-pin plug-in type connector, Enables SLEEP mode and monitoring of AMP STATUS unless the amplifier is in any of these conditions: OFF, SLEEP, or FAULT.

General Purpose Input/Output (GPIO)
Connect to the amplifier via RJ-11. There are 2 analog input controls and 2 digital output controls.

Output Connectors
One four-pole, touch-proof terminal strip per channel pair. Accepts up to 10 AWG wire or terminal forks.

*Warning: Only connect to networks that remain inside the building.

Note: DCi DA 8I600 (8-channel) back panel shown. 4-channel model has same features but half as many input/output channels.

Hardware Setup and Configuration

Wiring Input Connectors

Crown recommends using pre-built or professionally wired balanced cables (two-conductor plus shield). Balanced wiring provides better rejection of unwanted noise and hum; however, unbalanced line may also be used.

Use 6-pin plug-in cable ends at the amp input connectors. A male connector is supplied for each input of your model of amplifier. Additional connectors are available from Crown (P/N 5024623).

Figure 3 shows connector pin assignments for balanced wiring and **Figure 4** shows connector pin assignments for unbalanced wiring. Note that for bridged operation, only the odd-numbered input channels (1,3,5,7) should be wired for each bridged pair.

For Dante audio connections, standard Category 5e or 6 Ethernet cabling should be used for Gigabit networks. Category 5 cabling can be used for 100Mbps network connections. Primary and Secondary Dante ports are provided; Dante audio traffic is duplicated to both of these ports. The Secondary port can be connected to a second network switch for redundant operation in the event the Primary cable connection or switch is compromised.

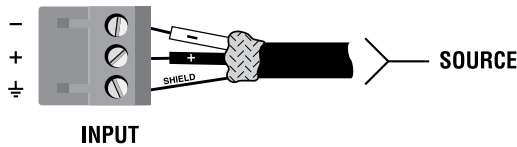

Figure 3: Balanced wiring

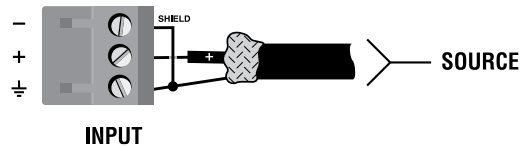

Figure 4: Unbalanced wiring

Wiring Output Connectors

IMPORTANT: The amplifier output mode (Low Z, High Z) should be properly configured for the application before connecting the speakers. By default, all outputs are configured for Low Z operation. See "**Hi-Z/Low-Z**" on page 15 for more information.

Before making any output connections, ensure the power cord is disconnected from the amplifier and carefully review the total impedance for loudspeakers connected to each amplifier output. If multiple loudspeakers are connected to an output in Low Z mode (i.e., in series, parallel, or series-parallel), be certain the total system impedance is within allowed specification for the output. When multiple loudspeakers are connected to one output in High Z mode, be certain total tapped power is below the rated power output for the channel. See "**DCi DA Specifications**" on page 47 for supported load specifications.

NOTE: Crown has designed an output cover that does not need to be removed to connect the output wiring.

Crown recommends using the included spade connectors and two or four-conductor, heavy gauge speaker wire. You may use terminal forks up to 10 AWG or bare wire for your output connectors (see **Figure 5**). For best results, Crown recommends Panduit part #PV10-6LF-L or equivalent terminal fork. For bare wire, it is highly recommended that output wiring is tinned. To reduce strain on input and output wiring, Crown recommends the use of horizontal lacer bars. For best results, Crown recommends Middle Atlantic part# LBP-4R90 or equivalent horizontal lacer bar.

For low-impedance loads, select the appropriate size of wire based on the distance from amplifier to speaker.

Distance	Wire Size
Up to 25 ft. (7.6m)	16 AWG
26-40 ft. (7.9-12.2m)	14 AWG
41-60 ft. (12.5-18.3m)	12 AWG
> 60 ft (18.3m)	10 AWG

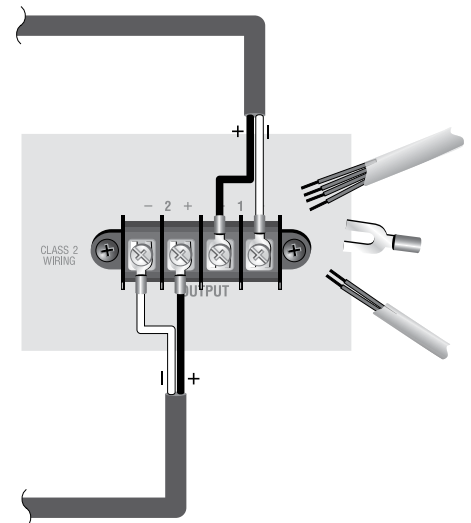

Figure 5: Wiring output connectors

CAUTION: Never use shielded cable for output wiring.

CAUTION: Never connect the speaker return to the chassis of the amplifier, or damage to the amplifier may result.

NOTE: Custom wiring should only be performed by qualified personnel. Class 2 output wiring is required.

For application-specific output connection diagrams, including how to wire outputs for bridge mono operation, see "**Application Examples**" on page 18.

Connecting Network Cables

When making connections to the control network and Dante ports, the included ferrites should be attached to the network and Dante cables at the back of the amplifier as shown in **Figure 6**. Both a small and large ferrite should be attached to each cable as shown.

Connecting to AC Mains

Connect your amplifier to the AC mains power source (power outlet) using the supplied AC power cord set. First, connect the IEC end of the cord set to the IEC connector on the amplifier; then, plug the other end of the cord set to the AC mains.



WARNING: The third prong of this connector (ground) is an important safety feature. Do not attempt to disable this ground connection by using an adapter or other methods.

Make certain the AC mains voltage and current ratings are sufficient to deliver full power to all amplifiers. If the AC line voltage varies out of an acceptable range, the amplifier's power supply turns off and the blue Power LED flashes. The amplifier will turn back on when the AC line voltage returns to safe operating levels.

DriveCore Install DA amplifiers utilize a universal power supply. The AC voltage requirements are 100V-240V~, 50/60Hz (±10%). If the voltage exceeds these requirements, the Power LED will flash and the amplifier will stop passing audio until the voltage is within the requirements.

Startup Procedure

When first turning on your amplifier:

1. Turn down the level of your audio source.
2. Turn on the "Power" switch. The Power indicator should light.
3. Turn down the amplifier levels in Audio Architect, see "**Channel Levels and Mutes**" on page 35.
4. Turn up the level of your audio source to an optimum level. Ensure that at no point in the signal chain is the signal being clipped in any way.
5. In Audio Architect, turn up the amplifier levels to the desired level.

IMPORTANT: Before making any wiring or installation changes, turn off the amplifier and disconnect the power cord.

For help with determining your system's optimum gain structure (signal levels) please refer to the Crown Amplifier Application Guide, available online at www.crownaudio.com.

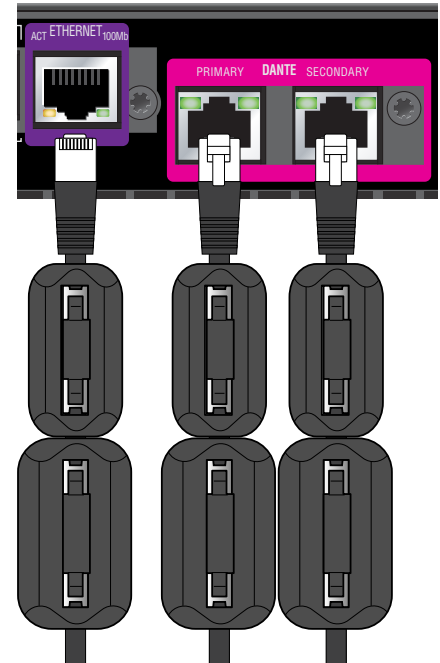



Figure 6: Ferrites attached to network cables

Precautions

Your amplifier is protected from internal and external faults, but you should still take the following precautions for optimum performance and safety:

1. Configure the amplifier for proper operation, including input and output wiring hookup. Improper wiring can result in serious operating difficulties. For information on wiring and configuration, please consult "**Wiring Input Connectors**" and "**Wiring Output Connectors**" on page 4. For advanced setup techniques, consult Crown's Amplifier Application Guide available online at www.crownaudio.com.
2. Use care when making connections, selecting signal sources, and controlling the output level. The load you save may be your own!
3. Do not short the ground lead of an output cable to the input signal ground. This may form a ground loop and cause oscillations.
4.  **Never connect the output to a power supply, battery, or power main. Electrical shock may result.**
5. Tampering with the circuitry or making unauthorized circuit changes may be hazardous and invalidate all agency listings.
6. Do not operate the amplifier with the Clip LEDs constantly flashing.
7. Do not overdrive the mixer, which will cause clipped signal to be sent to the amplifier. Such signals will be reproduced with extreme accuracy, and loudspeaker damage may result.
8. Do not operate the amplifier with less than the rated load impedance. Due to the amplifier's output protection, such a configuration may result in premature clipping and speaker damage.

REMEMBER: Crown is not liable for damage that results from overdriving other system components.

Software Setup

Setup and configuration of the DriveCore Install DA Series amplifiers can be completed through HiQnet Audio Architect™. The amplifier should be connected to a TCP/IP network via the Ethernet connection on the back of the amplifier. Note that the Dante digital audio transport connectors cannot be used for control and monitoring of the amplifier.

To quickly configure your DriveCore Install DA amplifier, connect all of the amplifiers and configuration computer to the same network. For more information on network configuration, please visit <http://audioarchitect.harmanpro.com>. In the following example, we will only show amplifiers.

When Audio Architect is first loaded, the software will scan the network for HiQnet devices. All devices that are discovered on the network will be found under the ADD DEVICES tab on the left hand tree menu. If the devices are not found, then the network may not be configured correctly. See **Figure 7**.

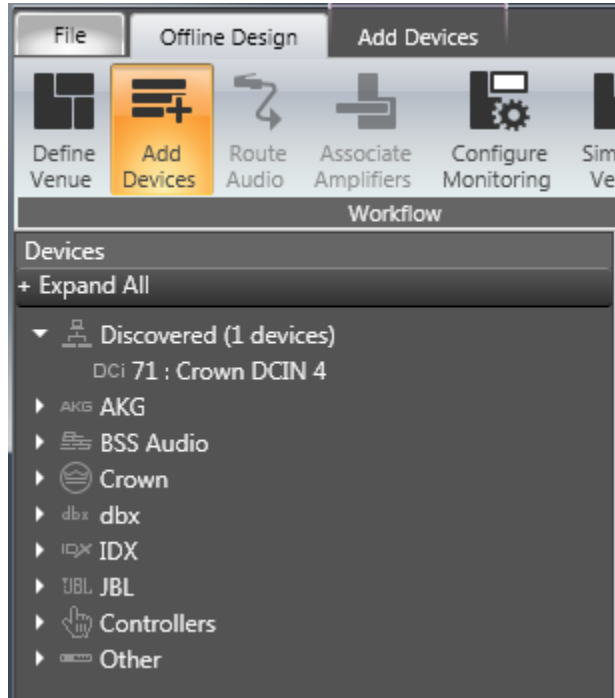

Figure 7: Add Devices tab tree menu

NOTE: Illustrations and some text references are for channel pair 1–2 and 3–4 only. Note that channels 5–6 and 7–8 can be programmed in the same manner, and each channel may be configured independently.

Configuring the Network using NetSetter

NetSetter is a software tool which enables you to discover HiQnet devices and reconfigure their network settings in real time, from one central location. Its function is to configure a system of devices to interoperate correctly on the same network and resolve conflicts quickly and easily. The latest version of NetSetter can be downloaded at www.audioarchitect.harmanpro.com/en-US/software.

The top of the NetSetter window displays overall operational functions that are available. At the bottom of the NetSetter window is an informational section that lists the number of discovered devices and the IP address of the DHCP server (if available). There is also information regarding the PC HiQnet Address, IP Address, and Subnet Mask.

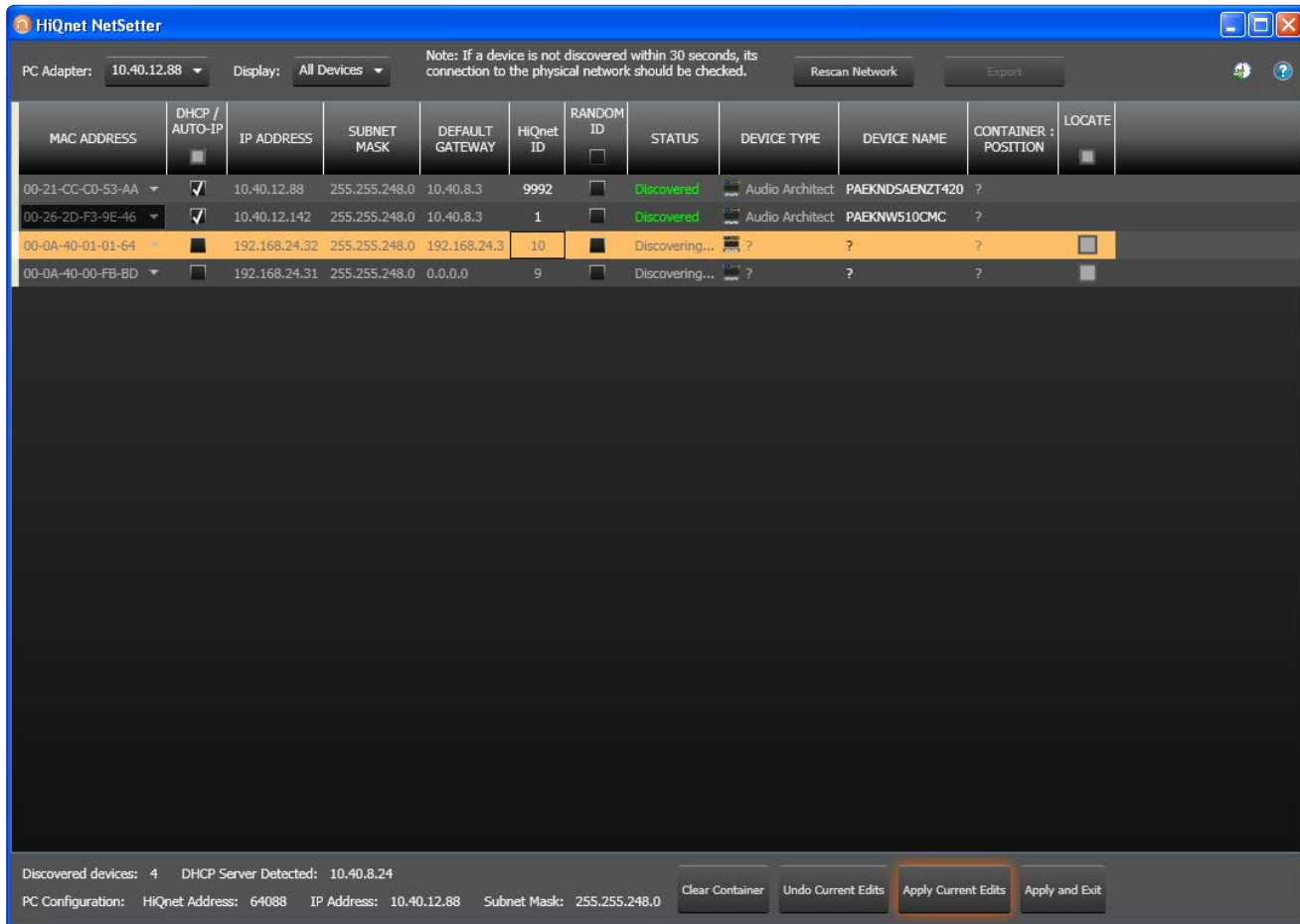

Figure 8: NetSetter window

1. PC Adapter

Use this dropdown menu to select the Network Interface Card (NIC) that NetSetter will use to attempt to discover HiQnet devices. All available NIC's are listed by IP Address. Selecting a new NIC will force a rescan of the network to which the new NIC is connected.

2. Display

The options available in this dropdown menu will filter the device list as follows:

a. All Devices

This is the default setting. All discovered devices are displayed.

b. HiQnet ID conflicts

Only discovered devices with HiQnet address conflicts are displayed.

c. IP address conflicts

Only discovered devices with IP address conflicts are displayed.

d. All conflicts

Only discovered devices with either HiQnet address conflicts or IP address conflicts are displayed.

e. Locked

Only devices in a Locked configuration will be displayed.

f. Discovering

Only devices in the process of being discovered will be displayed.

g. Discovered

Only discovered devices with no conflicts will be displayed.

h. DHCP/Auto-IP

All devices which have been discovered with DHCP/Auto-IP enabled and those which have been set to use DHCP/Auto-IP on applying the edits are displayed.

3. Rescan Network

Clicking this button re-scans the network to which the currently selected NIC is connected.

4. Export

Clicking this button brings up a "Save As" window, allowing you to save the HiQnet Addresses and IP Configurations of all devices on the network as a .CSV (Comma Separated Values) formatted file. This allows you to archive the information and open it in a spreadsheet program such as Microsoft® Excel®.

5. Proxies

This feature is used to connect to devices that cannot automatically be located by Audio Architect due to network configuration or security measures via proxy connections.

6. Static Routes

This feature is used to set up a static route and connect directly to a device located on a different subnet than the PC.

7. Clear Container

Resets the Container/Position Venue data of the selected device. The action occurs on either "Apply Current Edits" or "Apply and Exit" so that changes may be undone with the **Undo Current Edits** button.

8. Undo Current Edits

Resets any open edits in the grid to the values as currently on the network.

9. Apply Current Edits

Confirms any open edits in the grid. Devices update accordingly until connection is re-established with HiQnet NetSetter.

10. Apply and Exit

Confirms and saves any open edits in the grid. Devices update accordingly until connection is re-established with HiQnet.

NOTE: If you have made changes to NetSetter and attempt to exit the program, the confirmation window shown in **Figure 9** will appear. Clicking **OK** will apply the edits you have made since opening NetSetter. Clicking **Cancel** will return you to the program.

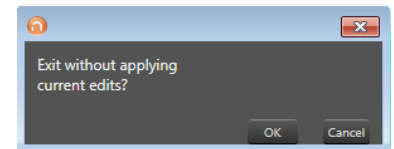

Figure 9: Confirmation window

The NetSetter Grid

The NetSetter grid is divided into the 12 sections described below.



Figure 10: NetSetter grid

1. MAC Address

Displays the MAC address of the discovered device. The data in this field cannot be edited.

NOTE: If more than one MAC address is discovered for a single device (e.g., HiQnet device MAC address, Dante card MAC address, etc.), the field will be represented as a dropdown menu and the desired MAC address can be selected from the list. For a device connected to the same control network with two control MAC addresses, the MAC address field will be displayed in red.

2. DHCP/Auto-IP

If the discovered device is configured to use DHCP/Auto-IP, this checkbox will be checked. If the discovered device is not using DHCP/Auto-IP, you may check the box so it will do so on applying edits. The device row will then become selected. The device will attempt to have its IP settings configured by DHCP on applying the edits; if no DHCP server is present, the device will attempt to have IP settings configured by Auto-IP.

All devices in the current filter view may be configured with DHCP/Auto-IP enabled by checking the checkbox in the column header—the individual checkboxes for all devices will become checked. If a single individual checkbox for a device is subsequently unchecked, the column header DHCP/Auto-IP checkbox will be automatically unchecked. Conversely, all devices in the current filter view can be configured with DHCP/Auto-IP disabled by unchecking the checkbox in the column header.

DHCP server status will be among the information displayed at the bottom of the NetSetter window. If a DHCP server is not detected, the information will read "DHCP server not detected". Note that checking a device's DHCP/Auto-IP checkbox has no immediate effect on the column sort order.

NOTE: Once edits have been made, it is critical to click the **Apply Current Edits** or **Apply and Exit** buttons for the changes to take affect.

3. IP Address

Displays the IP address of the discovered device. A valid IP address may be edited inline. If the edited value scopes the device out of the current Display filter, it will not be visible.

NOTE: A discovered device with an IP address that conflicts with that of another, already discovered device will be displayed in red. A conflicting IP address may be edited inline if you wish to change the device IP address on applying current edits. If DHCP/Auto-IP is enabled, the IP address field may not be edited inline.

NOTE: Once edits have been made, it is critical to click the **Apply Current Edits** or **Apply and Exit** buttons for the changes to take affect.

4. Subnet Mask

Displays the Subnet Mask of the discovered device. The Subnet Mask may be edited inline. The device row will be ordered accordingly with the current column sort immediately on successful editing of the field. The device row will remain selected.

NOTE: If DHCP/Auto-IP is enabled, the Subnet Mask field may not be edited inline.

NOTE: Once edits have been made, it is critical to click the **Apply Current Edits** or **Apply and Exit** buttons for the changes to take affect.

5. Default Gateway

Displays the Default Gateway of the discovered device. The Default Gateway may be edited inline. The device row will be ordered accordingly with the current column sort immediately on successful editing of the field. The device row will remain selected.

NOTE: If DHCP/Auto-IP is enabled, the Default Gateway field may not be edited inline.

If the device is being rediscovered, then the following behavior will occur:

- When the device is not selected, the device Default Gateway address field is displayed but is grayed out.
- When the device is selected and highlighted in orange, the field is represented in dark gray.

NOTE: Once edits have been made, it is critical to click the **Apply Current Edits** or **Apply and Exit** buttons for the changes to take affect.

6. Device ID

Displays the HiQnet address of the discovered device. This field may be edited inline if you want to change the device HiQnet address. If the edited value scopes the device out of the current Display filter, it will not be visible and no devices will be selected. If devices are discovered with a conflicting HiQnet address, then the following will occur:

- The HiQnet ID field of a discovered device will be displayed in pink when a HiQnet address conflicts with that of another, already discovered HiQnet address.
- When the device is selected and highlighted in orange, the field is represented in red.
- The HiQnet address is not displayed, instead a dash is displayed as grayed out.

NOTE: A conflicting HiQnet address may be edited inline if you want to change the device HiQnet address.

NOTE: Devices are not discoverable at the IP level. A device which is not discoverable at the IP level (invalid IP address, etc.) will not be able to report a HiQnet address. In this instance, the HiQnet ID field will display a "?" to indicate that the field may exist but that the software does not have enough discoverability of the device to determine the value. A blank field or "-" implies the value is null and the HiQnet ID field may not be edited inline.

NOTE: Once edits have been made, it is critical to click the **Apply Current Edits** or **Apply and Exit** buttons for the changes to take affect.

7. Random ID Reboot

When enabled, the device will be given a random HiQnet address. If you want to set the HiQnet address of a device to a random ID, check the Random ID checkbox. If the checkbox is unchecked before applying current edits, the prior HiQnet ID value will be restored.

All devices in the current filter view may be set to Random HiQnet ID by checking the checkbox in the column header—the individual checkboxes for all devices will become checked. If any individual checkbox is subsequently unchecked, the column header Random ID checkbox will automatically be unchecked. Conversely, if all devices in the current filter view are set to Random ID on and the Random HiQnet ID column header checkbox is checked, all devices may be set to Random ID off by unchecking the column header checkbox—the individual checkboxes for all devices will become unchecked.

NOTE: Devices are not discoverable at the IP level. A device which is not discoverable at the IP level (invalid IP address, etc.) will not be able to report a HiQnet address. In this instance, the Random ID checkbox will be unavailable.

8. Status

Displays the current discovery status of the device. The Status field may not be edited. Discovery status hierarchy is as follows:

a. Discovered

If a device has a unique IP address and a unique HiQnet address, this condition will be shown unless the device is access controlled. When the device is not selected, the "Discovered" label is represented in green.

The "Discovered" status is determined by the following conditions:

- The device is discoverable at the MAC address level.
- The device has a valid and unique IP address (manual or DHCP/Auto-IP).
- The device has a unique HiQnet address.
- The device is not access controlled.

b. IP Conflict

If a device has an IP address conflict, this error will be shown regardless of other status notifications. When the device is not selected, the "IP conflict" label is represented in blue.

The "IP conflict" status is determined by the following conditions:

- The device is discoverable at the MAC address level.
- The device has an IP address that conflicts with another device which has already been discovered by NetSetter.

c. HiQnet Conflict

If a device has a unique IP address yet has a HiQnet address conflict, this error will be shown regardless of other status notifications. When the device is not selected, the "HiQnet conflict" label is represented in red.

The "HiQnet conflict" status is determined by the following conditions:

- The device is discoverable at the MAC address level.
- The device has a valid and unique IP address (manual or DHCP/Auto-IP).
- The device has a HiQnet address that conflicts with another device which has already been discovered by NetSetter.

d. Locked

If a device has a unique IP address and a unique HiQnet address, this condition will be shown if the device is access controlled. When the device is not selected, the "Locked" label is represented in yellow.

The "Locked" status is determined by the following conditions:

- The device is discoverable at the MAC address level.
- The device has a valid and unique IP address (manual or DHCP/Auto-IP).
- The device has a unique HiQnet address.
- The device is access controlled.

When a device has been discovered in a Locked state and any field is attempted to be edited for the first time, a dialog prompting for the Admin password will appear. Only a successful login with the Admin password will enable all fields to be edited. This state may need to be reset on rediscovery after applying current edits, requiring the Admin password to be entered again.

e. Discovering

This condition will be displayed if the device has had changes made to its IP configuration or HiQnet address and HiQnet NetSetter is waiting to re-establish connection. When a device being rediscovered is not selected, all fields within the device row are displayed but grayed out.

The "Discovering" status is determined by the following conditions:

- The device had been previously discovered at the MAC address level.
- Edits had been made to one or more fields.
- The device is being rediscovered after applying current edits.

NOTE: Since the sort order automatically updates when a field within the sorted column is updated, the rediscovered device will occupy the same row on rediscovery. The exception is when DHCP/Auto-IP or Random ID has been set prior to applying current edits, in which case the rediscovered device will occupy the appropriate row in the current column sort order.

9. Device Type

The device class name is displayed here, as reported by the discovered device. To the left of each device class name, the brand icon is displayed. The software application name is displayed for discovered PCs running an instance of HiQnet software. HiQnet software programs include System Architect, Audio Architect, and Performance Manager.

NOTE: The Device Type field may not be edited inline.

NOTE: Devices are not discoverable at the IP or HiQnet level. A device which is not discoverable at the IP level (invalid IP address, etc.) or HiQnet address level (HiQnet address conflict, etc.) will not be able to report its class name. In this instance, the Device Type field will display a "?" to indicate that the field may exist but that the software does not have enough discoverability of the device to determine the value. A blank field or "-" implies the value is null.

10. Device Name

The user-definable Device Name is displayed here, as reported by the discovered device.

NOTE: This field may be edited inline if you want to change the Device Name. This field may not be edited for discovered PCs running an instance of HiQnet software.

NOTE: Devices are not discoverable at the IP or HiQnet level. A device which is not discoverable at the IP level (invalid IP address, etc.) or HiQnet address level (HiQnet address conflict, etc.) will not be able to report its Device Name. In this instance, the Device Name field will display a "?" to indicate that the field may exist but that the software does not have enough discoverability of the device to determine the value. A blank field or "-" implies the value is null.

NOTE: Once edits have been made, it is critical to click the **Apply Current Edits** or **Apply and Exit** buttons for the changes to take affect.

11. Container : Position

The Container and Position Venue Data is displayed here (separated by a colon), as reported by the discovered device. The field is left blank for discovered PCs

running an instance of HiQnet software. HiQnet software programs include System Architect, Audio Architect, and Performance Manager.

TIP: A selected device may have its Venue Data cleared (including all Building, Floor, and Room Venue data) by pressing the **Clear Container** button. This action takes place on applying current edits only and can be undone with the **Undo Current Edits** button.

NOTE: The Container/Position Venue Data may not be edited inline.

NOTE: Devices are not discoverable at the IP or HiQnet level. A device which is not discoverable at the IP level (invalid IP address, etc.) or HiQnet address level (HiQnet address conflict, etc.) will not be able to report its Container : Position data. In this instance, the Container : Position field will display a "?" to indicate that the field may exist but that the software does not have enough discoverability of the device to determine the value. A blank field or "-" implies the value is null.

12. Locate

The Locate feature allows a device to be easily identified within a network full of HiQnet devices. Clicking in the Locate column for a device will put the corresponding networked device into a Locate state—the Locate icon will be displayed on-screen and something will happen on the device to indicate the Locate state is active (e.g., an LCD or LED will flash, etc.). Clicking an active Locate icon will disable the Locate state for the device. Disabling the Locate state from the device will clear the icon. Devices may be put into a Locate state independently from selection so that more than one device can be located at any one time.

Offline/Online Operation Explained

Audio Architect has two define modes of operation: Offline and Online. Offline operation allows the system to be configured without real time changes to the system. In this mode, changes have to be sent to the edited device. In Online mode, changes to amplifiers are made real time.

When Audio Architect first opens, the Offline Design Tab is the ribbon presented, and the Device Toolbox appears on the left and an empty Properties window is at the bottom. The Add Devices box is highlighted. When going Online, it may be necessary to Match Devices and/or Synchronize Venue.

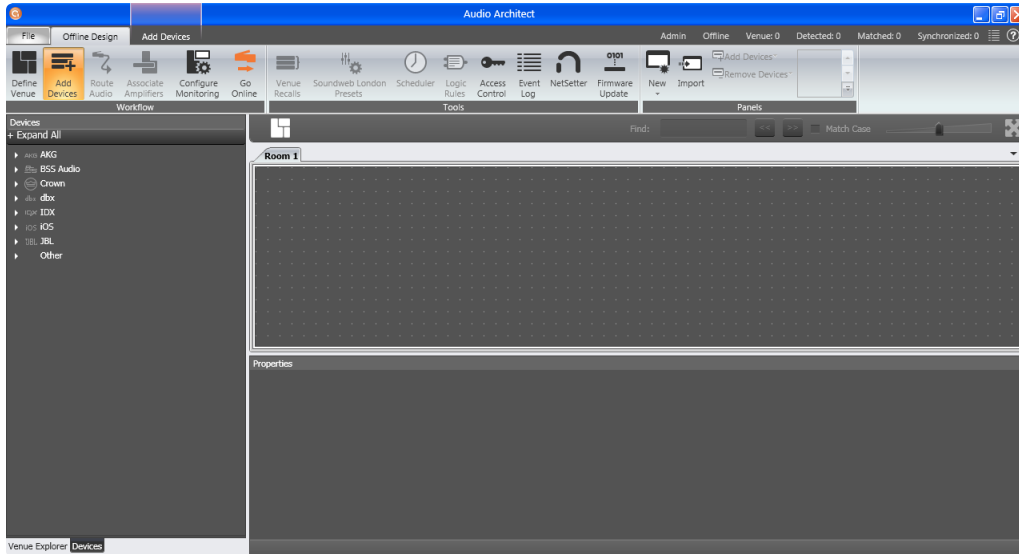

Figure 11: Main Audio Architect window

Match Devices allows users to associate amplifiers within their venue design to amplifiers on the network.

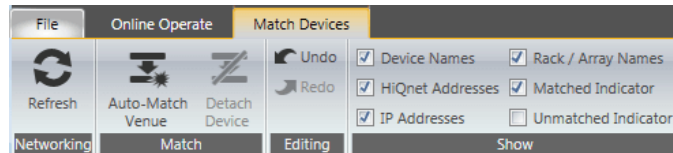

Figure 12: Match Devices ribbon

In the Match Devices tab, the following options are available:

- Networking**
 Clicking the **Refresh** button will temporarily take Audio Architect offline, then restart the network.
- Match**
 Clicking the **Auto-Match Venue** button will automatically match devices on the network with the devices in the Audio Architect venue. Selecting a device then clicking the **Detach** button removes the device's virtual connection with Audio Architect.
- Editing**
 Clicking the **Undo** button will undo the last change made and revert back to the previous state. Clicking the **Redo** button will redo the last action that was undone.
- Show**
 Any checked items in this section will be displayed alongside the appropriate devices in the Main Audio Architect window. The available items include Device Names, Rack/Array Names, HiQnet Addresses, IP Addresses, Matched Indicator, and Unmatched Indicator.

When going Online, the following options are possible:

- If one or more devices in the Venue are not matched AND corresponding devices are available on the network, going online lands in Match Devices mode.
- If all the devices in the Venue are matched, going online lands in Synchronize Venue mode. In Synchronize Venue mode, the user is given the option to either Send data from Audio Architect to the device or Receive data from the device to Audio Architect.
- If no devices require to be synced, going online lands in Run Venue mode.

Each amplifier can be dragged into the room window. Each device will have an IP address listed on the left of the amplifier and a Name ID on the right of the amplifier. The Name ID can be edited in the properties menu at the bottom of the window. The number to the left of Name ID is the HiQNet Device Address. The green circle only indicates that the amplifier has been discovered on the network.

The small box located below the rack allows quick access to amplifier factory panels. These panels include the following items:

- Factory Master Panels
- Monitor Panels
- Meter Panels
- Level and Mute Panels

NOTE: When a device is added to the window, it is automatically removed from the "Discovered" section.

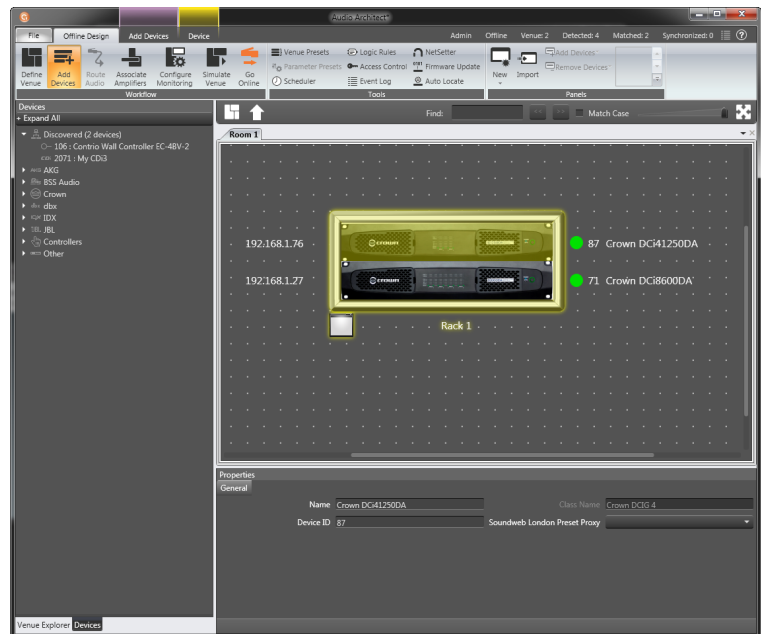

Figure 13: Device information

Double clicking an amplifier will access the amplifier factory control panel. At this point, Audio Architect is in OFFLINE MODE. In OFFLINE MODE, amplifier changes are not made in real time and will need to be sent to the amplifiers. Amplifier changes can also be sent in real time in ONLINE MODE. To go to ONLINE MODE, click on the GO ONLINE tab in the Workflow bar menu. RECEIVE and SEND buttons will appear for each device, rack, and room in the design. This gives the user the option to just update a single device, all devices in a rack or an entire venue. Click SEND to load the settings made in Audio Architect to the amplifier. Click RECEIVE to read the settings off of the amplifier to be reflected in Audio Architect.

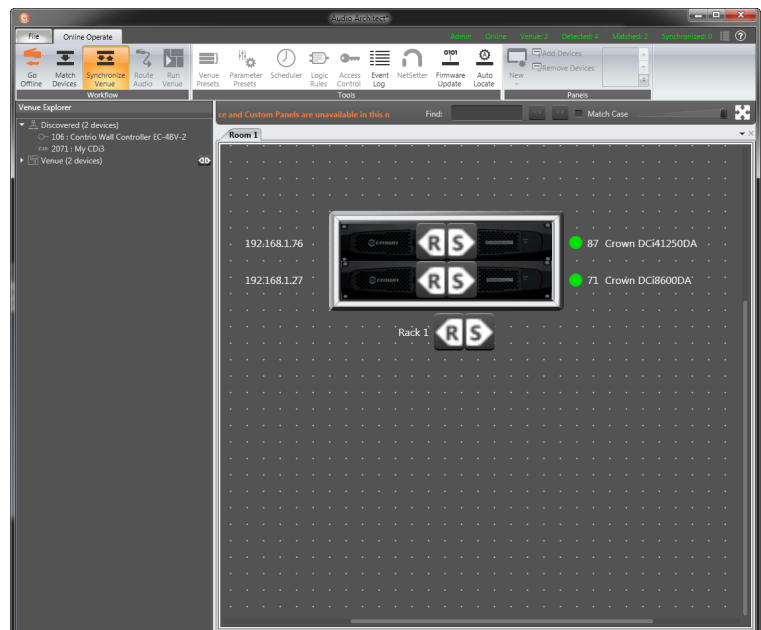

Figure 14: Send and Receive icons

Setup and System Configuration

Amplifier Mode Settings

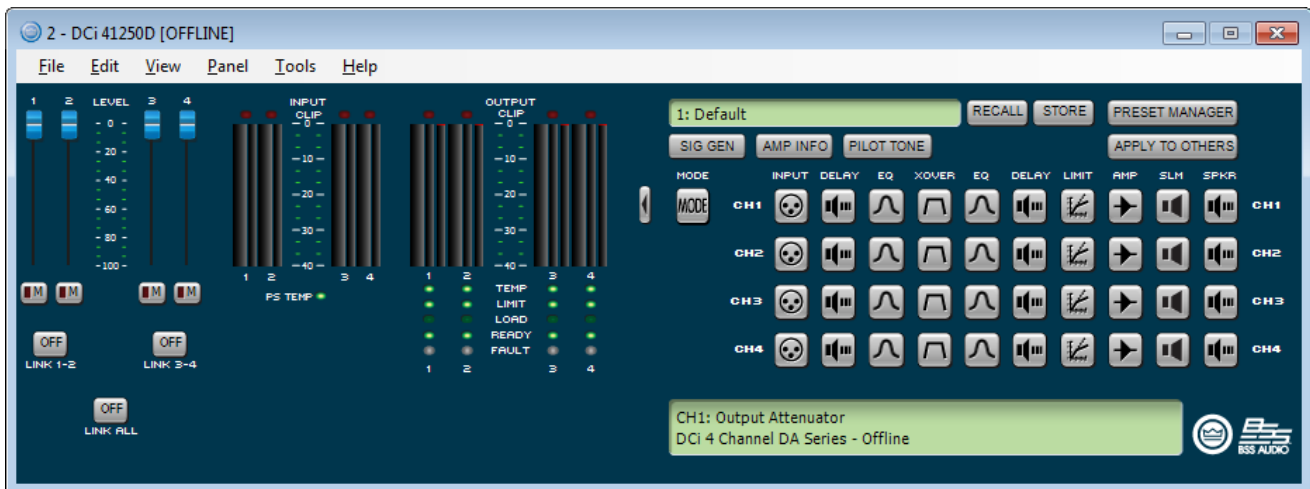

Figure 15: Configuration panel (4-channel amp model shown)

Figure 15 (above) shows the Configuration panel for a 4-channel DriveCore Install DA amplifier. The 8-channel amplifier Configuration panels have the same feature set. The DriveCore Install DA amplifier includes Digital Signal Processing (DSP), multiple input/output routing options, and a comprehensive diagnostics feature set. All of these features can be adjusted from the Configuration panel.

The DriveCore Install DA amplifiers are very capable and flexible amplifiers. In the Amplifier Mode Setting window (see Figure 16), the following items can be adjusted.

- Hi-Z/Low-Z on an individual channel basis.
- 70Vrms or 100Vrms operation
- Any analog input can be sent to any amplifier output
- Mono Bridge Output - Output pairs can be bridged for mono operation

Hi-Z/Low-Z

The DriveCore Install DA amplifiers are capable of High Z and Low Z outputs. Each individual channel is capable of Hi-Z or Low-Z operation. To select Hi-Z or Low-Z operation, double click on the mode button, the Amplifier Mode Setting Window will open (see Figure 16).

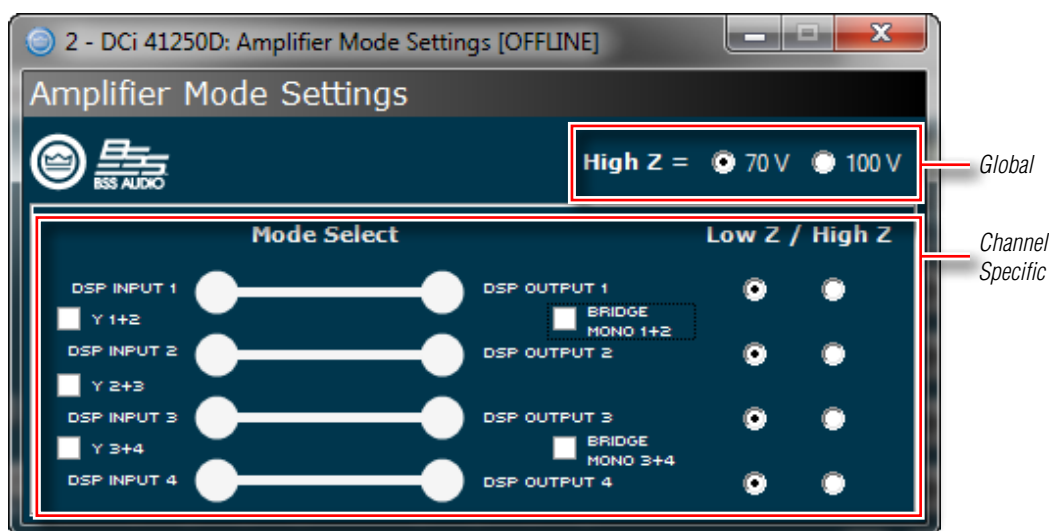

Figure 16: Low Z/High Z configuration

NOTE: Choosing 70Vrms or 100Vrms is an amplifier global setting, and affects all output channels selected for High-Z operation.

Cascading Inputs

Cascading the analog inputs, or "Y-ing channels", gives more flexibility to the installation of a DCi DA amplifier (See **Figure 17**). One input can be used to drive some or all of the amplifier outputs.

NOTE: By cascading the inputs, the corresponding input DSP functions for individual channels will be removed and only the output DSP functions will be available (See **Figure 18**).

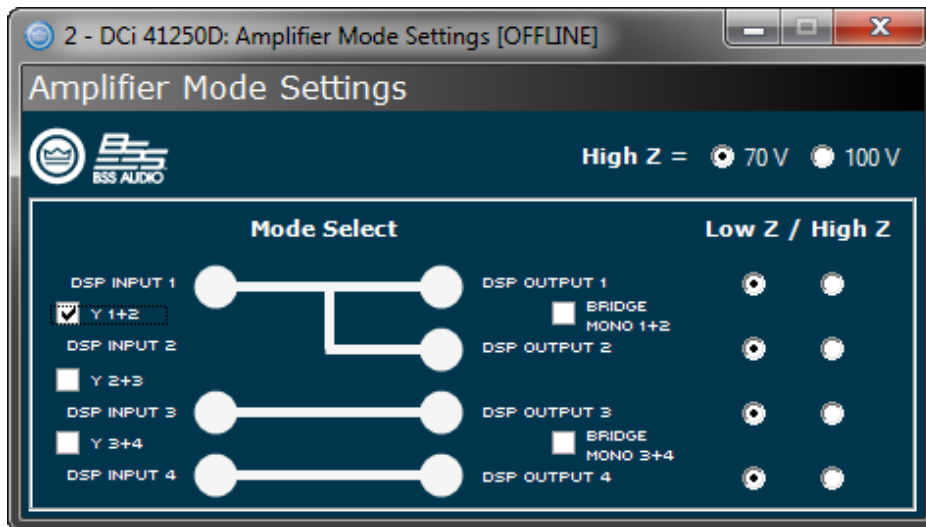

Figure 17: Use the "Y" checkboxes to cascade input channels

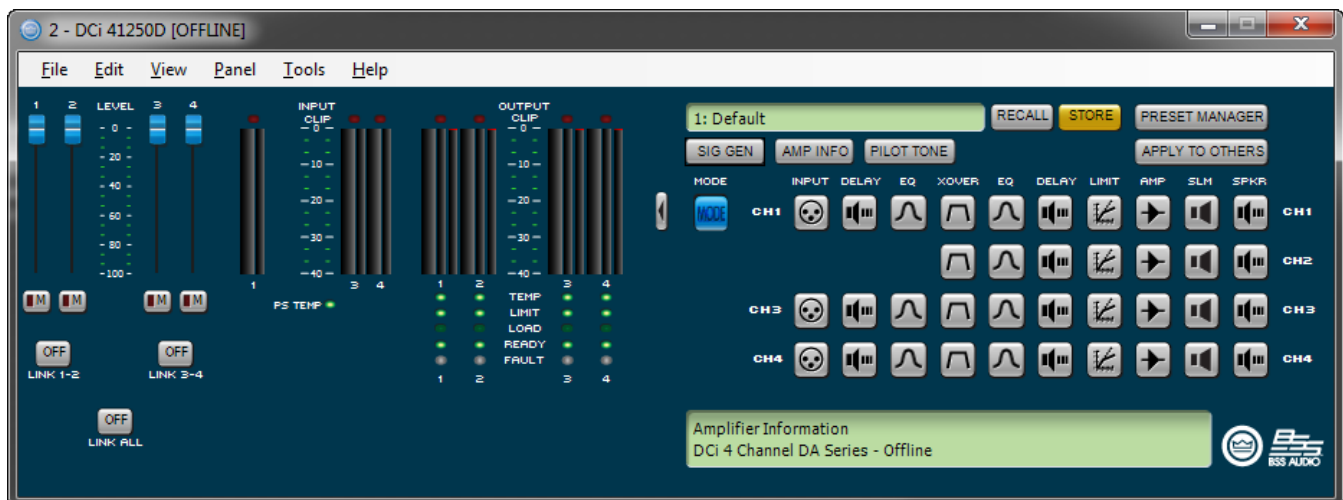

Figure 18: With the "Y 1+2" box checked, both output Ch.1 and Ch.2 are fed by input Ch.1 and input processing is organized accordingly

Bridge Mono Operation

The DCi DA amplifier outputs can be bridged to increase the power and voltage available at the output of the amplifier. The amplifier can be bridged in the Amplifier Mode window. By selecting the bridging option, only the first input channel will need to be wired. (See **Figure 19**). Note that the Low-Z and High-Z options are still available.

NOTE: If the amplifier output is in bridge mono mode and the High-Z option is selected, the amplifier will produce 140Vrms or 200Vrms.

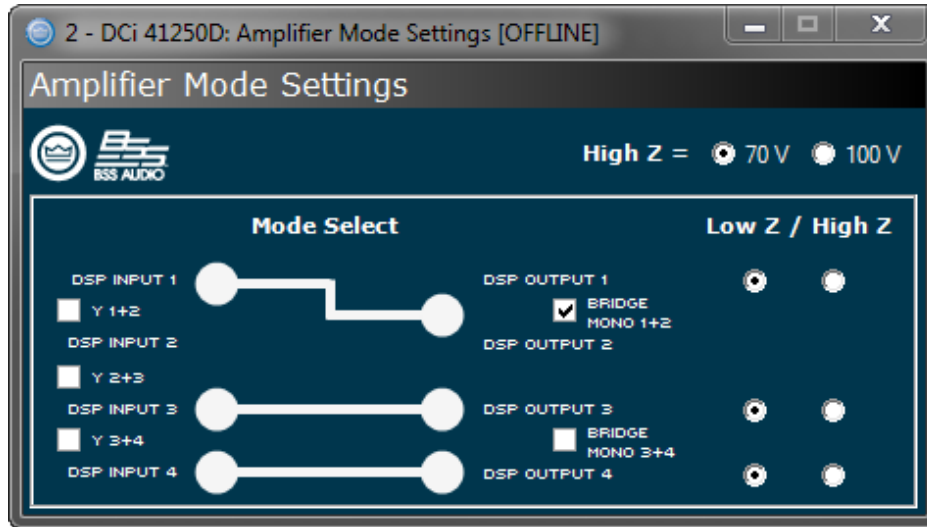

Figure 19: Bridge mono configuration

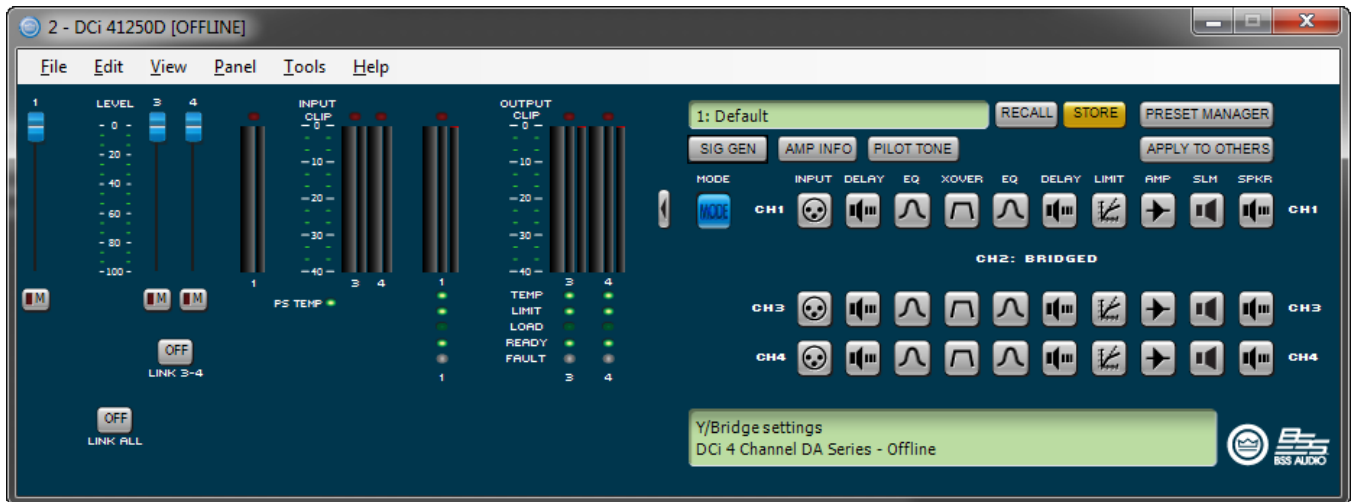

Figure 20: DSP chain configured for bridge mono operation

NOTE: When an output is configured for bridge mono operation, only one channel in the channel pair DSP will be available (See **Figure 20**).

Application Examples

Dual Mode Low-Z (8Ω, 4Ω or 2Ω) Output Operation

Typical input and output wiring, along with Audio Architect software settings are shown in **Figure 21** and **Figure 22**.

INPUTS: Connect the input with wiring in place for each channel. If the same signal is to drive both outputs of a channel pair ("mono"), the input signal can be sent to adjacent amplifier channels.

OUTPUTS: Maintain proper polarity (+/–) on output connectors. Connect the Channel 1 speaker's positive (+) lead to amplifier Channel 1 positive terminal; repeat for negative (–). Repeat Channel 2 wiring as for Channel 1, and for any subsequent channel pairs on multichannel models. Refer "**Wiring Output Connectors**" on **page 4** for output connector terminal assignments.

DANTE: When connecting via Dante, two Dante-equipped devices can be connected directly together using the Primary Dante ports. If connecting more than two Dante devices, the Primary ports of each device should be connected to a network switch (this is referred to as a "star" network topology).

100Mbps network switches and Category 5 cabling can be used for smaller Dante networks where smaller channel counts and/or lower sample rates are used. For optimum performance and improved reliability, a Gigabit network and Category 5e or Category 6 cabling should be used. Visit the Audinate website for more information.

To provide fault protection when using Dante, connect the Secondary ports of all Dante devices to a secondary (separate) network switch. If any "primary" cable connections or the "primary" switch fail, the "secondary" Dante network will automatically take over.

For further information on Dante, refer to "**Dante**" on **page 28**.

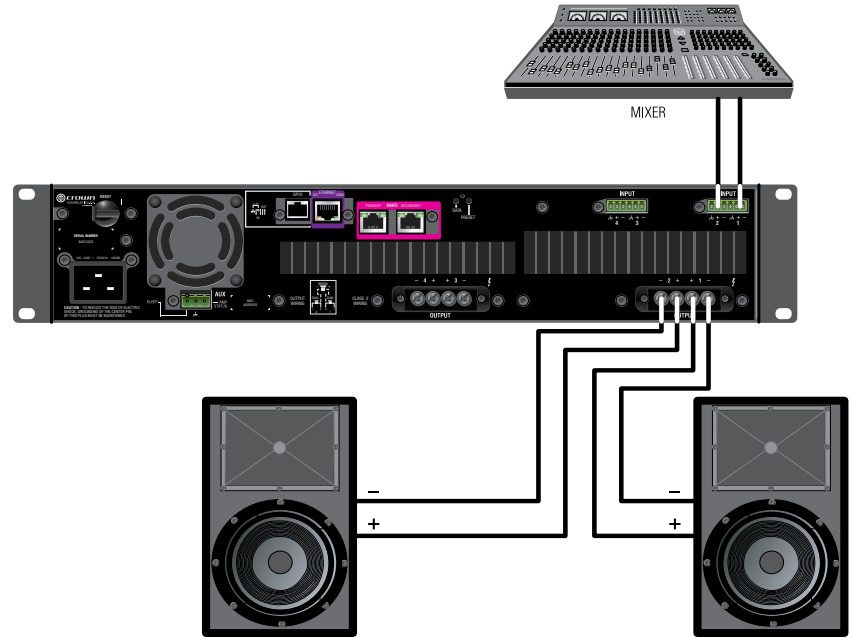

Figure 21: System Wiring Dual Mode

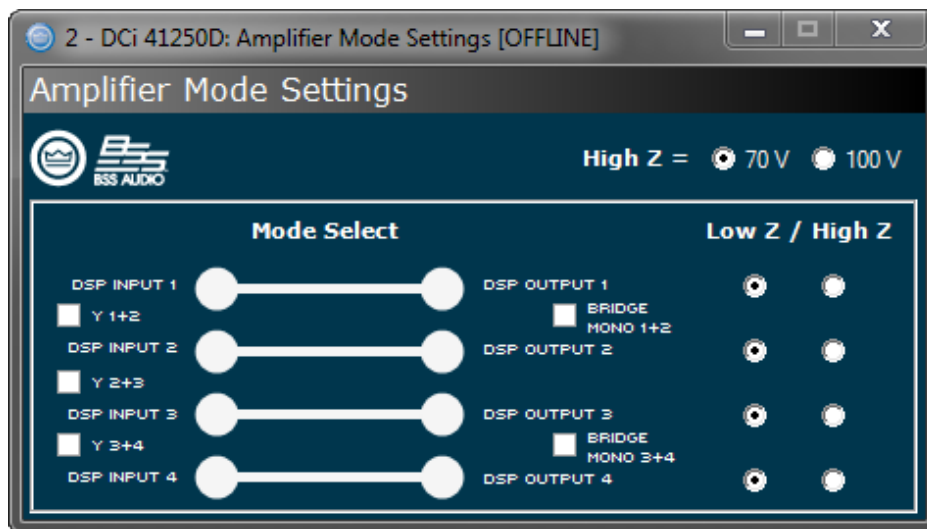

Figure 22: Audio Architect amplifier mode settings

NOTE: Always route the input and output wires in separate bundles.

WARNING: Only connect to networks that remain inside the building.

Bridge Mode Low-Z (16Ω, 8Ω, or 4Ω) Output Operation

Typical input and output wiring, along with software settings are shown in **Figure 23** and **Figure 24**.

INPUT WIRING: If using analog inputs, it is only necessary to wire the odd number inputs.

OUTPUTS: Connect the speaker across the positive terminals of each channel pair. Do not use the negative terminals of the channel pair when the pair is being operated in Bridge Mono mode.

DANTE: When connecting via Dante, two Dante-equipped devices can be connected directly together using the Primary Dante ports. If connecting more than two Dante devices, the Primary ports of each device should be connected to a network switch (this is referred to as a "star" network topology).

100Mbps network switches and Category 5 cabling can be used for smaller Dante networks where smaller channel counts and/or lower sample rates are used. For optimum performance and improved reliability, a Gigabit network and Category 5e or Category 6 cabling should be used. Visit the Audinate website for more information.

To provide fault protection when using Dante, connect the Secondary ports of all Dante devices to a secondary (separate) network switch. If any "primary" cable connections or the "primary" switch fail, the "secondary" Dante network will automatically take over.

For further information on Dante, refer to **"Dante" on page 28**.



Figure 23: System wiring in Bridge Mono mode

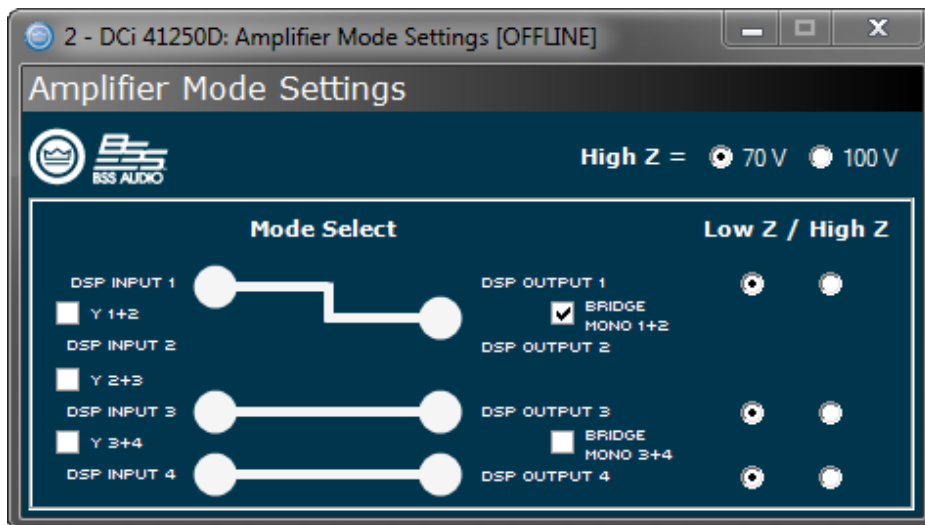

Figure 24: Audio Architect amplifier mode settings

NOTE: Always route the input and output wires in separate bundles.

WARNING: Only connect to networks that remain inside the building.

Dual Mode Hi-Z (70Vrms/100Vrms) Mode

Typical input and output wiring, along with software settings are shown in **Figure 25** and **Figure 26**. A 35Hz high pass filter is selected automatically when the amplifier channel is in Hi-Z or Bridged Hi-Z mode. Remember, DCi amplifiers allow each channel Hi-Z or Low-Z mode of operation to be selected independently, while 70Vrms/100Vrms selection is global.

DANTE: When connecting via Dante, two Dante-equipped devices can be connected directly together using the Primary Dante ports. If connecting more than two Dante devices, the Primary ports of each device should be connected to a network switch (this is referred to as a "star" network topology).

100Mbps network switches and Category 5 cabling can be used for smaller Dante networks where smaller channel counts and/or lower sample rates are used. For optimum performance and improved reliability, a Gigabit network and Category 5e or Category 6 cabling should be used. Visit the Audinate website for more information.

To provide fault protection when using Dante, connect the Secondary ports of all Dante devices to a secondary (separate) network switch. If any "primary" cable connections or the "primary" switch fail, the "secondary" Dante network will automatically take over.

For further information on Dante, refer to **"Dante" on page 28**.

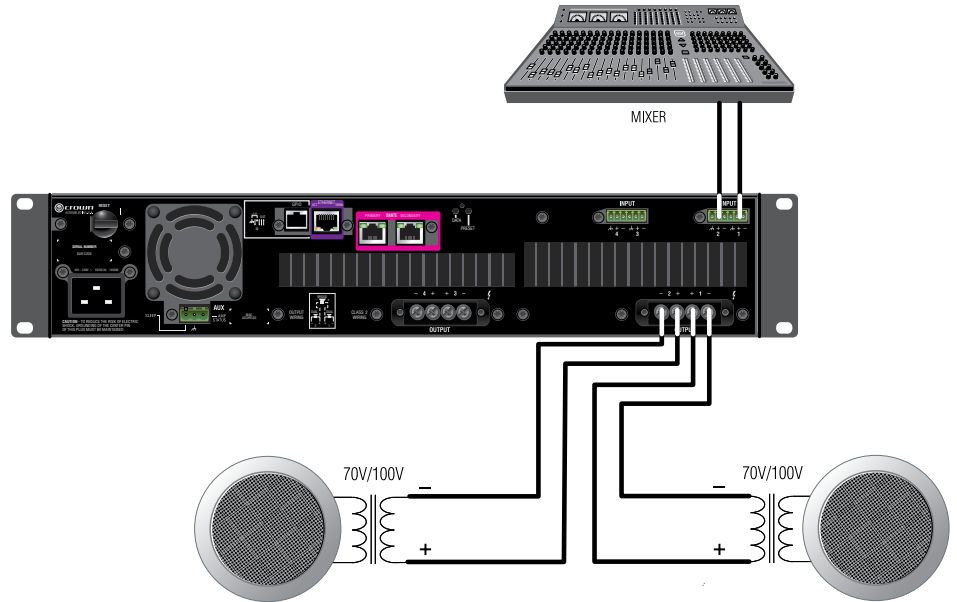

Figure 25: System wiring for 70Vrms/100Vrms operation

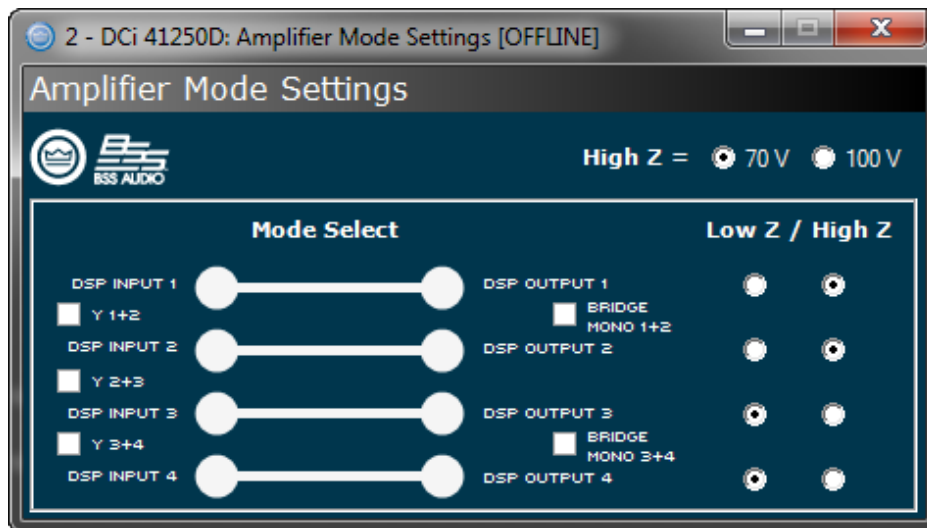

Figure 26: Audio Architect amplifier mode settings

NOTE: 70Vrms/100Vrms is global, while Low-Z/Hi-Z is per output channel.

NOTE: Always route the input and output wires in separate bundles.

WARNING: Only connect to networks that remain inside the building.

Bridge Mode Hi-Z (140Vrms/200Vrms)

Typical input and output wiring, along with software settings are shown in **Figure 27** and **Figure 28**.

INPUTS: Connect the input to the odd-numbered channels (1,3,5,7) only. Even-numbered inputs are disabled when the Bridge Mono mode is active.

OUTPUTS: Connect the speaker across the positive terminals of each channel pair. Do not use the negative terminals of the channel pair when the pair is being operated in Bridge Mono mode.

NOTE: For global selection of 70Vrms (140Vrms bridged) or 100Vrms (200Vrms bridged) operation, refer to "**Hi-Z/Low-Z**" on page 15.

DANTE: When connecting via Dante, two Dante-equipped devices can be connected directly together using the Primary Dante ports. If connecting more than two Dante devices, the Primary ports of each device should be connected to a network switch (this is referred to as a "star" network topology).

100Mbps network switches and Category 5 cabling can be used for smaller Dante networks where smaller channel counts and/or lower sample rates are used. For optimum performance and improved reliability, a Gigabit network and Category 5e or Category 6 cabling should be used. Visit the Audinate website for more information.

To provide fault protection when using Dante, connect the Secondary ports of all Dante devices to a secondary (separate) network switch. If any "primary" cable connections or the "primary" switch fail, the "secondary" Dante network will automatically take over.

For further information on Dante, refer to "**Dante**" on page 28.

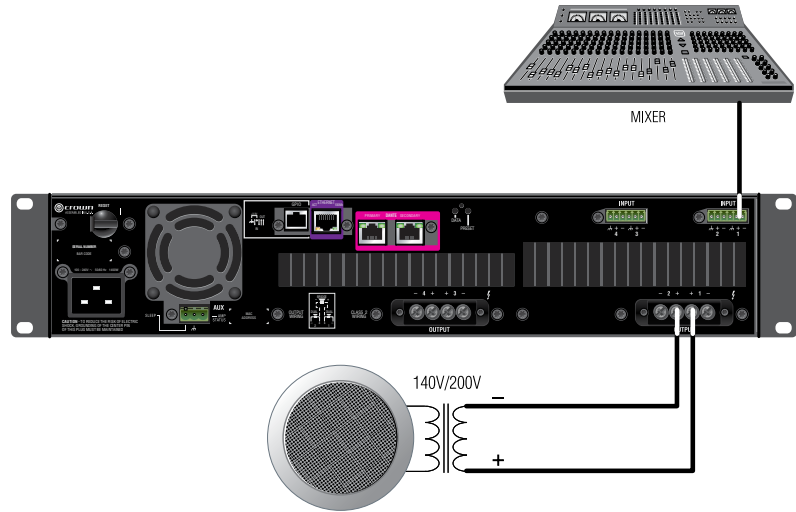

Figure 27: System wiring for 140Vrms/200Vrms operation

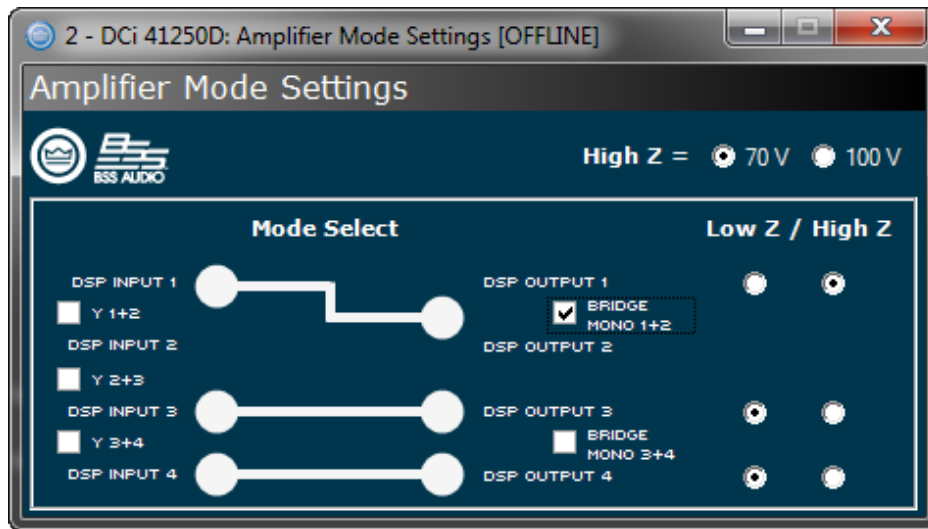

Figure 28: Audio Architect amplifier mode settings

NOTE: Always route the input and output wires in separate bundles.

WARNING: Only connect to networks that remain inside the building.

General Purpose In/Out Control Port

DriveCore Install DA Series amplifiers come with a 2-in, 2-out General Purpose In/Out (GPIO) control port in the form of a 6 position RJ-11 connector. The Control Port has multiple functions and uses which include preset selection and gain control, among others.

Hardware Specification

Inputs are capable of either binary or analog control of a State Variable (SV) within the amplifier. Outputs are binary only that represent an SV of the amplifier. Additionally, outputs can be controlled independently (on/off, polarity) via the software.

PIN 1: Output 1. 0VDC to +3.3VDC output. Output impedance = 1K Ω pullup to +3.3V.

PIN 2: Output 2. 0VDC to +3.3VDC output. Output impedance = 1K Ω pullup to +3.3V.

PIN 3: Input 1. 0VDC to +3.3VDC input. Logic = TTL thresholds. Analog = full scale 0-3.3V. Input impedance > 20K Ω .

PIN 4: +3.3VDC output. ILIMIT = 30mA. Output impedance = 100 Ω to +3.3V.

PIN 5: Input 2. 0VDC to +3.3VDC input. Logic = TTL thresholds. Analog = full scale 0-3.3V. Input impedance > 20K Ω .

PIN 6: GND.

Configuring the Control Port Inputs

2 inputs: Can be variable (connect to potentiometer), binary (connect to switch), or multilevel connect to rotary switch and voltage steps.

- Audio Architect is used to assign up to 40 SV's to each input
- An input mode is selected

SET - Sets the assigned SV(s) to a specific value

VARY - Continuously varies the assigned SV(s) by a specified value, typically a volume pot application.

PRESET - Recalls the max preset in one state (high) and the min preset in the other state (low)

BUMP - Similar to vary but implemented with a button instead of a pot. A high level will bump the assigned SV(s) by a specific value.

AUTOBUMP - Similar to bump, but will continue to bump the assigned SV(s) value as long as the input state is changed.

Right click on a DCi DA in the venue. Select "Configure Control Ports". A new tab labeled "(amplifier name) – Control Ports" will open.

Software Parameters

High Limit – Available only on input, and only for parameters in "Analog Input" mode. This field determines the value that the selected assigned parameter will assume when the control port input is at the maximum end of its range.

Input - selects between control port inputs, labeled 1 and 2.

Low Limit – Available only on input, and only for parameters in "Analog Input" mode. This field determines the value that the selected assigned parameter will assume when the control port input is at the minimum end of its range.

Mode – For the control port input, the Mode field determines how the assigned parameters will be controlled. For the control port output, the Mode field determines the conditions under which the output status will change.

Off Value – Available only on input, and only for parameters in "Direct Action" mode. Determines what the value of the selected assigned parameter will be when the control port input is logic "Low".

On Value – Available only on input, and only for parameters in "Direct Action" mode. Determines what the value of the selected assigned parameter will be when the control port input is logic "High".

Output – Selects between control port outputs, labeled 1 and 2.

Output Polarity – Enables selection between "Normal" and "Inverted".

Parameter Assignment – List of parameters that are currently assigned to a given control port input

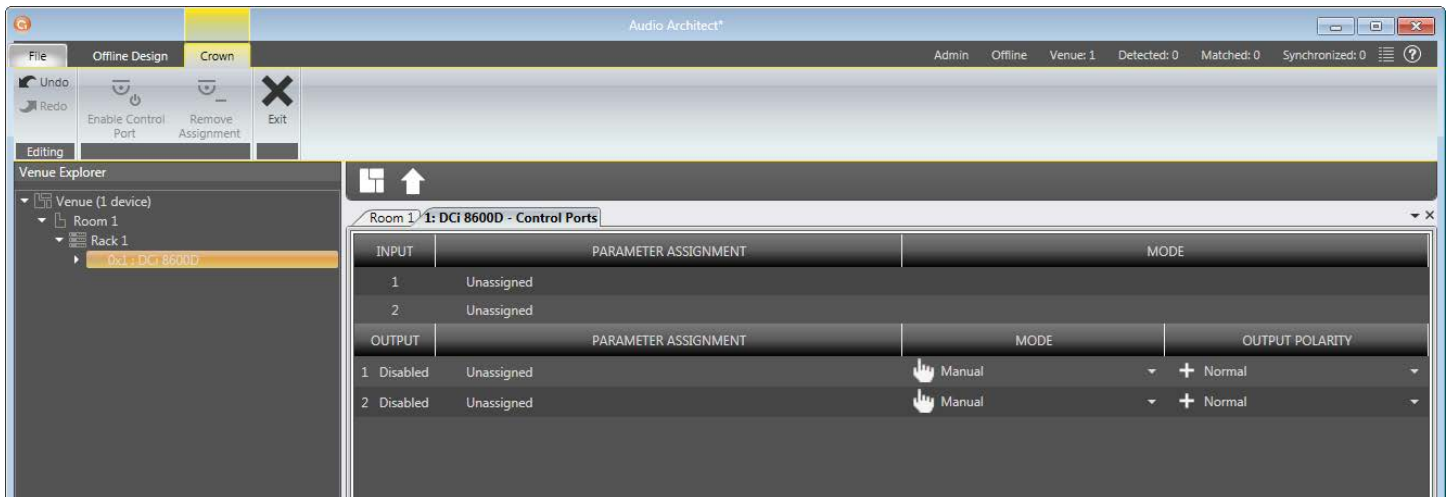

Figure 29: Control Port Configuration window

In the Venue Explorer, select and expand the device for a list of objects. Expand an object for a list of state variables (SV's) within the object. A state variable can be added to the control port input assignment by clicking and dragging with the mouse into the "Parameter Assignment" tab for either input 1 or 2.

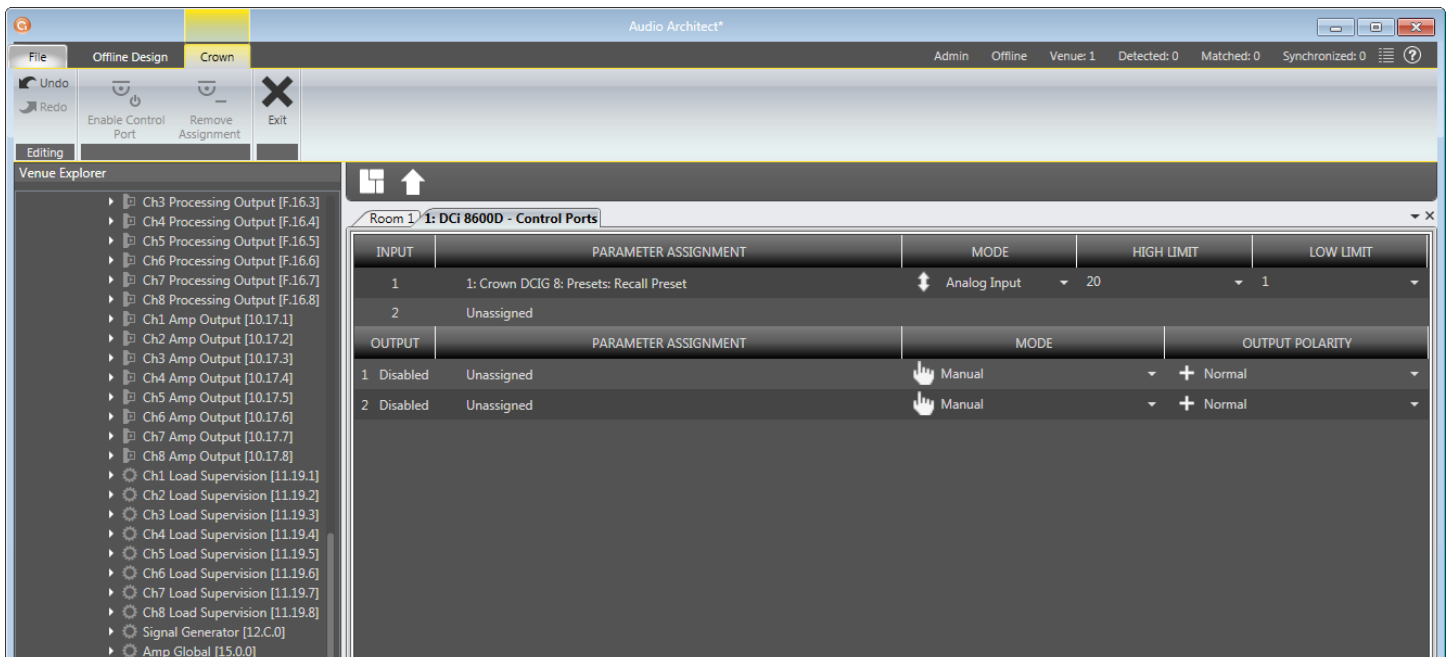

Figure 30: Assigning the "Current Preset" parameter to Control Port Input 1

Once an SV has been added, its type will determine which MODE options become available. If a binary SV has been assigned, only the "Direct Action" mode is selectable, and the "ON VALUE" and "OFF VALUE" parameters can be toggled as desired. However, if a non-binary SV is added, the "Analog Input" Mode becomes available. In this mode, the ON and OFF VALUE fields are unused, and the "HIGH LIMIT" and "LOW LIMIT" fields appear and become accessible. The LIMIT fields allow control of an SV over a specified range.

Additional state variables can be added to a given control port input by selecting the SV and dragging on top of a previously assigned row of the desired input. However, once an SV has been assigned and the MODE has been set, any subsequent SV that is added must function in the same MODE. Up to 40 SV's can be assigned to a given input.

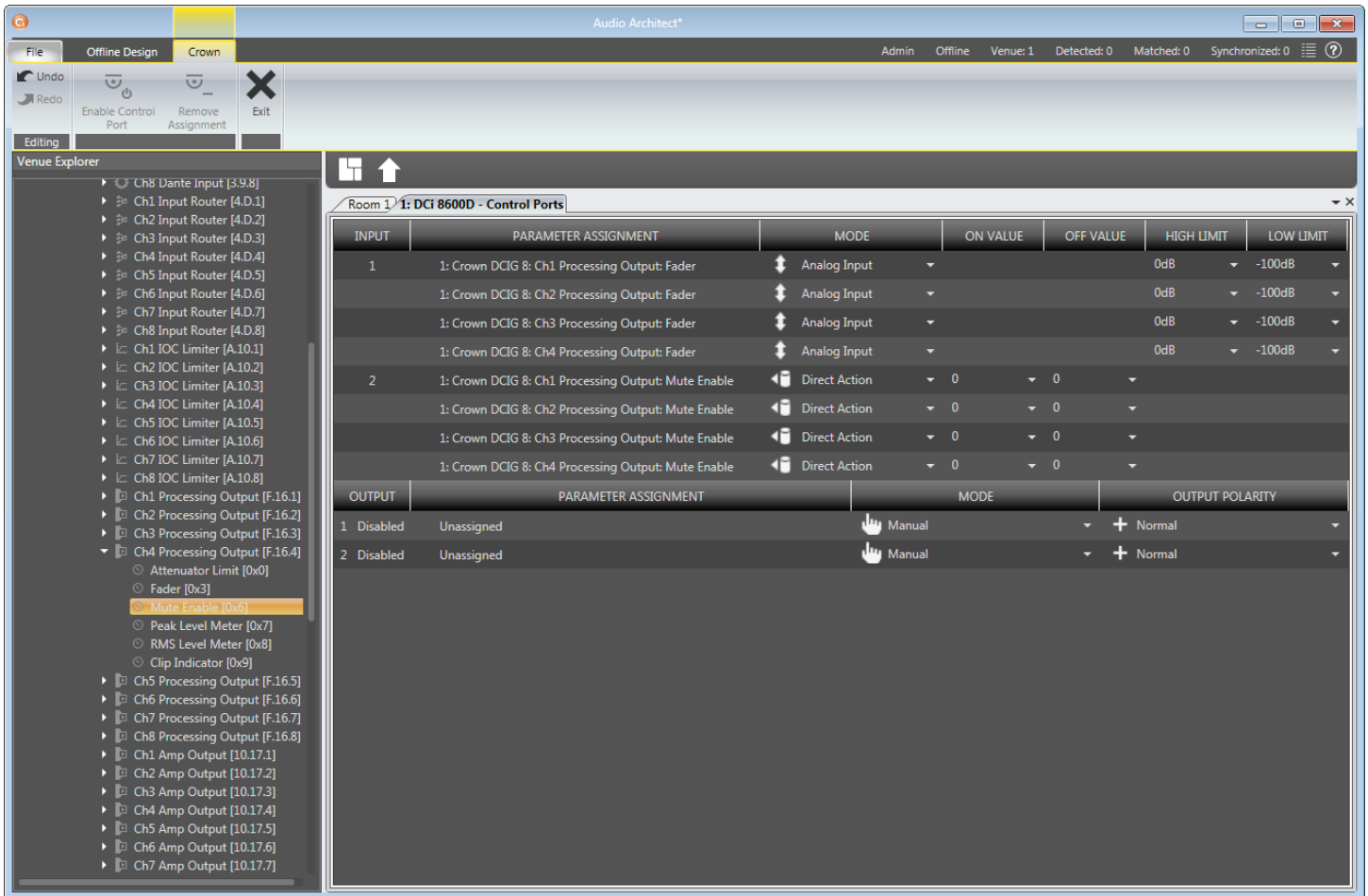

Figure 31: Configuring Input 1 to control Processing Output Faders for Channels 1 – 2, and Input 2 To control Processing Output Mutes for Channels 1 – 2

An assigned state variable can be removed by highlighting and selecting "Remove Assignment" in the upper left hand corner.

Configuring the Control Port Outputs

2 outputs: Binary only.

- There is a polarity control on each output so that it may function as active-high or active-low
- Output Mode 1 - Manual: Controlled directly by the output enable button
- Output Mode 2 - Report Errors: Active when any enabled error is reported. The indicator will stay on for up to 60 seconds after the error is cleared. Errors include:
 - Load Supervision
 - AC Line Voltage is out of range
 - Hardware Protection (faults)
 - Over temperature (any channel or power supply)
 - Amp output clipping
 - Processing output clipping (off by default)
 - Analog Input clipping (off by default)
- Output Mode 3 - Report online status: Active when HiQnet connection is lost. The length of time to wait for a time out is user adjustable, default = 60 seconds

The Control Port output configuration options can be found directly below those for the input. No parameters can be assigned to the outputs. Instead, there are three modes available: Manual, Report Errors, and Report Online Status. Manual mode enables direct control over the selected output. In "Report Errors" mode, the output status will change if any errors are reported to the network, such as clip errors, temperature errors, line voltage errors, etc. Finally, in "Report Online Status" mode, the output status will change if no network communication is detected for at least 60 seconds. The control port output does not turn off right away when reporting errors or online status. There are several reasons for this. The online status does not change quickly, it can take up to 60 seconds to drop offline or to recover. In these modes, the output is intended to be used with devices such as a backup amp switcher or an electro-mechanical system. We want to prevent this output from toggling on/off quickly. It may take the output up to 90 seconds to recover (i.e. switch states) from an error or loss of connection.

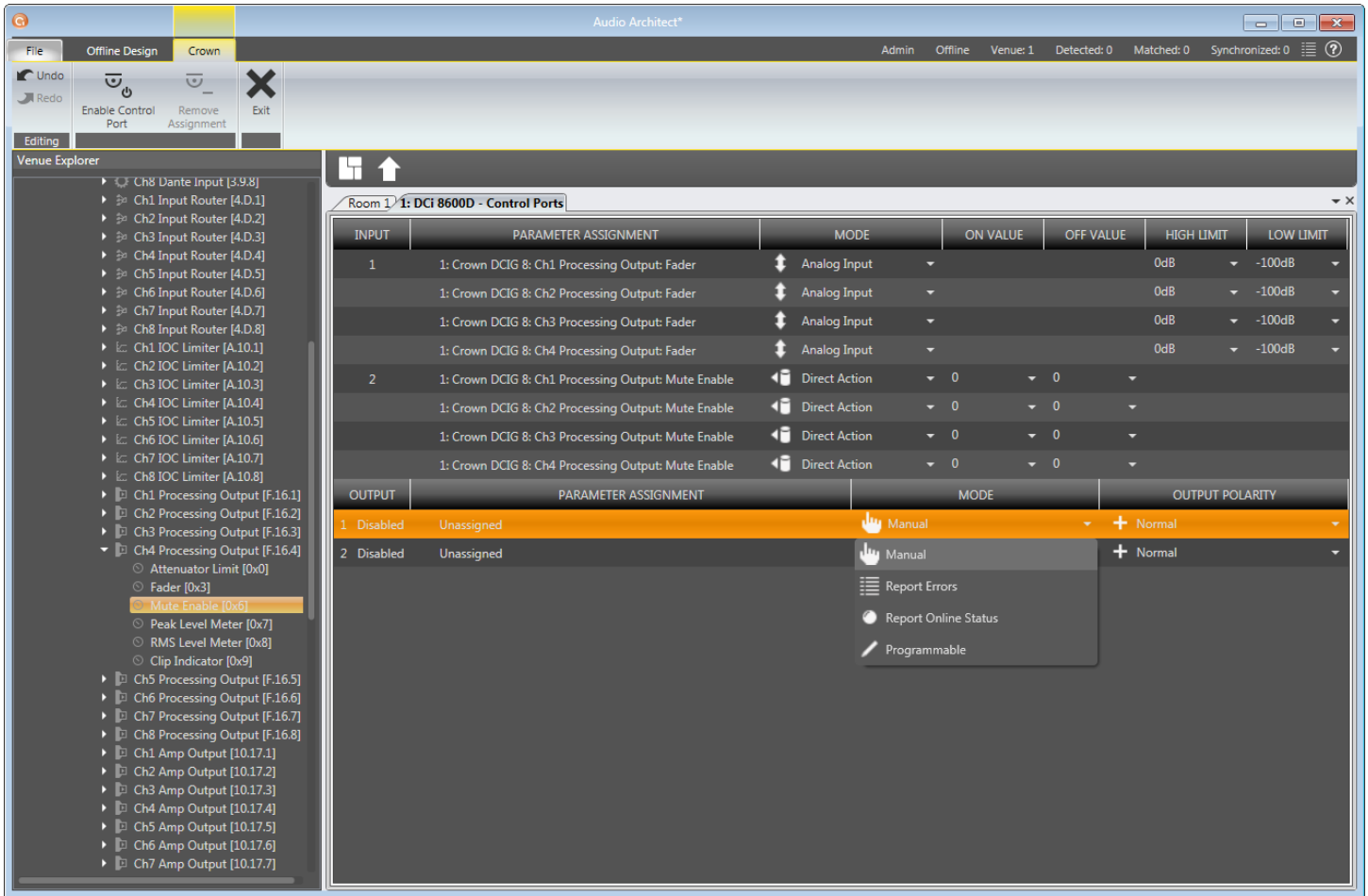

Figure 32: Control Port Output Configuration

NOTE: In all modes, the polarity of the binary output can be toggled under the OUTPUT POLARITY tab, where “Normal” or “Inverted” can be selected.

Aux Port/Sleep/Amp Status

AUX Port

The AUX port can be used for basic monitoring of the amplifier and for remote standby. The port is a 3 pin block connector with pin-2 used as ground.

Sleep

The amplifier can be put to sleep by connecting pins 1 and 2 together on the AUX port. When applying this connection, the amplifier will shut down and remain in sleep until the connection between pins 1 and 2 is open. While the amplifier is in sleep, the front panel power button is disabled. When the connection between pins 1 and 2 is open, the amplifier will revert to its last configuration and begin to output audio within 20 seconds. Communication via the network will take as long as the network interface card boots. If the front power button is pressed while the amp is in sleep mode, the blue power indicator will blink twice.

Amp Status

AMP STATUS can be used for basic monitoring of the amplifier. Monitoring of the amplifier can determine if the amplifier is operating within optimal parameters or if the amplifier has been shut off or is in fault. Between pins 2 and 3, there will be either a +5VDC potential or a 2Hz square wave (heart beat). This option can be found in the AMP INFO button on the main amplifier Configuration panel within Audio Architect.

Dante

Dante Introduction

Dante is a licensed technology from Audinate®. It uses standard Internet Protocols over a 100Mb or Gigabit network and is capable of transporting professional-quality, low-latency audio. Dante runs on inexpensive off-the-shelf computer networking hardware and does not require dedicated network infrastructure; Ethernet switches transmit Dante digital media streams alongside ordinary data traffic. The physical Dante connections must be made using Category 5e or Category 6 cables when using a Gigabit network (Category 5 cables may be used for purely 100Mbps networks).

The two Dante (RJ-45) ports on the back of the DCi DA amplifiers can be used to connect to other Dante-enabled devices for transmission and receipt of high-resolution digital audio over standard Ethernet cabling. The Dante protocol supports 24-bit resolution with a sample rate of either 48kHz or 96kHz. All DCi DA amplifiers support 8 Dante input channels and 8 Dante output channels.

Dante Specifications

- Supports 48kHz or 96kHz sample rates
- 24-bit audio resolution
- Dante data can co-exist on a network alongside control information and other standard data traffic
- Supports high channel counts; maximum channel count varies based on network speed (e.g., 100Mbps, Gigabit, etc.)
- Dante protocol based on networking technology standards, allowing the transport to operate with off-the-shelf networking peripherals
- 100m/328ft over Category 5e or Category 6 cable between devices (Category 5 cable can be used for purely 100Mbps networks)
- Supports fiber runs using fiber-enabled network switches
- Typical Dante transport latency contribution to a system is approximately 150µs or less
- Supports unicast (point-to-point) or multi-cast (one-to-many) audio packet transmission
- Supports redundancy using the Secondary Dante ports and a second network switch

Hardware Configuration

Dante devices have two Dante ports. One is the Primary and the other is the Secondary. When using only two Dante devices, the devices can be connected directly together. When connecting more than two devices, they should be connected to an Ethernet switch using a star networking topology. If using the Secondary Dante ports for redundancy, the Secondary ports should be connected to a second switch and operated as a separate network.

Fault Tolerance

The DCi DA amplifiers have a Primary and a Secondary Dante port; Dante audio traffic is duplicated to both of these ports. The Secondary port can be connected to a secondary network switch for redundant operation in the event a primary cable connection or the primary network is compromised.

Mastership

The Dante network requires one device on the network to act as master for the whole network. The master will provide the clock for all the other Dante devices on the network. This means that the whole network is synchronised to a single audio clock.

In certain cases, it is possible to utilize devices of more than one Ethernet transport type (AVB, CobraNet™, or BLU link) connected within the same Dante network. In other words, if you're careful, you can design a Harman system which actually includes more than two transports.

For example, it's possible for a Harman system to have CobraNet™ audio being converted to BLU link audio (the BSS Audio BLU-800 and BLU-320 both have the ability to "bridge" CobraNet to/from BLU link), which is then converted to Dante audio (BLU-806, BLU-326 and BLU-DAN all have the ability to "bridge" BLU link to/from Dante). It all depends on a given transport's ability to "slave" (AKA "re-clock") to a clock being generated by a separate transport.

Can it be "slaved" to the clock of another transport?

AVB	No
BLU link	Yes
CobraNet	No
Dante	Yes

The previous chart has critical implications on system design when combining two or more transports. Any system based on Soundweb London (including Architectural Media Systems) supports the following five multi-transport combinations:

- BLU link + AVB (AVB provides the clock)
- BLU link + CobraNet (CobraNet provides the clock)
- BLU link + Dante (either BLU link or Dante provides the clock)
- BLU link + Dante + AVB (AVB provides the clock)
- BLU link + Dante + CobraNet (CobraNet provides the clock)

Any multi-transport combination NOT specifically listed in the previous section is not allowed in Soundweb London systems (without being forced to use analog interconnects between transports). For example, Dante + AVB + CobraNet is NOT allowed, because the AVB and CobraNet networks would each be synced to different clocks—their own.

Mastership is negotiated between all the devices on the network, and change to the network will trigger the negotiation to be started. There are various rules for determining which device on the network becomes clock master :

- If there is only one device connected to CobraNet/AVB then that is master.
- If there are multiple devices connected to CobraNet/AVB, then they compare master priorities.
- If there are multiple devices on CobraNet/AVB with the same highest priority, then they use MAC address to decide which is master.
- If there are no devices connected to CobraNet/AVB, then they first compare master priorities. Next, if the priorities are the same, they compare MAC addresses.

Dante LED indicators

These are found on the Dante ports on the back panel of the device and indicate the following:

- Green LEDs

The green LED will light solid to indicate a network link is established and flash to indicate link activity.

- Orange LEDs

The orange LED indicates network connection speed (off = 10/100Mbps, on = 1 Gbps)

Dante Routing

The DriveCore Install DA amplifiers can use both analog and/or Dante inputs.

All Dante routing must be configured using Audinate's Dante Controller software, which can be downloaded from <https://www.audinate.com/products/software/dante-controller>.

Once Dante audio has been configured, input levels can be adjusted in the DriveCore Install DA amplifiers by clicking the Input Icon > Input Configuration. This panel allows you to make changes to the levels of the various sources. This feature allows you to adjust for different signal levels from the source (i.e. if analog inputs are quieter than Dante inputs) or can be used as an additional gain if needed.

The meters on this panel allow you to see both Peak and RMS levels. You are also able to set the maximum input level for the amplifier which will affect all channels. Network Signal Status lights below each Dante input channel provide confirmation of Dante signal presence.

NOTE: Gain Mode for the analog inputs can be used to maximize the Signal to Noise Ratio.

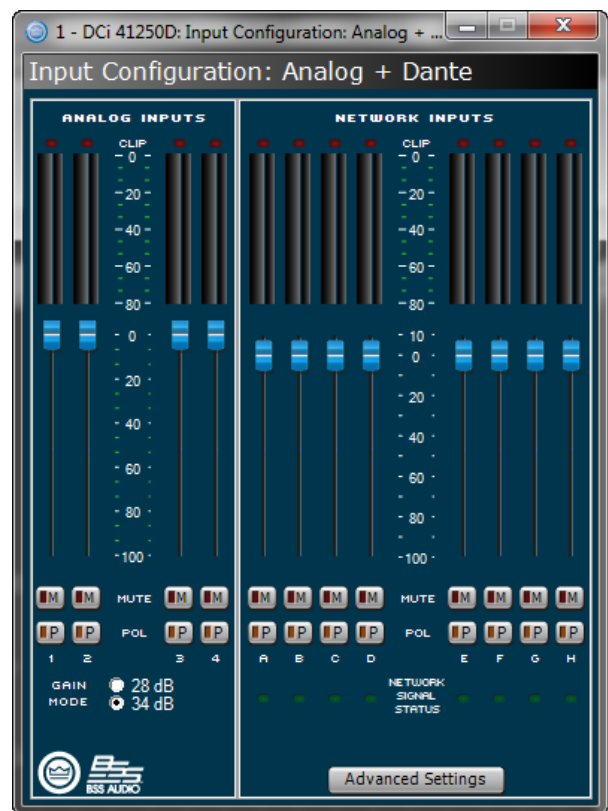

Figure 33: Input Configuration panel

Clicking the Advanced button opens the Dante Advanced Settings window (see **Figure 34**) where the following information is displayed:

- **Dante Device Name:**
The name of the device as shown in Dante Controller.
- **Sample Rate**
Dante sample rate (read only). To change sample rate, use Dante Controller, then reboot the amplifier.
- **MAC Address**
MAC Address of the Primary Dante port.
- **Version**
Firmware version of the Dante module.

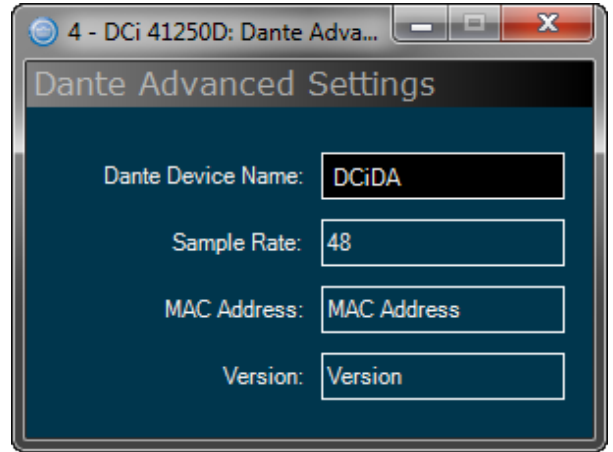

Figure 34: Dante Advanced Settings panel

The analog inputs in the DriveCore Install DA amplifiers provide additional flexibility when using the amplifiers Dante outputs. From the Dante Output Configuration window (Input Icon > Output Configuration), it is possible to utilize the DCi DA amplifier to be a Dante On-Ramp in two different ways:

- Send unprocessed audio from the analog inputs of the amplifier to one of the 8 available Dante outputs
NOTE: The audio from the analog inputs passes through the amplifier input gain stage (affected by selecting 28dB or 34dB of gain), and then through the input trim and polarity switches in the Source Routing - Input Configuration panel, before being sent to the Dante network.
- Send post-processed audio from a DCi DA amp output channel to one of the 8 available Dante outputs
NOTE: The post-processed audio is bussed from a point at the end of the entire channel processing chain in the DCi DA. This is effectively analogous to taking the audio from the physical output of the amplifier feeding a loudspeaker, and routing it onto the Dante network.

After selecting an Audio Source in the dialogue shown above, you must also route the Dante audio using the [Dante Controller software](#).

NOTE: When connected to a Dante network running at 96kHz, the DCi DA's Dante outputs will be disabled and the amp will not be able to transmit audio onto the Dante network. The amplifier will be able to receive a full compliment of up to 8 Dante streams to send to the input router, but it will not be able to output any audio signals back onto the Dante network.

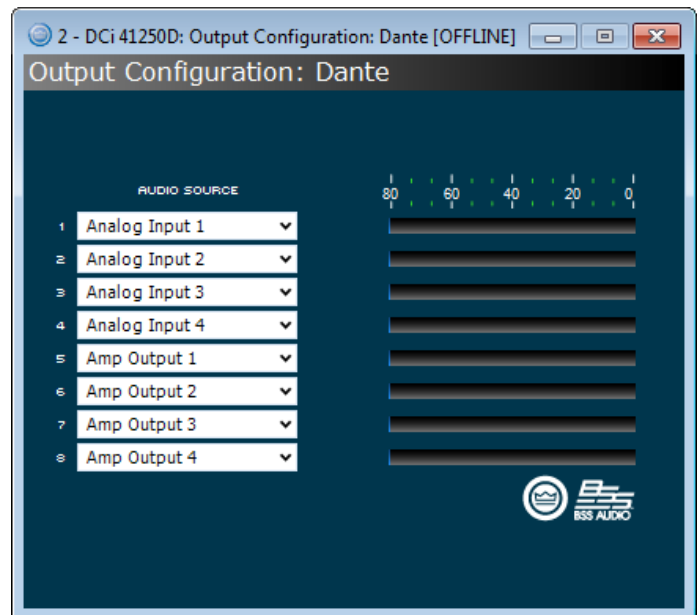

Figure 35: Dante Output Configuration panel

Advanced Operation

Introduction

Your DCi DA amplifier has a wide variety of onboard Digital Signal Processing (DSP). HiQnet Audio Architect software lets you adjust the DSP settings, such as filter slope, compression ratio, EQ frequency bands, and so on.

A **preset** is a group of DSP settings that configure the amp for a specific application. For example, you might use one preset that optimizes the amp's DSP for a JBL tri-amplified speaker setting. You might use another preset that sets up the DSP for a stereo pair of loudspeakers of your choice. You can choose any of 20 presets.

Amplifier Presets and Speaker Tunings

Preset 1 is the factory default preset and cannot be overwritten. It sets up the amplifier for pass-thru operation with no DSP features enabled. The DCi DA amplifier works with two types of presets:

User Presets – Using Audio Architect, you can create your own custom DSP presets, label them, and send them to the DCi DA amplifier. The amp stores those presets in firmware.

Downloadable Presets – Available for download from a variety of manufacturers, these presets are configured for optimal performance and can be sent to the amplifier via Audio Architect.

User Presets

User presets are DSP presets that are configured manually. The following three steps outlines setting up User Presets.

1. Adjust the DSP settings as desired in the Audio Architect software.
2. Save this group of settings as preset, you will be prompted to name it.
3. Download the preset to the DCi DA amplifier. See the software Help file for details. As soon as you save the setting as a preset, it is sent to the amplifier.

Speaker Tunings

Crown and JBL engineers have designed DriveCore Install DSP settings that are optimized for various JBL loudspeakers. Speaker tunings can be downloaded at the following website: www.jblpro.com. An improved speaker tuning approach has been developed for the DriveCore Install DA Series. The system is software library based rather than device preset based. The new approach offers significant benefits:

- Unlimited number of tunings organized into an unlimited number of libraries
- Simple and fast drop-down tuning recall/store/delete within device GUI
- Channel/band specific tunings – no more managing tunings across channels or amp chassis. Also yields logical one-to-one correlation of amp output to transducer/band.
- Faster tuning load/store times – much easier to compare and run A/B tests on multiple tunings without audio dropouts
- Library based – allows logical groupings and archiving of similar tunings (e.g. Screen Array Series or VTX Series, etc.)
- Tunings can be held within but are de-coupled from device presets. Eliminates concern of accidentally deleting or changing other device parameters – speaker tunings only contain the parameters required for speaker tunings! Now presets can be used for complete device configurations – as intended.
- Simpler and faster third-party and user tunings and libraries development – more people will be willing to develop custom or 3rd party tunings
- Single panel access to all required tuning parameters – easier/faster to create/modify tunings.

Speaker Tuning Panel

A new “speaker tuning” icon is implemented on the main device panel for each channel of DCi amplifiers. Double-clicking the speaker tuning icon will open the basic Speaker Tuning Panel (STP).

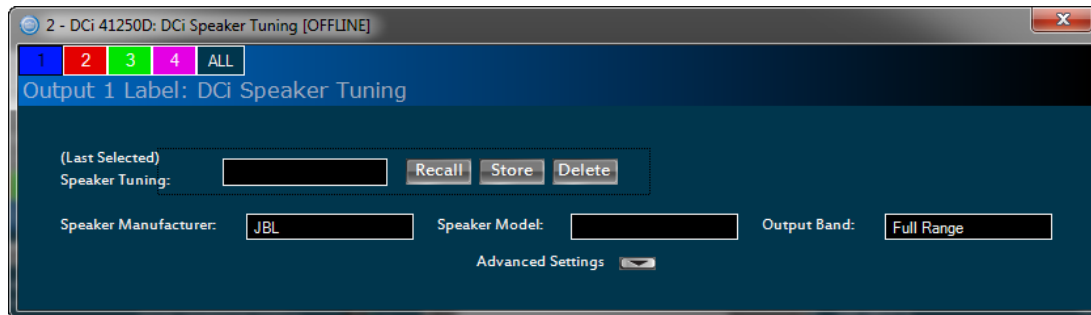

Figure 36: *Basic Speaker Tuning panel*

Basic STP functions are:

Recall

Loads the selected tuning from the working library (drop-down list) into the respective channel.

Store

Stores the STP settings from the respective channel into the working library with specified user name. The stored tuning is then available in the drop-down list for any other channel or amp.

Delete

Deletes the selected tuning from the working library.

Speaker Manufacturer

This parameter displays a text description of the respective speaker manufacturer (i.e. JBL, Custom, etc.). The data for this parameter is stored within the tuning and also within the device settings.

Speaker Model

This parameter displays a text description of the respective speaker model (i.e. 3722, Three-Way, etc.). The data for this parameter is stored within the tuning and also within the device settings.

Band

This parameter displays a text description of the respective tuning band (i.e. LF, MF, HF). The data for this parameter is stored within the tuning and also within the device settings.

Tool Tips

The Mfr, Model and Band text fields are displayed in the tool tip box when the mouse is hovered over the respective channel Speaker Tuning Icon.

Advanced STP functions are available to create/modify speaker tunings. Holding CTRL-ALT-SHFT while double-clicking the speaker tuning icon opens the advanced panel. See **Figure 37**.

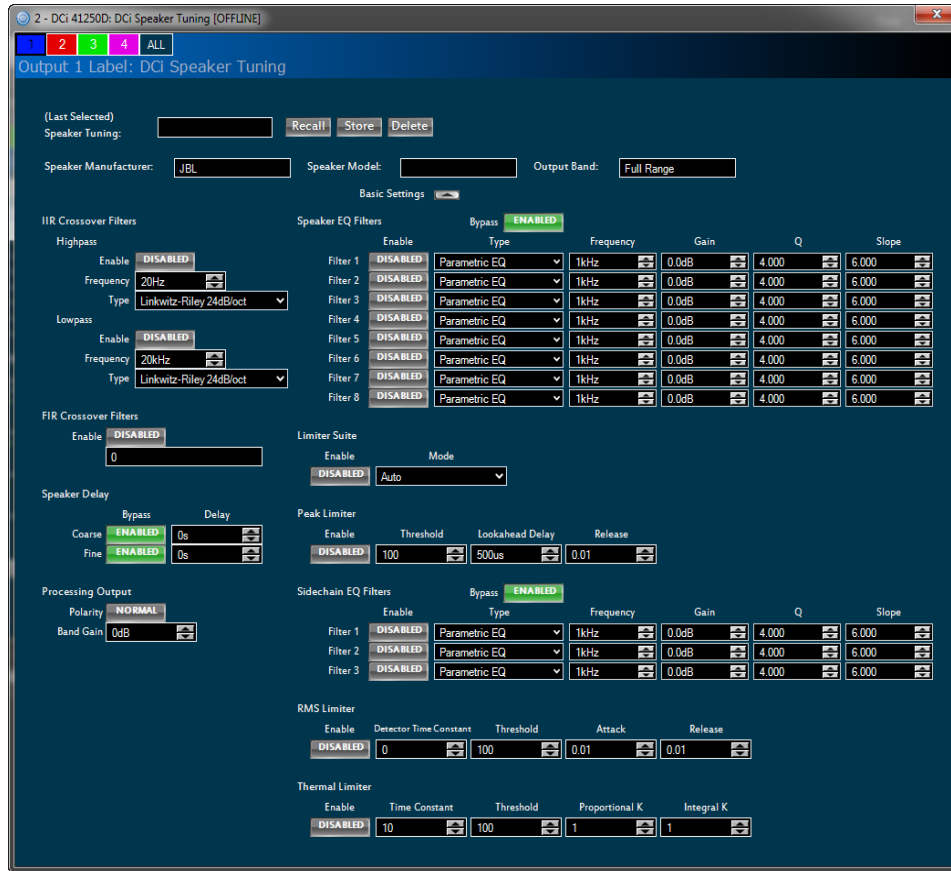

Figure 37: Advanced Speaker Tuning panel

The advanced panel includes every parameter implemented in a speaker tuning:

1. All parameters from basic panel (Recall, Store, Load, Delete, Mfr Name, Model, Band)
2. Crossover Filters (HP lower band-edge, LP upper band-edge, 18 types up to 48dB/oct)
3. EQ Filters (8 second order filter sections, 11 types, full parametric control)
4. LevelMax Limiter Suite (Peak, RMS, Thermal Limiters, Auto/Manual modes)
5. Delay (Fine adjustable from 0S to 0.1S, Coarse adjustable from 0S to 2S)
6. Band Gain (adjustable from -100dB to +20dB in 0.5dB steps)
7. Polarity/Invert

Speaker Tuning Libraries

The new system uses software based Speaker Tuning Libraries. Audio Architect manages these libraries within the device DLL. A library can contain any number of tunings. Audio Architect can manage any number of libraries. The library system implemented includes:

Working Library

The working library is opened and active when opening any Speaker Tuning Panel. The working library is automatically updated with the latest stored tunings/settings when exiting the open STP. Audio Architect is installed pre-configured for DCI amplifiers with a working library previously loaded with JBL Screen Array tunings from the JBL Master Screen Array Library.

NOTE: Multiple STP's can be opened but only the last parameters on the last panel closed are saved to the working library.

JBL Master Screen Array Library

This library is included with Audio Architect at install. The tunings in this library were developed and validated against previous same tunings for Crown DSI amplifiers. It is read-only to prevent over-write. At any time, a user can load this library to access reference JBL tunings for these devices.

User Libraries

At any time, the user may save the current working library to a custom user library file.

Loading a Library

Click on the File/Open > Speaker Tuning dialog on the device main panel to open and load an existing library file into the working library. This action replaces the current working library. Any changes not saved to the existing working library will be lost.

Saving a Library

Click on the File/Save > Speaker Tuning dialog on device main panel to save the current working library to any filename.

NOTE: JBL files are write-protected/read-only and cannot be over-written.

Library File Locations

The file location and naming conventions for all speaker tuning libraries is:

- Windows 7 and Windows 8.1 path C:\ProgramData\Harman Professional\Audio Architect\
- Windows XP path C:\Documents and Settings\All Users\Application Data\Harman Professional\Audio Architect\

Library Filename Conventions

The general file names are:

- Working Library: Crown Library.DCi Series.SpeakerTuning
- JBL Screen Array Library: JBL Master Screen Array Library.DCi Series.SpeakerTuning
- User Libraries: Any_user_file_name.DCi Series.SpeakerTuning

Channel Levels and Mutes

When viewing the Configuration panel, the panel can be expanded or minimized using the Arrow button, as shown on the right side of the Basic Configuration panel in **Figure 38**. From the Configuration panel, channel levels can be adjusted using the Level faders, channels can be muted, and Level faders can be linked using the Link buttons.



Figure 38: Basic Configuration panel

Input Signal Level Meter (green)

The measurement range is from 0dBFS to -40dBFS with 0.5dB resolution. Each audio channel has the following monitors:

- Switched Audio Input: This meter shows only the switched (selected) audio input after the Input Audio Router.
- Clip Indicator
- Peak + RMS levels

Output Signal Level Meter (blue)

The measurement range is from 0 dB to -40 dB with 0.5 dB resolution. The monitors are scaled so that 0 dB is referenced to the full rated output voltage of the amplifier. The wider left meter is rms and the right meter is peak for each channel. An output clip indicator is provided.

Indicators

- Temp: Lights if the temperature of the amplifier is too high and the amplifier is near shutdown.
 - Green: Thermal headroom used up is less than 59%.
 - Yellow: Thermal headroom used up is 60-80%.
 - Red: Thermal headroom used up is more than 81%.
- Limit: Lights when the amplifier signal is being limited.
- Load: Lights when the load impedance is out of range.
- Ready: Lights when the amplifier is on and ready to supply power.
- Fault: Lights when the amplifier is in a fault mode service may be required.

Software-Controllable Onboard DSP

Crown DriveCore Install DA amplifiers have Digital Signal Processing built into the amplifier.

When you use a DriveCore Install DA amp, the loudspeaker processors, crossovers, limiters and delays are in the onboard DSP – so discrete rack mount devices are not needed. This drastically cuts setup time, commissioning, rack space and costs. The DriveCore Install DA DSP can be monitored and controlled with a computer running Audio Architect software, and connected to the amplifier Network Connector by a Category 5 Network cable.

Some applications for this DSP are:

- Configure signal flow
- Optimize system gain structure
- Configure speaker configurations (set the drive levels, frequency bands, delays and limiting for your particular speakers)
- Configure EQ, filtering, and much more

See the Audio Architect Help files for more detailed information.

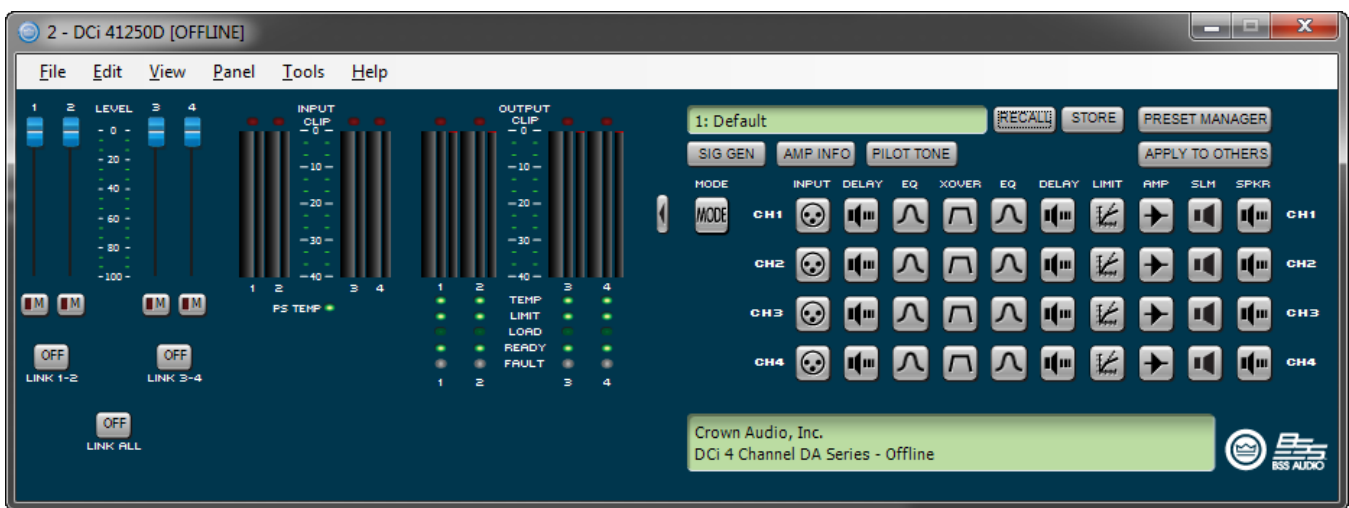

Figure 39: Onboard DSP controllable from Configuration panel

On the left of this panel is the Input and Output Signal Level Monitor. On the right side are rows of DSP selection buttons for each channel. When you double click on a button, a control panel opens for that button's function.

Also on the right are buttons that open control panels for these functions:

- Amplifier mode
- Signal generator (pink noise and sine wave)
- Amplifier information
- Recall and store presets
- Preset manager
- Apply to others (apply this amplifier's DSP settings to other devices)

These functions will be further explained on the next several pages.

Input Signal Router

Each channel of the DriveCore Install DA signal processing has an Input Signal Router that lets you choose the audio signal that will be used by the channel.

- **Analog Audio:** This selection configures the input router for analog sources. Each output channel will select its corresponding analog input. Choices for the Analog Audio input are any available analog input channels or one of the summed variants (e.g. Analog Input 1+2, Analog Input 3+4, etc.). Selecting Analog only will automatically change the MEDIUM input source to none.
- **Network Only:** This selects the audio input from the Dante port on the back panel of the amp. Each amplifier has 8 Dante input channels, as well as summed variants (e.g. Dante Inputs A+B, Dante Inputs C+D, etc.).
- **Network With Analog Backup:** The input takes the network signal as its source when the network signal or just the network clock is present. If the network lock is lost, the input switches to the selected Analog Source. Once that network lock is found again, the input switches back to the selected network source. This works even when the network signal has no audio but is sending a clock signal.
- **Analog Overrides Network:** Dante input is used as the channel's source. If the analog signal level is greater than an Analog Signal Threshold, which is user-defined, the input switches to the analog signal. As long as the analog signal level exceeds the threshold, or as long as its level falls below threshold for a user-defined hold time, the analog signal remains the channel's source.

The control operation will vary based on the mode that is selected.

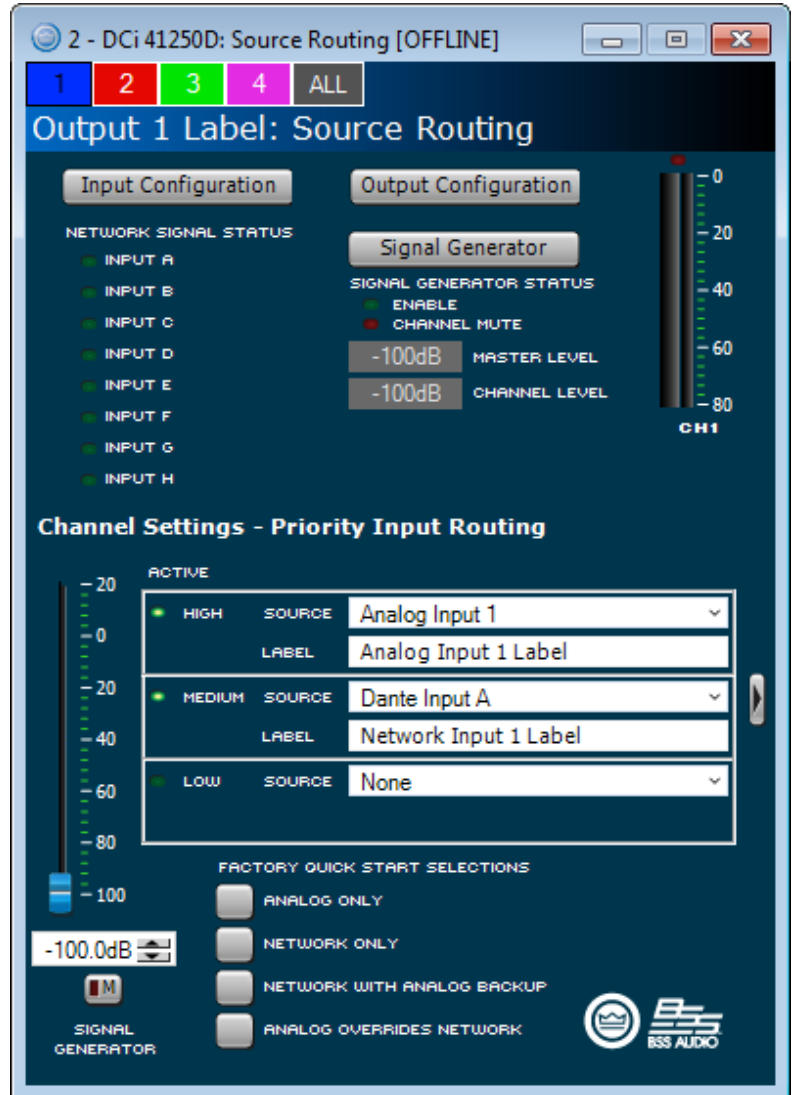

Figure 40: Basic Source Routing panel

Source Routing/Configuration



Figure 41: *Advanced Source Routing panel*

Quick Start Selection button at the bottom of the panel. Manual configuration of Threshold, Attack, Release, and Depth of Cut can be adjusted in this panel. These items are defined as follows:

- Threshold – Sets the level in dB below which the secondary input will be engaged.
- Attack – Defined as the time it takes for the secondary source to engage. This can range from 0.1 seconds to 1.0 seconds
- Release – Defined as the time it takes for the primary input to re-engage one the threshold level is exceeded.
- Depth of Cut – Defined as the level in dB of the primary source is held at if the release time is not exceeded.

Analog Only: This is the audio input from the audio connector on the back panel of the amp. Choices for the Analog Audio input are Channel 1, Channel 2, or a sum of Channels 1 and 2.

Input Delay and Driver/Output Delay

Input delay includes up to 2 seconds of delay. Output delay is typically used for driver alignment. Up to 0.1 seconds of output delay is provided. See **Figure 42**.

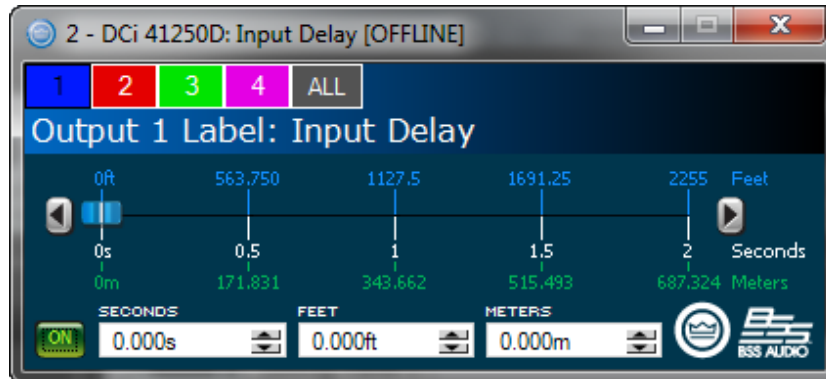

Figure 42: Delay panel

Input/Output Equalization

These panels let you adjust channel equalization for up to 8 frequencies. You can select filter type, frequency, gain, and bandwidth in octaves or Q as set by the user preferences in Audio Architect. Changes to the equalizer's frequency response can be done by typing in parameters or by click-dragging the response curve. See **Figure 43**.

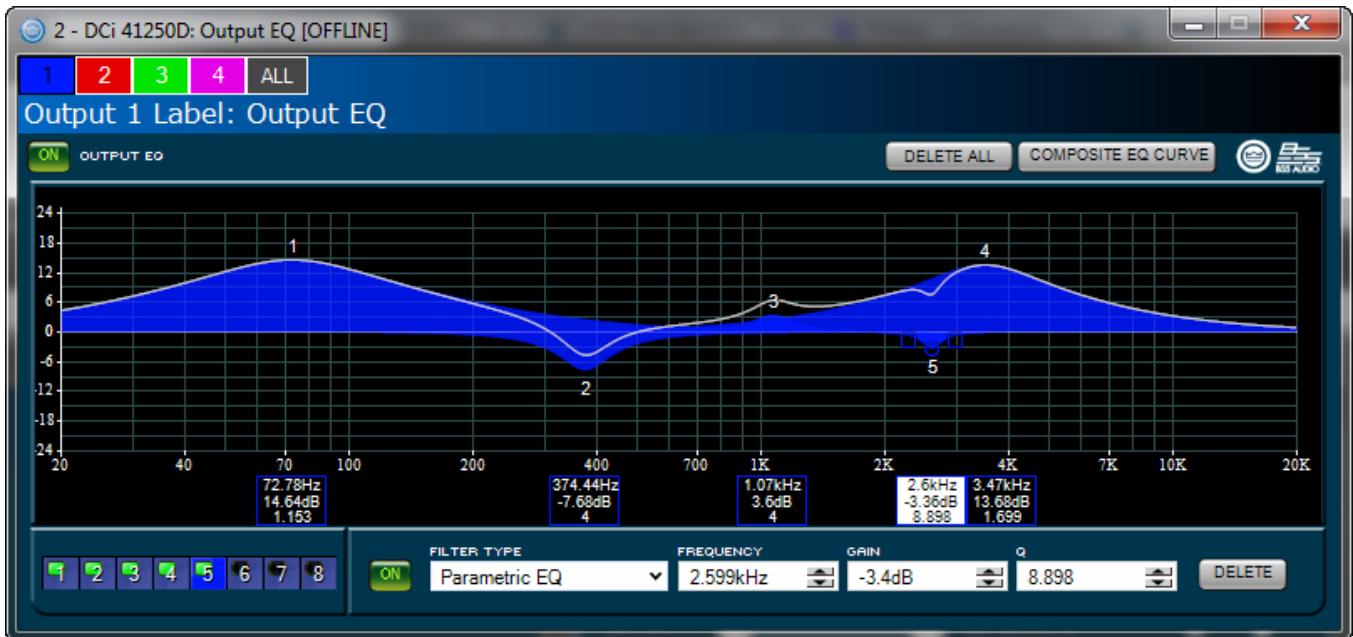

Figure 43: EQ panel

Crossover Filters

The Crossover section lets you use infinite impulse response (IIR) Crossover filter.

Each audio channel has three separate places where filters can be placed in the system: input EQ, Crossover, and Output EQ. Up to 16 EQ filters per channel are available, plus crossover filters. Each filter has up to +/-24dB of gain.

The following filters are available:

- Lowpass & Highpass:
 - Bessel 12dB/oct, 18dB/oct, 24dB/oct, 30dB/oct, 36dB/oct, 42dB/oct, 48dB/oct
 - Butterworth 12dB/oct, 18dB/oct, 24dB/oct, 30dB/oct, 36dB/oct, 42dB/oct, 48dB/oct
 - Linkwitz-Riley 24dB/oct, 36dB/oct, 48dB/oct
- Lowshelf: Low-frequency shelving EQ
- Highshelf: High-frequency shelving EQ
- Lowpass EQ: Variable bandwidth, can be expressed as Q (0.100 to 35) or Octaves (0.041 to 6.672)
- Highpass EQ: Variable Q from 0.1 to 25
- Parametric EQ: Variable Q from 0.1 to 35

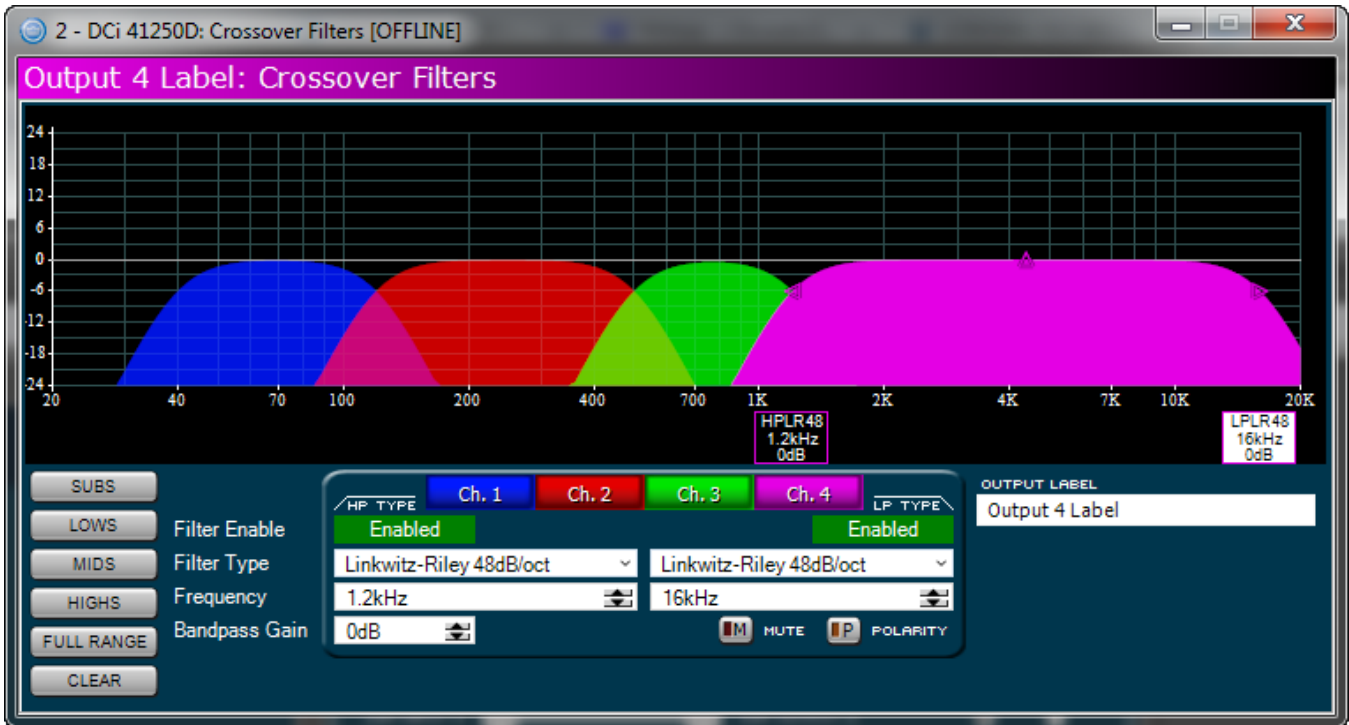

Figure 44: Crossover panel

LevelMax™ Suite

This is a suite consisting of a peak voltage limiter, RMS power limiter, clip limiter and transducer thermal limiter. First you will set the mode to automatic or advanced: See **Figure 45**.

- Automatic mode: The software determines the best settings based on the signal characteristics. You can modify only the RMS threshold, Speaker Thermal threshold and time constant. Everything else is set automatically.
- Advanced mode: You can modify the RMS threshold, Speaker Thermal threshold, time constant, Peak threshold and Peak/RMS release. Peak Voltage Limiter This limits the peak voltage output of the amplifier.
- On: Enables or disables this function. You'll set the parameters below:
- Threshold: Sets the level, in absolute voltage, which the limiter will allow from the amplifier. The range is from 1 Vpk to 255 Vpk.
- Attack Time: Sets the attack time of the limiter. The attack time is defined as the time it takes the limiter to attenuate the output signal by 20 dB. The range is from .1 millisecond to 100 milliseconds. The Instant setting attack time is instant (0 millisecond).
- Release Time: Sets the release time of the compressor. The release time is defined as the time it takes the limiter to increase the output signal by 20 dB. The range is the same range as attack time above.

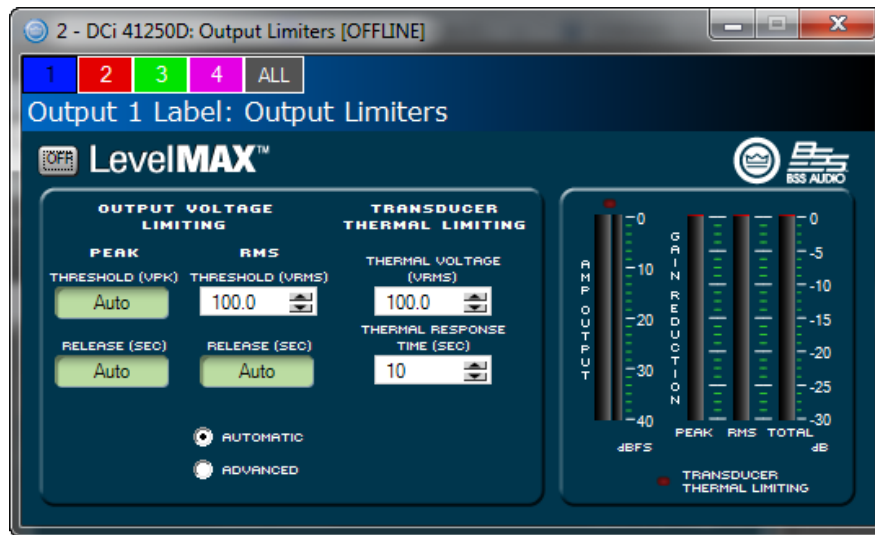

Figure 45: LevelMAX panel

Transducer Thermal Limiter

This limits the long-term output power of the amplifier to what the loudspeaker load can handle without overheating and going into thermal compression. You can set the voltage level at which the thermal limiter engages, the thermal response time and thermal voltage. Your loudspeaker manufacturer might be able to provide this information.

Meters show the amplifier output level in dBFS; and peak, RMS, and total gain reduction.

Signal Path Block Diagram

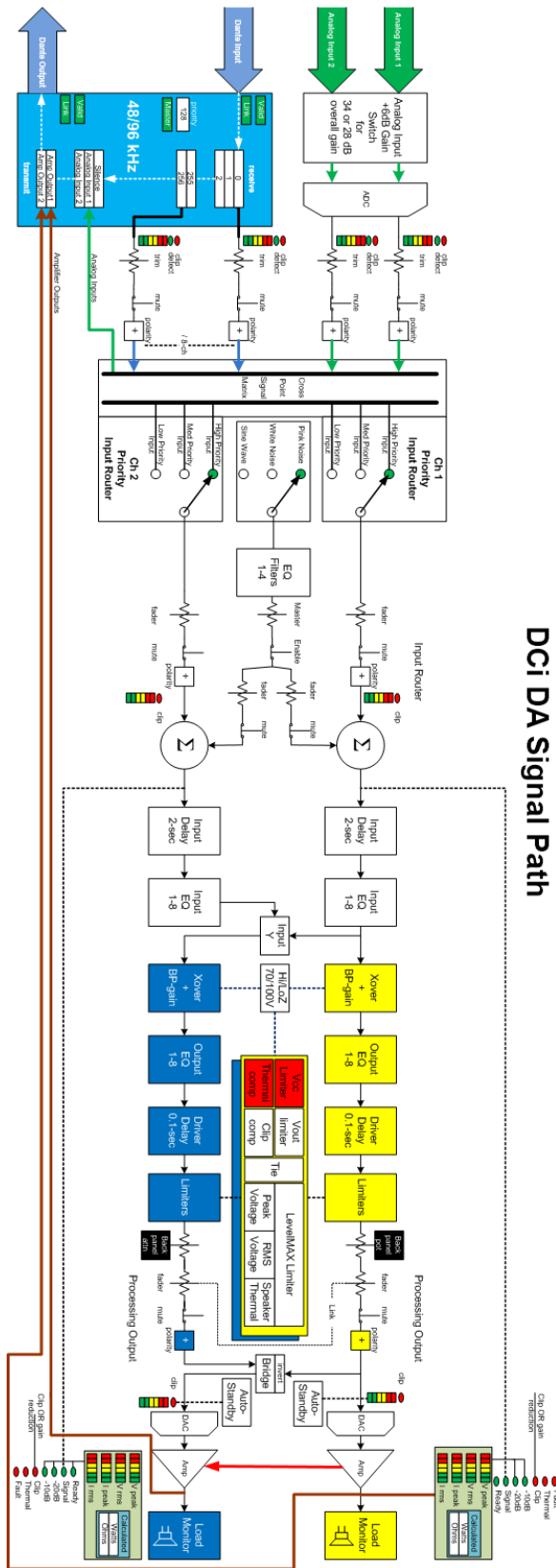

Figure 46: Signal Path Block Diagram

Protection System

Thermal Indicator

If the amplifier becomes too hot for safe operation, the channel that is generating too much heat will be shut down until the temperature drops below the thermal limit. The front-panel thermal indicator will illuminate at 80 degrees Celsius, indicating the onset of compression affecting the audio signal. The amplifier will continue to run in this state until either the temperature is reduced to a safe operating range, or if the temperature continues to rise, the channel will shut off to protect itself above 98 degrees Celsius.

Fault

The amplifier will enter a Fault state if the amplifier senses an unsafe condition. This protection is for both internal and external faults. In addition, be sure that the load connected to the amplifier is within 2 - 16 Ohm limit (4 - 16 Ohm Bridge Mono). If wiring is verified as correct and the fault condition persists, see "**Service**" on page 52 for servicing information.

Auto Insertion High-Pass Filters

A 35 Hz high-pass filter is inserted automatically when a channel is selected for Hi-Z operation.

AC Under/Over Voltage Protection

If the AC line voltage drops below 10% or rises above 10% of the nominal operating voltage of the amplifier, the amplifier's power supply turns off and the blue Power LED flashes. The amplifier will turn back on when the AC line voltage returns to safe operating levels.

Breaker

The DCi 4|1250DA and 8|600DA models utilizes a resettable breaker. Please contact Crown Service department for more information.

Fan-Cooled Chassis

DCi Series amplifiers are cooled by quiet, variable speed fans. Maximum fan noise level of a DCi amplifier is 47 dBA. The fans will pull air from the front of the amplifier to the rear of the amplifier.

The following fault conditions cause the fan to turn on full speed.

- High Frequency fault
- DC fault
- Short circuit fault
- Thermal fault
- Rail fault
- After a fault, the fan will remain at full speed for at least 60sec

Universal Switching Power Supply

The DCi Series incorporates a new switching power supply designed for extremely high efficiency and high output power. The supply includes Power Factor Correction (PFC), a Series Resonant Converter (SRC) and accepts AC supply voltages from 100 V~ to 240 V~. Microprocessor controlled diagnostic and control capabilities both optimize performance, and enhance long-term reliability.

Troubleshooting

Key	Symbol	Description
	●	Off
	◐	Flashing
	○	Off/Flashing/On
	☀	Lit

"Off/Flashing/On" above means that the LED can be off, or flashing, or on.

<p>Fault ———●</p> <p>Thermal ———●</p> <p>Clip ———●</p> <p>-10 ———●</p> <p>-20 ———●</p> <p>Signal ———●</p> <p>Ready ———●</p> <p style="text-align: right;">Bridge</p>	<p>Power ●</p> <p>Data ●</p>	<p>CONDITION: Power indicator is off. Mains indicator is on.</p> <p>POSSIBLE REASON:</p> <ul style="list-style-type: none"> The amplifier's Power switch is off.
-------------------------------------------------------------------------------------------------------------------------------------------------------------------------	------------------------------	----------------------------------------------------------------------------------------------------------------------------------------------------------------------------------------

<p>Fault ———●</p> <p>Thermal ———●</p> <p>Clip ———●</p> <p>-10 ———●</p> <p>-20 ———●</p> <p>Signal ———●</p> <p>Ready ———●</p> <p style="text-align: right;">Bridge</p>	<p>Power ●</p> <p>Data ●</p>	<p>CONDITION: Power indicator is off. Mains indicator is off.</p> <p>POSSIBLE REASON:</p> <ul style="list-style-type: none"> The power supply breaker has tripped. The amplifier has lost AC Power. The amplifier is not plugged in to the power receptacle.
-------------------------------------------------------------------------------------------------------------------------------------------------------------------------	------------------------------	------------------------------------------------------------------------------------------------------------------------------------------------------------------------------------------------------------------------------------------------------------------------------------------------------

<p>Fault ———●</p> <p>Thermal ———●</p> <p>Clip ———●</p> <p>-10 ———●</p> <p>-20 ———●</p> <p>Signal ———●</p> <p>Ready ———●</p> <p style="text-align: right;">Bridge</p>	<p>Power ◐</p> <p>Data ●</p>	<p>CONDITION: Power indicator is flashing.</p> <p>POSSIBLE REASON:</p> <ul style="list-style-type: none"> The AC line voltage has dropped below 10% or has risen above 10% of the nominal line voltage of the power supply. When the Amp is in Sleep Mode as set by the AUX Port, the amplifier will not power up until the ground closure on the AUX Port is released. When the power button is pushed in this condition, the Power Indicator will flash for 2 – 3 seconds.
-------------------------------------------------------------------------------------------------------------------------------------------------------------------------	------------------------------	-------------------------------------------------------------------------------------------------------------------------------------------------------------------------------------------------------------------------------------------------------------------------------------------------------------------------------------------------------------------------------------------------------------------------------------------------------------------------------------------------------------

<p>Fault ———●</p> <p>Thermal ☀</p> <p>Clip ———●</p> <p>-10 ———●</p> <p>-20 ———●</p> <p>Signal ———●</p> <p>Ready ———●</p> <p style="text-align: right;">Bridge</p>	<p>Power ☀</p> <p>Data ○</p>	<p>CONDITION: Thermal indicator is on.</p> <p>POSSIBLE REASON:</p> <ul style="list-style-type: none"> The amplifier is becoming too hot for safe operation. Allow amplifier to cool. Check for loads less than 2Ω, and for excessive input levels. Check for proper ventilation and proper mode-switch setting.
----------------------------------------------------------------------------------------------------------------------------------------------------------------------	------------------------------	---------------------------------------------------------------------------------------------------------------------------------------------------------------------------------------------------------------------------------------------------------------------------------------------------------------------------------------

<p>Fault ◐</p> <p>Thermal ———●</p> <p>Clip ———●</p> <p>-10 ———●</p> <p>-20 ———●</p> <p>Signal ———●</p> <p>Ready ———●</p> <p style="text-align: right;">Bridge</p>	<p>Power ☀</p> <p>Data ●</p>	<p>CONDITION: Fault indicator is flashing.</p> <p>POSSIBLE REASON:</p> <ul style="list-style-type: none"> There are a number of conditions that result in the Fault indicator flashing: temperature above 98C, DC/LF protection is engaged, HF detect, output short circuit detected. These conditions should all be checked and attempted to be resolved before the amp is shipped back for service.
----------------------------------------------------------------------------------------------------------------------------------------------------------------------	------------------------------	-----------------------------------------------------------------------------------------------------------------------------------------------------------------------------------------------------------------------------------------------------------------------------------------------------------------------------------------------------------------------------------------------------------------------------

CONDITION: Distorted sound.

POSSIBLE REASON:

- Load is wired incorrectly or Stereo/Bridge mode switch is set incorrectly. Check both.
- Input is overloaded by a signal level that is too high. Turn down your amplifier level controls, or turn down the input signal, until the clip light goes out.

NOTE: If the signal sounds distorted even though the Clip LED is off, the input signal may be distorted before it reaches the amplifier input. Check gain staging and output levels of the mixer or preamp..

Key

- Off
- ◐ Flashing
- Off/Flashing/On
- ☀ Lit

“Off/Flashing/On” above means that the LED can be off, or flashing, or on.

CONDITION: No sound, even though the amp has power.

POSSIBLE REASON:

- Speakers not connected.
- Open circuit due to speaker failure.

POSSIBLE REASON:

- Based on the front panel LEDs, determine which channel has a short. Remove the associated input connector to ensure that no voltage will be present on the output. Remove the shorted load (and possibly attached cables) and have it checked by a qualified technician. If the shorted condition remains after the load is removed, the unit should be sent into a qualified service center.

- Ready LED is off. Channel has been set to Sleep mode via the Aux port or Power Save mode.

Fault —●
Thermal —●

Clip —●
-10 —●
-20 —●
Signal —●
Ready —☀

Power ☀
Data ○



Bridge

CONDITION: No input signal.

Signal indicator is not flashing even though audio is applied and the channel is ready.

POSSIBLE REASON:

- Input signal level is very low.

Power ☀
Data ●



Bridge

CONDITION: Bridge LED is lit.

POSSIBLE REASON:

- Amplifier is in Bridge Mono mode.

Key	●	Off
	☀	Flashing
	○	Off/Flashing/On
	☀	Lit

“Off/Flashing/On” above means that the LED can be off, or flashing, or on.

DCi DA Specifications

Dual Mode — All Channels Driven

DCi Dante Model	Channels	2Ω	4Ω	8Ω	16Ω	70Vrms	100Vrms
8I600DA	8	300W	600W	600W	300W	600W	600W
4I1250DA	4	1250W	1250W	1250W	625W	1250W	1250W

Minimum Guaranteed Power (20 Hz - 20 kHz)

Bridge Mono Mode — All Channels Driven

DCi Dante Model	4Ω	8Ω	16Ω	140Vrms	200Vrms
8I600DA	600W	1200W	1200W	1200W	1200W
4I1250DA	2500W	2500W	2500W	2500W	2500W

Minimum Guaranteed Power (20 Hz - 20 kHz)

Input Sensitivity

DCi Dante Model	8Ω	70Vrms	100Vrms
8I600DA	1.4Vrms	1.4Vrms	2.0Vrms
4I1250DA	2.0Vrms	1.4Vrms	2.0Vrms

Dimensions

DCi Dante Model	Width	Height	Depth
8I600DA	19 in. (48.3 cm)	3.5 in. (8.9 cm)	17 in. (43.2 cm)
4I1250DA	19 in (48.3 cm)	3.5 in. (8.9 cm)	17 in. (43.2 cm)

Performance Specifications

	8 600DA	4 1250DA
Voltage Gain (at maximum level setting) 4/8 Ω , 70Vrms and 100Vrms Operation	34dB	
Frequency Response (8 Ω , 20Hz - 20kHz)	± 0.25 dB	
Dante Signal-to-Noise Ratio (ref. rated power, 8 Ω , 20Hz - 20kHz)	>108dB	
Total Harmonic Distortion (at full rated power, from 20Hz - 20kHz)	0.35%	
Analog Input Signal to Noise Ratio (ref. rated power, 8 Ω , 20Hz - 20kHz)	>104dB	
Intermodulation Distortion (60Hz and 7kHz at 4:1, from - 30dB to full rated power)	≤ 0.35 %	
Damping Factor (20Hz to 100Hz)	>1000	>1500
Crosstalk (below rated power, 20Hz to 1kHz)	>80dB	
Common Mode Rejection (20Hz to 1kHz, typical)	>70dB	
DC Output Offset (with inputs shorted)	± 10 mV	
Input Impedance (Nominally balanced, nominally unbalanced)	10 k Ω , 5 k Ω	
Maximum Input Level (Low Gain Mode)	+20dBu	
Required AC Mains (± 10 %)	100Vrms - 240Vrms~ 50/60Hz	
Cooling	Continuously variable speed forced air, front-to-back airflow	
Power Supply Connector	20A IEC connector	
Load Impedance Stereo/Dual Mode	2 Ω - 16 Ω ; 70Vrms and 100Vrms	
Load Impedance Bridge Mono	4 Ω - 16 Ω ; 140Vrms and 200Vrms	
Maximum Fan Noise (re dB SPL @ 1M)	47	
Weight	30 lbs (13.60 kg)	

AC Power Draw and Thermal Dissipation

AC Power Draw and Thermal Dissipation:

Pink noise 12dB crest factor, bandwidth limited 22Hz to 22kHz.
 Typical line impedance used.
 Data based on all channels driven.

DCi 4 1250DA - Bridge									
P1-32		120 VAC / 60 Hz				230 VAC / 50 Hz			
Condition	Load	"Line current (amps)"	Power Dissipated as Heat			"Line current (amps)"	Power Dissipated as Heat		
			watts	BTU	kcal/hr		watts	BTU	kcal/hr
At Idle Awake	N/A	1.6	183	625	157	0.9	183	625	157
1/8 Power Pink Noise Typical of program material just at clip	4Ω	8.4	309	1054	266	4.3	238	813	205
	8Ω	8.0	263	898	226	3.8	207	707	178
	16Ω	7.4	232	792	200	3.8	216	737	186
	140V (8Ω)	7.3	227	775	195	4.3	230	785	198
	200V (16Ω)	7.6	226	773	195	3.9	229	781	197
1/3 Power Pink Noise Typical of program material at extreme clip	4Ω	19.5	533	1819	458	10.0	419	1432	361
	8Ω	17.5	384	1311	330	9.5	414	1412	356
	16Ω	17.5	365	1246	314	9.0	292	997	251
	140V (8Ω)	16.8	330	1128	284	8.8	345	1176	296
	200V (16Ω)	17.1	334	1139	287	9.0	291	991	250

DCi 4 1250DA - Dual									
P1-32		120 VAC / 60 Hz				230 VAC / 50 Hz			
Condition	Load	"Line current (amps)"	Power Dissipated as Heat			"Line current (amps)"	Power Dissipated as Heat		
			watts	BTU	kcal/hr		watts	BTU	kcal/hr
At Idle Awake	N/A	1.6	183	625	157	0.9	184	628	158
1/8 Power Pink Noise Typical of program material just at clip	2Ω	8.9	217	740	187	4.5	230	787	198
	4Ω	9.0	245	835	210	4.3	215	734	185
	8Ω	8.3	232	792	200	3.9	195	665	168
	70V (4Ω)	8.5	220	751	189	4.4	198	675	170
	100V (8Ω)	7.6	219	747	188	3.9	177	604	152
1/3 Power Pink Noise Typical of program material at extreme clip	2Ω	21.3	443	1512	381	10.6	405	1382	348
	4Ω	20.3	397	1357	342	9.3	300	1025	258
	8Ω	18.0	301	1027	259	8.8	249	851	215
	70V (4Ω)	17.1	289	988	249	9.0	262	896	226
	100V (8Ω)	17.4	278	950	240	9.1	265	904	228

AC Power Draw and Thermal Dissipation:

Pink noise 12dB crest factor, bandwidth limited 22Hz to 22kHz.

Typical line impedance used.

Data based on all channels driven.

DCi 8 600DA - Bridge									
15004563770			120 VAC / 60 Hz			230 VAC / 50 Hz			
Condition	Load	"Line current (amps)"	Power Dissipated as Heat			"Line current (amps)"	Power Dissipated as Heat		
			watts	BTU	kcal/hr		watts	BTU	kcal/hr
At Idle Awake	N/A	1.9	218	744	188	1.0	220	751	189
1/8 Power Pink Noise Typical of program material just at clip	4Ω	5.4	330	1126	284	2.8	325	1109	279
	8Ω	8.1	346	1181	298	4.2	335	1144	288
	16Ω	7.7	306	1044	263	3.8	276	941	237
	140V (16Ω)	7.7	300	1023	258	3.9	285	973	245
	200V (33.33Ω)	7.5	281	960	242	3.9	272	929	234
1/3 Power Pink Noise Typical of program material at extreme clip	4Ω	10.8	468	1597	403	5.4	445	1519	383
	8Ω	17.9	530	1810	456	9.0	476	1625	410
	16Ω	17.0	421	1437	362	8.7	389	1328	335
	140V (16Ω)	17.3	439	1500	378	8.8	382	1305	329
	200V (33.33Ω)	17.0	412	1407	355	8.6	342	1168	294

DCi 8 600DA - Dual									
15004563770			120 VAC / 60 Hz			230 VAC / 50 Hz			
Condition	Load	"Line current (amps)"	Power Dissipated as Heat			"Line current (amps)"	Power Dissipated as Heat		
			watts	BTU	kcal/hr		watts	BTU	kcal/hr
At Idle Awake	N/A	1.9	222	756	191	1.0	221	754	190
1/8 Power Pink Noise Typical of program material just at clip	2Ω	5.5	336	1147	298	3.0	332	1133	286
	4Ω	8.2	363	1241	313	4.4	348	1186	299
	8Ω	7.8	314	1071	270	4.1	293	999	252
	70V (16.33Ω)	7.6	307	1047	264	4.0	289	979	274
	100V (33.33Ω)	7.8	293	1001	252	3.9	262	896	226
1/3 Power Pink Noise Typical of program material at extreme clip	2Ω	11.0	498	1700	429	5.9	476	1625	410
	4Ω	17.5	510	1739	438	10.0	547	1868	471
	8Ω	17.4	467	1593	402	9.1	421	1437	362
	70V (16.33Ω)	17.0	446	1522	384	9.0	393	1342	338
	100V (33.33Ω)	16.8	419	1430	360	8.9	362	1234	311

Warranty (United States Only)

SUMMARY OF WARRANTY

Crown International, 1718 West Mishawaka Road, Elkhart, Indiana 46517-4095 U.S.A. warrants to you, the ORIGINAL PURCHASER and ANY SUBSEQUENT OWNER of each NEW Crown product, for three years from the date of purchase by the original purchaser (the "warranty period") that the new Crown product is free of defects in materials and workmanship. We further warrant the new Crown product regardless of the reason for failure, except as excluded in this Warranty.



**Warranty is only valid within the United States of America. For information on Warranty outside of the U.S.A, please contact your local distributor.*

ITEMS EXCLUDED FROM THIS CROWN WARRANTY

This Crown Warranty is in effect only for failure of a new Crown product which occurred within the Warranty Period. It does not cover any product which has been damaged because of any intentional misuse, accident, negligence, or loss which is covered under any of your insurance contracts. This Crown Warranty also does not extend to the new Crown product if the serial number has been defaced, altered, or removed.

WHAT THE WARRANTOR WILL DO

We will remedy any defect, regardless of the reason for failure (except as excluded), by repair, replacement, or refund. We may not elect refund unless you agree, or unless we are unable to provide replacement, and repair is not practical or cannot be timely made. If a refund is elected, then you must make the defective or malfunctioning product available to us free and clear of all liens or other encumbrances. The refund will be equal to the actual purchase price, not including interest, insurance, closing costs, and other finance charges less a reasonable depreciation on the product from the date of original purchase. Warranty work can only be performed at our authorized service centers or at the factory. Warranty work for some products can only be performed at our factory. We will remedy the defect and ship the product from the service center or our factory within a reasonable time after receipt of the defective product at our authorized service center or our factory. All expenses in remedying the defect, including surface shipping costs in the United States, will be borne by us. (You must bear the expense of shipping the product between any foreign country and the port of entry in the United States including the return shipment, and all taxes, duties, and other customs fees for such foreign shipments.)

HOW TO OBTAIN WARRANTY SERVICE

You must notify us of your need for warranty service within the warranty period. All components must be shipped in a factory pack, which, if needed, may be obtained from us free of charge. Corrective action will be taken within a reasonable time of the date of receipt of the defective product by us or our authorized service center. If the repairs made by us or our authorized service center are not satisfactory, notify us or our authorized service center immediately.

DISCLAIMER OF CONSEQUENTIAL AND INCIDENTAL DAMAGES

YOU ARE NOT ENTITLED TO RECOVER FROM US ANY INCIDENTAL DAMAGES RESULTING FROM ANY DEFECT IN THE NEW CROWN PRODUCT. THIS INCLUDES ANY DAMAGE TO ANOTHER PRODUCT OR PRODUCTS RESULTING FROM SUCH A DEFECT. SOME STATES DO NOT ALLOW THE EXCLUSION OR LIMITATIONS OF INCIDENTAL OR CONSEQUENTIAL DAMAGES, SO THE ABOVE LIMITATION OR EXCLUSION MAY NOT APPLY TO YOU.

WARRANTY ALTERATIONS

No person has the authority to enlarge, amend, or modify this Crown Warranty. This Crown Warranty is not extended by the length of time which you are deprived of the use of the new Crown product. Repairs and replacement parts provided under the terms of this Crown Warranty shall carry only the unexpired portion of this Crown Warranty.

DESIGN CHANGES

We reserve the right to change the design of any product from time to time without notice and with no obligation to make corresponding changes in products previously manufactured.

LEGAL REMEDIES OF PURCHASER

THIS CROWN WARRANTY GIVES YOU SPECIFIC LEGAL RIGHTS, YOU MAY ALSO HAVE OTHER RIGHTS WHICH VARY FROM STATE TO STATE. No action to enforce this Crown Warranty shall be commenced after expiration of the warranty period.

THIS STATEMENT OF WARRANTY SUPERSEDES ANY OTHERS CONTAINED IN THIS MANUAL FOR CROWN PRODUCTS. 04/15

Service

Crown products are quality units that rarely require servicing. Before returning your unit for servicing, please contact Crown Technical Support to verify the need for servicing.

Warranty is only valid within the country in which the product was purchased.

This unit has very sophisticated circuitry which should only be serviced by a fully trained technician. This is one reason why each unit bears the following label:



CAUTION: To prevent electric shock, do not remove covers. No user serviceable parts inside. Refer servicing to a qualified technician.

Complete the Service Return Authorization form in the back of this manual, when returning a Crown product to the factory or authorized service center. The form must be included with your product inside the box or in a packing slip envelope securely attached to the outside of the shipping carton. Do not send this form separately.

Worldwide Service

Service may be obtained from an authorized service center (contact your local Crown/Amcron representative or our office for a list of authorized service centers). To obtain service, simply present the bill of sale as proof of purchase along with the defective unit to an authorized service center. They will handle the necessary paperwork and repair.

Remember to transport your unit in the original factory pack.

US and Canada Service

Service may be obtained in one of two ways: from an authorized service center or from the factory. You may choose either. It is important that you have your copy of the bill of sale as your proof of purchase.

Service at a US or Canada Service Center

This method usually saves the most time and effort. Simply present your bill of sale along with the defective unit to an authorized service center to obtain service. They will handle the necessary paperwork and repair. Remember to transport the unit in the original factory pack. A list of authorized service centers in your area can be obtained from Crown Factory Service, or online from www.crownaudio.com/en/support/service_lookup

Factory Service

Crown accepts no responsibility for non-serviceable product that is sent to us for factory repair. It is the owner's responsibility to ensure that their product is serviceable prior to sending it to the factory.

A Service Return Authorization (SRA) is required for product being sent to the factory for repair. An SRA can be completed online at www.crownaudio.com/support/rma. If you do not have access to the web, please call Customer Service at 574.294.8200 or 800.342.6939 extension 8205 in North America, Puerto Rico and the Virgin Islands only.

For warranty service, we will pay for ground shipping both ways in the United States. Contact Customer Service to obtain prepaid shipping labels prior to sending the unit. Or, if you prefer, you may prepay the cost of shipping, and HARMAN will reimburse you. Send copies of the shipping receipts to HARMAN to receive reimbursement.

Your repaired unit will be returned via UPS ground. Please contact us if other arrangements are required.

Factory Service Shipping Instructions

1. Service Return Authorization (SRA) is required for product being sent to the factory for service. Please complete the SRA by going to www.crownaudio.com/support/rma. If you do not have access to our website, call 1.800.342.6939, extension 8205 and we will create the SRA for you.
2. See packing instructions that follow.
3. Ship product to:
HARMAN Factory Service
1718 W Mishawaka Rd.
Elkhart, IN 46517
4. Use a bold black marker and write the SRA number on three sides of the box.
5. Record the SRA number for future reference. The SRA number can be used to check the repair status.

Packing Instructions

Important: These instructions must be followed. If they are not followed, HARMAN International, Inc. assumes no responsibility for damaged goods and/or accessories that are sent with your unit.

1. Fill out and include the Service Return Authorization Request in the back of this manual.
2. Do not ship any accessories (manuals, cords, hardware, etc.) with your unit. These items are not needed to service your product. We will not be responsible for these items.
3. When shipping your Crown product, it is important that it has adequate protection. We recommend you use the original pack material when returning the product for repair. If you do not have the original box, please call HARMAN at 800.342.6939 or 574.294.8210 and order new pack material. (Do not ship your unit in a wood or metal cabinet).
4. If you provide your own shipping pack, the minimum recommended requirements for materials are as follows:
 - a. 275 P.S.I. burst test, double-wall carton that allows for 2-inch solid Styrofoam on all six sides of unit or 3 inches of plastic bubble wrap on all six sides of unit.
 - b. Securely seal the package with an adequate carton sealing tape.
 - c. Do not use light boxes or "peanuts". Damage caused by poor packaging will not be covered under warranty.

Enclose the completed Service Return Authorization Request (or securely attach it to the outside of carton) and re-seal the shipping pack with a sturdy carton sealing tape.

Estimate Approval

Approval of estimate must be given within 30 days after being notified by HARMAN International. Units still in the possession of HARMAN after 30 days of the estimate will become the property of HARMAN International.

Payment of Non-Warranty Repairs

Payment on out-of-warranty repairs must be received within 30 days of the repair date. Units unclaimed after 30 days become the property of HARMAN International.

If you have any questions, please contact HARMAN.

HARMAN Factory Service

1718 W. Mishawaka Rd.,
Elkhart, Indiana 46517 U.S.A.

Telephone:

574-294-8200
800-342-6939 (North America, Puerto Rico, and Virgin Islands only)

Facsimile:

574-294-8301 (Technical Support)
574-294-8124 (Factory Service)

Web site:

www.crownaudio.com

Service Return Authorization Request

Shipping Address: HARMAN Factory Service, 1718 W. Mishawaka Rd., Elkhart, IN 46517
You may also request a service return authorization at www.crownaudio.com/support/rma

PLEASE PRINT CLEARLY

SRA #: _____ (If sending product to Crown factory service)
Model: _____ Serial Number: _____ Purchase Date: _____

PRODUCT RETURN INFORMATION

Individual or Business Name: _____
Phone #: _____ Fax #: _____ E-Mail: _____
Street Address (please, no P.O. Boxes): _____
City: _____ State/Prov: _____ Postal Code: _____ Country: _____
Nature of problem: _____

Other equipment in your system: _____

If warranty is expired, please provide method of payment. Proof of purchase may be required to validate warranty.

PAYMENT OPTIONS

- I have open account payment terms. Purchase order required. PO#: _____ COD
- Credit Card (Information below is required; however if you do not want to provide this information at this time, we will contact you when your unit is repaired for the information.)

Credit card information:

Type of credit card: MasterCard Visa American Express Discover

Type of credit card account: Personal/Consumer Business/Corporate

Card # _____ Exp. date: _____ *Card ID #: _____

*Card ID # is located on the back of the card following the credit card #, in the signature area. On American Express, it may be located on the front of the card. This number is required to process the charge to your account. If you do not want to provide it at this time, we will call you to obtain this number when the repair of your unit is complete.

Name on credit card: _____

Billing address of credit card: _____

