



152 Robbins Rd, Downingtown, PA, 19335, USA - HuddleCamHD.com | 1 800 - 486-5276

HuddleCamHD 30x

USB 3.0 PTZ CAMERA

INSTALLATION & OPERATION MANUAL





Precautions.....

Safety Tips.....

- Please read this manual carefully before using the camera.
- Avoid damage from stress, violent vibration or liquid intrusion during transportation, storage or installation.
- Take care of the camera during installation to prevent damage to the camera case, ports, lens or PTZ mechanism.
- Do not apply excessive voltage. (Use only the specified voltage.) Otherwise, you may experience electrical shock.
- Keep the camera away from strong electromagnetic sources.
- Do not aim the camera at bright light sources (e.g. bright lights, the sun, etc.) for extended periods of time.
- Do not clean the camera with any active chemicals or corrosive detergents.
- Do not disassemble the camera or any of the camera's components. If problems arise, please contact your authorized dealer.
- After long term operation, moving components can wear down. Contact your authorized dealer for repair.

Supplied Accessories.....

- HD Color Video Camera (1)
- 12V/2.0A DC Power Adapter (1)
- Installation Bracket (1)
- Installation Screw (1)
- USB 3.0 Data Cable (3m), Serial Control Cable, RS-232C to RS-485 Adaptor
- IR Remote Controller (1)
- User Manual (1)

Physical Description.....

1. Front View.....



1. **Lens**
2. **IR Receiver**
To receive IR remote controller signal.
3. **Power LED**
Blue LED lights when unit is powered and on.
4. **Stand by LED**
Orange LED lights when unit is powered and in standby.
5. **IR Receiver**
To receive IR remote controller signal.

2. Rear View.....

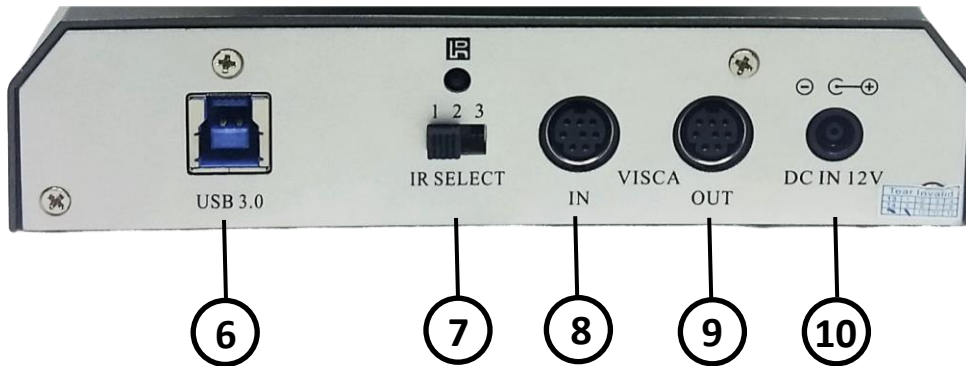

6. USB 3.0 Interface

For connection to PC USB 3.0 port (also compatible with USB 2.0 port and driver).

7. IR Selective Switch

When using only one remote to control more than one camera, this switch will assign a unique ID to each camera.

8. VISCA IN Port

For hard wired remote control from a 3rd party PC, joystick, etc...

9. VISCA Out Port/RS485

Used for daisy chaining multiple cameras for RS-232 RS-485 control.

10. DC IN 12V Socket

Only use the Power Adapter supplied with this camera.

2. Bottom View.....

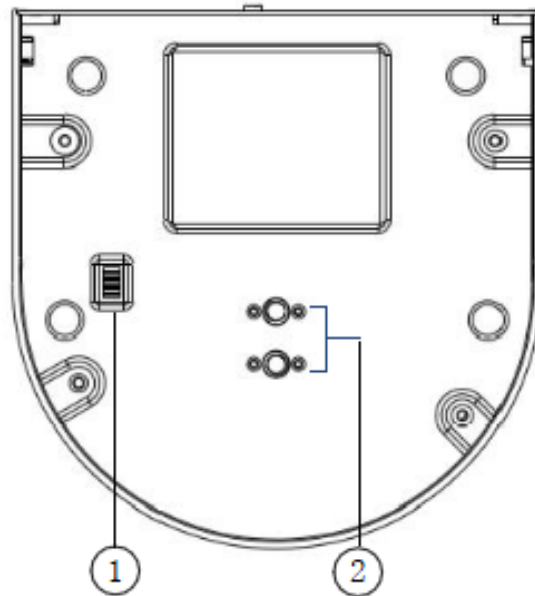

1. Tripod

Will accept 1/4-20 bolt from 3rd party tripod, wall or ceiling mount.

2. Dip-Switch

Used for selecting baud rate and the remote signal output switch.

4. Dip-Switch Settings.....

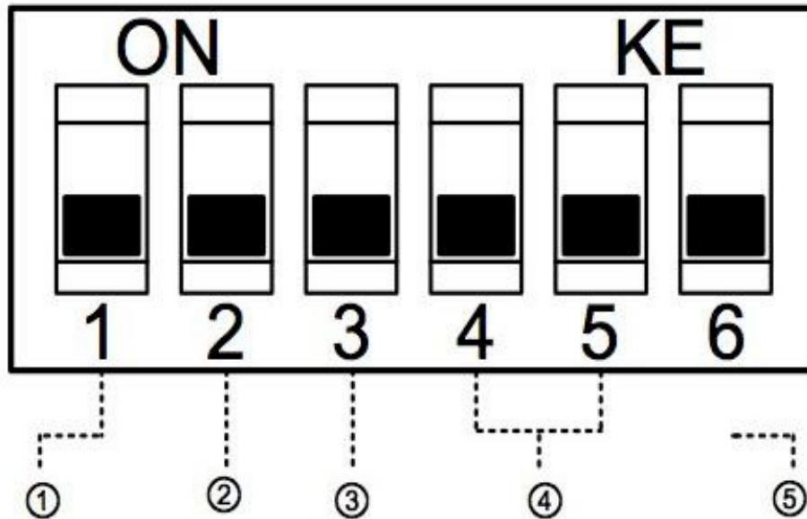

Note: When changing Dip-Switch settings, make all changes with camera powered off.

Dip-Switch 1 - (To set communication baud rate).

Dip-Switch 2 - (To set control protocol).

Dip-Switch 3 - (Set only for firmware upgrading).

Dip Switch 4 & 5 - (To set camera's RS232/RS485 ID number - for daisy chain wired control).

Camera address code setting

	Dip-switch4	Dip-switch 5
1	OFF	OFF
1	OFF	ON
2	ON	OFF
3	ON	ON

[Cable Connection Info.....](#)

[VISCA RS-232C - IN Reference.....](#)

VISCA RS-232C IN

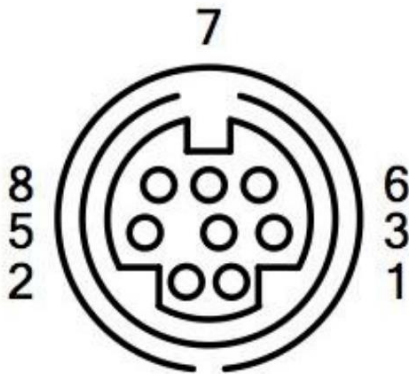

Pin S/N	Function
1	DTR IN
2	DSR IN
3	TXD IN
4	GND
5	RXD IN
6	GND
7	IR Commander Signal OUTPUT
8	NO Connection

[VISCA RS-232C - Out Reference.....](#)

VISCA RS-232C OUT

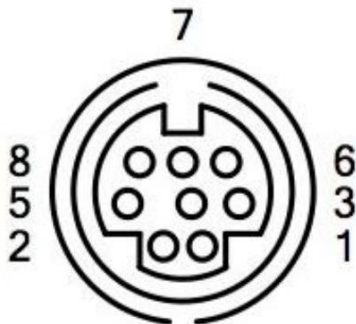

Pin S/N	Function	
	RS-232	RS-485
1	DTR OUT	TX+
2	DSR OUT	TX-
3	TXD OUT	
4	GND	
5	RXD OUT	
6	GND	
7		RS-485 -
8		RS-485 +



OSD MENU.....

On Screen Display Menu - Use the OSD menu to access and change the camera's settings.

Note: You cannot manually move the camera (pan/tilt) when the OSD menu is visible on the screen.

The Dome OSD Menu is as follows:

- **Pan Speed** **Default Value: 20**
 - Set speed of Pan motor
 - Range = 1 - 63
- **Tilt Speed** **Default Value: 20**
 - Set speed of Pan motor
 - Range = 1 - 63
- **Scan Speed (Auto Pan Mode)** **Default Value: 6**
 - Set speed of boundary scan
 - Range = 1 - 63
- **Tour Path (uses presets)** **Default Value: 1**
 - Select desired tour path
 - Range = 1 - 4
- **Tour Dwell** **Default Value: 5**
 - Set duration to dwell on each preset
 - Range = 1 - 60
- **Proportion** **Default Value: On**
 - Set Proportion - Range
 - On - Off
- **Auto Rev** **Default Value: P**
 - Set camera mounting orientation
 - N for inverted ceiling mount
- **Frame** **Default Value: 60Hz**
 - Set Refresh Rate
 - Range = 50Hz or 60 Hz



152 Robbins Rd, Downingtown, PA, 19335, USA - HuddleCamHD.com | 1 800 - 486-5276

The Lens OSD Menu is as follows:

- **DISPLAY** Default Value: OFF
 - ON/OFF
- **DZOOM** Default Value: OFF
 - ON/OFF
- **BACKLIGHT** Default Value: OFF
 - ON/OFF
- **NR (Noise Reduction)** Default Value: 3
 - Adjustable Value: 0-5
- **WB (White Balance)** Default Value: Auto
 - Auto/Manual/Outdoor/Indoor/One Push/ATW

(Manual Settings):

- **R GAIN (Red Gain)** Default Value: 64
 - Adjustable Scope: 0-255
- **B GAIN (Blue Gain)** Default Value: 84
 - Adjustable Scope: 0-255
- **AE (Auto Exposure)** Default Value: Auto
 - Auto/Manual/Shutter/Iris/Bright

(Manual Settings):

- **SHUTTER** Default Value: 1/1
 - Shutter Speed Range: 1/1-1/10000
- **IRIS** Default Value: Close
 - Close/F1.4-f22
- **BRIGHT** Default Value: 0
 - Set Brightness 0 - 31

IR Remote Controller (Note: Some buttons do not operate for all camera models)

1. **Reset:**
Restarts the camera and restores it to Factory Default settings.
(Note: Will delete all memory).
2. **Camera Selection**
Select Camera ID: 1, 2 or 3
3. **Preset Positions**
1-9: Preset Positions
Set: Setting Preset Position
Clear: Clear Preset Position
Call: Call Preset Position
Note: If you want to set (or call) the first preset position to 1, you should press number key "1", then press "Set" (or "Call") to set (call) the position.
4. **Fast Zoom in/out Control Zone**
+: Zoom in quickly
-: Zoom out quickly
5. **Pan/Tilt Controller**
 - ↑ Move Up
 - ↓ Move Down
 - ← Move Left
 - Move Right
 - ⏪ Auto Pan
6. **Additional Function Zone**
Freeze: Image Freeze
BL: Back-light Compensation
WB: White Balance
AE: Auto Exposure
D Zoom: Digital Zoom
HDMI: Swap to HDMI video output
DVI: Swap to DVI video output
Format: Swap between different formats
7. **Power Supply Switch**
Switch for turning camera on (i.e. Stand-By mode vs. Working mode)
8. **OSD Menu Zone**
Dome OSD: Enter Pan Tilt Zoom OSD menu
Lens OSD: Enter lens OSD menu
9. **Slow Zoom In/Out Zone**
+: Zoom in slowly
-: Zoom out slowly
10. **Focus Control Zone**
Auto: Turn on auto focus
Manual: Turn on manual focus
Far: Set focus at farther distance
Near: Set focus at nearer distance

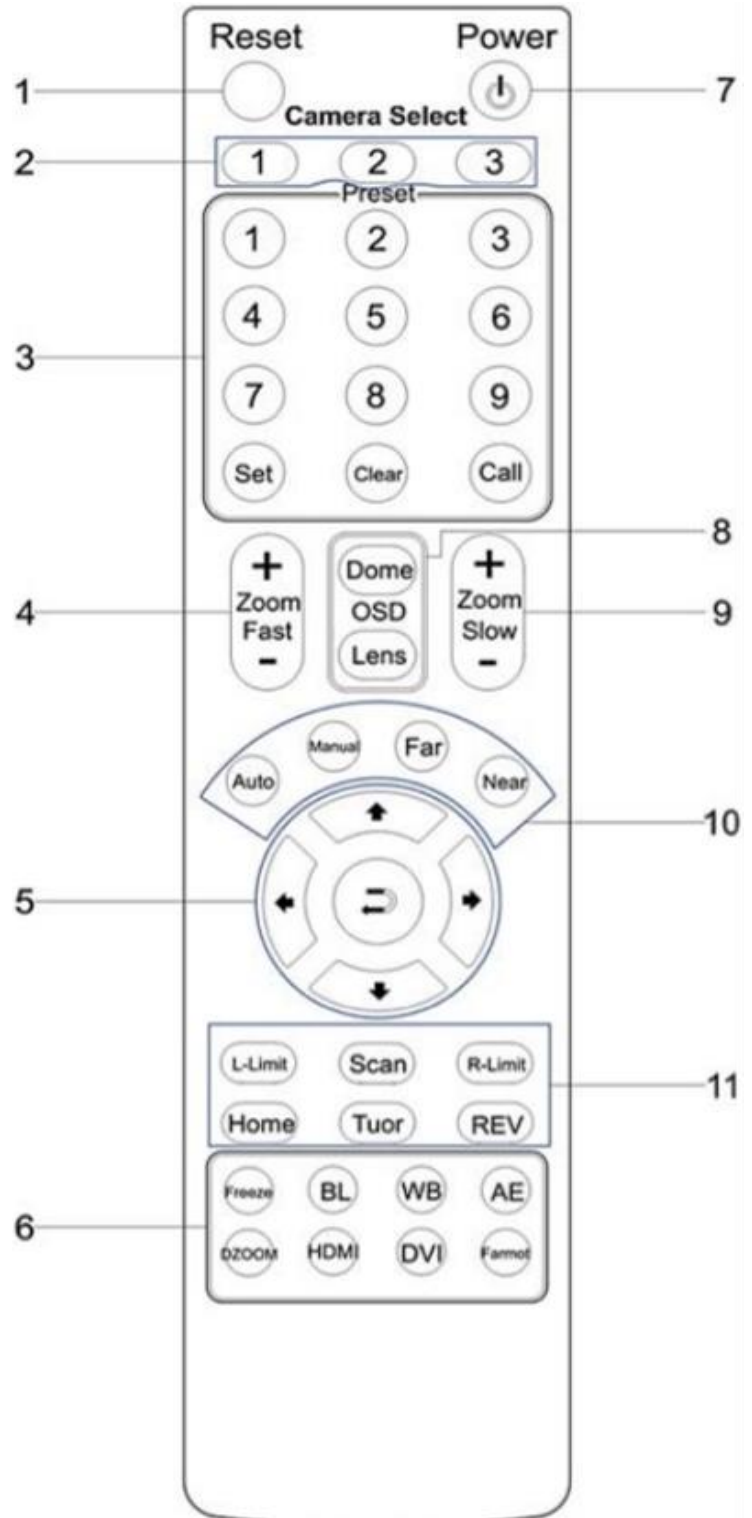



152 Robbins Rd, Downingtown, PA, 19335, USA - HuddleCamHD.com | 1 800 - 486-5276

- 11. **Pan/Tilt Function Zone**
 - L-Limit: Set left boundary limit scanning position
 - Scan: Enable Boundary Scanning (Auto Panning)
 - R-Limit: Set right boundary limit scanning position
 - Home: Go to camera's Home position
 - Tour: Enable automatic patrol tour of presets
 - Rev: Enable image flip for ceiling mounting

Connection Instructions.....

1. Connect included Power Supply to the camera.
2. Wait for camera to come to Home Position.
3. Connect included USB 3.0 cable to camera and USB 3.0 port of PC (unit is also backwards compatible with USB 2.0 port).
4. Select and configure camera in your software of choice.

NOTE: Failure to follow this sequence may result in no connection to PC.

Care Of The Unit.....

Remove dust or dirt on the surface of the lens with a blower (commercially available).

Installation Instructions.....

Desktop Installation.....

When using the HuddleCam™ on a desk, Make sure that it will stand level. If you want to use the camera on an incline, make sure the angle is less than 15 degrees to ensure that the camera's pan and tilt mechanism operates normally.

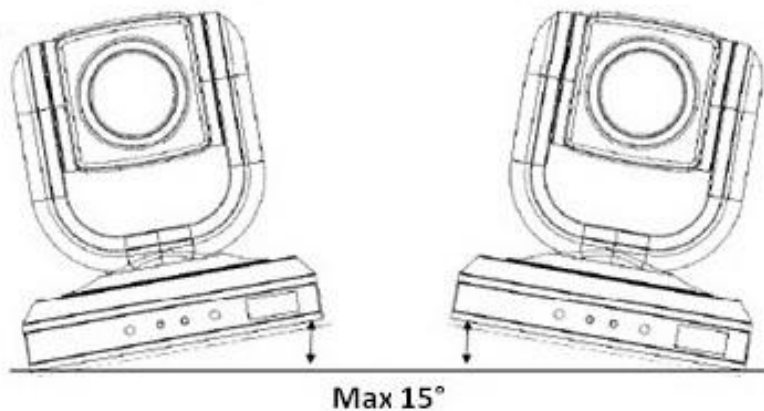

Tripod Installation.....

When using the HuddleCam™ with a tripod, screw the tripod to the bottom of the camera. The tripod screw must fit below specifications:

Note: Tripod must stand on a level surface.

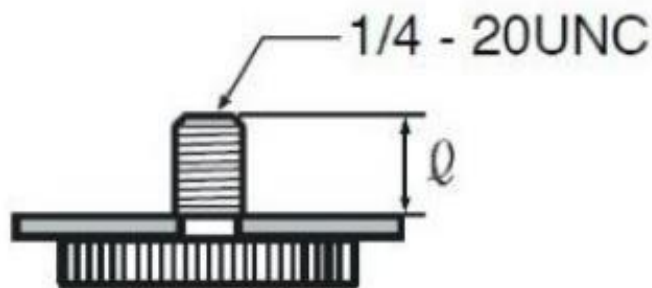

$$\ell = 5 - 7 \text{ mm}$$

Ceiling Mount.....

Step 1:

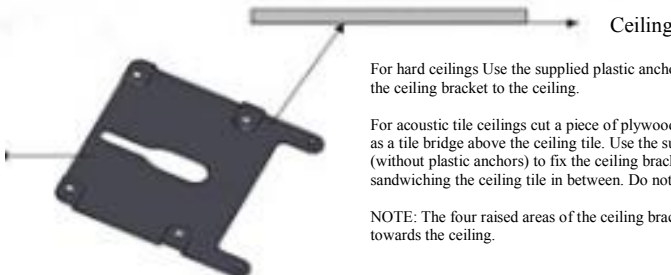

Ceiling Bracket

Ceiling

For hard ceilings Use the supplied plastic anchors and screws to fix the ceiling bracket to the ceiling.

For acoustic tile ceilings cut a piece of plywood 12" x 23.75" to use as a tile bridge above the ceiling tile. Use the supplied screws (without plastic anchors) to fix the ceiling bracket to the plywood, sandwiching the ceiling tile in between. Do not over-tighten.

NOTE: The four raised areas of the ceiling bracket must face towards the ceiling.

Step 2:



Slotted bolts

Use the two slotted bolts to fix the camera bracket to the bottom of the camera body. The 1/4 -20 bolt is for the threaded insert in the camera body. The smaller bolt threads into the bracket and pins the camera in place using the unthreaded opening in the camera body.

Camera Bracket

Step 3:

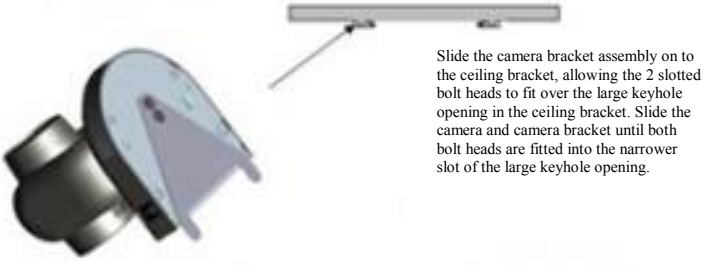

Slide the camera bracket assembly on to the ceiling bracket, allowing the 2 slotted bolt heads to fit over the large keyhole opening in the ceiling bracket. Slide the camera and camera bracket until both bolt heads are fitted into the narrower slot of the large keyhole opening.

Step 4:

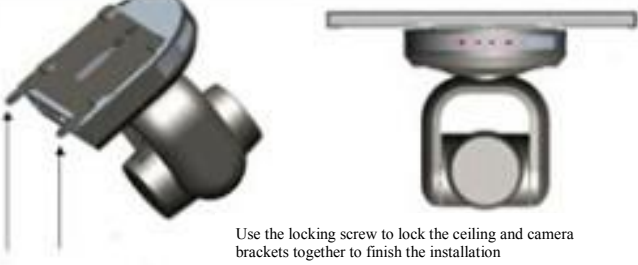

Use the locking screw to lock the ceiling and camera brackets together to finish the installation



152 Robbins Rd, Downingtown, PA, 19335, USA - HuddleCamHD.com | 1 800 - 486-5276

[Troubleshooting.....](#)

Problem	Cause	Resolution
There is no power to the camera.	Power adapter is disconnected from mains or from camera.	Check the connections between the camera, power adapter and mains. If anything is disconnected, reconnect it.
	Power switch is set to OFF.	Set the power switch to ON.
Camera will not connect to the PC via USB.	USB cable is bad.	Try new USB Cable
	Camera connects sometimes.	Connect USB only after camera has completely booted.
Camera unable to pan, tilt, and/or zoom.	Menu is currently displayed on the screen.	Retry after exiting the menu.
	Pan, tilt or zoom range limit was reached.	Try to pan/tilt/zoom in the other direction.
Remote control not working.	The “camera select” button on the remote control is not set to match the “IR select” switch number set on the camera.	Choose the correct “IR select” number to match camera settings.
Camera cannot be controlled via VISCA.	The connection between the PC and camera is incorrect.	Refer to Cable Connection Info section of this manual.
	Commands being sent are incorrect.	Refer to VISCA manual.
The Camera is not working at all.	No response or image from camera.	Disconnect power, and wait a few minutes, then connect the power again. Retry.



152 Robbins Rd, Downingtown, PA, 19335, USA - HuddleCamHD.com | 1 800 - 486-5276

Important Notes Regarding USB Connectivity:

USB 3.0 ports are backwards compatible with USB 2.0 devices. USB 2.0 ports are not completely forward compatible with USB 3.0 devices (some USB 3.0 devices will connect to USB 2.0 with limited functionality).

External USB hubs should be avoided (i.e. give the camera its own USB port on the device) as they are not well suited to transmitting HD video reliably.

USB extension systems must be fully compatible with the version of USB that you are using and must utilize an external power supply, when required. Caution: Some “compatible” USB 3.0 extenders do not actually have the full 5Gbps bandwidth required for uncompressed HD video - so check bandwidth specs. Always connect the HuddleCam directly to the device in order to associate the UVC drivers before attempting to use any extension system.

USB 3.0 power saving settings in the device’s operating system should be turned off completely for reliable USB 3.0 camera connectivity.

HuddleCam Cameras

All HuddleCamHD cameras utilize the UVC (USB Video Class) drivers that are built into Windows, Mac OS and Linux to stream HD video to your device via your device’s USB port (*USB 2.0 or USB 3.0 depending upon HuddleCam model*). When your device successfully recognizes the camera, your device will register the HuddleCam as an “imaging device”. You can see this in your Windows Device Manager program (type “device manager” into the Windows search tool) as shown in the screenshot, below:

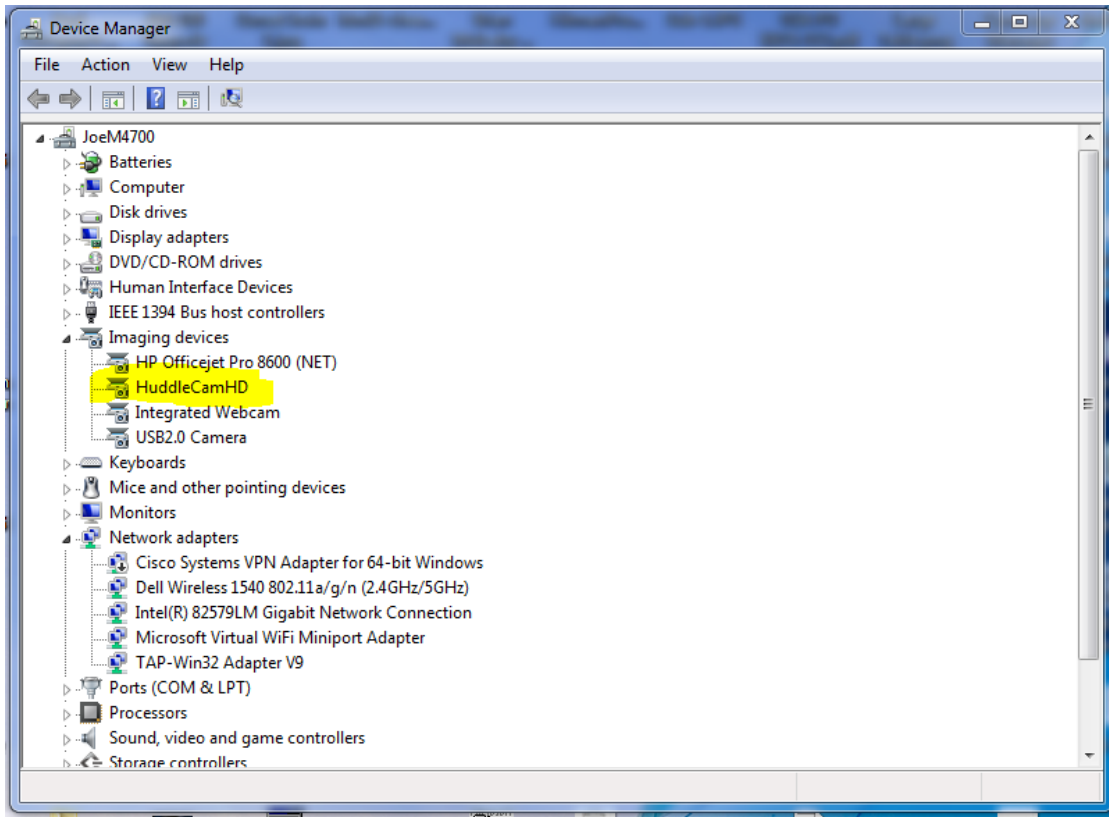

In this example, you can see the HuddleCam model in use connected as a fully functional USB 3.0 device (HuddleCamHD) as well as a USB 2.0 device with limited functionality (USB2.0 Camera).

If your device has not connected to or has not recognized the HuddleCam as an imaging device (in which case, you may see a new “unknown device”, “Westbridge” or “CYTFX3” labeled device show up in Device Manager’s “Universal Serial Bus Controllers” section rather than in the “Imaging Devices” section), the HuddleCam will not be available to programs that utilize a camera. In this case, try restarting the device and reconnecting the camera via USB (*USB 2.0 or USB 3.0 depending upon HuddleCam model*).

Similarly, you can see a connected device in System Information on a MAC. See screenshot below:

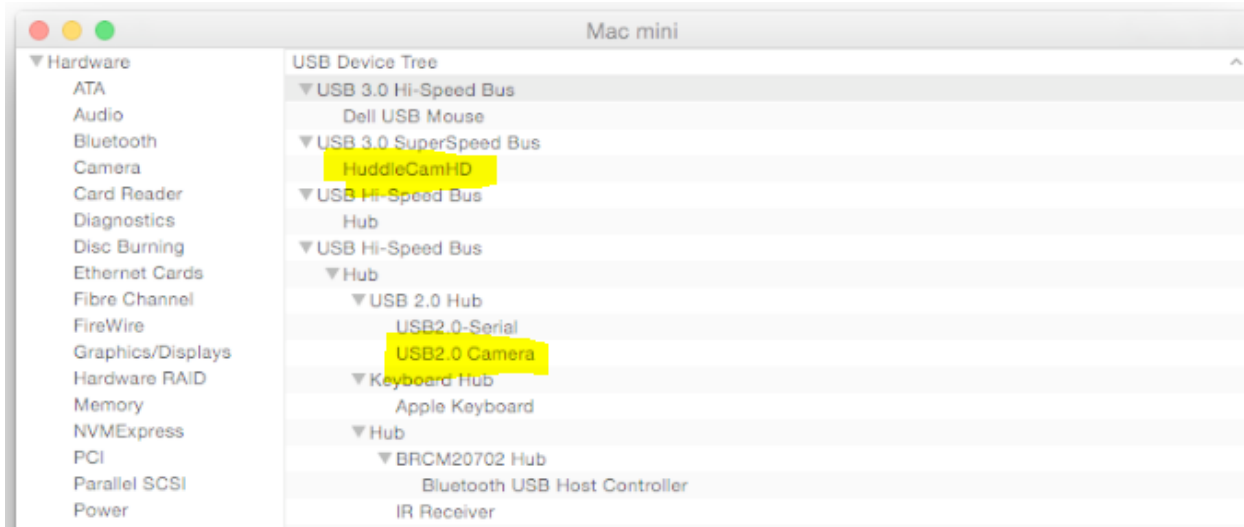

In this example, you can see the HuddleCam model in use connected as a fully functional USB 3.0 device “HuddleCamHD” as well as a “USB2.0 camera” with limited functionality (USB2.0 camera).

Specs.....

Model Number: HC30-xx-G2 (Color (xx): GY=Gray, WH=White)

Camera & Lens

- Video CMOS Sensor 1/2.8" CMOS 2.14 Mega Pixel
- Frame Rate 30fps 1920 x 1080p, 30fps 1280 x 720p
- Lens Zoom 30X Optical Zoom, 12X Digital Zoom f=4.3-129mm
- Field of View 4° (tele) to 63° (wide)
- Min Lux 0.5 Lux
- Warranty 2 years parts and labor

Pan/Tilt Movement

- Pan Movement 0-355°
- Tilt Rotation Up: 90°, Down: 45°
- Presets 64 Presets, 4 Patrol lines

Rear Board Connectors

- High Definition Interface USB 3.0
- Controller Signal Interface Mini DIN-8 (VISCA IN, VISCA OUT/RS485)
- Controller Signal Config. IDip-Switch Pin 6/TTL Signal
- Baud Rate 9600 bds
- Power Supply Interface DC 12V 2A

Electrical Index

- Power Supply Adapter 12V DC 2A
- Input Voltage 12V DC (10.5-14V DC)
- Input Power 24W (Max)
- Power Supply Max Temp -14°F to 140°F

Physical

- Material Aluminum, Plastic
- Dimensions 5.38" W x 6.5" H x 6" D [7"H w/ Tilt]
(137mm W x 166mm H x 153mm D [178mmH w/ Tilt])
- Weight 2.5 lbs (1.13 kg)
- Box Dimensions 12" x 9.5" x 9.25" (305mm x 242mm x 235mm)
- Boxed Weight 5.7 lbs (2.59 kg)
- Color Silver Gray
- Operating Temperature 32°F to + 113°F (0°C to +45°C)
- Storage Temperature -14°F to 140°F (-10°C +60°C)
- Working Environment Indoor only